

This document is meant purely as a documentation tool and the institutions do not assume any liability for its contents

► **B**                    **DIRECTIVE OF THE EUROPEAN PARLIAMENT AND OF THE COUNCIL**  
**of 12 December 2006**  
**laying down technical requirements for inland waterway vessels and repealing Council Directive**  
**82/714/EEC**  
**(2006/87/EC)**  
(OJ L 389, 30.12.2006, p. 1)

Amended by:

		Official Journal		
		No	page	date
► <b><u>M1</u></b>	Directive of the European Parliament and of the Council of 18 December 2006	L 389	261	30.12.2006
► <b><u>M2</u></b>	Council Directive 2008/59/EC of 12 June 2008	L 166	31	27.6.2008
► <b><u>M3</u></b>	Commission Directive 2008/87/EC of 22 September 2008	L 255	5	23.9.2008
► <b><u>M4</u></b>	Directive 2008/68/EC of the European Parliament and of the Council of 24 September 2008	L 260	13	30.9.2008
► <b><u>M5</u></b>	Commission Directive 2008/126/EC of 19 December 2008	L 32	1	31.1.2009



**DIRECTIVE OF THE EUROPEAN PARLIAMENT AND OF THE COUNCIL**

**of 12 December 2006**

**laying down technical requirements for inland waterway vessels and repealing Council Directive 82/714/EEC**

(2006/87/EC)

THE EUROPEAN PARLIAMENT AND THE COUNCIL OF THE EUROPEAN UNION,

Having regard to the Treaty establishing the European Community, and in particular Article 71(1) thereof,

Having regard to the proposal from the Commission,

Having regard to the opinion of the European Economic and Social Committee <sup>(1)</sup>,

Following consultation of the Committee of the Regions,

Acting in accordance with the procedure laid down in Article 251 of the Treaty <sup>(2)</sup>,

Whereas:

- (1) Council Directive 82/714/EEC of 4 October 1982 laying down technical requirements for inland waterway vessels <sup>(3)</sup> introduced harmonised conditions for issuing technical certificates for inland waterway vessels in all Member States, albeit excluding operations on the Rhine. Nevertheless, at European level, various technical requirements for inland waterway vessels have remained in force. Up to now, the coexistence of various international and national regulations has obstructed efforts to ensure mutual recognition of national navigation certificates without the need for an additional inspection of foreign vessels. Furthermore, the standards contained in Directive 82/714/EEC, in part, no longer reflect current technological developments.
- (2) Essentially, the technical requirements set out in the annexes to Directive 82/714/EEC incorporate the provisions laid down in the Rhine Vessel Inspection Regulation, in the version approved by the Central Commission for Navigation on the Rhine (CCNR) in 1982. The conditions and technical requirements for issuing inland navigation certificates under Article 22 of the Revised Convention for Rhine Navigation have been revised regularly since then and are recognised as reflecting current technological developments. For competition and safety reasons it is desirable, specifically in the interests of promoting harmonisation at European level, to adopt the scope and content of such technical requirements for the whole of the Community's inland waterway network. Account should be taken in this regard of the changes that have occurred in that network.
- (3) Community inland navigation certificates attesting the full compliance of vessels with the aforementioned revised technical requirements should be valid on all Community inland waterways.

<sup>(1)</sup> OJ C 157, 25.5.1998, p. 17.

<sup>(2)</sup> Opinion of the European Parliament of 16 September 1999 (OJ C 54, 25.2.2000, p. 79), Council Common Position of 23 February 2006 (OJ C 166 E, 18.7.2006, p. 1), Position of the European Parliament of 5 July 2006 (not yet published in the Official Journal) and Council Decision of 23 October 2006.

<sup>(3)</sup> OJ L 301, 28.10.1982, p. 1. Directive as last amended by the 2003 Act of Accession.

**▼B**

- (4) It is desirable to ensure a greater degree of harmonisation between the conditions for the issuing of supplementary Community inland navigation certificates by Member States for operations on Zone 1 and 2 waterways (estuaries), as well as for operations on Zone 4 waterways.
- (5) In the interests of passenger transport safety, it is desirable that the scope of Directive 82/714/EEC be extended to include passenger vessels designed to carry more than 12 passengers, along the lines of the Rhine Vessel Inspection Regulation.
- (6) In the interests of safety, harmonisation of standards should be at a high level and should be achieved in such a way so as not to result in any reduction in safety standards on any Community inland waterway.
- (7) It is appropriate to provide for a transitional regime for vessels in service not yet carrying a Community inland navigation certificate when subjected to a first technical inspection under the revised technical requirements established by this Directive.
- (8) It is appropriate, within certain limits and according to the category of vessel concerned, to determine the period of validity of Community inland navigation certificates in each specific case.
- (9) The measures necessary for the implementation of this Directive should be adopted in accordance with Council Decision 1999/468/EC of 28 June 1999 laying down the procedures for the exercise of implementing powers conferred on the Commission <sup>(1)</sup>.
- (10) It is necessary that the measures provided for in Council Directive 76/135/EEC of 20 January 1976 on reciprocal recognition of navigability licenses for inland waterway vessels <sup>(2)</sup> remain in force for those vessels not covered by this Directive.
- (11) Given that some vessels fall within the scope of Directive 94/25/EC of the European Parliament and of the Council of 16 June 1994 on the approximation of the laws, regulations and administrative provisions of the Member States relating to recreational craft <sup>(3)</sup> as well as of this Directive, the annexes of the two Directives should be adjusted by the relevant committee procedures as soon as possible if there are any contradictions or inconsistencies between the provisions of those Directives.
- (12) In accordance with point 34 of the Interinstitutional Agreement on better law-making <sup>(4)</sup>, Member States are encouraged to draw up, for themselves and in the interests of the Community, their own tables illustrating, as far as possible, the correlation between this Directive and the transposition measures, and to make them public.
- (13) Directive 82/714/EEC should be repealed,

HAVE ADOPTED THIS DIRECTIVE:

<sup>(1)</sup> OJ L 184, 17.7.1999, p. 23. Decision as amended by Decision 2006/512/EC (OJ L 200, 22.7.2006, p. 11).

<sup>(2)</sup> OJ L 21, 29.1.1976, p. 10. Directive as last amended by Directive 78/1016/EEC (OJ L 349, 13.12.1978, p. 31).

<sup>(3)</sup> OJ L 164, 30.6.1994, p. 15. Directive as last amended by Regulation (EC) No 1882/2003 (OJ L 284, 31.10.2003, p. 1).

<sup>(4)</sup> OJ C 321, 31.12.2003, p. 1.



### *Article 1*

#### **Classification of waterways**

1. For the purposes of this Directive, Community inland waterways shall be classified as follows:
  - (a) Zones 1, 2, 3 and 4:
    - (i) Zones 1 and 2: the waterways listed in Chapter 1 of Annex I;
    - (ii) Zone 3: the waterways listed in Chapter 2 of Annex I;
    - (iii) Zone 4: the waterways listed in Chapter 3 of Annex I.
  - (b) Zone R: those of the waterways referred to in point (a) for which certificates are to be issued in accordance with Article 22 of the Revised Convention for Rhine Navigation as that Article is worded when this Directive enters into force.
2. Any Member State may, after consulting the Commission, modify the classification of its waterways into the zones listed in Annex I. The Commission shall be notified of these modifications at least six months before their entry into force and shall inform the other Member States.

### *Article 2*

#### **Scope of application**

1. This Directive shall, in accordance with Article 1.01 of Annex II, apply to the following craft:
  - (a) vessels having a length (L) of 20 metres or more;
  - (b) vessels for which the product of length (L), breadth (B) and draught (T) is a volume of 100 m<sup>3</sup> or more.
2. This Directive shall also apply, in accordance with Article 1.01 of Annex II, to all of the following craft:
  - (a) tugs and pushers intended for towing or pushing craft referred to in paragraph 1 or floating equipment or for moving such craft or floating equipment alongside;
  - (b) vessels intended for passenger transport which carry more than 12 passengers in addition to the crew;
  - (c) floating equipment.
3. The following craft shall be excluded from this Directive:
  - (a) ferries;
  - (b) naval vessels;
  - (c) sea-going vessels, including sea-going tugs and pusher craft, which:
    - (i) operate or are based on tidal waters;
    - (ii) operate temporarily on inland waterways, provided that they carry:
      - a certificate proving conformity with the 1974 International Convention for the Safety of Life at Sea (SOLAS), or equivalent, a certificate proving conformity with the 1966 International Convention on Load Lines, or equivalent, and an international oil pollution prevention (IOPP) certificate proving conformity with the 1973 International Convention for the Prevention of Pollution from Ships (MARPOL); or

**▼B**

- in the case of passenger vessels not covered by all of the Conventions referred to in the first indent, a certificate on safety rules and standards for passenger ships issued in conformity with Council Directive 98/18/EC of 17 March 1998 on safety rules and standards for passenger ships <sup>(1)</sup>; or
- in the case of recreational craft not covered by all of the Conventions referred to in the first indent, a certificate of the country of which it carries the flag.

*Article 3***Obligation to carry a certificate**

1. Craft operating on the Community inland waterways referred to in Article 1 shall carry:
  - (a) when operating on a Zone R waterway:
    - either a certificate issued pursuant to Article 22 of the Revised Convention for Rhine Navigation;
    - or a Community inland navigation certificate issued or renewed after 30 December 2008, and attesting full compliance of the craft, without prejudice to the transitional provisions of Chapter 24 of Annex II, with technical requirements as defined in Annex II for which equivalency with the technical requirements laid down in application of the abovementioned Convention has been established according to the applicable rules and procedures;
  - (b) when operating on other waterways, a Community inland navigation certificate, including, where applicable, the specifications referred to in Article 5.
2. The Community inland navigation certificate shall be drawn up following the model set out in Part I of Annex V and shall be issued in accordance with this Directive.

*Article 4***Supplementary Community inland navigation certificates**

1. All craft carrying a valid certificate issued pursuant to Article 22 of the Revised Convention for Rhine Navigation may, subject to the provisions of Article 5(5) of this Directive, navigate on Community waterways carrying that certificate only.
2. However, all craft carrying the certificate referred to in paragraph 1 shall also be provided with a supplementary Community inland navigation certificate:
  - (a) when operating on Zone 3 and 4 waterways, if they wish to take advantage of the reduction in technical requirements on those waterways;
  - (b) when operating on Zone 1 and 2 waterways, or, in respect of passenger vessels, when operating on Zone 3 waterways that are not linked to the navigable inland waterways of another Member State, if the Member State concerned has adopted additional technical requirements for those waterways, in accordance with Article 5(1), (2) and (3).
3. The supplementary Community inland navigation certificate shall be drawn up following the model set out in Part II of Annex V and shall be issued by the competent authorities on production of the certificate

<sup>(1)</sup> OJ L 144, 15.5.1998, p. 1. Directive as last amended by Commission Directive 2003/75/EC (OJ L 190, 30.7.2003, p. 6).

**▼B**

referred to in paragraph 1 and under the conditions laid down by the authorities competent for the waterways concerned.

*Article 5***Additional or reduced technical requirements for certain zones**

1. Each Member State may, after consulting the Commission, and where applicable subject to the requirements of the Revised Convention for Rhine Navigation, adopt technical requirements additional to those in Annex II for craft operating on Zone 1 and 2 waterways within its territory.
2. In respect of passenger vessels operating on Zone 3 waterways within its territory that are not linked to the navigable inland waterways of another Member State, each Member State may maintain technical requirements additional to those in Annex II. Amendments to such technical requirements shall require the prior approval of the Commission.
3. The additional requirements shall be restricted to the subjects listed in Annex III. The Commission shall be notified of these additional requirements at least six months before their entry into force and shall inform the other Member States.
4. Compliance with the additional requirements shall be specified in the Community inland navigation certificate referred to in Article 3 or, where Article 4(2) applies, in the supplementary Community inland navigation certificate. Such proof of compliance shall be recognised on Community waterways of the corresponding zone.
5.
  - (a) Where application of the transitional provisions set out in Chapter 24a of Annex II would result in a reduction in existing national safety standards, a Member State may disapply those transitional provisions in respect of inland waterway passenger vessels operating on its inland waterways that are not linked to the navigable inland waterways of another Member State. In such circumstances, the Member State may require that such vessels operating on its non-linked inland waterways comply fully with the technical requirements set out in Annex II from 30 December 2008.
  - (b) A Member State exercising the provision in point (a) shall inform the Commission of its decision and provide the Commission with details of the relevant national standards applying to passenger vessels operating on its inland waterways. The Commission shall inform the Member States.
  - (c) Compliance with the requirements of a Member State for operating on its non-linked inland waterways shall be specified in the Community inland navigation certificate referred to in Article 3 or, where Article 4(2) applies, in the supplementary Community inland navigation certificate.
6. Craft operating only on Zone 4 waterways shall qualify for the reduced requirements as specified in Chapter 19b of Annex II on all waterways in that zone. Compliance with those reduced requirements shall be specified in the Community inland navigation certificate referred to in Article 3.
7. Each Member State may, after consulting the Commission, allow a reduction of the technical requirements of Annex II for craft operating exclusively on Zone 3 and 4 waterways within its territory.

Such a reduction shall be restricted to the subjects listed in Annex IV. Where the technical characteristics of a craft correspond to the reduced technical requirements, this shall be specified in the Community inland navigation certificate or, where Article 4(2) applies, in the supplementary Community inland navigation certificate.

**▼B**

The Commission shall be notified of the reductions of the technical requirements of Annex II at least six months before they come into force and shall inform the other Member States.

**▼M4****▼B***Article 7***Derogations**

1. Member States may authorise derogations from all or part of this Directive for:
  - (a) vessels, tugs, pushers and floating equipment operating on navigable waterways not linked by inland waterway to the waterways of other Member States;
  - (b) craft having a dead weight not exceeding 350 tonnes or craft not intended for the carriage of goods and having a water displacement of less than 100 m<sup>3</sup>, which were laid down before 1 January 1950 and operate exclusively on a national waterway.
2. Member States may authorise in respect of navigation on their national waterways derogations from one or more provisions of this Directive for limited journeys of local interest or in harbour areas. These derogations and the journeys or area for which they are valid shall be specified in the vessel's certificate.
3. The Commission shall be notified of derogations authorised in accordance with paragraphs 1 and 2 and shall inform the other Member States.
4. Any Member State which, as a result of derogations authorised in accordance with paragraphs 1 and 2, has no craft subject to the provisions of this Directive operating on its waterways shall not be required to comply with Articles 9, 10 and 12.

*Article 8***Issuance of Community inland navigation certificates**

1. The Community inland navigation certificate shall be issued to craft laid down as from 30 December 2008 following a technical inspection carried out prior to the craft being put into service and intended to check whether the craft complies with the technical requirements laid down in Annex II.
2. The Community inland navigation certificate shall be issued to craft excluded from the scope of Directive 82/714/EEC, but covered by this Directive in accordance with Article 2(1) and (2), following a technical inspection which shall be carried out upon expiry of the craft's current certificate, but in any case no later than 30 December 2018, to check whether the craft complies with the technical requirements laid down in Annex II. In Member States where the validity period of the craft's current national certificate is shorter than five years, such certificate may be issued until five years after 30 December 2008.

Any failure to meet the technical requirements laid down in Annex II shall be specified in the Community inland navigation certificate. Provided that the competent authorities consider that these shortcomings do not constitute a manifest danger, the craft referred to in the first subparagraph may continue to operate until such time as those components or areas of the craft which have been certified as not meeting those requirements are replaced or altered, whereafter those components or areas shall meet the requirements of Annex II.
3. Manifest danger within the meaning of this Article shall be presumed in particular when requirements concerning the structural

**▼B**

soundness of the shipbuilding, the navigation or manoeuvrability or special features of the craft in accordance with Annex II are affected. Derogations as allowed for in Annex II shall not be identified as shortcomings which constitute a manifest danger.

The replacement of existing parts with identical parts or parts of an equivalent technology and design during routine repairs and maintenance shall not be considered as a replacement within the meaning of this Article.

4. Compliance of a craft with the additional requirements referred to in Article 5(1), (2) and (3) shall, where appropriate, be checked during the technical inspections provided for in paragraphs 1 and 2 of this Article, or during a technical inspection carried out at the request of the vessel's owner.

*Article 9***Competent authorities**

1. Community inland navigation certificates may be issued by the competent authorities of any Member State.
2. Each Member State shall draw up a list indicating which of its authorities are competent for issuing the Community inland navigation certificates and shall notify the Commission thereof. The Commission shall inform the other Member States.

*Article 10***Carrying out of technical inspections**

1. The technical inspection referred to in Article 8 shall be carried out by the competent authorities which may refrain from subjecting the craft in whole or in part to technical inspection where it is evident from a valid attestation, issued by a recognised classification society in accordance with Article 1.01 of Annex II, that the craft satisfies in whole or in part the technical requirements of Annex II. Classification societies shall only be recognised if they fulfil the criteria listed in Part I of Annex VII.
2. Each Member State shall draw up a list indicating which of its authorities are competent for carrying out technical inspections and shall notify the Commission thereof. The Commission shall inform the other Member States.

*Article 11***Validity of Community inland navigation certificates**

1. The period of validity of Community inland navigation certificates shall be determined in each specific case by the authority competent for issuing such certificates in accordance with Annex II.
2. Each Member State may, in the cases specified in Articles 12 and 16 and in Annex II, issue provisional Community inland navigation certificates. Provisional Community inland navigation certificates shall be drawn up following the model set out in Part III of Annex V.

*Article 12***Replacement of Community inland navigation certificates**

Each Member State shall lay down the conditions under which a valid Community inland navigation certificate which has been lost or damaged may be replaced.





### *Article 13*

#### **Renewal of Community inland navigation certificates**

1. The Community inland navigation certificate shall be renewed on expiry of its period of validity in accordance with the conditions laid down in Article 8.
2. For the renewal of Community inland navigation certificates issued before 30 December 2008, the transitional provisions of Annex II shall apply.
3. For the renewal of Community inland navigation certificates issued after 30 December 2008, the transitional provisions of Annex II which have come into force after the issuing of such certificates shall apply.

### *Article 14*

#### **Extension of validity of Community inland navigation certificates**

The validity of a Community inland navigation certificate may exceptionally be extended without a technical inspection in accordance with Annex II by the authority which issued or renewed it. Such extension shall be indicated on that certificate.

### *Article 15*

#### **Issuance of new Community inland navigation certificates**

In the event of major alterations or repairs which affect the structural soundness of the shipbuilding, the navigation or manoeuvrability or special features of the craft in accordance with Annex II, the latter shall again undergo, prior to any further voyage, the technical inspection provided for in Article 8. Following this inspection, a new Community inland navigation certificate stating the technical characteristics of the craft shall be issued or the existing certificate amended accordingly. If this certificate is issued in a Member State other than that which issued or renewed the initial certificate, the competent authority which issued or renewed the certificate shall be informed accordingly within one month.

### *Article 16*

#### **Refusal to issue or renew, and withdrawal of, Community inland navigation certificates**

Any decision to refuse to issue or renew a Community inland navigation certificate shall state the grounds on which it is based. The person concerned shall be notified thereof and of the appeal procedure and its time limits in the Member State concerned.

Any valid Community inland navigation certificate may be withdrawn by the competent authority which issued or renewed it if the craft ceases to comply with the technical requirements specified in its certificate.

### *Article 17*

#### **Additional inspections**

The competent authorities of a Member State may, in accordance with Annex VIII, check at any time whether a craft is carrying a certificate valid under the terms of this Directive and satisfies the requirements set out in such certificate or constitutes a manifest danger for the persons on board, the environment or the navigation. The competent authorities shall take the necessary measures in accordance with Annex VIII.

**▼B***Article 18***Recognition of navigability certificates of craft from third countries**

Pending the conclusion of agreements on the mutual recognition of navigability certificates between the Community and third countries, the competent authorities of a Member State may recognise the navigability certificates of craft from third countries for navigation on the waterways of that Member State.

The issuance of Community inland navigation certificates to craft from third countries shall be carried out in accordance with Article 8(1).

*Article 19***Committee procedure**

1. The Commission shall be assisted by the Committee established under Article 7 of Council Directive 91/672/EEC of 16 December 1991 on the reciprocal recognition of national boatmasters' certificates for the carriage of goods and passengers by inland waterway <sup>(1)</sup> (hereinafter referred to as 'the Committee').

2. Where reference is made to this paragraph, Articles 3 and 7 of Decision 1999/468/EC shall apply, having regard to the provisions of Article 8 thereof.

**▼M1**

3. Where reference is made to this paragraph, Article 5a(1) to (4) and (5)(b), and Article 7 of Decision 1999/468/EC shall apply, having regard to the provisions of Article 8 thereof.

The time limits provided for in Article 5a(3)(c), (4)(b) and (4)(e) of Decision 1999/468/EC shall be set at twenty-one days, fifteen days and one month respectively.

4. Where reference is made to this paragraph, Article 5a(1), (2), (4) and (6), and Article 7 of Decision 1999/468/EC shall apply, having regard to the provisions of Article 8 thereof.

*Article 20***Adaptation of the Annexes and recommendations on provisional certificates**

1. Any amendments which are necessary to adapt the Annexes to this Directive to technical progress or to developments in this area arising from the work of other international organisations, in particular that of the Central Commission for Navigation on the Rhine (CCNR), to ensure that the two certificates referred to in Article 3(1)(a) are issued on the basis of technical requirements which guarantee an equivalent level of safety, or to take account of the cases referred to in Article 5, shall be adopted in accordance with the regulatory procedure with scrutiny referred to in Article 19(3). On imperative grounds of urgency, the Commission may follow the urgency procedure referred to in Article 19(4).

Those amendments shall be made rapidly in order to ensure that the technical requirements for the issuing of the Community inland navigation certificate recognised for navigation on the Rhine give a level of safety equivalent to that required for the issuing of the certificate referred to in Article 22 of the Revised Convention for Rhine Navigation.

<sup>(1)</sup> OJ L 373, 31.12.1991, p. 29. Directive as last amended by Regulation (EC) No 1882/2003.

**▼M1**

2. Notwithstanding paragraph 1, the Commission shall adopt the approvals referred to in Article 5(2) in accordance with the procedure referred to in Article 19(2).
3. The Commission shall decide on recommendations from the Committee on the issue of provisional Community inland navigation certificates in accordance with Article 2.19 of Annex II.

**▼B***Article 21***Continued applicability of Directive 76/135/EEC**

For those craft outside the scope of Article 2(1) and (2) of this Directive, but falling within the scope of Article 1(a) of Directive 76/135/EEC, the provisions of that Directive shall apply.

*Article 22***National additional or reduced requirements**

Additional requirements which were in force in a Member State before 30 December 2008 for craft operating within its territory on Zone 1 and 2 waterways or reduced technical requirements for craft operating within its territory on Zone 3 and 4 waterways which were in force in a Member State before that date shall continue to be in force until additional requirements in accordance with Article 5(1) or reductions in accordance with Article 5(7) of the technical prescriptions of Annex II come into force, but only until 30 June 2009.

*Article 23***Transposition**

1. Member States which have inland waterways as referred to in Article 1(1) shall bring into force the laws, regulations and administrative provisions necessary to comply with this Directive with effect from 30 December 2008. They shall forthwith inform the Commission thereof.

When Member States adopt these measures, they shall contain a reference to this Directive or shall be accompanied by such reference on the occasion of their official publication. The methods of making such reference shall be laid down by Member States.

2. Member States shall immediately communicate to the Commission the text of the provisions of national law which they adopt in the field covered by this Directive. The Commission shall inform the other Member States thereof.

*Article 24***Penalties**

Member States shall lay down a system of penalties for breaches of the national provisions adopted pursuant to this Directive and shall take all the measures necessary to ensure that these penalties are applied. The penalties thus provided for shall be effective, proportionate and dissuasive.

*Article 25***Repeal of Directive 82/714/EEC**

Directive 82/714/EEC shall be repealed with effect from 30 December 2008.

**▼B**

*Article 26*

**Entry into force**

This Directive shall enter into force on the day of its publication in the *Official Journal of the European Union*.

*Article 27*

**Addressees**

This Directive is addressed to the Member States which have inland waterways as referred to in Article 1(1).

**▼B****LIST OF ANNEXES**

Annex I	List of Community inland waterways divided geographically into Zones 1, 2, 3 and 4
Annex II	Minimum technical requirements applicable to vessels on inland waterways of Zones 1, 2, 3 and 4
Annex III	Subjects for possible additional technical requirements applicable to vessels on inland waterways of Zones 1 and 2
Annex IV	Subjects for possible reductions of the technical requirements applicable to vessels on inland waterways of Zones 3 and 4
Annex V	Model Community inland navigation certificates
Annex VI	Model register of Community inland navigation certificates
Annex VII	Classification societies
Annex VIII	Rules of procedure for the carrying out of inspections
Annex IX	Requirements applicable to signal lights, radar installations and rate-of-turn indicators



## ANNEX I

## LIST OF COMMUNITY INLAND WATERWAYS DIVIDED GEOGRAPHICALLY INTO ZONES 1, 2, 3 AND 4

## CHAPTER 1

## Zone 1

*Federal Republic of Germany*

Ems from a line linking the former Greetsiel lighthouse and the western pier of the port entrance at Eemshaven seawards as far as latitude 53° 30' N and longitude 6° 45' E, i.e. slightly seawards of the lightering area for dry-cargo carriers in the Alte Ems (\*)

*Republic of Poland*

The part of Pomorska Bay southward from the line linking NordPerd on Rugen Island and the lighthouse Niechorze.

The part of Gdańska Bay southward from the line linking the lighthouse Hel and the entrance buoy to the port of Baltijsk.

*United Kingdom of Great Britain and Northern Ireland*

## SCOTLAND

Blue Mull Sound	Between Gutcher and Belmont
Yell Sound	Between Tofts Voe and Ulsta
Sullom Voe	Within a line from the north-east point of Gluss Island to the northern point of Calback Ness
Dales Voe	In winter: within a line from the north point of Kebister Ness to the Coast of Breiwick at longitude 1° 10,8' W
Dales Voe	In summer: as for Lerwick
Lerwick	In winter: within the area bounded to the northward by a line from Scottle Holm to Scarfi Taing on Bressay and to the southward by a line from Twageos Point Lighthouse to Whalpa Taing on Bressay
Lerwick	In summer: within the area bounded to the northward by a line from Brim Ness to the north east corner of Inner Score and to the southward by a line from the south end of Ness of Sound to Kirkabisterness
Kirkwall	Between Kirkwall and Rousay not east of a line between Point of Graand (Egilsay) and Galt Ness (Shapinsay) or between Head of Work (Mainland) through Helliar Holm light to the shore of Shapinsay; not north west of the south east tip of Eynhallow Island, not to seaward and a line between the shore on Rousay at 59°10,5' N 002° 57,1' W and the shore on Egilsay at 59° 10' N 002° 56,4' W

(\*) In the case of vessels whose home port is elsewhere, account is to be taken of Article 32 of the Ems-Dollart Treaty of 8 April 1960 (BGBl. 1963 II, p. 602).

**▼B**

Stromness	To Scapa but not outside Scapa Flow
Scapa Flow	Within an area bounded by lines drawn from Point of Cletts on the island of Hoy to Thomson's Hill triangulation point on the island of Fara and thence to Gibraltar Pier on the island of Flotta; from St Vincent Pier on the island of Flotta to the westernmost point of Calf of Flotta; from the easternmost point of the Calf of Flotta to Needle Point on the island of South Ronaldsay and from the Ness on Mainland to Point of Oxan lighthouse on the island of Graemsay and thence to Bu Point on the island of Hoy; and seaward of Zone 2 waters
Balnakiel Bay	Between Eilean Dubh and A'Chleit
Cromarty Firth	Within a line from North Sutor to Nairn Breakwater and seaward of Zone 2 waters
Inverness	Within a line from North Sutor to Nairn Breakwater and seaward of Zone 2 waters
River Tay — Dundee	Within a line from Broughty Castle to Tayport and seaward of Zone 2 waters
Firth of Forth and River Forth	Within a line from Kirkcaldy to River Portobello and seaward of Zone 2 waters
Solway Firth	Within a line from Southerness Point to Silloth
Loch Ryan	Within a line from Finnart's Point to Milleur Point and seaward of Zone 2 waters
The Clyde	Outer limit: <p style="margin-left: 40px;">a line from Skipness to a position one mile south of Garroch Head thence to Farland Head</p> Inner limit in winter: <p style="margin-left: 40px;">a line from Cloch Lighthouse to Dunoon Pier</p> Inner limit in summer: <p style="margin-left: 40px;">a line from Bogany Point, Isle of Bute to Skelmorlie Castle and a line from Ardlamont Point to the southern extremity of Etrick Bay inside the Kyles of Bute</p> <i>Note:</i> The above inner summer limit is extended between 5 June and 5 September (both dates inclusive) by a line from a point two miles off the Ayrshire coast at Skelmorlie Castle to Tomont End, Cumbrae, and a line from Portachur Point, Cumbrae to Inner Brigurd Point, Ayrshire
Oban	Within an area bounded on the north by a line from Dunollie Point Light to Ard na Chruidh and to the south by a line from Rudha Seanach to Ard na Cuile
Kyle of Lochalsh	Through Loch Alsh to the head of Loch Duich
Loch Gairloch	In winter: <p style="margin-left: 40px;">none</p> In summer: <p style="margin-left: 40px;">South of a line running east from Rubha na Moine to Eilan Horrisdale and thence to Rubha nan Eanntag</p>

**NORTHERN IRELAND**

Belfast Lough	In winter: <p style="margin-left: 40px;">none</p> In summer: <p style="margin-left: 40px;">within a line from Carrickfergus to Bangor</p>
---------------	---

**▼B**

	and seaward of Zone 2 waters
Loch Neagh	At a greater distance than 2 miles from the shore
EAST COAST OF ENGLAND	
River Humber	In winter: within a line from New Holland to Paull In summer: within a line from Cleethorpes Pier to Patrington Church and seaward of Zone 2 waters
WALES AND WEST COAST OF ENGLAND	
River Severn	In winter: within a line from Blacknore Point to Caldicot Pill, Porstkewett In summer: within a line from Barry Dock Pier to Steepholm and thence to Brean Down and seaward of Zone 2 waters
River Wye	In winter: within a line from Blacknore Point to Caldicot Pill, Portskewett In summer: within a line from Barry Dock Pier to Steepholm and thence to Brean Down and seaward of Zone 2 waters
Newport	In winter: none In summer: within a line from Barry Dock Pier to Steepholm and thence to Brean Down and seaward of Zone 2 waters
Cardiff	In winter: none In summer: within a line from Barry Dock Pier to Steepholm and thence to Brean Down and seaward of Zone 2 waters
Barry	In winter: None In summer: within a line from Barry Dock Pier to Steepholm and thence to Brean Down and seaward of Zone 2 waters
Swansea	Within a line joining the seaward ends of the breakwaters
Menai Straits	Within the Menai Straits from a line joining Llanddwyn Island Light to Dinas Dinlleu and lines joining the south end of Puffin Island to Trwyn DuPoint and Llanfairfechan Railway Station, and seaward of Zone 2 waters



**▼B**

River Dee	In winter: within a line from Hilbre Point to Point of Air In summer: within a line from Formby Point to Point of Air and seaward of Zone 2 waters
River Mersey	In winter: None In summer: within a line from Formby Point to Point of Air and seaward of Zone 2 waters
Preston and Southport	Within a line from Southport to Blackpool inside the banks and seaward of Zone 2 waters
Fleetwood	In winter: None In summer: within a line from Rossal Point to Humphrey Head and seaward of Zone 2 waters
River Lune	In winter: None In summer: within a line from Rossal Point to Humphrey Head and seaward of Zone 2 waters
Heysham	In winter: None In summer: within a line from Rossal Point to Humphrey Head
Morecambe	In winter: None In the summer: from within a line from Rossal Point to Humphrey Head
Workington	Within a line from Southernness Point to Silloth and seaward of Zone 2 waters

## SOUTH OF ENGLAND

River Colne, Colchester	In winter: within a line from Colne Point to Whitstable In summer: within a line from Clacton Pier to Reculvers
River Blackwater	In winter: within a line from Colne Point to Whitstable In summer: within a line from Clacton Pier to Reculvers and seaward of Zone 2 waters

**▼B**

River Crouch and River Roach	<p>In winter:  within a line from Colne Point to Whitstable</p> <p>In summer:  within a line from Clacton Pier to Reculvers  and seaward of Zone 2 waters</p>
River Thames and its tributaries	<p>In winter:  within a line from Colne Point to Whitstable</p> <p>In summer:  within a line from Clacton Pier to Reculvers  and seaward of Zone 2 waters</p>
River Medway and the Swale	<p>In winter:  within a line from Colne Point to Whitstable</p> <p>In summer:  within a line from Clacton Pier to Reculvers  and seaward of Zone 2 waters</p>
Chichester	<p>Inside the Isle of Wight within an area bounded by lines drawn between the church spire, West Wittering, to Trinity Church, Bembridge, to the eastward, and the Needles and Hurst Point to the westward  and seaward of Zone 2 waters</p>
Langstone Harbour	<p>Inside the Isle of Wight within an area bounded by lines drawn between the church spire, West Wittering, to Trinity Church, Bembridge, to the eastward, and the Needles and Hurst Point to the westward  and seaward of Zone 2 waters</p>
Portsmouth	<p>Inside the Isle of Wight within an area bounded by lines drawn between the church spire, West Wittering, to Trinity Church, Bembridge, to the eastward, and the Needles and Hurst Point to the westward  and seaward of Zone 2 waters</p>
Bembridge, Isle of Wight	<p>Inside the Isle of Wight within an area bounded by lines drawn between the church spire, West Wittering, to Trinity Church, Bembridge, to the eastward, and the Needles and Hurst Point to the westward  and seaward of Zone 2 waters</p>
Cowes, Isle of Wight	<p>Inside the Isle of Wight within an area bounded by lines drawn between the church spire, West Wittering, to Trinity Church, Bembridge, to the eastward, and the Needles and Hurst Point to the westward  and seaward of Zone 2 waters</p>
Southampton	<p>Inside the Isle of Wight within an area bounded by lines drawn between the church spire, West Wittering, to Trinity Church, Bembridge, to the eastward, and the Needles and Hurst Point to the westward  and seaward of Zone 2 waters</p>
Beaulieu River	<p>Inside the Isle of Wight within an area bounded by lines drawn between the church spire, West Wittering, to Trinity Church, Bembridge, to the eastward, and the Needles and Hurst Point to the westward  and seaward of Zone 2 waters</p>
Keyhaven Lake	<p>Inside the Isle of Wight within an area bounded by lines drawn between the church spire, West Wittering, to Trinity Church, Bembridge, to the eastward, and the Needles and Hurst Point to the westward  and seaward of Zone 2 waters</p>

**▼B**

Weymouth	Within Portland Harbour and between the River Wey and Portland Harbour
Plymouth	Within a line from Cawsand to Breakwater to Staddon and seaward of Zone 2 waters
Falmouth	In winter: within a line from St Anthony Head to Rosemullion In summer: within a line from St Anthony Head to Nare Point and seaward of Zone 2 waters
River Camel	Within a line from Stepper Point to Trebetherick Point and seaward of Zone 2 waters
Bridgewater	Within the bar and seaward of Zone 2 waters
River Avon (Avon)	In winter: within a line from Blacknore Point to Caldicot Pill, Portskewett In summer: within a line from Barry Pier to Steephholm and thence to Brean Down and seaward of Zone 2 waters

**Zone 2***Czech Republic*

Dam Lake Lipno

*Federal Republic of Germany*

Ems	From a line across the Ems near the entrance to the port of Papenburg between Diemen pumping station and the opening of the dyke at Halte as far as a line linking the former Greetsiel lighthouse and the western pier of the port entrance at Eemshaven
Jade	Inside a line linking the Schillig cross light and Langwarden church tower
Weser	From the north-western edge of the railway bridge in Bremen as far as a line linking Langwarden and Cappel church towers, including the Westergate, Rekumer Loch, Rechter Nebenarm and Schweiburg side branches
Elbe	From the lower limit of the port of Hamburg as far as a line linking the Döse beacon and the western edge of the Friedrichskoog dyke (Dieksand), including the Nebelbe and the Este, Lühe, Schwinge, Oste, Pinnau, Krückau and Stör tributaries (in each case from the mouth to the barrage)
Meldorfer Bucht	Inside a line linking the western edge of the Friedrichskoog dyke (Dieksand) and the western pier head at Büsum
Eider	From the Gieselau Canal to the Eider barrage
Flensburger Förde	Inside a line linking Kegnäs lighthouse and Birknack
Schlei	Inside a line between the Schleimünde pier heads
Eckernförder Bucht	Inside a line linking Boknis-Eck and the north-eastern point of the mainland near Dänisch Nienhof

▼B

Kieler Förde	Inside a line linking the Bülk lighthouse and the Laboe naval memorial
Nord-Ostsee-Kanal (Kiel Canal)	From a line linking the pier heads at Brunsbüttel as far as a line linking the entry lights at Kiel-Holtenau, including Obereidersee and Enge, Audorfer See, Borgstedter See and Enge, Schirnauer See, Flemhuder See and the Achterwehrer Canal
Trave	from the north-western edge of the railway lift bridge and the northern edge of the Holstenbrücke (Stadttrave) in Lübeck as far as a line linking the southern inner and northern outer pier heads at Travemünde, including the Pötenitzer Wiek, Dassower See and the Altarmen at Teerhof island
Leda	From the entrance of the outer harbour of Leer sea lock to the mouth
Hunte	from the port of Oldenburg and from 140 m downstream of the Amalienbrücke in Oldenburg to the mouth
Lesum	From the Bremen-Burg railway bridge to the mouth
Este	From the tail water of Buxtehude lock to the Este barrage
Lühe	From the tail water of the Au-Mühle in Horneburg to the Lühe barrage
Schwinge	From the Salztor lock in Stade to the Schwinge barrage
Oste	From the north-eastern edge of the Bremervörde mill dam to the Oste barrage
Pinnau	From the south-western edge of the railway bridge in Pinneberg to the Pinnau barrage
Krückau	From the south-western edge of the bridge leading to/from the Wedenkamp in Elmshorn to the Krückau barrage
Stör	From Rensing tide gauge to the Stör barrage
Freiburger Hafenspriel	From the eastern edge of the sluice in Freiburg an der Elbe as far as the mouth
Wismarbucht, Kirchsee, Breitling, Salzhaff and Wismar port area	Seawards as far as a line between Hoher Wieschendorf Huk and Timmendorf light and a line linking Gollwitz light on the island of Poel and the southern point of the Wustrow peninsula
Warnow, including the Breitling and side branches	Downstream of the Mühlendamm from the northern edge of the Geinitzbrücke in Rostock towards the sea as far as a line linking the northern points of the western and eastern piers in Warnemünde
Waters enclosed by the mainland and the Darß and Zingst pensinsulas and the islands of Hiddensee and Rügen (including Stralsund port area)	Extending seawards between <ul style="list-style-type: none"> <li>— the Zingst peninsula and the island of Bock: as far as latitude 54° 26' 42' N</li> <li>— the islands of Bock and Hiddensee: as far as a line linking the northern point of the island of Bock and the southern point of the island of Hiddensee</li> <li>— the island of Hiddensee and the island of Rügen (Bug): as far as a line linking the south-eastern point of Neubessin and Buger Haken</li> </ul>
Greifswalder Bodden and Greifswald port area, including the Ryck	Seawards as far as a line from the eastern point of Thiessower Haken (Südperd) to the eastern point of the island of Ruden and continuing to the northern point of the island of Usedom (54° 10' 37' N, 13° 47' 51' E)

**▼B**

Waters enclosed by the mainland and the island of Usedom (the Peenestrom, including Wolgast port area and Achterwasser, and the Stettiner Haff) Eastwards as far as the border with the Republic of Poland in the Stettiner Haff

*Note* In the case of vessels whose home port is in another State, account is to be taken of Article 32 of the Ems-Dollart Treaty of 8 April 1960 (BGBl. 1963 II, p. 602).

*French Republic*

Dordogne	Downstream from the stone bridge at Libourne
Garonne and Gironde	Downstream from the stone bridge at Bordeaux
Loire	Downstream from the Haudaudine bridge on the Madeleine arm and downstream from the Pirmil bridge on the Pirmil arm.
Rhône	Downstream of the Trinquetaille bridge in Arles and beyond towards Marseille
Seine	Downstream of the Jeanne-d'Arc bridge in Rouen

*Republic of Hungary*

Lake Balaton

*Kingdom of the Netherlands*

Dollard

Eems

Waddenzee: including the links with the North Sea

IJsselmeer: including the Markermeer and IJmeer but excluding the Gouwzee

Nieuwe Waterweg and the Scheur

Calland Kanaal west from the Benelux harbour

Hollands Diep

Breddiep, Beerkanaal and its connected harbours

Haringvliet and Vuile Gat: including the waterways between Goeree-Overflakkee on the one hand and Voorne-Putten and Hoeksche Waard on the other

Hellegat

Volkerak

Krammer

Grevelingenmeer and Brouwerschavensche Gat: including all the waterways between Schouwen-Duiveland and Goeree-Overflakkee

Keten, Mastgat, Zijpe, Krabbenkreek, Eastern Scheldt and Roompot: including the waterways between Walcheren, Noord-Beveland and Zuid-Beveland on the one hand and Schouwen-Duiveland and Tholen on the other hand, excluding the Scheldt-Rhine Canal

Scheldt and Western Scheldt and its mouth on the sea: including the waterways between Zeeland Flanders, on the one hand, and Walcheren and Zuid-Beveland, on the other, excluding the Scheldt-Rhine Canal

*Republic of Poland*

Lagoon of Szczecin

Lagoon of Kamień

**▼B**

Lagoon of Wisła  
 Bay of Puck  
 Włocławski Reservoir  
 Lake Śniardwy  
 Lake Niegocin  
 Lake Mamry

*United Kingdom of Great Britain and Northern Ireland*

## SCOTLAND

Scapa Flow	Within an area bounded by lines drawn from Wharh on the island of Flotta to the Martello Tower on South Walls, and from Point Cletts on the island of Hoy to Thomson's Hill triangulation point on the island of Fara and thence to Gibraltar Pier on the island of Flotta
Kyle of Durness	South of Eilean Dubh
Cromarty Firth	Within a line between North Sutor and South Sutor
Inverness	Within a line from Fort George to Chanonry Point
Findhorn Bay	Within the spit
Aberdeen	Within a line from South Jetty to Abercromby Jetty
Montrose Basin	To the west of a line running north-south across the harbour entrance at Scurdie Ness Lighthouse
River Tay — Dundee	Within a line from the tidal basin (fish dock), Dundee to Craig Head, East Newport
Firth of Forth and River Forth	Within the Firth of Forth but not east of the Forth railway bridge
Dumfries	Within a line from Airds Point to Scar Point
Loch Ryan	Within a line from Cairn Point to Kircolme Point
Ayr Harbour	Inside the Bar
The Clyde	Above Zone 1 waters
Kyles of Bute	Between Colintrave and Rhubodach
Campbeltown Harbour	Within a line from Macringan's Point to Ottercharach Point
Loch Etive	Within Loch Etive above the Falls of Lora
Loch Leven	Above the bridge at Ballachulish
Loch Linnhe	North of Corran Point light
Loch Eil	The whole loch
Caledonian Canal	Lochs Lochy, Oich and Ness
Kyle of Lochalsh	Within Kyle Akin not westward of Eilean Ban Light or eastward of Eileanan Dubha
Loch Carron	Between Stromemore and Strome Ferry
Loch Broom, Ullapool	Within a line from Ullapool Point Light to Aultnaharrie
Kylesku	Across Loch Cairnbawn in the area between the easternmost point of Garbh Eilean and the westernmost point of Eilean na Rainich
Stornoway Harbour	Within a line from Arnish Point to Sandwick Bay Lighthouse, north-west side
The Sound of Scalpay	Not east of Berry Cove (Scalpay) and not west of Croc a Loin (Harris)

**▼B**

North Harbour, Scalpay and Tarbert Harbour	Within one mile from the shore of the Island of Harris
Loch Awe	The whole loch
Loch Katrine	The whole loch
Loch Lomond	The whole loch
Loch Tay	The whole loch
Loch Loyal	The whole loch
Loch Hope	The whole loch
Loch Shin	The whole loch
Loch Assynt	The whole loch
Loch Glascarnoch	The whole loch
Loch Fannich	The whole loch
Loch Maree	The whole loch
Loch Gairloch	The whole loch
Loch Monar	The whole loch
Loch Mullardach	The whole loch
Loch Cluanie	The whole loch
Loch Loyne	The whole loch
Loch Garry	The whole loch
Loch Quoich	The whole loch
Loch Arkaig	The whole loch
Loch Morar	The whole loch
Loch Shiel	The whole loch
Loch Earn	The whole loch
Loch Rannoch	The whole loch
Loch Tummel	The whole loch
Loch Ericht	The whole loch
Loch Fionn	The whole loch
Loch Glass	The whole loch
Loch Rimsdale/nan Clar	The whole loch

## NORTHERN IRELAND

Strangford Lough	Within a line from Cloghy Point to Dogtail Point
Belfast Lough	Within a line from Holywood to Macedon Point
Larne	Within a line from Larne Pier to the ferry pier on Island Magee
River Bann	From the seaward ends of the breakwaters to Toome Bridge
Lough Erne	Upper and Lower Lough Erne
Lough Neagh	Within two miles of the shore

## EAST COAST OF ENGLAND

Berwick	Within the breakwaters
Warkworth	Within the breakwaters

**▼B**

Blyth	Within the Outer Pier Heads
River Tyne	Dunston Staithes to Tyne Pier Heads
River Wear	Fatfield to Sunderland Pier Heads
Seaham	Within the breakwaters
Hartlepool	Within a line from Middleton Jetty to Old Pier Head Within a line joining North Pier Head to South Pier Head
River Tees	Within a line extending due west from Government Jetty to Tees Barrage
Whitby	Within Whitby Pier Heads
River Humber	Within a line from North Ferry to South Ferry
Grimsby Dock	Within a line from the West Pier of the Tidal Basin to the East Pier of the Fish Docks, North Quay
Boston	Inside the New Cut
Dutch River	The whole canal
River Hull	Beverley Beck to River Humber
Kielder Water	The whole lake
River Ouse	Below Naburn Lock
River Trent	Below Cromwell Lock
River Wharfe	From the junction with River Ouse to Tadcaster Bridge
Scarborough	Within Scarborough Pier Heads

## WALES AND WEST COAST OF ENGLAND

River Severn	North of a line running due west from Sharpness Point (51° 43,4' N) to Llanthony and Maisemore Weirs and seaward of Zone 3 waters
River Wye	At Chepstow, north of latitude (51° 38,0' N) to Monmouth
Newport	North of the overhead power cables crossing at Fifoots Points
Cardiff	Within a line from South Jetty to Penarth Head and the enclosed waters to the west of Cardiff Bay Barrage
Barry	Within a line joining the seaward ends of the breakwaters
Port Talbot	Within a line joining the seaward ends of the breakwaters on the River Afran outside enclosed docks
Neath	Within a line running due North from the seaward end of Baglan Bay Tanker Jetty (51° 37,2' N, 3° 50,5' W)
Llanelli and Burry Port	Within an area bounded by a line drawn from Burry Port Western Pier to Whiteford Point
Milford Haven	Within a line from South Hook Point to Thorn Point
Fishguard	Within a line joining the seaward ends of the north and east breakwaters
Cardigan	Within the Narrows at Pen-Yr-Ergyd
Aberystwyth	Within the seaward ends of the breakwaters
Aberdyfi	Within a line from Aberdyfi Railway Station to Twyni Bach Beacon



**▼B**

Barmouth	Within a line from Barmouth Railway Station to Penrhyn Point
Portmadoc	Within a line from Harlech Point to Graig Ddu
Holyhead	Within an area bounded by the main breakwater and a line drawn from the head of the breakwater to Brynglas Point, Towyn Bay
Menai Straits	Within the Menai Straits between a line joining Aber Menai Point to Belan Point and a line joining Beaumaris Pier to Pen-y-Coed Point
Conway	Within a line from Mussel Hill to Tremlyd Point
Llandudno	Within the breakwater
Rhyl	Within the breakwater
River Dee	Above Connah's Quay to Barrelwell Hill water extraction point
River Mersey	Within a line between the Rock Lighthouse and the North West Seaforth Dock but excluding other docks
Preston and Southport	Within a line from Lytham to Southport and within Preston Docks
Fleetwood	Within a line from Low Light to Knott
River Lune	Within a line from Sunderland Point to Chapel Hill up to and including Glasson Dock
Barrow	Within a line joining Haws Point, Isle of Walney to Roa Island Slipway
Whitehaven	Within the breakwater
Workington	Within the breakwater
Maryport	Within the breakwater
Carlisle	Within a line joining Point Carlisle to Torduff
Coniston Water	The whole lake
Derwentwater	The whole lake
Ullswater	The whole lake
Windermere	The whole lake

## SOUTH OF ENGLAND

Blakeney and Morston Harbour and approaches	To the east of a line running south from Blakeney Point to the entrance of the Stiffkey River
River Orwell and River Stour	River Orwell within a line from Blackmanshead breakwater to Landguard Point and seaward of Zone 3 waters
River Blackwater	All waterways within a line from the south-western extremity of Mersea Island to Sales Point
River Crouch and River Roach	River Crouch within a line from Holliwell Point to Foulness Point, including the River Roach
River Thames and its tributaries	River Thames above a line drawn north/south through the eastern extremity of Denton Wharf Pier, Gravesend to Teddington Lock
River Medway and the Swale	River Medway from a line drawn from Garrison Point to the Grain Tower, to Allington Lock; and the Swale from Whitstable to the Medway
River Stour (Kent)	River Stour above the mouth to the landing at Flagstaff Reach
Dover Harbour	Within lines drawn across the east and west entrances to the Harbour

**▼B**

River Rother	River Rother above the Tidal Signal Station at Camber to Scots Float Sluice and to the entrance lock on the River Brede
River Adur and Southwick Canal	Within a line drawn across Shoreham Harbour entrance to Southwick Canal Lock and to the west end of Tarmac Wharf
River Arun	River Arun above Littlehampton Pier to Littlehampton Marina
River Ouse (Sussex) Newhaven	River Ouse from a line drawn across Newhaven Harbour entrance piers to the north end of North Quay
Brighton	Brighton Marina outer harbour within a line from the southern end of West Quay to the north end of South Quay
Chichester	Within a line drawn between Eastoke point and the church spire, West Wittering and seaward of Zone 3 waters
Langstone Harbour	Within a line drawn between Eastney Point and Gunner Point
Portsmouth	Within a line drawn across the harbour entrance from Port Blockhouse to the Round Tower
Bembridge, Isle of Wight	Within Brading Harbour
Cowes, Isle of Wight	The River Medina within a line from the Breakwater Light on the east bank to the House Light on the west bank
Southampton	Within a line from Calshot Castle to Hook Beacon
Beaulieu River	Within Beaulieu River not eastward of a north/south line through Inchmery House
Keyhaven Lake	Within a line drawn due north from Hurst Point Low Light to Keyhaven Marshes
Christchurch	The Run
Poole	Within the line of the Chain Ferry between Sandbanks and South Haven Point
Exeter	Within an east-west line from Warren Point to the Inshore Lifeboat Station opposite Checkstone Ledge
Teignmouth	Within the harbour
River Dart	Within a line from Kettle Point to Battery Point
River Salcombe	Within a line from Splat Point to Limebury Point
Plymouth	Within a line from Mount Batten Pier to Raveness Point through Drake's Islands; the River Yealm within a line from Warren Point to Misery Point
Fowey	Inside the Harbour
Falmouth	Within a line from St. Anthony Head to Pendennis Point
River Camel	Within a line from Gun Point to Brea Hill
Rivers Taw and Torridge	Within a line bearing 200° from the lighthouse on Crow Point to the shore at Skern Point
Bridgewater	South of a line running due East from Stert Point (51° 13,0 'N)
River Avon (Avon)	Within a line from Avonmouth Pier to Wharf Point, to Netham Dam

**▼B**

## CHAPTER 2

**Zone 3***Kingdom of Belgium*

Maritime Scheldt (downstream of Antwerp open anchorage)

**▼M2***Republic of Bulgaria*

Danube: from rkm 845,650 to rkm 374,100

**▼B***Czech Republic*

Labe: from the lock Ústí nad Labem-Střekov to the lock Lovosice

Dam Lakes: Baška, Brněnská (Kníničky), Horka (Stráž pod Ralskem), Hracholusky, Jesenice, Nechanice, Olešná, Orlik, Pastviny, Plumov, Rozkoš, Seč, Skalka, Slapy, Těrlicko, Žermanice

Lake Máchovo

Water Area Velké Žernoseky

Ponds: Oleksovice, Svět, Velké Dářko

Mining Gravel Lakes: Dolní Benešov, Ostrožná Nová Ves a Tovačov

*Federal Republic of Germany*

Danube From Kelheim (km 2 414,72) to the German-Austrian border

Rhine From the German-Swiss border to the German-Netherlands border

Elbe From the mouth of the Elbe-Seiten canal to the lower limit of the port of Hamburg

Müritz

*French Republic*

Rhine

*Republic of Hungary*

Danube: from rkm 1812 to rkm 1433

Danube Moson: from rkm 14 to rkm 0

Danube Szentendre: from rkm 32 to rkm 0

Danube Ráckeve: from rkm 58 to rkm 0

River Tisza: from rkm 685 to rkm 160

River Dráva: from rkm 198 to rkm 70

River Bodrog: from rkm 51 to rkm 0

River Kettős-Körös: from rkm 23 to rkm 0

River Hármas-Körös: from rkm 91 to rkm 0

Channel Sió: from rkm 23 to rkm 0

Lake Velence

Lake Fertő

**▼B***Kingdom of the Netherlands*

## Rhine

Sneekermeer, Koevordermeer, Heegermeer, Fluessen, Slotermeer, Tjeukemeer, Beulakkerwilde, Belterwilde, Ramsdiep, Ketelmeer, Zwartemeer, Veluwemeer, Eemmeer, Alkmaardermeer, Gouwzee, Buiten IJ afgesloten IJ Noordzeekanaal, port of IJmuiden, Rotterdam port area, Nieuwe Maas, Noord, Oude Maas, Beneden Merwede, Nieuwe Merwede, Dordsche Kil, Boven Merwede, Waal, Bijlandsch Canal, Boven Rijn, Pannersdensch Canal, Geldersche IJssel, Neder Rijn, Lek, Amsterdam-Rhine-Canal, Veerse Meer, Schelde-Rhine-Canal as far as the mouth in the Volkerak, Amer, Bergsche Maas, the Meuse below Venlo, Gooimeer, Europort, Calandkanaal (east from the Benelux harbour), Hartelkanaal

*Republic of Austria*

Danube: from the border with Germany to the border with Slovakia

Inn: from the mouth to the Passau-Ingling Power Station

Traun: from the mouth to km 1,80

Enns: from the mouth to km 2,70

March: to km 6,00

*Republic of Poland*

- River Biebrza from the estuary of the Augustowski Channel to the estuary of the river Narwia
- River Brda from the link with the Bydgoski Channel in Bydgoszcz to the estuary of the river Wisła
- River Bug from the estuary of the river Muchawiec to the estuary of the river Narwia
- Lake Dąbie to the frontier with internal sea waters
- The Augustowski Channel from the link with the river Biebrza to the State border, together with the lakes located along the route of this Channel
- The Bartnicki Channel from Lake Ruda Woda to Lake Bartężek, together with Lake Bartężek
- The Bydgoski Channel
- The Elbląski Channel from Lake Druzno to Lake Jeziorak and Lake Szeląg Wielki, together with these lakes and the lakes on the route of the Channel, and a byway in the direction of Zalewo from Lake Jeziorak to Lake Ewingi, inclusive
- The Gliwicki Channel together with the Channel Kędzierzyński
- The Jagielloński Channel from the link with the river Elbląg to the river Nogat
- The Łaczański Channel
- The Ślesiński Channel with the lakes located along the route of this Channel and Lake Gopło
- The Żerański Channel
- River Martwa Wisła from the river Wisła in Przegalina to the frontier with internal sea waters
- River Narew from the estuary of the river Biebrza to the estuary of the river Wisła, together with Lake Zegrzyński
- River Nogat from the river Wisła to the estuary of the Lagoon of Wisła
- River Noteć (upper) from Lake Gopło to the link with the Górnonotecki Channel and the Górnonotecki Channel and River Noteć (lower) from the link of the Bydgoski Channel to the estuary to River Warta
- River Nysa Łużycka from Gubin to the estuary to River Odra
- River Odra from the town of Racibórz to the link with River Eastern Odra which turns into River Regalica from the Klucz-Ustowo Piercing, together

**▼B**

- with that river and its side-branches to Lake Dąbie as well as a byway of River Odra from the Opatowice lock to the lock in Wrocław city
- River Western Odra from a weir in Widuchowa (704,1 km of River Odra) to a border with internal sea waters, together with side-branches as well as the Klucz-Ustowo Piercing linking River Eastern Odra with River Western Odra
  - River Parnica and the Parnicki Piercing from River Western Odra to a border with internal sea waters
  - River Pisa from Lake Roś to the estuary of River Narew
  - River Szkarpada from River Wisła to the estuary of the Lagoon of Wisła
  - River Warta from the Ślesińskie Lake to the estuary of River Odra
  - System of Wielkie Jeziora Mazurskie encompassing the lakes linked by the rivers and channels constituting a main route from Lake Roś (inclusive) in Pisz to the Węgorzewski Channel (including that channel) in Węgorzewo, together with Lakes Seksty, Mikołajskie, Tałty, Tałtowisko, Kotek, Szymon, Szymoneckie, Jagodne, Boczne, Tajty, Kisajno, Dargin, Łabap, Kirsajty and Święcajty, together with the Giżycki Channel and the Niegociński Channel and the Piękna Góra Channel, and a byway of Lake Ryńskie (inclusive) in Ryn to Lake Nidzkie (up to 3 km, constituting a border with the 'Lake Nidzkie' nature reserve), together with lakes Beldany, Guzianka Mała and Guzianka Wielka
  - River Wisła from the estuary of River Przemsza to the link with the Łaczański Channel as well as from the estuary of that Channel in Skawina to the estuary of River Wisła to the Bay of Gdańsk, excluding the Włocławski Reservoir

**▼M2***Romania*

Danube: from the Serbian–Romanian border (km 1 075) to the Black Sea on the Sulina Channel-branch

Danube–Black Sea Canal (64,410 km length): from the junction with the Danube river, at km 299,300 of the Danube at Cernavodă (respectively km 64,410 of the Canal), to the Port of Constanta South–Agigea (km '0' of the Canal)

Poarta Albă–Midia Năvodari Canal (34,600 km length): from the junction with the Danube Poarta Albă–Midia Năvodari Canal (34,600 km length): from the junction with the Danube–Black Sea Canal at km 29,410 at Poarta Albă (respectively km 27,500 of the Canal) to the Port of Midia (km '0' of the Canal)

**▼B***Slovak Republic*

Danube: from Devín (rkm 1880,26) to the Slovak–Hungarian border

*United Kingdom of Great Britain and Northern Ireland*

## SCOTLAND

Leith (Edinburgh)	Within the breakwaters
Glasgow	Strathclyde Loch
Crinan Canal	Crinan to Ardrishaig
Caledonian Canal	The canal sections

## NORTHERN IRELAND

River Lagan	Lagan Weir to Stranmillis
-------------	---------------------------

## EAST OF ENGLAND

River Wear (non-tidal)	Old Railway Bridge, Durham to Prebends Bridge, Durham
River Tees	Upriver from Tees Barrage

**▼B**

Grimsby Dock	Inside of the locks
Immingham Dock	Inside of the locks
Hull Docks	Inside of the locks
Boston Dock	Inside the lock gates
Aire and Calder Navigation	Goole Docks to Leeds; junction with Leeds and Liverpool Canal; Bank Dole Junction to Selby (River Ouse Lock); Castleford Junction to Wakefield (Falling Lock)
River Ancholme	Ferriby Sluice to Brigg
Calder and Hebble Canal	Wakefield (Falling Lock) to Broadcut Top Lock
River Foss	From (Blue Bridge) junction with River Ouse to Monk Bridge
Fosdyke Canal	Junction with River Trent to Brayford Pool
Goole Dock	Inside the lock gates
Hornsea Mere	The whole canal
River Hull	From Struncheon Hill Lock to Beverley Beck
Market Weighton Canal	River Humber Lock to Sod Houses Lock
New Junction Canal	The whole canal
River Ouse	From Naburn Lock to Nun Monkton
Sheffield and South Yorkshire Canal	Keadby Lock to Tinsley Lock
River Trent	Cromwell Lock to Shardlow
River Witham	Boston Sluice to Brayford Poole (Lincoln)

## WALES AND WEST OF ENGLAND

River Severn	Above Llanthony and Maisemore Weirs
River Wye	Above Monmouth
Cardiff	Roath Park Lake
Port Talbot	Within the enclosed docks
Swansea	Within the enclosed docks
River Dee	Above Barrelwell Hill water extraction point
River Mersey	The docks (excluding Seaforth Dock)
River Lune	Above Glasson Dock
River Avon (Midland)	Tewkesbury Lock to Evesham
Gloucester	Gloucester City Docks Gloucester/Sharpness Canal
Hollingworth Lake	The whole lake
Manchester Ship Canal	The whole canal and Salford Docks including River Irwell
Pickmere Lake	The whole lake
River Tawe	Between Sea Barrage/Marina and the Morfa Athletics Stadium
Rudyard Lake	The whole lake
River Weaver	Below Northwich

## SOUTH OF ENGLAND

River Nene	Wisbech Cut and River Nene to Dog-in-a-Doublet Lock
------------	---

**▼B**

River Great Ouse	Kings Lynn Cut and River Great Ouse below West Lynn Road Bridge
Yarmouth	River Yare Estuary from a line drawn across the ends of the north and south entrance piers, including Breydon Water
Lowestoft	Lowestoft Harbour below Mutford Lock to a line drawn across the outer harbour entrance piers
Rivers Alde and Ore	Above the entrance to the River Ore to Westrow Point
River Deben	Above the entrance of the River Deben to Felixstowe Ferry
River Orwell and River Stour	From a line drawn from Fagbury Point to Shotley Point on the River Orwell to Ipswich Dock; and from a line drawn north/south through Erwarnton Ness on the River Stour to Manningtree
Chelmer & Blackwater Canal	Eastward of Beeleigh Lock
River Thames and its tributaries	River Thames above Teddington Lock to Oxford
River Adur and Southwick Canal	River Adur above the west end of Tarmac Wharf, and within Southwick Canal
River Arun	River Arun above Littlehampton Marina
River Ouse (Sussex), Newhaven	River Ouse above the north end of North Quay
Bewl Water	The whole lake
Grafham Water	The whole lake
Rutland Water	The whole lake
Thorpe Park Lake	The whole lake
Chichester	East of a line joining Cobnor Point and Chalkdock Point
Christchurch	Within Christchurch Harbour excluding the Run
Exeter Canal	The whole canal
River Avon (Avon)	Bristol City Docks Netham Dam to Pulteney Weir

## CHAPTER 3

**Zone 4***Kingdom of Belgium*

The entire Belgian network except the waterways in Zone 3

*Czech Republic*

All other waterways not listed in Zones 1, 2 and 3

*Federal Republic of Germany*

All inland waterways other than those in Zones 1, 2 and 3

*French Republic*

The entire French network except the waterways in Zones 1, 2 and 3

*Italian Republic*

River Po: from Piacenza to the mouth

**▼ B**

Milan-Cremona Canal, River Po: final stretch of 15 km to the Po  
 River Mincio: from Mantua, Governolo to the Po  
 Ferrara Waterway: from the Po (Pontelagoscuro), Ferrara to Porto Garibaldi  
 Brondolo and Valle Canals: from the eastern Po to the Venice lagoon  
 Fissero Canal — Tartaro — Canalbianco: from Adria to the eastern Po  
 Venetian coastline: from the Venice lagoon to Grado

*Republic of Lithuania*

The entire Lithuanian network

*Grand Duchy of Luxembourg*

Moselle

*Republic of Hungary*

All other waterways not listed in Zones 2 and 3

*Kingdom of the Netherlands*

All other rivers, canals and inland seas not listed in Zones 1, 2 and 3

*Republic of Austria*

Thaya: up to Bernhardsthal

March: above km 6,00

*Republic of Poland*

All other waterways not listed in Zones 1, 2 and 3

**▼ M2***Romania*

All other waterways not listed in Zone 3

**▼ B***Slovak Republic*

All other waterways not listed in Zone 3

*United Kingdom of Great Britain and Northern Ireland*

## SCOTLAND

Ratho and Linlithgow Union Canal	The whole canal
Glasgow	Forth and Clyde Canal Monkland Canal, Faskine and Drumpellier sections Hogganfield Loch

## EAST OF ENGLAND

River Ancholme	Brigg to Harram Hill Lock
Calder and Hebble Canal	Broadcut Top Lock to Sowerby Bridge
Chesterfield Canal	West Stockwith to Worksop
Cromford Canal	The whole canal
River Derwent	From junction with River Ouse to Stamford Bridge



**▼B**

Drifffield Navigation	From Struncheon Hill Lock to Great Drifffield
Erewash Canal	Trent Lock to Langley Mill Lock
Huddersfield Canal	Junction with Calder and Hebble at Coopers Bridge to Huddersfield Narrow Canal at Huddersfield Between Ashton-Under-Lyne and Huddersfield
Leeds and Liverpool Canal	From Leeds River Lock to Skipton Wharf
Light Water Valley Lake	The whole lake
The Mere, Scarborough	The whole lake
River Ouse	Above Nun Monkton Pool
Pocklington Canal	From the junction with River Derwent to Melbourne Basin
Sheffield and South Yorkshire Canal	Tinsley Lock to Sheffield
River Soar	Trent Junction to Loughborough
Trent and Mersey Canal	Shardlow to Dellow Lane Lock
River Ure and Ripon Canal	From Junction with River Ouse to Ripon Canal (Ripon Basin)
Ashton Canal	The whole canal

## WALES AND WEST OF ENGLAND

River Avon (Midland)	Above Evesham
Birmingham Canal Navigation	The whole canal
Birmingham and Fazeley Canal	The whole canal
Coventry Canal	The whole canal
Grand Union Canal (from Napton Junction to Birmingham and Fazeley)	The whole section of the canal
Kennet and Avon Canal (Bath to Newbury)	The whole section of the canal
Lancaster Canal	The whole canal
Leeds and Liverpool Canal	The whole canal
Llangollen Canal	The whole canal
Caldon Canal	The whole canal
Peak Forest Canal	The whole canal
Macclesfield Canal	The whole canal
Monmouthshire and Brecon Canal	The whole canal
Montgomery Canal	The whole canal
Rochdale Canal	The whole canal
Swansea Canal	The whole canal
Neath & Tennant Canal	The whole canal

**▼B**

Shropshire Union Canal	The whole canal
Staffordshire and Worcester Canal	The whole canal
Stratford-upon-Avon Canal	The whole canal
River Trent	The whole river
Trent and Mersey Canal	The whole canal
River Weaver	Above Northwich
Worcester and Birmingham Canal	The whole canal

## SOUTH OF ENGLAND

River Nene	Above Dog-in-a-Doublet Lock
River Great Ouse	Kings Lynn above West Lynn Road Bridge; River Great Ouse and all connected Fenland Waterways including the River Cam and Middle Level Navigation
The Norfolk and Suffolk Broads	All navigable tidal and non-tidal rivers, broads, canals and waterways within the Norfolk and Suffolk Broads including Oulton Broad, and Rivers Waveney, Yare, Bure, Ant and Thurne except as specified for Yarmouth and Lowestoft
River Blyth	River Blyth, entrance to Blythburgh
Rivers Alde and Ore	On the River Alde above Westrow Point
River Deben	River Deben above Felixstowe Ferry
River Orwell and River Stour	All waterways on the River Stour above Manningtree
Chelmer & Blackwater Canal	Westward of Beeleigh Lock
River Thames and its tributaries	River Stort and River Lee above Bow Creek; Grand Union Canal above Brentford Lock and Regents Canal above Limehouse Basin and all canals connected therewith; River Wey above Thames Lock; Kennet and Avon Canal; River Thames above Oxford; Oxford Canal
River Medway and the Swale	River Medway above Allington Lock
River Stour (Kent)	River Stour above the landing at Flagstaff Reach
Dover Harbour	The whole harbour
River Rother	River Rother and the Royal Military Canal above Scots Float Sluice and River Brede above the entrance lock
Brighton	Brighton Marina inner harbour above the lock
Wickstead Park Lake	The whole lake
Kennet and Avon Canal	The whole canal
Grand Union Canal	The whole canal
River Avon (Avon)	Above Pulteney Weir
Bridgewater Canal	The whole canal

**▼B***ANNEX II***MINIMUM TECHNICAL REQUIREMENTS APPLICABLE TO VESSELS  
ON INLAND WATERWAYS OF ZONES 1, 2, 3 AND 4**

## CONTENTS

## PART I

## CHAPTER 1

## GENERAL

- Article 1.01 — Definitions
- Article 1.02 — (Left void)
- Article 1.03 — (Left void)
- Article 1.04 — (Left void)
- Article 1.05 — (Left void)
- Article 1.06 — Temporary requirements
- Article 1.07 — Administrative instructions

## CHAPTER 2

## PROCEDURE

- Article 2.01 — Inspection bodies
- Article 2.02 — Request for an inspection
- Article 2.03 — Presentation of the craft for inspection
- Article 2.04 — (Left void)
- Article 2.05 — Provisional Community certificate
- Article 2.06 — Validity of the Community certificate
- Article 2.07 — Particulars in and amendments to the Community certificate
- Article 2.08 — (Left void)
- Article 2.09 — Periodical inspection
- Article 2.10 — Voluntary inspection
- Article 2.11 — (Left void)
- Article 2.12 — (Left void)
- Article 2.13 — (Left void)
- Article 2.14 — (Left void)
- Article 2.15 — Expenses
- Article 2.16 — Information
- Article 2.17 — Register of Community certificates

**▼M3**

- Article 2.18 — Unique European Vessel Identification Number

**▼B**

- Article 2.19 — Equivalences and derogations

## PART II

## CHAPTER 3

## SHIPBUILDING REQUIREMENTS

- Article 3.01 — Basic requirement
- Article 3.02 — Strength and stability

**▼B**

- Article 3.03 — Hull
- Article 3.04 — Engine and boiler rooms, bunkers

## CHAPTER 4

## SAFETY CLEARANCE, FREEBOARD AND DRAUGHT MARKS

- Article 4.01 — Safety clearance
- Article 4.02 — Freeboard
- Article 4.03 — Minimum freeboard
- Article 4.04 — Draught marks
- Article 4.05 — Maximum loaded draught of vessels whose holds are not always closed so as to be spray-proof and weathertight
- Article 4.06 — Draught scales

## CHAPTER 5

## MANOEUVRABILITY

- Article 5.01 — General
- Article 5.02 — Navigation tests
- Article 5.03 — Test area
- Article 5.04 — Degree of loading of vessels and convoys during navigation tests
- Article 5.05 — Use of on-board facilities for navigation test
- Article 5.06 — Prescribed (forward) speed
- Article 5.07 — Stopping capacity
- Article 5.08 — Capacity for going astern
- Article 5.09 — Capacity for taking evasive action
- Article 5.10 — Turning capacity

## CHAPTER 6

## STEERING SYSTEM

- Article 6.01 — General requirements
- Article 6.02 — Steering apparatus drive unit
- Article 6.03 — Hydraulic steering apparatus drive unit
- Article 6.04 — Power source
- Article 6.05 — Manual drive
- Article 6.06 — Rudder-propeller, water-jet, cycloidal-propeller and bow-thruster systems
- Article 6.07 — Indicators and monitoring devices
- Article 6.08 — Rate-of-turn regulators

**▼M3**

- Article 6.09 — Acceptance and periodical inspections

**▼B**

## CHAPTER 7

## WHEELHOUSE

- Article 7.01 — General
- Article 7.02 — Unobstructed view
- Article 7.03 — General requirements concerning control, indicating and monitoring equipment

**▼B**

- Article 7.04 — Specific requirements concerning control, indicating and monitoring equipment of main engines and steering system
- Article 7.05 — Navigation lights, light signals and sound signals
- Article 7.06 — Radar installations and rate-of-turn indicators
- Article 7.07 — Radio telephony systems for vessels with wheelhouses designed for radar navigation by one person
- Article 7.08 — Internal communication facilities on board
- Article 7.09 — Alarm system
- Article 7.10 — Heating and ventilation
- Article 7.11 — Stern-anchor operating equipment
- Article 7.12 — Retractable wheelhouses
- Article 7.13 — Entry in the Community certificate for vessels with wheelhouses designed for radar navigation by one person

## CHAPTER 8

## ENGINE DESIGN

- Article 8.01 — General
- Article 8.02 — Safety equipment
- Article 8.03 — Power plant
- Article 8.04 — Engine exhaust system
- Article 8.05 — Fuel tanks, pipes and accessories
- Article 8.06 — Storage of lubricating oil, pipes and accessories
- Article 8.07 — Storage of oils used in power transmission systems, control and activating systems and heating systems, pipes and accessories
- Article 8.08 — Bilge pumping and drainage systems
- Article 8.09 — Oily water and used oil stores
- Article 8.10 — Noise emitted by vessels

## CHAPTER 8a (Left void)

## CHAPTER 9

## ELECTRICAL EQUIPMENT

- Article 9.01 — General
- Article 9.02 — Electricity supply systems
- Article 9.03 — Protection against physical contact, intrusion of solid objects and the ingress of water
- Article 9.04 — Protection from explosion
- Article 9.05 — Earthing
- Article 9.06 — Maximum permissible voltages
- Article 9.07 — Distribution systems
- Article 9.08 — Connection to shore or other external networks
- Article 9.09 — Power supply to other craft
- Article 9.10 — Generators and motors
- Article 9.11 — Accumulators
- Article 9.12 — Switchgear installations
- Article 9.13 — Emergency circuit breakers
- Article 9.14 — Installation fittings

**▼B**

- Article 9.15 — Cables
- Article 9.16 — Lighting installations
- Article 9.17 — Navigation lights
- Article 9.18 — (Left void)
- Article 9.19 — Alarm and safety systems for mechanical equipment
- Article 9.20 — Electronic equipment
- Article 9.21 — Electromagnetic compatibility

## CHAPTER 10

## EQUIPMENT

- Article 10.01 — Anchor equipment
- Article 10.02 — Other equipment
- Article 10.03 — Portable fire extinguishers
- Article 10.03a — Permanently installed fire-fighting systems in accommodation spaces, wheelhouses and passenger spaces
- Article 10.03b — Permanently installed fire-fighting systems in engine rooms, boiler rooms and pump rooms

**▼M3**

- Article 10.03c — Permanently installed firefighting systems for protecting objects

**▼B**

- Article 10.04 — Ship's boats
- Article 10.05 — Lifebuoys and lifejackets

## CHAPTER 11

## SAFETY AT WORK STATIONS

- Article 11.01 — General
- Article 11.02 — Protection against falling
- Article 11.03 — Dimensions of working spaces
- Article 11.04 — Side decks
- Article 11.05 — Access to working spaces
- Article 11.06 — Exits and emergency exits
- Article 11.07 — Ladders, steps and similar devices
- Article 11.08 — Interior spaces
- Article 11.09 — Protection against noise and vibration
- Article 11.10 — Hatch covers
- Article 11.11 — Winches
- Article 11.12 — Cranes
- Article 11.13 — Storing flammable liquids

## CHAPTER 12

## ACCOMMODATION

- Article 12.01 — General
- Article 12.02 — Special design requirements for accommodation
- Article 12.03 — Sanitary installations
- Article 12.04 — Galleys
- Article 12.05 — Potable water

**▼B**

Article 12.06 — Heating and ventilation

Article 12.07 — Other accommodation installations

## CHAPTER 13

## FUEL-FIRED HEATING, COOKING AND REFRIGERATING EQUIPMENT

Article 13.01 — General

Article 13.02 — Use of liquid fuels, oil-fired equipment

Article 13.03 — Vaporising oil burner stoves and atomising oil burner heating appliances

Article 13.04 — Vaporising oil burner stoves

Article 13.05 — Atomising oil burner heating appliances

Article 13.06 — Forced-air heating appliances

Article 13.07 — Solid fuel heating

## CHAPTER 14

## LIQUEFIED GAS INSTALLATIONS FOR DOMESTIC PURPOSES

Article 14.01 — General

Article 14.02 — Installations

Article 14.03 — Receptacles

Article 14.04 — Location and arrangement of supply units

Article 14.05 — Spare and empty receptacles

Article 14.06 — Pressure regulators

Article 14.07 — Pressure

Article 14.08 — Piping and flexible tubes

Article 14.09 — Distribution system

Article 14.10 — Gas-consuming appliances and their installation

Article 14.11 — Ventilation and evacuation of combustion gases

Article 14.12 — Operating and safety requirements

Article 14.13 — Acceptance test

Article 14.14 — Tests

Article 14.15 — Attestation

## CHAPTER 15

## SPECIFIC REQUIREMENTS APPLICABLE TO PASSENGER VESSELS

Article 15.01 — General provisions

Article 15.02 — Vessels' hulls

Article 15.03 — Stability

Article 15.04 — Safety clearance and freeboard

Article 15.05 — Maximum permitted number of passengers

Article 15.06 — Passenger rooms and areas

Article 15.07 — Propulsion system

Article 15.08 — Safety devices and equipment

Article 15.09 — Life-saving equipment

Article 15.10 — Electrical Equipment

Article 15.11 — Fire protection

Article 15.12 — Fire-fighting

**▼B**

- Article 15.13 — Safety organisation
- Article 15.14 — Waste water collection and disposal facilities
- Article 15.15 — Derogations for certain passenger vessels

## CHAPTER 15a

## SPECIFIC REQUIREMENTS FOR PASSENGER SAILING VESSELS

- Article 15a.01 — Application of Part II
- Article 15a.02 — Exceptions for certain passenger sailing vessels
- Article 15a.03 — Stability requirements for vessels under sail
- Article 15a.04 — Shipbuilding and mechanical requirements
- Article 15a.05 — Rigging in general
- Article 15a.06 — Masts and spars in general
- Article 15a.07 — Special provisions for masts
- Article 15a.08 — Special provisions for topmasts
- Article 15a.09 — Special provisions for bowsprits
- Article 15a.10 — Special provisions for jib-booms
- Article 15a.11 — Special provisions for main booms
- Article 15a.12 — Special provisions for gaffs
- Article 15a.13 — General provisions for standing and running rigging
- Article 15a.14 — Special provisions for standing rigging
- Article 15a.15 — Special provisions for running rigging
- Article 15a.16 — Fittings and parts of the rigging
- Article 15a.17 — Sails
- Article 15a.18 — Equipment
- Article 15a.19 — Testing

## CHAPTER 16

## SPECIFIC REQUIREMENTS APPLICABLE TO CRAFT INTENDED TO FORM PART OF A PUSHED OR TOWED CONVOY OR OF A SIDE-BY-SIDE FORMATION

- Article 16.01 — Craft suitable for pushing
- Article 16.02 — Craft suitable for being pushed
- Article 16.03 — Craft suitable for propelling side-by-side formations
- Article 16.04 — Craft suitable for being propelled in convoys
- Article 16.05 — Craft suitable for towing
- Article 16.06 — Navigation tests on convoys
- Article 16.07 — Entries on the Community certificate

## CHAPTER 17

## SPECIFIC REQUIREMENTS APPLICABLE TO FLOATING EQUIPMENT

- Article 17.01 — General
- Article 17.02 — Derogations
- Article 17.03 — Additional requirements
- Article 17.04 — Residual safety clearance
- Article 17.05 — Residual freeboard
- Article 17.06 — Heeling test
- Article 17.07 — Confirmation of stability



**▼B**

Article 17.08 — Confirmation of stability in the case of reduced residual freeboard

Article 17.09 — Draught marks and draught scales

Article 17.10 — Floating equipment without confirmation of stability

## CHAPTER 18

## SPECIFIC REQUIREMENTS APPLICABLE TO WORKSITE CRAFT

Article 18.01 — Operating conditions

Article 18.02 — Application of Part II

Article 18.03 — Derogations

Article 18.04 — Safety clearance and freeboard

Article 18.05 — Ship's boats

## CHAPTER 19

SPECIFIC REQUIREMENTS APPLICABLE TO HISTORIC VESSELS  
(Left void)

## CHAPTER 19a

SPECIFIC REQUIREMENTS APPLICABLE TO CANAL BARGES (Left  
void)

## CHAPTER 19b

SPECIFIC REQUIREMENTS APPLICABLE TO VESSELS NAVI-  
GATING ON ZONE 4 WATERWAYS

Article 19b.01 — Application of Chapter 4

## CHAPTER 20

SPECIFIC REQUIREMENTS APPLICABLE TO SEA-GOING VESSELS  
(Left void)

## CHAPTER 21

SPECIFIC REQUIREMENTS APPLICABLE TO RECREATIONAL  
CRAFT

Article 21.01 — General

Article 21.02 — Application of Part II

Article 21.03 — (Left void)

## CHAPTER 22

## STABILITY OF VESSELS CARRYING CONTAINERS

Article 22.01 — General

Article 22.02 — Limit conditions and method of calculation for  
confirmation of stability for the transport of non-  
secured containers

Article 22.03 — Limit conditions and method of calculation for  
confirmation of stability for the transport of secured  
containers

Article 22.04 — Procedure for assessing stability on board

## CHAPTER 22a

SPECIFIC REQUIREMENTS APPLICABLE TO CRAFT LONGER  
THAN 110 M

Article 22a.01 — Application of Part I

Article 22a.02 — Application of Part II

Article 22a.03 — Strength

Article 22a.04 — Buoyancy and stability

**▼B**

Article 22a.05 — Additional requirements

Article 22a.06 — Application of Part IV in the event of conversion

## CHAPTER 22b

## SPECIFIC REQUIREMENTS APPLICABLE TO HIGH-SPEED VESSELS

Article 22b.01 — General

Article 22b.02 — Application of Part I

Article 22b.03 — Application of Part II

Article 22b.04 — Seats and safety belts

Article 22b.05 — Freeboard

Article 22b.06 — Buoyancy, stability and subdivision

Article 22b.07 — Wheelhouse

Article 22b.08 — Additional equipment

Article 22b.09 — Closed areas

Article 22b.10 — Exits and escape routes

Article 22b.11 — Fire protection and fire-fighting

Article 22b.12 — Transitional provisions

## PART III

## CHAPTER 23

## EQUIPMENT OF VESSELS WITH REGARD TO MANNING

Article 23.01 — (Left void)

Article 23.02 — (Left void)

Article 23.03 — (Left void)

Article 23.04 — (Left void)

Article 23.05 — (Left void)

Article 23.06 — (Left void)

Article 23.07 — (Left void)

Article 23.08 — (Left void)

Article 23.09 — Vessels' equipment

Article 23.10 — (Left void)

Article 23.11 — (Left void)

Article 23.12 — (Left void)

Article 23.13 — (Left void)

Article 23.14 — (Left void)

Article 23.15 — (Left void)

## PART IV

## CHAPTER 24

## TRANSITIONAL AND FINAL PROVISIONS

Article 24.01 — Applicability of transitional provisions to craft which are already in service

Article 24.02 — Derogations for craft which are already in service

Article 24.03 — Derogations for craft which were laid down on or before 1 April 1976

Article 24.04 — Other derogations

**▼B**

Article 24.05 — (Left void)

Article 24.06 — Derogations for craft not covered by Article 24.01 —

Article 24.07 — (Left void)

CHAPTER 24a

TRANSITIONAL PROVISIONS FOR CRAFT NOT NAVIGATING ON  
ZONE R WATERWAYS

Article 24a.01 — Application of transitional provisions to craft  
already in service and validity of previous  
Community certificates

Article 24a.02 — Derogations for craft already in service

Article 24a.03 — Derogations for craft the keels of which were laid  
before 1 January 1985

Article 24a.04 — Other derogations

*APPENDIX I* — SAFETY SIGNS

*APPENDIX II* — ADMINISTRATIVE INSTRUCTIONS

*APPENDIX III* — MODEL OF THE UNIQUE EUROPEAN VESSEL IDENTIFICATION NUMBER

*APPENDIX IV* — DATA FOR THE IDENTIFICATION OF A VESSEL

**▼B**

## PART I

## CHAPTER 1

**GENERAL***Article 1.01***Definitions**

The following definitions shall apply in this Directive:

*Types of craft*

1. 'craft': a vessel or item of floating equipment;
2. 'vessel': an inland waterway vessel or sea-going ship;
3. 'inland waterway vessel': a vessel intended solely or mainly for navigation on inland waterways;
4. 'sea-going ship': a vessel certificated for sea-going service;
5. 'motor vessel': a motor cargo vessel or a motor tanker;
6. 'motor tanker': a vessel intended for the carriage of goods in fixed tanks and built to navigate independently under its own motive power;
7. 'motor cargo vessel': a vessel, other than a motor tanker, intended for the carriage of goods and built to navigate independently under its own motive power;
8. 'canal barge': an inland waterway vessel not exceeding 38,5 m in length and 5,05 m in breadth and usually operating on the Rhine-Rhône Canal;
9. 'tug': a vessel specially built to perform towing operations;
10. 'pusher': a vessel specially built to propel a pushed convoy;
11. 'barge': a dumb barge or tank barge;
12. 'tank barge': a vessel intended for the carriage of goods in fixed tanks and built to be towed, either having no motive power of its own or having only sufficient motive power to perform restricted manoeuvres;
13. 'dumb barge': a vessel, other than a tank barge, intended for the carriage of goods and built to be towed, either having no motive power of its own or having only sufficient motive power to perform restricted manoeuvres;
14. 'lighter': a tank lighter, cargo lighter or ship-borne lighter;
15. 'tank lighter': a vessel intended for the carriage of goods in fixed tanks, built or specially modified to be pushed, either having no motive power of its own or having only sufficient motive power to perform restricted manoeuvres when not part of a pushed convoy;
16. 'cargo lighter': a vessel, other than a tank lighter, intended for the carriage of goods and built or specially modified to be pushed, either having no motive power of its own or having only sufficient motive power to perform restricted manoeuvres when not part of a pushed convoy;
17. 'ship-borne lighter': a lighter built to be carried aboard sea-going ships and to navigate on inland waterways;
18. 'passenger vessel': a day trip or cabin vessel constructed and equipped to carry more than 12 passengers;
19. 'passenger sailing vessel': a passenger vessel built and fitted out also with a view to propulsion under sail;
20. 'day-trip vessel': a passenger vessel without overnight passenger cabins;
21. 'cabin vessel': a passenger vessel with overnight passenger cabins;
22. 'high-speed vessel': a motorised craft capable of reaching speeds over 40 km/h in relation to water;
23. 'floating equipment': a floating installation carrying working gear such as cranes, dredging equipment, pile drivers or elevators;

**▼B**

24. 'worksite craft': a vessel, appropriately built and equipped for use at worksites, such as a reclamation barge, hopper or pontoon barge, pontoon or stone-dumping vessel;
25. 'recreational craft': a vessel other than a passenger vessel, intended for sport or pleasure;
26. 'ship's boat': a boat for use in transport, rescue, salvage and work duties;
27. 'floating establishment': any floating installation not normally intended to be moved, such as a swimming bath, dock, jetty or boathouse;
28. 'floating objec': a raft or other structure, object or assembly capable of navigation, not being a vessel or floating equipment or establishment;

***Assemblies of craft***

29. 'convoy': a rigid or towed convoy of craft;
30. 'formation': the manner in which a convoy is assembled;
31. 'rigid convoy': a pushed convoy or side-by-side formation;
32. 'pushed convoy': a rigid assembly of craft of which at least one is positioned in front of the craft providing the power for propelling the convoy, known as the 'pusher(s)'; a convoy composed of a pusher and a pushed craft coupled so as to permit guided articulation is also considered as rigid;
33. 'side-by-side formation': an assembly of craft coupled rigidly side by side, none of which is positioned in front of the craft propelling the assembly;
34. 'towed convoy': an assembly of one or more craft, floating establishments or floating objects towed by one or more self-propelled craft forming part of the convoy;

***Particular areas on board***

35. 'main engine room': space where the propulsion engines are installed;
36. 'engine room': space where combustion engines are installed;
37. 'boiler room': a space housing a fuel-operated installation designed to produce steam or heat a thermal fluid;
38. 'enclosed superstructure': a watertight, rigid, continuous structure with rigid walls joined to the deck in a permanent and watertight manner;
39. 'wheelhouse': the area which houses all the control and monitoring instruments necessary for manoeuvring the vessel;
40. 'accommodation': a space intended for the use of persons normally living on board, including galleys, storage space for provisions, toilets and washing facilities, laundry facilities, ante-rooms and passageways, but not the wheelhouse;
41. 'passenger area': areas on board intended for passengers and enclosed areas such as lounges, offices, shops, hairdressing salons, drying rooms, laundries, saunas, toilets, washrooms, passageways, connecting passages and stairs not encapsulated by walls;
42. 'control centre': a wheelhouse, an area which contains an emergency electrical power plant or parts thereof or an area with a centre permanently occupied by on-board personnel or crew members, such as for fire alarm equipment, remote controls of doors or fire dampers;
43. 'stairwell': the well of an internal staircase or of a lift;
44. 'lounge': a room of an accommodation or a passenger area. On board passenger vessels, galleys are not regarded as lounges;
45. 'galley': a room with a stove or a similar cooking appliance;
46. 'store room': a room for the storage of flammable liquids or a room with an area of over 4 m<sup>2</sup> for storing supplies;
47. 'hold': part of the vessel, bounded fore and aft by bulkheads, opened or closed by means of hatch covers, intended for the carriage of goods, whether packaged or in bulk, or for housing tanks not forming part of the hull;

**▼B**

48. 'fixed tank': a tank joined to the vessel, the walls of the tank consisting either of the hull itself or of a casing separate from the hull;
49. 'working station': an area where members of the crew carry out their duties, including gangway, derrick and ship's boat;
50. 'passageway': an area intended for the normal movement of persons and goods;
51. 'safe area': the area which is externally bounded by a vertical surface running at a distance of  $1/5 B_{WL}$  parallel to the course of the hull in the line of maximum draught;
52. 'muster areas': areas of the vessel which are specially protected and in which passengers muster in the event of danger;
53. 'evacuation areas': part of muster areas of the vessel from which evacuation of persons can be carried out;

**Marine engineering terms**

54. 'plane of maximum draught': the water plane corresponding to the maximum draught at which the craft is authorised to navigate;
55. 'safety clearance': the distance between the plane of maximum draught and the parallel plane passing through the lowest point above which the craft is no longer deemed to be watertight;
56. 'residual safety clearance': the vertical clearance available, in the event of the vessel heeling over, between the water level and the lowest point of the immersed side, beyond which the vessel is no longer regarded as watertight;
57. 'freeboard (f)': the distance between the plane of maximum draught and a parallel plane passing through the lowest point of the gunwale or, in the absence of a gunwale, the lowest point of the upper edge of the ship's side;
58. 'residual freeboard': the vertical clearance available, in the event of the vessel heeling over, between the water level and the upper surface of the deck at the lowest point of the immersed side or, if there is no deck, the lowest point of the upper surface of the fixed ship's side;
59. 'margin line': an imaginary line drawn on the side plating not less than 10 cm below the bulkhead deck and not less than 10 cm below the lowest non-watertight point of the side plating. If there is no bulkhead deck, a line drawn not less than 10 cm below the lowest line up to which the outer plating is watertight shall be used;
60. 'water displacement ( $\nabla$ )': the immersed volume of the vessel, in  $m^3$ ;
61. 'displacement ( $\Delta$ )': the total weight of the vessel, inclusive of cargo, in t;
62. 'block coefficient ( $C_B$ )': the ratio between the water displacement and the product of length  $L_{WL}$ , breadth  $B_{WL}$  and draught  $T$ ;
63. 'lateral plane above water ( $A_V$ )': lateral plane of the vessel above the waterline in  $m^2$ ;
64. 'bulkhead deck': the deck to which the required watertight bulkheads are taken and from which the freeboard is measured;
65. 'bulkhead': a wall of a given height, usually vertical, partitioning the vessel and bounded by the bottom of the vessel, the plating or other bulkheads;
66. 'transverse bulkhead': a bulkhead extending from one side of the vessel to the other;
67. 'wall': a dividing surface, usually vertical;
68. 'partition wall': a non-watertight wall;
69. 'length (L)': the maximum length of the hull in m, excluding rudder and bowsprit;
70. 'length overall ( $L_{OA}$ )': the maximum length of the craft in m, including all fixed installations such as parts of the steering system or power plant, mechanical or similar devices;
71. 'length of waterline ( $L_{WL}$ )': the length of the hull in m, measured at the maximum draught;

**▼ B**

72. 'breadth (B)': the maximum breadth of the hull in m, measured to the outer edge of the shell plating (excluding paddle wheels, rub rails, and similar);
73. 'breadth overall (B<sub>OA</sub>)': the maximum breadth of the craft in m, including all fixed equipment such as paddle wheels, rub rails, mechanical devices and the like;
74. 'breadth of waterline (B<sub>WL</sub>)': breadth of the hull in m, measured from the outside of the side plating at the maximum draught line;
75. 'height (H)': the shortest vertical distance in m between the lowest point of the hull or the keel and the lowest point of the deck on the side of the vessel;
76. 'draught (T)': the vertical distance in m between the lowest point of the hull or the keel and the maximum draught line;
77. 'forward perpendicular': the vertical line at the forward point of the intersection of the hull with the maximum draught line;
78. 'clear width of side deck': the distance between the vertical line passing through the most prominent part of the hatch coaming on the side deck side and the vertical line passing through the inside edge of the slip guard (guard-rail, foot rail) on the outer side of the side deck;

***Steering system***

79. 'steering system': all the equipment necessary for steering the vessel, such as to ensure the manoeuvrability laid down in Chapter 5;
80. 'rudder': the rudder or rudders, with shaft, including the rudder quadrant and the components connecting with the steering apparatus;
81. 'steering apparatus': the part of the steering system which produces the movement of the rudder;
82. 'drive unit': the steering-apparatus drive, between the power source and the steering apparatus;
83. 'power source': the power supply to the steering drive unit and the steering apparatus produced by an on-board network, batteries or an internal combustion engine;
84. 'steering control': the component parts of and circuitry for the operation of a power-driven steering control;
85. 'steering apparatus drive unit': the control for the steering apparatus, its drive unit and its power source;
86. 'manual drive': a system whereby manual operation of the hand wheel moves the rudder by means of a mechanical transmission, without any additional power source;
87. 'manually-operated hydraulic drive': a manual control actuating a hydraulic transmission;
88. 'rate-of-turn regulator': equipment which automatically produces and maintains a given rate of turn of the vessel in accordance with preselected values;
89. 'wheelhouse designed for radar navigation by one person': a wheelhouse arranged in such a way that, during radar navigation, the vessel can be manoeuvred by one person;

***Properties of structural components and materials***

90. 'watertight': a structural component or device so fitted as to prevent any ingress of water;
91. 'spray-proof and weathertight': a structural component or device so fitted that in normal conditions it allows only a negligible quantity of water to penetrate;
92. 'gastight': a structural component or device so fitted as to prevent the ingress of gas and vapours;
93. 'non-combustible': a substance which neither burns nor produces flammable vapours in such quantities that they ignite spontaneously when heated to approximately 750°C;

**▼ B**

94. 'flame-retardant': material which does not readily catch fire, or whose surface at least restricts the spread of flames pursuant to the test procedure referred to in Article 15.11(1)(c);
95. 'fire-resistance': the property of structural components or devices as certified by the test procedure referred to in Article 15.11(1)(d);
96. 'Code for Fire Test Procedures': the International Code for the Application of Fire Test Procedures adopted under Resolution MSC.61(67) by the Maritime Safety Committee of the IMO;

**Other definitions**

97. 'approved classification society': a classification society which has been recognised in accordance with the criteria and the procedures of Annex VII;
98. 'radar installation': an electronic navigational aid for detecting and displaying the surroundings and traffic;
99. 'Inland ECDIS': a standardised system for displaying electronic navigational charts for inland waters and associated information, that displays selected information from proprietary electronic navigational charts for inland waters and optionally information from other sensors of the craft;
100. 'Inland ECDIS installation': an installation for displaying electronic navigational charts for inland waters that can be operated in two different modes: information mode and navigation mode;
101. 'information mode': use of Inland ECDIS for information purposes only without radar overlay;
102. 'navigation mode': use of Inland ECDIS with radar overlay for navigating a craft;
103. 'shipboard personnel': all employees on board a passenger vessel who are not members of the crew;
104. 'persons with reduced mobility': persons facing particular problems when using public transport, such as the elderly and the handicapped and persons with sensory disabilities, persons in wheelchairs, pregnant women and persons accompanying young children;
105. 'Community certificate': a certificate issued to an inland waterway vessel by the competent authority, signifying compliance with the technical requirements of this Directive.

*Article 1.02***(Left void)***Article 1.03***(Left void)***Article 1.04***(Left void)***Article 1.05***(Left void)****▼ M1***Article 1.06***Temporary requirements**

Temporary requirements designed to amend non-essential elements of this Directive, by supplementing it, may be adopted, in accordance with the regulatory procedure with scrutiny referred to in Article 19(4) of this Directive, where it is found urgently necessary, for the purposes of adaptation to technical progress of inland waterway transport, to allow derogations from the provisions of this Directive or to allow tests. The requirements shall be published and shall



**▼M1**

be valid for a maximum of three years. They shall enter into force at the same time and shall be annulled under the same conditions in all Member States.

**▼B***Article 1.07***Administrative instructions**

In order to make the implementation of this Directive easier and uniform, binding administrative instructions for the inspection may be adopted in accordance with the procedure referred to in Article 19(2) of this Directive.

## CHAPTER 2

**PROCEDURE***Article 2.01***Inspection bodies**

1. Inspection bodies shall be set up by the Member States.
2. Inspection bodies shall consist of a chairman and experts.  
At least the following shall form part of each body as experts:
  - (a) an official from the administration that is responsible for inland navigation;
  - (b) an expert on the design of inland waterway vessels and their engines;
  - (c) a nautical expert in possession of a navigation certificate.
3. The Chairman and the experts within each body shall be designated by the authorities in the State in which the body is set up. On taking up their duties, the Chairman and the experts shall submit a written declaration that they will perform them completely independently. No declaration shall be required from officials.
4. Inspection bodies may be assisted by specialist experts in accordance with the national provisions applying.

*Article 2.02***Request for an inspection**

1. The procedure for making a request for an inspection and establishing the place and time of that inspection fall within the powers of the authorities issuing the Community certificate. The competent authority shall determine which documents are to be submitted. The procedure shall take place in such a way as to ensure that the inspection may be conducted within a reasonable period following the lodging of the request.
2. The owner of a craft that is not subject to this Directive, or his representative, may request a Community certificate. His request shall be met if the vessel fulfils the requirements of this Directive.

*Article 2.03***Presentation of the craft for inspection**

1. The owner, or his representative, shall present the craft in an unladen, cleaned and equipped state. He shall provide any assistance needed for the inspection, such as providing an appropriate dinghy and staff, and uncovering any parts of the hull or fittings that are not directly accessible or visible.
2. The inspection body shall demand a dry inspection on the first occasion. That dry inspection may be dispensed with if a classification certificate or a certificate from an approved classification society to the effect that the construction meets its requirements can be produced or if a certificate is produced which shows that a competent authority has already carried out a dry inspection for other purposes. Where there is a periodical inspection or an inspection, as provided for in Article 15 of this Directive, the inspection body may require an inspection out of the water.

**▼B**

The inspection body shall conduct trial runs during an initial inspection of motor vessels or convoys or where major changes are made to the propulsion or steering equipment.

3. The inspection body may require further operational tests and other supporting documents. That provision shall also apply during the building of the craft.

*Article 2.04***(Left void)***Article 2.05***Provisional Community certificate**

1. The competent authority may issue a provisional Community certificate:
  - (a) to craft intended to travel to a certain place with the permission of the competent authority in order to obtain a Community certificate;
  - (b) to craft whose Community certificate has been temporarily withdrawn in one of the instances referred to in Article 2.07 or in Articles 12 and 16 of this Directive;
  - (c) to craft whose Community certificate is in preparation following a successful inspection;
  - (d) to craft where not all of the conditions required for obtaining a Community certificate as set out in Part I of Annex V have been met;
  - (e) to craft so damaged that their state no longer complies with the Community certificate;
  - (f) to floating installations or equipment where the authorities responsible for special transport operations make the authorisation to carry out a special transport operation, as provided for by the applicable navigational authority regulations of the Member States, subject to obtaining such a Community certificate;
  - (g) to craft deviating from the provisions of Part II, as provided for in Article 2.19(2).
2. The provisional Community certificate shall be drawn up using the model set out in Part III of Annex V where the navigability of the craft, floating establishment or floating object seems to have been adequately ensured.

This shall include the conditions considered necessary by the competent authority and shall be valid:

- (a) in the cases referred to in paragraph 1(a), (d) to (f), for a single specific trip to be made within a suitable period that shall not exceed one month;
- (b) in the cases referred to in paragraph 1(b) and (c), for an appropriate duration;
- (c) in the cases referred to in paragraph 1(g), for six months. The provisional Community certificate may be extended for six months at a time until the Committee has taken a decision.

*Article 2.06***Validity of the Community certificate**

1. The validity period of Community certificates issued to newly built vessels in accordance with the provisions of this Directive shall be determined by the competent authority up to a maximum of:
  - (a) five years in the case of passenger vessels;
  - (b) 10 years in the case of all other craft.

The period of validity shall be entered on the Community certificate.

2. In the case of vessels already in operation before the inspection, the competent authority shall set the period of validity of the Community certificate case by case, in the light of the results of the inspection. However, the validity may not exceed the periods specified in paragraph 1.

**▼B***Article 2.07***Particulars in and amendments to the Community certificate**

1. The owner of a craft, or his representative, shall bring to the notice of the competent authority any change in the name or ownership of a craft, any remeasurement, and any change in the ►M3 European Vessel Identification Number ◀, registration or home port, and shall send the Community certificate to that authority for amendment.
2. Any competent authority may add any information or change to the Community certificate.
3. Where a competent authority adds any alteration or information to a Community certificate it shall inform the competent authority which issued the Community certificate thereof.

*Article 2.08***(Left void)***Article 2.09***Periodical inspection**

1. Craft shall be subjected to a periodical inspection before expiry of their Community certificate.
2. Following a justified request by the owner or his representative, the competent authority may, by way of an exception, and without any further inspections, grant an extension of the validity of the Community certificate for not more than six months. That extension shall be granted in writing and shall be kept on board the craft.
3. The competent authority shall again lay down the period of validity of the Community certificate in accordance with the results of that inspection.

The period of validity shall be entered on the Community certificate and brought to the attention of the authority having issued that Community certificate.

4. If, rather than have its period of validity extended, a Community certificate is replaced by a new version, the earlier Community certificate shall be returned to the competent authority which issued it.

*Article 2.10***Voluntary inspection**

The owner of a craft, or his representative, may voluntarily request an inspection at any time.

That request for an inspection shall be acted upon.

*Article 2.11***(Left void)***Article 2.12***(Left void)***Article 2.13***(Left void)***Article 2.14***(Left void)**

**▼ B***Article 2.15***Expenses**

The owner of a craft, or his representative, shall bear all of the costs arising from the inspection of the vessel and the issue of the Community certificate in accordance with a special set of charges drawn up by each of the Member States.

*Article 2.16***Information**

The competent authority may allow persons demonstrating a well-founded interest to be informed of the contents of a Community certificate and may issue those persons with extracts or copies of the Community certificates certified as true and designated as such.

*Article 2.17***Register of Community certificates**

1. Competent authorities shall assign an order number to the Community certificates they issue. They shall keep a register in accordance with the model set out in Annex VI of all the Community certificates they issue.
2. Competent authorities shall keep the original, or a copy of all the Community certificates they have issued, and shall enter on these any information and alterations, together with any Community certificate cancellations and replacements. ► **M3** They shall update the register mentioned in paragraph 1 accordingly. ◀

**▼ M3**

3. In order to perform administrative measures for maintaining safety and ease of navigation and for implementation of Articles 2.02 to 2.15 as well as Articles 8, 10, 11, 12, 15, 16 and 17 of this Directive read only access to the register in accordance with the model set out in Annex VI will be granted to competent authorities of other Member States, Contracting States of the Mannheim Convention and, as far as an equivalent level of privacy is guaranteed, to third countries on the basis of administrative agreements.

*Article 2.18***Unique European Vessel Identification Number**

1. The unique European Vessel Identification Number (ENI), in the following referred to as European Vessel Identification Number, consists of eight Arabic numerals according to Appendix III.
2. The competent authority having issued a Community certificate shall enter on that Community certificate the European Vessel Identification Number. Unless the craft possesses a European Vessel Identification Number at the time of issue of the Community Certificate it shall be assigned to that craft by the competent authority of the Member State in which the craft has been registered or has its home port.  
  
As far as craft from countries where an assignation of a European Vessel Identification Number is not possible are concerned the European Vessel Identification Number to be entered on the Community certificate shall be assigned by the competent authority issuing that Community certificate.
3. Only one single European Vessel Identification Number can be assigned to one craft. The European Vessel Identification Number is issued only once and remains unchanged throughout the whole lifetime of the craft.
4. The owner of a craft, or his representative, shall apply to the competent authority for assignment of the European Vessel Identification Number. The owner or his representative shall also be responsible for having the European Vessel Identification Number which is entered in the Community certificate affixed to the craft.

5. Each Member State shall notify the Commission of the competent authorities responsible for assigning European Vessel Identification Numbers. The Commission shall keep a register of those competent authorities and of competent authorities notified by third countries, and shall make the

**▼M3**

register available to the Member States. On request this register shall also be made available to competent authorities of third countries.

6. Each competent authority in accordance with paragraph 5 shall make all necessary arrangements in order to inform all other competent authorities listed in the register kept in accordance with paragraph 5 of each European Vessel Identification Number it assigns as well as of data for the identification of the vessel set out in Appendix IV. These data may be made available to competent authorities of other Member States, Contracting States of the Mannheim Convention and, as far as an equivalent level of privacy is guaranteed, to third countries on the basis of administrative agreements in order to perform administrative measures for maintaining safety and ease of navigation and for implementation of Articles 2.02 to 2.15 and Article 2.18(3) as well as Articles 8, 10, 11, 12, 15, 16 and 17 of this Directive.

**▼B***Article 2.19***Equivalences and derogations**

1. Where the provisions of Part II require the use, or presence, on board a craft of certain materials, installations or items of equipment, or the adoption of certain design aspects or certain arrangements, the competent authority may permit the use, or presence, on board the said craft of other materials, installations or items of equipment, or the adoption of other design features or other arrangements where, in accordance with the procedure referred to in Article 19(2) of this Directive, these are recognised to be equivalent.
2. If, in accordance with the procedure referred to in Article 19(2) of this Directive, the Committee reaches no decision on equivalence, as provided for in paragraph 1, the competent authority may issue a provisional Community certificate.

In accordance with the procedure referred to in Article 19(2) of this Directive, the competent authorities shall report to the Committee within one month of issue of the provisional Community certificate in accordance with Article 2.05(1)(g), indicating the name and ►M3 European Vessel Identification Number ◀ of the craft, the nature of the derogation and the State in which the craft is registered or has its home port.

3. In accordance with the procedure referred to in Article 19(2) of this Directive, the competent authority may, on the basis of a recommendation by the Committee, issue a Community certificate for trial purposes and for a limited period to a specific craft incorporating new technical specifications that derogate from the requirements of Part II, provided those specifications offer equivalent safety.
4. The equivalences and derogations referred to in paragraphs 1 and 3 shall be entered in the Community certificate. The Commission shall be informed thereof.

## PART II

## CHAPTER 3

**SHIPBUILDING REQUIREMENTS***Article 3.01***Basic requirements**

Vessels shall be built in accordance with good shipbuilding practice.

*Article 3.02***Strength and stability**

1. The hull shall be sufficiently strong to withstand all of the stresses to which it is normally subjected.
  - (a) In the case of newly built vessels or major conversions affecting vessel strength, adequate strength shall be demonstrated by presenting design

**▼B**

calculation proof. That proof is not required where a classification certificate or a declaration from an approved classification society is submitted.

- (b) Where there is an inspection as referred to in Article 2.09 the minimum thicknesses of the bottom, bilge and side plates shall be checked in accordance with the following conditions:

For vessels made from steel minimum thickness  $t_{\min}$  is given by the highest of the values resulting from the following formulae:

1. for vessels that are longer than 40 m:  $t_{\min} = f \cdot b \cdot c (2,3 + 0,04 L)$  (mm);

for vessels not more than 40 m in length:  $t_{\min} = f \cdot b \cdot c (1,5 + 0,06 L)$  (mm), however, not less than 3.00 mm

2.  $t_{\min} = 0,005 \cdot a \sqrt{T}$  [mm]

where:

a = frame spacing (mm);

f = frame spacing factor:

$$f = 1 \text{ for } a \leq 500 \text{ mm}$$

$$f = 1 + 0,0013 (a - 500) \text{ for } a > 500 \text{ mm}$$

b = factor for bottom, side or bilge plates

$$b = 1,0 \text{ for bottom plates and side plates}$$

$$b = 1,25 \text{ for bilge plates.}$$

$f = 1$  may be taken for the frame spacing when calculating the minimum thickness of the side plates. However, the minimum thickness of the bilge plates may in no case be less than that of the bottom plates and side plates.

c = factor for the type of structure:

c = 0,95 for vessels with double bottom and wing void, where the partition between wing void and hold is located vertically in line with the coaming

c = 1,0 for all other types of structure.

- (c) In longitudinally framed vessels with double bottom and wing voids, the minimum value calculated for the plate thickness in accordance with the formulae in paragraph (b) may be reduced to a calculated value certified by an approved classification society for sufficient hull strength (longitudinal, lateral and local strength).

Plates shall be renewed if bottom, bilge or side plates are below the permissible value laid down in this way.

The minimum values calculated in accordance with the method are limit values taking account of normal, uniform wear, and provided that ship-building steel is used and that the internal structural components such as frames, frame floor, main longitudinal and transverse structural members are in a good state and that the hull shows no indication of any overloading of the longitudinal strength.

As soon as these values are no longer achieved, the plates in question shall be repaired or replaced. However, lesser thicknesses, of not more than 10 % reduction from calculated values, are acceptable locally for small areas.

2. Where a material other than steel is used for the construction of the hull, it shall be proved by calculation that the hull strength (longitudinal, lateral and local strength) equals at least the strength that would result from the use of steel under the assumption of minimum thickness in accordance with paragraph 1. If a certificate of class or a declaration issued by a recognised classification society is presented, a proof by calculation may be dispensed with.
3. The stability of vessels shall correspond to their intended use.



*Article 3.03*

**Hull**

1. Bulkheads rising up to the deck or, where there is no deck, up to the gunwale, shall be installed at the following points:
  - (a) A collision bulkhead at a suitable distance from the bow in such a way that the buoyancy of the laden vessel is ensured, with a residual safety clearance of 100 mm if water enters the watertight compartment ahead of the collision bulkhead.
 

As a general rule, the requirement referred to in paragraph 1 shall be considered to have been met if the collision bulkhead has been installed at a distance of between  $0,04 L$  and  $0,04 L + 2$  m measured from the forward perpendicular in the plane of maximum draught.

If this distance exceeds  $0,04 L + 2$  m, the requirement set out in paragraph 1 shall be proved by calculation.

The distance may be reduced to  $0,03 L$ . In that case the requirement referred to in paragraph 1 shall be proved by calculation on the assumption that the compartment ahead of the collision bulkhead and those adjacent have all been filled with water.
  - (b) An aft-peak bulkhead at a suitable distance from the stern where the vessel length  $L$  exceeds 25 m.
2. No accommodation or installations needed for vessel safety or operation may be located ahead of the plane of the collision bulkhead. This requirement shall not apply to anchor gear.
3. The accommodation, engine rooms and boiler rooms, and the workspaces forming part of these shall be separated from the holds by watertight transverse bulkheads that extend up to the deck.
4. The accommodation shall be separated from engine rooms, boiler rooms and holds in a gastight manner and shall be directly accessible from the deck. If no such access has been provided an emergency exit shall also lead directly to the deck.
5. The bulkheads specified in paragraphs 1 and 3 and the separation of areas specified in paragraph 4 shall not contain any openings.

However, doors in the aft-peak bulkhead and penetrations, in particular for shafts and pipework, shall be permitted where they are so designed that the effectiveness of those bulkheads and of the separation of areas is not impaired. Doors in the aft-peak bulkhead shall be permitted only if it can be determined by remote monitoring in the wheelhouse whether they are open or closed and shall bear the following readily legible instruction on both sides:

‘Door to be closed immediately after use’.

6. The water inlets and discharges, and the pipework connected to these, shall be such that no unintentional ingress of water into the vessel is possible.
7. The foresections of vessels shall be built in such a way that the anchors neither wholly nor partly protrude beyond the side plating.

*Article 3.04*

**Engine and boiler rooms, bunkers**

1. Engine or boiler rooms shall be arranged in such a way that the equipment therein can be operated, serviced and maintained easily and safely.
2. The liquid-fuel or lubricant bunkers and passenger areas and accommodation may not have any common surfaces which are under the static pressure of the liquid when in normal service.
3. Engine room, boiler room and bunker bulkheads, ceilings and doors shall be made of steel or another equivalent non-combustible material.

Insulation material used in engine rooms shall be protected against the intrusion of fuel and fuel vapours.

All openings in walls, ceilings, and doors of engine rooms, boiler rooms, and bunker rooms shall be such that they can be closed from outside the room.

**▼B**

The locking devices shall be made from steel or an equivalently non-combustible material.

4. Engine and boiler rooms and other premises in which flammable or toxic gases are likely to escape shall be capable of being adequately ventilated.
5. Companionways and ladders providing access to engine and boiler rooms and bunkers shall be firmly attached and be made of steel or another shock-resistant and non-combustible material.
6. Engine and boiler rooms shall have two exits of which one may be an emergency exit.

The second exit may be dispensed with if:

- (a) the total floor area (average length × average width at the level of the floor plating) of the engine or boiler room does not exceed 35 m<sup>2</sup>; and
  - (b) the path between each point where servicing or maintenance operations are to be carried out and the exit, or foot of the companionway near the exit providing access to the outside, is not longer than 5 m; and
  - (c) a fire extinguisher is located at the servicing point that is furthest removed from the exit door and also, by way of derogation from Article 10.03(1)(e), where the installed power of the engines does not exceed 100 kW.
7. The maximum permissible sound pressure level in the engine rooms shall be 110 dB(A). The measuring points shall be selected as a function of the maintenance work needed during normal operation of the plant located therein.

## CHAPTER 4

**SAFETY CLEARANCE, FREEBOARD AND DRAUGHT MARKS***Article 4.01***Safety clearance**

1. The safety clearance shall be at least 300 mm.
2. The safety clearance in the case of vessels whose openings cannot be closed by spray-proof and weathertight devices, and for vessels sailing with their holds uncovered, shall be increased in such a way that each of those openings shall be at least 500 mm from the plane of maximum draught.

*Article 4.02***Freeboard**

1. The freeboard of vessels with a continuous deck, without sheer and superstructures, shall be 150 mm.
2. The freeboard of vessels with sheer and superstructures shall be calculated using the following formula:

$$F = 150 \cdot (1 - \alpha) - \frac{\beta_v \cdot Se_v + \beta_a \cdot Se_a}{15} \text{ [mm]}$$

where:

- a is a correction coefficient that takes account of all of the superstructures involved;
- $\beta_v$  is a coefficient for correcting the effect of the forward sheer resulting from the presence of superstructures in the forward quarter of length L of the vessel;
- $\beta_a$  is a coefficient correcting the effect of the aft sheer resulting from the presence of superstructures in the aft quarter of length L of the vessel;
- $Se_v$  is the effective forward sheer in mm;
- $Se_a$  is the effective aft sheer in mm.



**▼ B**

3. The coefficient  $\alpha$  is calculated using the following formula:

$$\alpha = \frac{\sum le_a + \sum le_m + \sum le_v}{L}$$

where:

$le_m$  is the effective length, in m, of a superstructure located in the median part corresponding to half of length  $L$  of the vessel;

$le_v$  is the effective length, in m, of a superstructure in the forward quarter of vessel length  $L$ ;

$le_a$  is the effective length, in m, of a superstructure in the aft quarter of vessel length  $L$ .

The effective length of a superstructure is calculated using the following formulae:

$$le_m = 1 \left( 2,5 \cdot \frac{b}{B} - 1,5 \right) \cdot \frac{h}{0,36} \text{ [m]}$$

$$le_v, le_a = 1 \left( 2,5 \cdot \frac{b}{B_1} - 1,5 \right) \cdot \frac{h}{0,36} \text{ [m]}$$

where:

$l$  is the effective length, in m, of the superstructure involved;

$b$  is the width, in m, of the superstructure involved;

$B_1$  is the width of the vessel, in m, measured on the outside of the vertical sideplates at deck level halfway along the superstructure involved;

$h$  is the height, in m, of the superstructure involved. However, in the case of hatches,  $h$  is obtained by reducing the height of the coamings by half of the safety distance according to Article 4.01(1) and (2). In no case will a value exceeding 0,36 m be taken for  $h$ .

If  $\frac{b}{B}$  or  $\frac{b}{B_1}$  is less than 0,6 the effective length  $le$  of the superstructure will be zero.

4. Coefficients  $\beta_v$  and  $\beta_a$  are calculated using the following formulae:

$$\beta_v = 1 - \frac{3 \cdot le_v}{L}$$

$$\beta_a = 1 - \frac{3 \cdot le_a}{L}$$

5. The effective aft/forward sheers  $Se_v/Se_a$  are calculated using the following formulae:

$$Se_v = S_v \cdot p$$

$$Se_a = S_a \cdot p$$

where:

$S_v$  is the actual forward shear, in mm; however  $S_v$  shall not be taken to be more than 1 000 mm;

$S_a$  is the actual aft shear, in mm; however  $S_a$  may not be taken to be more than 500 mm;

$p$  is a coefficient calculated using the following formula:

$$p = 4 \cdot \frac{x}{L}$$

$x$  is the abscissa, measured from the extremity of the point where the shear is 0,25  $S_v$  or 0,25  $S_a$  (see figure).

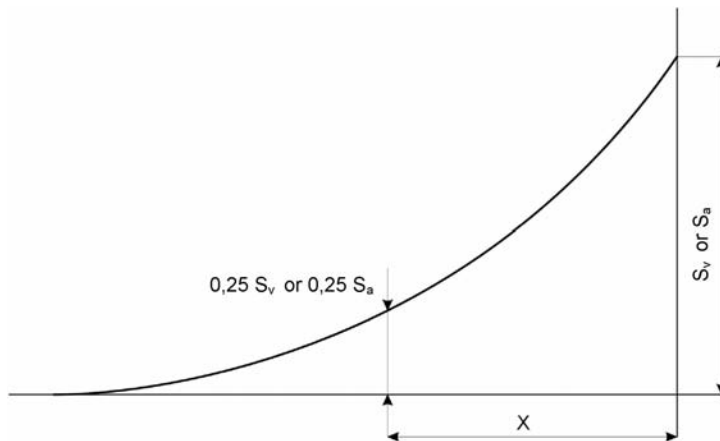
**▼B**

However, coefficient  $p$  will not be taken to be more than 1.

6. If  $\beta_a \cdot S_{e_a}$  is greater than  $\beta_v \cdot S_{e_v}$ , the value  $\beta_v \cdot S_{e_v}$  will be taken as being the value for  $\beta_a \cdot S_{e_a}$ .

*Article 4.03***Minimum freeboard**

In view of the reductions referred to in Article 4.02 the minimum freeboard shall be not less than 0 mm.

*Article 4.04***Draught marks**

1. The plane of maximum draught shall be determined in such a way that the specifications concerning minimum freeboard and minimum safety clearance are both met. However, for safety reasons, the inspection body may lay down a greater value for the safety clearance or freeboard. The plane of maximum draught shall be determined at least for Zone 3.
2. The plane of maximum draught shall be indicated by means of highly visible, indelible draught marks.
3. The draught marks for Zone 3 shall consist of a rectangle 300 mm long and 40 mm deep, the base of which is horizontal and coincides with the plane of the maximum authorised draught. Any differing draught marks shall include such a rectangle.
4. Vessels shall have at least three pairs of draught marks, of which one pair shall be centrally located and the two others located, respectively, at a distance from the bow and stern that is equal to roughly one-sixth of the length.

However,

- (a) where a vessel is less than 40 m in length it will suffice to affix two pairs of marks at a distance from the bow and stern, respectively, that is equal to a quarter of the length;
  - (b) where vessels are not intended for the carriage of goods, a pair of marks located roughly halfway along the vessel will suffice.
5. Marks or indications which cease to be valid following a further inspection shall be deleted or marked as being no longer valid under the supervision of the inspection body. If a draught mark should disappear, it may only be replaced under the supervision of an inspection body.
  6. Where a vessel has been measured in implementation of the 1966 Convention on the Measurement of Inland Navigation Vessels and the plane of the measurement marks meets the requirements of this Directive, those measurement marks shall take the place of the draught marks; this shall be mentioned in the Community certificate.
  7. For vessels operating on zones of inland waterways other than Zone 3 (Zones 1, 2 or 4) the bow and stern pairs of draught marks provided for in paragraph 4 shall be supplemented by adding a vertical line to which one or, in the case



**▼B**

3. The two stern measurement scales affixed pursuant to the Convention referred to in Article 4.04 (6), may replace the draught scales, provided that they include a graduation that meets the requirements plus, where appropriate, figures indicating the draught.

## CHAPTER 5

**MANOEUVRABILITY***Article 5.01***General**

Vessels and convoys shall display adequate navigability and manoeuvrability.

Unpowered vessels intended to be towed shall meet the specific requirements laid down by the inspection body.

Powered vessels and convoys shall meet the requirements set out in Articles 5.02 to 5.10.

*Article 5.02***Navigation tests**

1. Navigability and manoeuvrability shall be checked by means of navigation tests. Compliance with the requirements of Articles 5.06 to 5.10 shall, in particular, be examined.
2. The inspection body may dispense with all or part of the tests where compliance with the navigability and manoeuvrability requirements is proven in another manner.

*Article 5.03***Test area**

1. The navigation tests referred to in Article 5.02 shall be carried out on areas of inland waterways that have been designated by the competent authorities.
2. Those test areas shall be situated on a stretch of flowing or standing water that is if possible straight, at least 2 km long and sufficiently wide and is equipped with highly-distinctive marks for determining the position of the vessel.
3. It shall be possible for the inspection body to plot the hydrological data such as depth of water, width of navigable channel and average speed of the current in the navigation area as a function of the various water levels.

*Article 5.04***Degree of loading of vessels and convoys during navigation tests**

During navigation tests, vessels and convoys intended to carry goods shall be loaded to at least 70 % of their tonnage and loading, distributed in such a way as to ensure a horizontal attitude as far as possible. If the tests are carried out with a lesser load the approval for downstream navigation shall be restricted to that loading.

*Article 5.05***Use of on-board facilities for navigation test**

1. During the navigation test, all of the equipment referred to in items 34 and 52 of the Community certificate which may be actuated from the wheelhouse may be used, apart from anchors.
2. However, during the test involving turning into the current referred to in Article 5.10, bow anchors may be used.

**▼B***Article 5.06***Prescribed (forward) speed**

1. Vessels and convoys shall achieve a speed in relation to the water of at least 13 km/h. That condition is not mandatory where pusher tugs are operating solo.
2. The inspection body may grant exemptions to vessels and convoys operating solely in estuaries and ports.
3. The inspection body shall check if the unladen vessel is capable of exceeding a speed of 40 km/h in relation to water. If this can be confirmed, the following entry shall be made in item 52 of the Community certificate:

‘The vessel is capable of exceeding a speed of 40 km/h in relation to water.’

*Article 5.07***Stopping capacity**

1. Vessels and convoys shall be able to stop facing downstream in good time while remaining adequately manoeuvrable.
2. Where vessels and convoys are not longer than 86 m and not wider than 22.90 m the stopping capacity mentioned above may be replaced by turning capacity.
3. The stopping capacity shall be proved by means of stopping manoeuvres carried out within a test area as referred to in Article 5.03 and the turning capacity by turning manoeuvres in accordance with Article 5.10.

*Article 5.08***Capacity for going astern**

Where the stopping manoeuvre required by Article 5.07 is carried out in standing water it shall be followed by a navigation test while going astern.

*Article 5.09***Capacity for taking evasive action**

Vessels and convoys shall be able to take evasive action in good time. That capacity shall be proven by means of evasive manoeuvres carried out within a test area as referred to in Article 5.03.

*Article 5.10***Turning capacity**

Vessels and convoys not exceeding 86 m in length or 22,90 m in breadth shall be able to turn in good time.

That turning capacity may be replaced by the stopping capacity referred to in Article 5.07.

The turning capacity shall be proven by means of turning manoeuvres against the current.

## CHAPTER 6

**STEERING SYSTEM***Article 6.01***General requirements**

1. Vessels shall be fitted with a reliable steering system which provides at least the manoeuvrability required by Chapter 5.
2. Powered steering systems shall be designed in such a way that the rudder cannot change position unintentionally.

**▼ B**

3. The steering system as a whole shall be designed for permanent lists of up to 15° and ambient temperatures from — 20 °C to + 50 °C.
4. The component parts of the steering system shall be rugged enough to always be able to withstand the stresses to which they may be subjected during normal operation. No external forces applied to the rudder shall impair the operating capacity of the steering apparatus and its drive unit.
5. The steering system shall incorporate a powered drive unit if so required by the forces needed to actuate the rudder.
6. A steering apparatus with powered drive unit shall be protected against overloads by means of a system that restricts the torque applied by the drive unit.
7. The penetrations for the rudder stocks shall be so designed as to prevent the spread of water-polluting lubricants.

*Article 6.02***Steering apparatus drive unit****▼ M3**

1. If the steering apparatus has a powered drive unit, a second independent drive unit or an additional manual drive shall be present. In case of failure or malfunction of the drive unit of the rudder system, the second independent drive unit or the manual drive has to be in operation within 5 seconds.

**▼ B**

2. If the second drive unit or manual drive is not placed in service automatically, it shall be possible to do so immediately by means of a single operation by the helmsman that is both simple and quick.
3. The second drive unit or manual drive shall ensure the manoeuvrability required by Chapter 5 as well.

**▼ M3***Article 6.03***Hydraulic steering apparatus drive unit**

1. No other power consumers may be connected to the hydraulic steering apparatus drive unit.
2. Hydraulic tanks shall be equipped with a warning system that monitors a dropping of the oil level below the lowest content level needed for safe operation.
3. The dimensions, design and arrangement of the pipework shall as far as possible exclude mechanical damage or damage resulting from fire.
4. Hydraulic hoses are:
  - (a) only permissible, if vibration absorption or freedom of movement of components makes their use inevitable;
  - (b) to be designed for at least the maximum service pressure;
  - (c) to be renewed at the latest every eight years.
5. Hydraulic cylinders, hydraulic pumps and hydraulic motors as well as electric motors shall be examined at the latest every eight years by a specialised firm and repaired if required.

**▼ B***Article 6.04***Power source**

1. Steering systems fitted with two powered drive units shall have at least two power sources.
2. If the second power source for the powered steering apparatus is not constantly available while the vessel is under way, a buffer device carrying adequate capacity shall provide back-up during the period needed for start-up.
3. In the case of electrical power sources, no other power consumers may be supplied by the main power source for the steering system.

**▼ B***Article 6.05***Manual drive**

1. The manual wheel shall not be driven by a powered drive unit.
2. Regardless of rudder position, a kick-back of the wheel shall be prevented when the manual drive is engaged automatically.

*Article 6.06***Rudder-propeller, water-jet, cycloidal-propeller and bow-thruster systems**

1. Where the thrust vectoring of rudder-propeller, water-jet, cycloidal-propeller or bow-thruster installations is remotely actuated by electric, hydraulic or pneumatic means, there shall be two actuation systems, each independent of the other, between the wheelhouse and the propeller- or thruster-installation which, *mutatis mutandis*, meet the requirements of Articles 6.01 to 6.05.

Such systems are not subject to this paragraph if they are not needed in order to achieve the manoeuvrability required by Chapter 5 or if they are only needed for the stopping test.

2. Where there are two or more rudder-propeller, water-jet or cycloidal-propeller installations that are independent of each other the second actuation system is not necessary if the vessel retains the manoeuvrability required by Chapter 5 if one of the systems fails.

*Article 6.07***Indicators and monitoring devices**

1. The rudder position shall be clearly displayed at the steering position. If the rudder-position indicator is electric it shall have its own power supply.
2. ► **M3** An optical and acoustic alarm shall be present at the steering position to signal the following: ◀

**▼ M3**

- (a) oil level of the hydraulic tanks falling under the lowest content level in accordance with Article 6.03(2) and decrease of service pressure of the hydraulic system;

**▼ B**

- (b) failure of the electrical supply for the steering control;
- (c) failure of the electrical supply for the drive units;
- (d) failure of the rate-of-turn regulator;
- (e) failure of the required buffer devices.

*Article 6.08***Rate-of-turn regulators**

1. Rate-of-turn regulators and their components shall meet the requirements laid down in Article 9.20.
2. The proper functioning of the rate-of-turn regulator shall be displayed at the steering position by means of a green indicating light.

Any lack of or unacceptable variations in the supply voltage and an unacceptable decrease in the speed of rotation of the gyroscope shall be monitored.

3. Where, in addition to the rate-of-turn regulator, there are other steering systems, it shall be possible to clearly distinguish at the steering position which of these systems has been activated. It shall be possible to shift from one system to another immediately. The rate-of-turn regulator shall not have any influence on these other steering systems.
4. The electricity supply to the rate-of-turn regulator shall be independent of other power consumers.

**▼B**

5. The gyroscopes, detectors and rate-of-turn indicators used in the rate-of-turn regulators shall meet the minimum requirements of the minimum specifications and test conditions concerning rate-of-turn displays for inland waterways, as laid down in Annex IX.

**▼M3***Article 6.09***Acceptance and periodical inspections**

1. The correct installation of the steering system shall be inspected by an inspection body. For this purpose the inspection body can require the following documents:
  - (a) description of the steering system;
  - (b) drawings of and information on the steering apparatus drive units and the steering control;
  - (c) information concerning the steering apparatus;
  - (d) electrical wiring diagram;
  - (e) description of the rate-of-turn regulator;
  - (f) operating and maintenance instructions for the steering system.
2. Operation of the entire steering system shall be checked by means of a navigation test. If a rate-of-turn regulator is installed it shall be checked that a predetermined course can be reliably maintained and that bends can be negotiated safely.
3. Power-driven steering systems shall be inspected by an expert:
  - (a) before being put into service;
  - (b) after a failure;
  - (c) after any modification or repair;
  - (d) regularly at least every three years.
4. The inspection has to cover at least:
  - (a) a check of conformity with the approved drawings and at periodical inspections whether alterations in the steering system were made;
  - (b) a functional test of the steering system for all operational possibilities;
  - (c) a visual check and a tightness check of the hydraulic components, in particular valves, pipelines, hydraulic hoses, hydraulic cylinders, hydraulic pumps, and hydraulic strainers;
  - (d) a visual check of the electrical components, in particular relays, electric motors and safety devices;
  - (e) a check of the optical and acoustic control devices.
5. An inspection certificate, signed by the inspector, shall be issued, showing the date of inspection.

**▼B**

## CHAPTER 7

**WHEELHOUSE***Article 7.01***General**

1. Wheelhouses shall be arranged in such a way that the helmsman may at all times perform his task while the vessel is under way.
2. Under normal operating conditions, sound pressure generated by the vessel and measured at the level of the helmsman's head at the steering position shall not exceed 70 dB(A).
3. Where a wheelhouse has been designed for radar navigation by one person, the helmsman shall be able to accomplish his task while seated and all of the display or monitoring instruments and all of the controls needed for operation



**▼B**

of the vessel shall be arranged in such a way that the helmsman may use them comfortably while the vessel is under way without leaving his position or losing sight of the radar screen.

*Article 7.02***Unobstructed view**

1. There shall be an adequately unobstructed view in all directions from the steering position.
2. ►**M3** The area of obstructed vision for the helmsman ahead of the vessel in an unladen state with half of its supplies but without ballast shall not exceed two vessel lengths or 250 m whichever is less, to the surface of the water. ◀

Optical and electronic means for reducing the area of obstructed vision may not be taken into account during the inspection.

To further reduce any area of obstructed vision, only suitable electronic devices shall be used.

3. The helmsman's field of unobstructed vision at his normal position shall be at least 240° of the horizon and at least 140° within the forward semicircle.

No window frame, post or superstructure shall lie within the helmsman's usual axis of vision.

Even in the case where a field of unobstructed vision of at least 240° of the horizon is provided, the inspection body may require other measures and in particular the installation of suitable auxiliary optical or electronic devices if no sufficiently unobstructed view is provided towards the rear.

The height of the lower edge of the side windows shall be kept as low as possible and the height of the upper edge of the side and rear windows shall be kept as high as possible.

In determining whether the requirements in this Article for visibility from the wheelhouse are met, the helmsman shall be assumed to have a height of eye of 1 650 mm above the deck at the steering position.

4. The upper edge of the forward facing windows of the wheelhouse shall be high enough to allow a person at the steering position with height of eye of 1 800 mm a clear forward view to at least 10 degrees above the horizontal at eye-level height.
5. There shall in all weathers be suitable means of providing a clear view through the windscreen.
6. The glazing used in wheelhouses shall be made of safety glass and have a light transmission of at least 75 %.

**▼M3**

To avoid reflections, the bridge front windows shall be glare-free or fitted so as to exclude reflections effectively. This requirement shall be deemed to be fulfilled when the windows are inclined from the vertical plane, so as to form an outward angle of not less than 10° and not more than 25°.

**▼B***Article 7.03***General requirements concerning control, indicating and monitoring equipment**

1. Control equipment needed to operate the vessel shall be brought into its operating position easily. That position shall be unambiguously clear.
2. Monitoring instruments shall be easily legible. It shall be possible to adjust their lighting steplessly down to their extinction. Light sources shall be neither intrusive nor impair the legibility of the monitoring instruments.
3. There shall be a system for testing the warning and indicating lights.
4. It shall be possible to clearly establish whether a system is in operation. If its functioning is indicated by means of an indicating light, this shall be green.
5. Any malfunctioning or failure of systems that require monitoring shall be indicated by means of red warning lights.

**▼B**

6. An audible warning shall sound at the same time that a red warning light lights up. Audible warnings may be given by a single, collective signal. The sound pressure level of that signal shall exceed the maximum sound pressure level of the ambient noise at the steering position by at least 3 dB(A).
7. The audible warning shall be capable of being switched off after a malfunction or failure has been acknowledged. Such shutdown shall not prevent the alarm signal from being triggered by other malfunctions. The red warning lights shall only go out when the malfunction has been corrected.
8. The monitoring and indicating devices shall be automatically switched to an alternative power supply if their own power supply fails.

*Article 7.04***Specific requirements concerning control, indicating and monitoring equipment of main engines and steering system**

1. It shall be possible to control and monitor the main engines and steering systems from the steering position. Main engines fitted with a clutch which can be actuated from the steering position, or driving a controllable pitch propeller which can be controlled from the steering position, need only to be capable of being started up and shut down from the engine room.
2. The control for each main engine shall take the form of a single lever which prescribes an arc within a vertical plane that is approximately parallel to the longitudinal axis of the vessel. Movement of that lever towards the bow of the vessel shall cause forward motion, whereas movement of the lever towards the stern shall cause the vessel to go astern. Clutch engagement and reversal of the direction of motion shall take place about the neutral position of that lever. The lever shall catch in the neutral position.
3. The direction of the propulsion thrust imparted to the vessel and the rotational speed of the propeller or main engines shall be displayed inside wheelhouses that have been designed for radar navigation by one person.
4. The indicating and monitoring devices required by Article 6.07(2), Article 8.03(2), and Article 8.05 (13), shall be located at the steering position.
5. Vessels with wheelhouses designed for radar navigation by one person shall be steered by means of a lever. It shall be possible to move that lever easily by hand. The position of the lever in relation to the longitudinal axis of the vessel shall correspond precisely to the position of the rudder blades. It shall be possible to release hold of the lever in any given position without that of the rudder blades changing. The neutral position of the lever shall be clearly perceptible.
6. Where the vessel is fitted with bow rudders or special rudders, particularly for going astern, these shall be actuated in wheelhouses designed for radar navigation by one person by special levers which, *mutatis mutandis*, meet the requirements set out in paragraph 5.

That requirement shall also apply where, in convoys, the steering system fitted to craft other than those powering the convoy is used.

7. Where rate-of-turn regulators are used, it shall be possible for the rate-of-turn control to be released in any given position without altering the speed selected.

The control shall turn through a wide enough arc to guarantee adequately precise positioning. The neutral position shall be clearly perceptible from the other positions. The scale illumination shall be steplessly variable.

8. The remote-control equipment for the entire steering system shall be installed in a permanent manner and be arranged in such a way that the course selected is clearly visible. If the remote control equipment can be disengaged, it shall be equipped with an indicating device displaying the respective operational conditions 'in service' or 'out of service'. The disposition and manipulation of the controls shall be functional.

For systems that are subsidiary to the steering system, such as active bow thrusters, remote-control equipment not permanently installed shall be acceptable provided that such a subsidiary installation can be activated by means of an override at any time within the wheelhouse.

**▼B**

9. In the case of rudder-propeller, water-jet, cycloidal-propeller and bow-thruster systems, equivalent devices shall be acceptable as control, indicating and monitoring devices.

The requirements set out in paragraphs 1 to 8 shall apply, *mutatis mutandis*, in view of the specific characteristics and arrangements selected for the abovementioned active steering and propulsion units. The position of the indicating device shall clearly show for each installation the direction of the thrust acting on the vessel or the direction of the jet.

*Article 7.05***Navigation lights, light signals and sound signals**

1. In this Article the term:
- (a) ‘navigation lights’ means the masthead, side and stern lights, and the lights visible from all sides, the blue scintillating lights, yellow rapidly scintillating strong lights for high-speed vessels and blue lights for the carriage of dangerous goods;
  - (b) ‘light signals’ means the lights accompanying the sound signals and assigned to the blue panel.
2. Current indicating lights or other equivalent devices, such as repeater lights, for monitoring the navigation lights shall be installed in the wheelhouse unless that monitoring can be performed direct from the wheelhouse.
3. In wheelhouses designed for radar navigation by one person, repeater lights shall be installed on the control panel in order to monitor the navigation lights and the light signals. Switches of navigation lights shall be included in the repeater lights or be adjacent to these and shall be clearly assigned to them.

The arrangement and colour of the repeater lights for the navigation lights and light signals shall correspond to the actual position and colour of those lights and signals.

The failure of a navigation light or light signal to function shall cause the corresponding repeater light either to go out or to provide a signal in another manner.

4. In wheelhouses designed for radar navigation by one person it shall be possible to activate the sound signals by a foot operated switch. That requirement shall not apply to the ‘do not approach’ signal in accordance with the applicable navigational authority regulations of the Member States.
5. Navigation lights shall meet the requirements set out in Annex IX, Part I.

*Article 7.06***Radar installations and rate-of-turn indicators**

1. The radar equipment and rate-of-turn indicators shall be of a type that has been approved by the competent authority. The requirements concerning installation and operational testing of radar equipment and rate-of-turn indicators, as laid down in Annex IX, shall be met. Inland ECDIS equipment which can be operated in navigation mode shall be regarded as radar equipment. In addition the requirements of the Inland ECDIS standard shall be met.

The rate-of-turn indicator shall be located ahead of the helmsman and within his field of vision.

2. In wheelhouses designed for radar navigation by one person:
- (a) the radar screen shall not be shifted significantly out of the helmsman's axis of view in its normal position;
  - (b) the radar image shall continue to be perfectly visible, without a mask or screen, whatever the lighting conditions outside the wheelhouse;
  - (c) the rate-of-turn indicator shall be installed directly above or below the radar image or be incorporated into this.

**▼B***Article 7.07***Radio telephony systems for vessels with wheelhouses designed for radar navigation by one person**

1. Where vessel wheelhouses have been designed for radar navigation by one person, reception from the vessel-vessel networks and that of nautical information shall be via a loudspeaker, and outgoing communications via a fixed microphone. Send/receive shall be selected by means of a push-button.

It shall not be possible to use the microphones of those networks for the public correspondence network.

2. Where vessel wheelhouses designed for radar navigation by one person are equipped with a radio telephone system for the public correspondence network, reception shall be possible from the helmsman's seat.

*Article 7.08***Internal communication facilities on board**

There shall be internal communication facilities on board vessels with a wheelhouse designed for radar navigation by one person.

It shall be possible to establish communication links from the steering position:

- (a) with the bow of the vessel or convoy;
- (b) with the stern of the vessel or convoy if no direct communication is possible from the steering position;
- (c) with the crew accommodation;
- (d) with the boatmaster's cabin.

Reception at all positions of these internal communication links shall be via loudspeaker, and transmission shall be via a fixed microphone. The link with the bow and stern of the vessel or convoy may be of the radio-telephone type.

*Article 7.09***Alarm system**

1. There shall be an independent alarm system enabling the accommodation, engine rooms and, where appropriate, the separate pump rooms to be reached.
2. The helmsman shall have within reach an on/off switch controlling the alarm signal; switches which automatically return to the off position when released are not acceptable.
3. The sound pressure level for the alarm signal shall be at least 75 dB(A) within the accommodation area.

In engine rooms and pump rooms the alarm signal shall take the form of a flashing light that is visible on all sides and clearly perceptible at all points.

*Article 7.10***Heating and ventilation**

Wheelhouses shall be equipped with an effective heating and ventilation system that can be regulated.

*Article 7.11***Stern-anchor operating equipment**

On board vessels and convoys whose wheelhouse has been designed for radar navigation by one person and exceeding 86 m in length or 22,90 m in breadth it shall be possible for the helmsman to drop the stern anchors from his position.

*Article 7.12***Retractable wheelhouses**

Retractable wheelhouses shall be fitted with an emergency lowering system.

**▼B**

All lowering operations shall automatically trigger a clearly audible acoustic warning signal. That requirement shall not apply if the risk of injury which may result from the lowering is prevented by appropriate design features.

It shall be possible to leave the wheelhouse safely whatever its position.

*Article 7.13***Entry in the Community certificate for vessels with wheelhouses designed for radar navigation by one person**

Where a vessel complies with the special provisions for wheelhouses designed for radar navigation by one person as set out in Articles 7.01, 7.04 to 7.08 and 7.11, the following entry shall be made in the Community certificate:

‘The vessel has a wheelhouse designed for radar navigation by one person’.

## CHAPTER 8

**ENGINE DESIGN***Article 8.01***General**

1. Engines and their ancillaries shall be designed, built and installed in accordance with best practice.
2. Installations requiring regular inspection, particularly steam boilers, other pressure vessels and their accessories, and lifts, shall meet the regulations applying in one of the Member States of the Community.
3. Only internal-combustion engines burning fuels having a flashpoint of more than 55 °C may be installed.

*Article 8.02***Safety equipment**

1. Engines shall be installed and fitted in such a way as to be adequately accessible for operation and maintenance and shall not endanger the persons assigned to those tasks. It shall be possible to make them secure against unintentional starting.
2. Main engines, auxiliaries, boilers and pressure vessels, and their accessories, shall be fitted with safety devices.
3. In case of emergency, it shall also be possible to shut down the motors driving the blower and suction fans from outside the space in which they are located, and from outside the engine room.
4. Where necessary, connections of pipes which carry fuel oil, lubricating oil, and oils used in power transmission systems, control and activating systems and heating systems shall be screened or otherwise suitably protected to avoid oil spray or leakages onto hot surfaces, into machinery air intakes, or other sources of ignition. The number of connections in such piping systems shall be kept to a minimum.
5. External high pressure fuel delivery pipes of diesel engines, between the high pressure fuel pumps and fuel injectors, shall be protected with a jacketed piping system capable of containing fuel from a high pressure pipe failure. The jacketed piping system shall include a means for collection of leakages and arrangements shall be provided for an alarm to be given of a fuel pipe failure, except that an alarm is not required for engines with no more than two cylinders. Jacketed piping systems need not be applied to engines on open decks operating windlasses and capstans.
6. Insulation of engine parts shall meet the requirements of Article 3.04(3),-second paragraph.

**▼B***Article 8.03***Power plant**

1. It shall be possible to start, stop or reverse the ship's propulsion reliably and quickly.
2. The following shall be monitored by suitable devices which trigger an alarm once a critical level has been reached:
  - (a) the temperature of the main-engine cooling water;
  - (b) the lubricating-oil pressure for the main engines and transmissions;
  - (c) the oil and air pressure of the main engine reversing units, reversible transmissions or propellers.
3. Where vessels have only one main engine, that engine shall not be shut down automatically except in order to protect against overspeed.
4. Where vessels have only one main engine, that engine may be equipped with an automatic device for the reduction of the engine speed only if an automatic reduction of the engine speed is indicated both optically and acoustically in the wheelhouse and the device for the reduction of the engine speed can be switched off from the helmsman's position.
5. Shaft bushings shall be designed in such a way as to prevent the spread of water-polluting lubricants.

*Article 8.04***Engine exhaust system**

1. The exhaust gases shall be completely ducted out of the vessel.
2. All suitable measures shall be taken to avoid ingress of the exhaust gases into the various compartments. Exhaust pipes passing through accommodation or the wheelhouse shall, within these, be covered by protective gas-tight sheathing. The gap between the exhaust pipe and this sheathing shall be open to the outside air.
3. The exhaust pipes shall be arranged and protected in such a way that they cannot cause a fire.
4. The exhaust pipes shall be suitably insulated or cooled in the engine rooms. Protection against physical contact may suffice outside the engine rooms.

*Article 8.05***Fuel tanks, pipes and accessories**

1. Liquid fuels shall be stored in steel tanks which are either an integral part of the hull or which are firmly attached to the hull. If so required by the design of the vessel, an equivalent material in terms of fire-resistance may be used. These requirements shall not apply to tanks having a capacity of no more than 12 litres that have been incorporated in auxiliaries during their manufacture. Fuel tanks shall not have common partitions with drinking-water tanks.
2. Tanks and their pipework and other accessories shall be laid out and arranged in such a way that neither fuel nor fuel vapours may accidentally reach the inside of the vessel. Tank valves intended for fuel sampling or water drainage shall close automatically.
3. No fuel tanks may be located forward of the collision bulkhead.
4. Fuel tanks and their fittings shall not be located directly above engines or exhaust pipes.
5. The filler orifices for fuel tanks shall be marked distinctly.
6. The orifice for the fuel tank filler necks shall be on the deck, except for the daily-supply tanks. The filler neck shall be fitted with a connection piece in accordance with European standard EN 12827:1999.

Such tanks shall be fitted with a breather pipe terminating in the open air above the deck and arranged in such a way that no water ingress is possible. The cross-section of the breather pipe shall be at least 1,25 times the cross-section of the filler neck.

**▼B**

If tanks are interconnected, the cross-section of the connecting pipe shall be at least 1,25 times the cross-section of the filler neck.

**▼M3**

7. Directly at tank outlets the pipework for the distribution of fuels shall be fitted with a quick-closing valve that can be operated from the deck, even when the rooms in question are closed.

If the operating device is concealed, the lid or cover shall not be lockable.

The operating device shall be marked in red. If the device is concealed it shall be marked with a symbol for the quick-closing valve in accordance with Fig. 9 of Appendix I with a side length of at least 10 cm.

The first subparagraph shall not apply to fuel tanks mounted directly on the engine.

**▼B**

8. Fuel pipes, their connections, seals and fittings shall be made of materials that are able to withstand the mechanical, chemical and thermal stresses to which they are likely to be subjected. The fuel pipes shall not be subjected to any adverse influence of heat and it shall be possible to inspect them throughout their length.
9. Fuel tanks shall be provided with a suitable capacity-gauging device. Capacity-gauging devices shall be legible right up to the maximum filling level. Glass gauges shall be effectively protected against impacts, shall be fitted with an automatic closing device at their base and their upper end shall be connected to the tanks above their maximum filling level. The material used for glass gauges shall not deform under normal ambient temperatures. Sounding pipes shall not terminate in accommodation spaces. Sounding pipes terminating in an engine or boiler room shall be fitted with suitable self-closing devices.
10. (a) Fuel tanks shall be safeguarded against fuel spills during bunkering by means of appropriate onboard technical devices which shall be entered in item 52 of the Community certificate.
- (b) If fuel is taken on from bunkering stations with their own technical devices to prevent fuel spills on board during bunkering, the equipment requirements in (a) and paragraph 11 shall no longer apply.
11. If fuel tanks are fitted with an automatic shut-off device, the sensors shall stop fuelling when the tank is 97 % full; this equipment shall meet the 'failsafe' requirements.

If the sensor activates an electrical contact, which can break the circuit provided by the bunkering station by a binary signal, it shall be possible to transmit the signal to the bunkering station by means of a watertight connection plug meeting the requirements of IEC publication 60309-1:1999 for 40 to 50 V DC, housing colour white, earthing contact position ten o'clock.

12. Fuel tanks shall be provided with openings having leak-proof closures that are intended to permit cleaning and inspection.
13. Fuel tanks directly supplying the main engines and engines needed for safe operation of the vessel shall be fitted with a device emitting both visual and audible signals in the wheelhouse if their level of filling is not sufficient to ensure further safe operation.

*Article 8.06***Storage of lubricating oil, pipes and accessories**

1. Lubricating oil shall be stored in steel tanks which are either an integral part of the hull or which are firmly attached to the hull. If so required by the design of the vessel, an equivalent material in terms of fire-resistance may be used. These requirements shall not apply to tanks having a capacity of no more than 25 litres. Lubricating oil tanks shall not have common partitions with drinking-water tanks.
2. Lubricating oil tanks and their pipework and other accessories shall be laid out and arranged in such a way that neither lubricating oil nor lubricating oil vapour may accidentally reach the inside of the vessel.
3. No lubricating oil tanks may be located forward of the collision bulkhead.

**▼B**

4. Lubricating oil tanks and their fittings shall not be located directly above engines or exhaust pipes.
5. The filler orifices for lubricating oil tanks shall be marked distinctly.
6. Lubricating oil pipes, their connections, seals and fittings shall be made of materials that are able to withstand the mechanical, chemical and thermal stresses to which they are likely to be subjected. The pipes shall not be subjected to any adverse influence of heat and it shall be possible to inspect them throughout their length.
7. Lubricating oil tanks shall be provided with a suitable capacity-gauging device. Capacity-gauging devices shall be legible right up to the maximum filling level. Glass gauges shall be effectively protected against impacts, shall be fitted with an automatic closing device at their base and their upper end shall be connected to the tanks above their maximum filling level. The material used for glass gauges shall not deform under normal ambient temperatures. Sounding pipes shall not terminate in accommodation spaces. Sounding pipes terminating in an engine or boiler room shall be fitted with suitable self-closing devices.

*Article 8.07***Storage of oils used in power transmission systems, control and activating systems and heating systems, pipes and accessories**

1. Oils used in power transmission systems, control and activating systems and heating systems shall be stored in steel tanks which are either an integral part of the hull or which are firmly attached to the hull. If so required by the design of the vessel, an equivalent material in terms of fire-resistance may be used. These requirements shall not apply to tanks having a capacity of no more than 25 litres. Such oil tanks shall not have common partitions with drinking-water tanks.
2. Such oil tanks and their pipework and other accessories shall be laid out and arranged in such a way that neither such oil nor such oil vapour may accidentally reach the inside of the vessel.
3. No such oil tanks may be located forward of the collision bulkhead.
4. Such oil tanks and their fittings shall not be located directly above engines or exhaust pipes.
5. The filler orifices for such oil tanks shall be marked distinctly.
6. Such oil pipes, their connections, seals and fittings shall be made of materials that are able to withstand the mechanical, chemical and thermal stresses to which they are likely to be subjected. The pipes shall not be subjected to any adverse influence of heat and it shall be possible to inspect them throughout their length.
7. Such oil tanks shall be provided with a suitable capacity-gauging device. Capacity-gauging devices shall be legible right up to the maximum filling level. Glass gauges shall be effectively protected against impacts, shall be fitted with an automatic closing device at their base and their upper end shall be connected to the tanks above their maximum filling level. The material used for glass gauges shall not deform under normal ambient temperatures. Sounding pipes shall not terminate in accommodation spaces. Sounding pipes terminating in an engine or boiler room shall be fitted with suitable self-closing devices.

*Article 8.08***Bilge pumping and drainage systems**

1. It shall be possible to pump out each watertight compartment separately. However, that requirement shall not apply to watertight compartments that are normally sealed hermetically during operation.
2. Vessels requiring a crew shall be equipped with two independent bilge pumps which shall not be installed within the same space. At least one of these shall be motor driven. However, for vessels with a power of less than 225 kW or with a deadweight of less than 350 t, or where vessels not intended for the carriage of goods have a displacement of less than 250 m<sup>3</sup>, one pump will suffice which can be either manually-operated or motor-driven.



**▼B**

Each of the required pumps shall be capable of use on each watertight compartment.

3. The minimum pumping capacity  $Q_1$  of the first bilge pump shall be calculated using the following formula:

$$Q_1 = 0,1 \cdot d_1^2 \text{ (l/min)}$$

$d_1$  is calculated via the formula:

$$d_1 = 1,5 \cdot \sqrt{L(B+H)} + 25 \text{ [mm]}$$

The minimum pumping capacity  $Q_2$  of the second bilge pump shall be calculated using the following formula:

$$Q_2 = 0,1 \cdot d_2^2 \text{ (l/min)}$$

$d_2$  is calculated using the formula:

$$d_2 = 2 \cdot \sqrt{l(B+H)} + 25 \text{ [mm]}$$

However, the value  $d_2$  need not exceed value  $d_1$ .

For the calculation of  $Q_2$   $l$  shall be taken to be the length of the longest watertight compartment.

In these formulae:

$l$  is the length of the watertight compartment in question, in (m);

$d_1$  is the calculated internal diameter of the main drainage pipe, in (mm);

$d_2$  is the calculated internal diameter of the branch pipe, in (mm).

4. Where the bilge pumps are connected to a drainage system the drainage pipes shall have an internal diameter of at least  $d_1$ , in mm, and the branch pipes an internal diameter of at least  $d_2$ , in mm.

Where vessels are less than 25 m in length the values  $d_1$  and  $d_2$  may be reduced to 35 mm.

5. Only self-priming bilge pumps are permitted.
6. There shall be at least one suction on both the starboard and port sides of all flat-bottomed, drainable compartments that are wider than 5 m.
7. It may be possible to drain the aft peak via the main engine room by means of an easily accessible, automatically closable fitting.
8. Branch pipes of single compartments shall be connected to the main drainage pipe by means of a lockable non-return valve.

Compartments or other spaces that are capable of carrying ballast need to be connected to the drainage system only by means of a simple closing device. That requirement shall not apply to holds that are capable of carrying ballast. Such holds shall be filled with ballast water by means of ballast piping that is permanently installed and independent of the drainage pipes, or by means of branch pipes that can be connected to the main drainage pipe by flexible pipes or flexible adaptors. Water intake valves located in the bottom of the hold shall not be permitted for this purpose.

9. Hold bilges shall be fitted with gauging devices.
10. Where a drainage system incorporates permanently installed pipework the bilge-bottom drainage pipes intended to extract oily water shall be equipped with closures that have been sealed in position by an inspection body. The number and position of those closures shall be entered on the Community certificate.
11. Locking the closures in position shall be regarded as equivalent to sealing in accordance with paragraph 10. The key or keys for the locking of the closures shall be indicated accordingly and kept in a marked and easily accessible location in the engine room.

**▼B***Article 8.09***Oily water and used oil stores**

1. It shall be possible to store, on board, oily water accumulated during operation. The engine-room bilge is considered to be a store for this purpose.
2. In order to store used oils there shall, in the engine room, be one or several specific receptacles whose capacity corresponds to at least 1,5 times the quantity of the used oils from the sumps of all of the internal combustion engines and transmissions installed, together with the hydraulic fluids from the hydraulic-fluid tanks.

The connections used in order to empty the receptacles referred to above shall comply with European standard EN 1305:1996.

3. Where vessels are only used on short-haul operation the inspection body may grant exceptions from the requirements of paragraph 2.

*Article 8.10***Noise emitted by vessels**

1. The noise produced by a vessel under way, and in particular the engine air intake and exhaust noises, shall be damped by using appropriate means.
2. The noise generated by a vessel under way shall not exceed 75 dB(A) at a lateral distance of 25 m from the ship's side.
3. Apart from transshipment operations the noise generated by a stationary vessel shall not exceed 65 dB(A) at a lateral distance of 25 m from the ship's side.

## CHAPTER 8a

**(Left void)**

## CHAPTER 9

**ELECTRICAL EQUIPMENT***Article 9.01***General**

1. Where there are no specific requirements concerning certain parts of an installation the safety level shall be considered satisfactory where those parts have been produced in accordance with a European standard in force or in accordance with the requirements of an approved classification society.

The relevant documents shall be submitted to the inspection body.

2. Documents containing the following, and duly stamped by the inspection body, shall be kept on board:

- (a) general drawings concerning the entire electrical installation;
- (b) switching diagrams for the main switchboard, the emergency switchboard and the distribution switchboard, together with the most important technical data such as the amperage and rated current of the protection and control devices;
- (c) power data concerning the electrical machinery and equipment;
- (d) types of cable and information on conductor cross-sections.

It is not necessary to keep such documents on board unmanned craft, but they shall be available at all times with the owner.

3. The equipment shall be designed for permanent lists of up to 15° and ambient inside temperatures of between 0 and + 40 °C, and on the deck between - 20 °C and + 40 °C. It shall function perfectly within those limits.
4. The electrical and electronic equipment and appliances shall be fully accessible and easy to maintain.



*Article 9.02*

**Electricity supply systems**

1. Where craft are fitted with an electrical system, that system shall in principle have at least two power sources in such a way that where one power source fails the remaining source is able to supply the power consumers needed for safe navigation for at least 30 minutes.
2. Adequate rating of the power supply shall be demonstrated by means of a power balance. An appropriate simultaneity factor may be taken into account.
3. Independently of paragraph 1, Article 6.04 shall apply to the power source for the steering system (rudder installations).

*Article 9.03*

**Protection against physical contact, intrusion of solid objects and the ingress of water**

The type of minimum protection for permanently installed parts of an installation shall be as set out in the following table:

Location	Type of minimum protection (in accordance with IEC publ. 60529: 1992)					
	Generators	Motors	Trans- formers	Panels Distributors Switches	Fittings	Lighting equipment
Operation rooms, engine rooms, steering-gear compartments	IP 22	IP 22	IP <sup>(2)</sup> 22	IP <sup>(1)</sup> <sup>(2)</sup> 22	IP 44	IP 22
Holds					IP 55	IP 55
Battery and paint lockers						IP 44 u. (Ex) <sup>(3)</sup>
Free decks and open steering positions		IP 55		IP 55	IP 55	IP 55
Wheelhouse		IP 22	IP 22	IP 22	IP 22	IP 22
Accommodation apart from sanitary facilities and washrooms				IP 22	IP 20	IP 20
Sanitary facilities and washrooms		IP 44	IP 44	IP 44	IP 55	IP 44

<sup>(1)</sup> Where appliances release large amounts of heat: IP 12.

<sup>(2)</sup> Where appliances or panels do not have this type of protection their location shall meet the conditions applying to that type of protection.

<sup>(3)</sup> Electrical equipment of the certified safety type as in accordance with

(a) European standards EN 50014: 1997; 50015: 1998; 50016: 2002; 50017: 1998; 50018: 2000; 50019: 2000 and 50020: 2002;

or

(b) IEC publication 60079 as of 1 October 2003.

*Article 9.04*

**Protection from explosion**

Only explosion-proof electrical equipment (certified safety) may be installed in spaces where potentially explosive gases or mixtures of gases are likely to accumulate, such as compartments dedicated for accumulators or the storage of highly inflammable products. No light switches or switches for other electrical appliances shall be installed in these spaces. The protection from explosion shall take account of the characteristics of the potentially explosive gases or mixtures of gases that are likely to arise (explosion-potential group, temperature class).

**▼B***Article 9.05***Earthing**

1. Systems under a voltage of more than 50 V need to be earthed.
2. Metal parts that are open to physical contact and which, during normal operation, are not electrically live, such as engine frames and casings, appliances and lighting equipment, shall be earthed separately where they are not in electrical contact with the hull as a result of their installation.
3. The casings of mobile power consumers and portable devices shall, during normal use, be earthed by means of an additional earthing conductor that is incorporated into the power cable.

That provision shall not apply where a protective circuit-separation transformer is used, nor to appliances fitted with protective insulation (double insulation).

4. The cross-sections of the earthing conductors shall be not less than given in the following table:

Cross-section of outside conductors (mm <sup>2</sup> )	Minimum cross-section of earthing conductors	
	within insulated cables (mm <sup>2</sup> )	fitted separately (mm <sup>2</sup> )
from 0,5 to 4	same cross-section as that of the outside conductor	4
more than 4 to 16	same cross-section as that of the outside conductor	same cross-section as that of the outside conductor
more than 16 to 35	16	16
more than 35 to 120	half of the cross-section of the outside conductor	half of the cross-section of the outside conductor
more than 120	70	70

*Article 9.06***Maximum permissible voltages**

1. The following voltages shall not be exceeded:

Type of installation	Maximum permissible voltage		
	Direct current	Single-phase alternating current	Three-phase alternating current
a. Power and heating installations including the sockets for general use	250 V	250 V	500 V
b. Lighting, communications, command and information installations including the sockets for general use	250 V	250 V	-
c. Sockets intended to supply portable devices used on open decks or within narrow or damp metal lockers, apart from boilers and tanks:			
1. In general	50 V <sup>(1)</sup>	50 V <sup>(1)</sup>	-
2. Where a protective circuit-separation transformer only supplies one appliance	-	250 V <sup>(2)</sup>	-
3. Where protective-insulation (double insulation) appliances are used	250 V	250 V	-
4. Where ≤ 30 mA default current circuit breakers are used.	-	250 V	500 V

**▼ B**

Type of installation	Maximum permissible voltage		
	Direct current	Single-phase alternating current	Three-phase alternating current
d. Mobile power consumers such as electrical equipment for containers, motors, blowers and mobile pumps which are not normally moved during service and whose conducting parts which are open to physical contact are earthed by means of an earthing conductor that is incorporated into the connecting cable and which, in addition to that earthing conductor, are connected to the hull by their specific positioning or by an additional conductor	250 V	250 V	500 V
e. Sockets intended to supply portable appliances used inside boilers and tanks	50 V <sup>(1)</sup>	50 V <sup>(1)</sup>	-

<sup>(1)</sup> Where that voltage comes from higher-voltage networks galvanic separation shall be used (safety transformer).

<sup>(2)</sup> All of the poles of the secondary circuit shall be insulated from the earth.

2. By way of derogation from paragraph 1, if the necessary protective measures are applied higher voltages shall be acceptable:
- (a) for power installations where their power so requires;
  - (b) for special on-board installations such as radio and ignition systems.

*Article 9.07***Distribution systems**

1. The following distribution systems are allowed for direct current and single-phase alternating current:
  - (a) two-conductor systems of which one is earthed (L1/N/PE);
  - (b) single-conductor systems using the hull return principle, only for local installations (for example, starting gear for combustion engines, cathodic protection) (L1/PEN);
  - (c) two-conductor systems that are insulated from the hull (L1/L2/PE).
2. The following distribution systems are allowed for three-phase alternating current:
  - (a) four-conductor systems with earthing of the neutral point, not using the hull return principle (L1/L2/L3/N/PE) = (network TN-S) or (network TT);
  - (b) three-conductor systems insulated from the hull (L1/L2/L3/PE) = (network IT);
  - (c) three-conductor systems with earthing of the neutral point using the hull return principle, however, that shall not be allowed for terminal circuits (L1/L2/L3/PEN).
3. The inspection body may allow the use of other systems.

*Article 9.08***Connection to shore or other external networks**

1. Incoming supply lines from shore networks or other external networks to the installations of the onboard network shall have a permanent connection on board in the form of fixed terminals or fixed plug sockets. The cable connections shall not be subjected to any pulling load.
2. The hull shall be capable of being earthed effectively when the connection voltage exceeds 50 V. The earthing connection shall be specially marked.
3. The switching devices for the connection shall be arranged such as to prevent the concurrent operation of the onboard network generators and the shore network or another external network. A brief period of concurrent operation shall be permitted when changing from one system to another without a break in voltage.

**▼B**

4. The connection shall be protected against short circuiting and overload.
5. The main switchboard shall indicate whether the connection is live.
6. Indicator devices shall be installed to enable comparison of polarity in the case of direct current and phase sequence in the case of three-phase alternating current, between the connection and the onboard network.
7. A panel adjacent to the connection shall indicate:
  - (a) the measures required to establish the connection;
  - (b) the type of current and the nominal voltage and, for alternating current, the frequency.

*Article 9.09***Power supply to other craft**

1. When power is supplied to other craft, a separate connection shall be used. If power sockets rated at more than 16 A are used to supply current to other craft, devices (such as switches or interlocks) shall be provided to ensure that connection and disconnection can take place only when the line is dead.
2. Cable connections shall not be subjected to any pulling load.
3. Article 9.08, paragraphs 3 to 7, shall apply *mutatis mutandis*.

*Article 9.10***Generators and motors**

1. Generators, motors and their terminal boxes shall be accessible for inspections, measurements and repairs. The type of protection shall correspond to their location (see Article 9.03).
2. Generators driven by the main engine, the propeller shaft or by an auxiliary set intended for other purposes shall be designed with respect to the range of rotational speeds which can occur during normal operation.

*Article 9.11***Accumulators**

1. Accumulators shall be accessible and so arranged as not to shift due to movements of the craft. They shall not be placed where they will be exposed to excessive heat, extreme cold, spray, steam or vapour.

They shall not be installed in the wheelhouse, accommodation or holds. This requirement shall not apply to accumulators for portable appliances, or to accumulators requiring a charging power of less than 0,2 kW.

2. Accumulators requiring a charging power of more than 2,0 kW (calculated on the basis of the maximum charging current and the nominal voltage of the accumulator and taking into account the characteristic charging curve of the charging appliance) shall be installed in a special room. If placed on deck enclosing them in a cabinet will suffice.

Accumulators requiring a charging power not exceeding 2,0 kW may be installed in a cabinet or chest not only if placed on deck but also below decks. They may also be installed in an engine room or any other well-ventilated space provided that they are protected against falling objects and dripping water.

3. The interior surfaces of all rooms, cabinets or boxes, shelving or other built-in features intended for accumulators shall be protected against the harmful effects of electrolytes.
4. Provision shall be made for effective ventilation when accumulators are installed in a closed compartment, cabinet or chest. Forced-draught ventilation shall be provided for nickel-cadmium accumulators requiring a charging power of more than 2 kW and for lead-acid accumulators requiring more than 3 kW.

The air shall enter at the bottom and be discharged at the top so as to ensure total gas extraction.

**▼B**

Ventilation ducts shall not include any devices which obstruct the air flow, such as stop valves.

5. The required air throughput (Q) shall be calculated using the following formula:

$$Q = 0,11 \cdot I \cdot n \text{ (m}^3\text{/h)}$$

where:

I = ¼ of the maximum current, in A, provided by the charging device;

n = the number of cells.

In the case of buffer accumulators within the onboard network other methods of calculation taking into account the characteristic charging curve of the charging device may be accepted by the inspection body, provided that these methods are based on the provisions of approved classification societies or on relevant standards.

6. Where natural ventilation is used the cross-section of the ducts shall be sufficient for the required air throughput on the basis of an air-flow velocity of 0,5 m/section. However, the cross-section shall be at least 80 cm<sup>2</sup> for lead-acid accumulators and 120 cm<sup>2</sup> for nickel-cadmium accumulators.
7. Where forced-draught ventilation is used a fan shall be provided, preferably of the suction type, whose motor shall be clear of the gas or air stream.
- Fans shall be so designed as to preclude the generation of sparks through contact between a blade and the fan casing and to avoid any electrostatic charges.
8. 'Fire, naked flame and smoking prohibited' signs according to Figure 2 of Appendix I having a minimum diameter of 10 cm shall be affixed to the doors or covers of compartments, cabinets and chests containing accumulators.

*Article 9.12*

**Switchgear installations**

1. Electrical switchboards

- (a) Appliances, switches, fuses and switchboard instruments shall be clearly arranged and shall be accessible for maintenance and repair.

Terminals for voltages up to 50 V, and those for voltages higher than 50 V, shall be kept separate and marked appropriately.

- (b) For all switches and appliances marker plates identifying the circuit shall be affixed to the switchboards.

The nominal amperage and the circuit for fuses shall be identified.

- (c) When appliances with an operating voltage greater than 50 V are installed behind doors the live components of those appliances shall be protected against accidental contact while the doors are open.

- (d) The materials of switchboards shall have suitable mechanical strength and be durable, flame-retardant and self-extinguishing; they shall not be hygroscopic.

- (e) If high rupture capacity (HRC)-fuses are installed in electrical switchboards, accessories and personal protective equipment shall be available for installing and removing such fuses.

2. Switches, protective devices

- (a) Generator circuits and power consumer circuits shall be protected against short circuiting and overload on all non-earthed conductors. Switching devices triggered by short-circuiting and overload or fuses may be used for this purpose.

Circuits supplying electric motors of drive units (steering system) and their control circuits shall only be protected against short circuiting. Where circuits include thermal circuit-breakers these shall be neutralised or set at not less than twice the nominal amperage.

**▼B**

- (b) Outputs from the main switchboard to power consumers operating at more than 16 A shall include a load or power switch.
  - (c) Power consumers for the propulsion of the craft, the steering system, the rudder position indicator, navigation or safety systems, and power consumers with a nominal amperage greater than 16 A shall be supplied by separate circuits.
  - (d) The circuits of power consumers required for propelling and manoeuvring the vessel shall be supplied directly by the main switchboard.
  - (e) Circuit-breaking equipment shall be selected on the basis of nominal amperage, thermal or dynamic strength, and breaking capacity. Switches shall simultaneously cut off all live conductors. The switching position shall be identifiable.
  - (f) Fuses shall be of the enclosed-melt type and be made of ceramic or an equivalent material. It shall be possible to change them without any danger of physical contact for the operator.
3. Measuring and monitoring devices
- (a) Generator, accumulator and distribution circuits shall be equipped with measuring and monitoring devices where the safe operation of the installation so requires.
  - (b) Non-earthed networks with a voltage of more than 50 V shall be equipped with an earthing detection device capable of giving both visual and audible alarm. In secondary installations such as control circuits, this device may be dispensed with.
4. Location of electrical switchboards
- (a) Switchboards shall be located in accessible and well-ventilated spaces and be protected against water and mechanical damage.  
  
Piping and air ducts shall be so arranged that in the event of leakage the switchboards cannot be damaged. If their installation near electrical switchboards is inevitable, pipes shall not have detachable connections nearby.
  - (b) Cabinets and wall recesses in which unprotected switching devices are installed shall be of a flame-retardant material or be protected by a metal or other flame-retardant sheathing.
  - (c) When the voltage is greater than 50 V, insulating gratings or mats shall be placed at the operator's position in front of the main switchboard.

*Article 9.13***Emergency circuit breakers**

Emergency circuit breakers for oil burners, fuel pumps, fuel separators and engine-room ventilators shall be installed centrally outside the spaces containing the equipment.

*Article 9.14***Installation fittings**

1. Cable entries shall be sized as a function of the cables to be connected and be appropriate to the types of cable used.
2. Sockets for distribution circuits at different voltages or frequencies shall be impossible to confuse.
3. Switches shall simultaneously switch all non-earthed conductors within a circuit. However, single-pole switches within non-earthed circuitry shall be permitted in accommodation-lighting circuits apart from in laundries, bathrooms, washrooms and other rooms with wet facilities.
4. Where amperage exceeds 16 A it shall be possible to lock the sockets by means of a switch in such a way that the plug can only be inserted and withdrawn with the power switched off.



**▼B***Article 9.15***Cables**

1. Cables shall be flame-retardant, self-extinguishing and resistant to water and oil.

In accommodation, other types of cable may be used, provided that they are effectively protected, have flame-retardant characteristics and are self-extinguishing.

Flame-retardant standards of electric cables shall be in accordance with:

- (a) IEC publications 60332-1:1993, 60332-3:2000; or
  - (b) equivalent regulations recognised by one of the Member States.
2. Conductors of cables used for power and lighting circuits shall have a minimum cross-section of 1,5 mm<sup>2</sup>.
  3. Metal armouring, shielding and sheathing of cables shall not, under normal operating conditions, be used as conductors or for earthing.
  4. Metal shielding and sheathing of cables in power and lighting installations shall be earthed at least at one end.
  5. The cross-section of conductors shall take account of their maximum permissible end-temperature (current-carrying capacity) and of the permissible voltage drop. The voltage drop between the main switchboard and the least favourable point of the installation shall not be more than 5 % for lighting or more than 7 % for power or heating circuits, referred to the nominal voltage.
  6. Cables shall be protected against mechanical damage.
  7. The means of fixing the cables shall ensure that any pulling load remains within the permissible limits.
  8. When cables pass through bulkheads or decks, the mechanical strength, watertightness and fire resistance of these bulkheads and decks shall not be affected by the penetrations.
  9. Terminations and joints in all conductors shall be so made as to retain the original electrical, mechanical, flame-retardant and, where necessary, fire resistant properties. ► **M3** The number of cable joints shall be kept to a minimum. ◀
  10. Cables connected to retractable wheelhouses shall be sufficiently flexible and shall have insulation with sufficient flexibility down to — 20 °C and resistance to steam and vapour, ultraviolet rays and ozone.

*Article 9.16***Lighting installations**

1. Lighting appliances shall be so installed that the heat they emit cannot set fire to nearby inflammable objects or components.
2. Lighting appliances on open decks shall be so installed as not to impede the recognition of navigation lights.
3. When two or more lighting appliances are installed in an engine room or boiler room, they shall be supplied by at least two different circuits. This requirement shall also apply to spaces where cooling machinery, hydraulic machinery, or electric motors are installed.

*Article 9.17***Navigation lights**

1. Switchboards for navigation lights shall be installed in the wheelhouse. They shall be supplied by a separate feeder from the main switchboard or by two independent secondary distributions.

**▼B**

2. Navigation lights shall be supplied, protected and switched separately from the navigation lights switchboard.
3. No fault in the monitoring installation, as provided for in Article 7.05(2), shall affect the operation of the light which it monitors.
4. Several lights forming a functional unit and installed together at the same point may be jointly supplied, switched and monitored. The monitoring installation shall be capable of identifying the failure of any one of these lights. However, it shall not be possible to use both light sources in a double light (two lights mounted one above the other or in the same housing) simultaneously.

*Article 9.18***(Left void)***Article 9.19***Alarm and safety systems for mechanical equipment**

The alarm and safety systems for monitoring and protecting mechanical equipment shall meet the following requirements:

## (a) Alarm systems

The alarm systems shall be so designed that no failure in the alarm system can result in failure of the apparatus or installation being monitored.

Binary transmitters shall be designed on the quiescent-current principle or on the monitored load-current principle.

Visual alarms shall remain visible until the fault has been remedied; an alarm that has been acknowledged shall be distinguishable from an alarm that has not yet been acknowledged. Each alarm shall also comprise an audible warning. It shall be possible to switch off acoustic alarms. Switching off one acoustic alarm shall not prevent another signal from being set off by another cause.

Exceptions can be permitted in the case of alarm systems comprising less than five measurement points.

## (b) Safety systems

Safety systems shall be designed to halt or slow down the operation of the affected equipment, or to warn a permanently-manned station to do so before a critical state is reached.

Binary transmitters shall be designed according to the load-current principle.

If safety systems are not designed to be self-monitoring it shall be possible to check that they are operating correctly.

Safety systems shall be independent of other systems.

*Article 9.20***Electronic equipment**

## 1. General

The test conditions in paragraph 2 below shall apply only to electronic devices that are necessary for the steering system and the craft's power plants, including their ancillaries.

## 2. Test conditions

- (a) The stresses arising from the following tests shall not cause electronic devices to be damaged or to malfunction. The tests in accordance with relevant international standards, such as IEC publication 60092-504:2001, apart from the cold-condition test, shall be carried out with the device switched on. These tests shall include checking of proper operation.

**▼B**

## (b) Variations in voltage and frequency

		Variations	
		continuous	short-duration
General	Frequency	± 5 %	± 10 % 5 s
	Voltage	± 10 %	± 20 % 1.5 s
Battery operation	Voltage	+ 30 %/- 25 %	

## (c) Heating test

The sample is brought up to a temperature of 55 °C within a half-hour period. After that temperature has been reached it is maintained for 16 hours. An operating test is then carried out.

## (d) Cold-condition test

The sample is switched off and cooled to -25 °C and held at that temperature for two hours. The temperature is then raised to 0 °C and an operating test is carried out.

## (e) Vibration test

The vibration test shall be carried out along the three axes at the resonance frequency of the devices or of components for the period of 90 minutes in each case. If no clear resonance emerges the vibration test shall be carried out at 30 Hz.

The vibration test shall be carried out by sinusoidal oscillation within the following limits:

General:

$f = 2,0$  to  $13,2$  Hz;  $a = \pm 1$  mm

(amplitude  $a = \frac{1}{2}$  the vibration width)

$f = 13,2$  Hz to 100 Hz: acceleration  $\pm 0,7$  g.

Equipment intended to be fitted to diesel engines or steering apparatus shall be tested as follows:

$f = 2,0$  to 25 Hz;  $a = \pm 1,6$  mm

(amplitude  $a = \frac{1}{2}$  the vibration width)

$f = 25$  Hz to 100 Hz; acceleration  $\pm 4$  g.

The sensors intended to be installed in diesel-engine exhaust pipes may be exposed to considerably higher stresses. Account shall be taken of this during the tests.

(f) The electromagnetic compatibility test shall be carried out on the basis of IEC publications 61000-4-2:1995, 61000-4-3:2002, 61000-4-4:1995, at test degree number 3.

(g) Proof that the electronic equipment is adequate for these test conditions shall be provided by their manufacturer. A certificate by an approved classification society shall likewise be considered to be proof.

*Article 9.21***Electromagnetic compatibility**

The operation of the electric and electronic systems shall not be impaired by electromagnetic interference. General measures shall, with equal importance, extend to:

- (a) disconnection of the transmission paths between the source of interference and affected devices;
- (b) reducing the causes of disturbance at their source;
- (c) reducing the sensitivity of affected devices to interference.

**▼B**

## CHAPTER 10

## EQUIPMENT

*Article 10.01***Anchor equipment**

1. Vessels intended for the carriage of goods, apart from ship-borne lighters whose length  $L$  does not exceed 40m, shall be equipped with bow anchors whose total mass  $P$  is obtained using the following formula:

$$P = k \cdot B \cdot T \text{ (kg)}$$

where

- $k$  is a coefficient that takes account of the relationship between length  $L$  and beam  $B$ , and of the type of vessel:

$$k = c \sqrt{\frac{L}{8 \cdot B}}$$

for lighters, however,  $k = c$  will be taken;

- $c$  is an empirical coefficient given in the following table:

Dead-weight tonnage in t	Coefficient $c$
up to 400 inclusive	45
from 400 to 650 inclusive	55
from 650 to 1 000 inclusive	65
more than 1 000	70

On vessels whose dead-weight tonnage is not greater than 400 t and which, owing to their design and intended purpose, are used only on predetermined short-haul sections, the inspection body may accept that only two-thirds of total mass  $P$  is required for the bow anchors.

2. Passenger vessels and vessels not intended for the carriage of goods, apart from pushers, shall be fitted with bow anchors whose total mass  $P$  is obtained using the following formula:

$$P = k \cdot B \cdot T \text{ (kg)}$$

where:

- $k$  is the coefficient corresponding to paragraph 1, but where in order to obtain the value of the empirical coefficient ( $c$ ) the water displacement in  $m^3$  entered in the Community certificate shall be taken instead of the deadweight tonnage.

3. Vessels referred to in paragraph 1 whose maximum length does not exceed 86 m shall be equipped with stern anchors whose total mass is equal to 25 % of mass  $P$ .

Vessels whose maximum length exceeds 86 m shall be equipped with stern anchors whose total mass is equal to 50 % of mass  $P$  calculated in accordance with paragraph 1 or 2.

Stern anchors are not required for:

- (a) vessels for which the stern anchor mass will be less than 150 kg; in the case of vessels referred to in paragraph 1, final subparagraph, the reduced mass of the bow anchors shall be taken into account;
- (b) lighters.
4. Vessels intended to propel rigid convoys which do not exceed 86 m in length shall be equipped with stern anchors whose total mass is equal to 25 % of maximum mass  $P$  calculated in accordance with paragraph 1 for the formations (considered to be a nautical unit) permitted and entered in the Community certificate.

**▼B**

Vessels intended to propel rigid convoys which exceed 86 m in length downstream shall be equipped with stern anchors whose total mass is equal to 50 % of the maximum mass P calculated in accordance with paragraph 1 for the formations (considered to be a nautical unit) permitted and entered in the Community certificate.

5. The anchor masses established in accordance with paragraphs 1 to 4 may be reduced for certain special anchors.
6. The total mass P specified for bow anchors may be distributed between one or two anchors. It may be reduced by 15 % where the vessel is equipped with only a single bow anchor and the hawse pipe is located amidships.

The total mass required for stern anchors for pushers and vessels whose maximum length exceeds 86 m may be distributed between one or two anchors.

The mass of the lightest anchor shall not be less than 45 % of that total mass.

7. Cast iron anchors shall not be permitted.
8. On anchors their mass shall be indicated in characters which stand out in relief in a durable manner.
9. Anchors having a mass in excess of 50 kg shall be equipped with windlasses.
10. Each bow anchor chain shall have a minimum length of:
  - (a) 40 m for vessels not exceeding 30 m in length;
  - (b) 10 m longer than the vessel where this is more than 30 m and up to 50 m in length;
  - (c) 60 m where vessels are more than 50 m in length.

Each of the stern anchor chains shall be at least 40 m long. However, where vessels need to stop facing downstream they shall have stern anchor chains that are each at least 60 m in length.

11. The minimum tensile strength R of the anchor chains shall be calculated using the following formulae:
  - (a) anchors having a mass up to 500 kg:

$$R = 0,35 \cdot P' \text{ (kN);}$$

- (b) anchors having a mass of more than 500 kg and not exceeding 2 000 kg:

$$R = \left( 0,35 - \frac{P' - 500}{15000} \right) P' \text{ [kN];}$$

- (c) anchors having a mass of more than 2 000 kg:

$$R = 0,25 \cdot P' \text{ (kN).}$$

where

P' is the theoretical mass of each anchor determined in accordance with paragraphs 1 to 4 and 6.

The tensile strength of anchor chains shall be stated according to a standard in force in a Member State.

Where the anchors have a mass greater than that required by paragraphs 1 to 6, the tensile strength of the anchor chain shall be determined as a function of the actual anchor mass.

12. In cases where heavier anchors with correspondingly stronger anchor chains are aboard, only the minimum masses and minimum tensile strengths required according to paragraphs 1 to 6 and 11 shall be entered in the Community certificate.
13. Connecting pieces (swivels) between anchor and chain shall withstand a tensile load 20 % higher than the tensile strength of the corresponding chain.
14. The use of cables instead of anchor chains is permitted. The cables shall have the same tensile strength as that required for chains, but shall be 20 % longer.

**▼B***Article 10.02***Other equipment**

1. According to the applicable navigational authority regulations in force in the Member States, at least the following equipment shall be on board:

- (a) radio-telephone system;
- (b) appliances and devices for giving visual and audible signals as well as daytime and night-time vessel marking;
- (c) stand-alone back-up lights for the prescribed mooring lights;
- (d) a fire-proof, marked receptacle, with cover, to receive oily cleaning cloths;
- (e) a fire-proof, marked receptacle, with cover, to receive hazardous or pollutant solid wastes and a fire-proof, marked receptacle, with cover, to receive hazardous or pollutant liquid wastes according to the relevant applicable navigational authority regulations;
- (f) a fire-proof, marked receptacle, with cover, to receive slops.

2. In addition, the equipment shall include at least:

(a) Mooring cables;

Vessels shall be equipped with three mooring cables. Their minimum lengths shall be at least the following:

- first cable:  $L + 20$  m, but not more than 100 m,
- second cable:  $2/3$  of the first cable,
- third cable:  $1/3$  of the first cable.

The shortest cable is not required on board vessels whose  $L$  is less than 20 m.

The cables shall have a tensile strength  $R_s$  that is calculated using the following formulae;

$$\text{for } L \cdot B \cdot T \text{ up to } 1\,000 \text{ m}^3: \quad R_s = 60 + \frac{L \cdot B \cdot T}{10} \text{ (kN);}$$

$$\text{for } L \cdot B \cdot T \text{ exceeding } 1\,000 \text{ m}^3: \quad R_s = 150 + \frac{L \cdot B \cdot T}{100} \text{ [kN].}$$

For the required cables a certificate in accordance with European standard EN 10 204:1991, under No 3.1, shall be on board.

These cables may be replaced by ropes having the same length and tensile strength. The minimum tensile strength of these ropes shall be indicated in a certificate.

(b) Towing cables;

Tugs shall be equipped with a number of cables that are suitable for their operation.

However, the main cable shall be at least 100 m long and have a tensile strength, in kN, not less than one third of the total power, in kW, of the main engine(s).

Motor vessels and pushers that are also able to tow shall be equipped with a towing cable that is at least 100 m long and whose tensile strength, in kN, is not less than one quarter of the total power, in kW, of the main engine(s).

(c) A heaving line;

(d) A boarding gangway at least 0,4 m wide and 4 m long whose side edges are defined by a brightly-coloured strip; that gangway shall be equipped with a handrail. The inspection body may permit shorter gangways for small vessels;

(e) A gaff hook;

**▼B**

- (f) An appropriate first-aid kit with a content in accordance with a relevant standard of a Member State. The first-aid kit shall be kept in an accommodation room or in the wheelhouse and be stored in such a way that it is easily and safely accessible if necessary. If first-aid kits are stored under cover, the cover shall be marked by a symbol for first-aid kit according to Figure 8 of Appendix I, having a side length of at least 10 cm;
  - (g) A pair of binoculars, 7 × 50 or with larger lens diameter;
  - (h) A notice concerning the rescue and revival of persons overboard;
  - (i) A searchlight that can be operated from the wheelhouse.
3. There shall be an embarkation stairway or ladder on vessels whose side height above the unladen waterline exceeds 1,50 m.

*Article 10.03***Portable fire extinguishers**

1. There shall be at least one portable fire extinguisher in accordance with European standard EN 3:1996 at each of the following places:
  - (a) in the wheelhouse;
  - (b) close to each entrance from the deck to accommodation spaces;
  - (c) close to each entrance to service spaces which are not accessible from the accommodation spaces and which contain heating, cooking or refrigeration equipment using solid or liquid fuels or liquefied gas;
  - (d) at each entrance to engine rooms and boiler rooms;
  - (e) at suitable points below deck in engine rooms and boiler rooms such that no position in the space is more than 10 metres walking distance away from an extinguisher.
2. For the portable fire extinguishers required by paragraph 1, only powder-type extinguishers with a content of at least 6 kg or other portable fire extinguishers with the same extinguishing capacity may be used. They shall be suitable for Class A, B and C fires and for fires in electrical systems of up to 1000 V.
3. In addition powder, water or foam fire extinguishers may be used which are suitable at least for the class of fire most likely to occur in the room for which they are intended.
4. Portable fire extinguishers with CO<sub>2</sub> as the extinguishing agent may be used only for extinguishing fires in galleys and electrical installations. The content of these fire extinguishers shall be no more than 1 kg per 15 m<sup>3</sup> of the room in which they are made available for use.
5. Portable fire extinguishers shall be checked at least every two years. An inspection certificate shall be issued, signed by the inspector and showing the date of inspection.
6. If portable fire extinguishers are installed in such a way that they are out of sight the panel covering them shall be identified by a symbol for fire extinguishers as shown in Figure 3 of Appendix I, and having a side length of at least 10 cm.

*Article 10.03a***Permanently installed fire-fighting systems in accommodation spaces, wheelhouses and passenger spaces**

1. Fire protection in accommodation spaces, wheelhouses and passenger spaces is to be provided only by suitable automatic pressurised water sprinklers as permanently installed fire-fighting systems.
2. Installation or conversion of the systems shall be carried out only by specialised firms.
3. The systems shall be made of steel or equivalent non-combustible materials.
4. The systems shall be able to spray water at a rate of at least 5 l/m<sup>2</sup> per minute over the area of the largest room to be protected.

**▼ M1**

5. Systems spraying smaller quantities of water shall have a type-approval pursuant to IMO Resolution A 800(19) or another recognised standard. Such recognitions, when designed to amend non-essential elements of this Directive, shall be adopted in accordance with the regulatory procedure with scrutiny referred to in Article 19(3) of this Directive. Type-approval shall be carried out by an approved classification society or an accredited testing institution. The accredited testing institution shall comply with the European standard for general requirements for the competence of testing and calibrating laboratories (EN ISO/IEC 17025: 2000).

**▼ B**

6. The systems shall be checked by an expert:
- (a) before being put into service;
  - (b) before being put back into service after they have been triggered;
  - (c) after any modification or repair;
  - (d) regularly at least every two years.
7. When carrying out the check in accordance with paragraph 6, the expert shall verify whether the systems meet the requirements of this paragraph.
- The check shall at least include:
- (a) external inspection of the entire system;
  - (b) functional testing of the safety systems and nozzles;
  - (c) functional testing of the pressure tanks and pumping system.

**▼ M3**

8. An inspection certificate, signed by the expert, shall be issued, showing the date of inspection.

**▼ B**

9. The number of installed systems shall be entered in the Community certificate.

**▼ M3****▼ B***Article 10.03b***Permanently installed fire-fighting systems in engine rooms, boiler rooms and pump rooms****▼ M1**

1. Extinguishing agents

For protecting engine rooms, boiler rooms and pump rooms, the following extinguishing agents may be used in permanently installed fire-fighting systems:

- (a) CO<sub>2</sub> (carbon dioxide);
- (b) HFC 227 ea (heptafluoropropane);
- (c) IG-541 (52 % nitrogen, 40 % argon, 8 % carbon dioxide);

**▼ M3**

- (d) FK-5-1-12 (Dodecafluoro-2-methylpentane-3-on).

**▼ M1**

Permission to use other extinguishing agents, when such permission is designed to amend non-essential elements of this Directive, shall be given in accordance with the regulatory procedure with scrutiny referred to in Article 19(3) of this Directive.

**▼ B**

2. Ventilation, air intake

- (a) Combustion air for the propulsion engines shall not be extracted from rooms that are to be protected by permanently installed fire-fighting systems. This shall not apply where there are two mutually independent and hermetically separated main engine rooms or if next to the main engine room there is a separate engine room with a bow thruster,



**▼B**

ensuring that the vessel is able to make way under its own power in the event of fire in the main engine room.

- (b) Any forced ventilation present in the room to be protected shall switch off automatically if the fire-fighting system is triggered.
- (c) There shall be devices available with which all apertures which can allow air to enter or gas to escape from the room to be protected can be quickly closed. It shall be clearly recognisable whether they are open or closed.
- (d) The air escaping from relief valves in the compressed-air tanks installed in engine rooms shall be conveyed to the open air.
- (e) Over- or underpressure resulting from the inflow of extinguishing agent shall not destroy the components of the surrounding partitions of the room to be protected. It shall be possible for the pressure to equalise without danger.
- (f) Protected rooms shall have a facility for extracting the extinguishing agent and the combustion gases. Such facilities shall be capable of being operated from positions outside the protected rooms and which would not be made inaccessible by a fire within such spaces. If there are permanently installed extractors, it shall not be possible for these to be switched on while the fire is being extinguished.

## 3. Fire alarm system

The room to be protected shall be monitored by means of an appropriate fire alarm system. The alarm shall be noticeable in the wheelhouse, the accommodation spaces and the room to be protected.

## 4. Piping system

- (a) The extinguishing agent shall be conveyed to the room to be protected and distributed there by means of a fixed piping system. Inside the room to be protected the piping and associated fittings shall be made of steel. Tank connecting pipes and expansion joints shall be exempt from this provided the materials used have equivalent properties in case of fire. Pipes shall be both internally and externally protected against corrosion.

**▼M3**

- (b) Outlet nozzles shall be dimensioned and fitted such that the extinguishing agent is evenly distributed. In particular the extinguishing agent shall also be effective beneath the floor plates.

**▼B**

## 5. Triggering device

- (a) Fire-fighting systems with automatic triggering shall not be permissible.
- (b) It shall be possible to trigger the fire-fighting system from a suitable place outside the room to be protected.
- (c) Triggering devices shall be installed in such a way that they can be operated even in case of a fire and in the event of damage by fire or explosion in the room to be protected the necessary quantity of extinguishing agent can still be conveyed.

Non-mechanical triggering devices shall be powered from two different mutually independent energy sources. These energy sources shall be located outside the room to be protected. Control lines in the room to be protected shall be designed so as to remain functional for at least 30 minutes in the event of fire. This requirement shall be fulfilled in the case of electric wiring if it complies with the standard IEC 60331-21:1999.

If triggering devices are installed in such a way that they are out of sight the panel covering them shall be identified by the 'fire-fighting installation' symbol as shown in Figure 6 of Appendix I, having a side length of at least 10 cm, and the following text in red lettering on a white background:

'Feuerlöscheinrichtung

Installation d'extinction

Brandblusinstallatie

Fire-fighting installation'.

**▼B**

- (d) If the fire-fighting system is intended for the protection of several rooms, the triggering devices for each room have to be separate and clearly identified.
- (e) Next to each triggering device operating instructions in one of the languages of the Member States shall be posted up visibly and indelibly. They shall contain, in particular, instructions regarding:
  - (aa) triggering of the fire-fighting system;
  - (bb) the need for checking to ensure that all persons have left the room to be protected;

**▼M3**

- (cc) action to be taken by the crew when the firefighting system is triggered and when accessing the protected room after triggering or flooding, in particular with regard to the possible presence of dangerous substances;

**▼B**

- (dd) action to be taken by the crew in the case of failure of the fire-fighting system.
- (f) The operating instructions shall point out that before the fire-fighting system is triggered combustion engines drawing air from the room to be protected are to be shut down.

## 6. Warning system

- (a) Permanently installed fire-fighting systems shall be provided with acoustic and optical warning systems.
- (b) The warning system shall be set off automatically as soon as the fire-fighting system is first triggered. The warning signal shall sound for an appropriate time before the extinguishing agent is released and it shall not be possible to switch it off.
- (c) Warning signals shall be clearly visible in the rooms to be protected and outside the accesses to them and clearly audible even under operating conditions producing the loudest inherent noise. They shall be clearly distinct from all other acoustic and optical signals in the room to be protected.
- (d) The acoustic warning signals shall be clearly audible in the adjacent rooms even when connecting doors are closed and under operating conditions producing the loudest inherent noise.
- (e) If the warning system is not self-monitoring as regards short-circuits, wire breaks and voltage drops, it shall be possible to check that it is working properly.
- (f) At every entrance to a room that can be supplied with extinguishing agent, a clearly visible notice shall be put up bearing the following text in red lettering on a white background:

‘Vorsicht, Feuerlöscheinrichtung!

Bei Ertönen des Warnsignals (Beschreibung des Signals) den Raum sofort verlassen!

Attention, installation d'extinction d'incendie!

Quitter immédiatement ce local au signal (description du signal)

Let op, brandblusinstallatie!

Bij het in werking treden van het alarmsignaal (omschrijving van het signaal) deze ruimte onmiddellijk verlaten!

Warning, fire-fighting installation!

Leave the room as soon as the warning signal sounds (description of signal)’.

## 7. Pressure tanks, fittings and pressure pipes

- (a) Pressure tanks, fittings and pressure pipes shall comply with the provisions in force in one of the Member States.

**▼B**

- (b) Pressure tanks shall be installed in accordance with the manufacturer's instructions.
- (c) Pressure tanks, fittings and pressure pipes are not to be installed in accommodation spaces.
- (d) The temperature in cabinets and installation spaces containing pressure tanks shall not exceed 50 °C.
- (e) Cabinets or installation spaces on deck shall be firmly fixed in place and have air vents which are to be arranged in such a way that in the event of a leak in the pressure tank no gas can escape into the interior of the vessel. Direct connections to other rooms are not permitted.

## 8. Quantity of extinguishing agent

If the quantity of extinguishing agent is intended for protecting more than one room, the total amount of extinguishing agent available does not need to be greater than the quantity necessary for the largest room to be protected.

## 9. Installation, inspection and documentation

- (a) The system shall be installed or converted only by a firm specialising in fire-fighting systems. The requirements specified by the extinguishing agent manufacturer and the system manufacturer (product data sheet, safety data sheet) are to be complied with.
- (b) The system shall be checked by an expert:
  - (aa) before being put into service;
  - (bb) before being put back into service after it has been triggered;
  - (cc) after any modification or repair;
  - (dd) regularly at least every two years.
- (c) In the inspection the expert shall check whether the system meets the requirements of this chapter.
- (d) The inspection shall cover at least the following:
  - (aa) external inspection of the entire installation;
  - (bb) tightness check on pipes;
  - (cc) functional checking of control and triggering systems;
  - (dd) checking of tank pressure and content;
  - (ee) checking of tightness and facilities for locking the room to be protected;
  - (ff) checking the fire alarm system;
  - (gg) checking the warning system.

**▼M3**

- (e) An inspection certificate, signed by the expert, shall be issued, showing the date of inspection.

**▼B**

- (f) The number of permanently installed fire-fighting systems shall be entered in the Community certificate.

10. CO<sub>2</sub> fire-fighting systems

Fire-fighting systems using CO<sub>2</sub> as the extinguishing agent shall comply with the following provisions in addition to the requirements under paragraphs 1 to 9:

- (a) CO<sub>2</sub> containers shall be housed outside the room to be protected in a space or cabinet hermetically separated from other rooms. The doors to these installation spaces and cabinets shall open outwards, be lockable and bear on the outside a symbol for 'General danger warning' in accordance with Figure 4 of Appendix I, at least 5 cm in height, together with the marking 'CO<sub>2</sub>' in the same colour and with the same height;

**▼B**

- (b) installation spaces below decks for CO<sub>2</sub> containers shall be accessible only from the open air. These spaces shall have their own adequate artificial ventilation system with extraction ducts, completely separate from other ventilation systems on board;
- (c) the CO<sub>2</sub> containers shall not be filled to more than 0,75 kg/l. The specific volume of unpressurised CO<sub>2</sub> gas is to be taken as 0,56 m<sup>3</sup>/kg;
- (d) the volume of CO<sub>2</sub> for the room to be protected shall be at least 40 % of its gross volume. It shall be possible to supply this volume within 120 seconds, and to check whether supply has been completed;
- (e) opening the container valves and operating the flood valve shall be separate control operations;
- (f) the appropriate time mentioned under paragraph 6(b) shall be at least 20 seconds. There shall be a reliable device to ensure the delay before delivery of the CO<sub>2</sub> gas.

## 11. HFC-227ea — fire-fighting systems

Fire-fighting systems using HFC-227ea as the extinguishing agent shall comply with the following provisions in addition to the requirements under paragraphs 1 to 9:

- (a) if there are several rooms to be protected, each with a different gross volume, each room shall be provided with its own fire-fighting system;
- (b) each container of HFC-227ea that is installed in the room to be protected shall be equipped with an overpressure relief valve. This shall harmlessly release the contents of the container into the room to be protected if the container is exposed to the effects of fire and the fire-fighting system has not been triggered;
- (c) each container shall be fitted with a device for checking the gas pressure;
- (d) the containers shall not be filled to more than 1,15 kg/l. The specific volume of the unpressurised HFC-227ea is to be taken as 0,1374 m<sup>3</sup>/kg;
- (e) the volume of HFC-227ea for the room to be protected shall be at least 8 % of the room's gross volume. This volume shall be supplied within 10 seconds;
- (f) the HFC-227ea containers shall be provided with a pressure monitor which triggers an acoustic and optical alarm signal in the wheelhouse in the event of an unauthorised loss of propellant. If there is no wheelhouse, this alarm signal shall be given outside the room to be protected;
- (g) after flooding, the concentration in the room to be protected shall not exceed 10,5 %;
- (h) the fire-fighting system shall not contain any parts made of aluminium.

## 12. IG-541 — fire-fighting systems

Fire-fighting systems using IG-541 as the extinguishing agent shall comply with the following provisions in addition to the requirements under paragraphs 1 to 9:

- (a) if there are several rooms to be protected, each with a different gross volume, each room shall be provided with its own fire-fighting system;
- (b) each container of IG-541 that is installed in the room to be protected shall be equipped with an overpressure relief valve. This shall harmlessly release the contents of the container into the room to be protected if the container is exposed to the effects of fire and the fire-fighting system has not been triggered;
- (c) each container shall be fitted with a device for checking the contents;
- (d) the filling pressure of the container shall not exceed 200 bar at + 15 °C;
- (e) the volume of IG-541 for the room to be protected shall be at least 44 % and no more than 50 % of the room's gross volume. This volume shall be supplied within 120 seconds.

**▼M3**

## 13. FK-5-1-12 — firefighting systems

Firefighting systems using FK-5-1-12 as the extinguishing agent shall comply with the following provisions in addition to the requirements under paragraphs 1 to 9:

- (a) if there are several rooms to be protected, each with a different gross volume, each room shall be provided with its own firefighting system;
- (b) each container of FK-5-1-12 installed in the room to be protected shall be equipped with an overpressure relief valve. The overpressure relief valve shall harmlessly release the contents of the container into the room to be protected if the container is exposed to the effects of fire and the firefighting system has not been triggered;
- (c) each container shall be fitted with a device for checking the gas pressure;
- (d) the containers shall not be filled to more than 1,00 kg/l. The specific volume of the unpressurised FK-5-1-12 is to be taken as 0,0719 m<sup>3</sup>/kg;
- (e) the volume of FK-5-1-12 for the room to be protected shall be at least 5,5 % of the room's gross volume. This volume shall be supplied within 10 seconds;
- (f) the FK-5-1-12 containers shall be provided with a pressure monitor which triggers an acoustic and optical alarm signal in the wheelhouse in the event of an unauthorised loss of propellant. If there is no wheelhouse, this alarm signal shall be given outside the room to be protected;
- (g) after flooding, the concentration in the room to be protected shall not exceed 10,0 %.

*Article 10.03c***Permanently installed firefighting systems for protecting objects**

Permanently installed firefighting systems for protecting objects shall only be permitted on the basis of recommendations from the Committee.

**▼B***Article 10.04***Ship's boats**

1. The following craft shall carry a ship's boat according to European standard EN 1914: 1997:
  - (a) motor vessels and barges exceeding 150 t deadweight;
  - (b) tugs and pushers with a water displacement of more than 150 m<sup>3</sup>;
  - (c) floating equipment;
  - (d) passenger vessels.
2. It shall be possible for one person to launch such ship's boats safely within five minutes from the first manual action necessary. If a powered launching device is used this shall be such that safe, quick launching shall not be impaired if its power supply fails.
3. Inflatable ship's boats shall be inspected according to manufacturer's instructions.

*Article 10.05***Lifebuoys and lifejackets**

1. On board craft there shall be at least three lifebuoys in accordance with European standard EN 14144: 2002. They shall be ready for use and attached to the deck at appropriate points without being attached to their mounting. At least one lifebuoy shall be in the immediate vicinity of the wheelhouse and shall be equipped with a self-igniting, battery-powered light that will not be extinguished in water.

**▼B**

2. ► **M3** A personalised, automatically inflatable lifejacket in accordance with European standards EN 395:1998, EN 396:1998, EN ISO 12402-3:2006 or EN ISO 12402-4:2006 shall be within reach of every person who is regularly on board a craft. ◀

Non-inflatable lifejackets in accordance with these standards shall also be admissible for children.

3. Lifejackets shall be inspected in accordance with the manufacturer's instructions.

## CHAPTER 11

**SAFETY AT WORK STATIONS***Article 11.01***General**

1. Vessels shall be built, arranged and equipped in such a way as to enable persons to work and move about in safety.
2. Permanently installed facilities that are necessary for working on board shall be arranged, laid out and secured in such a way as to permit safe and easy operation, use and maintenance. If necessary, mobile or high-temperature components shall be fitted with protective devices.

*Article 11.02***Protection against falling**

1. Decks and side decks shall be flat and at no point be likely to cause tripping; it shall be impossible for puddles to form.
2. Decks, side decks, engine-room floors, landings, stairways and the tops of side deck bollards shall have non-slip surfaces.
3. The tops of side deck bollards and obstacles in passageways, such as the edges of steps, shall be painted in a colour contrasting with the surrounding deck.
4. The outer edges of decks, as well as work stations where persons might fall more than 1 m, shall be fitted with bulwarks or coamings that are at least 0,70 m high or with a guard rail in accordance with European standard EN 711:1995, which shall comprise a handrail, a rail at knee height and a foot-rail. Side decks shall be fitted with a foot-rail and a continuous handrail that is secured to the coaming. Coaming handrails shall not be required where side decks are fitted with non-retractable shipside guard rails.
5. At work stations where there is danger of falling more than 1 m the inspection body may require appropriate fittings and equipment to ensure safe working.

*Article 11.03***Dimensions of working spaces**

Working spaces shall be large enough to provide every person working in them with adequate freedom of movement.

*Article 11.04***Side decks**

1. The clear width of a side deck shall be at least 0,60 m. That figure may be reduced to 0,50 m at certain points that are necessary for the operation of the vessel such as deck-washing valves. It may be reduced to 0,40 m at bollards and cleats.
2. Up to a height of 0,90 m above the side deck, the clear width of the side deck may be reduced to 0,54 m provided that the clear width above, between the outer edge of the hull and the inner edge of the hold, is not less than 0,65 m. In this case, the clear width of the side deck may be reduced to 0,50 m if the outer edge of the side deck is fitted with a guard rail in accordance with

**▼B**

European standard EN 711:1995 to prevent falling. On vessels 55 m or less in length with only aft accommodation, the guard rail may be dispensed with.

3. The requirements of paragraphs 1 and 2 shall apply up to a height of 2,00 m above the side deck.

*Article 11.05***Access to working spaces**

1. Points of access and passageways for the movement of persons and objects shall be of sufficient size and so arranged that:
  - (a) in front of the access opening, there is sufficient room not to impede movement;
  - (b) the clear width of the passageway shall be appropriate for the intended use of the working space and shall be not less than 0,60 m, except in the case of craft less than 8 m wide, where it may be reduced to 0,50 m;
  - (c) the clear height of the passageway including the sill is not less than 1,90 m.
2. Doors shall be so arranged that they can be opened and closed safely from either side. They shall be protected against accidental opening or closing.
3. Appropriate stairs, ladders or steps shall be installed in accesses, exits and passageways where there is more than a 0,50 m difference in floor level.
4. Working spaces which are manned continuously shall be fitted with stairs if there is a difference in floor level of more than 1,00 m. This requirement shall not apply to emergency exits.
5. Vessels with holds shall have at least one permanently installed means of access at each end of each hold.

By way of derogation from the first sentence the permanently installed means of access may be dispensed with if at least two movable ladders are provided which reach at least 3 rungs over the hatch coaming at an angle of inclination of 60°.

*Article 11.06***Exits and emergency exits**

1. The number, arrangement and dimensions of exits, including emergency exits, shall be in keeping with the purpose and dimensions of the relevant space. Where one of the exits is an emergency exit, it shall be clearly marked as such.
2. Emergency exits or windows or the covers of skylights to be used as emergency exits shall have a clear opening of not less than 0,36 m<sup>2</sup>, and the smallest dimension shall be not less than 0,50 m.

*Article 11.07***Ladders, steps and similar devices**

1. Stairs and ladders shall be securely fixed. Stairs shall be not less than 0,60 m wide and the clear width between handrails shall be not less than 0,60 m; steps shall be not less than 0,15 m deep; steps shall have non-slip surfaces and stairs with more than three steps shall be fitted with handrails.
2. Ladders and separately attached rungs shall have a clear width of not less than 0,30 m; rungs shall be not more than 0,30 m apart and the distance between rungs and structures shall be not less than 0,15 m.
3. Ladders and separately attached rungs shall be clearly recognisable from above and shall be equipped with safety handles above exit openings.
4. Movable ladders shall be at least 0,40 m wide, and at least 0,50 m wide at the base; it shall be possible to ensure that they will not topple or skid; the rungs shall be securely fixed in the uprights.

**▼B***Article 11.08***Interior spaces**

1. The dimensions, arrangement and layout of interior working spaces shall be in keeping with the work to be carried out and shall meet the health and safety requirements. They shall be equipped with sufficient non-dazzle lighting and with sufficient ventilation arrangements. If necessary, they shall be fitted with heating appliances capable of maintaining an adequate temperature.
2. The floors of interior working spaces shall be solid and durable, and shall be designed not to cause tripping or slipping. Openings in decks and floors shall, when open, be secured against the danger of falling, and windows and skylights shall be so arranged and fitted that they can be operated and cleaned safely.

*Article 11.09***Protection against noise and vibration**

1. Working spaces shall be so situated, equipped and designed that crew members are not exposed to harmful vibrations.
2. Permanent working spaces shall, in addition, be so constructed and sound-proofed that the health and safety of crew members are not affected by noise.
3. For crew members who are likely to be exposed to noise levels exceeding 85 dB(A) every day individual acoustic protection devices shall be available. In working spaces where noise levels exceed 90 dB(A) it shall be indicated that wearing of acoustic protection devices is mandatory by a symbol 'Wear acoustic protection device' with a diameter of at least 10 cm in accordance with Figure 7 of Appendix I.

*Article 11.10***Hatch covers**

1. Hatch covers shall be easily accessible and safe to handle. Hatch-cover components weighing more than 40 kg shall be designed to slide or pivot or be fitted with mechanical opening devices. Hatch covers operated by lifting gear shall be fitted with adequate and easily accessible attachment devices. Non-interchangeable hatch covers and upper sills shall be clearly marked to show the hatches to which they belong and their correct position on those hatches.
2. Hatch covers shall be secured against being tilted by the wind or by loading gear. Sliding covers shall be fitted with catches to prevent accidental horizontal movement of more than 0,40 m; they shall be capable of being locked in their final position. Appropriate devices shall be fitted to hold stacked hatch covers in position.
3. The power supply for mechanically operated hatch covers shall be cut off automatically when the control switch is released.
4. Hatch covers shall be capable of bearing the loads to which they are likely to be subjected: Hatch covers designed to be walked on shall be capable of bearing concentrated loads of at least 75 kg. Hatch covers not designed to be walked on shall be marked as such. Hatch covers designed to receive deck cargo shall have the permissible load in t/m<sup>2</sup> marked on them. Where supports are needed to achieve the maximum permissible load this shall be indicated in an appropriate place; in this case the relevant drawings shall be kept on board.

*Article 11.11***Winches**

1. Winches shall be designed in such a way as to enable work to be carried out safely. They shall be fitted with devices that prevent unintentional load release. Winches that do not lock automatically shall be fitted with a brake that is adequate to deal with their tractive force.



**▼B**

2. Hand-operated winches shall be fitted with devices to prevent kickback of the crank. Winches that are both power- and manually driven shall be designed in such a way that the motive-power control cannot actuate the manual control.

*Article 11.12***Cranes**

1. Cranes shall be built in accordance with best practice. The forces arising during their operation shall be safely transmitted into the vessel's structure; they shall not impair its stability.
2. A manufacturer's plate containing the following information shall be affixed to cranes:
  - (a) manufacturer's name and address;
  - (b) the CE marking, together with the year of manufacture;
  - (c) series or type reference;
  - (d) where applicable, serial number.
3. The maximum permissible loadings shall be permanently marked in a clearly legible manner on cranes.

Where a crane's safe working load does not exceed 2 000 kg it will be sufficient if the safe working load at the maximum reach is permanently marked in a clearly legible manner on the crane.

4. There shall be devices to protect against crushing or shearing accidents. The outer parts of the crane shall leave a safety clearance of 0,5 m upwards, downwards and to the sides, between them and all surrounding objects. The safety clearance to the sides shall not be required outside work stations and passageways.
5. It shall be possible to protect power driven cranes against unauthorised use. It shall only be possible to start these up from the crane's driving position. The control shall be of the automatic-return type (buttons without stops); their operating direction shall be unambiguously clear.

If the motive power fails it shall not be possible for the load to drop uncontrolled. Unintentional crane movements shall be prevented.

Any upward movement of the hoisting device and any exceeding of the safe working load shall be limited by an appropriate device. Any downward movement of the hoisting device shall be limited if under any envisaged operating conditions at the moment of attaching the hook there can be less than two cable windings on the drum. The corresponding counter movement shall still be possible after the automatic limiting devices have been actuated.

The tensile strength of the cables for running rigging shall correspond to five times the cable's permissible loading. The cable construction shall be faultless and the design shall be suitable for use on cranes.

6. Before putting into service for the first time or before putting back into service following major alteration, calculations and a load test shall provide proof of adequate strength and stability.

Where a crane's safe working load does not exceed 2 000 kg the expert may decide that the proof by calculation may be fully or partly replaced by a test with a load 1,25 times the safe working load carried out over the full working range.

The acceptance test according to the first or second paragraph shall be carried out by an expert recognised by the inspection body.

7. Cranes shall be checked regularly and in any case at least every 12 months, by an expert. During that inspection the safe working condition of the crane shall be determined by a visual check and an operating check.
8. Every 10 years, at the latest, after the acceptance test the crane shall again be inspected by an expert recognised by the inspection body.
9. Cranes with a safe working load exceeding 2 000 kg, or which are used for transshipment of cargo, or which are mounted on board lifting jacks, pontoons and other floating equipment or worksite craft shall in addition meet the requirements of one of the Member States.

**▼B**

10. For all cranes at least the following documents shall be kept on board:
- (a) the crane manufacturer's operating instructions, including at least the following information:
    - operating range and function of the controls;
    - maximum permissible safe working load as a function of the reach;
    - maximum permissible inclination of the crane;
    - assembly and maintenance instructions;
    - instructions concerning regular checks;
    - general technical data.
  - (b) certificates concerning the checks carried out in accordance with paragraphs 6 to 8 or 9.

*Article 11.13***Storing flammable liquids**

To store flammable liquids with a flash point of less than 55°C there shall be a ventilated cupboard made of non-combustible material on deck. On its outside there shall be a symbol 'Fire, naked flame and smoking prohibited' with a diameter of at least 10 cm in accordance with Figure 2 of Appendix I.

## CHAPTER 12

**ACCOMMODATION***Article 12.01***General**

1. Vessels shall have accommodation for the persons lodging habitually on board, and at least for the minimum crew.
2. Accommodation shall be so designed, arranged and fitted out as to meet the health, safety and comfort needs of those on board. It shall be of safe and easy access and adequately insulated against heat and cold.
3. The inspection body may authorise exceptions to the provisions of this Chapter if the health and safety of those on board are ensured by other means.
4. The inspection body shall enter on the Community certificate any restrictions on the vessel's daily operating periods and its operating mode resulting from the exceptions referred to in paragraph 3.

*Article 12.02***Special design requirements for accommodation**

1. It shall be possible to ventilate accommodation adequately even when the doors are closed; in addition, communal living quarters shall receive adequate daylight and, as far as possible, provide a view out.
2. Where there is no deck-level access to the accommodation and the difference in level is 0,30 m or more the accommodation shall be accessible by means of stairs.
3. In the foresection of the vessel no floor shall be more than 1,20 m below the plane of maximum draught.
4. Living and sleeping quarters shall have at least two exits which are as far apart from each other as possible and which serve as escape routes. One exit may be designed as an emergency exit. This does not apply to rooms with an exit leading directly onto the deck or into a corridor which serves as an escape route, provided the corridor has two exits apart from each other leading to port and starboard. Emergency exits, which may include skylights and windows, shall have a clear opening of at least 0,36 m<sup>2</sup> and a shortest side no less than 0,50 m and permit rapid evacuation in an emergency. Insulation and cladding of escape routes shall be made of

**▼B**

- flame-retardant materials and the usability of escape routes shall be guaranteed at all times by appropriate means such as ladders or separately attached rungs.
5. Accommodation shall be protected against inadmissible noise and vibration. Sound pressure levels shall not exceed:
    - (a) 70 dB(A) in communal living quarters;
    - (b) 60 dB(A) in sleeping quarters. This provision shall not apply to vessels operating exclusively outside the rest periods of the crew as laid down by the national legislation of the Member States. The restriction of the daily operating period shall be entered on the Community certificate.
  6. Headroom in the accommodation shall be not less than 2,00 m.
  7. As a general rule, vessels shall have at least one communal living room partitioned off from the sleeping quarters.
  8. The free floor area of communal living quarters shall be not less than 2 m<sup>2</sup> per person, and in any event not less than 8 m<sup>2</sup> in total (not counting furniture, except tables and chairs).
  9. The cubic capacity of private living and sleeping rooms shall be not less than 7 m<sup>3</sup> each.
  10. The volume of airspace per person shall be at least 3,5 m<sup>3</sup> in private living quarters. In sleeping quarters it shall be at least 5 m<sup>3</sup> for the first occupant and at least 3 m<sup>3</sup> for each additional occupant (not counting volume of furniture). Sleeping cabins shall, as far as possible, be intended for no more than two persons. Berths shall be not less than 0,30 m above the floor. Where one berth is placed over another, the headroom above each berth shall be not less than 0,60 m.
  11. Doors shall have an opening whose upper edge is at least 1,90 m above deck or above the floor and a clear width of at least 0,60 m. The prescribed height may be achieved by means of sliding or hinged covers or flaps. Doors shall open to the outside and it shall be possible to open them from either side. Sills shall not be more than 0,40 m high, but shall nonetheless comply with the provisions of other safety regulations.
  12. Stairways shall be permanently fixed and safely negotiable. They shall be deemed to be so when:
    - (a) they are at least 0,60 m wide;
    - (b) the tread is at least 0,15 m deep;
    - (c) the steps are non-slip;
    - (d) stairways with more than three steps are fitted with at least one handrail or handle.
  13. Pipes carrying dangerous gases or liquids, and particularly those under such a high pressure that a leak could pose a danger to persons, shall not be located in the accommodation or in corridors leading to the accommodation. This does not apply to steam pipes and hydraulic system pipes, provided they are fitted in metal sleeves, and for the pipes of liquefied gas installations for domestic purposes.

*Article 12.03***Sanitary installations**

1. At least the following sanitary installations shall be provided in vessels with accommodation:
  - (a) one toilet per accommodation unit or per six crew members; it shall be possible to ventilate these with fresh air;
  - (b) one washbasin with waste pipe and connected up to hot and cold potable water per accommodation unit or per four crew members;
  - (c) one shower or bath connected up to hot and cold potable water per accommodation unit or per six crew members.
2. The sanitary installations shall be in close proximity to the accommodation. Toilets shall not have direct access to galleys, mess rooms or combined communal living quarters/galleys.

**▼B**

3. Toilet compartments shall have a floor space of at least 1 m<sup>2</sup>, not less than 0,75 m wide and not less than 1,10 m long. Toilet compartments in cabins for no more than two persons may be smaller. Where a toilet contains a wash basin and/or shower, the floor space shall be increased at least by the floor space occupied by the wash basin and/or shower (or bath).

*Article 12.04***Galleys**

1. Galleys may be combined with communal living quarters.
2. Galleys shall comprise:
  - (a) a cooker;
  - (b) a sink with waste connection;
  - (c) a supply of potable water;
  - (d) a refrigerator;
  - (e) sufficient storage and working space.
3. The eating area of combined galleys/communal living quarters shall be large enough to accommodate the number of crew normally using it at the same time. Seats shall be not less than 0,60 m wide.

*Article 12.05***Potable water**

1. Vessels with accommodation shall have a potable water installation. Potable water tank filling apertures and potable water hoses shall be marked as being intended exclusively for potable water. Potable water filler necks shall be installed above the deck.
2. Potable water installations shall:
  - (a) on their inner surfaces be made of a material which resists corrosion and poses no physiological danger;
  - (b) be free of pipe sections where a regular flow of water is not guaranteed, and
  - (c) be protected against excessive heating.
3. In addition to paragraph 2, potable water tanks shall:
  - (a) have a capacity of at least 150 l per person normally living on board, and at least per member of the minimum crew;
  - (b) have a suitable, lockable opening to enable the inside to be cleaned;
  - (c) have a water level indicator;
  - (d) have ventilation pipes which lead to the open air or are fitted with appropriate filters.
4. Potable water tanks shall not share walls with other tanks. Potable water pipes shall not pass through tanks containing other liquids. Connections are not permitted between the potable water supply system and other pipes. Pipes carrying gas or liquids other than potable water shall not pass through potable water tanks.
5. Potable water pressure vessels shall operate only on uncontaminated compressed air. Where it is produced by means of compressors, appropriate air filters and oil separators shall be installed directly in front of the pressure vessel unless the water and the air are separated by a diaphragm.

*Article 12.06***Heating and ventilation**

1. It shall be possible to heat accommodation in accordance with its intended use. Heating installations shall be appropriate for the weather conditions which may arise.

**▼B**

2. It shall be possible to ventilate the living and sleeping quarters adequately even when the doors are closed. Ventilation shall ensure adequate air circulation in all climatic conditions.
3. The accommodation shall be so designed and arranged as to prevent as far as possible the entry of foul air from other areas of the vessel such as engine rooms or holds; where forced-air ventilation is used, the intake vents shall be so placed as to satisfy the above requirements.

*Article 12.07***Other accommodation installations**

1. Each crew member living on board shall have an individual berth and an individual clothes locker fitted with a lock. The internal measurements of the berth shall be not less than 2,00 × 0,90 m.
2. Suitable places for storing and drying work clothes shall be provided, but not in the sleeping quarters.
3. All accommodation areas shall be fitted with electric lighting. Additional lamps using gas or liquid fuel may only be used in communal living quarters. Lighting devices using liquid fuel shall be made of metal and shall burn only fuels with a flash point above 55 °C or commercial paraffin oil. They shall be placed or attached so as not to constitute a fire hazard.

## CHAPTER 13

**FUEL-FIRED HEATING, COOKING AND REFRIGERATING EQUIPMENT***Article 13.01***General**

1. Heating, cooking and refrigeration equipment running on liquefied gas shall meet the requirements of Chapter 14.
2. Heating, cooking and refrigeration equipment, together with its accessories, shall be so designed and installed that it is not dangerous even in the event of overheating. It shall be so installed that it cannot overturn or be moved accidentally.
3. The equipment referred to in paragraph 2 shall not be installed in areas in which substances with a flash point below 55 °C are used or stored. No flues from these installations may pass through such areas.
4. The supply of air necessary for combustion shall be ensured.
5. Heating appliances shall be securely connected to flues, which shall be fitted with suitable cowls or devices affording protection against the wind. They shall be arranged in such a manner as to permit cleaning.

*Article 13.02***Use of liquid fuels, oil-fired equipment**

1. Heating, cooking and refrigeration equipment which uses liquid fuel may be operated only with fuels whose flash point is above 55 °C.
2. By way of derogation from paragraph 1, cooking appliances and heating and refrigeration appliances fitted with burners with wicks and running on commercial paraffin oil may be permitted in the accommodation and wheelhouse provided the capacity of the fuel tank does not exceed 12 litres.
3. Appliances fitted with burners with wicks shall be:
  - (a) fitted with a metal fuel tank whose filling aperture may be locked and which has no soft-solder joints below the maximum filling level, and shall be designed and installed in such a way that the fuel tank cannot be opened or emptied accidentally;
  - (b) capable of being lit without the aid of another liquid fuel;
  - (c) so installed as to ensure the safe evacuation of combustion gases.

**▼B***Article 13.03***Vaporising oil burner stoves and atomising oil burner heating appliances**

1. Vaporising oil burner stoves and atomising oil burner heating appliances shall be built in accordance with best practice.
2. Where a vaporising oil burner stove or an atomising oil burner heating appliance is installed in an engine room, the air supply to the heating appliance and the engines shall be so designed that the heating appliance and the engines can operate properly and safely independently of one another. Where necessary, there shall be a separate air supply. The equipment shall be installed in such a way that no flame from the burner can reach other parts of the engine room installations.

*Article 13.04***Vaporising oil burner stoves**

1. It shall be possible to light vaporising oil burner stoves without the aid of another combustible liquid. They shall be fixed above a metal drip pan which encompasses all the fuel-carrying parts, whose sides are at least 20 mm high and which has a capacity of at least two litres.
2. For vaporising oil burner stoves installed in an engine room, the sides of the metal drip pan prescribed in paragraph 1 shall be at least 200 mm high. The lower edge of the vaporising burner shall be located above the edge of the drip pan. In addition, the upper edge of the drip pan shall extend at least 100 mm above the floor.
3. Vaporising oil burner stoves shall be fitted with a suitable regulator which, at all settings, ensures a virtually constant flow of fuel to the burner and which prevents any fuel leak should the flame go out. Regulators shall be considered suitable which function properly even when exposed to vibration and inclined up to 12° and which, in addition to a level-regulating float, have
  - (a) a second float which closes off the fuel supply safely and reliably when the permitted level is exceeded, or
  - (b) an overflow pipe, but only if the drip pan has sufficient capacity to accommodate at least the contents of the fuel tank.
4. Where the fuel tank of a vaporising oil burner stove is installed separately:
  - (a) the drop between the tank and the burner feed may not exceed that laid down in the manufacturer's operating instructions;
  - (b) it shall be so installed as to be protected from unacceptable heating;
  - (c) it shall be possible to interrupt the fuel supply from the deck.
5. The flues of vaporising oil burner stoves shall be fitted with a device to prevent draught inversion.

*Article 13.05***Atomising oil burner heating appliances**

Atomising oil burner heating appliances shall in particular meet the following requirements:

- (a) adequate ventilation of the burner shall be ensured before the fuel is supplied;
- (b) the fuel supply shall be regulated by a thermostat;
- (c) the fuel shall be ignited by an electric device or by a pilot flame;
- (d) a flame monitoring device shall cut off the fuel supply when the flame goes out;
- (e) the main switch shall be placed at an easily accessible point outside the installation room.

**▼B***Article 13.06***Forced-air heating appliances**

Forced-air heating appliances consisting of a combustion chamber around which the heating air is conducted under pressure to a distribution system or to a room shall meet the following requirements:

- (a) if the fuel is atomised under pressure the combustion air shall be supplied by a blower;
- (b) the combustion chamber shall be well ventilated before the burner can be lit. Ventilation may be considered complete when the combustion air blower continues to operate after the flame has gone out;
- (c) the fuel supply shall be automatically cut off if:
  - the fire goes out;
  - the supply of combustion air is not sufficient;
  - the heated air exceeds a previously set temperature, or
  - the power supply of the safety devices fails.

In the above cases the fuel supply shall not be re-established automatically after being cut off;
- (d) it shall be possible to switch off the combustion air and heating air blowers from outside the room where the heating appliance is located;
- (e) where heating air is drawn from outside, the intake vents shall be located as far as possible above the deck. They shall be installed in such a manner that rain and spray water cannot enter;
- (f) heating air pipes shall be made of metal;
- (g) it shall not be possible to close the heating air outlet apertures completely;
- (h) it shall not be possible for any leaking fuel to reach the heating air pipes;
- (i) it shall not be possible for forced-air heating appliances to draw their heating air from an engine room.

*Article 13.07***Solid fuel heating**

1. Solid fuel heating appliances shall be placed on a metal plate with raised edges such that no burning fuel or hot cinders fall outside the plate.
 

This requirement does not apply to appliances installed in compartments built of non-combustible materials and intended solely to house boilers.
2. Solid fuel boilers shall be fitted with thermostatic controls to regulate the flow of combustion air.
3. A means by which cinders can be quickly doused shall be placed in the vicinity of each heating appliance.

## CHAPTER 14

**LIQUEFIED GAS INSTALLATIONS FOR DOMESTIC PURPOSES***Article 14.01***General**

1. Liquefied gas installations consist essentially of a supply unit comprising one or more gas receptacles, and of one or more pressure regulators, a distribution system and a number of gas-consuming appliances.
 

Spare and empty receptacles not in the supply unit shall not be considered part of the installation. Article 14.05 shall apply to them *mutatis mutandis*.
2. Installations may be operated only with commercial propane.

**▼ B***Article 14.02***Installations**

1. Liquefied gas installations shall be suitable throughout for use with propane and shall be built and installed in accordance with best practice.
2. Liquefied gas installations may be used only for domestic purposes in the accommodation and the wheelhouse, and for corresponding purposes on passenger vessels.
3. There may be a number of separate installations on board. A single installation shall not be used to serve accommodation areas separated by a hold or a fixed tank.
4. No part of a liquefied gas installation shall be located in the engine room.

*Article 14.03***Receptacles**

1. Only receptacles with an approved content of between 5 and 35 kg are permitted. In the case of passenger vessels, the inspection body may approve the use of receptacles with a larger content.
2. Receptacles shall bear the official stamp certifying that they have been accepted following the required tests.

*Article 14.04***Location and arrangement of supply units**

1. Supply units shall be installed on deck in a freestanding or wall cupboard located outside the accommodation in a position such that it does not interfere with movement on board. They shall not, however, be installed against the fore or aft bulwark. The cupboard may be a wall cupboard set into the superstructure provided that it is gastight and can only be opened from outside the superstructure. It shall be so located that the distribution pipes leading to the gas consumption points are as short as possible.

No more receptacles may be in operation simultaneously than are necessary for the functioning of the installation. Several receptacles may be connected only if a reversing coupler is used. Up to four receptacles may be connected per supply unit. The number of receptacles on board, including spare receptacles, shall not exceed six per installation.

Up to six receptacles may be connected on passenger vessels with galleys or canteens for passengers. The number of receptacles on board, including spare receptacles, shall not exceed nine per installation.

Pressure regulators, or in case of two-stage regulation the first pressure regulator, shall be fitted to a wall in the same cupboard as the receptacles.

2. Supply units shall be so installed that any leaking gas can escape from the cupboard into the open without any risk of it penetrating inside the vessel or coming into contact with a source of ignition.
3. Cupboards shall be constructed of flame-retardant materials and shall be sufficiently ventilated by apertures in the top and bottom. Receptacles shall be placed upright in the cupboards in such a way that they cannot overturn.
4. Cupboards shall be so built and placed that the temperature of the receptacles cannot exceed 50 °C.
5. The words 'Liquefied gas' and a 'Fire, naked flame and smoking prohibited' symbol at least 10 cm in diameter in accordance with Figure 2 of Appendix I shall be affixed to the outer wall of the cupboard.

*Article 14.05***Spare and empty receptacles**

Spare and empty receptacles not located in the supply unit shall be stored outside the accommodation and the wheelhouse in a cupboard built in accordance with Article 14.04.



**▼B***Article 14.06***Pressure regulators**

1. Gas-consuming appliances may be connected to receptacles only through a distribution system fitted with one or more pressure regulators to bring the gas pressure down to the utilisation pressure. The pressure may be reduced in one or two stages. All pressure regulators shall be set permanently at a pressure determined in accordance with Article 14.07.
2. The final pressure regulators shall be either fitted with or immediately followed by a device to protect the pipe automatically against excess pressure in the event of a malfunctioning of the pressure regulator. It shall be ensured that in the event of a leak in the protection device any leaking gas can escape into the open without any risk of it penetrating inside the vessel or coming into contact with a source of ignition; if necessary, a special pipe shall be fitted for this purpose.
3. The protection devices and vents shall be protected against the entry of water.

*Article 14.07***Pressure**

1. Where two-stage regulating systems are used, the mean pressure shall be not more than 2,5 bar above atmospheric pressure.
2. The pressure at the outlet from the last pressure regulator shall be not more than 0,05 bar above atmospheric pressure, with a tolerance of 10 %.

*Article 14.08***Piping and flexible tubes**

1. Pipes shall consist of permanently installed steel or copper tubing.  

However, pipes connecting with the receptacles shall be high-pressure flexible tubes or spiral tubes suitable for propane. Gas-consuming appliances may, if not permanently installed, be connected by means of suitable flexible tubes not more than 1 m long.
2. Pipes shall be able to withstand any stresses, in particular regarding corrosion and strength, which may occur under normal operating conditions on board and their characteristics and layout shall be such that they ensure a satisfactory flow of gas at the appropriate pressure to the gas-consuming appliances.
3. Pipes shall have as few joints as possible. Both pipes and joints shall be gastight and shall remain gastight despite any vibration or expansion to which they may be subjected.
4. Pipes shall be readily accessible, properly fixed and protected at every point where they might be subject to impact or friction, particularly where they pass through steel bulkheads or metal walls. The entire surface of steel pipes shall be treated against corrosion.
5. Flexible pipes and their joints shall be able to withstand any stresses which may occur under normal operating conditions on board. They shall be installed in such a way that they are free of tension, cannot be heated excessively and can be inspected over their entire length.

*Article 14.09***Distribution system**

1. It shall be possible to shut off the entire distribution system by means of a main valve which is at all times easily and rapidly accessible.
2. Each gas-consuming appliance shall be supplied by a separate branch of the distribution system, and each branch shall be controlled by a separate closing device.
3. Valves shall be fitted at points where they are protected from the weather and from impact.

**▼B**

4. An inspection connection shall be fitted after each pressure regulator. It shall be ensured using a closing device that in pressure tests the pressure regulator is not exposed to the test pressure.

*Article 14.10***Gas-consuming appliances and their installation**

1. The only appliances that may be installed are propane-consuming appliances approved in one of the Member States and equipped with devices that effectively prevent the escape of gas in the event of either the flame or the pilot light being extinguished.
2. Appliances shall be so placed and connected that they cannot overturn or be accidentally moved and any risk of accidental wrenching of the connecting pipes is avoided.
3. Heating and water-heating appliances and refrigerators shall be connected to a flue for evacuating combustion gases into the open air.
4. The installation of gas-consuming appliances in the wheelhouse is permitted only if the wheelhouse is so constructed that no leaking gas can escape into the lower parts of the craft, in particular through the penetrations for control lines to the engine room.
5. Gas-consuming appliances may be installed in sleeping quarters only if combustion is independent of ambient air in the quarters.
6. Gas-consuming appliances in which combustion depends on ambient air shall be installed in rooms which are sufficiently large.

*Article 14.11***Ventilation and evacuation of combustion gases**

1. In rooms containing gas-consuming appliances in which combustion depends on ambient air, fresh air shall be supplied and combustion gases evacuated by means of ventilation apertures of adequate dimensions, with a clear section of at least 150 cm<sup>2</sup> per aperture.
2. Ventilation apertures shall not have any closing device and shall not lead to sleeping quarters.
3. Evacuation devices shall be so designed as to ensure the safe evacuation of combustion gases. They shall be reliable in operation and made of non-combustible materials. Their operation shall not be affected by forced ventilation.

*Article 14.12***Operating and safety requirements**

An operating instruction shall be affixed on board in a suitable place. It shall contain at least the following:

‘The valves of receptacles not connected to the distribution system shall be closed, even if the receptacles are presumed empty’;

‘Flexible pipes shall be replaced as soon as their condition so requires’;

‘All gas-consuming appliances shall be connected or the corresponding connecting pipes shall be sealed’.

*Article 14.13***Acceptance test**

Before a liquefied gas installation is put into service, after any modification or repair and on every renewal of the attestation referred to in Article 14.15, the entire installation shall be accepted by an expert recognised by the inspection body. During the acceptance test the expert shall verify whether the installation

**▼B**

conforms to the requirements of this Chapter. ► **M3** Additionally, for passenger vessels the expert shall verify whether a valid inspection certificate certifying the correct installation of the gas alarm system referred to in Article 15.15(9) or its inspection is available. ◀ He shall submit an acceptance report to the inspection body.

*Article 14.14***Tests**

Tests on the installation shall be carried out under the following conditions:

1. Medium-pressure pipes between the closing device, referred to in Article 14.09 (4), of the first pressure regulator and the valves fitted before the final pressure regulator:

(a) pressure test, carried out with air, an inert gas or a liquid at a pressure 20 bar above atmospheric pressure;

(b) tightness test, carried out with air or an inert gas at a pressure 3,5 bar above atmospheric pressure.

2. Pipes at the service pressure between the closing device, referred to in Article 14.09(4), of the only pressure regulator or the final pressure regulator and the valves fitted before the gas-consuming appliances:

tightness test, carried out with air or an inert gas at a pressure of 1 bar above atmospheric pressure.

3. Pipes situated between the closing device, referred to in Article 14.09 (4), of the only pressure regulator or the final pressure regulator and the controls of gas-consuming appliances:

tightness test at a pressure of 0,15 bar above atmospheric pressure.

4. In the tests referred to in paragraphs 1(b), 2 and 3, the pipes are deemed gastight if, after sufficient time to allow for equalisation with ambient temperature, no decrease in the test pressure is observed during a further 10 minute test period.

5. Receptacle connectors, pipe joints and other fittings subjected to the pressure in the receptacles, and joints between pressure regulators and the distribution pipe:

tightness test, carried out with a foaming substance, at the service pressure.

6. All gas-consuming appliances shall be brought into service at the nominal capacity and shall be tested for satisfactory and undisturbed combustion at different capacity settings.

Flame failure devices shall be checked to ensure that they operate satisfactorily.

7. After the test referred to in paragraph 6, it shall be verified for each gas-consuming appliance connected to a flue, whether, after five minutes' operation at the nominal capacity, with windows and doors closed and the ventilation devices in operation, any combustion gases are escaping into the room through the air intake.

If there is a more than momentary escape of such gases, the cause shall immediately be detected and remedied. The appliance shall not be approved for use until all defects have been eliminated.

*Article 14.15***Attestation**

1. The Community certificate shall include an attestation to the effect that all liquefied gas installations conform to the requirements of this Chapter.
2. The attestation will be issued by the inspection body following the acceptance test referred to in Article 14.13.
3. The attestation shall be valid for a period not exceeding three years. It may be renewed only after a further acceptance test carried out in accordance with Article 14.13.

**▼B**

Exceptionally, where the owner of a vessel or his representative submits a reasoned request, the inspection body may extend the validity of the attestation for not more than three months without carrying out the acceptance test referred to in Article 14.13. Such extension shall be entered in the Community certificate.

## CHAPTER 15

## SPECIFIC REQUIREMENTS APPLICABLE TO PASSENGER VESSELS

*Article 15.01***General provisions**

1. The following provisions shall not apply:
  - (a) Article 3.02(1)(b);
  - (b) Articles 4.01 to 4.03;
  - (c) Article 8.08(2), second sentence, and paragraph 7;
  - (d) Article 9.14(3), second sentence, for rated voltages of over 50V.
2. The following items of equipment are prohibited on passenger vessels:
  - (a) lamps powered by liquefied gas or liquid fuel according to Article 12.07(3);
  - (b) vaporising oil-burner stoves according to Article 13.04;
  - (c) solid fuel heaters according to Article 13.07;
  - (d) devices fitted with wick burners according to Article 13.02(2) and (3), and
  - (e) liquefied gas devices according to Chapter 14.
3. Vessels without their own power cannot be licensed for passenger transport.
4. On passenger vessels, areas shall be provided for use by persons with reduced mobility, according to the provisions of this Chapter. If the application of provisions of this Chapter which take into account the specific safety needs of persons with reduced mobility is difficult in practice or incurs unreasonable costs, the inspection body may allow derogations from these provisions on the basis of recommendations in accordance with the procedure referred to in Article 19(2) of this Directive. These derogations shall be mentioned in the Community certificate.

*Article 15.02***Vessels' hulls**

1. In the course of the inspections referred to in Article 2.09, the thickness of the outside plating of steel passenger vessels shall be determined as follows:
  - (a) the minimum thickness  $t_{\min}$  of the bottom, bilge and side plating of the outer hull of passenger vessels is determined in accordance with the larger value of the following formulae:

$$t_{1_{\min}} = 0,006 \cdot a \cdot \sqrt{T} \text{ [mm];}$$

$$t_{2_{\min}} = f \cdot 0,55 \cdot \sqrt{L_{WL}} \text{ [mm].}$$

In these formulae:

$$f = 1 + 0,0013 \cdot (a - 500);$$

a = longitudinal or transverse frame spacing (mm), and where the frame spacing is less than 400 mm, a = 400 mm should be entered;

- (b) it is permissible to fall short of the minimum value determined in accordance with (a) above for the plate thickness in cases where the permitted value has been determined and certified on the basis of a

**▼B**

- mathematical proof for the sufficient strength (longitudinal, transverse and local) of the vessel's hull;
- (c) at no point of the outside plating shall the thickness calculated in accordance with (a) or (b) above be less than 3 mm;
- (d) plate renewals shall be carried out when bottom, bilge or side plate thicknesses have fallen short of the minimum value determined in accordance with (a) or (b), in conjunction with (c) above.
2. The number and position of bulkheads shall be selected such that, in the event of flooding, the vessel remains buoyant according to Article 15.03(7) to (13). Every portion of the internal structure which affects the efficiency of the subdivision of such vessels shall be watertight, and shall be of a design which will maintain the integrity of the subdivision.
  3. The distance between the collision bulkhead and the forward perpendicular shall be at least  $0,04 L_{WL}$  and not more than  $0,04 L_{WL} + 2$  m.
  4. A transverse bulkhead may be fitted with a bulkhead recess, if all parts of this offset lie within the safe area.
  5. The bulkheads, which are taken into account in the damaged stability calculation according to Article 15.03(7) to (13), shall be watertight and be installed up to the bulkhead deck. Where there is no bulkhead deck, these bulkheads shall extend to a height at least 20 cm above the margin line.
  6. The number of openings in these bulkheads shall be kept as low as is consistent with the type of construction and normal operation of the vessel. Openings and penetrations shall not have a detrimental effect on the watertight function of the bulkheads.
  7. Collision bulkheads shall have no openings and no doors.
  8. Bulkheads according to paragraph 5 separating the engine rooms from passenger areas or crew and shipboard personnel accommodation shall have no doors.
  9. Manually operated doors without remote control in bulkheads referred to in paragraph 5, are permitted only in areas not accessible to passengers. They shall:
    - (a) remain closed at all times and be opened only temporarily to allow access;
    - (b) be fitted with suitable devices to enable them to be closed quickly and safely;
    - (c) display the following notice on both sides of the doors:
 

‘Close door immediately after passing through’.
  10. Doors in bulkheads referred to in paragraph 5 that are open for long periods shall comply with the following requirements:
    - (a) They shall be capable of being closed from both sides of the bulkhead and from an easily accessible point above the bulkhead deck.
    - (b) After being closed by remote control the door shall be such that it can be opened again locally and closed safely. Closure shall not be impeded by carpeting, foot rails or other obstructions.
    - (c) The time taken for the remote-controlled closure process shall be at least 30 seconds but not more than 60 seconds.
    - (d) During the closure procedure an automatic acoustic alarm shall sound by the door.
    - (e) The door drive and alarm shall also be capable of operating independently of the on-board power supply. There shall be a device at the location of the remote control that displays whether the door is open or closed.
  11. Doors in bulkheads referred to in paragraph 5, and their actuators shall be located in the safe area.
  12. There shall be a warning system in the wheelhouse to indicate which of the doors in bulkheads referred to in paragraph 5 are open.

**▼ B**

13. Open-ended piping and ventilation ducts shall be offset in such a way that, in any conceivable flooding, no additional spaces or tanks are flooded through them.
  - (a) If several compartments are openly connected by piping or ventilation ducts, such piping and ducts shall, in an appropriate place, be lead above the waterline corresponding to the worst possible flooding.
  - (b) Piping need not meet the requirement under (a) if shut-off devices are fitted in the piping where it passes through the bulkheads and which can be remotely controlled from a point above the bulkhead deck.
  - (c) Where a pipework system has no open outlet in a compartment, the pipework shall be regarded as intact in the event of this compartment being damaged, if it runs within the safe area and is more than 0,50 m from the bottom of the vessel.
14. Remote controls of bulkhead doors according to paragraph 10 and shut-off devices according to paragraph 13(b) above the bulkhead deck shall be clearly indicated as such.
15. Where double bottoms are fitted, their height shall be at least 0,60 m, and where wing voids are fitted, their width shall be at least 0,60 m.
16. Windows may be situated below the margin line if they are watertight, cannot be opened, possess sufficient strength and conform to Article 15.06(14).

*Article 15.03***Stability**

1. The applicant shall prove by a calculation based on the results from the application of a standard for intact stability that the intact stability of the vessel is appropriate. All calculations shall be carried out free to trim and sinkage. ► **M3** The lightship data taken into account for the stability calculation shall be determined by means of a heeling test. ◀
2. The intact stability shall be proven for the following standard load conditions:
  - (a) at the start of the voyage:
 

100 % passengers, 98 % fuel and fresh water, 10 % waste water;
  - (b) during the voyage:
 

100 % passengers, 50 % fuel and fresh water, 50 % waste water;
  - (c) at the end of the voyage:
 

100 % passengers, 10 % fuel and fresh water, 98 % waste water;
  - (d) unladen vessel:
 

no passengers, 10 % fuel and fresh water, no waste water.

For all standard load conditions, the ballast tanks shall be considered as either empty or full in accordance with normal operational conditions.

**▼ M3**

In addition, the requirement of section 3(d) shall be proved for the following load condition:

**▼ B**

100 % passengers, 50 % fuel and fresh water, 50 % waste water, all other liquid (including ballast) tanks are considered filled to 50 %.

**▼ M3****▼ B**

3. The proof of adequate intact stability by means of a calculation shall be produced using the following definitions for the intact stability and for the standard load conditions mentioned in paragraph 2(a) to (d):

**▼ M3**

- (a) the maximum righting lever  $h_{\max}$  shall occur at a heeling angle of  $\varphi_{\max} \geq (\varphi_{\text{mom}} + 3^\circ)$  and shall not be less than 0,20 m. However, in

**▼ M3**

case  $\varphi_f < \varphi_{\max}$  the righting lever at the downflooding angle  $\varphi_f$  shall not be less than 0,20 m;

- (b) the downflooding angle  $\varphi_f$  shall not be less than  $(\varphi_{\text{mom}} + 3^\circ)$ ;
- (c) the area A under the curve of the righting levers shall, depending on the position of  $\varphi_f$  and  $\varphi_{\max}$ , reach at least the following values:

Case			A
1	$\varphi_{\max} \leq 15^\circ$ or $\varphi_f \leq 15^\circ$		0,05 m·rad up to the smaller of the angles $\varphi_{\max}$ or $\varphi_f$
2	$15^\circ < \varphi_{\max} < 30^\circ$	$\varphi_{\max} \leq \varphi_f$	$0,035 + 0,001 \cdot (30 - \varphi_{\max})$ m·rad up to the angle $\varphi_{\max}$
3	$15^\circ < \varphi_f < 30^\circ$	$\varphi_{\max} > \varphi_f$	$0,035 + 0,001 \cdot (30 - \varphi_f)$ m·rad up to the angle $\varphi_f$
4	$\varphi_{\max} \geq 30^\circ$ and $\varphi_f \geq 30^\circ$		0,035 m·rad up to the angle $\varphi = 30^\circ$

Where:

- $h_{\max}$  is the maximum lever;
- $\varphi$  the heeling angle;
- $\varphi_f$  the downflooding angle, that is the heeling angle, at which openings in the hull, in the superstructure or deck houses which cannot be closed so as to be watertight, submerge;
- $\varphi_{\text{mom}}$  the maximum heeling angle according to (e);
- $\varphi_{\max}$  the heeling angle at which the maximum righting lever occurs;
- A the area under the curve of the righting levers;

**▼ B**

- (d) the initial metacentric height,  $GM_o$ , corrected by the effect of the free surfaces in liquid tanks, shall not be less than 0,15 m;

**▼ M3**

- (e) in each of the following two cases the heeling angle  $\varphi_{\text{mom}}$  shall not exceed 12:
- (aa) in application of the heeling moment due to persons and wind according to sections 4 and 5;
- (bb) in application of the heeling moment due to persons and turning according to sections 4 and 6;

**▼ B**

- (f) for a heeling moment resulting from moments due to passengers, wind and turning according to paragraphs 4, 5 and 6, the residual freeboard shall be not less than 200 mm;
- (g) for vessels with windows or other openings in the hull located below the bulkhead decks and not closed watertight, the residual safety clearance shall be at least 100 mm on the application of the three heeling moments resulting from subparagraph (f).
4. The heeling moment due to one-sided accumulation of persons shall be calculated according to the following formula:

$$M_p = g \cdot P \cdot y = g \cdot \sum P_i \cdot y_i \text{ (kNm)}$$

where:

- P = total mass of persons on board in (t), calculated by adding up the maximum permitted number of passengers and the maximum number of shipboard personnel and crew under normal operating conditions, assuming an average mass per person of 0,075 t
- y = lateral distance of centre of gravity of total mass of persons P from centre line in (m)
- g = acceleration of gravity ( $g = 9,81 \text{ m/s}^2$ )

**▼B**

$P_i$  = mass of persons accumulated on area  $A_i$  in (t)

$$P_i = n_i \cdot 0,075 \cdot A_i \text{ (t)}$$

where

$A_i$  = area occupied by persons in (m<sup>2</sup>)

$n_i$  = number of persons per square meter

**▼M3**

$n_i$  3,75 for free deck areas and deck areas with movable furniture;

for deck areas with fixed seating furniture such as benches,  $n_i$  shall be calculated by assuming an area of 0,50 m in width and 0,75 m in seat depth per person

**▼B**

$y_i$  = lateral distance of geometrical centre of area  $A_i$  from centre line in (m).

The calculation shall be carried out for an accumulation of persons both to starboard and to port.

The distribution of persons shall correspond to the most unfavourable one from the point of view of stability. Cabins shall be assumed unoccupied for the calculation of the persons' moment.

For the calculation of the loading cases, the centre of gravity of a person shall be taken as 1 m above the lowest point of the deck at 0,5 L<sub>WL</sub>, ignoring any deck curvature and assuming a mass of 0,075 t per person.

A detailed calculation of deck areas which are occupied by persons may be dispensed with if the following values are used:

$$P = 1,1 \cdot F_{\max} \cdot 0,075 \quad \text{for day trip vessels}$$

$$1,5 \cdot F_{\max} \cdot 0,075 \quad \text{for cabin vessels}$$

where

$F_{\max}$  = maximum permitted number of passengers on board

$y = B/2$  in (m).

5. The moment due to wind pressure ( $M_w$ ) shall be calculated as follows:

$$M_w = p_w \cdot A_w \cdot (l_w + T/2) \text{ (kNm)}$$

where

$p_w$  = the specific wind pressure of 0,25 kN/m<sup>2</sup>;

$A_w$  = lateral plane of the vessel above the plane of draught according to the considered loading condition in m<sup>2</sup>;

$l_w$  = distance of the centre of gravity of the lateral plane  $A_w$  from the plane of draught according to the considered loading condition in m.

6. The moment due to centrifugal force ( $M_{dr}$ ), caused by the turning of the vessel, shall be calculated as follows:

$$M_{dr} = c_{dr} \cdot C_B \cdot v^2 \cdot D/L_{WL} \cdot (KG - T/2) \text{ (kNm)}$$

where

$c_{dr}$  = a coefficient of 0,45;

$C_B$  = block coefficient (if not known, taken as 1,0);

$v$  = maximum speed of the vessel in m/s;

$KG$  = distance between the centre of gravity and the keel line in m.

For passenger vessels with propulsion systems according to Article 6.06,  $M_{dr}$  shall be derived from full-scale or model tests or else from corresponding calculations.



**▼B**

7. The applicant shall prove, by means of a calculation based on the method of lost buoyancy, that the damaged stability of the vessel is appropriate in the event of flooding. All calculations shall be carried out free to trim and sinkage.
8. Buoyancy of the vessel in the event of flooding shall be proven for the standard load conditions specified in paragraph 2. Accordingly, mathematical proof of sufficient stability shall be determined for the three intermediate stages of flooding (25, 50 and 75 % of flood build-up) and for the final stage of flooding.
9. Passenger vessels shall comply with the one-compartment status and the two-compartment status.

The following assumptions concerning the extent of damage shall be taken into account in the event of flooding:

**▼M3**

	1-compartment status	2-compartment status
Dimension of the side damage		
longitudinal l [m]	$0,10 \cdot L_{WL}$ , however not less than 4,00 m	$0,05 \cdot L_{WL}$ , however not less than 2,25 m
transverse b [m]	B/5	0,59
vertical h [m]	from vessel bottom to top without delimitation	
Dimension of the bottom damage		
longitudinal l [m]	$0,10 \cdot L_{WL}$ , however not less than 4,00 m	$0,05 \cdot L_{WL}$ , however not less than 2,25 m
transverse b [m]	B/5	
vertical h [m]	0,59; pipework installed according to Article 15.02(13)(c), shall be deemed intact	

**▼B**

- (a) For one-compartment status the bulkheads can be assumed to be intact if the distance between two adjacent bulkheads is greater than the damage length. Longitudinal bulkheads at a distance of less than B/3 from the outer plating measured perpendicular to centre line from the shell plating at the maximum draught shall not be taken into account for calculation purposes.
- (b) For two-compartment status each bulkhead within the extent of damage will be assumed to be damaged. This means that the position of the bulkheads shall be selected in such a way as to ensure that the passenger vessel remains buoyant after flooding of two or more adjacent compartments in the longitudinal direction.
- (c) The lowest point of every non-watertight opening (e.g. doors, windows, access hatchways) shall lie at least 0,10 m above the damaged waterline. The bulkhead deck shall not be immersed in the final stage of flooding.
- (d) Permeability is assumed to be 95 %. If it is proven by a calculation that the average permeability of any compartment is less than 95 %, the calculated value can be used instead.

The values to be adopted shall not be less than:

Lounges	95 %
Engine and boiler rooms	85 %
Luggage and store rooms	75 %
Double bottoms, fuel bunkers, ballast and other tanks, depending on whether, according to their intended purpose, they are to be assumed to be full or empty for the vessel floating at the plane of maximum draught	0 or 95 %

▼ M3▼ B

- (e) If damage of a smaller dimension than specified above produces more detrimental effects with respect to heeling or loss of metacentric height, such damage shall be taken into account for calculation purposes.
10. For all intermediate stages of flooding referred to in paragraph 8, the following criteria shall be met:

- (a) the heeling angle  $j$  at the equilibrium position of the intermediate stage in question shall not exceed  $15^\circ$ ;
- (b) beyond the heel in the equilibrium position of the intermediate stage in question, the positive part of the righting lever curve shall display a righting lever value of  $GZ \geq 0,02$  m before the first unprotected opening becomes immersed or a heeling angle  $\varphi$  of  $25^\circ$  is reached;
- (c) non-watertight openings shall not be immersed before the heel in the equilibrium position of the intermediate stage in question has been reached;

▼ M3

- (d) the calculation of the free surface effect in all intermediate stages of flooding shall be based on the gross surface area of the damaged compartments.

▼ B

11. During the final stage of flooding, the following criteria shall be met taking into account the heeling moment ► M3 ◀ in accordance with paragraph 4:

- (a) the heeling angle  $\varphi_E$  shall not exceed  $10^\circ$ ;

▼ M3

- (b) beyond the equilibrium position the positive part of the righting lever curve shall display a righting lever value of  $GZ_R \geq 0,02$  m with an area  $A \geq 0,0025$  m $\cdot$ rad. These minimum values for stability shall be met until the immersion of the first unprotected opening or in any case before reaching a heeling angle  $\varphi_m$  of  $25^\circ$ .

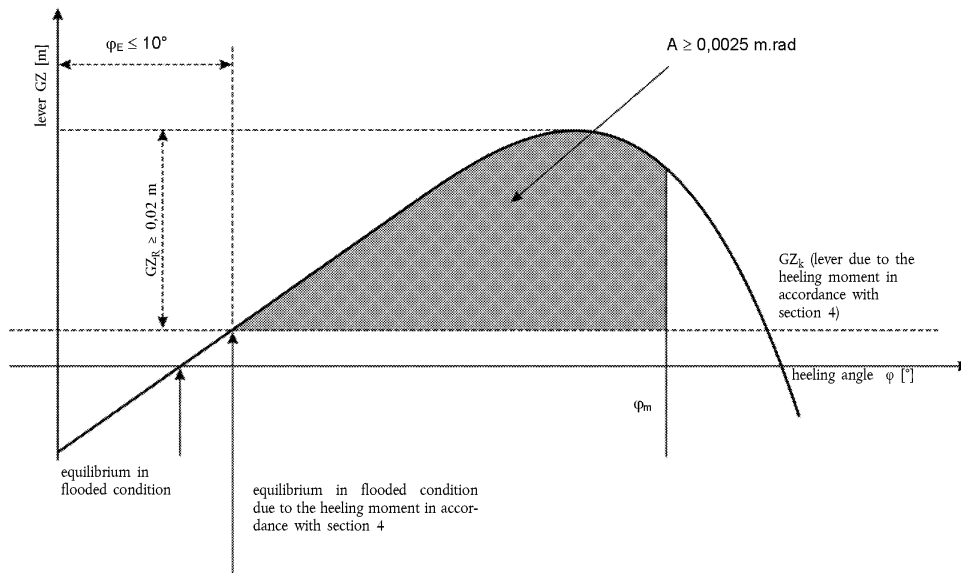

Where:

- $\varphi_E$  is the heeling angle in the final stage of flooding taking into account the moment in accordance with section 4;
- $\varphi_m$  is the angle of vanishing stability or the angle at which the first unprotected opening immerses or  $25^\circ$ ; whichever is less is to be used;
- $GZ_R$  is the remaining righting lever in the final stage of flooding taking into account the moment in accordance with section 4;

**▼M3**

$GZ_K$  is the heeling lever resulting from the moment in accordance with section 4;

**▼B**

- (c) non-watertight openings shall not be immersed before the equilibrium position has been reached; if such openings are immersed before this point, the rooms affording access are deemed to be flooded for damaged stability calculation purposes.
12. The shut-off devices which shall be able to be closed watertight shall be marked accordingly.
13. If cross-flood openings to reduce asymmetrical flooding are provided, they shall meet the following conditions:
- (a) for the calculation of cross-flooding, IMO Resolution A.266 (VIII) shall be applied;
  - (b) they shall be self-acting;
  - (c) they shall not be equipped with shut-off devices;
  - (d) the total time allowed for compensation shall not exceed 15 minutes.

*Article 15.04***Safety clearance and freeboard**

1. The safety clearance shall be at least equal to the sum of:
- (a) the additional lateral immersion, which, measured on the outside plating, is produced by the permissible heeling angle according to Article 15.03(3)(e), and
  - (b) the residual safety clearance according to Article 15.03(3)(g).
- For vessels without a bulkhead deck, the safety clearance shall be at least 500 mm.
2. The freeboard shall be at least equal to the sum of:
- (a) the additional lateral immersion, which, measured on the outside plating, is produced by the heeling angle according to Article 15.03(3)(e), and
  - (b) the residual freeboard according to Article 15.03(3)(f).
- However, the freeboard shall be at least 300 mm.
3. The plane of maximum draught is to be set so as to ensure compliance with the safety clearance according to paragraph 1, and the freeboard according to paragraph 2 and Articles 15.02 and 15.03.
4. For safety reasons, the inspection body may stipulate a greater safety clearance or a greater freeboard.

*Article 15.05***Maximum permitted number of passengers**

1. The inspection body shall set the maximum permitted number of passengers and shall enter this number on the Community certificate.
2. The maximum permitted number of passengers shall not exceed any of the following values:
- (a) number of passengers for whom the existence of an evacuation area according to Article 15.06(8), has been proven;
  - (b) number of passengers that has been taken into account for the stability calculation according to Article 15.03;
  - (c) number of available berths for passengers on cabin vessels used for voyages including overnight stays.
3. For cabin vessels which are also used as day trip vessels, the number of passengers shall be calculated for use both as a day trip vessel and as a cabin vessel and entered on the Community certificate.
4. The maximum permitted number of passengers shall be displayed on clearly legible and prominently positioned notices on board the vessel.

**▼B***Article 15.06***Passenger rooms and areas**

1. Passenger rooms shall:
  - (a) on all decks, be located aft of the level of the collision bulkhead and, as long as they are below the bulkhead deck, forward of the level of the aft-peak bulkhead, and
  - (b) be separated from the engine and boiler rooms in a gas-tight manner;
  - (c) be so arranged, that sight lines in accordance with Article 7.02 do not pass through them.
2. Cupboards and rooms referred to in Article 11.13 and intended for the storage of flammable liquids shall be outside the passenger area.
3. The number and width of the exits of passenger rooms shall comply with the following requirements:
  - (a) rooms or groups of rooms designed or arranged for 30 or more passengers or including berths for 12 or more passengers shall have at least two exits. On day trip vessels one of these two exits can be replaced by two emergency exits; ► **M3** rooms, with the exception of cabins, and groups of rooms that have only one exit, shall have at least one emergency exit; ◀
  - (b) if rooms are located below the bulkhead deck, one of the exits can be a watertight bulkhead door, according to Article 15.02(10), leading into an adjacent compartment from which the upper deck can be reached directly. The other exit shall lead directly or, if permitted in accordance with (a), as an emergency exit into the open air, or to the bulkhead deck. This requirement does not apply to individual cabins;
  - (c) exits according to (a) and (b) shall be suitably arranged and shall have a clear width of at least 0,80 m and also a clear height of at least 2,00 m. For doors of passenger cabins and other small rooms, the clear width can be reduced to 0,70 m;
  - (d) in the case of rooms or groups of rooms intended for more than 80 passengers the sum of the widths of all exits intended for passengers and which shall be used by them in an emergency shall be at least 0,01 m per passenger;
  - (e) if the total width of the exits is determined by the number of passengers, the width of each exit shall be at least 0,005 m per passenger;
  - (f) emergency exits shall have a shortest side at least 0,60 m long or a minimum diameter of 0,70 m. They shall open in the direction of escape and be marked on both sides;
  - (g) exits of rooms intended for use by persons with reduced mobility shall have a clear width of at least 0,90 m. Exits normally used for embarking and disembarking people with reduced mobility shall have a clear width of at least 1,50 m.
4. Doors of passenger rooms shall comply with the following requirements:
  - (a) with the exception of doors leading to connecting corridors, they shall be capable of opening outwards or be constructed as sliding doors;
  - (b) cabin doors shall be made in such a way that they can also be unlocked from the outside at any time;
  - (c) powered doors shall open easily in the event of failure of the power supply to this mechanism;
  - (d) for doors intended for use by persons with reduced mobility, there shall be from the direction from which the door opens, a minimum clearance of 0,60 m between the inner edge of the doorframe on the lock side and an adjacent perpendicular wall.
5. Connecting corridors shall comply with the following requirements:
  - (a) they shall have a clear width of at least 0,80 m or, if they lead to rooms used by more than 80 passengers, at least 0,01 m per passenger;
  - (b) their clear height shall be not less than 2,00 m;

**▼B**

- (c) connecting corridors intended for use by persons with reduced mobility shall have a clear width of 1,30 m. Connecting corridors more than 1,50 m wide shall have handrails on either side;
  - (d) where a part of the vessel or a room intended for passengers is served by a single connecting corridor, the clear width thereof shall be at least 1,00 m;
  - (e) connecting corridors shall be free of steps;
  - (f) they shall lead only to open decks, rooms or staircases;
  - (g) dead ends in connecting corridors shall be not longer than two meters.
6. In addition to the provisions of paragraph 5, escape routes shall also comply with the following requirements:
- (a) stairways, exits and emergency exits shall be so disposed that, in the event of a fire in any given area, the other areas may be evacuated safely;
  - (b) the escape routes shall lead by the shortest route to evacuation areas according to paragraph 8;
  - (c) escape routes shall not lead through engine rooms or galleys;
  - (d) there shall be no rungs, ladders or the like installed at any point along the escape routes;
  - (e) doors to escape routes shall be constructed in such a way as not to reduce the minimum width of the escape route referred to in paragraph 5(a) or (d);
  - (f) escape routes and emergency exits shall be clearly signed. The signs shall be lit by the emergency lighting system.
7. Escape routes and emergency exits shall have a suitable safety guidance system.
8. For all persons on board, there shall be muster areas available which satisfy the following requirements:
- (a) ► **M3** the total area of the muster areas ( $A_S$ ) shall correspond to at least the following value: ◀
    - Day trip vessels:  $A_S = 0,35 \cdot F_{\max}$  (m<sup>2</sup>)
    - Cabin vessels:  $A_S = 0,45 \cdot F_{\max}$  (m<sup>2</sup>)

In these formulae the following definition applies:

$F_{\max}$  maximum permitted number of passengers on board;
  - (b) each individual muster or evacuation area shall be larger than 10 m<sup>2</sup>;
  - (c) the muster areas shall be clear of furniture, whether movable or fixed;
  - (d) if movable furniture is located in a room in which muster areas are defined, it shall be secured appropriately to avoid slipping;
  - (e) life-saving appliances shall be easily accessible from the evacuation areas;
  - (f) it shall be possible to evacuate people safely from these evacuation areas, using either side of the vessel;
  - (g) the muster areas shall lie above the margin line;
  - (h) the muster and evacuation areas are to be shown as such in the safety plan and signposted on board the vessel;
  - (i) if fixed seats or benches are located in a room in which muster areas are defined the corresponding number of persons need not be taken into account when calculating the total area of muster areas according to (a). However, the number of persons for whom fixed seats or benches in a certain room are taken into account must not exceed the number of persons for whom muster areas are available in this room;
  - (j) the provisions of (d) and (i) shall also apply to free decks on which muster areas are defined;

**▼B**

- (k) if collective life-saving appliances complying with Article 15.09(5), are available on board, the number of persons for whom such appliances are available may be disregarded when calculating the total surface area of the muster areas referred to in (a);
  - (l) however, in all cases where reductions according to (i) to (k) are applied, the total area according to (a) shall be sufficient for at least 50 % of the maximum permitted number of passengers.
9. Stairs and their landings in the passenger areas shall comply with the following requirements:
- (a) they shall be constructed in accordance with European standard EN 13056: 2000;
  - (b) they shall have a clear width of at least 0,80 m or, if they lead to connecting corridors or areas used by more than 80 passengers, at least 0,01 m per passenger;
  - (c) they shall have a clear width of at least 1,00 m if they provide the only means of access to a room intended for passengers;
  - (d) where there is not at least one staircase on each side of the vessel in the same room, they shall lie in the safe area;
  - (e) in addition, stairs intended for use by persons with reduced mobility shall comply with the following requirements:
    - (aa) The gradient of the stairs shall not exceed 38°;
    - (bb) The stairs shall have a clear width of at least 0,90 m;
    - (cc) Spiral staircases are not allowed;
    - (dd) The stairs shall not run in a direction transverse to the vessel;
    - (ee) The handrails of the stairs shall extend approximately 0,30 m beyond the top and bottom of the stairs without restricting traffic routes;
    - (ff) Handrails, front sides of at least the first and the last step as well as the floor coverings at the ends of the stairs shall be colour highlighted.
- Lifts intended for persons with reduced mobility, and lifting equipment, like stairlifts or lifting platforms, shall be constructed according to a relevant standard or a regulation of a Member State.
10. Parts of the deck intended for passengers, and which are not enclosed, shall comply with the following requirements:
- (a) they shall be surrounded by a fixed bulwark or guard rail at least 1,00 m high or a railing according to the European standard EN 711: 1995, construction type PF, PG or PZ. Bulwarks and railings of decks intended for use by persons with reduced mobility shall be at least 1,10 m high;
  - (b) openings and equipment for embarking or disembarking and also openings for loading or unloading shall be such that they can be secured and have a clear width of at least 1,00 m. Openings, used normally for the embarking or disembarking of persons with reduced mobility, shall have a clear width of at least 1,50 m;
  - (c) if the openings and equipment for embarking or disembarking cannot be observed from the wheelhouse, optical or electronic aids shall be provided;
  - (d) passengers sitting down shall not interrupt sight lines in accordance with Article 7.02.
11. The parts of the vessel not intended for passengers, in particular access to the wheelhouse, to the winches and to the engine rooms, shall be such that they can be secured against unauthorised entry. At any such access, a symbol corresponding to Figure 1 in Appendix I shall be displayed in a prominent position.
12. Gangways shall be constructed in accordance with European standard EN 14206: 2003. By way of derogation from Article 10.02(2)(d), their length can be less than 4 m.

**▼B**

13. Traffic areas intended for use by persons with reduced mobility shall have a clear width of 1,30 m and be free of doorsteps and sills more than 0,025 m high. Walls in traffic areas intended for use by persons with reduced mobility shall be equipped with handrails at a height of 0,90 m above the floor.
14. Glass doors and walls in traffic areas and also window panes shall be manufactured from pre-stressed glass or laminated glass. They may also be made from a synthetic material, provided this is authorised for use in a fire-protection context.  
  
Transparent doors and transparent walls extending as far as the floor in traffic areas shall be prominently marked.
15. Superstructures or their roofs consisting completely of panoramic panes shall only be manufactured from materials which, in the event of an accident, reduce as much as possible the risks of injury to the persons on board.
16. Potable water systems shall, at least, comply with the requirements of Article 12.05.
17. There shall be toilets available for passengers. At least one toilet shall be fitted for use by persons with reduced mobility according to a relevant standard or a regulation of a Member State and shall be accessible from areas intended for use by persons with reduced mobility.
18. Cabins without an opening window shall be connected to a ventilation system.
19. By analogy, rooms in which crew members or shipboard personnel are accommodated shall comply with the provisions of this Article.

*Article 15.07***Propulsion system**

In addition to the main propulsion system, vessels shall be equipped with a second independent propulsion system so as to ensure that, in the event of a breakdown affecting the main propulsion system, the vessel can continue to make steerageway under its own power.

The second independent propulsion system shall be placed in a separate engine room. If both engine rooms have common partitions, these shall be built according to Article 15.11 (2).

*Article 15.08***Safety devices and equipment**

1. All passenger vessels shall have internal communication facilities according to Article 7.08. Such facilities shall also be available in the operation rooms and, where there is no direct communication from the wheelhouse, in the access and evacuation areas for passengers as referred to in Article 15.06(8).
2. All passenger areas shall be reachable via a loudspeaker system. The system shall be designed in such a way as to ensure that the information transmitted can be clearly distinguished from background noise. Loudspeakers are optional where direct communication between the wheelhouse and the passenger area is possible.
3. The vessel shall be equipped with an alarm system. The system shall include:
  - (a) an alarm system enabling passengers, crew members and shipboard personnel to alert the vessel's command and crew.  
  
This alarm should be given only in areas assigned to the vessel's command and to the crew; it should only be possible for the vessel's command to stop the alarm. The alarm shall be capable of being triggered from at least the following places:
    - (aa) in each cabin;
    - (bb) in the corridors, lifts and stairwells, with the distance to the nearest trigger not exceeding 10 m and with at least one trigger per watertight compartment;
    - (cc) in lounges, dining rooms and similar recreation rooms;

**▼B**

- (dd) in toilets, intended for use by persons with reduced mobility;
- (ee) in engine rooms, galleys and similar rooms where there is a fire risk;
- (ff) in the cold-storage rooms and other store rooms.

The alarm triggers shall be installed at a height above the floor of 0,85 m to 1,10 m;

- (b) an alarm system enabling the vessel's command to alert passengers.

This alarm shall be clearly and unmistakably audible in all rooms accessible to passengers. It shall be capable of being triggered from the wheelhouse and from a location that is permanently staffed;

- (c) an alarm system enabling the vessel's command to alert the crew and shipboard personnel.

The alarm system referred to in Article 7.09(1), shall also reach the recreation rooms for the shipboard personnel, the cold-storage rooms and other store rooms.

Alarm triggers shall be protected against unintentional use.

4. Each watertight compartment shall be fitted with a bilge level alarm.
5. Two motor-driven bilge pumps shall be provided.
6. A permanently installed drainage system according to Article 8.08(4), shall be provided on board.
7. Cold-storage room doors, even when locked, shall also be capable of being opened from the inside.
8. Where CO<sub>2</sub> bar-systems are situated in rooms below deck these rooms shall be fitted with an automatic ventilation system which turns itself on automatically when the door or hatch to the room is opened. The ventilation ducts shall run down to 0,05 m from the floor of this room.
9. In addition to the first-aid kit according to Article 10.02(2)(f), further first-aid kits shall be provided in sufficient number. The first-aid kits and their storage shall comply with the requirements set out in Article 10.02(2)(f).

*Article 15.09***Life-saving equipment**

1. ► **M3** In addition to the lifebuoys specified in Article 10.05(1), all parts of the deck intended for passengers and not enclosed shall be equipped with suitable lifebuoys, which shall be positioned on both sides of the vessel not more than 20 m apart. Lifebuoys shall be considered as suitable if they comply with
  - the European standard EN 14144:2003, or
  - the International Convention for the Safety of Life at Sea (SOLAS 1974) Chapter III Rule 7.1 and the International Life-Saving Appliance (LSA) Code, paragraph 2.1. ◀

Half of all the prescribed lifebuoys shall be fitted with a buoyant cord at least 30 m long with a diameter of 8 to 11 mm. The other half of the prescribed lifebuoys shall be fitted with a self-igniting, battery-powered light which will not be extinguished in water.

**▼M3**

2. In addition to the lifebuoys referred to in section 1, individual life-saving equipment according to Article 10.05, section 2, shall be within reach for all shipboard personnel. For shipboard personnel not responsible for undertaking duties according to the safety rota not inflatable or semi-automatically inflatable lifejackets according to the standards mentioned in Article 10.05, section 2, are allowed.

**▼B**

3. Passenger vessels shall have appropriate equipment to enable persons to be transferred safely to shallow water, to the bank or to another craft.



**▼ B**

4. ► **M3** In addition to the life-saving equipment referred to in sections 1 and 2, individual life-saving equipment according to Article 10.05, section 2, shall be available for 100 % of the maximum permitted number of passengers. Not inflatable or semi-automatically inflatable lifejackets according to the standards mentioned in Article 10.05, section 2, are also allowed. ◀

**▼ M3****▼ B**

5. The term ‘collective life-saving equipment’ covers ship's boats according to Article 10.04, and life rafts.

Life rafts shall:

- (a) bear a notice indicating their purpose and the number of persons for whom they are approved;
  - (b) offer adequate seating space for the permitted number of persons;
  - (c) provide a buoyancy of at least 750 N per person in fresh water;
  - (d) be provided with a rope linked to the passenger vessel to prevent them drifting away;
  - (e) be made of suitable materials and be resistant to oil, oil products and temperatures up to 50 °C;
  - (f) assume and maintain a stable trim and, in this respect, be fitted with appropriate devices enabling them to be grabbed by the indicated number of persons;
  - (g) be fluorescent orange in colour or have fluorescent surfaces, visible from all sides, of at least 100 cm<sup>2</sup>;
  - (h) be such that they can be released from their stowed position and put overboard quickly and safely by one person, or can float free from their stowed position;
  - (i) be provided with appropriate means of evacuation from the evacuation areas referred to in Article 15.06(8), onto the life rafts if the vertical distance between the deck of the evacuation areas and the plane of maximum draught is greater than 1 m.
6. Additional collective life-saving appliances are items of life-saving equipment which ensure the buoyancy of several persons in the water. These shall:
- (a) bear a notice indicating their purpose and the number of persons for whom they are approved;
  - (b) provide a buoyancy of at least 100 N per person in fresh water;
  - (c) be made of suitable materials and be resistant to oil, oil products and to temperatures of up to 50 °C;
  - (d) assume and maintain a stable trim and, in this respect, be fitted with appropriate devices enabling them to be grabbed by the indicated number of persons;
  - (e) be fluorescent orange in colour or have fluorescent surfaces, visible from all sides, of at least 100 cm<sup>2</sup>;
  - (f) be such that they can be released from their stowed position and put overboard quickly and safely by one person, or can float free from their stowed position.
7. Inflatable collective life-saving appliances shall in addition:
- (a) comprise at least two separate air compartments;
  - (b) inflate automatically or by manual command when launched;
  - (c) assume and maintain a stable trim irrespective of the load to be supported, even when only half the air compartments are inflated.
8. The life-saving appliances shall be stowed on board in such a way that they can be reached easily and safely when required. Concealed storage places shall be clearly marked.

**▼B**

9. Life-saving equipment shall be checked according to the manufacturer's instructions.
10. The ship's boat shall be equipped with an engine and a searchlight.
11. A suitable stretcher shall be available.

*Article 15.10***Electrical Equipment**

1. Only electrical equipment shall be permitted for lighting.
2. Article 9.16(3), shall also apply additionally for passageways and recreation rooms for passengers.
3. For the following rooms and locations, adequate lighting and emergency lighting shall be provided:
  - (a) locations where life-saving equipment is stored and where such equipment is normally prepared for use;
  - (b) escape routes, access for passengers, including gangways, entrances and exits, connecting corridors, lifts and accommodation area companionways, cabin areas and accommodation areas;
  - (c) markings on the escape routes and emergency exits;
  - (d) in other areas intended for use by persons with reduced mobility;
  - (e) operation rooms, engine rooms, steering equipment rooms and their exits;
  - (f) wheelhouse;
  - (g) emergency power supply room;
  - (h) points at which extinguishers and fire extinguishing equipment controls are located;
  - (i) areas in which passengers, shipboard personnel and crew muster in the event of danger.
4. There shall be an emergency power plant, consisting of an emergency power source and emergency switchboard, which, in the event of a failure of the supply to the following electrical equipment, can immediately take over as their replacement supply, where the equipment does not have its own power source:
  - (a) signal lights;
  - (b) audible warning devices;
  - (c) emergency lighting in accordance with paragraph 3;
  - (d) radiotelephone installations;
  - (e) alarm, loudspeaker and on-board message communications systems;
  - (f) searchlights according to Article 10.02(2)(i);
  - (g) fire alarm system;
  - (h) other safety equipment such as automatic pressurised sprinkler systems or fire extinguishing pumps;
  - (i) lifts and lifting equipment within the meaning of Article 15.06 (9), second sentence.
5. The light fittings for the emergency lighting shall be marked as such.
6. The emergency power plant shall be installed outside the main engine room, outside the rooms housing the power sources referred to in Article 9.02(1), and outside the room where the main switchboard is located; it shall be separated from these rooms by partitions according to Article 15.11(2).

Cables feeding the electrical installations in the event of an emergency shall be installed and routed in such a way as to maintain the continuity of supply of these installations in the event of fire or flooding. These cables shall never be routed through the main engine room, galleys or rooms where the main power source and its connected equipment is installed, except insofar as it is necessary to provide emergency equipment in such areas.

**▼M3**

The emergency power plant shall be installed either above the margin line or as far away as possible from the power sources according to Article 9.02(1), so as to ensure that, in the event of flooding in accordance with Article 15.03(9), it is not flooded at the same time as these power sources.

**▼B**

7. The following are admissible for use as an emergency power source:
  - (a) auxiliary generator sets with their own independent fuel supply and independent cooling system which, in the event of a power failure, turn on and take over the supply of power within 30 seconds automatically or, if they are located in the immediate vicinity of the wheelhouse or any other location permanently manned by crew members, can be turned on manually; or
  - (b) accumulator batteries, which, in the event of a power failure, turn on automatically or, if they are located in the immediate vicinity of the wheelhouse or any other location permanently manned by crew members, can be turned on manually. They shall be capable of powering the abovementioned power consumers throughout the prescribed period without recharging and without an unacceptable voltage reduction.
8. The projected operating period for the emergency power supply is to be defined according to the defined purpose of the passenger vessel. It shall not be less than 30 minutes.
9. The insulation resistances and the earthing for electrical systems shall be tested on the occasion of inspections according to Article 2.09.
10. The power sources according to Article 9.02(1), shall be independent of each other.
11. A failure of the main or emergency power equipment shall not mutually affect the operational safety of the installations.

*Article 15.11***Fire protection**

1. The suitability for fire protection of materials and components shall be established by an accredited test institution on the basis of appropriate test methods.
  - (a) The test institution shall satisfy:
    - (aa) the Code for Fire Test Procedures; or
    - (bb) European standard EN ISO/IEC 17025: 2000 concerning the general requirements for the competence of testing and calibration laboratories.
  - (b) The recognised test methods for determining the non-flammability of materials are:
    - (aa) Annex 1, Part 1, of the Code for Fire Test Procedures; and
    - (bb) the equivalent regulations of one of the Member States.
  - (c) The recognised test methods for determining that a material is flame-retardant are:
    - (aa) the respective requirements laid down in Annex 1, Parts 5 (Surface flammability test), 6 (Test for the deck coverings), 7 (Test for hanging textiles and plastics), 8 (Test for upholstered furniture) and 9 (Test for components of bedding) of the Code for Fire Test Procedures; and
    - (bb) the equivalent regulations of one of the Member States.
  - (d) The recognised test methods for determining fire resistance are:
    - (aa) Annex I, part 3, of the Code for Fire Test Procedures, and
    - (bb) the equivalent regulations of one of the Member States.

**▼M3****▼B**

▼ **M3**

- (e) The inspection body may, in accordance with the Code for Fire Test Procedures, prescribe a test on a sample partition in order to ensure compliance with the provisions of paragraph 2 on resistivity and temperature increase.

## 2. Partitions

- (a) Partitions between rooms shall be designed in accordance with the following tables:

- (aa) Table for partitions between rooms, in which no pressurised sprinkler systems according to Article 10.03a are installed.

Rooms	Control centres	Stairwells	Muster areas	Lounges	Engine rooms	Galleys	Store rooms
Control centres	—	A0	A0/B15 <sup>(1)</sup>	A30	A60	A60	A60
Stairwells		—	A0	A30	A60	A60	A60
Muster areas			—	A30/B15 <sup>(2)</sup>	A60	A60	A60
Lounges				—/B15 <sup>(3)</sup>	A60	A60	A60
Engine rooms					A60/A0 <sup>(4)</sup>	A60	A60
Galleys						A0	A60/B15 <sup>(5)</sup>
Store rooms							—

<sup>(1)</sup> Partitions between control centres and internal muster areas shall correspond to Type A0, but external muster areas only to Type B15.

<sup>(2)</sup> Partitions between lounges and internal muster areas shall correspond to Type A30, but external muster areas only to Type B15.

<sup>(3)</sup> Partitions between cabins, partitions between cabins and corridors and vertical partitions separating lounges according to section 10 shall comply with Type B15, for rooms fitted with pressurised sprinkler systems B0.

<sup>(4)</sup> Partitions between engine rooms according to Articles 15.07 and 15.10, section 6, shall comply with Type A60; in other cases they shall comply with Type A0.

<sup>(5)</sup> B15 is sufficient for partitions between galleys, on the one hand, and cold-storage rooms and food store rooms, on the other.

- (bb) Table for partitions between rooms, in which pressurised sprinkler systems according to Article 10.03a are installed

Rooms	Control centres	Stairwells	Muster areas	Lounges	Engine rooms	Galleys	Store rooms
Control centres	—	A0	A0/B15 <sup>(1)</sup>	A0	A60	A30	A30
Stairwells		—	A0	A0	A60	A30	A0
Muster areas			—	A30/B15 <sup>(2)</sup>	A60	A30	A30
Lounges				—/B0 <sup>(3)</sup>	A60	A30	A0
Engine rooms					A60/A0 <sup>(4)</sup>	A60	A60
Galleys						—	B15
Store rooms							—

<sup>(1)</sup> Partitions between control centres and internal muster areas shall correspond to Type A0, but external muster areas only to Type B15.

<sup>(2)</sup> Partitions between lounges and internal muster areas shall correspond to Type A30, but external muster areas only to Type B15.

<sup>(3)</sup> Partitions between cabins, partitions between cabins and corridors and vertical partitions separating lounges according to section 10 shall comply with Type B15, for rooms fitted with pressurised sprinkler systems B0.

<sup>(4)</sup> Partitions between engine rooms according to Articles 15.07 and 15.10, section 6, shall comply with Type A60; in other cases they shall comply with Type A0.

**▼M3**

- (b) Type A partitions are bulkheads, walls and decks which satisfy the following requirements:
- (aa) They are made of steel or of another equivalent material;
  - (bb) They are appropriately stiffened;
  - (cc) They are insulated with an approved non-combustible material such that the average temperature on the side facing away from the fire rises to not more than 140 °C above the initial temperature and at no point, including the gaps at the joints, does a temperature increase of more than 180 °C above the initial temperature occur within the following specified periods:
    - Type A60 — 60 minutes
    - Type A30 — 30 minutes
    - Type A0 — 0 minutes;
  - (dd) they are constructed in such a way as to prevent the transmission of smoke and flames until the end of the one-hour normal fire test;
- (c) Type B partitions are bulkheads, walls, decks, ceilings or facings that meet the following requirements:
- (aa) they are made of an approved non-combustible material. Furthermore, all materials used in the manufacture and assembly of partitions shall be non-combustible, except for the facing, which shall be at least flame retardant;
  - (bb) they demonstrate an insulation value such that the average temperature on the side facing away from the fire rises to not more than 140 °C above the initial temperature and at no point, including the gaps at the joints, does a temperature increase of more than 225 °C above the initial temperature occur within the following specified periods:
    - Type B15 — 15 minutes
    - Type B0 — 0 minutes;
  - (cc) they are constructed in such a way as to prevent the transmission of flames until the end of the first half hour of the normal fire test.

**▼B**

3. Paints, lacquers and other surface treatment products as well as deck coverings used in rooms except engine rooms and store rooms shall be flame-retardant. Carpets, fabrics, curtains and other hanging textile materials as well as upholstered furniture and components of bedding shall be flame-retardant if the rooms in which they are located are not equipped with a pressurised sprinkler system according to Article 10.03a.
4. Lounge ceilings and wall claddings, including their substructures, shall, where these lounges do not have a pressurised sprinkler system according to Article 10.03a, be manufactured from non-combustible materials with the exception of their surfaces, which shall be at least flame-retardant.
5. Furniture and fittings in lounges which serve as muster areas shall, where the rooms do not have a pressurised sprinkler system according to Article 10.03a, be manufactured from non-combustible materials.
6. Paints, lacquers and other materials used on exposed internal areas shall not produce excessive amounts of smoke or toxic substances. This shall be proven in accordance with the Code for Fire Test Procedures.
7. Insulation materials in lounges shall be non-combustible. This does not apply to insulations used on coolant-carrying pipes. The surfaces of the insulation materials used on these pipes shall be at least flame-retardant.
8. Doors in partitions according to paragraph 2 shall satisfy the following requirements:
  - (a) they shall satisfy the same requirements set out in paragraph 2 as the partitions themselves;
  - (b) they shall be self-closing in the case of doors in partition walls according to paragraph 10 or in the case of enclosures around engine rooms, galleys and stairwells;

**▼B**

- (c) self-closing doors which remain open in normal operation shall be such that they can be closed from a location permanently manned by shipboard personnel or crew members; Once a door has been remotely closed, it shall be possible to reopen and close it safely on the spot;
  - (d) watertight doors according to Article 15.02 need not be insulated.
9. Walls according to paragraph 2 shall be continuous from deck to deck or end at continuous ceilings, which satisfy the same requirements as referred to in paragraph 2.
10. The following passenger areas shall be divided by vertical partitions as referred to in paragraph 2:
- (a) passenger areas with a total surface area of more than 800 m<sup>2</sup>;
  - (b) passenger areas in which there are cabins, at intervals of not more than 40 m.
- The vertical partitions shall be smoke-tight under normal operating conditions and shall be continuous from deck to deck.
11. Hollows above ceilings, beneath floors and behind wall claddings shall be separated at intervals of not more than 14 m by non-combustible draught stops which, even in the event of fire, provide an effective fireproof seal.
12. Stairs shall be made of steel or another equivalent non-combustible material.
13. Internal stairs and lifts shall be encapsulated at all levels by walls according to paragraph 2. The following exceptions are permissible:
- (a) a staircase connecting only two decks does not need to be encapsulated, if on one of the decks the staircase is enclosed according to paragraph 2;
  - (b) in a lounge, stairs need not be encapsulated if they are located entirely within the interior of this room, and
    - (aa) if this room extends over only two decks, or
    - (bb) if there is a pressurised sprinkler system according to Article 10.03a installed in this room on all decks, this room has a smoke extraction system according to paragraph 16 and the room has access on all decks to a stairwell.
14. Ventilation systems and air supply systems shall satisfy the following requirements:
- (a) they shall be designed in such a way as to ensure that they themselves do not cause the spread of fire and smoke;
  - (b) openings for air intake and extraction and air supply systems shall be such that they can be closed off;
  - (c) ventilation ducts shall be made from steel or an equivalent non-combustible material and be securely connected to each other and to the superstructure of the vessel;
  - (d) when ventilation ducts with a cross-section of more than 0,02 m<sup>2</sup> are passed through partitions according to paragraph 2 of Type A or partitions according to paragraph 10, they shall be fitted with automatic fire dampers which can be operated from a location permanently manned by shipboard personnel or crew members;
  - (e) ventilation systems for galleys and engine rooms shall be separated from ventilation systems which supply other areas;
  - (f) air extraction ducts shall be provided with lockable openings for inspection and cleaning. These openings shall be located close to the fire dampers;
  - (g) built-in ventilators shall be such that they can be switched off from a central location outside the engine room.
15. Galleys shall be fitted with ventilation systems and stoves with extractors. The air extraction ducts of the extractors shall satisfy the requirements according to paragraph 14 and, additionally, be fitted with manually operated fire dampers at the inlet openings.

**▼B**

16. Control centres, stairwells and internal evacuation areas shall be fitted with natural or mechanical smoke extraction systems. Smoke extraction systems shall satisfy the following requirements:
- (a) they shall offer sufficient capacity and reliability;
  - (b) they shall comply with the operating conditions for passenger vessels;
  - (c) if smoke extraction systems also serve as general ventilators for the rooms, this shall not hinder their function as smoke extraction systems in the event of a fire;
  - (d) smoke extraction systems shall have a manually operated triggering device;
  - (e) mechanical smoke extraction systems shall additionally be such that they can be operated from a location permanently manned by shipboard personnel or crew members;
  - (f) natural smoke extraction systems shall be fitted with an opening mechanism, operated either manually or by a power source inside the extraction system;
  - (g) manually operated triggering devices and opening mechanisms shall be accessible from inside or outside the room being protected.
17. Lounges not constantly supervised by shipboard personnel or crew members, galleys, engine rooms and other rooms presenting a fire risk shall be connected to an appropriate fire alarm system. The existence of a fire and its exact whereabouts shall be automatically displayed at a location permanently manned by shipboard personnel or crew members.

*Article 15.12***Fire-fighting**

1. In addition to the portable extinguishers according to Article 10.03, at least the following portable extinguishers shall be available on board:
- (a) one portable extinguisher for every 120 m<sup>2</sup> of gross floor area in passenger areas;
  - (b) one portable extinguisher per group of 10 cabins, rounded upwards;
  - (c) one portable extinguisher in each galley and in the vicinity of any room in which flammable liquids are stored or used. In galleys the extinguishing agent shall also be suitable for fighting fat fires.

These additional fire extinguishers shall meet the requirements laid down in Article 10.03, paragraph 2, and be installed and distributed on the vessel so that, in the event of a fire starting at any point and at any time, a fire extinguisher can be reached immediately. In every galley and also in hair-dressing salons and perfumeries, there shall be a fire blanket to hand.

2. Passenger vessels shall be provided with a hydrant system consisting of:
- (a) two motor-driven fire extinguishing pumps of sufficient capacity, at least one of which is permanently installed;
  - (b) one fire extinguisher line with a sufficient number of hydrants with permanently connected fire hoses at least 20 m in length and fitted with a nozzle capable of producing both a mist and a jet of water and incorporating a shut-off facility.
3. Hydrant systems shall be designed and dimensioned in such a way that:
- (a) any point of the vessel can be reached from at least two hydrants in different places, each with a single hose length of not more than 20 m;
  - (b) the pressure at the hydrants is at least 300 kPa; and
  - (c) on all decks a water jet length of at least 6 m can be attained.

If a hydrant chest is provided, an 'extinguisher hose' symbol similar to that shown in Figure 5 in Appendix I, of at least 10 cm side length, shall be affixed to the outside of the chest.

4. Hydrant valves with screw threads or cocks shall be such that they can be set so that each of the fire hoses can be separated and removed during operation of the fire extinguishing pumps.

**▼B**

5. Fire extinguisher hoses in the internal area shall be rolled up on an axially connected reel.
6. Materials for fire-fighting equipment shall either be heat-resistant or shall be suitably protected against failure to work when subjected to high temperatures.
7. Pipes and hydrants shall be arranged in such a way that the possibility of freezing is avoided.
8. The fire extinguishing pumps shall:
  - (a) be installed or housed in separate rooms;
  - (b) be such that they can be operated independently of each other;
  - (c) each be capable, on all decks, of maintaining the necessary pressure at the hydrants and achieving the requisite length of water jet;
  - (d) be installed forward of the aft bulkhead.

Fire extinguishing pumps may also be used for general purposes.
9. Engine rooms shall be fitted with a permanently fitted fire extinguishing system according to Article 10.03b.
10. On cabin vessels there shall be:
  - (a) two self-contained breathing apparatus sets corresponding to European standard EN 137: 1993 with full-face masks corresponding to European standard EN 136: 1998;
  - (b) two sets of equipment consisting of at least a protective suit, helmet, boots, gloves, axe, crowbar, torch and safety-line, and
  - (c) four smoke hoods.

*Article 15.13***Safety organisation**

1. A safety rota shall be provided on board passenger vessels. The safety rota describes the duties of the crew and the shipboard personnel in the following eventualities:
  - (a) breakdown;
  - (b) fire on board;
  - (c) evacuation of passengers;
  - (d) person overboard.

Specific safety measures for persons with reduced mobility shall be taken into consideration.

The crew members and shipboard personnel designated in the safety rota should be assigned their various duties, depending on the posts they occupy. Special instructions to the crew shall ensure that, in the event of danger, all doors and openings in the watertight bulkheads referred to in Article 15.02 will be hermetically closed immediately.
2. The safety rota includes a safety plan, in which at least the following are clearly and precisely designated:
  - (a) areas intended for use by persons with reduced mobility;
  - (b) escape routes, emergency exits and muster and evacuation areas as referred to in Article 15.06(8);
  - (c) life-saving equipment and ship's boats;
  - (d) fire extinguishers and fire extinguishing and pressurised sprinkler systems;
  - (e) other safety equipment;
  - (f) the alarm system referred to in Article 15.08(3)(a);
  - (g) the alarm system referred to in Article 15.(3)(b) and (c);



**▼ B**

- (h) the bulkhead doors referred to in Article 15.02(5), and the position of their controls, as well as the other openings referred to in Article 15.02(9), (10) and (13), and Article 15.03(12);
  - (i) doors referred to in Article 15.11(8);
  - (j) fire dampers;
  - (k) fire alarm system;
  - (l) emergency power plant;
  - (m) ventilation system control units;
  - (n) shore connections;
  - (o) fuel line shut-offs;
  - (p) liquefied gas installations;
  - (q) public address systems;
  - (r) radiotelephone equipment;
  - (s) first-aid kits.
3. The safety rota according to paragraph 1 and the safety plan according to paragraph 2 shall:
- (a) be duly stamped by the inspection body, and
  - (b) be prominently displayed at an appropriate point on each deck.
4. A code of conduct for passengers shall be posted up in each cabin and also a simplified safety plan containing only the information referred to in paragraph 2(a) to (f).

This code of conduct shall include at least:

- (a) designation of emergencies
  - fire,
  - flooding,
  - general hazard;
- (b) description of the various alarm signals;
- (c) instructions concerning the following:
  - escape routes,
  - what to do,
  - need to keep calm;
- (d) instructions concerning the following:
  - smoking,
  - use of fire and naked flame,
  - opening windows,
  - use of certain items of equipment.

These details shall be posted up in Dutch, English, French and German.

*Article 15.14*

**Waste water collection and disposal facilities**

1. Passenger vessels shall be equipped with waste water collecting tanks or appropriate on-board sewage treatment systems.
2. Waste water collection tanks shall have sufficient capacity. Tanks shall be fitted with a device to indicate their content level. There shall be on-board pumps and pipes for emptying the tanks, whereby waste water can be passed from both sides of the vessel. It shall be possible to pass waste water from other vessels through.

The pipes shall be fitted with a discharge connection according to European standard EN 1306: 1996.

**▼B***Article 15.15***Derogations for certain passenger vessels**

1. ► **M3** Passenger vessels authorised to carry up to a maximum of 50 passengers and with a length  $L_{WL}$  of not more than 25 m shall prove adequate stability after damage according to Article 15.03(7 to 13) or, as an alternative, prove that they comply with the following criteria after symmetrical flooding: ◀

**▼M3**

- (a) the immersion of the vessel shall not exceed the margin line and

**▼B**

- (b) the metacentric height  $GM_R$  shall not be less than 0,10 m.

The necessary residual buoyancy shall be assured through the appropriate choice of material used for the construction of the hull or by means of highly cellular foam floats, solidly attached to the hull. In the case of vessels with a length of more than 15 m, residual buoyancy can be ensured by a combination of floats and subdivision complying with the 1-compartment status according to in Article 15.03.

2. For passenger vessels in accordance with paragraph 1 the inspection body may permit minor derogations from the clear height required in Article 15.06(3)(c) and paragraph 5(b). The derogation shall not be more than 5 %. In the case of derogations the relevant parts shall be indicated by colour.
3. By way of derogation from Article 15.03(9), passenger vessels not exceeding 45 m in length and authorised to carry up to a maximum of 250 passengers do not need to have two-compartment status.
4. (Left void)
5. ► **M3** The inspection body may waive the application of Article 10.04 in the case of passenger vessels authorised to carry up to a maximum of 250 passengers and with a length  $L_{WL}$  of not more than 25 m, provided they are equipped with a platform, accessible from each side of the vessel, directly above the line of flotation, so as to enable persons to be recovered from the water. ◀ Passenger vessels may be equipped with a comparable installation, subject to the following conditions:
  - (a) one person alone shall be able to operate the installation;
  - (b) mobile installations are allowed;
  - (c) the installations shall be outside the danger area of the propulsion systems; and
  - (d) effective communication shall be possible between the boatmaster and the person in charge of the installation.
6. The inspection body may waive the application of Article 10.04 in the case of passenger vessels authorised to carry up to a maximum of 600 passengers and with a length of not more than 45 m, provided they are equipped with a platform according to paragraph 5, first sentence, or with an equivalent installation according to paragraph 5, second sentence. In addition, the passenger vessel shall have:
  - (a) a rudder propeller, a cycloidal propeller or a water jet as main propulsion, or
  - (b) a main propulsion system with two propulsion units, or
  - (c) a main propulsion system and a bow-thruster.
7. By way of derogation from Article 15.02(9), passenger vessels not exceeding 45 m in length and authorised to carry at most a number of passengers corresponding to the length of the vessel in metres are allowed to have on board, in the passenger area, a manually controlled bulkhead door without remote control according to Article 15.02(5), if:
  - (a) the vessel has only one deck;
  - (b) this door is accessible directly from the deck and is not more than 10 m away from the deck;

**▼B**

- (c) the lower edge of the door opening lies at least 30 cm above the floor of the passenger area, and
  - (d) each of the compartments divided by the door is fitted with a bilge level alarm.
8. On passenger vessels in accordance with paragraph 7, by way of derogation from Article 15.06(6)(c), one escape route may lead through a galley, as long as there is a second escape route available.
  9. For passenger vessels with a length not exceeding 45 m the following shall not apply: Article 15.01(2)(e), when the liquefied gas installations are fitted with appropriate alarm systems for CO concentrations posing a health risk and for potentially explosive mixtures of gas and air.
  10. ►**M3** The following provisions shall not apply to passenger vessels with a length  $L_{WL}$  not exceeding 25 m: ◀
    - (a) Article 15.04(1), last sentence;
    - (b) Article 15.06(6)(c), for the galleys, as long as a second escape route is available;
    - (c) Article 15.07.
  11. For cabin vessels not exceeding 45 m in length, Article 15.12(10), shall not apply, provided smoke-hoods in a number corresponding to the number of berths are readily accessible in each cabin.

## CHAPTER 15a

**SPECIFIC REQUIREMENTS FOR PASSENGER SAILING VESSELS***Article 15a.01***Application of Part II**

In addition to the provisions of Part II, the requirements in this Chapter shall apply to passenger sailing vessels.

*Article 15a.02***Exceptions for certain passenger sailing vessels**

1. For passenger sailing vessels having an  $L_{WL}$  not exceeding 45 m and a maximum permissible number of passengers not exceeding  $L_{WL}$  in whole meters, the following provisions shall not apply:
  - (a) Article 3.03(7), provided that anchors are not transported in hawse pipes;
  - (b) Article 10.02(2)(d), with regard to length;
  - (c) Article 15.08(3)(a);
  - (d) Article 15.15(9)(a).
2. By way of derogation from paragraph 1, the number of passengers may be raised to 1,5 times the  $L_{WL}$  in whole meters, if sails, rigging and deck fittings so permit.

*Article 15a.03***Stability requirements for vessels under sail**

1. For the calculation of the heeling moment according to Article 15.03(3), the furled sails shall be taken into account when determining the centre of gravity of the vessel.
2. Taking into consideration all load conditions according to Article 15.03(2), and using a standard arrangement of sails, the heeling moment caused by wind pressure shall not be so high as to exceed a heeling angle of 20°. At the same time
  - (a) a constant wind pressure of 0,07 kN/m<sup>2</sup> shall be applied for the calculation,

**▼B**

- (b) the residual safety clearance shall be at least 100 mm, and
  - (c) the residual freeboard shall not be negative.
3. The righting lever of static stability shall
    - (a) reach its maximum value at a heeling angle of 25° or over,
    - (b) amount to at least 200 mm at a heeling angle of 30° or over,
    - (c) be positive at a heeling angle of up to 60°.
  4. The area under the righting lever curve shall not be less than
    - (a) 0,055 mrad up to 30°;
    - (b) 0,09 mrad up to 40° or at the angle at which an unprotected opening reaches the water surface and which is less than 40°.

Between

- (c) 30° and 40°, or
- (d) 30° and the angle at which an unprotected opening reaches the water surface and which is less than 40°,

this area shall not be less than 0,03 mrad.

*Article 15a.04*

**Shipbuilding and mechanical requirements**

1. By way of derogation from Article 6.01(3), and Article 9.01(3), the equipment must be designed for permanent lists of up to 20°.
2. By way of derogation from Article 15.06(5)(a) and Article 15.06(9)(b), the inspection body may, in the case of passenger sailing vessels not more than 25 m long, authorise a clear width of less than 800 mm for connecting corridors and companionways. However, the clear width shall be at least 600 mm.
3. By way of derogation from Article 15.06(10)(a), the inspection body may, in specific cases, authorise the use of removable guard rails in areas where this is necessary for controlling the sails.
4. Within the meaning of Article 15.07, sails rank as a main propulsion system.
5. By way of derogation from Article 15.15(7)(c), the height of the lower edge of the door opening may be reduced to 200 mm above the floor of the passenger area. Once opened, the door shall close and lock automatically.
6. If there is a possibility of the propeller idling while the vessel is under sail, any endangered parts of the propulsion system shall be protected against potential damage.

*Article 15a.05*

**Rigging in general**

1. The parts of the rigging shall be arranged in such a way as to prevent unacceptable chafing.
2. If a material other than wood is used or if special types of rigging are used, such a design shall guarantee equivalent levels of safety with the dimensions and strength values laid down in this Chapter. As evidence of the strength
  - (a) a strength calculation shall be carried out, or
  - (b) confirmation of sufficient strength shall have been obtained from an approved classification society, or
  - (c) dimensioning shall be based on the procedures set out in a recognised regulatory framework (e.g. Middendorf, Kusk-Jensen).

The evidence shall be presented to the inspection body.

**▼B***Article 15a.06***Masts and spars in general**

1. All spars shall be made of high-quality material.
2. Wood for masts shall:
  - (a) be free of knot concentrations;
  - (b) be free of sapwood within the required dimensions;
  - (c) as far as possible be straight-grained;
  - (d) contain as little as possible twisted growth.
3. If the chosen timber is either pitch pine or Oregon pine of quality level 'clear and better' the diameters in the tables reproduced in Articles 15a.07 to 15a.12 can be reduced by 5 %.
4. If the timbers used for masts, topmasts, yardarms, booms and bowsprits are not round in cross-section, such timbers must be of equivalent strength.
5. Mast pedestals, mast trunks and fastenings on deck, on floor-plates and on stem or stern shall be constructed in such a way that they can either absorb the forces they are subjected to or transfer them to other connected parts of the structure.
6. Depending on the stability of the vessel and the external forces it is subjected to and also the distribution of the available sail area, the inspection body may, on the basis of the dimensions laid down in Articles 15a.07 to 15a.12, allow reductions in the cross-sections of the spars and, where appropriate, of the rigging. Evidence shall be submitted in accordance with Article 15a.05(2).
7. If the vessel's period of oscillation/period of roll, in seconds, is less than three quarters of its breadth, in metres, the dimensions set out in Articles 15a.07 to 15a.12 shall be increased. Evidence shall be submitted in accordance with Article 15a.05(2).
8. In the tables reproduced in Articles 15a.07 to 15a.12 and 15a.14, possible intermediate values shall be interpolated.

*Article 15a.07***Special provisions for masts**

1. Wooden masts shall meet the following minimum requirements:

Length (*) (m)	Diameter on deck (cm)	Diameter on the cross-tree (cm)	Diameter on the mast cap (cm)
10	20	17	15
11	22	17	15
12	24	19	17
13	26	21	18
14	28	23	19
15	30	25	21
16	32	26	22
17	34	28	23
18	36	29	24
19	39	31	25
20	41	33	26
21	43	34	28
22	44	35	29
23	46	37	30

**▼B**

Length (*) (m)	Diameter on deck (cm)	Diameter on the cross-tree (cm)	Diameter on the mast cap (cm)
24	49	39	32
25	51	41	33

(\*) Distance from the cross-tree to the deck.

If a mast has two yards, the diameters shall be increased by at least 10 %.

If a mast has more than two yards, the diameters shall be increased by at least 15 %.

In the case of masts fitted through the deck, the diameter at the mast foot shall be at least 75 % of the diameter of the mast at deck level.

- Mast fittings, mast bands, cross-trees and mast caps shall be sufficiently strongly dimensioned and attached.

*Article 15a.08***Special provisions for topmasts**

- Wooden topmasts shall meet the following minimum requirements:

Length (*) (m)	Diameter at the foot (cm)	Half-length diameter (cm)	Diameter at fitting (**) (cm)
4	8	7	6
5	10	9	7
6	13	11	8
7	14	13	10
8	16	15	11
9	18	16	13
10	20	18	15
11	23	20	16
12	25	22	17
13	26	24	18
14	28	25	20
15	31	27	21

(\*) Total length of the topmast, without the masthead.

(\*\*) Diameter of the topmast at the level of the masthead fitting.

If square sails are attached to a topmast, the dimensions set out in the table shall be increased by 10 %.

- The overlap between the topmast and the mast shall be at least 10 times the required foot diameter of the topmast.

*Article 15a.09***Special provisions for bowsprits**

- Wooden bowsprits shall meet the following minimum requirements:

Length (*) (m)	Diameter at stem (cm)	Half-length diameter (cm)
4	14,5	12,5
5	18	16

**▼B**

Length (*) (m)	Diameter at stem (cm)	Half-length diameter (cm)
6	22	19
7	25	23
8	29	25
9	32	29
10	36	32
11	39	35
12	43	39

(\*) Total length of the bowsprit.

- The inboard section of the bowsprit shall have a length of at least four times the diameter of the bowsprit at the stem.
- The diameter of the bowsprit at its head shall be at least 60 % of the diameter of the bowsprit at the stem.

*Article 15a.10***Special provisions for jib-booms**

- Wooden jib-booms shall meet the following minimum requirements:

Length (*) (m)	2	3	4	5	6	7	8	9	10
Diameter at the stem (cm)	7	10	14	17	21	24	28	31	35

(\*) Total length of the jib-boom.

- The diameter of the jib-boom at its head shall be at least 60 % of the diameter at the stem.

*Article 15a.11***Special provisions for main booms**

- Wooden main booms shall meet the following minimum requirements:

Length (*) (m)	5	6	7	8	9	10	11	12	13	14	15	16
Diameter (cm)	14	15	16	17	18	20	21	23	24	25	26	27

(\*) Total length of the main boom.

- The diameter at the swivel pin shall be at least 72 % of the diameter specified in the table.
- The diameter at the clew shall be at least 85 % of the diameter specified in the table.
- Measured from the mast, the greatest diameter shall be at two thirds of the length.
- Where:
  - there is an angle of less than 65° between the main boom and the after leech and the main sheet is attached to the end of the boom, or
  - the attachment point of the sheet is not abreast of the clew,
 the inspection body may, according to Article 15a.05(2), require a greater diameter.
- For sail areas of less than 50 m<sup>2</sup>, the inspection body may authorise reductions in the dimensions set out in the table.

**▼B***Article 15a.12***Special provisions for gaffs**

1. Wooden gaffs shall meet the following minimum requirements:

Length (*) (m)	4	5	6	7	8	9	10
Diameter (cm)	10	12	14	16	17	18	20

(\*) Total length of the gaff.

2. The unsupported length of the gaff shall be not more than 75 %.
3. The breaking strength of the crowfoot shall be at least equal to 1,2 times the breaking strength of the peak halyard.
4. The top angle of the crowfoot shall be a maximum of 60°.
5. If, by way of derogation from paragraph 4, the top angle of the crowfoot is greater than 60°, the tensile strength shall be adjusted to accommodate the forces that will then occur.
6. For sail areas of less than 50 m<sup>2</sup>, the inspection body may authorise reductions in the dimensions set out in the table.

*Article 15a.13***General provisions for standing and running rigging**

1. Standing and running rigging shall comply with the strength requirements set out in Articles 15a.14 and 15a.15.
2. Wire cable connections may take the form of:
- splicings,
  - compression sleeves, or
  - sealing sleeves.
- Splicings shall be marled and ends shall be whipped.
3. Eye splices shall be provided with thimbles.
4. Ropes shall be routed in such a way as not to obstruct entrances and companionways.

*Article 15a.14***Special provisions for standing rigging**

1. Forestays and shrouds shall meet the following minimum requirements:

Mast length (*) (m)	11	12	13	14	15	16	17	18
Tensile strength of the forestay (kN)	160	172	185	200	220	244	269	294
Tensile strength of the shrouds (kN)	355	415	450	485	525	540	630	720
Number of shroud cables and ropes per side	3	3	3	3	3	3	4	4

(\*) Distance from the top or cross-tree to the deck.

2. Backstays, topmasts, flying jib-stays, jib-booms and bowsprit shrouds shall meet the following minimum requirements:

Mast length (*) (m)	<13	13-18	>18
Tensile strength of the backstay (kN)	89	119	159



**▼B**

Tensile strength of the topmast (kN)	89	119	159
Length of topmast (m)	<6	6-8	>8
Tensile strength of the flying jib-stay (kN)	58	89	119
Length of jib-boom (m)	<5	5-7	>7
Tensile strength of the bow sprit shrouds (kN)	58	89	119

(\*) Distance from the top or cross-tree to the deck.

- The preferred rope design shall be based on Rope Construction Method  $6 \times 7$  FE in the strength class  $1\,550\text{ N/mm}^2$ . Alternatively, at the same strength class, Construction Method  $6 \times 36$  SE or  $6 \times 19$  FE may be used. Because of the higher elasticity of Construction Method  $6 \times 19$ , the tensile strengths given in the table shall be increased by 10 %. Use of a different rope design shall be permitted provided it has comparable properties.
- If rigid rigging is used, the tensile strengths shown in the table shall be increased by 30 %.
- For rigging, only approved forks, round eyes and bolts may be used.
- Bolts, forks, round eyes and turnbuckles shall be capable of being properly secured.
- The tensile strength of the bobstay shall be at least 1,2 times the tensile strength of the respective jib-stay and flying jib-stay.
- For vessels with less than  $30\text{ m}^3$  water displacement, the inspection body may permit the reductions in tensile strengths shown in the table set out below:

Water displacement divided by the number of masts ( $\text{m}^3$ )	Reduction (%)
>20 to 30	20
10 to 20	35
< 10	60

*Article 15a.15***Special provisions for running rigging**

- For running rigging, fibre ropes or steel wire ropes shall be used. The minimum tensile strength and the diameter for running rigging shall, in relation to the sail area, meet the following minimum requirements:

Type of running rigging	Rope material	Sail area ( $\text{m}^2$ )	Minimum tensile strength (KN)	Diameter of rope (mm)
Staysail halyards	Steel wire	up to 35	20	6
		> 35	38	8
	Fibre (polypropylene-PP)	Rope diameter of at least 14 mm and one rope sheave for every $25\text{ m}^2$ or part thereof		
Gaff sail halyards Top sail halyards	Steel wire	up to 50	20	6
		> 50 to 80	30	8
		> 80 to 120	60	10
		>120 to 160	80	12
	Fibre (PP)	Rope diameter of at least 18 mm and one rope sheave for every $30\text{ m}^2$ or part thereof		

**▼B**

Type of running rigging	Rope material	Sail area (m <sup>2</sup> )	Minimum tensile strength (KN)	Diameter of rope (mm)
Staysail sheets	Fibre (PP)	up to 40	14	
		> 40	18	
	For sail areas of more than 30 m <sup>2</sup> , the sheet shall take the form of a tackle or shall be capable of being operated by a winch			
Gaff-/Top-sail sheets	Steel wire	< 100	60	10
		100 to 150	85	12
		> 150	116	14
	For top sail sheets, elastic connection elements (fore runners) are necessary.			
	Fibre (PP)	Rope diameter of at least 18 mm and at least three rope sheaves. Where the sail area is greater than 60 m <sup>2</sup> , one rope sheave per 20 m <sup>2</sup>		

- Running rigging forming part of the staying shall have a tensile strength which corresponds to that of the respective stay or shrouds.
- If materials other than those stated in paragraph 1 are used, the strength values given in the table in paragraph 1 shall be complied with.

Fibre ropes of polyethylene shall not be used.

*Article 15a.16***Fittings and parts of the rigging**

- If steel wire ropes or fibre ropes are used, the diameters of the rope sheaves (measured from centre of rope to centre of rope) shall meet the following minimum requirements:

Steel wire (mm)	6	7	8	9	10	11	12
Fibre (mm)	16	18	20	22	24	26	28
Rope sheave (mm)	100	110	120	130	145	155	165

- By way of derogation from paragraph 1, the diameter of the rope sheaves may be equal to six times the diameter of the steel wire, provided that the steel wire does not constantly run over sheaves.
- The tensile strength of the fittings (e.g. forks, round eyes, turnbuckles, eye-plates, bolts, rings and shackles) shall be compatible with the tensile strength of the standing or running rigging that is attached to them.
- The fastenings of stay and shroud futtocks shall be designed to take up the forces they are subjected to.
- Only one shackle, along with the relevant stay or shroud, may be attached to each eye.
- Blocks of halyards and topping lifts shall be securely fastened to the mast, and the revolving crowfeet used for this purpose shall be in good condition.
- Attachments of eye-bolts, cleats, belaying pins and fife-rails shall be designed to cope with the forces they are subjected to.

*Article 15a.17***Sails**

- It shall be ensured that sails can be taken in simply, swiftly and safely.
- The sail area shall be appropriate for the type of vessel and the water displacement.

**▼B***Article 15a.18***Equipment**

1. Vessels that are fitted with a jib-boom or a bowsprit shall have a jib-net and an adequate number of appropriate holding and tensioning devices.
2. The equipment according to paragraph 1 may be dispensed with if the jib-boom or bowsprit is equipped with a hand becket and a foot rope adequately dimensioned to allow for the attachment of a safety harness to be carried on board.
3. For work on the rigging, a boatswain's chair shall be provided.

*Article 15a.19***Testing**

1. The rigging shall be tested by the inspection body every 2,5 years. As a minimum, the test shall cover the following:
  - (a) the sails, including leeches, clews and reef eyes;
  - (b) the state of the masts and spars;
  - (c) the state of the standing and running rigging together with cable wire connections;
  - (d) facilities for taking in the sail swiftly and safely;
  - (e) the secure fastening of blocks of halyards and topping lifts;
  - (f) the fastening of mast trunks and other fastening points for standing and running rigging that are attached to the vessel;
  - (g) the winches for operating the sails;
  - (h) other facilities fitted for the purposes of sailing, such as lee-boards and the fittings for operating them;
  - (i) the measures taken to prevent the chafing of the spars, the running and standing rigging and the sails;
  - (j) the equipment according to Article 15a.18.
2. That part of the wooden mast passing through the deck and located below the deck shall be re-examined at intervals to be determined by the inspection body, but at the very least on the occasion of each periodical inspection according to Article 2.09. The mast shall be extracted for this purpose.
3. A certificate of the last inspection carried out in accordance with paragraph 1 and issued, dated and signed by the inspection body, shall be carried on board.

## CHAPTER 16

**SPECIFIC REQUIREMENTS APPLICABLE TO CRAFT INTENDED  
TO FORM PART OF A PUSHED OR TOWED CONVOY OR OF A  
SIDE-BY-SIDE FORMATION**

*Article 16.01***Craft suitable for pushing**

1. Craft which are to be used for pushing purposes shall incorporate a suitable pushing device. They shall be designed and equipped in such a way as to:
  - (a) enable crews easily and safely to cross over to the pushed craft with the coupling devices connected;
  - (b) enable them to occupy a fixed position in relation to the coupled craft;
  - (c) prevent relative movement between the craft themselves.

**▼B**

2. If the craft are joined together with cables the pusher craft shall be equipped with at least two special winches or equivalent coupling devices for tensioning the cables.
3. The coupling devices shall enable a rigid assembly to be formed with the pushed craft.

Where convoys consist of a pusher craft and a single pushed craft the coupling devices may permit controlled articulation. The necessary drive units shall easily absorb the forces to be transmitted and shall be capable of being controlled easily and safely. Articles 6.02 to 6.04 shall apply *mutatis mutandis* to such drive units.

4. The collision bulkhead referred to in Article 3.03(1)(a), can be dispensed with for pushers.

*Article 16.02***Craft suitable for being pushed**

1. The following shall not apply to lighters without steering system, accommodation, engine or boiler rooms:
  - (a) Chapters 5 to 7 and 12;
  - (b) Article 8.08(2) to (8), Article 10.02 and Article 10.05(1).

If steering systems, accommodation, engine or boiler rooms are present the relevant requirements of this Annex shall apply to them.

2. In addition, ship-borne lighters whose length L does not exceed 40 m shall meet the following requirements:
  - (a) collision bulkheads referred to in Article 3.03(1), can be dispensed with if their front faces are able to bear a load at least 2,5 times that set for the collision bulkheads on inland waterway vessels with the same draught and built in accordance with the requirements of an approved classification society;
  - (b) by way of derogation from Article 8.08(1), compartments of the double bottom to which access is difficult do not have to be drainable unless their volume exceeds 5 % of the water displacement of the ship-borne lighter at the maximum authorised loaded draught.
3. Craft intended for being pushed shall be fitted with coupling devices ensuring a safe connection to other craft.

*Article 16.03***Craft suitable for propelling side-by-side formations**

Craft intended to propel side-by-side formations shall be equipped with bollards or equivalent devices which, as a result of their number and arrangement, enable the formation to be coupled in a safe manner.

*Article 16.04***Craft suitable for being propelled in convoys**

Craft intended to be propelled in convoys shall be equipped with coupling devices, bollards or equivalent devices which, as a result of their number and arrangement, ensure a safe connection to other craft in the convoy.

*Article 16.05***Craft suitable for towing**

1. Craft intended for towing shall meet the following requirements:
  - (a) the towing devices shall be arranged in such a way that their use does not compromise the safety of the craft, crew or cargo;
  - (b) tugging and towing craft shall be fitted with a tow hook which shall be capable of being released safely from the wheelhouse; this shall not apply if the design or other fittings prevent capsizing;

**▼B**

- (c) towing devices shall consist of winches or a tow hook. The towing devices shall be located ahead of the propeller plane. This requirement shall not apply to craft that are steered by their propulsion units such as rudder propellers or cycloidal propellers;
  - (d) by way of derogation from the requirements of (c), for craft solely giving — in accordance with applicable navigational authority regulations of the Member States — towing assistance to motorised craft, a towing device such as a bollard or an equivalent device shall suffice. Point (b) shall apply *mutatis mutandis*;
  - (e) where the towing cables could snag on the stern of the vessel, deflector hoops with cable catchers shall be provided.
2. Craft of length L exceeding 86 m shall not be authorised for towing downstream.

*Article 16.06***Navigation tests on convoys**

1. In order to authorise a pusher or motor vessel to propel a rigid convoy, and to enter this on the Community certificate, the inspection body shall decide which formations are to be presented and shall conduct the navigation tests referred to in Article 5.02 with the convoy in the formation(s) applied for, which the inspection body regards to be the least favourable one(s). The requirements set out in Articles 5.02 to 5.10 shall be met by this convoy.

The inspection body shall check that the rigid connection of all craft in the convoy is maintained during the manoeuvres required by Chapter 5.

2. If during the navigation tests referred to in paragraph 1 there are specific installations on board the craft that are being either pushed or propelled side-by-side, such as the steering system, propulsion units or manoeuvring equipment, or articulated couplings in order to meet the requirements set out in Articles 5.02 to 5.10, the following shall be entered on the Community certificate for the craft propelling the convoy: formation, position, name and ►M3 European Vessel Identification Number ◀ of those craft which are fitted with the specific installations used.

*Article 16.07***Entries on the Community certificate**

1. If a craft is intended to propel a convoy, or be propelled in a convoy, its compliance with the relevant requirements as set out in Articles 16.01 to 16.06 shall be entered on the Community certificate.
2. The following information shall be entered on the Community certificate for the propelling craft:
- (a) the convoys and formations that have been accepted;
  - (b) the types of coupling;
  - (c) the maximum coupling forces determined, and
  - (d) where appropriate, the minimum tensile strength of the coupling cables for the longitudinal connection and also the number of cable windings.

## CHAPTER 17

**SPECIFIC REQUIREMENTS APPLICABLE TO FLOATING EQUIPMENT***Article 17.01***General**

For construction and equipment of floating equipment Chapters 3, 7 to 14 and 16 shall apply. Floating equipment with its own means of propulsion shall also meet the requirements of Chapters 5 and 6. Propulsion units permitting only short-haul operation shall not constitute own means of propulsion.

**▼B***Article 17.02***Derogations**

1. The inspection body may grant derogations from the following requirements:
  - (a) Article 3.03(1) and (2), shall apply *mutatis mutandis*;
  - (b) Article 7.02 shall apply *mutatis mutandis*;
  - (c) the maximum sound pressure levels prescribed by Article 12.02 (5), second sentence, may be exceeded while the floating equipment's working gear is operating, provided that, during service, nobody sleeps on board at night;
  - (d) derogations may be granted from other requirements concerning structure, working gear or equipment provided that equal safety is ensured in each case.
2. The inspection body may dispense with the application of the following requirements:
  - (a) Article 10.01(1), shall not apply if during operation of floating equipment that equipment can be securely anchored by means of a working anchor or piles. However, floating equipment with its own means of propulsion shall have at least one anchor meeting the requirements in Article 10.01 (1), where an empirical coefficient *k* is taken to be equal to 45, and the smallest height is taken for *T*;
  - (b) Article 12.02(1), second part of sentence, if the accommodation can be adequately lit by means of electricity.
3. In addition, the following shall apply:
  - (a) for Article 8.08(2), second sentence, the bilge pump shall be motor driven;
  - (b) for Article 8.10(3), the noise may exceed 65 dB(A) at a lateral distance of 25 m from the ship's side of any stationary floating equipment while its working gear is operating;
  - (c) for Article 10.03(1), at least one further portable extinguisher is required if working gear not permanently attached to the craft is placed on the deck;
  - (d) for Article 14.02(2), in addition to the liquefied-gas equipment for domestic use, there may also be other liquefied-gas facilities. Those facilities and their accessories shall meet the requirements of one of the Member States.

*Article 17.03***Additional requirements**

1. Floating equipment on which persons are present during operation shall be fitted with a general alarm system. The alarm signal shall be clearly distinguishable from other signals and, within accommodation and at all work stations, shall produce a sound pressure level that is at least 5 dB(A) higher than the maximum local sound pressure level. It shall be possible to actuate the alarm system from the wheelhouse and the main work stations.
2. Working equipment shall have sufficient strength to withstand the loads it is subjected to and shall meet the requirements of Directive 98/37/EC of the European Parliament and of the Council of 22 June 1998 on the approximation of the laws of the Member States relating to machinery <sup>(1)</sup>;
3. The stability (resistance to overbalancing) and strength of working equipment, and where appropriate its attachments, shall be such that it may withstand the forces resulting from the expected heel, trim and movement of the floating equipment.

<sup>(1)</sup> OJ L 207, 23.7.1998, p. 1. Directive as amended by Directive 98/79/EC (OJ L 331, 7.12.1998, p. 1).

**▼B**

4. If loads are lifted by means of hoists the maximum authorised load deriving from stability and strength shall be prominently displayed on panels on deck and at the control stations. If the lifting capacity can be increased by connecting additional floats the values authorised both with and without these additional floats shall be clearly stated.

*Article 17.04***Residual safety clearance**

1. For the purposes of this Chapter and by way of derogation from Article 1.01 of this Annex, residual safety clearance means the shortest vertical distance between surface of the water and the lowest part of the floating equipment beyond which it is no longer watertight, taking into account trim and heel resulting from the moments referred to in Article 17.07(4).
2. The residual safety clearance is sufficient according to Article 17.07(1), for any spray-proof and weathertight aperture if it is at least 300 mm.
3. At an aperture that is not spray-proof and weathertight the residual safety clearance shall be at least 400 mm.

*Article 17.05***Residual freeboard**

1. For the purposes of this Chapter and by way of derogation from Article 1.01 of this Annex, residual freeboard means the smallest vertical distance between the surface of the water and the upper surface of the deck at its edge taking into account trim and heel resulting from the moments referred to in Article 17.07 (4).
2. The residual freeboard is sufficient according to Article 17.07(1), if it is at least 300 mm.
3. The residual freeboard may be reduced if it is proven that the requirements of Article 17.08 have been met.
4. Where the shape of a float differs perceptibly from that of a pontoon, as in the case of a cylindrical float, or where the cross-section of a float has more than four sides, the inspection body may require or authorise a residual freeboard that differs from programme 2. This shall also apply to floating equipment consisting of several floats.

*Article 17.06***Heeling test**

1. Confirmation of stability according to Articles 17.07 and 17.08 shall be based on a heeling test that has been carried out in a proper manner.
2. If during a heeling test it is not possible to achieve adequate heeling angles, or if the heeling test causes unreasonable technical difficulties, this may be replaced by a calculation of the craft's centre of gravity and weight. The result of the weight calculation shall be checked by measuring the draught, and the difference shall not exceed  $\pm 5\%$ .

*Article 17.07***Confirmation of stability**

1. It shall be confirmed that, when taking into account the loads applied during operation of the working gear and whilst under way, the residual freeboard and the residual safety clearance are sufficient. For that purpose the sum of the trim and heeling angles shall not exceed  $10^\circ$  and the bottom of the float shall not emerge.
2. Confirmation of stability shall include the following data and documents:
  - (a) scale drawings of floats and working gear and the detailed data relating to these that are needed to confirm stability, such as content of the tanks, openings providing access to the inside of the vessel;
  - (b) hydrostatic data or curves;

**▼B**

- (c) righting lever curves for static-stability to the extent required in accordance with paragraph 5 below or Article 17.08;
  - (d) description of the operating conditions together with the corresponding data concerning weight and centre of gravity, including its unladen state and the equipment situation as regards transport;
  - (e) calculation of the heeling, trimming and righting moments, with a specification of the trim and heeling angles and the corresponding residual freeboard and residual safety clearances;
  - (f) a compilation of the results of the calculation with a specification of the limits for operation and the maximum loads.
3. Confirmation of stability shall be based on at least the following load assumptions:
- (a) specific mass of the dredging products for dredgers:
    - sands and gravels: 1,5 t/m<sup>3</sup>,
    - very wet sands: 2,0 t/m<sup>3</sup>,
    - soil, on average: 1,8 t/m<sup>3</sup>,
    - mixture of sand and water in the ducts: 1,3 t/m<sup>3</sup>;
  - (b) for clamshell dredgers, the values given under point (a) shall be increased by 15 %;
  - (c) for hydraulic dredgers the maximum lifting power shall be considered.
- 4.1. Confirmation of stability shall take account of the moments resulting from:
- (a) load;
  - (b) asymmetric structure;
  - (c) wind pressure;
  - (d) turning whilst under way of self-propelled floating equipment;
  - (e) cross current, if necessary;
  - (f) ballast and provisions;
  - (g) deck loads and, where appropriate, cargo;
  - (h) free surfaces of liquids;
  - (i) inertia forces;
  - (j) other mechanical equipment.

The moments which may act simultaneously shall be added up.

- 4.2. The moment caused by the wind pressure shall be calculated in accordance with the following formula:

$$M_w = c \cdot p_w \cdot A \left( l_w + \frac{T}{2} \right) \text{ [kNm]}$$

where:

$c$  = shape-dependent coefficient of resistance

For frameworks  $c = 1,2$  and for solid-section beams  $c = 1,6$ . Both values take account of gusts of wind.

The whole area encompassed by the contour line of the framework shall be taken to be the surface area exposed to the wind.

$p_w$  = specific wind pressure; this shall uniformly be taken to be 0,25 kN/m<sup>2</sup>;

$A$  = lateral plane above the plane of maximum draught in m<sup>2</sup>;

$l_w$  = distance from the centre of area of the lateral plane  $A$  from the plane of maximum draught, in m.



**▼B**

- 4.3. In order to determine the moments due to turning whilst under way according to paragraph 4.1(d) for self-propelled floating equipment, the formula set out in Article 15.03 (6) shall be used.
- 4.4. The moment resulting from cross current according to paragraph 4.1(e) shall be taken into account only for floating equipment which is anchored or moored across the current while operating.
- 4.5. The least favourable extent of tank filling from the point of view of stability shall be determined and the corresponding moment introduced into the calculation when calculating the moments resulting from liquid ballast and liquid provisions according to paragraph 4.1(f).
- 4.6. The moment resulting from inertia forces according to paragraph 4.1(i) shall be given due consideration if the movements of the load and the working gear are likely to affect stability.
5. The righting moments for floats with vertical side walls may be calculated using the following formula

$$M_a = 10 \cdot D \cdot \overline{MG} \cdot \sin\varphi \text{ (kNm)}$$

where:

$\overline{MG}$  = metacentric height, in m;

$\varphi$  = heeling angle in degrees.

That formula shall apply up to heeling angles of 10° or up to a heeling angle corresponding to immersion of the edge of the deck or emergence of the edge of the bottom; the smallest angle shall be decisive. The formula may be applied to slanting side walls up to heeling angles of 5°; the limit conditions set out in paragraphs 3 and 4 shall also apply.

If the particular shape of the float(s) does not permit such simplification the righting lever curves according to paragraph 2(c) shall be required.

*Article 17.08*

**Confirmation of stability in the case of reduced residual freeboard**

If a reduced residual freeboard according to Article 17.05(3), is used, it shall be proven for all operating conditions that:

- (a) after correction for the free surfaces of liquids, the metacentric height is not less than 0,15 m;
- (b) for heeling angles between 0 and 30°, there is a righting lever of at least

$$h = 0,30 - 0,28 \cdot \varphi_n \text{ (m)}$$

$\varphi_n$  being the heeling angle from which the righting lever curve displays negative values (range of stability); it shall not be less than 20° or 0,35 rad and shall not be introduced into the formula for more than 30° or 0,52 rad, taking the radian (rad) (1° = 0,01745 rad) for the unit of  $\varphi^\circ$ ;

- (c) the sum of the trim and heeling angles does not exceed 10°;
- (d) a residual safety clearance meeting the requirements in Article 17.04 remains;
- (e) a residual freeboard of at least 0,05 m remains;
- (f) for heeling angles between 0 and 30°, a residual righting lever of at least

$$h = 0,20 - 0,23 \cdot \varphi_n \text{ (m)}$$

remains, where  $\varphi_n$  is the heeling angle from which the righting lever curve displays negative values; it shall not be introduced into the formula for more than 30° or 0,52 rad.

Residual righting lever means the maximum difference existing between 0° and 30° of heel between the righting lever curve and the heeling lever curve. If an opening towards the inside of the vessel is reached by the water at a heeling angle less than that corresponding to the maximum difference between the lever curves, the lever corresponding to that heeling angle shall be taken into account.

**▼B***Article 17.09***Draught marks and draught scales**

Draught marks and draught scales shall be affixed in accordance with Articles 4.04 and 4.06.

*Article 17.10***Floating equipment without confirmation of stability**

1. The application of Articles 17.04 to 17.08 may be dispensed with for floating equipment:
  - (a) whose working gear can in no way alter their heeling or trim, and
  - (b) where any displacement of the centre of gravity can be reasonably excluded.
2. However,
  - (a) at maximum load the safety clearance shall be at least 300 mm and the freeboard at least 150 mm;
  - (b) for apertures which cannot be closed spray-proof and weathertight the safety clearance shall be at least 500 mm.

## CHAPTER 18

**SPECIFIC REQUIREMENTS APPLICABLE TO WORKSITE CRAFT***Article 18.01***Operating conditions**

Worksite craft designated as such in the Community certificate set out in Part I or II of Annex V may navigate outside worksites only when unladen. That restriction shall be entered on the Community certificate.

For this purpose worksite craft shall have a certificate issued by the competent authority indicating the duration of works and the geographical boundaries of the worksite in which the craft may be operated.

*Article 18.02***Application of Part II**

Unless otherwise specified in this Chapter the construction and equipment of worksite craft shall be in line with Chapters 3 to 14 of Part II.

*Article 18.03***Derogations**

1.
  - (a) Article 3.03(1), shall apply *mutatis mutandis*;
  - (b) Chapters 5 and 6 shall apply *mutatis mutandis* where the craft is self-propelled;
  - (c) Article 10.02(2)(a) and (b), shall apply *mutatis mutandis*;
  - (d) the inspection body may grant exceptions to the other requirements concerning construction, arrangement and equipment provided that equivalent safety is proven in every case.
2. The inspection body may dispense with the following provisions:
  - (a) Article 8.08 (2) to (8), if no crew is required;

**▼B**

- (b) Article 10.01(1) and (3), if the worksite craft can be securely anchored by means of working anchors or piles. However, self-propelled worksite craft shall be equipped with at least one anchor meeting the requirements set out in Article 10.01(1), where coefficient  $k$  is taken to be 45 and  $T$  is taken to be the lowest height;
- (c) Article 10.02(1)(c), if the worksite craft is not self-propelled.

*Article 18.04***Safety clearance and freeboard**

1. If a worksite craft is used as a reclamation barge or a hopper barge the safety clearance outside the hold area shall be at least 300 mm and the freeboard at least 150 mm. The inspection body may permit a smaller freeboard if proof by calculation is provided that stability is sufficient for a cargo having a specific mass of 1,5 t/m<sup>3</sup> and that no side of the deck reaches the water. The effect of liquefied cargo shall be taken into account.
2. The provisions of Articles 4.01 and 4.02 shall apply *mutatis mutandis* to worksite craft not covered by paragraph 1. The inspection body may determine values departing from the above for safety clearance and freeboard.

*Article 18.05***Ship's boats**

Worksite craft shall not be required to have a ship's boat where:

- (a) they are not self-propelled or
- (b) a ship's boat is available elsewhere on the worksite.

That derogation shall be entered on the Community certificate.

## CHAPTER 19

**SPECIFIC REQUIREMENTS APPLICABLE TO HISTORIC VESSELS****(Left void)**

## CHAPTER 19a

**SPECIFIC REQUIREMENTS APPLICABLE TO CANAL BARGES****(Left void)**

## CHAPTER 19b

**SPECIFIC REQUIREMENTS APPLICABLE TO VESSELS NAVIGATING ON ZONE 4 WATERWAYS***Article 19b.01***Application of Chapter 4**

1. By way of derogation from Article 4.01(1) and (2), the safety clearance of doors and openings other than hold hatches for vessels navigating on Zone 4 waterways is reduced as follows:
  - (a) for openings which can be closed spray-proof and weathertight, to 150 mm;
  - (b) for openings which cannot be closed spray-proof and weathertight, to 200 mm.
2. By way of derogation from Article 4.02, the minimum freeboard of vessels navigating on Zone 4 waterways is 0 mm, if the safety clearance according to paragraph 1 is respected.



CHAPTER 20

**SPECIFIC REQUIREMENTS APPLICABLE TO SEA-GOING VESSELS**

**(Left void)**

CHAPTER 21

**SPECIFIC REQUIREMENTS APPLICABLE TO RECREATIONAL CRAFT**

*Article 21.01*

**General**

Only Articles 21.02 and 21.03 shall apply to the construction and equipment of recreational craft.

*Article 21.02*

**Application of Part II**

1. Recreational craft shall meet the following requirements:
  - (a) from Chapter 3:
 

Article 3.01, Article 3.02(1)(a) and 2, Article 3.03(1)(a) and (6), and Article 3.04(1);
  - (b) Chapter 5;
  - (c) from Chapter 6:
 

Article 6.01(1), and Article 6.08;
  - (d) from Chapter 7:
 

Article 7.01(1) and (2), Article 7.02, Article 7.03(1) and (2), Article 7.04(1), Article 7.05(2), Article 7.13 if there is a wheelhouse designed for radar navigation by one person;
  - (e) from Chapter 8:
 

Article 8.01(1) and (2), Article 8.02(1) and (2), Article 8.03(1) and (3), Article 8.04, Article 8.05(1) to (10) and (13), Article 8.08 (1), (2), (5), (7) and (10), Article 8.09(1), and Article 8.10;
  - (f) from Chapter 9:
 

Article 9.01(1), *mutatis mutandis*;
  - (g) from Chapter 10:
 

Article 10.01(2), (3) and (5) to (14), Article 10.02(1)(a) to (c), and (2)(a) and (e) to (h), Article 10.03(1)(a), (b) and (d): however, there shall be at least two fire extinguishers on board; Article 10.03(2) to (6), Article 10.03a, Article 10.03b ►**M3**, Article 10.03c ◀ and Article 10.05;
  - (h) Chapter 13;
  - (i) Chapter 14.
2. For recreational craft subject to Directive 94/25/EC of the European Parliament and of the Council of 16 June 1994 on the approximation of laws, regulations and administrative provisions of the Member States relating to recreational craft <sup>(1)</sup>, first inspection and periodical inspections only extend to:
  - (a) Article 6.08, if there is a rate-of-turn indicator;
  - (b) Article 7.01(2), Article 7.02, Article 7.03(1), and Article 7.13, if there is a wheelhouse designed for radar navigation by one person;

<sup>(1)</sup> OJ L 164, 30.6.1994, p. 15. Directive as last amended by Regulation (EC) No 1882/2003.

**▼B**

- (c) Article 8.01(2), Article 8.02(1), Article 8.03(3), Article 8.05(5), Article 8.08(2), and Article 8.10;
- (d) Article 10.01(2), (3), (6) and (14), Article 10.02(1)(b) and (c), (2)(a) and (e) to (h), Article 10.03 (1)(b) and (d) and (2) to (6), and ►**M3** Article 10.05 ◀;
- (e) Chapter 13;
- (f) from Chapter 14:
  - (aa) Article 14.12;
  - (bb) Article 14.13; the acceptance test after putting into service of the liquefied gas installation shall be carried out in accordance with the requirements of Directive 94/25/EC, and an acceptance report shall be submitted to the inspection body;
  - (cc) Articles 14.14 and 14.15; the liquefied gas installation shall be in accordance with the requirements of Directive 94/25/EC;
  - (dd) Chapter 14 entirely, if the liquefied gas installation is fitted after placing on the market of the recreational craft.

*Article 21.03***(Left void)**

## CHAPTER 22

**STABILITY OF VESSELS CARRYING CONTAINERS***Article 22.01***General**

1. The provisions of this Chapter shall apply to vessels carrying containers where stability documents are required according to the applicable navigational authority regulations in force in the Member States.  
  
Stability documents shall be checked, or submitted elsewhere for checking, and duly stamped by an inspection body.
2. Stability documents shall provide the boatmaster with comprehensible information on vessel stability for each loading condition.  
  
Stability documents shall include at least the following:
  - (a) information on the permissible stability coefficients, the permissible KG - values or the permissible heights for the centre of gravity of the cargo;
  - (b) data concerning spaces that can be filled with ballast water;
  - (c) forms for checking stability;
  - (d) instructions for use or an example of a calculation for use by the boatmaster.
3. For vessels where it is optional whether containers are carried non-secured or secured, separate calculation methods shall be provided for confirmation of stability both for transport of non-secured and secured cargoes of containers.
4. A cargo of containers shall only be considered to be secured if each individual container is firmly attached to the hull of the vessel by means of container guides or securing equipment and its position cannot alter during the voyage.

*Article 22.02***Limit conditions and method of calculation for confirmation of stability for the transport of non-secured containers**

1. All methods of calculating vessel stability in the case of non-secured containers shall meet the following limit conditions:
  - (a) Metacentric height  $\overline{MG}$  shall be not less than 1,00 m.

**▼B**

- (b) Under the joint action of the centrifugal force resulting from the vessel's turning, wind pressure and the free surfaces of liquids the heeling angle shall not exceed 5° and the edge of the deck shall not be immersed.
- (c) The heeling lever resulting from the centrifugal force caused by the vessel's turning shall be determined in accordance with the following formula:

$$h_{KZ} = c_{KZ} \cdot \frac{v^2}{L_{WL}} \cdot \left( \overline{KG} - \frac{T'}{2} \right) \text{ [m]}$$

where:

$c_{KZ}$  parameter ( $c_{KZ} = 0,04$ ) ( $s^2/m$ );

$v$  the maximum speed of the vessel in relation to the water (m/s);

$\overline{KG}$  height of centre of gravity of the laden vessel above its base (m);

$T'$  draught of the laden vessel (m).

- (d) The heeling lever resulting from the wind pressure shall be determined in accordance with the following formula:

$$h_{KW} = c_{KW} \cdot \frac{A'}{D'} \cdot \left( l_w + \frac{T'}{2} \right) \text{ [m]}$$

where:

$c_{KW}$  parameter ( $c_{KW} = 0,025$ ) ( $t/m^2$ );

$A'$  lateral plane above the respective plane of draught with the vessel laden ( $m^2$ );

$D'$  displacement of the laden vessel (t);

$l_w$  height of the centre of gravity of the lateral plane  $A'$  above the respective plane of draught (m);

$T'$  draught of the laden vessel (m).

- (e) The heeling lever resulting from the free surfaces of rainwater and residual water within the hold or the double bottom shall be determined in accordance with the following formula:

$$h_{KfO} = \frac{c_{KfO}}{D'} \cdot \sum \left( b \cdot l \cdot \left( b - 0,55\sqrt{b} \right) \right) \text{ [m]}$$

where:

$c_{KfO}$  parameter ( $c_{KfO} = 0,015$ ) ( $t/m^2$ )

$b$  width of hold or section of the hold in question (m); (\*)

$l$  length of hold or section of the hold in question (m); (\*)

$D'$  displacement of the laden vessel (t).

- (f) Half of the fuel and fresh water supply shall be taken into account for each load condition.

2. The stability of a vessel carrying non-secured containers shall be considered to be sufficient if the effective  $\overline{KG}$  does not exceed the  $\overline{KG}_{zul}$  resulting from the following formulae. The  $\overline{KG}_{zul}$  shall be calculated for various displacements covering the entire range of draughts.

$$(a) \overline{KG}_{zul} = \frac{\overline{KM} + \frac{B_{WL}}{2F} \cdot \left( Z \cdot \frac{T_m}{2} - h_{KW} - h_{KfO} \right)}{\frac{B_{WL}}{2F} \cdot Z + 1} \text{ [m]}$$

No value less than 11,5 ( $11,5 = 1/\tan 5^\circ$ ) shall be taken for  $\frac{B_{WL}}{2F}$ .

(\*) The hold sections providing free surfaces that are exposed to water arise from the longitudinal and/or transverse water-tight compartmentalisation that forms independent sections.

**▼B**

$$(b) \overline{KG}_{zul} = \overline{KM} - 1,00 \text{ (m)}$$

The lowest value of  $\overline{KG}_{zul}$  in accordance with formula (a) or (b) shall be decisive.

Within the formulae:

$\overline{KG}_{zul}$  maximum permissible height of the laden vessel's centre of gravity above its base (m);

$\overline{KM}$  height of the metacentre above the base (m) in accordance with the approximation formula in paragraph 3;

F respective effective freeboard at 1/2 L (m);

Z parameter for the centrifugal force resulting from turning

$$Z = \frac{(0,7 \cdot v)^2}{9,81 \cdot 1,25 \cdot L_{WL}} = 0,04 \cdot \frac{v^2}{L_{WL}} [-]$$

v maximum speed of the vessel in relation to the water (m/s);

$T_m$  respective average draught (m);

$h_{KW}$  heeling lever resulting from lateral wind pressure according to paragraph 1(d) (m);

$h_{KfO}$  sum of the heeling levers resulting from the free surfaces of liquids according to paragraph 1(e) (m).

### 3. Approximation formula for $\overline{KM}$

Where no sheet of hydrostatic curves is available the value  $\overline{KM}$  for the calculation in accordance with paragraph 2 and Article 22.03 (2), may be determined by the following approximation formulae:

(a) for vessels in the shape of a pontoon

$$\overline{KM} = \frac{B_{WL}^2}{\left(12,5 - \frac{T_m}{H}\right) \cdot T_m} + \frac{T_m}{2} \text{ [m]}$$

(b) for other vessels

$$\overline{KM} = \frac{B_{WL}^2}{\left(12,7 - 1,2 \cdot \frac{T_m}{H}\right) \cdot T_m} + \frac{T_m}{2} \text{ [m]}$$

#### Article 22.03

#### Limit conditions and method of calculation for confirmation of stability for the transport of secured containers

1. All methods of calculating vessel stability in the case of secured containers shall meet the following limit conditions:

- metacentric height  $\overline{MG}$  shall be not less than 0,50 m;
- no hull opening shall be immersed by the joint action of the centrifugal force resulting from the turning of the vessel, the wind pressure and the free surfaces of liquids;
- the heeling levers resulting from the centrifugal force due to the vessel's turning, the wind pressure and the free surfaces of liquids shall be determined in accordance with the formulae referred to in Article 22.02(1)(c) to (e);
- half of the fuel and fresh water supply shall be taken into account for each load condition.

**▼B**

2. The stability of a vessel carrying secured containers shall be considered to be sufficient if the effective  $\overline{KG}$  does not exceed  $\overline{KG}_{zul}$  the resulting from the following formulae that has been calculated for various displacements covering the entire range of draughts.

$$(a) \overline{KG}_{zul} = \frac{\overline{KM} - \frac{I-i}{2\forall} \left( 1 - 1,5 \frac{F}{F'} \right) + 0,75 \frac{B_{WL}}{F} \left( Z \cdot \frac{T_m}{2} - h_{KW} - h_{KfO} \right)}{0,75 \cdot \frac{B_{WL}}{F} \cdot Z + 1} \quad [m]$$

No value less than 6,6 shall be taken for  $\frac{B_{WL}}{F}$  and

no value less than 0 for  $\frac{I-i}{2\forall} \cdot \left( 1 - 1,5 \frac{F}{F'} \right)$ .

$$(b) \overline{KG}_{zul} = \overline{KM} - 0,50 \text{ (m)}$$

The lowest value for  $\overline{KG}_{zul}$  in accordance with formula (a) or (b) shall be decisive.

Within these formulae, apart from the terms defined previously:

I transverse moment of inertia of water line area at  $T_m$  ( $m^4$ ) (for the approximation formula see paragraph 3);

i transverse moment of inertia of the water line area parallel to the base, at height

$$T_m + \frac{2}{3} F' \quad [m^4]$$

$\forall$  water displacement of the vessel at  $T_m$  ( $m^3$ );

$F'$  ideal freeboard  $F' = H' - T_m$  (m) or  $F' = \frac{a \cdot B_{WL}}{2 \cdot b}$  [m], the lowest value shall be decisive;

a the vertical distance between the lower edge of the opening that is first immersed in the event of heeling and the water line in the vessel's upright position (m);

b distance from that same opening from the centre of the vessel (m);

$H'$  ideal side height  $H' = H + \frac{q}{0,9 \cdot L \cdot B_{WL}}$  [m];

q sum of the volumes of the deckhouses, hatches, trunk decks and other superstructures up to a maximum height of 1,0 m above H or up to the lowest aperture in the volume under consideration, the lowest value being decisive. Parts of volumes located within a range of 0,05 L from the extremities of the vessel shall not be taken into account ( $m^3$ ).

### 3. Approximation formula for I

Where there is no sheet of hydrostatic curves available the value for the transverse moment of inertia I of the water line area may be calculated by the following approximation formulae:

(a) for vessels in the shape of a pontoon

$$I = \frac{B_{WL}^2 \cdot \forall}{\left( 12,5 - \frac{T_m}{H} \right) \cdot T_m} \quad [m^4]$$

(b) for other vessels

$$I = \frac{B_{WL}^2 \cdot \forall}{\left( 12,7 - 1,2 \cdot \frac{T_m}{H} \right) \cdot T_m} \quad [m^4]$$



**▼B***Article 22.04***Procedure for assessing stability on board**

The procedure for assessing stability may be determined by the documents referred to in Article 22.01(2).

## CHAPTER 22a

**SPECIFIC REQUIREMENTS APPLICABLE TO CRAFT LONGER THAN 110 M***Article 22a.01***Application of Part I**

In addition to the requirements set out in Article 2.03(3), the inspection body which is subsequently to issue the Community certificate shall be informed by the owner or his representative before building of craft longer than 110 m, except sea-going ships, begins (building of a new vessel or extension of a vessel already in service). That inspection body shall conduct inspections during the building stage. It may dispense with inspections during the building stage if a certificate is produced before building begins to show that an approved classification society declares that it is to supervise that building.

*Article 22a.02***Application of Part II**

In addition to Part II, Articles 22a.03 to 22a.05 shall apply to craft that are longer than 110 m.

*Article 22a.03***Strength**

Sufficient hull strength in accordance with Article 3.02(1)(a) (longitudinal, lateral and local strength) shall be verified by a certificate issued by an approved classification society.

*Article 22a.04***Buoyancy and stability**

1. Paragraphs 2 to 9 shall apply to craft that are longer than 110 m, with the exception of passenger vessels.
2. The proof of sufficient stability, including stability after damage, shall be verified for the most unfavourable loading condition.

The basic values for the stability calculation, the vessel's lightweight and the location of the centre of gravity, shall be determined:

- either by means of a heeling experiment, or
- by detailed mass and moment calculation, in which case the lightweight of the vessel shall be verified by checking the draught, with a tolerance limit of +/- 5 % between the mass determined by calculation and the displacement determined by the draught readings.

3. The proof of buoyancy after damage shall be verified for the fully laden craft.

For this purpose, calculated proof of sufficient stability shall be established for the critical intermediate stages of flooding and for the final stage of flooding. Negative values of stability in intermediate stages of flooding may be accepted by the competent authority if sufficient stability in subsequent intermediate stages is verified.

4. The following assumptions shall be taken into consideration for the damaged condition:

- (a) Extent of side damage:

longitudinal extent: at least 0,10 L,

**▼B**

transverse extent: 0,59 m,  
vertical extent: from the base line upwards without limit;

## (b) Extent of bottom damage:

longitudinal extent: at least 0,10 L,  
transverse extent: 3,00 m,  
vertical extent: from the base 0,39 m upwards, the sump excepted.

## (c) Any bulkheads within the damaged area shall be assumed damaged, which means that the subdivision shall be chosen so that the vessel remains afloat after the flooding of two or more adjacent compartments in the longitudinal direction.

For the main engine room only the one-compartment standard need be taken into account, i.e. the end bulkheads of the engine room shall be assumed as not damaged.

For bottom damage, adjacent athwartship compartments shall also be assumed as flooded.

## (d) Permeability

Permeability shall be assumed to be 95 %.

By way of derogation from this assumption, the following permeability may be assumed:

- engine and operation rooms: 85 %
- double bottoms, fuel tanks, ballast tanks, etc. depending on whether, according to their function, they have to be assumed as full or empty for the vessel floating at the maximum permissible draught: 0 or 95 %.

If a calculation proves that the average permeability of any compartment is lower, the calculated value may be used.

## (e) The lower edge of any non-watertight openings (e.g. doors, windows, access hatches) shall, at the final stage of flooding, be not less than 100 mm above the damaged waterline.

## 5. The stability after damage shall be sufficient if, on the basis of the assumptions in paragraph 4:

- (a) at the final stage of flooding a safety clearance of not less than 100 mm remains and the heeling angle of the craft does not exceed 5°; or
- (b) calculations in accordance with the procedure for calculation of damaged stability specified in Part 9 of the ADNR produce a positive result.

## 6. When cross- or down-flooding openings are provided for reduction of asymmetrical flooding, the time for equalisation shall not exceed 15 minutes, if during the intermediate stages of flooding sufficient damaged stability has been verified.

## 7. If openings through which undamaged compartments may additionally become flooded are capable of being closed watertight, the closing appliances shall be marked according to their operating instructions.

## 8. The proof by calculation in accordance with paragraphs 2 to 5 shall be considered to have been provided if damaged stability calculations in accordance with Part 9 of the ADNR, are produced with a positive result.

## 9. Where necessary in order to meet the requirements in paragraphs 2 or 3, the plane of maximum draught shall be re-established.

*Article 22a.05***Additional requirements**

## 1. Craft longer than 110 m shall:

- (a) be fitted with a multi-propeller propulsion system, with at least two independent engines of equal power and a bow thruster that is controlled from the wheelhouse and is also effective when the craft is in an unladen state; or

**▼B**

have a single-propeller propulsion system and a bow thruster that is controlled from the wheelhouse with its own power supply and which is also effective when the craft is in an unladen state and makes it possible for the craft to proceed under its own power in the event of a breakdown of the main propulsion system;

- (b) be fitted with a radar navigation system, together with a rate-of-turn indicator in accordance with Article 7.06(1);
  - (c) have a permanently-installed bilge pumping system in accordance with Article 8.08;
  - (d) meet the requirements of Article 23.09(1)(1).
2. For craft, except passenger ships, with a length of more than 110 m, which in addition to paragraph 1
- (a) are capable of being separated, in the event of an accident, in the middle third of the vessel without the use of heavy salvage equipment while the separated parts of the vessel shall remain afloat after separation;
  - (b) are provided with a certificate that shall be carried on board and which is issued by an approved classification society regarding the buoyancy, trim position and stability of the separate parts of the vessel, indicating the degree of loading above which buoyancy of the two parts is no longer ensured;
  - (c) are built as double-hull vessels in accordance with the ADNR, where for motor vessels sections 9.1.0.91 to 9.1.0.95, and for tank vessels sections 9.3.2.11.7 and 9.3.2.13 to 9.3.2.15 of Part 9 of the ADNR shall apply;
  - (d) are fitted with a multi-screw propulsion system in accordance with paragraph 1(a), first half sentence;

it shall be entered in item 52 of the Community certificate that they comply with all the requirements of points (a) to (d).

3. For passenger vessels with a length of more than 110 m which in addition to paragraph 1
- (a) are built or converted for their highest class under the supervision of an approved classification society, in which case compliance shall be confirmed by means of a certificate issued by the classification society while current class is not necessary;

- (b) either

have a double bottom with a height of at least 600 mm and subdivision to ensure that, in the event of flooding of any two adjacent watertight compartments, the vessel does not immerse lower than the margin line and a residual safety clearance of 100 mm remains,

or

have a double bottom with a height of at least 600 mm and a double hull with a distance of at least 800 mm between the side wall of the vessel and the longitudinal bulkhead;

- (c) be fitted with a multi-screw propulsion system with at least two independent engines of equal power and a bow thruster system which can be operated from the wheelhouse and which operates longitudinally as well as transversely;
- (d) allow the stern anchor to be operated directly from the wheelhouse;

it shall be entered in item 52 of the Community certificate that they comply with all the requirements of points (a) to (d).

*Article 22a.06*

**Application of Part IV in the event of conversion**

The inspection body may apply Chapter 24 to craft converted to a length of more than 110 m only on the basis of specific recommendations by the Committee.



## CHAPTER 22b

## SPECIFIC REQUIREMENTS APPLICABLE TO HIGH-SPEED VESSELS

*Article 22b.01***General**

1. High-speed vessels shall not be constructed as cabin vessels.
2. The following installations are prohibited on board high-speed vessels:
  - (a) appliances fitted with wick burners according to Article 13.02;
  - (b) vaporising oil burner stoves according to Articles 13.03 and 13.04;
  - (c) solid-fuel heating appliances according Article 13.07;
  - (d) liquefied gas installations according to Chapter 14.

*Article 22b.02***Application of Part I**

1. In addition to the provisions of Article 2.03, high-speed vessels shall be constructed and classified under the supervision and in accordance with the applicable rules of an approved classification society which has special rules for high-speed vessels. The class shall be maintained.
2. By way of derogation from Article 2.06, Community certificates issued in accordance with the provisions of this Chapter shall be valid for a maximum of five years.

*Article 22b.03***Application of Part II**

1. Notwithstanding paragraph 2 and Article 22b.02(2), Chapters 3 to 15 shall apply to high-speed vessels, with the exception of the following provisions:
  - (a) Article 3.04(6), second subparagraph;
  - (b) Article 8.08(2), second sentence;
  - (c) Article 11.02(4), second and third sentences;
  - (d) Article 12.02(4), second sentence;
  - (e) Article 15.06(3)(a), second sentence.
2. By way of derogation from Article 15.02(9), and Article 15.15(7), all doors in watertight bulkheads shall be capable of being remote controlled.
3. By way of derogation from Article 6.02(1), in case of failure or malfunctioning of the steering apparatus drive unit a second independent steering apparatus drive unit or a manually operated drive unit shall come into operation without time delay.
4. In addition to the requirements of Part II, high-speed vessels shall meet the requirements of Articles 22b.04 to 22b.12.

*Article 22b.04***Seats and safety belts**

Seats shall be available for the maximum number of passengers permitted on board. Seats shall be fitted with safety belts. Safety belts may be dispensed with where suitable impact protection is provided or where they are not required under Chapter 4, part 6, of the HSC Code 2000.

*Article 22b.05***Freeboard**

By way of derogation from Articles 4.02 and 4.03, the freeboard shall be at least 500 mm.

**▼B***Article 22b.06***Buoyancy, stability and subdivision**

For high-speed vessels, proper documentation shall be provided for:

- (a) buoyancy and stability characteristics adequate for safety where the craft is operated in the displacement mode, both when intact and when damaged;
- (b) stability characteristics and stabilising systems ensuring the safety of the craft when used in the dynamic buoyancy phase and the transition phase;
- (c) stability characteristics in the non-displacement and transitional modes adequate to transfer the craft safely to displacement mode in case of any system malfunction.

*Article 22b.07***Wheelhouse**

## 1. Arrangement

- (a) By way of derogation from Article 7.01(1), wheelhouses shall be arranged in such a way that the helmsman and a second member of the crew may at all times perform their tasks while the vessel is under way.
- (b) The steering position shall be arranged so as to accommodate workstations for the persons mentioned in (a). The instruments for navigation, manoeuvring, monitoring and communication and other important operating controls shall be sufficiently close together to allow a second member of the crew as well as the helmsman to obtain the necessary information and to operate the controls and installations as necessary while seated. The following requirements shall apply in all cases:
  - (aa) the steering position for the helmsman shall be arranged so as to allow radar navigation by one person.
  - (bb) the second member of the crew shall have his own radar screen (slave) at his workstation and shall be able to intervene from his workstation to transmit information and control the propulsion of the vessel.
- (c) The persons mentioned in (a) shall be able to operate the installations mentioned in (b) without any hindrance, including when safety belts are properly worn.

## 2. Unobstructed view

- (a) By way of derogation from Article 7.02(2), the area of obstructed view forward of the bow for the helmsman in a seated position shall not be more than one vessel length irrespective of the amount of cargo.
- (b) By way of derogation from Article 7.02(3), the total arc of blind sectors from right ahead to 22,5° abaft the beam on either side shall not exceed 20°. Each individual blind sector shall not exceed 5°. The clear sector between two blind sectors shall not be less than 10°.

## 3. Instruments

Instrument panels for operating and monitoring the installations mentioned in Article 22b.11 shall be in separate and clearly marked positions in the wheelhouse. This shall also apply, where appropriate, to controls for launching collective lifesaving equipment.

## 4. Lighting

Red light shall be used for areas or pieces of equipment which shall be lit during use.

## 5. Windows

Reflections shall be avoided. A means for avoiding dazzle by sunlight shall be provided.

## 6. Surface materials

The use of reflective surface materials in the wheelhouse shall be avoided.

**▼B***Article 22b.08***Additional equipment**

High-speed craft shall have the following equipment:

- (a) a radar installation and rate-of-turn indicator according to Article 7.06(1),
- (b) readily accessible individual lifesaving equipment conforming to European Standard EN 395:1998 for the maximum number of persons permitted on board.

*Article 22b.09***Closed areas**

## 1. General

Public spaces and accommodation and the equipment they contain shall be designed so that any person making proper use of those facilities will not suffer injury during a normal and emergency start or stop, or during manoeuvring in normal cruise and in failure or malfunction conditions.

## 2. Communication

- (a) For the purpose of informing passengers of safety measures, all passenger vessels shall be fitted with acoustic and visual installations visible and audible to everyone on board.
- (b) The installations described under (a) shall enable the boatmaster to give instructions to passengers.
- (c) Every passenger shall have access to instructions for emergency situations close to their seat, including a plan of the vessel showing all exits, escape routes, emergency equipment, lifesaving equipment and instructions for the use of lifejackets.

*Article 22b.10***Exits and escape routes**

Escape and evacuation routes shall satisfy the following requirements:

- (a) there shall be easy, safe and quick access from the steering position to spaces and accommodation accessible to the public;
- (b) escape routes leading to emergency exits shall be clearly and permanently marked;
- (c) all exits shall be properly marked. The operation of the opening mechanism shall be obvious from the outside and the inside;
- (d) the escape routes and emergency exits shall have a suitable safety guidance system;
- (e) sufficient space for a member of the crew shall be left next to exits.

*Article 22b.11***Fire protection and fire-fighting**

1. Corridors, rooms and accommodation accessible to the public and also galleys and engine rooms shall be connected to an appropriate fire alarm system. Any fire and its location shall be indicated automatically in a place permanently manned by crew.
2. Engine rooms shall be equipped with a permanently installed fire-fighting system according to Article 10.03b.
3. Rooms and accommodation accessible to the public and their escape routes shall be equipped with a pressurised water sprinkler system according to Article 10.03a. It shall be possible to drain the used water rapidly and directly to the outside.

**▼B***Article 22b.12***Transitional provisions**

High-speed vessels according to Article 1.01(22) which have a valid Community certificate on 31 March 2003 shall meet the following provisions of this Chapter:

- (a) Articles 22b.01, 22b.04, 22b.08, 22b.09, 22b.10, 22b.11(1)

when the Community certificate is renewed;

- (b) on 1 April 2013,

Article 22b.07(1), (3), (4), (5) and (6);

- (c) on 1 January 2023

all other provisions.

## PART III

## CHAPTER 23

**EQUIPMENT OF VESSELS WITH REGARD TO MANNING***Article 23.01*

**(Left void)**

*Article 23.02*

**(Left void)**

*Article 23.03*

**(Left void)**

*Article 23.04*

**(Left void)**

*Article 23.05*

**(Left void)**

*Article 23.06*

**(Left void)**

*Article 23.07*

**(Left void)**

*Article 23.08*

**(Left void)**

*Article 23.09***Vessels' equipment**

1. For motor vessels, pushers, pushed convoys and passenger vessels, compliance with, or failure to comply with, the provisions of subparagraphs 1.1 or 1.2 shall be entered in item 47 of the Community certificate by the inspection body.

- 1.1 Standard S1

- (a) The propulsion systems shall be arranged in such a way that speed can be changed and the direction of the propeller thrust reversed from the steering position.

**▼B**

It shall be possible for the auxiliary engines needed for operational purposes to be switched on or off from the steering position, unless this is done automatically or the engines run continuously during each voyage.

- (b) In the danger areas of,
- the temperature of the main-engine cooling water,
  - the lubricating-oil pressure for the main engines and transmissions,
  - the oil and air pressure of the main-engine reversing units, reversible transmissions or propellers,
  - the bilge levels in the main engine room,
- there shall be monitoring by means of instruments which set off acoustic and visual signals in the wheelhouse in the event of malfunction. The acoustic alarm signals may be combined in one audible warning device. They may be switched off as soon as the malfunction has been acknowledged. The visual alarm signals may only be switched off when the malfunctions which set them off have been corrected.
- (c) The fuel shall be supplied and the main engine cooled automatically.
- (d) The steering system shall be able to be operated by one person, even in maximum draught, without requiring particular force.
- (e) It shall be possible to give the visual and acoustic signals required under national or international navigational authority regulations, as appropriate, from the steering position.
- (f) Where there is no direct communication between the steering position and the foresection, the aft, the accommodation and the engine rooms, a voice communication system shall be provided. For communication with the engine rooms, this may be in the form of an optical or acoustic signal.
- (g) The required ship's boat shall be capable of being released by one crew member alone and in an appropriate amount of time.
- (h) There shall be a searchlight which can be operated from the steering position.
- (i) The operation of cranks and similar revolving parts of lifting devices shall not require a force of more than 160 N.
- (k) The towing winches entered in the Community certificate shall be motorised.
- (l) The bilge and deck-wash pumps shall be motorised.
- (m) The principal control units and monitoring instruments shall be ergonomically arranged.
- (n) The equipment required under Article 6.01(1), shall be capable of being remotely operated from the steering position.

## 1.2 Standard S2

- (a) For motor vessels operating separately:
- standard S1 and additionally equipped with a bow thruster which can be operated from the steering position;
- (b) For motor vessels propelling in side-by-side formation:
- standard S1 and additionally equipped with a bow thruster which can be operated from the steering position;
- (c) For motor vessels propelling pushed convoys made up of the motor vessel itself and a craft in front:
- standard S1 and additionally equipped with hydraulic or electrically operated coupling winches. This equipment is, however, not required if the foremost vehicle in the pushed convoy is equipped with a bow thruster which can be operated from the steering position of the pushing motor vessel;



**▼B**

- (d) For pushers propelling a pushed convoy:

standard S1 and additionally equipped with hydraulic or electric coupling winches. This equipment is, however, not required if the foremost craft in the pushed convoy is equipped with a bow thruster which can be operated from the steering position of the pusher;

- (e) For passenger vessels:

standard S1 and additionally equipped with a bow thruster which can be operated from the steering position. This equipment is, however, not required if the propulsion system and steering system of the passenger vessel guarantee equal manoeuvrability.

*Article 23.10*

**(Left void)**

*Article 23.11*

**(Left void)**

*Article 23.12*

**(Left void)**

*Article 23.13*

**(Left void)**

*Article 23.14*

**(Left void)**

*Article 23.15*

**(Left void)**

PART IV

CHAPTER 24

**TRANSITIONAL AND FINAL PROVISIONS**

*Article 24.01*

**Applicability of transitional provisions to craft which are already in service**

1. The provisions of Articles 24.02 to 24.04 apply only to craft carrying on 30 December 2008 a valid vessel certificate according to the Rhine Vessel Inspection Regulation in force on 31 December 1994, or which were under construction or undergoing conversion on 31 December 1994.
2. For craft not covered by paragraph 1, the provisions of Article 24.06 apply.

*Article 24.02*

**Derogations for craft which are already in service**

1. Without prejudice to Articles 24.03 and 24.04, craft which do not fully comply with the provisions of this Directive must
  - (a) be adapted to comply with those provisions in accordance with the transitional provisions listed in the table below, and
  - (b) until their adaptation, comply with the Rhine Vessel Inspection Regulation in force on 31 December 1994.

**▼B**

2. The following definitions apply in the table below:

- ‘NRC’: the provision does not apply to craft which are already operating, unless the parts concerned are replaced or converted, i.e. the provision applies only to Newly-built craft and to the Replacement or Conversion of the parts or areas concerned. If existing parts are replaced by replacement parts using the same technology and of the same type, this does not constitute replacement (‘R’) within the meaning of the transitional provisions.
- ‘Issue or renewal of the Community certificate’: the provision must be complied with the time of the next issue or renewal of the Community certificate after the date indicated.

Article and paragraph	Content	Deadline and comments
	CHAPTER 3	
3.03(1)(a)	Situation of collision bulkhead	NRC, at the latest on issue or renewal of the Community certificate after 1.1.2035
paragraph 2	Accommodations	NRC, at the latest on issue or renewal of the Community certificate after 1.1.2010
	Safety equipment	NRC, at the latest on issue or renewal of the Community certificate after 1.1.2015
paragraph 4	Gastight separation of accommodations from engine rooms, boiler rooms and holds	NRC, at the latest on issue or renewal of the Community certificate after 1.1.2010
paragraph 5, second subparagraph	Monitoring of doors in aft-peak bulkheads	NRC, at the latest on issue or renewal of the Community certificate after 1.1.2010
paragraph 7	Anchors not protruding in foresections of vessels	NRC, at the latest on issue or renewal of the Community certificate after 1.1.2041
3.04(3), second sentence	Insulation material used in engine rooms	NRC, at the latest on issue or renewal of the Community certificate
paragraph 3, third and fourth sentences	Openings and locking devices	NRC, at the latest on issue or renewal of the Community certificate
3.04(6)	Exits of engine rooms	Engine rooms which were not considered as engine rooms according to Article 1.01 before 1995 must be equipped with a second exit at NRC, at the latest on issue or renewal of the Community certificate after 1.1.2035
	CHAPTER 5	
5.06(1), first sentence	Minimum speed	For craft laid down before 1996 at the latest on issue or renewal of the Community certificate after 1.1.2035
	CHAPTER 6	
6.01(1)	Manoeuvrability required by Chapter 5	NRC, at the latest on issue or renewal of the Community certificate after 1.1.2035
paragraph 3	Permanent lists and ambient temperatures	NRC, at the latest on issue or renewal of the Community certificate after 1.1.2010
paragraph 7	Design of rudder stocks	For craft laid down before 1996: NRC, at the latest on issue or renewal of the Community certificate after 1.1.2015
6.02(1)	Presence of separate hydraulic tanks	NRC, at the latest on issue or renewal of the Community certificate after 1.1.2010
	Duplicated pilot valves in case of hydraulic drive units	NRC, at the latest on issue or renewal of the Community certificate after 1.1.2020

**▼M3**

▼ M3

Article and paragraph	Content	Deadline and comments
paragraph 2	Separated pipework for the second drive unit in case of hydraulic drive units  Activating the second drive unit by means of a single operation	NRC, at the latest on issue or renewal of the Community certificate after 1.1.2020  NRC, at the latest on issue or renewal of the Community certificate after 1.1.2010
▼ <u>B</u> paragraph 3	Manoeuvrability required by Chapter 5 ensured by second drive unit/manual drive	NRC, at the latest on issue or renewal of the Community certificate after 1.1.2035
▼ <u>M3</u> 6.03(1)	Connection of other consumers to hydraulic steering apparatus drive units	NRC, at the latest on issue or renewal of the Community certificate after 1.1.2020
▼ <u>B</u> 6.05(1)	Wheel of manual drive not driven by powered drive unit	NRC, at the latest on issue or renewal of the Community certificate after 1.1.2010
6.06(1)	Two independent actuation systems	NRC, at the latest on issue or renewal of the Community certificate after 1.1.2015
▼ <u>M3</u> 6.07(2)(a)	level alarm of the hydraulic tanks and alarm of the service pressure	NRC, at the latest on issue or renewal of the Community certificate after 1.1.2010
▼ <u>B</u> paragraph 2(e)	Monitoring of buffer devices	NRC, at the latest on issue or renewal of the Community certificate
6.08(1)	Requirements for electrical equipment according to Article 9.20	NRC, at the latest on issue or renewal of the Community certificate after 1.1.2015
▼ <u>M3</u> 7.02(2)	CHAPTER 7  Obstructed vision ahead of the vessel 2 vessel lengths if less than 250 m	NRC, at the latest on issue or renewal of the Community certificate after 1.1.2049
▼ <u>B</u> 7.02(3), second subparagraph	Unobstructed view in the helmsman's usual axis of vision	NRC, at the latest on issue or renewal of the Community certificate after 1.1.2015
paragraph 5	Minimal light transmission	NRC, at the latest on issue or renewal of the Community certificate after 1.1.2010
7.03(7)	Shutdown of alarms	NRC, at the latest on issue or renewal of the Community certificate, unless the wheelhouse has been designed for radar navigation by one person
paragraph 8	Automatic switch to another power supply	NRC, at the latest on issue or renewal of the Community certificate after 1.1.2010
7.04(1)	Control of main engines and steering systems	NRC, at the latest on issue or renewal of the Community certificate
paragraph 2	Control of main engine	Unless wheelhouses have been designed for radar navigation by one person: NRC, at the latest on issue or renewal of the Community certificate after 1.1.2035 if the direction of motion can be achieved directly; 1.1.2010 for other engines
7.09	Alarm system	NRC, at the latest on issue or renewal of the Community certificate after 1.1.2010

**▼B**

Article and paragraph	Content	Deadline and comments
7.12 first paragraph	Retractable wheelhouses	NRC, at the latest on issue or renewal of the Community certificate Non-hydraulic lowering system: at the latest on issue or renewal of the Community certificate after 1.1.2035
second and third paragraphs		NRC, at the latest on issue or renewal of the Community certificate
	<b>CHAPTER 8</b>	
8.01(3)	Only internal-combustion engines burning fuels having a flashpoint of more than 55°C	NRC, at the latest on issue or renewal of the Community certificate after 1.1.2015
8.02(1)	Securing of engines against unintentional starting	NRC, at the latest on issue or renewal of the Community certificate after 1.1.2010
paragraph 4	Automatic protection of engine parts	NRC, at the latest on issue or renewal of the Community certificate
8.03(2)	Monitoring devices	NRC, at the latest on issue or renewal of the Community certificate after 1.1.2010
paragraph 3	Automatic protection against overspeed	NRC, at the latest on issue or renewal of the Community certificate after 1.1.2010
paragraph 5	Design of shaft bushings	NRC, at the latest on issue or renewal of the Community certificate after 1.1.2015
8.05(1)	Steel tanks for liquid fuels	NRC, at the latest on issue or renewal of the Community certificate after 1.1.2015
paragraph 2	Automatic closing of tank valves	NRC, at the latest on issue or renewal of the Community certificate
paragraph 3	No fuel tanks located forward of the collision bulkhead	NRC, at the latest on issue or renewal of the Community certificate after 1.1.2010
paragraph 4	No fuel tanks and their fittings above engines or exhaust pipes	NRC, at the latest on issue or renewal of the Community certificate after 1.1.2010. Until then, appropriate devices must ensure the safe evacuation of fuels.
paragraph 6, third to fifth sentences	Installation and measurements of breather pipes and connection pipes	NRC, at the latest on issue or renewal of the Community certificate after 1.1.2010
<b>▼M3</b> paragraph 7, first subparagraph	Quick-closing valve on the tank operated from deck, even when the rooms in question are closed.	NRC, at the latest on issue or renewal of the Community certificate after 1.1.2015
<b>▼B</b> paragraph 9, first sentence	Capacity-gauging devices to be legible up to maximum filling level	NRC, at the latest on issue or renewal of the Community certificate after 1.1.2010
paragraph 13	Filling level control not only for main engines but also other engines needed for safe operation of the vessel	NRC, at the latest on issue or renewal of the Community certificate after 1.1.2015
8.08(8)	Simple closing device not sufficient for connection of ballast spaces to drainage pipes for holds capable of carrying ballast	NRC, at the latest on issue or renewal of the Community certificate after 1.1.2010
paragraph 9	Gauging devices in hold bilges	NRC, at the latest on issue or renewal of the Community certificate after 1.1.2010
8.09(2)	Installations for the collection of oily water and used oil stores	NRC, at the latest on issue or renewal of the Community certificate after 1.1.2010
8.10(3)	Emission limit of 65 dB(A) for stationary vessels	NRC, at the latest on issue or renewal of the Community certificate after 1.1.2015

▼ **B**

Article and paragraph	Content	Deadline and comments
	CHAPTER 8a The transitional provisions on Chapter 8a of the Rhine Vessel Inspection Regulation apply	
	CHAPTER 9	
9.01(1), second sentence	Relevant documents to be submitted to the inspection body	NRC, at the latest on issue or renewal of the Community certificate after 1.1.2035
paragraph 2, second indent	Switching diagrams for main, emergency and distribution switchboard to be kept on board	NRC, at the latest on issue or renewal of the Community certificate after 1.1.2010
paragraph 3	Ambient inside and deck temperatures	NRC, at the latest on issue or renewal of the Community certificate after 1.1.2010
9.02(1) to (3)	Electricity supply systems	NRC, at the latest on issue or renewal of the Community certificate after 1.1.2010
9.05(4)	Cross-section of the earthing conductors	NRC, at the latest on issue or renewal of the Community certificate after 1.1.2015
9.11(4)	Effective ventilation when accumulators are installed in a closed compartment, cabinet or chest	NRC, at the latest on issue or renewal of the Community certificate
9.12(2)(d)	Switch-gear installations	NRC, at the latest on issue or renewal of the Community certificate after 1.1.2015
paragraph 3(b)	Earth detection device capable of giving both visual and audible alarm	NRC, at the latest on issue or renewal of the Community certificate after 1.1.2010
9.13	Emergency circuit breakers	NRC, at the latest on issue or renewal of the Community certificate after 1.1.2010
9.14(3), second sentence	Prohibition of single-pole switches in laundries, bathrooms, washrooms and other rooms with wet facilities	NRC, at the latest on issue or renewal of the Community certificate after 1.1.2010
9.15(2)	Minimum cross-section of 1,5 mm <sup>2</sup> per cable	NRC, at the latest on issue or renewal of the Community certificate after 1.1.2010
paragraph 9	Cables connected to retractable wheel-houses	NRC, at the latest on issue or renewal of the Community certificate after 1.1.2010
9.16(3), second sentence	Second circuit	NRC, at the latest on issue or renewal of the Community certificate after 1.1.2015
9.19	Alarm and safety systems for mechanical equipment	NRC, at the latest on issue or renewal of the Community certificate after 1.1.2015
9.20	Electronic equipment	NRC, at the latest on issue or renewal of the Community certificate after 1.1.2035
9.21	Electromagnetic compatibility	NRC, at the latest on issue or renewal of the Community certificate after 1.1.2035
	CHAPTER 10	
10.01	Anchor equipment	NRC, at the latest on issue or renewal of the Community certificate after 1.1.2010
10.02(2)(a)	Certificate for mooring and other cables	First cable to be replaced on the vessel: NRC, at the latest 1.1.2008 Second and third cables: 1.1.2013
10.03(1)	European standard	For replacement, at the latest 1.1.2010
paragraph 2	Suitability for Class A, B and C fires	For replacement, at the latest 1.1.2010
paragraph 4	Relation of CO <sub>2</sub> content and size of room	For replacement, at the latest 1.1.2010

▼B

Article and paragraph	Content	Deadline and comments
10.03a	Permanently installed fire-fighting systems in accommodation spaces, wheelhouses and passenger spaces	NRC, at the latest on issue or renewal of the Community certificate after 1.1.2035
10.03b	Permanently installed fire-fighting systems in engine rooms, boiler rooms and pump rooms	( <sup>1</sup> )
10.04	Application of the European standard to dinghies	NRC, at the latest on issue or renewal of the Community certificate after 1.1.2015
10.05(2)	Inflatable life jackets	NRC, at the latest on issue or renewal of the Community certificate after 1.1.2010. Life jackets which have been on board on 30.9.2003 may be used until the issue or renewal of the Community certificate after 1.1.2010.
	CHAPTER 11	
11.02(4)	Equipment of outer edges of decks, side decks and work stations	NRC, at the latest on issue or renewal of the Community certificate after 1.1.2015
11.04	Side decks	( <sup>2</sup> ) First issue or renewal of the Community certificate after 1.1.2035, when larger than 7,30 m
11.05(1)	Access to workplaces	NRC, at the latest on issue or renewal of the Community certificate after 1.1.2035
paragraphs. 2 and 3	Doors and accesses, exits and passageways where there is more than a 0,50 m difference in floor level	Issue or renewal of the Community certificate
paragraph 4	Stairs in working spaces which are manned continuously	NRC, at the latest on issue or renewal of the Community certificate after 1.1.2035
11.06(2)	Exits and emergency exits	NRC, at the latest on issue or renewal of the Community certificate after 1.1.2035
11.07(1), 2nd sentence	Ladders, steps and similar devices	NRC, at the latest on issue or renewal of the Community certificate after 1.1.2035
paragraphs 2 and 3		Issue or renewal of the Community certificate
11.10	Hatch covers	NRC, at the latest on issue or renewal of the Community certificate after 1.1.2010
11.11	Winches	NRC, at the latest on issue or renewal of the Community certificate after 1.1.2010

(<sup>1</sup>) 1. Permanent CO<sub>2</sub> fire-fighting systems installed before 1 October 1980 may remain in use until the issue or renewal of the Community certificate after 1 January 2035, if they comply with the requirements of Article 7.03(5) of the Rhine Vessel Inspection Regulation in force on 1 April 1976.

2. Permanent CO<sub>2</sub> fire-fighting systems installed between 1 April 1992 and 31 December 1994 may remain in use until the issue or renewal of the Community certificate after 1 January 2035, if they comply with the requirements of Article 7.03(5) of the Rhine Vessel Inspection Regulation in force on 31 December 1994.

3. Recommendations of the CCNR issued between 1 April 1992 and 31 December 1994 with regard to Article 7.03(5) of the Rhine Vessel Inspection Regulation in force on 31 December 1994 remain valid until the issue or renewal of the Community certificate after 1 January 2035.

4. Article 10.03b(2)(a) is only applicable until the issue or renewal of the Community certificate after 1 January 2035 if those installations have been installed in vessels laid down after 1 October 1992.

(<sup>2</sup>) The provision applies to vessels laid down after 31.12.1994 and to vessels in service with the following proviso: The requirements of Article 11.04 must be complied with where the entire hold area is renewed.

Where a conversion modifying the clear width of the side deck covers the entire length of the side decks,

(a) Article 11.04 must be complied with, if the clear width of the side deck before the conversion to a height of 0,90 m, or if the clear width above that height is to be reduced,

(b) the clear width of the side deck before the conversion to a height of 0,90 m, or the clear width above that height must not be lower than the measurements indicated in Article 11.04.

**▼B**

Article and paragraph	Content	Deadline and comments
11.12(2) to (6) and (8) to (10)	Cranes: manufacturer's plate, maximum permissible loadings, protection devices, calculation test, inspection by experts, certificates on board	NRC, at the latest on issue or renewal of the Community certificate after 1.1.2015
11.13	Storing of flammable liquids	NRC, at the latest on issue or renewal of the Community certificate
	<b>CHAPTER 12</b>	
12.01(1)	Accommodation for the persons lodging habitually on board	NRC, at the latest on issue or renewal of the Community certificate after 1.1.2035
12.02(3)	Situation of floors	NRC, at the latest on issue or renewal of the Community certificate after 1.1.2035
paragraph 4	Living and sleeping quarters	NRC, at the latest on issue or renewal of the Community certificate after 1.1.2035
paragraph 6	Headroom in the accommodation	NRC, at the latest on issue or renewal of the Community certificate after 1.1.2035
paragraph 8	Free floor area of communal living quarters	NRC, at the latest on issue or renewal of the Community certificate after 1.1.2035
paragraph 9	Cubic capacity of rooms	NRC, at the latest on issue or renewal of the Community certificate after 1.1.2035
paragraph 10	Volume of airspace per person	NRC, at the latest on issue or renewal of the Community certificate after 1.1.2035
paragraph 11	Size of doors	NRC, at the latest on issue or renewal of the Community certificate after 1.1.2035
paragraph 12(a) and (b)	Situation of stairs	NRC, at the latest on issue or renewal of the Community certificate after 1.1.2035
paragraph 13	Pipes carrying dangerous gases or liquids	NRC, at the latest on issue or renewal of the Community certificate after 1.1.2035
12.03	Sanitary installations	NRC, at the latest on issue or renewal of the Community certificate after 1.1.2035
12.04	Galleys	NRC, at the latest on issue or renewal of the Community certificate after 1.1.2035
12.05	Potable water	NRC, at the latest on 31.12.2006
12.06	Heating and ventilation	NRC, at the latest on issue or renewal of the Community certificate after 1.1.2035
12.07(1), second sentence	Other accommodation installations	NRC, at the latest on issue or renewal of the Community certificate after 1.1.2035
	<b>CHAPTER 15</b>	
15.01(1)(d)	Non-application of Article 9.14 (3) second sentence for rated voltages of over 50V	NRC, at the latest on issue or renewal of the Community certificate after 1.1.2010
paragraph 2(c)	Prohibition of solid fuel heaters according to Article 13.07	NRC, at the latest on issue or renewal of the Community certificate after 1.1.2010 The provision does not apply to craft with solid fuel engines (steam engines).
(e)	Prohibition of liquefied gas installations according to Chapter 14	NRC, at the latest on issue or renewal of the Community certificate after 1.1.2045. The transitional provision applies only if alarm systems are fitted in accordance with Article 15.15(9)

**▼M3**

**▼B**

Article and paragraph	Content	Deadline and comments
15.02(2)	Number and position of bulkheads	NRC, at the latest on issue or renewal of the Community certificate after 1.1.2045
paragraph 5, second sentence	Margin line if no bulkhead deck	For passenger vessels which have been laid down before 1.1.1996, the requirement applies at NRC, at the latest on issue or renewal of the Community certificate after 1.1.2045
paragraph 10(c)	Time for closure process	NRC, at the latest on issue or renewal of the Community certificate after 1.1.2015
paragraph 12	Optical warning system	NRC, at the latest on issue or renewal of the Community certificate
paragraph 15	Minimum height of double bottoms, width of wing voids	NRC, at the latest on issue or renewal of the Community certificate after 1.1.2045
15.03(1) to (6)	Intact stability	NRC, and when the maximum number of passengers is raised, at the latest on issue or renewal of the Community certificate after 1.1.2045
Paragraphs 7 and 8	Damaged stability	NRC, at the latest on issue or renewal of the Community certificate after 1.1.2045
paragraph 9	Two-compartment status	NRC
paragraphs 10 to 13	Damaged stability	NRC, at the latest on issue or renewal of the Community certificate after 1.1.2045
15.05(2)(a)	Number of passengers for whom the existence of an evacuation area according to Article 15.06(8) has been proven	NRC, at the latest on issue or renewal of the Community certificate after 1.1.2045
(b)	Number of passengers that has been taken into account for the stability calculation according to Article 15.03	NRC, at the latest on issue or renewal of the Community certificate after 1.1.2045
15.06(1)(a)	Passenger rooms on all decks aft of the collision bulkhead and forward of the level of the aft-peak bulkhead	NRC, at the latest on issue or renewal of the Community certificate after 1.1.2045
paragraph 3(c), first sentence	Clear height of exits	NRC, at the latest on issue or renewal of the Community certificate after 1.1.2045
second sentence	Clear width of doors of passenger cabins and other small rooms	For the measurement of 0,7 m, NRC, at the latest on issue or renewal of the Community certificate after 1.1.2045, applies
15.06(3)(f), first sentence	Size of emergency exits	NRC, at the latest on issue or renewal of the Community certificate after 1.1.2045
(g)	Exits of rooms intended for use by persons with reduced mobility	NRC, at the latest on issue or renewal of the Community certificate after 1.1.2045
paragraph 4(d)	Doors intended for use by persons with reduced mobility	NRC, at the latest on issue or renewal of the Community certificate after 1.1.2045
paragraph 5	Requirements for connecting corridors	NRC, at the latest on issue or renewal of the Community certificate after 1.1.2045
paragraph 6(b)	Escape routes to evacuation areas	NRC, at the latest on issue or renewal of the Community certificate after 1.1.2045
<b>▼M3</b>		
(c)	No escape routes through engine rooms	NRC, at the latest on issue or renewal of the Community certificate after 1.1.2007
	No escape routes through galleys	NRC, at the latest on issue or renewal of the Community certificate after 1.1.2015
<b>▼B</b>		
(d)	No rungs, ladders or the like installed along the escape routes	NRC, at the latest on issue or renewal of the Community certificate after 1.1.2045



**▼ B**

Article and paragraph	Content	Deadline and comments
<b>▼ M3</b> paragraph 7	Suitable safety guidance system	NRC, at the latest on issue or renewal of the Community certificate after 1.1.2015
<b>▼ B</b> paragraph 8	Requirements for muster areas	NRC, at the latest on issue or renewal of the Community certificate after 1.1.2045
paragraph 9	Requirements for stairs and their landings in the passenger areas	NRC, at the latest on issue or renewal of the Community certificate after 1.1.2045
paragraph 10(a), first sentence	Railing according to European standard EN 711: 1995	NRC, at the latest on issue or renewal of the Community certificate after 1.1.2045
second sentence	Height of bulwarks and railings of decks intended for use by persons with reduced mobility	NRC, at the latest on issue or renewal of the Community certificate after 1.1.2045
15.06(10)(b), second sentence	Clear width of openings used normally for the embarking or disembarking of persons with reduced mobility	NRC, at the latest on issue or renewal of the Community certificate after 1.1.2045
paragraph 13	Traffic areas and walls in traffic areas intended for use by persons with reduced mobility	NRC, at the latest on issue or renewal of the Community certificate after 1.1.2045
paragraph 14, first sentence	Design of glass doors and walls in traffic areas and window panes	NRC, at the latest on issue or renewal of the Community certificate after 1.1.2045
paragraph 15	Requirements for superstructures or their roofs consisting completely of panoramic panes	NRC, at the latest on issue or renewal of the Community certificate after 1.1.2045
<b>▼ M3</b> paragraph 16	Potable water systems in accordance with Article 12.05	NRC, at the latest 31.12.2006
<b>▼ B</b> paragraph 17, second sentence	Requirements for toilets fitted for use by persons with reduced mobility	NRC, at the latest on issue or renewal of the Community certificate after 1.1.2045
paragraph 18	Ventilation system for cabins without an opening window	NRC, at the latest on issue or renewal of the Community certificate after 1.1.2045
paragraph 19	Requirements of Article 15.06 for rooms in which crew members or shipboard personnel are accommodated	NRC, at the latest on issue or renewal of the Community certificate after 1.1.2045
<b>▼ M3</b> 15.07	Requirements for the propulsion system	NRC, at the latest on issue or renewal of the Community certificate after 1.1.2015
<b>▼ B</b> 15.08(2)	Requirements for loudspeaker systems in passenger areas	For passenger vessels with LWL of less than 40 m or for not more than 75 persons the provision applies at NRC, at the latest on issue or renewal of the Community certificate after 1.1.2010
paragraph 3	Requirements for the alarm system	For day-trip vessels the provision applies at NRC, at the latest on issue or renewal of the Community certificate after 1.1.2010
paragraph 4	Bilge level alarm for each watertight compartment	NRC, at the latest on issue or renewal of the Community certificate after 1.1.2010
paragraph 5	Two motor-driven bilge pumps	NRC, at the latest on issue or renewal of the Community certificate after 1.1.2010
paragraph 6	Permanently installed bilge system	NRC, at the latest on issue or renewal of the Community certificate after 1.1.2015

**▼ B**

Article and paragraph	Content	Deadline and comments
paragraph 8	Ventilation system for CO <sub>2</sub> bar-systems in rooms below deck	NRC, at the latest on issue or renewal of the Community certificate after 1.1.2010
15.09(3)	Appropriate transfer equipment	NRC, at the latest on issue or renewal of the Community certificate after 1.1.2010
<b>▼ M3</b>		
paragraph 4	Life-saving equipment	For passenger vessels which were equipped with collective life-saving appliances according to Article 15.09(5) before 1.1.2006, these appliances are considered an alternative to individual life-saving equipment.  For passenger vessels which were equipped with collective life-saving appliances according to Article 15.09(6) before 1.1.2006, these are considered an alternative to individual life-saving equipment until the issue or renewal of the Community certificate after 1.1.2010
<b>▼ B</b>		
paragraph 5(b) and (c)	Adequate seating space, buoyancy of at least 750 N	NRC, at the latest on issue or renewal of the Community certificate after 1.1.2010
(f)	Stable trim and appropriate grabbing devices	NRC, at the latest on issue or renewal of the Community certificate after 1.1.2010
(i)	Appropriate means of evacuation from evacuation areas on to life rafts	NRC, at the latest on issue or renewal of the Community certificate after 1.1.2010
paragraph 10	Ship's boat equipped with engine and searchlight	NRC, at the latest on issue or renewal of the Community certificate after 1.1.2010
15.10(2)	Article 9.16(3) also applicable to passageways and recreation rooms for passengers	NRC, at the latest on issue or renewal of the Community certificate after 1.1.2015
<b>▼ M3</b>		
paragraph 3	Adequate emergency lighting	NRC, at the latest on issue or renewal of the Community certificate after 1.1.2015
<b>▼ B</b>		
15.10(4)	Emergency power plant	For day-trip vessels with LWL of 25 m or less, the provision applies at NRC, at the latest on issue or renewal of the Community certificate after 1.1.2015
(f)	Emergency supply for searchlights according to Article 10.02 (2)(i)	NRC, at the latest on issue or renewal of the Community certificate after 1.1.2015
(i)	Emergency supply for lifts and lifting equipment according to Article 15.06(9),-second sentence	NRC, at the latest on issue or renewal of the Community certificate after 1.1.2015
<b>▼ M3</b>		
paragraph 6, first sentence	Partitions according to Article 15.11(2).	NRC, at the latest on issue or renewal of the Community certificate after 1.1.2015
second and third sentence	Installation of cables	NRC, at the latest on issue or renewal of the Community certificate after 1.1.2015
fourth sentence	Emergency power plant above the margin line	NRC, at the latest on issue or renewal of the Community certificate after 1.1.2015
<b>▼ B</b>		
15.11	Fire protection	
paragraph 1	Suitability for fire protection of materials and components	NRC, at the latest on issue or renewal of the Community certificate after 1.1.2045

**▼ B**

Article and paragraph	Content	Deadline and comments
paragraph 2	Design of partitions	NRC, at the latest on issue or renewal of the Community certificate after 1.1.2045
paragraph 3	Paints, lacquers and other surface treatment products as well as deck coverings used in rooms except engine rooms and store rooms shall be flame-retardant	NRC, at the latest on issue or renewal of the Community certificate after 1.1.2015
paragraph 4	Lounge ceilings and wall claddings manufactured from non-combustible material	NRC, at the latest on issue or renewal of the Community certificate after 1.1.2045
paragraph 5	Furniture and fittings in muster areas manufactured from non-combustible material	NRC, at the latest on issue or renewal of the Community certificate after 1.1.2045
paragraph 6	Tested according to Code	NRC, at the latest on issue or renewal of the Community certificate after 1.1.2045
paragraph 7	Insulation materials in lounges	NRC, at the latest on issue or renewal of the Community certificate after 1.1.2045
paragraph 8	Requirements for doors in partitions	NRC, at the latest on issue or renewal of the Community certificate after 1.1.2045
paragraph 9	Walls	On cabin vessels without automatic pressurised-water spraying systems, ends of walls between cabins: NRC, at the latest on issue or renewal of the Community certificate after 1.1.2010
paragraph 10	Partitions	NRC, at the latest on issue or renewal of the Community certificate after 1.1.2045
15.11(11)	Draught stops	NRC, at the latest on issue or renewal of the Community certificate after 1.1.2045
paragraph 12, 2nd sentence	Stairs made of steel or another equivalent non-combustible material	NRC, at the latest on issue or renewal of the Community certificate after 1.1.2045
paragraph 13	Encapsulation of internal stairs	NRC, at the latest on issue or renewal of the Community certificate after 1.1.2045
paragraph 14	Ventilation systems and air supply systems	NRC, at the latest on issue or renewal of the Community certificate after 1.1.2045
paragraph 15	Ventilation systems in galleys and stoves with extractors	NRC, at the latest on issue or renewal of the Community certificate after 1.1.2045
paragraph 16	Control centres, stairwells, muster areas and smoke extraction systems	NRC, at the latest on issue or renewal of the Community certificate after 1.1.2045
paragraph 17	Fire alarm system	For day-trip vessels: NRC, at the latest on issue or renewal of the Community certificate after 1.1.2010
<b>▼ M3</b>		
15.12(1)(c)	Portable fire extinguishers in galleys	NRC, at the latest on issue or renewal of the Community certificate
paragraph 2(a)	Second fire-extinguishing pump	NRC, at the latest on issue or renewal of the Community certificate after 1.1.2010
paragraph 3(b) and (c)	Pressure and water jet length	NRC, at the latest on issue or renewal of the Community certificate after 1.1.2010
<b>▼ B</b>		
paragraph 6	Materials, protection against failure	NRC, at the latest on issue or renewal of the Community certificate after 1.1.2010
15.12(7)	Avoidance of the possibility of freezing of pipes and hydrants	NRC, at the latest on issue or renewal of the Community certificate after 1.1.2010
paragraph 8(b)	Independent operation of fire extinguishing pumps	NRC, at the latest on issue or renewal of the Community certificate after 1.1.2010

**▼ B**

Article and paragraph	Content	Deadline and comments
(c)	Water jet length on all decks	NRC, at the latest on issue or renewal of the Community certificate after 1.1.2010
(d)	Installation of fire extinguishing pumps	NRC, at the latest on issue or renewal of the Community certificate after 1.1.2010
<b>▼ M3</b> paragraph 9	Fire-extinguishing system in engine rooms	NRC, at the latest on issue or renewal of the Community certificate after 1.1.2015
<b>▼ B</b> 15.14(1)	Waste water collection and disposal facilities	For cabin vessels with no more than 50 berths and for day-trip vessels: NRC, at the latest on issue or renewal of the Community certificate after 1.1.2045
paragraph 2	Requirements for waste water collection tanks	For cabin vessels with no more than 50 berths and for day-trip vessels with no more than 50 passengers: NRC, at the latest on issue or renewal of the Community certificate after 1.1.2045
15.15(1)	Damage stability	NRC, at the latest on issue or renewal of the Community certificate after 1.1.2045
paragraph 4	(Left void)	
paragraph 5	Equipped with a ship's boat, a platform or an equivalent installation	For passenger vessels licensed for a maximum of 250 passengers or 50 berths: NRC, at the latest on issue or renewal of the Community certificate after 1.1.2010
15.15(6)	Equipped with a ship's boat, a platform or an equivalent installation	For passenger vessels licensed for a maximum of 250 passengers or 50 berths: NRC, at the latest on issue or renewal of the Community certificate after 1.1.2010
paragraph 9(a)	Alarm systems for liquefied gas installations	NRC, at the latest on renewal of the certificate according to Article 14.15
(b)	Collective life-saving appliances according to Article 15.09(5)	NRC, at the latest on issue or renewal of the Community certificate after 1.1.2010
	<b>CHAPTER 16</b>	
16.01(2)	Special winches or equivalent coupling devices	The requirement applies to craft licensed before 1.1.1995 for pushing without proper securing equipment, only at NRC, at the latest on issue or renewal of the Community certificate after 1.1.2035.
16.01(3), last sentence	Requirements for drive units	NRC, at the latest on issue or renewal of the Community certificate after 1.1.2035
	<b>CHAPTER 17</b>	
17.02(3)	Additional requirements	The same transitional provisions as those indicated under the relevant article apply.
17.03(1)	General alarm system	NRC, at the latest on issue or renewal of the Community certificate
paragraph 4	Maximum authorised load	NRC, at the latest on issue or renewal of the Community certificate
17.04(2) and (3)	Residual safety clearance	NRC, at the latest on issue or renewal of the Community certificate
17.05(2) and (3)	Residual freeboard	NRC, at the latest on issue or renewal of the Community certificate
17.06, 17.07 and 17.08	Heeling test and confirmation of stability	NRC, at the latest on issue or renewal of the Community certificate



Article and paragraph	Content	Deadline and comments
17.09	Draught marks and draught scales	NRC, at the latest on issue or renewal of the Community certificate
	CHAPTER 20 The transitional provisions on Chapter 20 of the Rhine Vessel Inspection Regulation apply	
21.01 to 21.02	CHAPTER 21	The requirements apply to recreational craft built before 1.1.1995, only at NRC, at the latest on issue or renewal of the Community certificate after 1.1.2035.

*Article 24.03*

**Derogations for craft which were laid down on or before 1 April 1976**

1. In addition to the provisions of Article 24.02, the following provisions may be applied to craft which were laid down on or before 1 April 1976.

The following definitions apply in the table below:

- ‘RC’: The provision does not apply to craft which are already operating, unless the parts concerned are replaced or converted, i.e. the provision applies only to the Replacement or Conversion of the parts or areas concerned. If existing parts are replaced by replacement parts using the same technology and of the same type, this does not constitute replacement (‘R’) within the meaning of the transitional provisions.
- ‘Issue or renewal of the Community certificate’: The provision must be complied with by the time of the next issue or renewal of the Community certificate after the date indicated.

Article and paragraph	Content	Deadline and comments
3.03(1)(a)	CHAPTER 3 Situation of collision bulkhead	RC, at the latest on issue or renewal of the Community certificate after 1.1.2035
3.04(2)	Common surfaces of bunkers and accommodation and passenger areas	RC, at the latest on issue or renewal of the Community certificate after 1.1.2035
paragraph 7	Maximum permissible sound pressure level	Issue or renewal of the Community certificate after 1.1.2015
4.01(2), 4.02 and 4.03	CHAPTER 4 Safety clearance, freeboard, minimum freeboard	Issue or renewal of the Community certificate after 1.1.2015
7.01(2)	CHAPTER 7 Sound pressure generated by the vessel	RC, at the latest on issue or renewal of the Community certificate after 1.1.2015
7.05(2)	Monitoring of navigation lights	Issue or renewal of the Community certificate
8.08(3) and (4)	CHAPTER 8 Minimum pumping capacity and internal diameter of drainage pipes	Issue or renewal of the Community certificate after 1.1.2015
8.10(2)	Noise generated by a vessel under way	RC, at the latest on issue or renewal of the Community certificate after 1.1.2015

**▼B**

Article and paragraph	Content	Deadline and comments
	CHAPTER 9	
9.01	Requirements for electrical equipment	RC, at the latest on issue or renewal of the Community certificate after 1.1.2015
9.03	Protection against physical contact, intrusion of solid objects and the ingress of water	RC, at the latest on issue or renewal of the Community certificate after 1.1.2015
9.06	Maximum permissible voltages	RC, at the latest on issue or renewal of the Community certificate after 1.1.2015
9.10	Generators and motors	RC, at the latest on issue or renewal of the Community certificate after 1.1.2015
9.11(2)	Installation of accumulators	RC, at the latest on issue or renewal of the Community certificate after 1.1.2015
9.12	Switch-gear installations	RC, at the latest on issue or renewal of the Community certificate after 1.1.2015
9.14	Installation fittings	RC, at the latest on issue or renewal of the Community certificate after 1.1.2015
9.15	Cables	RC, at the latest on issue or renewal of the Community certificate after 1.1.2015
9.17	Navigation lights	RC, at the latest on issue or renewal of the Community certificate after 1.1.2015
	CHAPTER 12	
12.02(5)	Noise and vibration in accommodations	Issue or renewal of the Community certificate after 1.1.2015
	CHAPTER 15	
15.02(5), (6), first sentence, (7) to (11) and (13)	Margin line if no bulkhead deck	RC, at the latest on issue or renewal of the Community certificate after 1.1.2045
15.02(16)	Watertight windows	RC, at the latest on issue or renewal of the Community certificate after 1.1.2045
15.04	Safety clearance, freeboard, immersion measures	RC, at the latest on issue or renewal of the Community certificate after 1.1.2045
15.05	Number of passengers	Issue or renewal of the Community certificate after 1.1.2045
15.10(4), (6), (7), (8) and (11)	Emergency power plant	RC, at the latest on issue or renewal of the Community certificate after 1.1.2045

**▼M3****▼B**

- Article 15.11(3)(a), applies to day-trip vessels laid down on or before 1 April 1976 until the first issue or renewal of the Community certificate after 1.1.2045, with the proviso that only paints, varnishes, coatings and other materials used on surfaces facing escape routes and other materials for the surface treatment of panels must be fire-resistant and that smoke or toxic vapours may not develop to any dangerous extent.
- Article 15.11(12), applies to day-trip vessels laid down on or before 1 April 1976 until the first issue or renewal of the Community certificate after 1.1.2045, with the proviso that it is sufficient if, instead of stairs in the form of a load-bearing steel assembly, the stairs serving as an escape route are designed in such a way that they remain useable, in the event of a fire, for about the same time as stairs in the form of a load-bearing steel assembly.



*Article 24.04*

**Other derogations**

1. For craft the minimum freeboard of which was determined in accordance with Article 4.04 of the Rhine Vessel Inspection Regulation as applicable on 31 March 1983, the inspection body may, at the request of the owner, determine the freeboard in accordance with Article 4.03 of the Rhine Vessel Inspection Regulation as applicable on 1 January 1995.
2. Craft laid down before 1 July 1983 do not need to conform to Chapter 9, but must at least conform to Chapter 6 of the Rhine Vessel Inspection Regulation as applicable on 31 March 1983.
3. Article 15.06(3)(a) to (e), and Article 15.12(3)(a), with regard to the rule concerning a single hose length apply only to craft laid down after 30 September 1984, and to conversions of the areas concerned, at the latest when the Community certificate is renewed after 1 January 2045.
4. If it is difficult in practical terms to apply the provisions set out in this Chapter following the expiry of the transitional provisions, or if their application gives rise to unreasonably high costs, the inspection body may allow derogations from these provisions subject to recommendations by the Committee. These derogations must be entered in the Community certificate.
5. Where this provision refers, with regard to equipment design requirements, to a European or an international standard, such equipment may, after any revision of the standard, continue to be used for a further 20 years following the revision of the standard.

*Article 24.05*

**(Left void)**

*Article 24.06*

**Derogations for craft not covered by Article 24.01**

1. The following provisions apply:
  - (a) to craft for which a vessel certificate in accordance with the Rhine Vessel Inspection Regulation was issued for the first time between 1 January 1995 and 30 December 2008, provided they were not under construction or undergoing conversion on 31 December 1994;
  - (b) to craft which have obtained another traffic licence between 1 January 1995 and 30 December 2008.
2. It must be proved that those craft comply with the Rhine Vessel Inspection Regulation as applicable on the date on which the vessel certificate or the other traffic licence is granted.
3. The craft must be adapted to comply with provisions which enter into force following the first issue of the vessel certificate or other traffic licence in accordance with the transitional provisions set out in the table below.
4. Article 24.04(4) and (5), apply *MUTATIS MUTANDIS*.
5. The following definitions apply in the table below:
  - ‘NRC’: The provision does not apply to craft which are already operating, unless the parts concerned are replaced or converted, i.e. the provision applies only to Newly-built craft and to the Replacement or Conversion of the parts or areas concerned. If existing parts are replaced by replacement parts using the same technology and of the same type, this does not constitute replacement (‘R’) within the meaning of the transitional provisions.
  - ‘Issue or renewal of the Community certificate’: The provision must be complied with by the time of the next issue or renewal of the Community certificate after the date indicated.

**▼B**

Article and paragraph	Content	Deadline and comments	Valid for craft with vessel certificate or traffic licence before
	CHAPTER 3		
3.03(7)	Anchors not protruding in fore-sections of vessels	NRC, at the latest on issue or renewal of the Community certificate after 1.1.2041	1.10.1999
3.04(3), second sentence	Insulation in engine rooms	NRC, at the latest on issue or renewal of the Community certificate	1.4.2003
paragraph 3, third and fourth sentences	Openings and closing devices	NRC, at the latest on issue or renewal of the Community certificate	1.10.2003
	CHAPTER 6		
6.02(1)	Duplicated pilot valves in case of hydraulic drive units	NRC, at the latest on issue or renewal of the Community certificate after 1.1.2020	1.4.2007
	Separated pipework for the second drive unit in case of hydraulic drive units	NRC, at the latest on issue or renewal of the Community certificate after 1.1.2020	1.4.2007
6.03(1)	Connection of other consumers to hydraulic steering apparatus drive units	NRC, at the latest on issue or renewal of the Community certificate after 1.1.2020	1.4.2007
6.07(2)(a)	level alarm of the hydraulic tanks and alarm of the service pressure	NRC, at the latest with renewal of the Community certificate after 1.1.2010	1.4.2007
	CHAPTER 7		
7.02(2)	Obstructed vision ahead of the vessel 2 vessel lengths if less than 250 m	NRC, at the latest on issue or renewal of the Community certificate after 1.1.2049	30.12.2008
	CHAPTER 8		
8.02(4)	Protection of engine parts	NRC, at the latest on issue or renewal of the Community certificate	1.4.2003
8.03(3)	Protection against overspeed	NRC, at the latest on issue or renewal of the Community certificate after 1.1.2010	1.4.2004
	CHAPTER 9		
8.05(7) first sentence	Quick-closing valve on the tank operated from deck, even when the rooms in question are closed.	NRC, at the latest on issue or renewal of the Community certificate after 1.1.2015	1.4.2008
	CHAPTER 10		
8.05(9), first sentence	Sounding devices must be readable up to the maximum filling level	NRC, at the latest on issue or renewal of the Community certificate after 1.1.2010	1.4.1999
paragraph 13	Filling level control not only for main engines but also other engines needed for safe operation of the vessel	NRC, at the latest on issue or renewal of the Community certificate after 1.1.2015	1.4.1999



## ▼ B

Article and paragraph	Content	Deadline and comments	Valid for craft with vessel certificate or traffic licence before
	CHAPTER 8a The transitional provisions on Chapter 8a of the Rhine Vessel Inspection Regulation apply.		
	CHAPTER 10		
10.02(2)(a)	Certification of wire ropes and other ropes	The first rope replaced on the vessel: NRC, at the latest 1.1.2008. Second and third ropes: 1.1.2013.	1.4.2003
10.03(1)	European standard	On replacement, at the latest 1.1.2010	1.4.2002
paragraph 2	Suitable for fire category A, B and C	On replacement, at the latest 1.1.2010	1.4.2002
10.03a	Permanently installed fire-fighting systems in cabins, wheelhouses and passenger areas	NRC, at the latest on issue or renewal of the Community certificate after 1.1.2035	1.4.2002
10.03b	Permanently installed fire-fighting systems in engine rooms, boiler rooms and pump rooms	( <sup>1</sup> ) at the latest on issue or renewal of the Community certificate after 1.1.2035	1.4.2002
10.04	Application of the European standard to dinghies	NRC, at the latest on issue or renewal of the Community certificate after 1.1.2015	1.10.2003
10.05(2)	Inflatable life-jackets	NRC, at the latest on issue or renewal of the Community certificate after 1.1.2010. Life jackets which have been on board on 30.9.2003 may be used until the issue or renewal of the Community certificate after 1.1.2010.	1.10.2003
	CHAPTER 11		
11.13	Storage of flammable liquids	NRC, at the latest on issue or renewal of the Community certificate	1.10.2002
	CHAPTER 15		
15.01(1)(c)	Non-application of Article 8.06 (2), second sentence	NRC, at the latest on issue or renewal of the Community certificate	1.1.2006
(d)	Non-application of Article 9.14(3),- second sentence for rated voltages of over 50V	NRC, at the latest on issue or renewal of the Community certificate after 1.1.2010	1.1.2006
paragraph 2(b)	Prohibition of vaporising oil-burner stoves according to Article 13.04	NRC, at the latest on issue or renewal of the Community certificate	1.1.2006

(<sup>1</sup>) 1. Permanent CO<sub>2</sub> fire-fighting systems installed between 1 January 1995 and 31 March 2003 remain authorised until the issue or renewal of the Community certificate after 1 January 2035 if they comply with Article 10.03(5), of the Rhine Vessel Inspection Regulation as applicable on 31 March 2002.  
2. Recommendations of the Central Commission for Navigation on the Rhine issued between 1 January 1995 and 31 March 2002 regarding Article 10.03(5), of the Rhine Vessel Inspection Regulation as applicable on 31 March 2002 remain valid until the issue or renewal of the Community certificate after 1 January 2035.  
3. Article 10.05(2)(a), is applicable until the issue or renewal of the Community certificate after 1 January 2035 only if those systems have been installed in vessels laid down after 1 October 1992.

**▼B**

Article and paragraph	Content	Deadline and comments	Valid for craft with vessel certificate or traffic licence before
(c)	Prohibition of solid fuel heaters according to Article 13.07	NRC, at the latest on issue or renewal of the Community certificate after 1.1.2010	1.1.2006
<b>▼M3</b>			
(e)	Prohibition of liquefied gas installations according to Chapter 14	NRC, at the latest on issue or renewal of the Community certificate after 1.1.2045. The transitional provision applies only if alarm systems are fitted in accordance with Article 15.15(9)	1.1.2006
<b>▼B</b>			
15.02(2)	Number and position of bulkheads	NRC, at the latest on issue or renewal of the Community certificate after 1.1.2045	1.1.2006
paragraph 5, second sentence	Margin line if no bulkhead deck	For passenger vessels laid down before 1.1.1996, the requirement applies at NRC, at the latest on issue or renewal of the Community certificate after 1.1.2045	1.1.2006
paragraph 15	Minimum height of double bottoms, width of wing voids	NRC, at the latest on issue or renewal of the Community certificate after 1.1.2045	1.1.2006
15.03(1) to (6)	Intact stability	NRC, and when the maximum number of passengers is raised, at the latest on issue or renewal of the Community certificate after 1.1.2045	1.1.2006
15.03(7) and (8)	Damaged stability	NRC, at the latest on issue or renewal of the Community certificate after 1.1.2045	1.1.2006
paragraph 9	2-compartment status	NRC	1.1.2007
paragraphs 10 to 13	Damaged stability	NRC, at the latest on issue or renewal of the Community certificate after 1.1.2045	1.1.2006
15.05(2)(a)	Number of passengers for whom the existence of an evacuation area according to Article 15.06 section 8 has been proven	NRC, at the latest on issue or renewal of the Community certificate after 1.1.2045	1.1.2006
(b)	Number of passengers that has been taken into account for the stability calculation according to Article 15.03	NRC, at the latest on issue or renewal of the Community certificate after 1.1.2045	1.1.2006
15.06(1)	Passenger rooms on all decks forward of the level of the aft-peak bulkhead	NRC, at the latest on issue or renewal of the Community certificate after 1.1.2045	1.1.2006
paragraph 2	Cupboards and rooms referred to in Article 11.13 and intended for the storage of flammable liquids	NRC, at the latest on issue or renewal of the Community certificate	1.1.2006
paragraph 3(c), first sentence	Clear height of exits	NRC, at the latest on issue or renewal of the Community certificate after 1.1.2045	1.1.2006
second sentence	Clear width of doors of passenger cabins and other small rooms	For the measurement of 0,7 m, NRC, at the latest on issue or renewal of the Community certificate after 1.1.2045, applies	1.1.2006

**▼B**

Article and paragraph	Content	Deadline and comments	Valid for craft with vessel certificate or traffic licence before
15.06(3)(f), first sentence	Size of emergency exits	NRC, at the latest on issue or renewal of the Community certificate after 1.1.2045	1.1.2006
(g)	Exits intended for use by persons with reduced mobility	NRC, at the latest on issue or renewal of the Community certificate after 1.1.2045	1.1.2006
paragraph 4(d)	Doors intended for use by persons with reduced mobility	NRC, at the latest on issue or renewal of the Community certificate after 1.1.2045	1.1.2006
paragraph 5	Requirements for connecting corridors	NRC, at the latest on issue or renewal of the Community certificate after 1.1.2045	1.1.2006
paragraph 6(b)	Escape routes to evacuation areas	NRC, at the latest on issue or renewal of the Community certificate after 1.1.2045	1.1.2006
<b>▼M3</b>			
(c)	No escape routes through engine rooms	NRC, at the latest on issue or renewal of the Community certificate after 1.1.2007	1.1.2006
	No escape routes through galleys	NRC, at the latest on issue or renewal of the Community certificate after 1.1.2015	
<b>▼B</b>			
(d)	No rungs, ladders or the like installed along the escape routes	NRC, at the latest on issue or renewal of the Community certificate after 1.1.2045	1.1.2006
<b>▼M3</b>			
paragraph 7	Suitable safety guidance system	NRC, at the latest on issue or renewal of the Community certificate after 1.1.2015	1.1.2006
<b>▼B</b>			
paragraph 8	Requirements for muster areas	NRC, at the latest on issue or renewal of the Community certificate after 1.1.2045	1.1.2006
paragraph 9(a) to (c), (e), and last sentence	Requirements for stairs and their landings in the passenger areas	NRC, at the latest on issue or renewal of the Community certificate after 1.1.2045	1.1.2006
paragraph 10(a), first sentence	Railing according to European standard EN 711: 1995	NRC, at the latest on issue or renewal of the Community certificate after 1.1.2045	1.1.2006
second sentence	Height of bulwarks and railings of decks intended for use by persons with reduced mobility	NRC, at the latest on issue or renewal of the Community certificate after 1.1.2045	1.1.2006
(b), second sentence	Clear width of openings used for the embarking or disembarking of persons with reduced mobility	NRC, at the latest on issue or renewal of the Community certificate after 1.1.2045	1.1.2006
paragraph 12	Gangways in accordance with European standard EN 14206: 2003	NRC, at the latest on issue or renewal of the Community certificate	1.1.2006
paragraph 13	Traffic areas and walls in traffic areas, intended for use by persons with reduced mobility	NRC, at the latest on issue or renewal of the Community certificate after 1.1.2045	1.1.2006
paragraph 14, first sentence	Design of glass doors and walls in traffic areas and window panes	NRC, at the latest on issue or renewal of the Community certificate after 1.1.2045	1.1.2006

**▼B**

Article and paragraph	Content	Deadline and comments	Valid for craft with vessel certificate or traffic licence before
paragraph 15	Requirements for superstructures or their roofs consisting completely of panoramic panes	NRC, at the latest on issue or renewal of the Community certificate after 1.1.2045	1.1.2006
<b>▼M3</b>			
paragraph 16	Potable water systems in accordance with Article 12.05	NRC, at the latest 31.12.2006	1.1.2006
<b>▼B</b>			
paragraph 17, second sentence	Requirements for toilets fitted for use by persons with reduced mobility	NRC, at the latest on issue or renewal of the Community certificate after 1.1.2045	1.1.2006
paragraph 18	Ventilation system for cabins without an opening window	NRC, at the latest on issue or renewal of the Community certificate after 1.1.2045	1.1.2006
<b>▼M3</b>			
15.07	Requirements for the propulsion system	NRC, at the latest on issue or renewal of the Community certificate after 1.1.2015	1.1.2006
<b>▼B</b>			
15.08(2)	Requirements for loudspeaker systems in passenger areas	For passenger vessels with LWL of less than 40 m or for not more than 75 persons the provision applies at NRC, at the latest on issue or renewal of the Community certificate after 1.1.2010	1.1.2006
paragraph 3	Requirements for the alarm system	For day-trip vessels the provision applies at NRC, at the latest on issue or renewal of the Community certificate after 1.1.2010	1.1.2006
paragraph 3(c)	Alarm system enabling the vessel's command to alert the crew and shipboard personnel	For cabin vessels the provision applies at NRC, at the latest on issue or renewal of the Community certificate	1.1.2006
paragraph 4	Bilge level alarm for each watertight compartment	NRC, at the latest on issue or renewal of the Community certificate after 1.1.2010	1.1.2006
paragraph 5	Two motor-driven bilge pumps	NRC, at the latest on issue or renewal of the Community certificate after 1.1.2010	1.1.2006
paragraph 6	Permanently installed bilge system according to Article 8.06 section 4	NRC, at the latest on issue or renewal of the Community certificate after 1.1.2015	1.1.2006
paragraph 7	Inside opening of cold-storage rooms	NRC, at the latest on issue or renewal of the Community certificate	1.1.2006
paragraph 8	Ventilation system for CO <sub>2</sub> bar-systems in rooms below deck	NRC, at the latest on issue or renewal of the Community certificate after 1.1.2010	1.1.2006
paragraph 9	First-aid kits	NRC, at the latest on issue or renewal of the Community certificate	1.1.2006
15.09(1), first sentence	Lifebuoys	NRC, at the latest on issue or renewal of the Community certificate	1.1.2006
paragraph 2	Individual life-saving equipment	NRC, at the latest on issue or renewal of the Community certificate	1.1.2006

**▼ B**

Article and paragraph	Content	Deadline and comments	Valid for craft with vessel certificate or traffic licence before
paragraph 3	Appropriate transfer equipment	NRC, at the latest on issue or renewal of the Community certificate after 1.1.2010	1.1.2006
<b>▼ M3</b> paragraph 4	Life-saving equipment	For passenger vessels which were equipped with collective life-saving appliances according to Article 15.09(5) before 1.1.2006, these appliances are considered an alternative to individual life-saving equipment.  For passenger vessels which were equipped with collective life-saving appliances according to Article 15.09(6) before 1.1.2006, these are considered an alternative to individual life-saving equipment until the issue or renewal of the Community certificate after 1.1.2010	1.1.2006
<b>▼ B</b> paragraph 5(b) and (c)	Adequate seating space, buoyancy of at least 750 N	NRC, at the latest on issue or renewal of the Community certificate after 1.1.2010	1.1.2006
(f)	Stable trim and appropriate grabbing devices	NRC, at the latest on issue or renewal of the Community certificate after 1.1.2010	1.1.2006
(i)	Appropriate means of evacuation from the evacuation areas onto the life rafts	NRC, at the latest on issue or renewal of the Community certificate after 1.1.2010	1.1.2006
paragraph 9	Check on life-saving equipment according to the manufacturer's instructions	NRC, at the latest on issue or renewal of the Community certificate	1.1.2006
paragraph 10	Ship's boat equipped with engine and searchlight	NRC, at the latest on issue or renewal of the Community certificate after 1.1.2010	1.1.2006
paragraph 11	Stretcher	NRC, at the latest on issue or renewal of the Community certificate	1.1.2006
	Electrical Equipment		1.1.2006
15.10(2)	Article 9.16(3) also applicable to passageways and recreation rooms for passengers	NRC, at the latest on issue or renewal of the Community certificate after 1.1.2015	1.1.2006
<b>▼ M3</b> paragraph 3	Adequate emergency lighting	NRC, at the latest on issue or renewal of the Community certificate after 1.1.2015	1.1.2006
<b>▼ B</b> paragraph 4	Emergency power plant	For day-trip vessels with LWL of 25 m or less, the provision applies at NRC, at the latest on issue or renewal of the Community certificate after 1.1.2015	1.1.2006
(f)	Emergency supply for searchlights according to Article 10.02(2)(i)	NRC, at the latest on issue or renewal of the Community certificate after 1.1.2015	1.1.2006

**▼B**

Article and paragraph	Content	Deadline and comments	Valid for craft with vessel certificate or traffic licence before
(i)	Emergency supply for lifts and lifting equipment according to Article 15.06(9), second sentence	NRC, at the latest on issue or renewal of the Community certificate after 1.1.2015	1.1.2006
<b>▼M3</b>			
paragraph 6, first sentence	Partitions according to Article 15.11(2).	NRC, at the latest on issue or renewal of the Community certificate after 1.1.2015	1.1.2006
second and third sentences	Installation of cables	NRC, at the latest on issue or renewal of the Community certificate after 1.1.2015	1.1.2006
fourth sentence	Emergency power plant above the margin line	NRC, at the latest on issue or renewal of the Community certificate after 1.1.2015	1.1.2006
<b>▼B</b>			
15.11	Fire protection		1.1.2007
paragraph 1	Suitability for fire protection of materials and components	NRC, at the latest on issue or renewal of the Community certificate after 1.1.2045	1.1.2006
15.11(2)	Design of partitions	NRC, at the latest on issue or renewal of the Community certificate after 1.1.2045	1.1.2006
paragraph 3	Paints, lacquers and other surface treatment products as well as deck coverings used in rooms except engine rooms and store rooms shall be flame-retardant	NRC, at the latest on issue or renewal of the Community certificate after 1.1.2015	1.1.2006
paragraph 4	Lounge ceilings and wall claddings manufactured from non-combustible material	NRC, at the latest on issue or renewal of the Community certificate after 1.1.2045	1.1.2006
paragraph 5	Furniture and fittings in muster areas manufactured from non-combustible material	NRC, at the latest on issue or renewal of the Community certificate after 1.1.2045	1.1.2006
paragraph 6	Tested according to Code	NRC, at the latest on issue or renewal of the Community certificate after 1.1.2045	1.1.2006
paragraph 7	Insulation materials in lounges non-combustible	NRC, at the latest on issue or renewal of the Community certificate after 1.1.2045	1.1.2006
paragraph 8, (a), (b), (c), second sentence and (d)	Requirements for doors in partitions	NRC, at the latest on issue or renewal of the Community certificate after 1.1.2045	1.1.2006
paragraph 9	Walls	On cabin vessels without automatic pressurised-water spraying systems, ends of walls between cabins: NRC, at the latest on issue or renewal of the Community certificate after 1.1.2010	1.1.2006
paragraph 10	Partitions	NRC, at the latest on issue or renewal of the Community certificate after 1.1.2045	1.1.2006
paragraph 12, second sentence	Stairs made of steel or another equivalent non-combustible material	NRC, at the latest on issue or renewal of the Community certificate after 1.1.2045	1.1.2006
paragraph 13	Encapsulation of internal stairs by walls according to paragraph 2	NRC, at the latest on issue or renewal of the Community certificate after 1.1.2045	1.1.2006

**▼ B**

Article and paragraph	Content	Deadline and comments	Valid for craft with vessel certificate or traffic licence before
paragraph 14	Ventilation systems and air supply systems	NRC, at the latest on issue or renewal of the Community certificate after 1.1.2045	1.1.2006
paragraph 15	Ventilation systems in galleys and stoves with extractors	NRC, at the latest on issue or renewal of the Community certificate after 1.1.2045	1.1.2006
paragraph 16	Control centres, stairwells, muster areas and smoke extraction systems	NRC, at the latest on issue or renewal of the Community certificate after 1.1.2045	1.1.2006
paragraph 17	Fire alarm system	For day-trip vessels: NRC, at the latest on issue or renewal of the Community certificate after 1.1.2010	1.1.2006
<b>▼ M3</b>			
15.12(1)(c)	Portable fire extinguishers in galleys	NRC, at the latest on issue or renewal of the Community certificate	1.1.2006
paragraph 2(a)	Second fire-extinguishing pump	NRC, at the latest on issue or renewal of the Community certificate after 1.1.2010	1.1.2006
<b>▼ B</b>			
paragraph 4	Hydrant valves	NRC, at the latest on issue or renewal of the Community certificate	1.1.2006
paragraph 5	Axially connected reel	NRC, at the latest on issue or renewal of the Community certificate	1.1.2006
paragraph 6	Materials, protection against failure	NRC, at the latest on issue or renewal of the Community certificate after 1.1.2010	1.1.2006
paragraph 7	Avoidance of the possibility of freezing of pipes and hydrants	NRC, at the latest on issue or renewal of the Community certificate after 1.1.2010	1.1.2006
paragraph 8(b)	Independent operation of fire extinguishing pumps	NRC, at the latest on issue or renewal of the Community certificate after 1.1.2010	1.1.2006
(d)	Installation of fire extinguishing pumps	NRC, at the latest on issue or renewal of the Community certificate after 1.1.2010	1.1.2006
<b>▼ M3</b>			
paragraph 9	Fire-extinguishing system in engine rooms	NRC, at the latest on issue or renewal of the Community certificate after 1.1.2015. The transitional provision does not apply to passenger vessels which have been laid down after 31.12.1995, the hull of which is made of wood, aluminium or plastic and the engine rooms of which are not made of a material according to Article 3.04(3) and (4).	1.1.2006
<b>▼ B</b>			
15.13	Safety organisation	For day-trip vessels: NRC, at the latest on issue or renewal of the Community certificate	1.1.2006

**▼B**

Article and paragraph	Content	Deadline and comments	Valid for craft with vessel certificate or traffic licence before
15.14(1)	Waste water collection and disposal facilities	For cabin vessels with 50 or fewer berths, and for day-trip vessels: NRC, at the latest on issue or renewal of the Community certificate after 1.1.2045	1.1.2006
paragraph 2	Requirements for waste water collection tanks	For cabin vessels with 50 or fewer berths, and for day-trip vessels with 50 or fewer passengers: NRC, at the latest on issue or renewal of the Community certificate after 1.1.2045	1.1.2006
15.15	Derogations for certain passenger vessels		1.1.2006
paragraph 1	Damage stability	NRC, at the latest on issue or renewal of the Community certificate after 1.1.2045	1.1.2006
paragraph 4	(Left void)		
paragraph 5	Equipped with a ship's boat, a platform or an equivalent installation	For passenger vessels licensed for a maximum of 250 passengers or 50 berths: NRC, at the latest on issue or renewal of the Community certificate after 1.1.2010	1.1.2006
paragraph 6	Equipped with a ship's boat, a platform or an equivalent installation	For passenger vessels licensed for a maximum of 250 passengers or 50 berths: NRC, at the latest on issue or renewal of the Community certificate after 1.1.2010	1.1.2006
15.15(9)(a)	Alarm systems for liquefied gas installations	NRC, at the latest on renewal of the attestation according to Article 14.15	1.1.2006
(b)	Collective life-saving appliances according to Article 15.09 section 5	NRC, at the latest on issue or renewal of the Community certificate after 1.1.2010	1.1.2006

*Article 24.07***(Left void)**

## CHAPTER 24a

**ADDITIONAL TRANSITIONAL PROVISIONS FOR CRAFT NOT NAVIGATING ON ZONE R WATERWAYS***Article 24a.01***Application of transitional provisions to craft already in service and validity of previous Community certificates**

1. The following provisions apply:
  - (a) to craft for which a Community certificate was issued for the first time before 30 December 2008; and
  - (b) to craft which obtained another traffic licence before 30 December 2008, not navigating a Zone R waterway.
2. It must be proved that those craft comply with the provisions of Chapters 1 to 12 of Annex II to Directive 82/714/EEC on the date on which the Community certificate or the other traffic licence is issued.



**▼B**

3. Community certificates delivered before 30 December 2008 remain valid until the date of expiry indicated on the certificate. Article 2.09(2), remains applicable.

*Article 24a.02***Derogations for craft already in service**

1. Without prejudice to Articles 24a.03 and 24a.04, craft which do not fully comply with the provisions of this Directive must be adapted to comply with provisions which enter into force after the first issue of their Community certificate or other traffic licence in accordance with the transitional provisions listed in the table below.
2. The following definitions apply in the table below:
- ‘NRC’: The provision does not apply to craft which are already operating, unless the parts concerned are replaced or converted, i.e. the provision applies only to Newly-built craft and to the Replacement or Conversion of the parts or areas concerned. If existing parts are replaced by replacement parts using the same technology and of the same type, this does not constitute replacement (‘R’) within the meaning of the transitional provisions.
  - ‘Issue or renewal of the Community certificate’: The provision must be complied with by the time of the issue or next renewal of the Community certificate after 30 December 2008. If the certificate expires between 30 December 2008 and the day before 30 December 2009, that requirement is, however, only mandatory from 30 December 2009.

Article and paragraph	Content	Deadline and comments
	CHAPTER 3	
3.03(1)(a)	Location of collision bulkhead	NRC, at the latest on issue or renewal of the Community certificate after 30 December 2049
3.03(2)	Accommodations	NRC, at the latest on issue or renewal of the Community certificate after 30 December 2024
3.03(2)	Safety equipment	NRC, at the latest on issue or renewal of the Community certificate after 30 December 2029
3.03(4)	Gastight separation	NRC, at the latest on issue or renewal of the Community certificate after 30 December 2024
3.03(5), second paragraph	Monitoring of doors in the aft-peak bulkhead	
3.03(7)	Anchors not protruding in foresections of vessels	NRC, at the latest on issue or renewal of the Community certificate after 30 December 2049
3.04(3), second sentence	Insulation in engine rooms	NRC, at the latest on issue or renewal of the Community certificate
3.04(3), third and fourth sentences	Openings and locking devices	NRC, at the latest on issue or renewal of the Community certificate
3.04(6)	Exits from spaces classified as engine rooms as a result of this Directive	NRC, at the latest on issue or renewal of the Community certificate after 30 December 2049
	CHAPTER 4	
4.04	Draught marks	NRC, at the latest on issue or renewal of the Community certificate after 30 December 2024



**▼B**

Article and paragraph	Content	Deadline and comments
	CHAPTER 7	
<b>▼M3</b> 7.02(2) to (6)	Unobstructed view from the wheelhouse, except the following sections	NRC, at the latest on issue or renewal of the Community certificate after 1.1.2049
<b>▼B</b> 7.02(3), second paragraph	Unobstructed view in the sightline of the helmsman	NRC, at the latest on issue or renewal of the Community certificate after 30 December 2029
paragraph 5	Minimal light transmission of glazing	NRC, at the latest on issue or renewal of the Community certificate after 30 December 2024
7.03(7)	Shutdown of alarms	NRC, at the latest on issue or renewal of the Community certificate
paragraph 8	Automatic switch to alternative power supply	NRC, at the latest on issue or renewal of the Community certificate after 30 December 2024
7.04(1)	Control of main engines and steering devices	NRC, at the latest on issue or renewal of the Community certificate
7.04(2)	Control of main engines	If wheelhouses have not been designed for radar navigation by one person: NRC, at the latest on issue or renewal of the Community certificate after 30 December 2049 if the direction of motion can be achieved directly; at the latest on issue or renewal of the Community certificate after 30 December 2024 for other engines
7.09	Alarm system	NRC, at the latest on issue or renewal of the Community certificate after 30 December 2024
7.12 first paragraph	Retractable wheelhouses	NRC, at the latest on issue or renewal of the Community certificate. Without automatic retraction: NRC, at the latest on issue or renewal of the Community certificate after 30 December 2049
second and third paragraphs		NRC, at the latest on issue or renewal of the Community certificate
	CHAPTER 8	
8.01(3)	Only internal-combustion engines burning fuels having a flashpoint of more than 55 °C	NRC, at the latest on issue or renewal of the Community certificate after 30 December 2029
8.02(1)	Securing of engines against unintentional starting	NRC, at the latest on issue or renewal of the Community certificate after 30 December 2024
paragraph 4	Protection of machinery parts	NRC, at the latest on issue or renewal of the Community certificate
8.03(2)	Monitoring devices	NRC, at the latest on issue or renewal of the Community certificate after 30 December 2024
paragraph 3	Automatic protection against overspeed	NRC, at the latest on issue or renewal of the Community certificate after 30 December 2024
paragraph 5	Design of shaft bushings	NRC, at the latest on issue or renewal of the Community certificate after 30 December 2029

▼B

Article and paragraph	Content	Deadline and comments
8.05(1)	Steel tanks for liquid fuels	NRC, at the latest on issue or renewal of the Community certificate after 30 December 2029
8.05(2)	Automatic closing of tank valves	NRC, at the latest on issue or renewal of the Community certificate
paragraph 3	No fuel tanks forward of the collision bulkhead	NRC, at the latest on issue or renewal of the Community certificate after 30 December 2024
paragraph 4	No fuel tanks and their fittings above engines or exhaust pipes	NRC, at the latest on issue or renewal of the Community certificate after 30 December 2024. Until then, appropriate devices must ensure the safe evacuation of fuels
paragraph 6 third to fifth sentences	Installation and measurements of breather pipes and connection pipes	NRC, at the latest on issue or renewal of the Community certificate after 30 December 2024
paragraph 7	Shutoff device to be operated from the deck	NRC, at the latest on issue or renewal of the Community certificate after 30 December 2029
paragraph 9, first sentence	Capacity-gauging devices to be legible up to maximum filling level	NRC, at the latest on issue or renewal of the Community certificate after 30 December 2024
paragraph 13	Filling level control not only for main engines but also other engines needed for safe operation of the vessel	NRC, at the latest on issue or renewal of the Community certificate after 30 December 2029
8.06	Storage of lubricating oil, pipes and accessories	NRC, at the latest on issue or renewal of the Community certificate after 30 December 2049
8.07	Storage of oils used in power transmission systems, control and activating systems and heating systems, pipes and accessories	NRC, at the latest on issue or renewal of the Community certificate after 30 December 2049
8.08(8)	Simple closing device not sufficient for connection of ballast spaces to drainage pipes for holds capable of carrying ballast	NRC, at the latest on issue or renewal of the Community certificate after 30 December 2024
8.08(9)	Gauging devices in hold bilges	NRC, at the latest on issue or renewal of the Community certificate after 30 December 2024
8.09(2)	Installations for the collection of oily water and used oil stores	NRC, at the latest on issue or renewal of the Community certificate after 30 December 2024
8.10(3)	Emission limit of 65 dB(A) for stationary craft	NRC, at the latest on issue or renewal of the Community certificate after 30 December 2029
	<b>CHAPTER 9</b>	
9.01(1), second sentence	Relevant documents to be submitted to the inspection body	NRC, at the latest on issue or renewal of the Community certificate after 30 December 2049
9.01(2), second indent	Switching diagrams for main, emergency and distribution switchboard to be kept on board	NRC, at the latest on issue or renewal of the Community certificate after 30 December 2024
paragraph 3	Ambient inside and deck temperatures	NRC, at the latest on issue or renewal of the Community certificate after 30 December 2024
9.02(1) to (3)	Electricity supply systems	NRC, at the latest on issue or renewal of the Community certificate after 30 December 2024

▼B

Article and paragraph	Content	Deadline and comments
9.03	Protection against physical contact, intrusion of solid objects and the ingress of water	NRC, at the latest on issue or renewal of the Community certificate after 30 December 2029
9.05(4)	Cross-section of the earthing conductors	NRC, at the latest on issue or renewal of the Community certificate after 30 December 2029
9.11(4)	Effective ventilation when accumulators are installed in a closed compartment, cabinet or chest	NRC, at the latest on issue or renewal of the Community certificate
9.12	Switch-gear installations	NRC, at the latest on issue or renewal of the Community certificate after 30 December 2029
9.12(3)(b)	Earth detection device capable of giving both visual and audible alarm	NRC, at the latest on issue or renewal of the Community certificate after 30 December 2024
9.13	Emergency circuit breakers	NRC, at the latest on issue or renewal of the Community certificate after 30 December 2024
9.14	Installation fittings	NRC, at the latest on issue or renewal of the Community certificate after 30 December 2029
9.14(3), second sentence	Prohibition of single-pole switches in laundries, bathrooms, washrooms and other rooms with wet facilities	NRC, at the latest on issue or renewal of the Community certificate after 30 December 2024
9.15(2)	Minimum cross-section of 1,5 mm <sup>2</sup> per cable	NRC, at the latest on issue or renewal of the Community certificate after 30 December 2024
paragraph 10	Cables connected to retractable wheel-houses	NRC, at the latest on issue or renewal of the Community certificate after 30 December 2024
9.16(3), second sentence	Second circuit	NRC, at the latest on issue or renewal of the Community certificate after 30 December 2029
9.19	Alarm and safety systems for mechanical equipment	NRC, at the latest on issue or renewal of the Community certificate 30 December 2029
9.20	Electronic equipment	NRC, at the latest on issue or renewal of the Community certificate after 30 December 2049
9.21	Electromagnetic compatibility	NRC, at the latest on issue or renewal of the Community certificate after 30 December 2049
	<b>CHAPTER 10</b>	
10.01	Anchor equipment	NRC, at the latest on issue or renewal of the Community certificate after 30 December 2024
10.02(2)(a)	Certificate for mooring and other cables	First cable to be replaced on the vessel: NRC, at the latest on issue or renewal of the Community certificate after 30 December 2024 Second and third cables: 30 December 2029
10.03(1)	European standard	At replacement, at the latest 30 December 2024
paragraph 2	Suitability for Class A, B and C fires	At replacement, at the latest 30 December 2024

## ▼ B

Article and paragraph	Content	Deadline and comments
paragraph 4	Relation of CO <sub>2</sub> content and size of room	At replacement, at the latest 30 December 2024
10.03a	Permanently installed fire-fighting systems in accommodation spaces, wheelhouses and passenger spaces	NRC, at the latest on issue or renewal of the Community certificate after 30 December 2049
10.03b	Permanently installed fire-fighting systems in engine rooms, boiler rooms and pump rooms	CO <sub>2</sub> fire-fighting systems permanently installed before 1 October 1985 may remain in use until the issue or renewal of the Community certificate after 30 December 2049 if they comply with the requirements of Article 13.03 of Annex II of Directive 82/714/EEC
10.04	Application of the European standard to dinghies	NRC, at the latest on issue or renewal of the Community certificate after 30 December 2029
10.05(2)	Inflatable life jackets	NRC, at the latest on issue or renewal of the Community certificate after 30 December 2024  Life jackets which are on board on the day before 30 December 2008 can be used until renewal of the Community certificate after 30 December 2024
	CHAPTER 11	
11.02(4)	Equipment of outer edges of decks, side decks and work stations	NRC, [at the latest on issue or renewal of the Community certificate after 30 December 2029
11.04	Side decks	First issue or renewal of the Community certificate <sup>(1)</sup> after 30 December 2049 where width exceeds 7,30 m
11.05(1)	Access to workplaces	NRC, at the latest on issue or renewal of the Community certificate after 30 December 2049
paragraphs 2 and 3	Doors and accesses, exits and passageways where there is more than a 0,50 m difference in floor level	NRC, at the latest on issue or renewal of the Community certificate
paragraph 4	Stairs in working spaces which are manned continuously	NRC, at the latest on issue or renewal of the Community certificate after 30 December 2049
11.06(2)	Exits and emergency exits	NRC, at the latest on issue or renewal of the Community certificate after 30 December 2049
11.07(1), second sentence	Ladders, steps and similar devices	NRC, at the latest on issue or renewal of the Community certificate after 30 December 2049
paragraphs 2 and 3		NRC, at the latest on issue or renewal of the Community certificate

<sup>(1)</sup> The provision applies to vessels laid down 2 years after the date of entry into force of this Directive and to vessels in service with the following proviso:

The requirements of Article 11.04 must be complied with where the entire hold area is renewed.

Where a conversion modifying the clear width of the side deck covers the entire length of the side decks,

(a) Article 11.04 must be complied with if the clear width of the side deck before the conversion to a height of 0,90 m, or the clear width above that height is to be reduced,

(b) the clear width of the side deck before the conversion, to a height of 0,90 m, or the clear width above that height must not be lower than the measurements indicated in Article 11.04.

**▼B**

Article and paragraph	Content	Deadline and comments
11.10	Hatch covers	NRC, at the latest on issue or renewal of the Community certificate after 30 December 2024
11.11	Winches	NRC, at the latest on issue or renewal of the Community certificate after 30 December 2024
11.12(2) to (6) and (8) to (10)	Cranes: manufacturer's plate, maximum permissible loadings, protection devices, calculation test, inspection by experts, certificates on board	NRC, at the latest on issue or renewal of the Community certificate after 30 December 2029
11.13	Storing of flammable liquids	NRC, at the latest on issue or renewal of the Community certificate
	<b>CHAPTER 12</b>	
12.01(1)	Accommodation for the persons lodging habitually on board	NRC, at the latest on issue or renewal of the Community certificate after 30 December 2049
12.02(3)	Situation of floors	NRC, at the latest on issue or renewal of the Community certificate after 30 December 2049
paragraph 4	Living and sleeping quarters	NRC, at the latest on issue or renewal of the Community certificate after 30 December 2049
12.02(5)	Noise and vibration in accommodations	NRC, at the latest on issue or renewal of the Community certificate after 30 December 2029
paragraph 6	Headroom in accommodations	NRC, at the latest on issue or renewal of the Community certificate after 30 December 2049
paragraph 8	Free floor area of communal living quarters	NRC, at the latest on issue or renewal of the Community certificate after 30 December 2049
paragraph 9	Cubic capacity of rooms	NRC, at the latest on issue or renewal of the Community certificate after 30 December 2049
paragraph 10	Volume of airspace per person	NRC, at the latest on issue or renewal of the Community certificate after 30 December 2049
paragraph 11	Size of doors	NRC, at the latest on issue or renewal of the Community certificate after 30 December 2049
paragraph 12(a) and (b)	Situation of stairs	NRC, at the latest on issue or renewal of the Community certificate after 30 December 2049
paragraph 13	Pipes carrying dangerous gases or liquids	NRC, at the latest on issue or renewal of the Community certificate after 30 December 2049
12.03	Sanitary installations	NRC, at the latest on issue or renewal of the Community certificate after 30 December 2049
12.04	Galleys	NRC, at the latest on issue or renewal of the Community certificate after 30 December 2049
12.05	Potable water	NRC, at the latest on issue or renewal of the Community certificate

**▼B**

Article and paragraph	Content	Deadline and comments
12.06	Heating and ventilation	NRC, at the latest on issue or renewal of the Community certificate after 30 December 2049
12.07 section 1, second sentence	Other accommodation installations	NRC, at the latest on issue or renewal of the Community certificate after 30 December 2049
	CHAPTER 15 Passenger vessels	see Article 8 of this Directive
	CHAPTER 15a Passenger sailing vessels	see Article 8 of this Directive
16.01(2)	CHAPTER 16 Special winches or equivalent coupling devices	NRC, at the latest on issue or renewal of the Community certificate after 30 December 2049
paragraph 3, last sentence	Requirements for drive units	NRC, at the latest on issue or renewal of the Community certificate after 30 December 2049
	CHAPTER 17 Floating equipment	see Article 8 of this Directive
	CHAPTER 21 Recreational craft	see Article 8 of this Directive
22b.03	CHAPTER 22b Second independent steering apparatus drive unit	NRC, at the latest on issue or renewal of the Community certificate after 30 December 2029

*Article 24a.03***Derogations for craft which were laid down before 1 January 1985**

1. In addition to the provisions in Article 24a.02, craft which were laid down before 1 January 1985 may be exempted from the following provisions, under the conditions described in column 3 of the table below, provided the safety of the vessel and its crew is ensured in an appropriate manner.
2. The following definitions apply in the table below:
  - ‘NRC’: The provision does not apply to craft which are already operating, unless the parts concerned are replaced or converted, i.e. the provision only applies to Newly-built craft and to the Replacement or Conversion of the parts or areas concerned. If existing parts are replaced by replacement parts using the same technology and of the same type, this does not constitute replacement (‘R’) within the meaning of these transitional provisions.
  - ‘Issue or renewal of the Community certificate’: The provision must be complied with by the time of the first issue or next renewal of the Community certificate after 30 December 2008. If the certificate expires between 30 December 2008 and the day before 30 December 2009, that requirement is, however, only mandatory from 30 December 2009.



▼B

Article and paragraph	Content	Deadline and comments
	CHAPTER 3	
3.03(1)	Watertight collision bulkheads	NRC
3.03(2)	Accommodations, safety installations	NRC
3.03(5)	Openings in watertight bulkheads	NRC
3.04(2)	Surfaces of bunkers	NRC
3.04(7)	Maximum permissible sound pressure level in engine rooms	NRC
	CHAPTER 4	
4.01	Safety clearance	NRC, at the latest on issue or renewal of the Community certificate after 30 December 2019
4.02	Freeboard	NRC
	CHAPTER 6	
6.01(3)	Requirements of steering system	NRC
	CHAPTER 7	
7.01(2)	Maximum permissible sound pressure level in wheelhouse	NRC
7.05(2)	Monitoring of navigation lights	NRC
7.12	Retractable wheelhouses	NRC
	CHAPTER 8	
8.01(3)	Prohibition of certain liquid fuels	NRC
8.04	Engine exhaust system	NRC, at the latest on issue or renewal of the Community certificate
8.05(13)	Alarm device for level of fuel filling	NRC
8.08(2)	Equipment with bilge pumps	NRC
8.08(3) and (4)	Diameter and minimum pumping capacity of bilge pumps	NRC
8.08(5)	Self-priming bilge pumps	NRC
8.08(6)	Equipment with strainers	NRC
8.08(7)	Automatically closable fitting for aft peak	NRC
8.10(2)	Noise emitted by craft	NRC
	CHAPTER 9	
9.01(2)	Certificates for electrical equipment	NRC
9.01(3)	Installation of electrical equipment	NRC
9.06	Maximum permissible voltages	NRC
9.10	Generators and motors	NRC
9.11(2)	Accumulators	NRC, at the latest on issue or renewal of the Community certificate after 30 December 2029
9.12(2)	Switches, protective devices	NRC, at the latest on issue or renewal of the Community certificate after 30 December 2029

**▼B**

Article and paragraph	Content	Deadline and comments
9.14(3)	Simultaneous switching	NRC
9.15	Cables	NRC
9.16(3)	Lighting in engine rooms	NRC
9.17(1)	Switchboards for navigation lights	NRC
9.17(2)	Power supply for navigation lights	NRC
	<b>CHAPTER 10</b>	
10.01(9)	Anchor windlasses	NRC
10.04(1)	Dinghies according to standard	NRC
10.05(1)	Lifebuoys according to standard	NRC
10.05(2)	Life jackets according to standard	NRC
	<b>CHAPTER 11</b>	
11.11(2)	Safety of winches	NRC
	<b>CHAPTER 12</b>	
12.02(13)	Pipes carrying dangerous gases or liquids	NRC





*Article 24a.04***Other derogations**

If it is difficult in practical terms to apply the provisions set out in this Chapter following the expiry of the transitional provisions, or if their application gives rise to unreasonably high costs, the inspection body may allow derogations from these provisions subject to recommendations by the Committee. These derogations must be entered in the Community certificate.



▼B

## Appendix I

## Safety signs

<p>Figure 1 No entry for unauthorised persons</p>		<p>Colour: red/white/black</p>
<p>Figure 2 Fire, naked flame and smoking prohibited</p>		<p>Colour: red/white/black</p>
<p>Figure 3 Fire extinguisher</p>		<p>Colour: red/white</p>
<p>Figure 4 General danger warning</p>		<p>Colour: black/yellow</p>
<p>Figure 5 Extinguisher hose</p>		<p>Colour: red/white</p>

**▼B**

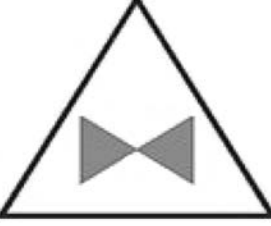
<p>Figure 6 Fire-fighting installation</p>		<p>Colour: red/white</p>	
<p>Figure 7 Wear acoustic protection device</p>		<p>Colour: blue/white</p>	
<p>Figure 8 First-aid kit</p>		<p>Colour: green/white</p>	
<b>▼M3</b>	<p>Figure 9 Quick-closing valve on the tank</p>		<p>Colour: brown/white</p>

**▼B**

The symbols actually used may slightly differ from or be more detailed than the graphical representations in this Appendix, provided the meaning is not changed and differences and modifications do not render the meaning incomprehensible.

▼ **M5***Appendix II***Administrative instructions**

- No 1: Requirements relating to the capacity for taking evasive action and turning capacity
- No 2: Requirements concerning prescribed (forward) speed, stopping capacity and capacity for going astern
- No 3: Requirements for coupling systems and coupling devices for craft suitable for propelling or being propelled in a rigid assembly
- No 4: Left void
- No 5: Noise measurements
- No 6: Left void
- No 7: Special anchors with reduced mass
- No 8: Strength of watertight windows
- No 9: Requirements for automatic pressurised water sprinklers
- No 10: Left void
- No 11: Completion of the Community Certificate
- No 12: Fuel tanks on floating equipment
- No 13: Minimum hull thickness of barges
- No 14: Left void
- No 15: Steerageway under vessel's own power
- No 16: Left void
- No 17: Appropriate fire alarm system
- No 18: Proof of buoyancy, trim and stability of the separated parts of a vessel
- No 19: Left void
- No 20: Equipment for vessels to be operated according to standards S1 and S2
- No 21: Requirements for low-location lighting
- No 22: Specific safety needs of persons with reduced mobility
- No 23: Left void
- No 24: Suitable gas warning equipment
- No 25: Electrical cables

*Note:*

In accordance with Article 5(7) of the Directive, for subjects covered by Annex IV, each Member State may allow less stringent requirements for the respective values indicated in the following Administrative instructions for craft operating exclusively on Zone 3 and Zone 4 waterways within its territory.

In accordance with Article 5(1) and (3) of the Directive, for subjects covered by Annex III, each Member State may adopt more stringent requirements for the respective values indicated in the following Administrative instructions for craft operating on Zone 1 and Zone 2 waterways within its territory.

## ▼M5

## ADMINISTRATIVE INSTRUCTION No 1

**Requirements relating to the capacity for taking evasive action and turning capacity**

(Articles 5.09 and 5.10 in conjunction with Articles 5.02(1), 5.03(1), 5.04 and 16.06 of Annex II)

**1. General conditions and boundary conditions relating to the evasive action test**

- 1.1. According to Article 5.09, vessels and convoys shall be able to take evasive action in good time and the capacity for such action shall be proved by evasive action manoeuvres in the test area in accordance with Article 5.03. This shall be proved by simulated evasive action manoeuvres to port and starboard with prescribed values whereby for specific turning speeds of the vessel in response to putting across and then checking the helm a certain time limit shall be complied with.

During tests the requirements of Section 2 shall be complied with keeping a keel clearance of at least 20 % of the draught, but not less than 0,50 m.

**2. Evasive action test procedure and recording of data**

(Diagram in Annex 1)

- 2.1. Evasive action manoeuvres shall be performed as follows:

With the vessel or convoy under way at a constant speed of  $V_0 = 13$  km/h in relation to the water, at the start of the manoeuvre (time  $t_0 = 0$  s, turning speed  $r = 0^\circ/\text{min}$ , rudder angle  $\delta_0 = 0^\circ$ , engine speed kept constant), evasive action to port or starboard is to be initiated by putting across the helm. The rudder shall be set to an angle  $\delta$ , or the steering unit to an angle  $\delta_a$  in the case of an active steering device, at the start of the manoeuvre, in accordance with the indications given in point 2.3. The rudder angle  $\delta$  (e.g.  $20^\circ$  to starboard) shall be maintained until the value  $r_1$  of the turning speed referred to in point 2.2 for the corresponding dimensions of the vessel or convoy is reached. When the turning speed  $r_1$  is reached, the time  $t_1$  shall be recorded and the rudder set to the same angle on the opposite side (e.g.  $20^\circ$  to port) so as to stop the turn and commence turning in the opposite direction, i.e., to reduce the turning speed to  $r_2 = 0$  and let it to rise again to the value given in point 2.2. When the turning speed  $r_2 = 0$  is reached, the time  $t_2$  shall be recorded. When the turning speed  $r_3$  given in point 2.2 is reached, the rudder shall be set in the opposite direction to the same angle  $\delta$ , so as to stop the turning movement. The time  $t_3$  shall be recorded. When the turning speed  $r_4 = 0$  is reached, the time  $t_4$  shall be recorded and the vessel or convoy shall be returned to its original course.

- 2.2. The following limit values shall be complied with to reach turning speed  $r_4$  depending on the dimensions of the vessels or the convoys and on the water depth  $h$ :

	Dimensions of vessels or convoys $L \times B$	Required turning speed $r_1 = r_3$ ( $^\circ/\text{min}$ )		Limit values for the time $t_4$ (s) in shallow and deep water		
		$\delta = 20^\circ$	$\delta = 45^\circ$	$1,2 \leq h/T \leq 1,4$	$1,4 < h/T < 2$	$h/T > 2$
1	All motor vessels; single-in-line convoys $\leq 110 \times 11,45$	$20^\circ/\text{min}$	$28^\circ/\text{min}$	150 s	110 s	110 s
2	Single-in-line convoys up to $193 \times 11,45$ or two-abreast convoys up to $110 \times 22,90$	$12^\circ/\text{min}$	$18^\circ/\text{min}$	180 s	130 s	110 s
3	Two-abreast convoys $\leq 193 \times 22,90$	$8^\circ/\text{min}$	$12^\circ/\text{min}$	180 s	130 s	110 s
4	Two-abreast convoys up to $270 \times 22,90$ or three-abreast convoys up to $193 \times 34,35$	$6^\circ/\text{min}$	$8^\circ/\text{min}$	(*)	(*)	(*)

(\*) In accordance with the decision of the nautical expert.

**▼M5**

The times  $t_1$ ,  $t_2$ ,  $t_3$  and  $t_4$  required to reach turning speeds  $r_1$ ,  $r_2$ ,  $r_3$  and  $r_4$  shall be recorded in the measurements report in Annex 2. The  $t_4$  values shall not exceed the limits given in the table.

2.3. At least four evasive action manoeuvres shall be carried out, namely:

- one to starboard with a rudder angle  $\delta = 20^\circ$
- one to port with a rudder angle  $\delta = 20^\circ$
- one to starboard with a rudder angle  $\delta = 45^\circ$
- one to port with a rudder angle  $\delta = 45^\circ$ .

If necessary (e.g. in the case of uncertainty about the values measured or of unsatisfactory manoeuvres), the evasive action manoeuvres shall be repeated. The turning speeds given in point 2.2 and the time limits shall be complied with. For active steering devices or special types of rudder, a position  $\delta_a$  of the steering unit or rudder angle  $\delta_a$  other than  $\delta = 20^\circ$  and  $\delta = 45^\circ$  may be selected, according to the expert's assessment, depending on the type of steering system.

2.4. In order to determine the turning speed, a rate-of-turn indicator in accordance with Annex IX to the Directive shall be on board.

2.5. In accordance with Article 5.04, the load condition during the evasive action manoeuvre shall be between 70 % and 100 % of the maximum deadweight. If the test is carried out with a smaller load, approval for downstream and upstream navigation shall be restricted to that load limit.

The procedure for evasive action manoeuvres and the terms used are shown in a diagram in Annex 1.

### 3. Turning capacity

The turning capacity of vessels and convoys whose length (L) does not exceed 86 m and width (B) does not exceed 22,90 m shall be considered sufficient under Article 5.10, in conjunction with Article 5.02(1) when during an upstream turning manoeuvre with an initial speed in relation to the water of 13 km/h, the limit values for stopping facing downstream established in Administrative instruction No 2 are complied with. The keel clearance conditions according to Section 1.1 shall be complied with.

### 4. Other requirements

4.1. Notwithstanding points 1 to 3, the following requirements shall be met:

- (a) for manually controlled steering systems, a single turn of the wheel shall correspond to a rudder angle of at least  $3^\circ$ ;
- (b) for powered steering systems, when the rudder is at maximum immersion, it shall be possible to achieve an average angular velocity of  $4^\circ/\text{s}$  over the rudder's entire turning range.

This requirement shall also be checked, with the vessel at full speed, for moving the rudder over a range from  $35^\circ$  port to  $35^\circ$  starboard. In addition, it shall be checked whether the rudder keeps the position of maximum angle at maximum propulsion power. For active steering systems or special types of rudder, this provision applies *mutatis mutandis*.

4.2. If any of the additional equipment referred to in Article 5.05 is needed in order to reach the required manoeuvring capacities, it shall comply with the requirements of chapter 6, and the following particulars shall be entered under item 52 of the Community Certificate:

'Flanking rudders (\*)/bow steering systems (\*)/other equipment (\*) referred to under item 34 is (\*)/are (\*) necessary to comply with the manoeuvrability requirements of chapter 5.

(\*) Delete as appropriate.'

### 5. Recording of data and reports

The measurements, reports and recording of data shall be carried out according to the procedure set out in Annex 2.

▼ M5

## ANNEX 1

to Administrative instruction No 1

## Diagram of the evasive action manoeuvre

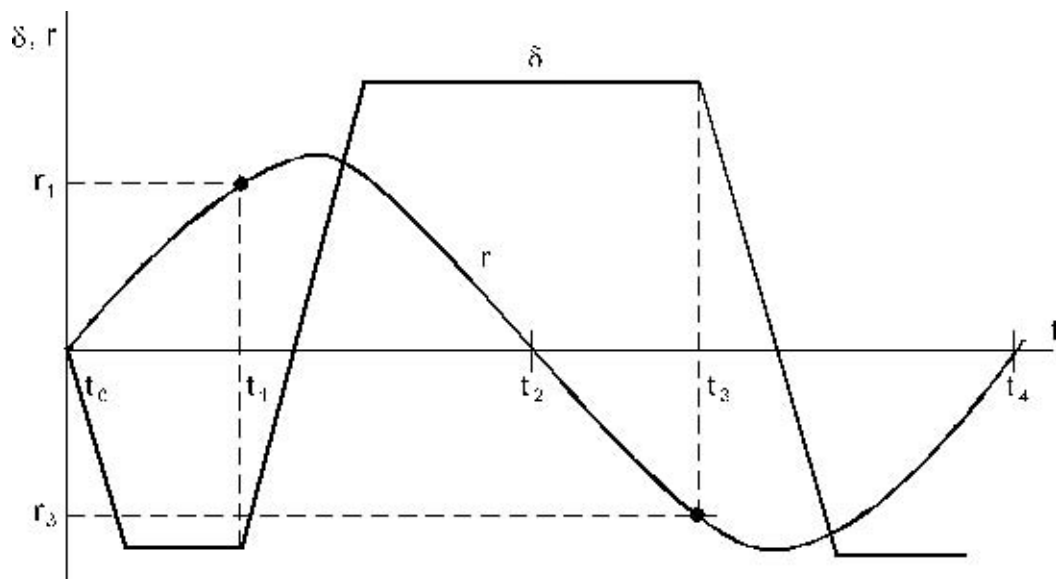
 $t_0$  = Start of evasive action manoeuvre $t_1$  = Time to reach turning speed  $r_1$  $t_2$  = Time to reach turning speed  $r_2 = 0$  $t_3$  = Time to reach turning speed  $r_3$  $t_4$  = Time to reach turning speed  $r_4 = 0$  (end of evasive action manoeuvre) $\delta$  = Rudder angle [°] $r$  = Turning speed [°/min]



▼ **M5**

## ANNEX 2

to Administrative instruction No 1

**Report on evasive action manoeuvre and turning capacity**

Inspection body: .....

Date: .....

Name: .....

Name of craft: .....

Owner: .....

Type of craft: ..... Test area: .....

or convoy: ..... Relevant water level [m]: .....

L × B [m × m]: ..... Depth of water h [m]: .....

T<sub>test</sub> [m]: ..... h/T: .....

Speed of the current [m/s]:

Load: ..... % of maximum .....

(during test) [t]: ..... deadweight: .....

Rate-of turn indicator

Type: .....

Type of rudder construction: normal construction/special construction (\*)

Active steering system: yes/no (\*)

Results of evasive action manoeuvres:

Time t <sub>1</sub> to t <sub>4</sub> required for the evasive action	Rudder angle $\delta$ or $\delta_a$ (*) at which evasive action commences and turning speed to be complied with $r_1 = r_3$				Comments
	$\delta = 20^\circ$ STAR (*)	$\delta = 20^\circ$ PORT (*)	$\delta = 45^\circ$ STAR (*)	$\delta = 45^\circ$ PORT (*)	
	$\delta_a = \dots$ STAR (*)	$\delta_a = \dots$ PORT (*)	$\delta_a = \dots$ STAR (*)	$\delta_a = \dots$ PORT (*)	
	$r_1 = r_3 = \dots$ °/min		$r_1 = r_3 = \dots$ °/min		
t <sub>1</sub> [s]					
t <sub>2</sub> [s]					
t <sub>3</sub> [s]					
t <sub>4</sub> [s]					
Limit value t <sub>4</sub> according to 2.2	Limit value t <sub>4</sub> = ... [s]				

**Turning capacity (\*)**

Geographic position at start of turning manoeuvre ..... km

Geographic position at end of turning manoeuvre ..... km

**Steering apparatus**

Type of operation: manual/powered (\*)

Rudder angle for each turn of the wheel (\*): ..... °

(\*) Delete as appropriate.

▼ **M5**

Angular velocity of the rudder over the whole range (\*): ..... °/s

Angular velocity of the rudder over the range 35° Port to 35° Starboard (\*): ..... °/s

---

(\*) Delete as appropriate.

▼ **M5**

## ADMINISTRATIVE INSTRUCTION No 2

**Requirements concerning prescribed (forward) speed, stopping capacity and capacity for going astern**

(Articles 5.06, 5.07 and 5.08 in conjunction with Articles 5.02(1), 5.03(1), 5.04 and 16.06 of Annex II)

**1. Maximum prescribed (forward) speed in accordance with Article 5.06**

The speed in relation to the water is satisfactory in accordance with Article 5.06(1) when it reaches at least 13 km/h. During tests, the following conditions shall be met in the same way as for the stopping test:

- (a) the keel clearance set out in point 2.1 shall be complied with;
- (b) the measuring, recording, registration and evaluation of test data shall be carried out.

**2. Stopping capacity and capacity for going astern prescribed in accordance with Articles 5.07 and 5.08**

2.1. Vessels and convoys are deemed able to stop facing downstream in good time in accordance with Article 5.07(1) when this is proved during a test of stopping in relation to the ground facing downstream at an initial speed in relation to the water of 13 km/h, with a keel clearance equal to at least 20 % of the draught but not less than 0,50 m.

- (a) In flowing water (current velocity of 1,5 m/s), stopping in relation to the water shall be demonstrated over a maximum distance measured in relation to the ground of:

550 m for vessels and convoys of:

- length  $L > 110$  m or
- width  $B > 11,45$  m,

or

480 m for vessels and convoys of:

- length  $L \leq 110$  m and
- width  $B \leq 11,45$  m.

The stopping manoeuvre is completed on coming to a stop in relation to the ground.

- (b) In standing water (current velocity of less than 0,2 m/s), stopping in relation to the water shall be demonstrated over a maximum distance, measured in relation to the ground of:

350 m for vessels and convoys of:

- length  $L > 110$  m or
- width  $B > 11,45$  m,

or

305 m for vessels and convoys of:

- length  $L \leq 110$  m and
- width  $B \leq 11,45$  m.

In standing water, a test shall also be performed to demonstrate that a speed of not less than 6,5 km/h can be reached when going astern.

The measuring, recording and registration of the test data referred to in (a) or (b) shall be carried out in accordance with the procedure set out in Appendix 1.

Throughout the entire test, the vessel or the convoy shall have adequate manoeuvrability.

2.2. In accordance with Article 5.04, during the test, vessels shall be loaded as far as possible to 70-100 % of their deadweight. This load condition shall be evaluated in accordance with Appendix 2. When the vessel or the

**▼M5**

convoy is loaded to less than 70 % at the time of the test, the permitted maximum displacement in downstream navigation shall be set in accordance with the actual load, provided that the limit values of point 2.1 are complied with.

- 2.3. If the actual values of the initial speed and current velocity at the time of the test do not meet the conditions set out in point 2.1, the results obtained shall be evaluated according to the procedure described in Appendix 2.

The permitted deviation of the initial speed of 13 km/h shall be not more than +1 km/h, and the current velocity in flowing water shall be between 1,3 and 2,2 m/s, otherwise the tests shall be repeated.

- 2.4. The permitted maximum displacement or the respective maximum load or the maximum immersed cross-section for vessels and convoys in downstream navigation shall be determined on the basis of the tests and entered in the Community Certificate.

▼ **M5***Appendix 1**to Administrative instruction No 2***MEASURING, RECORDING AND REGISTRATION OF DATA COLLECTED DURING STOPPING MANOEUVRE TESTS****1. Stopping manoeuvre**

The vessels and convoys referred to in Chapter 5 shall carry out a test in flowing water or in standing water, in a test area, to prove that they are capable of stopping facing downstream only with their propulsion system without the use of anchors. The stopping manoeuvre shall, in principle, be carried out in accordance with figure 1. It begins when the vessel is travelling at a constant speed of as near as possible to 13 km/h in relation to the water by reversing the engines from 'ahead' to 'astern' (point **A** of the order 'stop') and is completed when the vessel is stationary in relation to the ground (point **E**:  $v = 0$  in relation to the ground or point **D**:  $v = 0$  in relation to the water and in relation to the ground if the stopping manoeuvre is carried out in standing water).

When stopping manoeuvres are carried out in flowing water, the position and the moment of stopping in relation to the water shall also be recorded (the vessel moves at the speed of the current; point **D**:  $v = 0$  in relation to the water).

The data measured shall be entered in a report as shown in the diagram of table 1. Before the stopping manoeuvre is carried out, the unchanging data shall be entered at the top of the form.

The average current velocity ( $v_{STR}$ ) in the fairway shall be determined, if available, based on the reading of an established water level gauge, or by measuring the movement of a floating body and shall be entered in the report.

In principle, the use of current metres is permitted to determine the speed of the vessel in relation to the water during the stopping manoeuvre, if it is possible to record the movement and the required data in accordance with the procedure above.

**2. Registration of the data measured and recording them in the report (table 1)**

For the stopping manoeuvre, first of all the initial speed in relation to the water shall be determined. This can be done by measuring the time taken to travel between two markers on land. In flowing water, the average current velocity shall be taken into account.

The stopping manoeuvre is initiated by the order 'stop' **A**, given on passing a marker on land. Passing the land marker shall be recorded perpendicularly to the axis of the vessel and shall be entered in the report. Passing all other land markers during the stopping manoeuvre shall be similarly recorded and each marker (e.g. kilometre post) and the time of passing shall be noted in the report.

The values measured shall, if possible, be recorded at intervals of 50 m. In each case, note should be taken of the time when points **B** and **C** — if possible — as well as when points **D** and **E** are reached and the respective position shall be estimated. The data concerning the engine speed need not be recorded in the report, but should be noted to permit more accurate control of the initial speed.

**3. Description of the stopping manoeuvre**

The stopping manoeuvre according to figure 1 shall be presented in the form of a diagram. First of all, the time-traverse diagram shall be plotted using the measurements entered in the test report and points **A** to **E** shall be indicated. It will then be possible to determine the average speed between two measurement points and to plot the speed/time diagram.

This is done as follows (see figure 1):

By determining the quotient of the difference of position over the difference in time  $\Delta s/\Delta t$ , the average speed of the vessel for this period can be calculated.





▼ M5

## Appendix 2

## to Administrative instruction No 2

## EVALUATION OF THE RESULTS OF THE STOPPING MANOEUVRE

1. On the basis of the values recorded compliance with the limit values in accordance with Appendix 1 shall be verified. If the conditions for the stopping manoeuvre deviate substantially from the standard conditions, or if there are doubts as to the compliance with the limit values, the results shall be evaluated. To that end the following procedure may be applied for calculating stopping manoeuvres.
2. Theoretical stopping distances are determined under the standard conditions ( $S_{\text{reference}}$ ) of point 2.1 of Administrative instruction No 2 and under stopping manoeuvre conditions ( $S_{\text{actual}}$ ) and are compared with the stopping distance measured ( $S_{\text{measured}}$ ). The corrected stopping distance of the stopping manoeuvre under standard conditions ( $S_{\text{standard}}$ ) is calculated as follows:

Formula 2.1:

$$S_{\text{STANDARD}} = S_{\text{MEASURED}} \cdot \frac{S_{\text{REFERENCE}}}{S_{\text{ACTUAL}}} \leq \text{Limit value in accordance with point 2.1(a) or (b) of Administrative instruction No 2}$$

When the stopping manoeuvre has been carried out with a load of 70-100 % of the maximum deadweight in accordance with point 2.2 of Administrative instruction No 2 in order to calculate  $S_{\text{standard}}$  the displacement ( $D_{\text{reference}} = D_{\text{actual}}$ ) corresponding to the load at the time of the test shall be used for the determination of  $S_{\text{reference}}$  and  $S_{\text{actual}}$ .

When in determining  $S_{\text{standard}}$  according to formula 2.1, the limit value in question is exceeded or not reached, the value of  $S_{\text{reference}}$  shall be reduced or increased by variation of  $D_{\text{reference}}$  so that the limit value is complied with ( $S_{\text{standard}} = \text{limit value in question}$ ). The maximum displacement permitted in downstream navigation shall be set accordingly.

3. According to the limit values given in point 2.1(a) and (b) of Administrative instruction No 2, only the stopping distances measured in

— Phase I ('Full ahead' reversed to 'full astern'):  $S_I$

and

— Phase II (End of reversal until vessel stops in relation to the water):  $S_{II}$

shall be calculated (see figure 1). The total stopping distance is then:

Formula 3.1:

$$S_{\text{total}} = S_I + S_{II}$$

4. The particular stopping distances shall be calculated as follows:



## ▼ M5

## CALCULATION OF THE STOPPING MANOEUVRE

Figure 2

Diagram

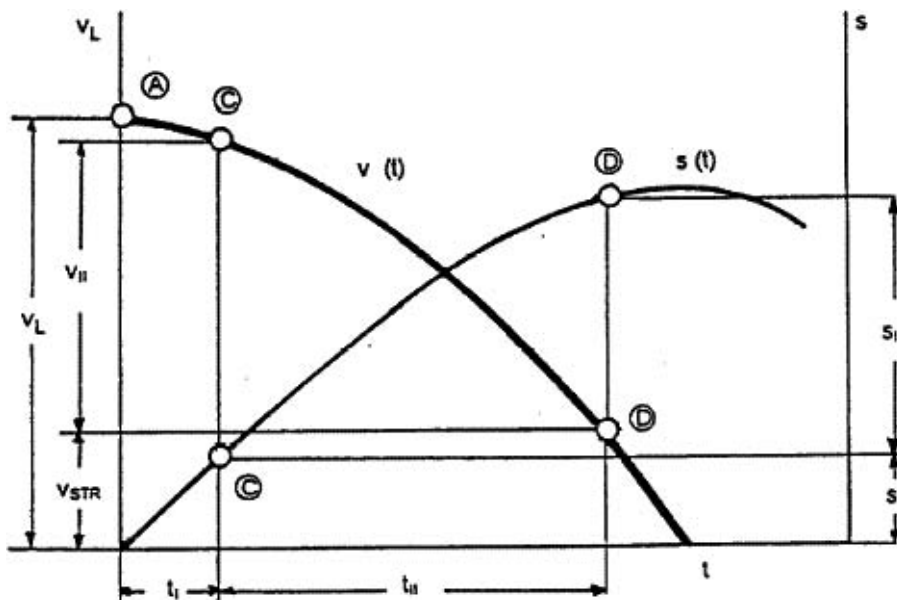

Calculation Formulae:

with the following coefficients

- 4.1.  $S_I = k_1 \cdot v_L \cdot t_1$   $t_1 \leq 20$  s —  $k_1$  according to table 1
- 4.2.  $S_{II} = k_2 \cdot v_{II}^2 \cdot \frac{D \cdot g}{k_3 \cdot F_{POR} + R_{TmII} - R_G} \cdot \left( k_4 + \frac{V_{STR}}{V_{II}} \right)$  —  $k_2, k_3, k_4$  according to table 1
- 4.3.  $R_{TmII} = (R_T/v^2) \cdot (k_7 \cdot k_6 \cdot (v_L - v_{STR}))^2$  —  $k_6, k_7$  according to table 1  
—  $R_T/v^2$  according to table 3
- 4.4.  $R_G = i \cdot D \cdot \rho \cdot g \cdot 10^{-6}$
- 4.5.  $V_{II} = k_6 \cdot (V_L - V_{STR})$  —  $k_6$  according to table 1
- 4.6.  $F_{POR} = f \cdot P_B$  —  $f$  according to table 2
- 4.7.  $t_{II} = \frac{S_{II}}{v_{II} \cdot \left( k_4 + \frac{v_{STR}}{v_{II}} \right)}$  —  $k_4$  according to table 1

In formulae 4.1 to 4.7:

$v_L$	Speed in relation to the ground at the start of reversal	(m/s)
$t_I$	Reversal time	(s)
$v_{II}$	Speed in relation to the water at the end of reversal	(m/s)
$D$	Displacement	(m <sup>3</sup> )
$F_{POR}$	Bollard pull in reverse	(kN)
$P_B$	Power of propulsion engine	(kW)

▼ **M5**

$R_{TmII}$	Average resistance during phase II, to be determined using the diagram for determining $R_T/v^2$	(kN)
$R_G$	Gradient resistance	(kN)
$i$	Gradient in m/km (if missing to be taken as 0,16)	(m/km)
$v_{STR}$	Average current velocity	(m/s)
$g$	Acceleration due to gravity (9,81)	(m/s <sup>2</sup> )
$\rho$	Density of water, $\rho$ fresh water = 1 000	(kg/m <sup>3</sup> )
$T$	Maximum draught (of vessel or convoy)	(m)
$h$	Water depth	(m)
$B$	Width	(m)
$L$	Length	(m)

The coefficients for the formulae 4.1, 4.2, 4.3, 4.4, 4.5, 4.6 and 4.7 can be taken from the tables below.

Table 1

**k factors for:**

- (a) Motor vessels and single file convoys
- (b) Two-abreast convoys
- (c) Three-abreast convoys

	a	b	c	Units
$k_1$	0,95	0,95	0,95	—
$k_2$	0,115	0,120	0,125	$\frac{kg \cdot s^2}{m^4}$
$k_3$	1,20	1,15	1,10	—
$k_4$	0,48	0,48	0,48	—
$k_6$	0,90	0,85	0,80	—
$k_7$	0,58	0,55	0,52	—

Table 2

**Coefficient f for ratio between bollard pull in reverse and the power of the propulsion engines**

Propulsion system	f	Units
Modern nozzles with rounded rear edge	0,118	kN/kW
Old nozzles with sharp rear edge	0,112	kN/kW
Propellers without nozzle	0,096	kN/kW
Rudder propellers with nozzles (generally sharp rear edge)	0,157	kN/kW
Rudder propellers without nozzles	0,113	kN/kW

▼ M5

Table 3

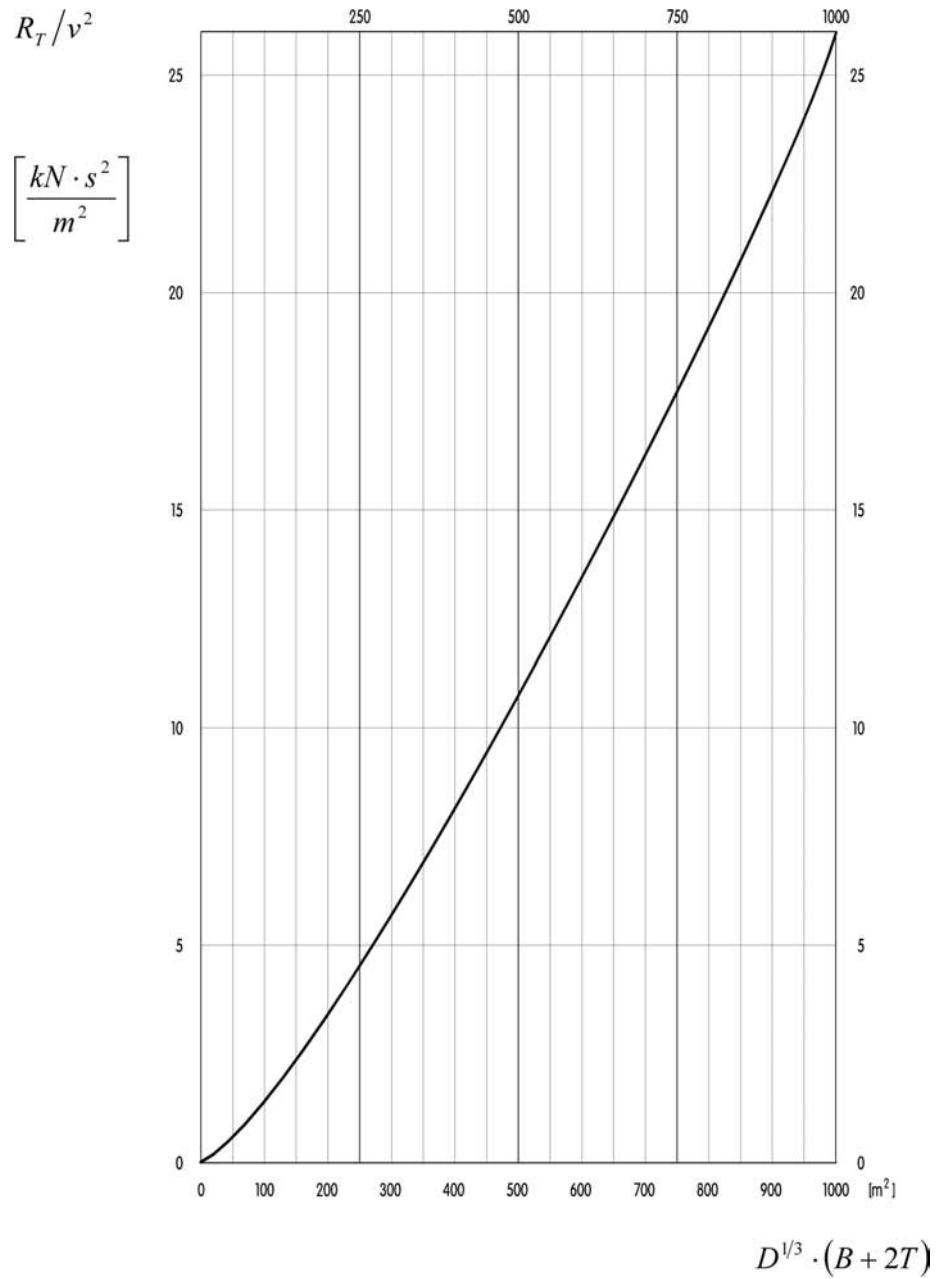
**Diagram concerning the calculation of resistance**To determine the value of  $R_T/v^2$  in relation to  $D^{1/3} [B + 2T]$ :

▼ **M5***Annex to Appendix 2**to Administrative instruction No 2***Examples on the application of Appendix 2****(Evaluation of the results of the stopping manoeuvre)**

## EXAMPLE I

1. **Data of vessels and convoy**

Formation: ordinary motor vessel with a (Europa IIa) lighter coupled abreast

	L [m]	B [m]	T <sub>max</sub> [m]	Dwt (*) <sub>max</sub> [t]	D <sub>max</sub> [m <sup>3</sup> ]	P <sub>B</sub> [kW]
Motor vessel	110	11,4	3,5	2 900	3 731	1 500
Lighter	76,5	11,4	3,7	2 600	2 743	—
Convoy	110	22,8	3,7	5 500	6 474	1 500

Propulsion system of the motor vessel: modern nozzles with rounded rear edge

(\*) *Dwt* = deadweight.

2. **Values measured during the stopping manoeuvre**

Current velocity:	$v_{STR_{actual}}$	=	1,4 m/s	≈	5,1 km/h
Speed of vessel (in relation to the water):	$V_{S_{actual}}$	=	3,5 m/s	≈	12,5 km/h
Speed of vessel (in relation to the ground):	$V_{L_{actual}}$	=	4,9 m/s	≈	17,6 km/h
Reversal time (measured) (point A to C):	$t_I$	=	16 s		
Stopping distance in relation to the water (point A to D):	$S_{MEASURED}$	=	340 m		
Load condition (possibly estimated):	$D_{actual}$	=	5 179 m <sup>3</sup>	≈	0,8 D <sub>max</sub>
Actual draught of convoy:	$T_{actual}$	=	2,96 m	≈	0,8 T <sub>max</sub>

3. **Limit value according to point 2.1(a) or (b) to be compared with  $S_{standard}$** 

Since B > 11,45 m and since the convoy is in flowing water, the following is applicable for this convoy under 2.1(a):

$$S_{standard} < 550 \text{ m}$$

4. **Determination of corrected stopping distance compared to standard conditions**

— **Measured value** according to Appendix 1 (see point 2)

$$s_{measured} = 340 \text{ m}$$

— **to be calculated:**

$s_{actual}$  as the sum of

$s_{I_{actual}}$  (according to formula 4.1 of Appendix 2 with  $v_{L_{actual}}$ )

and

$s_{II_{actual}}$  (according to formulae 4.2, 4.3, 4.4, 4.5 and 4.6 of Appendix 2 with actual speeds  $v_{II_{actual}}$ ,  $v_{STR_{actual}}$ ,  $D_{actual}$ )

$s_{reference}$  as the sum of

$s_{I_{reference}}$  (according to formula 4.1 of Appendix 2 with  $v_{L_{reference}}$ )

and

$s_{II_{reference}}$  (according to formulae 4.2 to 4.6 of Appendix 2 with the reference speeds according to 2.1 of the Adminis-

▼ **M5**

trative instruction and given that the load condition is greater than 70 % of the maximum load ( $\approx 80\%$ ):  
 $D_{reference} = D_{actual}$  and  $T_{reference} = T_{actual}$ )

— to be checked:

$$S_{standard} = S_{measured} \cdot \frac{S_{reference}}{S_{actual}} \leq 550 \text{ m}$$

## 4.1. Coefficients for the calculation taken from Appendix 2

Table 1

for $s_{I_{actual}}$ and $s_{I_{reference}}$	$k_1 = 0,95$
for $s_{II_{actual}}$ and $s_{II_{reference}}$	$k_2 = 0,12$
	$k_3 = 1,15$
	$k_4 = 0,48$
	$k_6 = 0,85$
	$k_7 = 0,55$

Table 2 (for modern nozzles with rounded rear edge)

$$f = 0,118$$

4.2. Calculation of  $S_{actual}$ 

- (a)  $s_{I_{actual}}$  with the values measured during the stopping manoeuvre (formula 4.1)

$$S_{I_{actual}} = k_1 \cdot v_{L_{actual}} \cdot t_{I_{actual}}$$

$$S_{I_{actual}} = 0,95 \cdot 4,9 \cdot 16 = 74,5 \text{ m}$$

- (b) Formula for  $s_{II_{actual}}$

$$S_{II_{actual}} = k \cdot v_{II_{actual}}^2 \cdot \frac{D_{actual} \cdot g}{k_3 \cdot F_{POR} + R_{TmII_{actual}} - R_G} \cdot \left( k_4 + \frac{V_{STR_{actual}}}{V_{II_{actual}}} \right)$$

- (c) Calculation of  $R_{TmII_{actual}}$  according to table 3 and formula 4.3 of Appendix 2

$$D_{actual}^{1/3} = 5 \cdot 179^{1/3} + 17,3 \text{ [m]}$$

$$D_{actual}^{1/3} \cdot (B + 2 \cdot T_{actual}) = 17,3 \cdot (22,8 + 5,92) = 496,8 \text{ [m}^2\text{]}$$

$$\text{according to table 3 } \frac{R_T}{v^2} = 10,8 \left[ \frac{kN \cdot s^2}{m^2} \right]$$

$$v_{L_{actual}} - v_{STR_{actual}} = 4,9 - 1,4 = 3,5 \text{ m/s}$$

$$R_{TmII_{actual}} = \frac{R_T}{v_2} \cdot \left( k_7 \cdot k_6 \cdot \left( v_{L_{actual}} - v_{STR_{actual}} \right) \right)^2 = 10,8 \cdot (0,55 \cdot 0,85 \cdot 3,5)^2 = \underline{28,8} \text{ [kN]}$$

- (d) Calculation of resistance to gradient  $R_G$  according to formula 4.4

$$R_G = 10^{-6} \cdot (0,16 \cdot D_{actual} \cdot \rho \cdot g) = 10^{-6} \cdot (0,16 \cdot 5179 \cdot 1000 \cdot 9,81) = \underline{8,13} \text{ [kN]}$$

## ▼ M5

- (e) Calculation of
- $v_{II_{actual}}$
- according to formula 4.5

$$v_{II_{actual}} = k_6 \left( v_{L_{actual}} - v_{STR_{actual}} \right) = 0,85 \cdot 3,5 = 2,97 \text{ [m/s]}$$

$$v_{II_{actual}}^2 = 8,85 \text{ [m/s]}^2$$

- (f) Calculation of
- $F_{POR}$
- according to formula 4.6 and table 2

$$F_{POR} = 0,118 \cdot 1\,500 = \underline{177} \text{ [kN]}$$

- (g) Calculation of
- $s_{II_{actual}}$
- using formula (b) and the results of (c), (d), (e) and (f)

$$s_{II_{actual}} = \frac{0,12 \cdot 8,85 \cdot 9,81 \cdot \left( 0,48 + \frac{1,4}{2,97} \right)}{1,15 \cdot 177 + 28,8 - 8,13} \cdot 5\,179$$

$$s_{II_{actual}} = \underline{228,9} \text{ m}$$

- (h) Calculation of total distance according to formula 3.1

$$s_{actual} = 74,51 + 228,9 = \underline{303,4} \text{ m}$$

*Note:* The term ( $R_{mII} - R_G$ ), which is a function of  $D$ , with an actual value of 20,67 kN is obviously relatively small compared to  $k_3 \cdot F_{POR}$  with an actual value of 203,55 kN, so for simplification purposes,  $s_{II}$  can be taken as proportional to  $D$ , i.e.  $s_{II} = \text{Constant} \cdot D$ .

4.3. Calculation of  $s_{reference}$ 

Initial values

$$v_{STR_{reference}} = 1,5 \text{ m/s} = 5,4 \text{ km/h} \quad D_{reference} = D_{actual} = 5\,179 \text{ m}^3$$

$$v_{S_{reference}} = 3,6 \text{ m/s} = 13 \text{ km/h} \quad T_{reference} = T_{actual} = 2,96 \text{ m}$$

$$v_{L_{reference}} = 5,1 \text{ m/s} = 18,4 \text{ km/h}$$

$$(a) \quad S_{I_{reference}} = k_1 \cdot v_{L_{reference}} \cdot t_I$$

$$S_{I_{reference}} = 0,95 \cdot 5,1 \cdot 16 = \underline{77,50} \text{ m}$$

$$(b) \quad S_{II_{reference}} = k_2 \cdot v_{II_{reference}}^2 \cdot \frac{D_{reference} \cdot g}{k_3 \cdot F_{POR} + R_{TmII_{reference}} - R_G} \cdot \left( k_4 + \frac{v_{STR_{reference}}}{v_{II_{reference}}} \right)$$

- (c) calculation of
- $R_{TmII_{reference}}$

$$\frac{R_T}{v^2} = 10,8 \left[ \frac{\text{kN} \cdot \text{s}^2}{\text{m}^2} \right] \text{ as in point 4.2, since } B, D \text{ and } T \text{ are unchanged.}$$

$$v_{L_{reference}} - v_{STR_{reference}} = 3,6 \text{ [m/s]}$$

$$R_{TmII_{reference}} = \frac{R_T}{v^2} \cdot \left( k_7 \cdot k_6 \cdot \left( v_{L_{reference}} - v_{STR_{reference}} \right) \right)^2 = 10,8 \cdot (0,55 \cdot 0,85 \cdot 3,6)^2 = \underline{30,99} \text{ [kN]}$$

- (d) Resistance due to gradient
- $R_G$
- as in point 4.2

▼ **M5**(e) Calculation of  $v_{II,reference}$ 

$$v_{II,reference} = k_6 \cdot \left( v_{L,reference} - v_{STR,reference} \right) = 0,85 \cdot 3,6 = 3,06 \text{ [m/s]}, \quad v_{II,reference}^2 = 9,36 \text{ [m/s]}^2$$

(f)  $F_{POR}$  as in point 4.2.(g) Calculation of  $s_{II,reference}$  using formula (b) and the result from (c) to (f)

$$s_{II,reference} = \frac{0,12 \cdot 9,36 \cdot 9,81 \cdot \left( 0,48 + \frac{1,5}{3,06} \right)}{1,15 \cdot 177 + 30,99 - 8,13} \cdot 5\,179$$

$$= \underbrace{0,0472} \cdot 5\,179 = \underline{244,5 \text{ m}}$$

Constant<sub>reference</sub>

(h) Calculation of total distance

$$s_{reference} = s_{I,reference} + s_{II,reference} = 77,5 + 244,5 = \underline{322 \text{ m}}$$

4.4. Verification of compliance with permissible stopping distance under standard conditions  $s_{standard}$ 

according to formula 2.1 of Appendix 2

$$s_{standard} = s_{measured} \cdot \frac{s_{reference}}{s_{actual}} = 340 \cdot \frac{322}{303,4} = \underline{360,8 \text{ m} < 550 \text{ m}}$$

Conclusion:

The permissible limit value is far from being reached, i.e.:

- admission to downstream navigation is possible without problems for the actual load condition ( $0,8 \cdot D_{max}$ ),
- a higher load condition is possible and may be calculated according to point 5 below.

5. **Possible increase of  $D_{actual}$**  in downstream navigation

$$(s_{standard})_{Limit} = s_{measured} \cdot \frac{(s_{reference})_{Limit}}{s_{actual}} = 550 \text{ m}$$

$$(s_{reference})_{Limit} = 550 \cdot \frac{s_{actual}}{s_{measured}} = 550 \cdot \frac{303,4}{340} = 490,8 \text{ m}$$

With  $s_{II,reference} = \text{Constant}_{reference} \cdot D$  according to the note under point 4.2

$$(s_{reference})_{Limit} = \left( s_{I,reference} + s_{II,reference} \right)_{Limit} = s_{I,reference} + 0,0472 \cdot (D_{reference})_{Limit}$$

Hence

$$(D_{reference})_{Limit} = \frac{(s_{reference})_{Limit} - s_{I,reference}}{0,0472} = \frac{490,8 - 77,5}{0,0472} = 8\,756 \text{ m}^3$$

From this follows that:

Since  $(D_{reference})_{Limit} > D_{max}$  ( $8\,756 > 6\,474$ ) this formation (see point 1) may be permitted in downstream navigation with full load.

## ▼M5

## EXAMPLE II

## 1. Data of vessels and convoy

Formation: large motor vessel propelling

2 lighters side-by-side in front and

1 lighter coupled side-by-side

	L [m]	B [m]	T <sub>max</sub> [m]	Dwt (*) <sub>max</sub> [t]	D <sub>max</sub> [m <sup>3</sup> ]	P <sub>B</sub> [kW]
Motor vessel	110	11,4	3,5	2 900	3 731	1 500
Each lighter	76,5	11,4	3,7	2 600	2 743	—
Convoy	186,5	22,8	3,7	10 700	11 960	1 500

Propulsion system of the self-propelled vessel: modern nozzles with rounded rear edge.

(\*) Dwt = deadweight.

## 2. Values measured during the stopping manoeuvre

Current velocity:	$v_{STR_{actual}}$	=	1,4 m/s	≈	5,1 km/h
Speed of vessel (in relation to the water):	$V_{S_{actual}}$	=	3,5 m/s	≈	12,5 km/h
Speed of vessel (in relation to the bank):	$V_{L_{actual}}$	=	4,9 m/s	≈	17,6 km/h
Reversal time (measured) (point A to C):	$t_I$	=	16 sec		
Stopping distance in relation to the water (point A to D):	$s_{measured}$	=	580 m		
Load condition (possibly estimated):	$D_{actual}$	=	9 568 m <sup>3</sup>	≈	0,8 D <sub>max</sub>
Actual draught of convoy:	$T_{actual}$	=	2,96 m	≈	0,8 T <sub>max</sub>

3. Limit value according to paragraph 2.1(a) or (b) of the Administrative instruction to be compared with  $s_{standard}$ 

Since  $B > 11,45$  and the convoy is in flowing water, the following applies for this convoy under point 2.1(a):

$$s_{standard} \leq 550 \text{ m}$$

## 4. Determination of the corrected stopping distance compared with standard conditions

— Measured value:

$$s_{measured} = 340 \text{ m}$$

— calculations to be made:

$s_{actual}$  as the sum of

$s_{I_{actual}}$  (according to formula 4.1 of Appendix 2 with  $V_{L_{actual}}$ )

and

$s_{II_{actual}}$  (according to formulae 4.2, 4.3, 4.4, 4.5 and 4.6 of Appendix 2 with real speeds  $v_{L_{actual}}$  (see under 2 above) and  $D_{actual}$ )

$s_{reference}$ : sum  $s_{I_{reference}} + s_{II_{reference}}$  (according to formulae 4.1 to 4.6 of Appendix 2 with reference speeds and in conformity of Appendix 2, because the load condition > 70 % of maximum, where  $D_{reference} = D_{actual}$  and  $T_{reference} = T_{actual}$ )

— to be verified:

$$s_{standard} = s_{measured} \cdot \frac{s_{reference}}{s_{actual}} \leq 550 \text{ m, otherwise}$$

— calculate:

$$s^*_{standard} = 550 \text{ m by reduction of } D_{actual} \text{ to } D^*$$



▼ **M5**

## 4.1. Coefficients for the calculation according to Appendix 2

Table 1

for $s_{I_{actual}}$ and $s_{I_{reference}}$	$k_1$	=	0,95
for $s_{I_{actual}}$ and $s_{I_{reference}}$	$k_2$	=	0,12
	$k_3$	=	1,15
	$k_4$	=	0,48
	$k_5$	=	0,85
	$k_7$	=	0,55

Table 2 (for modern nozzles with rounded rear edge)

$$f = 0,118$$

4.2. Calculation of  $s_{I_{actual}}$ (a)  $s_{I_{actual}}$  Using the values measured during the stopping manoeuvres

$$s_{I_{actual}} = k_1 \cdot v_{L_{actual}} \cdot t_{I_{actual}}$$

$$s_{I_{actual}} = 0,95 \cdot 4,8 \cdot 16 = \underline{73 \text{ m}}$$

(b) formula for  $s_{II_{actual}}$ 

$$s_{II_{actual}} = k_2 \cdot v_{II_{actual}}^2 \cdot \frac{D_{actual} \cdot g}{k_3 \cdot F_{POR} + R_{TmII_{actual}} - R_G} \cdot \left( k_4 + \frac{v_{STR_{actual}}}{v_{II_{actual}}} \right)$$

(c) Calculation of  $R_{TmII_{actual}}$  according to table 3 and formula 4.3 of Appendix 2

$$D_{actual}^{1/3} = 9\,568^{1/3} = 21,2 \text{ [m]}$$

$$D_{actual}^{1/3} \cdot (B + 2 \cdot T_{actual}) = 21,2 \cdot (22,8 - 5,92) = 609 \text{ [m}^2\text{]}$$

$$\text{from table 3 } \frac{R_T}{v^2} = 14,0 \left[ \frac{\text{kN} \cdot \text{s}^2}{\text{m}^2} \right]$$

$$v_{L_{actual}} - v_{STR_{actual}} = 4,8 - 1,4 = 3,4 \text{ m/s}$$

$$R_{TmII_{actual}} = \frac{R_T}{v^2} \cdot \left( k_7 \cdot k_6 \cdot (v_{L_{actual}} - v_{STR_{actual}}) \right)^2 = 14,0 \cdot (0,55 \cdot 0,85 \cdot 3,4)^2 = \underline{35,4 \text{ [kN]}}$$

(d) Calculation of resistance due to gradient  $R_G$  according to formula 4.4 of Appendix 2.

$$R_G = 10^{-6} \cdot (0,16 \cdot D_{actual} \cdot \rho \cdot g) = 10^{-6} \cdot (0,16 \cdot 9\,568 \cdot 1\,000 \cdot 9,81) = \underline{15,02 \text{ [kN]}}$$

(e) Calculation of  $v_{II_{actual}}$  according to formula 4.5 of Appendix 2

$$v_{II_{actual}} = k_6 \cdot \left( v_{L_{actual}} \cdot v_{STR_{actual}} \right) = 2,89 \text{ [m/s]}$$

$$v_{II_{actual}}^2 = 8,35 \text{ [m/s]}^2$$

## ▼ M5

- (f) Calculation of
- $F_{POR}$
- according to formula 4.6 and table 2

$$F_{POR} = 0,118 \cdot 1\,500 = \underline{177} \text{ [kN]}$$

- (g) Calculation of
- $s_{II\text{actual}}$
- using formula (b) and the result of (c), (d), (e) and (f)

$$S_{II\text{actual}} = \frac{0,12 \cdot 8,35 \cdot 9,81 \left(0,48 + \frac{1,4}{2,89}\right)}{1,15 \cdot 177 + 35,4 - 15,02} \cdot 9\,568$$

$$S_{II\text{actual}} = \underline{402 \text{ m}}$$

- (h) Calculation of the total distance according to formula 3.1

$$s_{\text{actual}} = 73 + 402 = \underline{475 \text{ m}}$$

4.3. Calculation of  $s_{\text{reference}}$ 

Initial values:

$$V_{STR\text{reference}} = 1,5 \text{ m/s} \approx 5,4 \text{ km/h} \quad D_{\text{reference}} = D_{\text{actual}} = 9\,568 \text{ m}^3$$

$$V_{S\text{reference}} = 3,6 \text{ m/s} \approx 13 \text{ km/h} \quad T_{\text{reference}} = T_{\text{actual}} = 2,96 \text{ m}$$

$$V_{L\text{reference}} = 5,1 \text{ m/s} \approx 18,4 \text{ km/h}$$

$$(a) \quad S_{I\text{reference}} = k_1 \cdot v_{L\text{reference}} \cdot t_1$$

$$S_{I\text{reference}} = 0,95 \cdot 5,1 \cdot 16 = \underline{77,50 \text{ m}}$$

$$(b) \quad S_{II\text{reference}} = k_2 \cdot v_{II\text{reference}}^2 \cdot \frac{D_{\text{reference}} \cdot g}{k_3 \cdot F_{POR} + R_{TmII\text{reference}} - R_G} \cdot \left(k_4 + \frac{v_{STR\text{reference}}}{v_{II\text{reference}}}\right)$$

- (c) Calculation of
- $R_{TmII\text{reference}}$

$$\frac{R_T}{v^2} = 14,0 \left[ \frac{\text{kN} \cdot \text{s}^2}{\text{m}^2} \right] \text{ as under point 4.2 since B, D and T and unchanged}$$

$$v_{L\text{reference}} - v_{STR\text{reference}} = 3,6 \text{ [m/s]}$$

$$R_{TmII\text{reference}} = 14,0 \cdot (0,55 \cdot 0,85 \cdot 3,6)^2 = \underline{39,6} \text{ [kN]}$$

- (d) Resistance due to gradient
- $R_G$
- as under point 4.2

- (e) Calculation of
- $v_{II\text{reference}}$

$$v_{II\text{reference}} = 0,85 \cdot 3,6 = \underline{3,06} \text{ [m/s]}, \quad v_{II\text{reference}}^2 = 9,36 \text{ [m/s]}^2$$

## ▼ M5

- (f)  $F_{POR}$  as under point 4.2  
 (g) Calculation of  $S_{II_{reference}}$  using formula (b) and the result of (c) to (f)

$$S_{II_{reference}} = \frac{0,12 \cdot 9,36 \cdot 9,81 \cdot \left(0,48 + \frac{1,5}{3,06}\right)}{1,15 \cdot 177 + 39,6 - 15,02} \cdot 9\,568$$

$$S_{II_{reference}} = \underbrace{0,04684 \cdot 9\,568}_{\text{Constant}_{reference}} = \underline{448 \text{ m}}$$

- (h) Calculation of the total distance

$$S_{reference} = S_{I_{reference}} + S_{II_{reference}} = 77,5 + 448 = \underline{525,5 \text{ m}}$$

- 4.4. Verification of compliance with permissible stopping distance under standard conditions  $S_{standard}$  according to formula 2.1 of Appendix 2

$$S_{standard} = S_{measured} \cdot \frac{S_{reference}}{S_{actual}} = 580 \cdot \frac{525,5}{475} = \underline{641 \text{ m} > 550 \text{ m}}$$

Conclusion: The limit value has clearly been exceeded; admission to downstream navigation is possible only with a load restriction. This restricted load can be determined in conformity with No 5 below.

5. **D\* permissible in downstream navigation according to formula 2.1 of Appendix 2**

$$S_{standard} = S_{measured} \cdot \frac{S_{reference}^*}{S_{actual}} = 550 \text{ m}$$

Therefore:

$$S_{reference}^* = 550 \cdot \frac{S_{actual}}{S_{measured}} = S_{I_{reference}} + S_{II_{reference}}^*$$

$$S_{II_{reference}}^* = \text{Constant}_{reference} \cdot D^* = 0,04684 \cdot D^*$$

$$D^* = \frac{550 \cdot \frac{475}{580} - 77,5}{0,04684} = 7\,950 \text{ [m}^3\text{]}$$

Consequence: Since in downstream navigation the permissible displacement  $D^*$  is only 7 950 m<sup>3</sup>, the permissible deadweight (perm. Dwt.) in this formation is approximately:

$$\frac{\text{perm.Dwt.}}{\text{max.Dwt.}} = \frac{D^*}{D_{max}} = \frac{7\,950}{11\,960} = 0,66$$

Permissible deadweight (see point 1)

$$0,66 \cdot 10\,700 = 7\,112 \text{ t}$$

▼ **M5**

## ADMINISTRATIVE INSTRUCTION No 3

**Requirements for coupling systems and coupling devices for craft suitable for propelling or being propelled in a rigid assembly**

(Articles 16.01, 16.02, 16.06, 16.07 of Annex II)

In addition to the requirements of Chapter 16 of Annex II, the relevant provisions of the navigational authority regulations in force in the Member States shall be observed.

**1. General requirements**

- 1.1. Every coupling system shall guarantee the rigid coupling of all the craft in a convoy, i.e. under foreseen operating conditions the coupling device shall prevent longitudinal or transversal movement between the vessels, so that the assembly can be seen as a 'nautical unit'.
- 1.2. The coupling system and its components shall be safe and easy to use, enabling craft to be coupled rapidly without endangering personnel.
- 1.3. The forces arising from foreseen operating conditions shall be properly absorbed and safely transmitted into the vessel's structure by the coupling system and its components.
- 1.4. A sufficient number of coupling points shall be available.

**2. Coupling forces and dimensioning of coupling devices**

The coupling devices of convoys and formations of vessels to be authorised shall be dimensioned so as to guarantee sufficient safety levels. This condition is deemed to be fulfilled if the coupling forces determined according to points 2.1, 2.2 and 2.3 are assumed to be the tensile strength for the dimensioning of the longitudinal coupling components.

- 2.1. Coupling points between pusher and pushed lighters or other craft:

$$F_{SB} = 270 \cdot P_B \cdot \frac{L_S}{B_s} \cdot 10^{-3} \text{ [kN]}$$

- 2.2. Coupling points between pushing motor vessel and pushed craft:

$$F_{SF} = 80 \cdot P_B \cdot \frac{L_S}{h_K} \cdot 10^{-3} \text{ [kN]}$$

- 2.3. Coupling points between pushed craft:

$$F_{SL} = 80 \cdot P_B \cdot \frac{L'_S}{h'_K} \cdot 10^{-3} \text{ [kN]}$$

A value of 1 200 kN is deemed to be sufficient for the maximum coupling force for a pushing craft at the coupling point between the first pushed craft and the craft coupled ahead of it, even if formula in point 2.3 produces a higher value.

For the coupling points of all other longitudinal connections between pushed craft, the dimensioning of the coupling devices shall be based on the coupling force determined according to formula in point 2.3.

## ▼ M5

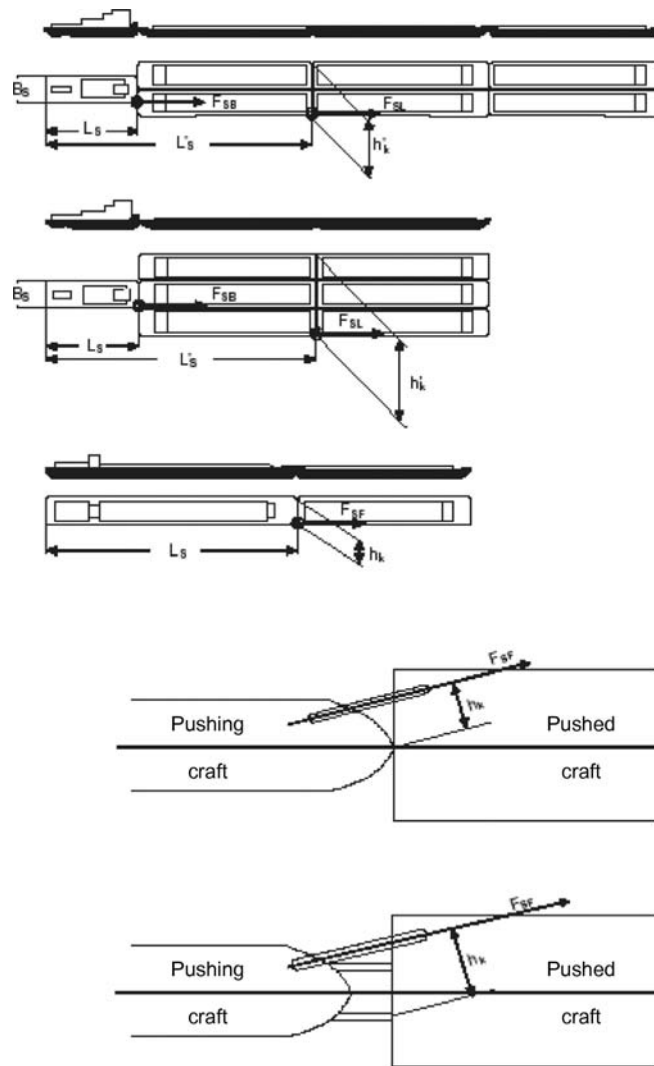

Where:

$F_{SB}, F_{SF}, F_{SL}$ [kN]	Coupling force of the longitudinal connection;
$P_B$ [kW]	Installed power of the propulsion engine;
$L_S$ [m]	Distance from the stern of the pusher or pushing craft to the coupling point;
$L'_S$ [m]	Distance from the stern of the pushing craft to the coupling point between the first pushed craft and the craft coupled ahead of it;
$h_k, h'_k$ [m]	Respective lever arm of the longitudinal connection;
$B_S$ [m]	Width of the pushing craft;
270 and 80 $\left[ \frac{\text{kN}}{\text{kW}} \right]$	Empirically established values for the conversion of installed power to thrust while ensuring adequate levels of safety.

- 2.4.1. For the longitudinal coupling of individual craft at least two coupling points shall be used. Each coupling point shall be dimensioned for the coupling force determined according to points 2.1, 2.2 or 2.3. If rigid coupling components are used, a single coupling point may be authorised if that point ensures secure connection of the craft.

The tensile strength of the cables shall be selected according to the foreseen number of windings. There shall be no more than three windings at the coupling point. Cables shall be selected according to their intended use.

**▼M5**

- 2.4.2. In the case of pushers with a single pushed lighter, formula in point 2.2 can be used to determine the coupling force if such pushers have been authorised to propel several such lighters.
- 2.4.3. Sufficient numbers of bollards or equivalent devices shall be available and be capable of absorbing the coupling forces arising.

**3. Special requirements for articulated couplings**

Articulated couplings shall be designed so as to also ensure a rigid coupling between craft. Compliance with the requirements of Chapter 5 shall be checked during navigation tests with a rigid convoy in accordance with Article 16.06.

The drive unit of the articulated coupling shall enable a satisfactory return from the articulated position. The requirements of Articles 6.02 to 6.04 shall be applied *mutatis mutandis*, hence when a powered drive unit is used, a second independent drive unit and energy source shall be available in the event of failure.

It shall be possible to operate and monitor the articulated coupling (its articulated movement, at least) from the wheelhouse, the requirements of Articles 7.03 and 7.05 shall be applied *mutatis mutandis*.

▼ M5

ADMINISTRATIVE INSTRUCTION No 4

(Left void)

▼ **M5**

## ADMINISTRATIVE INSTRUCTION No 5

**Noise measurements**

(Article 3.04(7), Article 7.01(2), Article 7.03(6), Article 7.09(3), Article 8.10, Article 11.09(3), Article 12.02(5), Article 17.02(3)(b), and Article 17.03(1) of Annex II)

**1. General**

In order to check the maximum sound pressure levels given in Annex II, measured values, measurement procedures and conditions for the quantitative, reproducible recording of sound pressure levels in accordance with points 2 and 3 shall be established.

**2. Measuring instruments**

The measuring instrument shall meet the requirements of class 1 according to EN 60651:1994.

Before and after each set of measurements, a class 1 calibrator according to EN 60942:1998 shall be placed on the microphone in order to calibrate the measurement system. The compliance of the calibrator with the requirements of EN 60942:1998 shall be checked once per year. The compliance of the measuring equipment with the requirements of EN 60651:1994 shall be checked every two years.

**3. Noise measurements****3.1. On board craft**

Measurements shall be carried out in accordance with ISO 2923:2003 Sections 5 to 8 measuring only A-weighted sound pressure levels.

**3.2. Air noise emitted from craft**

Noise emissions from craft on inland waterways and in ports are determined by means of measurements in accordance with EN ISO 22922:2000, Sections 7 to 11. Doors and windows of engine rooms shall be closed during measurements

**4. Documentation**

Measurements shall be recorded according to the 'Noise Measurement Report' (Annex).

**Noise Measurement Report**

— on board craft in accordance with ISO 2923:2003

— air noise emitted from craft in accordance with EN ISO 2922:2000 (\*)

**A. Craft data****1. Craft type and name:**

Unique European vessel identification number:

**2. Owner:****3. Main propulsion system:****3.1. Main engines:**

Number	Manufacturer	Type	Year of construction	Power (kW)	Engine speed (min <sup>-1</sup> )	Two-stroke/four-stroke	Turbo-charged yes/no
1							
2							

(\*) Delete as appropriate.



**▼M5**

## 3.2. Transmission

Manufacturer: ..... Type: ..... Gear reduction: 1: .....

## 3.3. Propellers

Number: ..... Number of blades: ..... Diameter: ..... mm ..... Nozzle: yes/no (\*)

## 3.4. Steering system

Type:

## 4. Auxiliaries:

Number	Propulsion of	Manufacturer	Type	Year of construction	Power (kW)	Engine speed (min <sup>-1</sup> )
1						
2						
3						
4						
5						

## 5. Noise reduction measures implemented:

## 6. Observations:

**B. Measuring instruments used**

## 1. Sound pressure level meter:

Manufacturer: ..... Type: ..... Latest check: .....

## 2. Octave/Third octave band analyser:

Manufacturer: ..... Type: ..... Latest check: .....

## 3. Calibrator:

Manufacturer: ..... Type: ..... Latest check: .....

## 4. Accessories:

## 5. Observations:

**C. Measurement conditions — craft**

## 1. Formation during the measurements:

2. Load/displacement: ..... t/m<sup>3</sup> (\*) (approximately ..... % of maximum value)3. Speed of main engine: ..... min<sup>-1</sup> (approximately ..... % of maximum value)

## 4. Auxiliaries in service No:

## 5. Observations:

**D. Measurement conditions — surroundings**

1. Area of measurement: ..... Upstream/downstream (\*)

2. Water depth: ..... m (Relevant water level = ..... m)

3. Weather: ..... Temperature: ..... °C; Wind strength: ..... BF

4. External noise interference: yes/no (\*), if yes, specify: .....

## 5. Observations:

(\*) Delete as appropriate.

**▼M5****E. Recording of measurement**

1. Measurement carried out by:
2. Date:
3. Observations:
4. Signature:

**F.1. Measurement results**

Noise measurements on board craft:

Number	Measurement point	Doors		Windows		Measured value in dB(A)	Observations
		open	closed	open	closed		

**F.2. Measurement results**

Measurement of air noise emitted from craft:

Number	Measurement point	Measured values in dB(A)	Observations

▼ M5

ADMINISTRATIVE INSTRUCTION No 6

(Left void)

## ▼M5

## ADMINISTRATIVE INSTRUCTION No 7

**Special anchors with reduced mass**

(Article 10.01(5) of Annex II)

*PART 1****Authorised special anchors***

Special anchors with reduced mass authorised by the competent authorities in accordance with Article 10.01(5) are presented in the following table.

Anchor No	Authorised reduction of anchor mass (%)	Competent authority
1. HA-DU	30 %	Germany
2. D'Hone Spezial	30 %	Germany
3. Pool 1 (hollow)	35 %	Germany
4. Pool 2 (solid)	40 %	Germany
5. De Biesbosch-Danforth	50 %	Germany
6. Vicinay-Danforth	50 %	France
7. Vicinay AC 14	25 %	France
8. Vicinay Type 1	45 %	France
9. Vicinay Type 2	45 %	France
10. Vicinay Type 3	40 %	France
11. Stockes	35 %	France
12. D'Hone-Danforth	50 %	Germany
13. Schmitt high holding anchor	40 %	Netherlands

*PART 2****Authorisation and test procedure of special anchors with reduced mass***

(Reduction of the anchor mass values determined in accordance with Article 10.01(1) to (4) of Annex II)

**1. Chapter 1 — Authorisation procedure**

- 1.1. Special anchors with reduced mass in accordance with Article 10.01(5) of Annex II shall be authorised by the competent authorities. The competent authority determines the authorised reduction of anchor mass for special anchors in accordance with the procedure outlined below.
- 1.2. Authorisation as special anchor is only possible if the reduction of anchor mass established is at least 15 %.
- 1.3. Applications for the authorisation of a special anchor in accordance with point 1.1 shall be submitted to the competent authority of a Member State. Ten copies of the following documents shall be forwarded with each application:
  - (a) an outline of the dimensions and mass of the special anchor, giving the main dimensions and type designation for each available anchor size;

▼ **M5**

(b) a braking force diagram for the reference anchor A (in accordance with point 2.2) and the special anchor B to be authorised which has been prepared and assessed by an institution designated by the competent authority.

- 1.4. The competent authority notifies the Commission of any applications to reduce anchor mass which it considers to authorise after testing. The competent authority consequently notifies the Commission of any authorised special anchor, giving its type designation and authorised reduction of anchor mass. The competent authority grants authorisation to the applicant at the earliest 3 months after notifying the Commission provided that the latter does not raise objections.

## 2. Chapter 2 — Test Procedure

- 2.1. The braking force diagrams in accordance with point 1.3 shall show the braking forces as a function of speed for the reference anchor A and the special anchor B to be authorised on the basis of tests in accordance with points 2.2 to 2.5 below. Annex I shows one possible braking force test.
- 2.2. The reference anchor A used in the tests shall be a conventional folding stockless anchor corresponding to the sketch and details given below, with a mass of at least 400 kg.

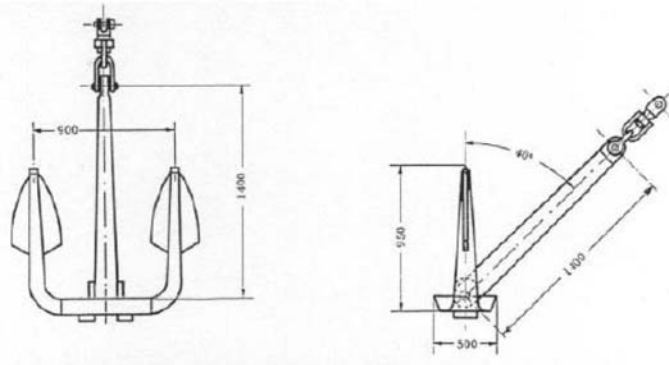

A tolerance of  $\pm 5\%$  applies to the dimensions and mass given. However, the surface area of each fluke must be at least  $0,15\text{ m}^2$ .

- 2.3. The mass of the special anchor B used in the tests shall not deviate by more than  $10\%$  from the mass of the reference anchor A. If the tolerances are greater, the forces shall be recalculated proportional to mass.
- 2.4. Braking force diagrams shall give a linear representation of speed ( $v$ ) in the range  $0$  to  $5\text{ km/h}$  (speed over ground). To this end, three tests shall be carried out in an upstream direction for the reference anchor A and the special anchor B on an alternating basis over each of two stretches of river determined by the competent authority, one with coarse gravel and one with fine sand. On the River Rhine the stretch between  $401\text{--}402\text{ km}$  can serve as a reference stretch for the coarse gravel tests and the stretch between  $480\text{--}481\text{ km}$  for the fine sand tests.
- 2.5. For each test, the anchor being tested shall be towed with a steel wire cable whose length between the points of connection on the anchor and on the towing craft or device is  $10$  times the height of the connection point on the craft above the anchorage ground.
- 2.6. The percentage of reduction of anchor mass is calculated by the following formula:

$$r = 75 \cdot \left( 1 - 0,5 \frac{PB}{PA} \left( \frac{FA}{FB} + \frac{AA}{AB} \right) \right) [\%]$$

Where

$r$  the percentage of reduction of anchor mass of special anchor B in relation to reference anchor A;

$PA$  the mass of reference anchor A;

▼ **M5**

- PB the mass of special anchor B;
- FA holding force of reference anchor A at  $v = 0,5$  km/h;
- FB holding force of special anchor B at  $v = 0,5$  km/h;
- AA the surface area on the braking force diagram defined by:
- the line parallel to the y-axis at  $v = 0$ ,
  - the line parallel to the y-axis at  $v = 5$  km/h,
  - the line parallel to the x-axis at holding force  $F = 0$ ,
  - the braking force curve for reference anchor A,

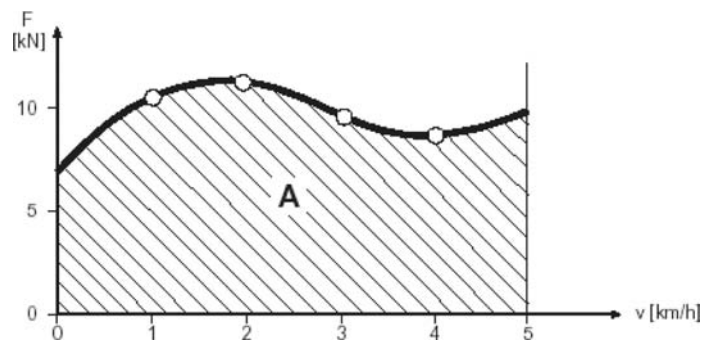
**Model braking force diagram**

(Determining the surface areas AA and AB)

- AB same definition as for AA except that the braking force curve for special anchor B is used.
- 2.7. The acceptable percentage is the average of six values of  $r$  calculated in accordance with point 2.6.

▼ **M5**

*Annex I to the regulations on the inspection and authorisation of special anchors*

**Example of an anchor test method with a single-file two-part pushed convoy**

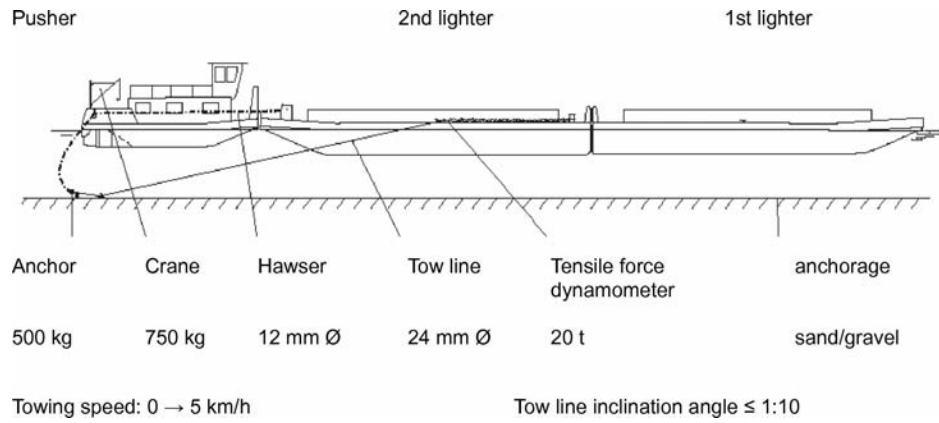

**▼M5**

## ADMINISTRATIVE INSTRUCTION No 8

**Strength of watertight windows**

(Article 15.02(16) of Annex II)

**1. General**

According to Article 15.02(16) of Annex II, watertight windows may be situated below the margin line if they are watertight, cannot be opened, possess sufficient strength and conform to Article 15.06(14).

**2. Construction of watertight windows**

The requirements of Article 15.02(16) of Annex II are deemed to be fulfilled if the construction of watertight windows complies with the following provisions.

- 2.1. Only pre-stressed glass complying with ISO 614, published 04/94, shall be used.
- 2.2. Round windows shall comply with ISO 1751, published 04/94, Series B: medium heavy-duty windows Type: non-opening window.
- 2.3. Angular windows shall comply with ISO 3903, published 04/94, Series E: heavy-duty windows Type: non-opening window
- 2.4. ISO standard windows may be replaced by windows whose construction is at least equivalent to the requirements of points 2.1 to 2.3.



**▼M5**

## ADMINISTRATIVE INSTRUCTION No 9

**Requirements for automatic pressurised water sprinklers**

(Article 10.03a(1) of Annex II)

Suitable automatic pressurised water sprinklers as in Article 10.03a(1) shall meet the following requirements:

1. The automatic pressurised water sprinkler shall be ready for service at all times when there are persons on board. No additional action by crew members shall be required to trigger operation.
2. The system shall be permanently maintained at the necessary pressure. The pipes shall be filled with water up to the spray nozzles at all times. The system shall have a continuously working water supply. It shall not be possible for impurities harmful to operation to enter the system. Appropriate display instruments and test systems (e.g. pressure gauges, pressure-tank water level indicators, pump test piping) shall be installed for monitoring and checking the system.
3. The pump for the water supply to the spray nozzles shall be activated automatically by a pressure drop in the system. The pump shall be dimensioned so that it can continuously provide a sufficient water supply at the necessary pressure if all the spray nozzles necessary for covering the area of the largest room to be protected are activated simultaneously. The pump shall supply the automatic pressurised water sprinkler exclusively. In the event of pump failure, it shall be possible to provide the spray nozzles with a sufficient water supply from another on-board pump.
4. The system shall be divided into sections, each with no more than 50 spray nozzles.
5. The number and the layout of spray nozzles shall ensure effective distribution of water in the rooms to be protected.
6. Spray nozzles shall be triggered at a temperature between 68 °C and 79 °C.
7. The installation of components of automatic pressurised water sprinklers within the rooms to be protected shall be limited to the necessary minimum. No such system components shall be installed in main engine rooms.
8. Visual and acoustic indicators shall be provided in one or more suitable locations, at least one of which must be permanently manned, displaying activation of automatic pressurised water sprinklers for each section.
9. The energy supply of the installation of automatic pressurised water sprinklers shall be provided by two independent energy sources that shall not be installed in the same location. Each energy source shall be capable of supplying the entire system unassisted.
10. An installation plan of the automatic pressurised water sprinkler shall be presented to the inspection body for examination before installation of the system. The plan shall indicate the types and performance data of the machines and equipment used. An installation tested and certified by an approved classification society which complies at least with the above prescriptions can be authorised without further testing.
11. The presence of an automatic pressurised water sprinkler shall be entered in the Community Certificate under item 43.

▼ M5

ADMINISTRATIVE INSTRUCTION No 10

(Left void)

**▼M5**

## ADMINISTRATIVE INSTRUCTION No 11

**Completion of the Community Certificate**

## 1. GENERAL

1.1. **Forms**

For completion of the Community Certificate only forms authorised by the competent authority shall be used. Forms shall be filled in on one side only.

When issuing a new Community Certificate, all pages 1 to 13 shall be included, even if some pages have no entries.

1.2. **Method of entry**

Entries on the Community Certificate shall be typewritten or computer-printed. Hand written entries may only be made in exceptional cases. The entries shall be indelible. Font colours shall be black or blue only. Deletions shall be made in red.

## 2. ENTRIES

2.1. **Deletion of alternatives**

Where entries are marked with (\*) those which are not appropriate shall be deleted.

2.2. **Items without entry**

If, for any of the items 1 to 48, no entry is either necessary or possible, a line shall be drawn across the entire field.

2.3. **Final page of the Community Certificate**

If no additional pages are required after page 13 (see point 3.2.3), the words 'continued on page' (\*) at the bottom of page 13 shall be deleted.

2.4. **Amendments**2.4.1. *First handwritten amendment on a page*

A page can be amended once only, however, several amendments may be made at that time. A red line shall be drawn through any details to be amended. A previously deleted alternative (see point 2.1) or an item previously without entry (see point 2.3) shall be underlined in red. The new details shall not be entered in the amended field, but on the same page under the heading 'Amendments', the line 'This page has been replaced' shall be deleted.

2.4.2. *Further handwritten amendments on a page*

For further amendments the page shall be replaced and the necessary amendments as well as any earlier amendments shall be entered directly under the appropriate items. Under the heading 'Amendments' the line 'amendments to item(s)' shall be deleted.

The old page shall be retained by the inspection body which originally issued the Community Certificate.

---

(\*) Delete as appropriate.

**▼M5****2.4.3. Amendments by electronic data processing**

In case of amendments by electronic data processing, the page shall be replaced and the necessary amendments as well as any earlier amendments shall be entered directly under the appropriate items. Under the heading 'Amendments' the line 'amendments to item(s)' shall be deleted.

The old page shall be retained by the inspection body which originally issued the Community Certificate.

**2.5. Corrections by pasting over**

Pasting over of entries or pasting in further details added to an item is not allowed.

**3. REPLACING AND ADDING PAGES****3.1. Replacing pages**

Page 1 of the Community Certificate shall never be replaced. For replacing other pages the procedures outlined in point 2.4.2 or point 2.4.3 shall be applied.

**3.2. Adding pages**

If there is insufficient space for further entries on pages 10, 12 or 13 of the Community Certificate, additional pages may be attached.

**3.2.1. Extension/Confirmation of validity**

If further extension is necessary when the certificate has already been extended six times, the words 'Continued on page 10a' shall be added at the bottom of page 10, and a further page 10 shall be marked as page 10a and inserted after page 10. The respective entry is then made under item 49 at the top of page 10a. At the bottom of page 10a the entry 'Continued on page 11' shall be made.

**3.2.2. Extension of the liquefied gas installation certificate**

A similar procedure to point 3.2.1 shall be applied, with page 12a inserted after page 12.

**3.2.3. Annex to the Community Certificate**

At the bottom of page 13 the words 'End of the Community Certificate' shall be deleted in red, the deleted words 'Continued on page (\*)' shall be underlined in red and behind that the page number 13a shall be entered. This amendment shall carry an official stamp. A further page 13 shall be marked as page 13a and inserted after page 13. The provisions of points 2.2 and 2.3 apply to page 13a *mutatis mutandis*.

The same procedure shall be applied for any further annexes (pages 13b, 13c, etc.).

**4. EXPLANATIONS OF INDIVIDUAL ITEMS**

Self-explanatory items are not mentioned below.

2. If applicable, insert terms as per Article 1.01. Other vessel types shall be entered with their commonly accepted designation.

15. This section shall only be completed for craft for which at least one of the properties 1.1 or 1.2 or 3 in item 14 is not deleted, otherwise the entire table shall be deleted.

(\*) Delete as appropriate.

▼ M5

- 15.1. In the column ‘formation figure’ of the table the number(s) of the formations depicted shall be entered. Lines without entry shall be struck through.
- Further formations may be drawn under ‘Other formations’ and shall be designated 18, 19, 20, etc.
- If it is not apparent from the property ‘fit to push’ in the previous ship certificate which formations are authorised, the entry from the previous ship certificate may be transferred to item 52. ‘See item 52’ shall be entered in line 1 of the table ‘Authorised formations’.
- 15.2. Couplings
- Only the details of the coupling between the pushing craft and the pushed section of the convoy shall be entered.
- 17-20. Details according to the tonnage certificate items 17-19 to two decimal places and item 20 without decimal places. Length overall and breadth overall give the maximum dimensions of the craft, including all projecting fixed parts. Length L and Breadth B give the maximum hull dimensions (see also Article 1.01 Definitions).
21. Dead weight tonnage for cargo vessels in t according to the tonnage certificate for the maximum draught according to item 19.
- Displacement for all other craft in m<sup>3</sup>. If no tonnage certificate is available, calculate the displacement from the product of the block coefficient and length  $L_{WL}$ , breadth  $B_{WL}$  and mean draught at maximum immersion.
23. Number of passenger berths available (including folding beds and similar).
24. Only watertight transverse bulkheads extending from one side of the vessel to the other shall be taken into consideration.
26. If applicable, the following terms shall be used:
- manually operated hatch covers,
  - manually operated rolling hatch covers,
  - manually operated sliding hatch covers,
  - mechanically operated sliding hatch covers,
  - mechanically operated hatch covers.
- Other types of hatch covers shall be entered with their commonly accepted designation.
- Any holds which do not have a hatch cover shall be listed, e.g. under item 52.
28. Figure without decimal place.
- 30, 31 and 33. Every winch housing shall be counted as one winch, regardless of the number of anchors or towing cables connected to it.
34. Under ‘Other installations’ systems which do not use rudder blades (e.g. rudder-propeller, cycloidal-propeller, bow-thruster systems) shall be entered.
- Enter also any electrical auxiliary engines for manual actuation.
- With bow-thruster systems, ‘remote-controlled’ refers only to remote controls operated from the steering position in the wheelhouse.
35. Only the theoretical values according to Article 8.08(2) and (3), Article 15.01(1)(c), and Article 15.08(5) shall

▼ M5

- be entered, and then only for craft whose keels were laid down after 31 December 1984.
36. A sketch may be necessary for clarification.
37. Only the theoretical values without reduction according to Article 10.01(1)-(4) shall be entered.
38. Only the minimum lengths according to Article 10.01 (10) and the minimum tensile strength according to Article 10.01(11) shall be entered.
- 39 and 40. Only the minimum lengths and minimum tensile strength values recalculated according to Article 10.02 (2) shall be entered.
42. The inspection body may add items to the list of necessary equipment. These shall be justified as essential to ship safety for the respective vessel type or its operational area. Additions shall be entered under item 52.
- Left column, row 3 and 4: for passenger vessels the first mentioned item shall be crossed out and under the second mentioned item the length of the gangway as established by the inspection body shall be entered. For all other vessels the second mentioned item shall be crossed out completely respectively, if the inspection body has allowed a shorter length than what is foreseen by Article 10.02(2)(d), only the first half shall be crossed out and the length of the gangway entered.
- Left column, row 6: here the number of the prescribed first aid kits according to Article 10.02(2)(f) and Article 15.08(9) shall be entered.
- Left column, row 10: here the number of the prescribed fire proof receptacles according to Article 10.02(1)(d) to (f) shall be entered.
43. Portable fire extinguishers required by other safety regulations, e.g. the regulation for the carriage of dangerous substances on the Rhine (ADNR), are not included here.
44. Row 3: in Community Certificates to be extended before 1.1.2010, or 1.1.2025 where Chapter 24a is applicable, the item 'according to EN 395:1998 or 396:1998' shall be crossed if no life vests according to this standard are onboard.
- Row 4: when Community Certificates are extended after 1.1.2015, or 1.1.2030 where Chapter 24a is applicable, or if a new dinghy is taken onboard, the item 'with a set of oars, one mooring line and a baler' shall be crossed. The item 'according to EN 1914:1997' shall be crossed if no dinghy according to this standard is onboard.
46. As a general rule, continuous operation shall not be inserted if there is a lack of berths or if there are excessive noise levels.
50. The expert shall sign only if he has completed page 11 himself.
52. Here any additional restrictions, exemptions and explanations, or similar, applying to entries under individual items can be given.

## 5. TRANSITIONAL PROVISIONS

## 5.1. Existing Community Certificates

With the exception of Article 2.09(2), no further extensions to existing Community Certificates shall be granted.

▼ **M5**

5.2. **Replacement after a periodical inspection**

After a periodical inspection of a vessel which does not yet have a Community Certificate in line with the model in Annex V Part 1, a Community Certificate shall be issued. Article 2.09(4) and Article 2.17 shall apply.

**▼M5**

## ADMINISTRATIVE INSTRUCTION No 12

**Fuel tanks on floating equipment**

(Article 8.05(1) and Article 17.02(1)(d) of Annex II)

According to Article 8.05(1), fuel tanks shall form an integral part of the hull or shall be firmly attached to it.

Fuel tanks for engines of working gear on floating equipment do not have to form an integral part of the hull or be firmly attached to it. Mobile tanks may be used, provided that they comply with the following conditions:

1. The capacity of these tanks shall not exceed 1 000 litres.
2. It shall be possible to attach the tanks sufficiently firmly and to earth them.
3. The tanks shall be made from steel of a sufficient wall thickness and shall be installed in a drip tray. The latter shall be designed to prevent leaking fuel contaminating the waterways. The drip tray may be dispensed with if double-skin tanks with a leak protection or leakage warning system are used and which are filled only via an automatic delivery valve. The provisions of point 3 shall be deemed to be fulfilled if the construction of a tank has been certified and approved according to the regulations of a Member State.

An appropriate entry shall be made in the Community Certificate.



▼ **M5**

ADMINISTRATIVE INSTRUCTION No 13

**Minimum hull thickness of barges**

(Article 3.02(1) of Annex II)

During periodical inspections in accordance with Article 2.09 of barges which are exclusively towed, the inspection body may allow minor deviations from Article 3.02(1)(b) with respect to the minimum thickness of the shell plating of the hull. The deviation shall not be more than 10 %, and the minimum hull thickness shall not be less than 3 mm.

The deviations shall be entered in the Community Certificate.

Under item 14 of the Community Certificate, only property No 6.2 'Towed as a craft with no motive power of its own' shall apply.

Properties No 1 to 5.3 and 6.1 shall be deleted.

▼ M5

ADMINISTRATIVE INSTRUCTION No 14

(Left void)

**▼M5**

## ADMINISTRATIVE INSTRUCTION No 15

**Steerageway under vessel's own power**

(Article 10.03b(2)(a), Article 15.07(1), Article 22a.05(1)(a) of Annex II)

**1. Minimum requirements for vessel's steerageway**

Steerageway under a vessel's own power in accordance with Articles 10.03b(2)(a), 15.07(1) and 22a.05(1)(a) is deemed to be sufficient if — when using the bow thruster — the vessel or the formation propelled by the vessel attains a speed of 6,5 km/h in relation to the water and a rate-of-turn of 20°/min can be induced and maintained while under way at a speed of 6,5 km/h in relation to the water.

**2. Navigation tests**

On verifying the minimum requirements Articles 5.03 and 5.04 shall be complied with.

▼ M5

ADMINISTRATIVE INSTRUCTION No 16

(Left void)

**▼M5**

## ADMINISTRATIVE INSTRUCTION No 17

**Appropriate fire alarm system**

(Article 10.03b(3), Article 15.11(17), Article 22b.11(1) of Annex II)

Fire alarm systems are considered to be appropriate if they meet the following conditions.

**0. COMPONENTS**

0.1. Fire alarm systems consist of:

- (a) fire detection system,
- (b) fire indicator system,
- (c) control panel,

as well as the external power supply.

0.2. The fire detection system may be divided into one or more fire zones.

0.3. The fire indicator system may have one or more indicator devices.

0.4. The control panel is the central control unit of the fire alarm system. It also includes parts of the fire indicator system (i.e. an indicator device).

0.5. A fire detection zone may have one or more fire detectors.

0.6. Fire detectors may be:

- (a) heat detectors;
- (b) smoke detectors;
- (c) ion detectors;
- (d) flame detectors;
- (e) combination detectors (fire detectors combining two or more of the detectors listed in (a) to (d)).

Fire detectors which respond to other factors indicating the onset of a fire may be approved by the inspection body provided that they are no less sensitive than the detectors referred to under (a) to (e).

0.7. Fire detectors may be installed:

- (a) with or
- (b) without

individual identification.

**1. CONSTRUCTION REQUIREMENTS****1.1. General**

1.1.1. Compulsory fire alarm systems shall be operational at all times.

1.1.2. Fire detectors required in accordance with point 2.2 shall be automatic. Additional manually operated fire detectors may be installed.

1.1.3. The system and its components shall be able to withstand voltage fluctuations and surges, changes in ambient temperature, vibrations, humidity, shocks, impacts and corrosion such as commonly occur on vessels.

**1.2. Energy supply**

1.2.1. Energy sources and electric circuits necessary for the operation of the fire alarm system shall be self monitoring. Any fault occurring shall activate a visual and acoustic alarm signal on the control panel which can be distinguished from a fire alarm signal.

1.2.2. There shall be at least two power sources for the electrical part of the fire alarm system, one of which shall be an emergency power system (i.e.

**▼M5**

emergency power source and emergency switchboard). There shall be two separate power-feeds solely for this purpose. These shall lead to an automatic switch in or near the control panel of the fire alarm system. On day-trip vessels up to 25 m  $L_{WL}$  and on motor vessels a separate emergency power supply is sufficient.

**1.3. Fire detection system**

- 1.3.1. Fire detectors shall be grouped in fire detection zones
- 1.3.2. Fire detection systems shall not be used for any other purpose. By way of derogation the closing of the doors in accordance with Article 15.11(8) and similar functions may be activated and indicated on the control panel.
- 1.3.3. Fire detection systems shall be designed in such a way that the first indicated fire alarm does not prevent fire alarms set off by other detectors.

**1.4. Fire detection zones**

- 1.4.1. Where the fire detectors cannot be remotely identified individually, a fire detection zone shall not monitor more than one deck. This does not apply to a fire detection zone which monitors an encapsulated stairwell.

In order to avoid delays in detecting the origin of the fire, the number of enclosed spaces included in each fire detection zone shall be limited. There shall not be more than fifty enclosed spaces in one fire detection zone.

Where the fire detection system has remote identification of individual fire detectors, the fire detection zones may monitor several decks and any number of enclosed spaces.

- 1.4.2. On passenger vessels which do not have a fire detection system with remote identification of individual fire detectors, a fire detection zone shall not comprise more than the area constituted in accordance with Article 15.11(10). The activation of a fire detector in an individual cabin in this fire detection zone shall set off a visual and acoustic signal in the passageway outside that cabin.
- 1.4.3. Galleys, engine rooms and boiler rooms shall constitute separate fire detection zones.

**1.5. Fire detectors**

- 1.5.1. Only heat, smoke or ion detectors shall be used as fire detectors. Other types may only be used as additional detectors.
- 1.5.2. Fire detectors shall be type-approved.
- 1.5.3. All automatic fire detectors shall be designed in such a way that they can be tested to ensure that they are working properly and brought back into service without having to replace any components.
- 1.5.4. Smoke detectors shall be set so that they respond to a reduction in visibility per metre caused by smoke of more than 2 % to 12,5 %. Smoke detectors fitted in galleys, engine rooms and boiler rooms shall respond within sensitivity limits meeting the requirements of the inspection body, whereby under-sensitivity or over-sensitivity of the detectors shall be avoided.
- 1.5.5. Heat detectors shall be set so that with temperature increase rates of less than 1 °C/min they respond at temperatures of between 54 °C and 78 °C.

With higher rates of temperature increase, the heat detector shall respond within temperature limits where under- or over-sensitivity of the heat detector is avoided.

- 1.5.6. With the agreement of the inspection body, the permissible operating temperature of heat detectors may be increased to 30 °C above the maximum temperature in the upper part of engine and boiler rooms.
- 1.5.7. The sensitivity of flame detectors shall be sufficient to detect flames against an illuminated background. Flame detectors shall also be equipped with a system for identifying false alarms.

**▼M5****1.6. Fire detection system and control panel**

- 1.6.1. Activation of a fire detector shall set off a visual and acoustic fire alarm signal at the control panel and the indicator devices.
- 1.6.2. The control panel and the indicator devices shall be at a location which is permanently manned by crew or shipboard personnel. One indicator shall be at the steering position.
- 1.6.3. The indicator devices shall indicate at least the fire detection zone in which a fire detector has been activated.
- 1.6.4. On or near each indicator device there shall be clear information on the areas monitored and the location of the fire detection zones.

**2. INSTALLATION REQUIREMENTS**

- 2.1. Fire detectors shall be installed in such a manner as to ensure the best possible operation of the system. Locations in the vicinity of deck girders and ventilation shafts or other locations where air currents could adversely affect system operation and locations where impacts or mechanical damage are likely shall be avoided.
- 2.2. In general, fire detectors located on the ceiling shall be at least 0,5 metres away from bulkheads. The maximum distance between fire detectors and bulkheads shall conform to the following table:

Type of fire detector	Maximum floor surface area per fire detector	Maximum distance between fire detectors	Maximum distance of fire detectors from bulkheads
Heat	37 m <sup>2</sup>	9 m	4,5 m
Smoke	74 m <sup>2</sup>	11 m	5,5 m

The inspection body may stipulate or approve other distances on the basis of tests which prove the characteristics of the detectors.

- 2.3. The routing of electric cables for the fire alarm system through engine rooms and boiler rooms or other high fire risk areas is not permitted unless this is necessary for fire detection in those areas or connection to the corresponding power supply.

**3. TESTING**

- 3.1. Fire alarm systems shall be tested by an expert:
- (a) after installation;
  - (b) regularly, but at least every two years.

In the case of engine rooms and boiler rooms these tests shall be carried out under varying operational and ventilation conditions.

- 3.2. A test certificate shall be signed by the expert, indicating the date of the test.

**▼M5**

## ADMINISTRATIVE INSTRUCTION No 18

**Proof of buoyancy, trim and stability of the separated parts of a vessel**

(Article 22a.05(2), in conjunction with Article 22.02 and Article 22.03 of Annex II)

1. When proving the buoyancy, trim and stability of the parts of a vessel which have been separated in accordance with Article 22a.05(2)(a), it shall be assumed that both parts were partly or fully unloaded beforehand or That containers extending beyond the hatch coaming were suitably protected from slipping.
2. For each of the two parts, the following requirements shall therefore be met when calculating stability in accordance with Article 22.03 (Limit conditions and method of calculation for confirmation of stability for the transport of secured containers):
  - metacentric height MG shall be not less than 0,50 m,
  - there shall be a residual safety clearance of 100 mm,
  - the speed to be taken into account shall be 7 km/h,
  - the wind pressure shall be taken to be 0,01 t/m<sup>2</sup>.
3. The heeling angle ( $\leq 5^\circ$ ) does not have to be complied with for the parts of the vessel separated in accordance with Article 22a.05(2) since this angle — derived from the coefficient of friction — was specified for non-secured containers.

The heeling lever resulting from the free surfaces of liquids shall be taken into account in accordance with the formula given in Article 22.02(1)(e).
4. The requirements set out in points 2 and 3 shall also be deemed to have been met if, for each of the two parts, the stability requirements set out in Section 9.1.0.95.2 of the Ordinance on the transportation of hazardous goods on the Rhine (ADNR) are met.
5. Confirmation of the stability of the separated parts of the vessel may be obtained on the assumption that the load is evenly distributed, as an even distribution of the load — as far as it is not already the case — can be done prior to separation, or else the vessel can be largely unloaded.



▼ M5

ADMINISTRATIVE INSTRUCTION No 19

(Left void)

▼ **M5**

## ADMINISTRATIVE INSTRUCTION No 20

**Equipment for vessels to be operated according to standards S1 and S2**

(Article 23.09 of Annex II)

## 1. GENERAL INTRODUCTION

According to Article 23.09(1) of Annex II, vessels which are intended to be operated according to standards S1 and S2 shall comply with the provisions of this Article. According to Article 23.09(1) the inspection body shall confirm in the Community Certificate that the vessel complies with these provisions.

These provisions are supplementary equipment requirements which apply in addition to the requirements with which a vessel has to comply for the Community Certificate to be issued. Provisions of Article 23.09 which might be interpreted in different ways will be clarified in this Administrative instruction. Accordingly, the provisions of Article 23.09(1) of Annex II shall be interpreted as follows:

## 2. ARTICLE 23.09

2.1. **(1.1)(a) — Arrangement of the propulsion system**

If a vessel is fitted with a directly reversible main engine, the compressed air system which is required to reverse the direction of thrust shall:

- (a) be kept permanently pressurised by an automatically adjusting compressor; or
- (b) when an alarm is triggered in the wheelhouse be pressurised by means of an auxiliary engine which can be started from the steering position. If the auxiliary engine has its own fuel tank, there shall — in accordance with Article 8.05(13) — be a warning device in the wheelhouse to indicate if the level of filling is not sufficient to ensure further safe operation.

2.2. **(1.1)(b) — Bilge levels in the main engine room**

If a bow steering system is necessary to comply with the manoeuvring requirements of Chapter 5, the room containing the bow steering system shall be deemed to be a main engine room.

2.3. **(1.1)(c) — Automatic fuel supply**

## 2.3.1. If the propulsion system has a daily-supply tank,

- (a) its contents shall be sufficient to ensure an operation period of the propulsion system of 24 hours, assuming a consumption of 0,25 litres per kW per hour;
- (b) the fuel supply pump for refilling the daily-supply tank shall be operated continuously; or
- (c) the fuel supply pump shall be fitted with:
  - a switch that automatically switches on the fuel supply pump when the daily-supply tank reaches a certain low level, and
  - a switch that automatically switches off the fuel supply pump when the daily-supply tank is full.

## 2.3.2. The daily-supply tank shall have a level alarm device which meets the requirements of Article 8.05(13).

2.4. **(1.1)(d) — No particular force required for the steering system**

Hydraulically operated steering systems fulfil this requirement. Manually operated steering systems shall not require a force of more than 160 N in order to be operated.

▼ **M5****2.5. (1.1)(e) — Visual and acoustic signals required under way**

Visual signs do not include cylinders, balls, cones or double cones required under navigational authority regulations of the Member States.

**2.6. (1.1)(f) — Direct communication and communication with the engine room**

2.6.1. Direct communication shall be deemed to be ensured if:

- (a) direct visual contact is possible between the wheelhouse and the control positions for the winches and bollards on the fore section or the stern of the vessel and in addition the distance from the wheelhouse to these control positions is not more than 35 m; and
- (b) the accommodation is directly accessible from the wheelhouse.

2.6.2. Communication with the engine room shall be deemed to be ensured if the signal referred to in Article 7.09(3) second sentence, can be operated independently from the switch referred to in Article 7.09(2).

**2.7. (1.1)(i) — Cranks and similar rotating means of operation**

These include:

- (a) manually operated anchor winches (the maximum force required shall be deemed to be that when the anchors are hanging freely);
- (b) cranks for lifting hatches;
- (c) cranks on mast and funnel winches.

These do not include:

- (a) warping and coupling winches;
- (b) cranks on cranes, unless intended for ship's boats.

**2.8. (1.1)(m) — Ergonomic arrangement**

The provisions are deemed to be fulfilled if:

- (a) the wheelhouse is arranged in accordance with European Standard EN 1864:2008; or
- (b) the wheelhouse is designed for radar navigation by one person; or
- (c) the wheelhouse meets the following requirements:
  - (aa) the control units and monitoring instruments are in the forward field of vision and within an arc of not more than 180° (90° to starboard and 90° to port), including the floor and ceiling. They shall be clearly legible and visible from the normal position of the helmsman;
  - (bb) the main control units such as the steering wheel or steering lever, the engine controls, the radio controls, and the controls for the acoustic signals and the warning and manoeuvring signals required under national or international navigational authority regulations, as appropriate, shall be arranged in such a way that the distance between the controls on the starboard side and those on the port side is not more than 3 m. The helmsman shall be able to operate the engines without letting go of the controls for the steering system and while still being able to operate the other controls such as the radio system, the controls for the acoustic signals and the warning and manoeuvring signals required under national or international navigational authority regulations, as appropriate;
  - (cc) the warning and manoeuvring signals required under national or international navigational authority regulations, as appropriate, are operated electrically, pneumatically, hydraulically or mechanically. By way of derogation, it may be operated by means of a tension wire only if safe operation from the steering position is possible in this way.

▼ **M5**

## 3. ARTICLE 23.09

3.1. **(1.2)(a) — Motor vessel operating separately**

Motor vessels which according to the Community Certificate are also suitable for pushing but which:

- (a) do not have hydraulically or electrically operated coupling winches; or
- (b) whose hydraulically or electrically operated coupling winches do not meet the requirements of point 3.3 of this Administrative instruction,

shall be given the standard S2 as motor vessel operating separately.

The entry 'Standard S2 does not apply to the motor vessel when pushing' shall be entered under item 47 of the Community Certificate.

3.2. **(1.2)(c) — Pushed convoys**

Motor vessels which according to their Community Certificate are suitable for pushing and are fitted with hydraulically or electrically operated coupling winches that fulfil the requirements of point 3.3 of this Administrative instruction but which do not have their own bow thruster shall be given the standard S2 as motor vessel pushing a convoy. The entry 'Standard S2 does not apply to the motor vessel when operating separately' shall be entered under item 47 of the Community Certificate.

3.3. **(1.2)(c), first sentence, and (1.2)(d), first sentence — Special winches or equivalent devices for tensioning the cables (coupling devices)**

The coupling devices required are the minimum equipment specified in accordance with Article 16.01(2) which, according to points 2.1 and 2.2 of Administrative instruction No 3 (longitudinal connections), serve to take up the coupling forces and which meet the following requirements:

- (a) the device shall provide the tensioning force required for the coupling only by mechanical means;
- (b) the controls for the device shall be located on the device itself. By way of derogation, remote control is permitted provided that:
  - the person operating the device has an unobstructed direct view of the device from the control position,
  - there is a device at the control position to prevent unintentional operation,
  - the device has an emergency stop;
- (c) the device shall have a braking device which acts immediately if the controls are released or the motive force fails;
- (d) it shall be possible for the coupling cable to be released manually if the motive force fails.

3.4. **(1.2)(c), second sentence, and (1.2)(d), second sentence — Operating the bow thruster**

The control for operating the bow thruster shall be permanently installed in the wheelhouse. The requirements of Article 7.04(8) shall be complied with. The electric cabling to operate the bow thruster shall be permanently installed up to the fore section of the pushing motor vessel or the pusher.

3.5. **(1.2)(e) — Equivalent manoeuvrability**

Equivalent manoeuvrability is ensured by a propulsion system consisting of:

- (a) a multi-propeller drive and at least two independent propulsion systems with similar power output;

▼ M5

- (b) at least one cycloidal propeller;
- (c) at least one rudder propeller; or
- (d) at least one 360° water-jet propulsion system.

**▼M5**

## ADMINISTRATIVE INSTRUCTION No 21

**Requirements for low-location lighting**

(Article 15.06(7); Article 22b.10(d) of Annex II)

**1. General**

- 1.1. According to the abovementioned provisions, passenger vessels and high-speed vessels shall have suitable systems to clearly identify the escape routes and emergency exits when the normal emergency lighting is less effective due to smoke. Such systems shall take the form of low-location lighting (LLL). This Administrative instruction covers the approval, installation and maintenance of such systems.
- 1.2. In addition to the emergency lighting required by Article 15.10(3) the escape routes, including stairways, exits and emergency exits, shall be marked by low-location lighting (LLL) throughout the whole of the escape route, particularly at corners and intersections.
- 1.3. The LLL system shall function for at least 30 minutes after its activation.
- 1.4. LLL products shall be neither radioactive nor toxic.
- 1.5. Instructions on the LLL system shall be displayed with the safety plan in accordance with Article 15.13(2) and in every cabin.

**2. Definitions**

- 2.1. Low-location lighting (LLL) — Electrically powered lighting or photoluminescent indicators placed along the escape routes so as to ensure that all such routes can be easily identified.
- 2.2. Photoluminescent (PL) system — An LLL system which uses PL material. Photoluminescent material contains a chemical (example: zinc sulphide) that has the quality of storing energy when illuminated by visible light. The PL material emits light which becomes visible when the ambient light source is less effective. Without the light source to re-energise it, the PL material gives off the stored energy for a period of time with diminishing luminance.
- 2.3. Electrically powered (EP) system — An LLL system which requires electrical power for its operation, such as systems using incandescent bulbs, light-emitting diodes, electroluminescent strips or lamps, electrofluorescent lamps, etc.

**3. Passageways and stairways**

- 3.1. In all passageways, the LLL shall be continuous, except where interrupted by corridors and cabin doors, in order to provide a visible delineation along the escape route. LLL systems in compliance with an international standard having a visible delineation without being continuous shall also be acceptable. The LLL shall be installed at least on one side of the corridor, either on the wall no more than 0,3 m from the floor, or on the floor no more than 0,15 m from the wall. In corridors more than two metres wide, LLL shall be installed on both sides.
- 3.2. In dead-end corridors, the LLL shall have arrows placed at intervals of no more than 1 m, or equivalent direction indicators, pointing in the direction of the escape route.
- 3.3. In all stairways, LLL shall be installed on at least one side at no more than 0,3 m above the steps, which will make the location of each step readily identifiable to any person standing above and below that step. Low-location lighting shall be installed on both sides if the width of the stairway is two metres or more. The top and bottom of each set of stairs shall be identified to show that there are no further steps.

**4. Doors**

- 4.1. Low-location lighting shall lead to the exit door handle. To prevent confusion, no other doors shall be similarly marked.

**▼M5**

- 4.2. Where sliding doors are fitted in partitions in accordance with Article 15.11(2) and in bulkheads in accordance with Article 15.02(5), the direction of opening shall be indicated.

**5. Signs and markings**

- 5.1. All escape route signs shall be of photoluminescent material or marked by electric lighting. The dimensions of such signs and markings shall be commensurate with the rest of the LLL system.
- 5.2. Low-location lighting exit signs shall be provided at all exits. The signs shall be located within the prescribed area on the side of the exit doors where the handle is located.
- 5.3. All signs shall contrast in colour to the background (wall or floor) on which they are installed.
- 5.4. Standardised symbols (for example those described in IMO Decision A.760(18)) shall be used for the LLL.

**6. Photoluminescent systems**

- 6.1. PL strips shall be no less than 0,075 m wide. Narrower strips may however be used if their luminance is increased proportionally to compensate for their width.
- 6.2. Photoluminescent materials shall provide at least 15 mcd/m<sup>2</sup> measured 10 minutes after the removal of all external illuminating sources. The system shall then continue to provide luminance values greater than 2 mcd/m<sup>2</sup> for 20 minutes.
- 6.3. Any PL system materials shall be provided with not less than the minimum level of ambient light necessary to charge the PL material to meet the above luminance requirements.

**7. Electrically powered systems**

- 7.1. Electrically powered systems shall be connected to the emergency switchboard required by Article 15.10(4) so as to be powered by the main source of electrical power under normal circumstances and also by the emergency source of electrical power when the latter is in operation. For the purpose of dimensioning the capacity of the emergency source of electrical power the EP systems shall be included in the list of emergency consumers.
- 7.2. Electrically powered systems shall either switch on automatically or be capable of being activated by means of a single operation at the steering position.
- 7.3. Where electrically powered systems are installed, the following standards of luminance shall be applied:
1. the active parts of electrically powered systems shall have a minimum luminance of 10 cd/m<sup>2</sup>;
  2. the point sources of miniature incandescent lamps shall provide not less than 150 mcd mean spherical intensity with a spacing of not more than 0,1 m between lamps;
  3. the point sources of light-emitting-diode systems shall have a minimum peak intensity of 35 mcd. The angle of half-intensity cone shall be appropriate to the likely track directions of approach and viewing. Spacing between lamps shall be no more than 0,3 m; and
  4. for electroluminescent systems, these shall function for 30 minutes from the instant when the main power supply to which it was required to be connected by Section 7.1 fails.
- 7.4. All EP systems shall be arranged so that the failure of any single light, lighting strip, or battery will not result in the marking being ineffective.
- 7.5. Electrically powered systems shall meet the requirements of Article 9.20 for vibration and heat testing. By way of derogation from Article 9.20(2) (c) the heat test may be conducted at a reference ambient temperature of 40 °C.

**▼M5**

- 7.6. Electrically powered systems shall meet the electromagnetic compatibility requirements laid down in Article 9.21.
- 7.7. Electrically powered systems shall provide a type of minimum protection of IP 55 in accordance with IEC 60529:1992.

**8. Tests**

LLL systems shall have their luminance tested by an expert at least once every five years. A test certificate shall be signed by the expert, indicating the date of the test. If the luminance for a particular reading does not meet the requirements of this Administrative instruction, readings shall be taken in at least ten locations equally spaced apart. If more than 30 % of the readings do not meet the requirements of this Administrative instruction, the LLL shall be replaced. If between 20 % and 30 % of the readings do not meet the requirements of this Administrative instruction, the LLL shall be checked again within one year.



▼ **M5**

## ADMINISTRATIVE INSTRUCTION No 22

**Specific safety needs of persons with reduced mobility**

(Article 1.01(104), Article 15.01(4), Article 15.06(3) to (5), (9), (10), (13) and (17), Article 15.08(3), Article 15.10(3), Article 15.13(1) to (4) of Annex II)

**1. Introduction**

Persons with reduced mobility have safety needs exceeding those of other passengers. These needs are taken into account in the requirements of Chapter 15, which are explained as follows.

These requirements are intended to ensure that persons with reduced mobility can stay and move safely on board vessels. In addition, in an emergency such persons should have the same level of safety as other passengers.

It is not necessary that all passenger areas fulfil the specific safety requirements of persons with reduced mobility. Therefore those requirements apply only to certain areas. However, the persons in question must be given the opportunity of being informed of the areas specially adapted for them in view of safety, so that they can organise their stay on board accordingly. It is the responsibility of the ship-owner to make the corresponding areas available, make them known and communicate them to persons with reduced mobility.

The provisions concerning persons with reduced mobility make reference to:

- Directive 2003/24/EC of the European Parliament and of the Council of 14 April 2003 amending Council Directive 98/18/EC on safety rules and standards for passenger ships, and
- the guide for the adaptation of inland waterway passenger vessels to people with disabilities in accordance with Resolution No 25 of the United Nations Economic Commission for Europe.

The definition of the term ‘persons with reduced mobility’ used in Annex II is largely identical to that of the Directive and most of the technical requirements are based on the guide. In cases of doubt, therefore, both can be referred to when taking decisions. In general, the requirements of the Directive and guide go beyond those of Annex II.

The requirements of Annex II do not concern berths and similar installations. These are subject to national provisions.

**2. Article 1.01(104) — Term ‘Persons with reduced mobility’**

‘Persons with reduced mobility’ means anyone who, as a result of physical impairments, cannot move or distinguish their surroundings in the same way as other passengers. This definition includes persons with impaired eyesight or hearing or persons accompanying children in buggies or being carried. However, for the purposes of these provisions, persons with reduced mobility do not include anyone with psychic impairments.

**3. Article 15.01(4) — General provisions: Areas provided for use by persons with reduced mobility**

Areas provided for use by persons with reduced mobility range from, in the simplest case, the entrance area to the places from which an evacuation will take place in an emergency. They shall include:

- a place where life-saving equipment is stowed or issued in an emergency,
- seats,
- a suitably-adapted toilet (No 10 of these guidelines), and
- connecting corridors.

The number of seats corresponds at least approximately to the number of persons with reduced mobility that — over a lengthy period — are most

▼ **M5**

frequently onboard simultaneously. The number should be determined by the ship-owner on the basis of experience, as this is beyond the knowledge of the competent authority.

On cabin vessels consideration shall also be given to connecting corridors to passenger cabins used by persons with reduced mobility. The number of such cabins is to be determined by the ship-owner in the same way as the number of seats. With the exception of the width of doors, no requirements are imposed for the special arrangement of cabins. It is the responsibility of the owner to make any further necessary arrangements.

Sentence 2 is identical to Article 24.04(4), taking into account the special safety requirements of persons with reduced mobility. It shall therefore be applied likewise. Should the recommendations require alternative measures, these may in particular be of organisational nature.

4. **Article 15.06(3)(g) — Exits of rooms**

With regard to the requirements concerning the width of connecting corridors, exits and openings in bulwarks or guard rails intended for use by persons with reduced mobility or usually used for the embarkation or disembarkation of persons with reduced mobility, consideration shall be given to buggies and the fact that people may be dependent on various types of walking aids or wheelchairs. In the case of exits or openings for embarkation or disembarkation account shall also be taken of the additional space needed for any assisting staff.

5. **Article 15.06(4)(d) — Doors**

The requirements regarding the arrangement of the area surrounding doors intended for use by persons with reduced mobility shall ensure that persons dependent for example on walking aids can open such doors safely.

6. **Article 15.06(5)(c) — Connecting corridors**

See point 4 of this Administrative instruction.

7. **Article 15.06(9) — Stairways and elevators**

The requirements for the arrangement of stairways shall, in addition to possible reduced mobility, also take into account eyesight impediments.

8. **Article 15.06(10)(a) and (b) — Bulwarks and guard rails**

The requirements for bulwarks and guard rails of decks intended for use by persons with reduced mobility shall provide for a greater height since such persons are more likely to lose their balance or be unable to hold on by themselves.

See also point 4 of this Administrative instruction.

9. **Article 15.06(13) — Traffic areas**

For various reasons, persons with reduced mobility need to support themselves or hold on more frequently, so walls in traffic areas intended for use by persons with reduced mobility shall be equipped with handrails at an appropriate height.

See also point 4 of this Administrative instruction

10. **Article 15.06(17) — Toilets**

Persons with reduced mobility shall also be able to stay and move safely in toilets, so at least one toilet shall be adapted accordingly.

**▼M5****11. Article 15.08(3)(a and b) — Alarm system**

Persons with reduced mobility are more likely to encounter situations in which they are dependent on the help of others. In rooms in which, as a general rule, they cannot be seen by crew members, on-board personnel or passengers, the possibility of triggering an alarm should therefore be provided for. This applies to toilets intended for use by persons with reduced mobility.

Persons with reduced mobility include persons with impaired eyesight or hearing. Consequently, at least in areas intended for use by persons with reduced mobility, the passenger alarm system shall provide suitable visual and audible alarms.

**12. Article 15.10(3)(d) — Sufficient lighting**

Persons with reduced mobility also include persons with impaired eyesight. Sufficient lighting in areas intended for use by persons with reduced mobility is therefore essential and shall meet higher requirements than lighting for other passenger areas.

**13. Article 15.13(1) — Safety rota**

The special safety measures necessary for persons with reduced mobility to be taken into consideration in the safety rota shall take into account both the possibility of reduced mobility and impaired hearing and eyesight. For such persons measures for normal operation shall be taken into account in addition to measures in the event of emergencies.

**14. Article 15.13(2) — Safety plan**

The areas covered by point 3 of this Administrative instruction shall be designated.

**15. Article 15.13(3)(b) — Displaying the safety rota and the safety plan**

At least the copies of the safety rota and the safety plan displayed in the areas intended for use by persons with reduced mobility shall be such that they can, where possible, also be read by persons with impaired eyesight. This can be achieved for example by appropriate use of contrast and character size.

In addition, the plans shall be displayed at a height so that wheelchair users can read them as well.

**16. Article 15.13(4) — Code of conduct for passengers**

Point 15 of this Administrative instruction applies accordingly

▼ M5

ADMINISTRATIVE INSTRUCTION No 23

(Left void)

▼ **M5**

## ADMINISTRATIVE INSTRUCTION No 24

**Suitable gas warning equipment**

(Article 15.15(9) of Annex II)

1. In accordance with Sections 24.02(2) and 24.06(5) (in each case transitional provision to Section 15.01(2)(e)) liquefied petroleum gas (LPG) systems for household purposes on board existing passenger vessels may only be operated until the first renewal of the Community Certificate after 1 January 2045, on condition that a gas warning equipment in accordance with Section 15.15(9) is available. In accordance with Section 15.15(9), LPG systems for household purposes may in the future also be installed on passenger vessels put into operation for the first time and of which the length does not exceed 45 m, if such warning equipment is installed at the same time.
2. In accordance with Sections 24.02(2) and 24.06(5) (in each case transitional provision to Section 15.15(9)) this gas warning equipment shall be installed on the first renewal of the certificate in accordance with Section 14.15.
3. The gas warning equipment consists of sensors, equipment and pipes and shall be considered suitable if it at least meets the following prescribed requirements:
  - 3.1. Requirements to be met by the system (sensors, equipment, pipes):
    - 3.1.1. Gas warning shall be given at the latest when reaching or exceeding one of the following values:
      - (a) 10 % lower explosion limit (LEL) of a propane-air mixture; and
      - (b) 30 ppm CO (carbon monoxide).
    - 3.1.2. The time until activation of the alarm for the whole system must not exceed 20 s.
    - 3.1.3. The limit values mentioned in numbers 3.1.1 and 3.1.2 must not be adjustable.
    - 3.1.4. The test gas production shall be so designed that any interruption or obstruction is detected. Any falsification due to air admission or loss of test gas as a consequence of leakage shall be avoided or detected and reported.
    - 3.1.5. The equipment shall be designed for temperatures ranging from -10 to 40° C and an air humidity ranging from 20 to 100 %.
    - 3.1.6. The gas warning equipment must be self-monitoring. It shall be impossible to switch off the equipment unauthorised.
    - 3.1.7. Gas warning equipment supplied by the onboard power supply network shall be buffered against power failure. Battery-powered appliances shall be provided with a warning device indicating a reduction of the battery voltage.
  - 3.2. Requirements to be met by the equipment:
    - 3.2.1. The equipment shall consist of an evaluation and display unit.
    - 3.2.2. The alarm indicating that the limit values in points 3.1.1(a) and (b) have been reached or exceeded shall be given optically and acoustically, both in the room monitored and in the wheelhouse or at any other permanently manned location. It shall be clearly visible and audible even in operating conditions with the highest noise level. It shall be clearly distinguishable from any other acoustic and optical signals in the room to be protected. The acoustic alarm shall also be clearly audible with closed connecting doors at the entrances and in neighbouring rooms. The acoustic alarm may be silenced after activation, the optical alarm may only be cancelled if the limit values fall below those given mentioned in point 3.1.1.
    - 3.2.3. It shall be possible to separately detect and clearly assign the reports indicating that the limit values in points 3.1.1(a) and (b) have been reached or exceeded.
    - 3.2.4. If the appliance has a special status (start-up, failure, calibration, parameterisation, maintenance etc.), this shall be indicated. The failure of the

**▼M5**

whole system or one of the components shall be indicated by an alarm in analogy to point 3.2.2. The acoustic alarm may be silenced after activation, the optical alarm may only be cancelled if the failure is removed.

- 3.2.5. If it is possible to issue different reports (limit values, special status) it shall also be possible to discern them separately and to assign them clearly. If necessary, a collective signal shall be displayed indicating that it is not possible to issue all reports. In this case, the reports shall be issued by order of priority, beginning with the report with the highest safety relevance. The display of the reports which cannot be issued shall be possible by pressing a button. The order of priority shall be evident from the documentation of the appliance.
- 3.2.6. The equipment shall be so designed that unauthorised interference is not possible.
- 3.2.7. In all cases where detection and alarm equipment are used, the control alarm unit and indicating device shall be operable from outside the spaces containing the gas storage and consuming appliances.
- 3.3. Requirements to be met by the sensors/sampling devices:
  - 3.3.1. In every room with consuming appliances, sensors of the gas warning equipment shall be provided in the vicinity of these appliances. The sensors/sampling devices shall be installed in such a way that gas accumulation is detected before the limit values mentioned in point 3.1.1 are reached. Arrangement and installation of the sensors shall be documented. The selection of the locations shall be substantiated by the manufacturer or the specialised firm installing the equipment. The pipes of the sampling devices should be as short as possible.
  - 3.3.2. The sensors shall be easily accessible in order to enable regular calibration, maintenance and safety checks.
- 3.4. Requirements to be met by the installation:
  - 3.4.1. The whole gas warning equipment shall be installed by a specialised firm.
  - 3.4.2. For the installation, the following aspects shall be taken into consideration:
    - (a) local ventilation systems;
    - (b) structural arrangements (design of walls, partitions etc.) facilitating or complicating the accumulation of gases; and
    - (c) prevention of adverse effects due to mechanical damage, water or heat damage.
  - 3.4.3. All pipes of the sampling devices shall be arranged in such a way that condensate formation is not possible.
  - 3.4.4. The installation shall be effected in such a way that any unauthorised tampering is not possible.
4. Calibration/inspection of the equipment
  - 4.1. Before the starting-up of the gas warning equipment, it shall be calibrated in accordance with the manufacturer's details.
  - 4.2. The gas warning equipment shall be regularly calibrated and inspected by an approved expert or an expert in accordance with the manufacturer's details. An inspection certificate shall be issued, signed by the approved expert or an expert in accordance with the manufacturer's details and showing the date of the inspection.
  - 4.3. Elements of the gas warning equipment with limited lifespan shall be replaced in due time before the expiry of the expected lifespan.
5. Marking
  - 5.1. All appliances shall at least show the following information in a clearly legible and indelible form:
    - (a) name and address of the manufacturer;
    - (b) legal marking;
    - (c) designation of series and type;

**▼M5**

- (d) if possible, serial number;
  - (e) if required, any advice indispensable for safe use; and
  - (f) for each sensor the indication of the calibration gas.
- 5.2. Elements of the gas warning equipment with limited restricted lifespan shall be clearly marked as such.
6. Manufacturer's details relating to the gas warning equipment:
- (a) complete instructions, drawings and diagrams concerning the safe and proper operation as well as the installation, starting-up and maintenance of the gas warning equipment;
  - (b) operating instructions containing at least:
    - (aa) measures to be taken in the case of an alarm or error indication;
    - (bb) safety measures in the case of non-availability (e.g. calibration, inspection, interruption); and
    - (cc) persons responsible for installation and maintenance;
  - (c) instructions for calibration before the starting-up, and for routine calibration, including time intervals to be followed;
  - (d) supply voltage;
  - (e) type and meaning of the alarms and displays (e.g. special status);
  - (f) information concerning the detection of operating difficulties and the removal of faults;
  - (g) type and scope of the replacement of components with limited lifespan; and
  - (h) type, scope and time interval of the inspections.

▼ **M5****ADMINISTRATIVE INSTRUCTION No 25****Electric cables**

(Article 9.15 and 15.10(6) of Annex II)

**General (all vessels) — Article 9.15**

1. When applying Article 9.15, Section 5, reduced ventilation of shielded cables or cables in totally enclosed trunks has to be taken into account.
2. In Article 9.15, Section 9 the number of cable joints should be kept to a minimum. They may be used for repair or replacement purposes as well as, exceptionally, for the simplification of installation. Cable joints made in accordance with 3.28 and Annex D to IEC 60092-352:2005, or equivalent regulations recognised by one of the Member States, will be considered acceptable.

**Passenger vessels — Article 15.10(6)**

1. On passenger vessels, cables and cable routing are considered to be satisfactory if they meet the conditions in 2 and 3.
2. For cables providing power in an emergency to equipment listed in Article 15.10, Section 4, compliance with Article 15.10, Section 6 second paragraph will require that:
  - (a) the cables are run in such a manner as to avoid being rendered unserviceable by heating of the bulkheads and decks that may be caused by a fire in an adjacent space;
  - (b) where the cables supply equipment located within high fire risk areas, the cable runs within such areas must avoid routes which pass over or near the top of diesel engines and oil-fired equipment, or near to hot surfaces e.g. diesel engine exhaust systems. Where there is no alternative route, cables must be protected from heat and fire damage. Such fire protection could be in the form of a steel plate or trunk;
  - (c) the cables and associated equipment supplied from the emergency source of power should, as far as practicable, be kept within the safe area;
  - (d) cable systems are arranged so that fire in any area bounded by Type A partitions as shown in Article 15.11, Section 2 will not interfere with services essential for safety in any other such area. This requirement will be met if main and emergency cables do not pass through the same area. If they pass through the same area, the requirement will be met if:
    - (aa) they are separated as wide as is practicable; or
    - (bb) the emergency cable is of the fire resistant type.
3. Consideration should be given to the arrangements of bunched cable runs to ensure that the flame-retardant characteristics of the cables are not impaired. This requirement is met if the cables are in accordance with IEC 60332-3:2000. If compliance with IEC 60332-3:2000, or equivalent regulations recognised by one of the Member States, is not met, fire stops in long runs of bunched cables (over 6 m vertical and 14 m horizontal) should be considered, unless the cables are totally enclosed in cable trunks. The use of unsuitable paints, trunking and casings may significantly affect the fire propagation characteristics of cables and shall be avoided. The use of special types of cables such as radio frequency cables may be permitted without complying with the foregoing.



▼ **M3***Appendix III***Model of the Unique European Vessel Identification Number**

A	A	A	x	x	x	x	x
[Code of the competent authority that assigns the European Vessel Identification Number]			[Serial Number]				

In the model, 'AAA' represents the three-digit code given by the competent authority assigning the European Vessel Identification Number according to the following number ranges:

001-019	France
020-039	Netherlands
040-059	Germany
060-069	Belgium
070-079	Switzerland
080-099	reserved for craft from countries that are not party to the Mannheim Convention and for which a Rhine Vessel Certificate has been issued before 1 April 2007
100-119	Norway
120-139	Denmark
140-159	United Kingdom
160-169	Iceland
170-179	Ireland
180-189	Portugal
190-199	reserved
200-219	Luxembourg
220-239	Finland
240-259	Poland
260-269	Estonia
270-279	Lithuania
280-289	Latvia
290-299	reserved
300-309	Austria
310-319	Liechtenstein
320-329	Czech Republic
330-339	Slovakia
340-349	reserved
350-359	Croatia
360-369	Serbia
370-379	Bosnia and Herzegovina
380-399	Hungary
400-419	Russian Federation
420-439	Ukraine
440-449	Belarus
450-459	Republic of Moldova
460-469	Romania
470-479	Bulgaria
480-489	Georgia
490-499	reserved

**▼ M3**

500-519	Turkey
520-539	Greece
540-549	Cyprus
550-559	Albania
560-569	former Yugoslav Republic of Macedonia
570-579	Slovenia
580-589	Montenegro
590-599	reserved
600-619	Italy
620-639	Spain
640-649	Andorra
650-659	Malta
660-669	Monaco
670-679	San Marino
680-699	reserved
700-719	Sweden
720-739	Canada
740-759	United States of America
760-769	Israel
770-799	reserved
800-809	Azerbaijan
810-819	Kazakhstan
820-829	Kyrgyzstan
830-839	Tajikistan
840-849	Turkmenistan
850-859	Uzbekistan
860-869	Iran
870-999	reserved.

'xxxxx' represents the five-digit serial number given by the competent authority.

▼ **M3***Appendix IV***Data for the identification of a vessel****A. All vessels**

1. Unique European Vessel Identification Number in accordance with Article 2.18 of this Annex (Annex V, Part 1, box 3 of the model, and Annex VI, fifth column)
2. Name of the craft/vessel (Annex V, Part 1, box 1 of the model, and Annex VI, fourth column)
3. Type of craft as defined in Article 1.01, points 1-28, of this Annex (Annex V, Part 1, box 2 of the model)
4. Length over all as defined in Article 1.01, point 70, of this Annex (Annex V, Part 1, box 17a)
5. Breadth over all as defined in Article 1.01 point 73, of this Annex (Annex V, Part 1, box 18a)
6. Draught as defined in Article 1.01 point 76, of this Annex (Annex V, Part 1, box 19)
7. Source of data (= Community Certificate)
8. Deadweight (Annex V, Part 1, box 21 and Annex VI, 11th column) for cargo vessels
9. Displacement as defined in Article 1.01 point 60, of this Annex (Annex V, Part 1, box 21 and Annex VI, 11th column) for vessels other than cargo vessels
10. Operator (owner or his representative, Annex II, Chapter 2)
11. Issuing Authority (Annex V, Part 1, and Annex VI)
12. Number of Community Inland Navigation Certificate (Annex V, Part 1, and Annex VI, first column of the model)
13. Expiration date (Annex V, Part 1, box 11 of the model, and Annex VI, 17th column of the model)
14. Creator of dataset

**B. Where available**

1. National number
2. Type of craft in accordance with the Technical Specification for Electronic Ship Reporting in inland navigation
3. Single or double hull in accordance with ADN/ADNR
4. Height as defined in Article 1.01 No 75
5. Gross tonnage (for maritime vessels)
6. IMO number (for maritime vessels)
7. Call sign (for maritime vessels)
8. MMSI number
9. ATIS code
10. Type, number, issuing authority and expiration date of other certificates

*ANNEX III***SUBJECTS FOR POSSIBLE ADDITIONAL TECHNICAL REQUIREMENTS APPLICABLE TO VESSELS ON INLAND WATERWAYS OF ZONES 1 AND 2**

Any additional technical requirements adopted by a Member State under Article 5(1) of this Directive for vessels operating on Zones 1 and/or 2 of that Member State's territory are limited to the following subjects:

1. Definitions
  - Necessary for understanding the additional requirements
2. Stability
  - Structure reinforcement
  - Certificate/attestation by an approved Classification Society
3. Safety clearance and freeboard
  - Freeboard
  - Safety clearance
4. Watertightness of hull openings and superstructures
  - Superstructures
  - Doors
  - Windows and skylights
  - Hold hatches
  - Other openings (ventilation pipes, exhaust pipes, etc.)
5. Equipment
  - Anchors and anchor chains
  - Navigation lights
  - Sound signals
  - Compass
  - Radar
  - Transmitting and receiving installations
  - Life-saving equipment
  - Availability of nautical charts
6. Additional provisions for passenger vessels
  - Stability (wind strength, criteria)
  - Life-saving equipment
  - Freeboard
  - Safety clearance
  - Wheelhouse visibility
7. Convoys and container transport
  - Pusher connection craft-lighter
  - Stability of craft or lighters carrying containers

*ANNEX IV***SUBJECTS FOR POSSIBLE REDUCTIONS OF THE TECHNICAL REQUIREMENTS APPLICABLE TO VESSELS ON INLAND WATERWAYS OF ZONES 3 AND 4**

Any reduced technical requirements allowed by a Member State under Article 5(7) of this Directive for vessels operating exclusively on Zone 3 or Zone 4 waterways on the territory of that Member State are restricted to the following subjects:

**Zone 3**

- Anchor equipment, including length of anchor chains
- (Forward) speed
- Collective life-saving appliances
- Two-compartment status
- Wheelhouse visibility

**Zone 4**

- Anchor equipment, including length of anchor chains
- (Forward) speed
- Life-saving appliances
- Two-compartment status
- Wheelhouse visibility
- Second independent propulsion system

**▼B**

*ANNEX V*

**MODEL COMMUNITY INLAND NAVIGATION CERTIFICATES**

**Part I**

**MODEL COMMUNITY INLAND NAVIGATION CERTIFICATE**

**COMMUNITY INLAND NAVIGATION CERTIFICATE**

(Reserved for State emblem)

**NAME OF STATE**

CERTIFICATE No.....

....., .....

(Place)

(date)

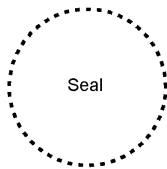

.....  
(Inspection body)

.....  
(Signature)

Remarks

The craft may be used for navigation by virtue of this certificate only while in the condition herein described.

In the event of major alterations or repairs, the craft must undergo a special inspection before any new voyage..

The owner of the craft, or his representative, must inform an inspection body of any change in the name or ownership of the craft, any remeasurement and any change in the official number, registration number or home port, and send it the inspection certificate for amendment.

**▼ B**

Certificate No ..... of the ..... inspection body

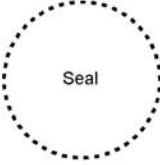
1. Name of craft	2. Type of craft	3. ▶ <sup>(1)</sup> Unique european vessel identification number ◀
4. Name and address of owner		
5. Place of registration and registration number	6. Home port	
7. Year of construction	8. Name and location of shipyard	
9. This certificate replaces Certificate No ..... issued on ..... by the ..... inspection body		
10. The abovementioned craft, subsequent to the inspection carried out on (*) ..... on presentation of the certificate issued on (*) ..... by the approved classification society ..... is acknowledged as fit to operate — on Community waterways in Zone(s) (*) ..... ..... on the waterways in Zone(s) (*) ..... ..... in ..... (Names of States (*) ) ..... except for: ..... ..... — on the following waterways in :... (Name of the State (*) ) ..... ..... ..... ..... at the maximum authorised draught and with the equipment and crew specified below.		
11. The validity of this certificate expires on.....		
(*) Amendment to item(s): ..... New text: ..... ..... ..... (*) ..... This page has been replaced. ..... <div style="display: flex; justify-content: space-around; align-items: flex-end;"> <div style="text-align: center;">                     (Place)                       Seal                 </div> <div style="text-align: center;">                     (date)                      .....                      Inspection body                      .....                      (Signature)                 </div> </div>		
(*) Delete as appropriate.		

▶<sup>(1)</sup> M3

**▼ B**

Certificate No ..... of the ..... inspection body

12. The certificate number (1), official number (2), registration number (3) and measurement number (4) are affixed with the corresponding signs at the following locations on the craft

1. ....

2. ....

3. ....

4. ....

13. The maximum authorised draught is indicated on each side of the craft

— by two — ..... — draught marks (\*).

— by the upper measurement plates (\*).

Two draught scales have been applied (\*).

The rear measurement scales serve as draught scales: they have been supplemented for that purpose by figures indicating the draughts (\*).

14. Without prejudice to the restrictions (\*) mentioned in items 15 and 52, the craft is fit to

1. push (*)	4. be propelled in a side-by-side formation (*)
1.1 in rigid formation (*)	5. tow (*)
1.2 with controlled articulation (*)	5.1 craft having no motive power of their own (*)
2. be pushed (*)	5.2 motorised craft (*)
2.1 in rigid formation (*)	5.3 upstream only (*)
2.2 at the head of a rigid formation (*)	6. be towed (*)
2.3 with controlled articulation (*)	6.1 as a motorised craft (*)
3. propel a side-by-side formation (*)	6.2 as a craft with no motive power of its own (*)

(\*) Amendment to item(s): .....

New text: .....

.....

(\*) This page has been replaced.

..... (Place) ..... (date) .....

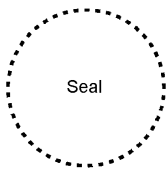

..... (Inspection body)

..... (Signature)

(\*) Delete as appropriate.





**▼ B**

Certificate No ..... of the ..... inspection body

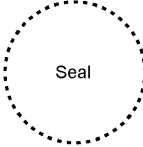
16. Measurement certificate No ..... of the ..... Measurement Office dated.....			
17 a. Length overall	m	18 a. Breadth overall	m
17 b. Length L	m	18 b. Breadth B	m
19. Maximum draught		m	20. Freeboard
			cm
21. Dead weight/Displacement (*) t/m <sup>3</sup> (*)		22. Number of passengers:	
		23. Number of passenger berths:	
24. Number of watertight compartments		25. Number of holds	
		26. Type of hatch cover	
27. Number of main propulsion engines		28. Total power rating of main means of propulsion kw	
		29. Number of main propellers	
30. Number of bow windlasses of which..... powered		31. Number of stern windlasses of which..... powered	
32. Number of towing hooks		33. Number of towing winches of which..... powered	
34. Steering gear			
Number of rudder blades on main rudder		Main rudder drive	
		— manual (*)	
		— electric (*)	
		— electric/hydraulic (*)	
		— hydraulic (*)	
Other installations:: yes/no (*) Type:			
Flanking rudder: yes /no (*)		Flanking rudder drive:	
		— manual (*)	
		— electric (*)	
		— electric/hydraulic (*)	
		— hydraulic (*)	
Bow rudder installation si/no (*)		— bow rudder (*)	
		— bow thruster (*)	
		— other installation (*)	
		— Remote control yes /no (*)	
		Remote activation yes /no (*)	
35. Pumping equipment			
Total calculated capacity		Number of power driven pumps	
..... l/min		.....	
		Flow rate	
		..... l/min	
		Number of pumps	
		.....	
(*) Amendment to item(s):.....			
New text: .....			
.....			
.....			
(*) This page has been replaced.			
.....		.....	
(Place)		(date)	
			
		(Inspection body)	
		.....	
		(Signature)	
(*) This page has been replaced.			

**▼ B**

Certificate No ..... of the ..... inspection body

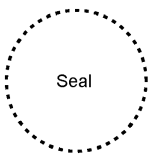
36. Number and position of closures referred to in Article 8.08(10) and (11)			
37. Anchors			
Number of bow anchors .....	Total mass of bow anchors ..... kg	Number of stern anchors .....	Total mass of stern anchors ..... kg
38. Anchor chains			
Number of bow anchor chains .....	Length of each chain ..... m	Tensile strength of each chain ..... kN	
Number of stern anchor chains .....	Length of each chain ..... m	Tensile strength of each chain ..... kN	
39. Mooring cables			
1st cable ..... m long with a tensile strength of..... kN			
2nd cable ..... m long with a tensile strength of..... kN			
3rd cable ..... m long with a tensile strength of..... kN			
40. Towing cables			
..... with a length of ..... m and a tensile strength of..... kN			
..... with a length of ..... m and a tensile strength of..... kN			
41. Visual and audible signals			
The lights, flags, balls, floats and audible warning devices used for signalling and to emit the visual and audible signals prescribed by the navigational authority regulations in force in the Member States are carried on board, as are the stand-alone emergency mooring lights prescribed by the navigational authority regulations in force in the Member States			
(*) Amendment to item(s): .....			
New text: .....			
.....			
.....			
(*) This page has been replaced			
.....		.....	
(Place)		(date)	
 <p>Seal</p>		.....	
		(Inspection body)	
		.....	
		(Signature)	
.....			
(*) Delete as appropriate.			

**▼ B**

Certificate No ..... of the ..... inspection body

42.	Other equipment heaving line gangway with handrail  gaff hook first-aid kit  pair of binoculars notice concerning rescue of persons overboard fire-resistant receptacles  embarkation stairway/ladder (*)	Voice communication system  Radio-telephone installation  Cranes	— alternative two-way (*) — simultaneous two-way/telephone (*) — internal radio-telephone link (*) — vessel-to-vessel service — nautical information service — vessel-port authority service  — in accordance with Article 11.12(9) (*) — other cranes with a useful load not exceeding 2 000 kg (*)
43.	Fire-fighting appliances	Number of portable extinguisher ..... Fixed sprinkler system(s) No. Number (*) ..... Other fixed fire-fighting system(s) No. Number (*) .....	
Number of fire pumps		Number of hydrants	Number of hoses
The powered drainage pump replaces a fire pump			Yes/No (*)
44.	Life-saving equipment Number of lifebuoys  A life-jacket for each person regularly on board.  Other life-saving equipment on passenger vessels (*) ..... ..... ..... .....  A ship's boat with a set of oars, one mooring line and a baler (*) Collective life-saving equipment on passenger vessels (*) ..... ..... ..... .....		
45.	Special wheelhouse arrangements for radar navigation by one person: The vessel has a wheelhouse designed for radar navigation by one person (*).		
(*) Amendment to item(s): ..... New text: ..... ..... .....			
(*) This page has been replaced. ..... <div style="display: flex; justify-content: space-around;"> <div style="text-align: center;">                     (Place)                        Seal                 </div> <div style="text-align: center;">                     (date)                      .....                      (Inspection body)                      .....                      (Signature)                 </div> </div>			
(*) Delete as appropriate.			

**▼ B**

Certificate No ..... of the ..... inspection body

46. Operating modes meeting the requirements of national or international law concerning the crew (\*\*)

47. Vessel equipment in accordance with Article 23.09  
 The vessel (complies) (\*)/(does not comply) (\*) with Article 23.09 (1) (\*)/(Article 23.09(1)(2) (\*)

Space for entering the minimum crew meeting the requirements of national or international law (**)	Space for entering the operating modes according to item 46.		
..... ..... .....	.....	.....	.....

48. Space for entering the minimum crew for vessels that are not covered by general minimum crew prescriptions in national or international requirements (\*\*)

	Space for entering the operating modes (**)		
..... ..... ..... ..... ..... ..... ..... ..... ..... .....	.....	.....	.....

Observations and special conditions:  
 .....  
 .....  
 .....  
 .....

(\*) Amendment to item(s): .....  
 New text: .....  
 .....

(\*) This page has been replaced.  
 .....  
 (Place) (date)

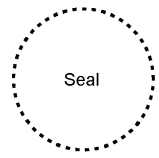

.....  
 (Inspection body)  
 .....  
 (Signature)

(\*) Delete as appropriate.  
 (\*\*) Requirements of national or international law which a Member State may choose to apply, or have no requirements.

**▼ B**

Certificate No ..... of the ..... inspection body

**49. Extension/confirmation (\*) of certificate validity (\*) Periodical/special (\*) inspection**

The Inspection Body inspected the vessel on ..... (\*).  
 A certificate dated ..... from the ..... approved classification society  
 .....  
 was presented to the inspection body (\*)  
 Reason for the inspection/certificate (\*)  
 .....  
 In view of the inspection result/certificate (\*), the period of validity of the certificate is maintained/extended (\*)  
 until .....  
 ..... (Place) ..... (date)

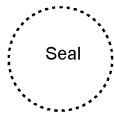

..... (Inspection body)

..... (Signature)

(\*) Delete as appropriate.

**49. Extension/confirmation (\*) of certificate validity (\*) Periodical/special (\*) inspection**

The Inspection Body inspected the vessel on ..... (\*).  
 A certificate dated ..... from the ..... approved classification society  
 .....  
 was presented to the inspection body (\*)  
 Reason for the inspection/certificate (\*)  
 .....  
 In view of the inspection result/certificate (\*), the period of validity of the certificate is maintained/extended (\*)  
 until .....  
 ..... (Place) ..... (date)

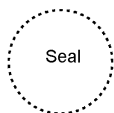

..... (Inspection body)

..... (Signature)

(\*) Delete as appropriate.

**49. Extension/confirmation (\*) of certificate validity (\*) Periodical/special (\*) inspection**

The Inspection Body inspected the vessel on ..... (\*).  
 A certificate dated ..... from the ..... approved classification society  
 .....  
 was presented to the inspection body (\*)  
 Reason for the inspection/certificate (\*)  
 .....  
 In view of the inspection result/certificate (\*), the period of validity of the certificate is maintained/extended (\*)  
 until .....  
 ..... (Place) ..... (date)

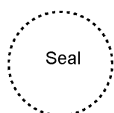

..... (Inspection body)

..... (Signature)

(\*) Delete as appropriate.

**▼ B**

Certificate No ..... of the ..... inspection body

**49. Extension/confirmation (\*) of certificate validity (\*) Periodical/special (\*) inspection**

The Inspection Body inspected the vessel on ..... (\*).  
 A certificate dated ..... from the ..... approved classification society  
 .....  
 was presented to the inspection body (\*)  
 Reason for the inspection/certificate (\*)  
 .....  
 In view of the inspection result/certificate (\*), the period of validity of the certificate is maintained/extended (\*)  
 until .....  
 ..... (Place) ..... (date)

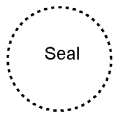

..... (Inspection body)

..... (Signature)

(\*) Delete as appropriate.

**49. Extension/confirmation (\*) of certificate validity (\*) Periodical/special (\*) inspection**

The Inspection Body inspected the vessel on ..... (\*).  
 A certificate dated ..... from the ..... approved classification society  
 .....  
 was presented to the inspection body (\*)  
 Reason for the inspection/certificate (\*)  
 .....  
 In view of the inspection result/certificate (\*), the period of validity of the certificate is maintained/extended (\*)  
 until .....  
 ..... (Place) ..... (date)

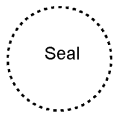

..... (Inspection body)

..... (Signature)

(\*) Delete as appropriate.

**49. Extension/confirmation (\*) of certificate validity (\*) Periodical/special (\*) inspection**

The Inspection Body inspected the vessel on ..... (\*).  
 A certificate dated ..... from the ..... approved classification society  
 .....  
 was presented to the inspection body (\*)  
 Reason for the inspection/certificate (\*)  
 .....  
 In view of the inspection result/certificate (\*), the period of validity of the certificate is maintained/extended (\*)  
 until .....  
 ..... (Place) ..... (date)

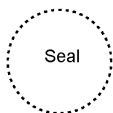

..... (Inspection body)

..... (Signature)

(\*) Delete as appropriate.





**▼ B**

Certificate No ..... of the ..... inspection body

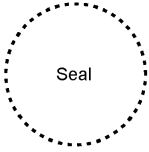
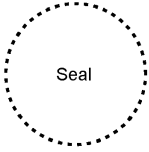
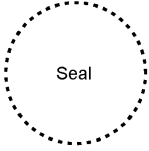
<p><b>51. Extension of the attestation relating to liquefied gas installation(s)</b></p> <p>The period covered by the attestation relating to liquefied gas installation(s)                  dated: ..... is extended until .....</p> <p>— following the periodical inspection by the authorised officer .....</p> <p>— on presentation of the acceptance report dated .....</p> <p>.....                  (Place) , .....                  (date)</p> <div style="display: flex; justify-content: space-around; align-items: center; margin-top: 20px;"> <div style="text-align: center;">  <p>Seal</p> </div> <div style="text-align: center;"> <p>.....                      (Inspection body)</p> <p>.....                      (Signature)</p> </div> </div>	
<p><b>51. Extension of the attestation relating to liquefied gas installation(s)</b></p> <p>The period covered by the attestation relating to liquefied gas installation(s)                  dated: ..... is extended until .....</p> <p>— following the periodical inspection by the authorised officer .....</p> <p>— on presentation of the acceptance report dated .....</p> <p>.....                  (Place) , .....                  (date)</p> <div style="display: flex; justify-content: space-around; align-items: center; margin-top: 20px;"> <div style="text-align: center;">  <p>Seal</p> </div> <div style="text-align: center;"> <p>.....                      (Inspection body)</p> <p>.....                      (Signature)</p> </div> </div>	
<p><b>51. Extension of the attestation relating to liquefied gas installation(s)</b></p> <p>The period covered by the attestation relating to liquefied gas installation(s)                  dated: ..... is extended until .....</p> <p>— following the periodical inspection by the authorised officer .....</p> <p>— on presentation of the acceptance report dated .....</p> <p>.....                  (Place) , .....                  (date)</p> <div style="display: flex; justify-content: space-around; align-items: center; margin-top: 20px;"> <div style="text-align: center;">  <p>Seal</p> </div> <div style="text-align: center;"> <p>.....                      (Inspection body)</p> <p>.....                      (Signature)</p> </div> </div>	



**▼ B**

**Part II**

MODEL SUPPLEMENTARY COMMUNITY INLAND NAVIGATION CERTIFICATE

Annex to inspection certificate for the Rhine No.....	Page 1
<p><b>SUPPLEMENTARY COMMUNITY INLAND NAVIGATION CERTIFICATE</b></p> <p>(Reserved for State emblem)</p> <p><b>NAME OF STATE</b></p> <p>Name and address of the competent authority issuing the supplementary certificate</p>	
<p>1. Name of vessel: .....</p> <p>2. <sup>9)</sup> Unique european vessel identification number: .....</p> <p>3. Place of registration and registration number: .....</p> <p>4. Country of registration and/or home port <sup>(1)</sup> .....</p> <p>5. Having regard to the inspection certificate for the Rhine No..... dated ..... valid until .....</p> <p>6. Having regard to the result of the inspection..... ..... on .....</p> <p>7. the abovementioned vessel is deemed fit to operate on the Community waterways of Zone(s) ..... de la Comunidad Europea .....</p> <p>8. This supplementary certificate expires on .....</p> <p>9. Issued in ....., on .....</p> <p>10.</p>	
 <p>Seal</p>	<p>..... (Competent authority)</p> <p>..... (Signature)</p>
<p><sup>(1)</sup> Delete where inapplicable.</p>	

**▼ B**

Page 2 Annex to inspection certificate for the Rhine No.....

11.		Zone and / or waterways <sup>(1)</sup>				
		4	3	2	1	
Freeboard (cm)	with hold closed					
	with hold open					

12. Derogations from inspection certificate for the Rhine No .....  
 .....  
 .....  
 .....  
 .....  
 .....

13. The entries concerning the number of crew members in the inspection certificate for the Rhine do not apply.

14. Having regard to inspection certificate for the Rhine No .....  
 dated ..... valid until.....

Having regard to the result of the inspection .....  
 .....on .....

This supplementary certificate is extended/renewed <sup>(1)</sup> until .....

.....  
 (Place) (date)

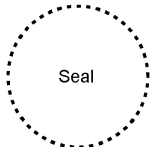

.....  
 (Competent authority)

.....  
 (Signature)

<sup>(1)</sup> Delete where inapplicable.

**▼ B**

**Part III**

MODEL PROVISIONAL COMMUNITY INLAND NAVIGATION CERTIFICATE

Provisional Community certificate (\*)/Provisional certificate of Approval (\*) No .....

1. Name of craft	2. Type of craft	3. <sup>(1)</sup> Unique european vessel identification number ◀										
4. Name and domicile of owner												
5. Length L/L <sub>WL</sub> (*) ..... Number of passengers ..... Number of berths (*) .....												
6. Space for information about the crew .....												
6.1 Operating modes meeting the requirements of national or international law (**)												
6.2 Vessel equipment in accordance with Article 23.09 The vessel (complies *)/(does not comply *)/with Article 23.09(1) *)/(Article 23.09(1)(2) *)												
<table border="1" style="width: 100%; border-collapse: collapse;"> <tr> <td style="width: 50%; padding: 5px;">Space for entering the minimum crew meeting the requirements of national or international law (**)</td> <td style="width: 50%; padding: 5px;">Space for entering the operating modes according to 6.1</td> </tr> <tr> <td style="height: 40px;">.....</td> <td style="text-align: center;"> <table border="1" style="width: 100%; border-collapse: collapse;"> <tr> <td style="width: 33%; height: 20px;">.....</td> <td style="width: 33%; height: 20px;">.....</td> <td style="width: 33%; height: 20px;">.....</td> </tr> <tr> <td style="height: 20px;">.....</td> <td style="height: 20px;">.....</td> <td style="height: 20px;">.....</td> </tr> </table> </td> </tr> </table>		Space for entering the minimum crew meeting the requirements of national or international law (**)	Space for entering the operating modes according to 6.1	.....	<table border="1" style="width: 100%; border-collapse: collapse;"> <tr> <td style="width: 33%; height: 20px;">.....</td> <td style="width: 33%; height: 20px;">.....</td> <td style="width: 33%; height: 20px;">.....</td> </tr> <tr> <td style="height: 20px;">.....</td> <td style="height: 20px;">.....</td> <td style="height: 20px;">.....</td> </tr> </table>	.....	.....	.....	.....	.....	.....	
Space for entering the minimum crew meeting the requirements of national or international law (**)	Space for entering the operating modes according to 6.1											
.....	<table border="1" style="width: 100%; border-collapse: collapse;"> <tr> <td style="width: 33%; height: 20px;">.....</td> <td style="width: 33%; height: 20px;">.....</td> <td style="width: 33%; height: 20px;">.....</td> </tr> <tr> <td style="height: 20px;">.....</td> <td style="height: 20px;">.....</td> <td style="height: 20px;">.....</td> </tr> </table>	.....	.....	.....	.....	.....	.....					
.....	.....	.....										
.....	.....	.....										
6.3. Space for entering the minimum crew for vessels that are not covered by general minimum crew prescriptions in national international requirements (**)												
7. Liquefied gas installation(s) Attestation valid until .....												
8. Special conditions												
9. Carriage of dangerous goods, see separate box (*)												
10. Validity Provisional certificate (*)/provisional certificate of approval (*) valid until ..... (Date) for navigation *)/for a single voyage (*)												
<p><b>The abovementioned craft is acknowledged as fit to operate</b></p> <p>— on Community waterways in Zone(s) (*) .....</p> <p style="padding-left: 20px;">on the waterways in Zone(s) (*) .....</p> <p style="padding-left: 20px;">in (Names of States (*)</p> <p style="padding-left: 20px;">except for .....</p> <p>.....</p> <p>— on the following waterways in (Name of State (*)). .....</p> <p>.....</p>												

► <sup>(1)</sup> M3

**▼ B**

11. .... (Place) , ..... (Date) ..... (Place) , ..... (Date) .....

..... (Competent authority for provisional certificate of approval) ..... (Inspection body) .....

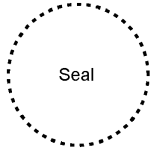

..... Signature .....

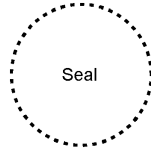

..... Signature .....

.....  
 (\*) Delete as appropriate.

(\*\*) Requirements of national or international law which a Member State may choose to apply, or have no requirements

**9. Carriage of dangerous goods**

(Indicate whether the vessel meets the requirements of national and international law, if any)

**▼B**

*ANNEX VI*

**MODEL REGISTER OF COMMUNITY INLAND NAVIGATION CERTIFICATES**

Competent authority/Inspection body .....

Register of Community inland navigation certificates

Year .....

(Left-hand page)

Community inland navigation certificate	Name of vessel		Unique european vessel identification number	Owner		Vessel register		Type of vessel	
	No	Day		Month	Name	Address	Place		No



(Right-hand page)

Deadweight according to tonnage certificate or displacement (*)		Zones or stretch of inland waterway, where appropriate		Endorsements concerning supplementary or special inspections, withdrawal and annulment of the certificate	Community inland navigation certificate valid until	Other comments
Date of tonnage certificate	Tonnage mark	t/m <sup>3</sup>	from			

(\*) If no tonnage certificate is available, estimate the deadweight or displacement..



*ANNEX VII*

**CLASSIFICATION SOCIETIES**

CONTENTS

Part I:	Criteria for the approval of classification societies
Part II:	Procedure for the approval of classification societies
Part III:	List of approved classification societies

*Part I*

**Criteria for the approval of classification societies**

Classification societies seeking approval pursuant to Article 10 of this Directive shall meet all the following criteria:

1. the classification society shall be able to document extensive experience in assessing the design and construction of inland waterway vessels, including vessels for the carriage of dangerous goods. The classification society shall have comprehensive rules and regulations for the design, construction and periodic inspection of inland waterway vessels, including vessels for the carriage of dangerous goods, which shall be published at least in Dutch, English, French or German and shall be continuously updated and improved through research and development programmes. The rules and regulations must not conflict with the provisions of Community law or with international agreements in force;
2. the classification society shall publish its register of vessels annually;
3. the classification society shall not be controlled by shipowners or shipbuilders or by others engaged commercially in the design, manufacture, fitting-out, repair, operation or insurance of ships. The classification society shall not be dependent on a single commercial enterprise for its revenue;
4. the headquarters of the classification society or a branch authorised to give a ruling and to act in all areas incumbent on it under the regulations governing inland waterway transport shall be located in one of the Member States;
5. the classification society and its experts shall have a good reputation in inland waterway transport; the experts shall be able to provide proof of their professional abilities. They shall act on the responsibility of the classification society;
6. the classification society shall have a significant technical, managerial, support, inspection and research staff, in proportion to the tasks and the vessels classified and catering also for developing capability and updating the regulations. It shall have inspectors in at least one Member State;
7. the classification society shall be governed by a code of ethics;
8. the classification society shall be managed and administered in such a way as to ensure the confidentiality of information required by a Member State;
9. the classification society shall be prepared to provide relevant information to a Member State;
10. the classification society's management shall have defined and documented its policy and objectives for, and commitment to, quality and ensured that this policy is understood, implemented and maintained at all levels in the classification society;
11. the classification society shall have prepared and implemented and shall maintain an effective internal quality system based on the relevant parts of internationally recognised quality standards and complying with the EN 45004 (inspection bodies) and EN 29001 standards, as interpreted by the IACS Quality System Certification Scheme Requirements. The quality system must be certified by an independent body of auditors recognised

**▼B**

- by the administration of the State in which the classification society has its headquarters or branch, as provided for in subparagraph 4, and which, *inter alia*, ensures that:
- (a) the classification society's rules and regulations are established and maintained in a systematic manner;
  - (b) the classification society's rules and regulations are complied with;
  - (c) the requirements of the statutory work for which the classification society is authorised are satisfied;
  - (d) the responsibilities, powers and interrelation of personnel whose work affects the quality of the classification society's services are defined and documented;
  - (e) all work is carried out under controlled conditions;
  - (f) a supervisory system is in place which monitors the actions and work carried out by surveyors and technical and administrative staff employed directly by the classification society;
  - (g) the requirements of major statutory work for which the classification society is authorised are only carried out or directly supervised by its exclusive surveyors or by exclusive surveyors of other approved classification societies;
  - (h) a system for qualification of surveyors and continuous updating of their knowledge is implemented;
  - (i) records are maintained, demonstrating achievement of the required standards in the items covered by the services performed, as well as the effective operation of the quality system; and
  - (j) a comprehensive system of planned and documented internal audits of quality-related activities exists in all locations.
12. the quality system must be certified by an independent body of auditors recognised by the administration of the State in which the classification society has its headquarters or branch, as provided for in paragraph 4;
  13. the classification society shall undertake to bring its requirements into line with the appropriate European Union directives and to provide the Committee with all relevant information in good time;
  14. the classification society shall undertake periodically to consult with the classification societies already approved in order to guarantee the equivalence of their technical standards and of implementation thereof, and should allow participation in the development of its rules and regulations by representatives of a Member State and other parties concerned.

*Part II***Procedure for the approval of classification societies**

A decision to approve a classification society pursuant to Article 10 of this Directive is to be taken by the Commission according to the procedure referred to in Article 19(2) of this Directive. In addition, the following procedure must be observed:

1. an application for approval shall be submitted to the Commission by the representatives of the State in which the classification society has its headquarters or a branch authorised to give a ruling and act in all areas incumbent on it under the regulations governing inland waterway vessels. Furthermore, the representatives of this State shall send all information and documentation needed to check that the criteria for approval are met;
2. any Committee member can demand a hearing with the classification society concerned or that further information or documentation be provided;
3. approval shall be withdrawn in a similar way. Any Committee member can ask for approval to be withdrawn. The representatives of the State asking for the withdrawal shall submit the information and documentation supporting their application;
4. when making its decisions, the Commission shall take account of decisions made by the Central Commission for Navigation on the Rhine regarding approval of the classification society concerned. Before approving a classifi-

**▼B**

cation society which has not been approved by the Central Commission for Navigation on the Rhine, the Commission shall consult the Secretariat of the Central Commission;

5. following each decision on approval of a classification society or the withdrawal of approval, the list of approved societies shall be amended;
6. the Commission shall inform the classification societies concerned of the Commission's decisions.

*Part III***List of approved classification societies**

On the basis of the criteria set out in Parts I and II, the following classification societies are currently approved in accordance with Article 10 of this Directive:

1. Bureau Veritas,
2. Germanischer Lloyd,
3. Lloyd's Register of Shipping.

Until their approval under Parts I and II, classification societies which are recognised and approved and authorised by a Member State in accordance with Council Directive 94/57/EC of 22 November 1994 on common rules and standards for ship inspection and survey organisations and for the relevant activities of maritime administrations <sup>(1)</sup> are currently approved in accordance with Article 10 of this Directive only in respect of vessels which operate exclusively on waterways of that Member State.

<sup>(1)</sup> OJ L 319, 12.12.1994, p. 20. Directive as last amended by Directive 2002/84/EC of the European Parliament and of the Council (OJ L 324, 29.11.2002, p. 53).

*ANNEX VIII***RULES OF PROCEDURE FOR THE CARRYING OUT OF INSPECTIONS***Article 1*

If the authorities find upon inspection that the certificate carried on the vessel is invalid, or that the vessel does not satisfy the requirements set out in the certificate, but that such invalidity or failure to satisfy the requirements does not constitute a manifest danger, the owner of the vessel or his representative shall take all necessary measures to remedy the situation. The authority which issued the certificate or which last renewed it shall be informed within seven days.

*Article 2*

If, upon making the inspection referred to in Article 1, the authorities find that the certificate is not being carried or that the vessel constitutes a manifest danger, they may prevent the vessel from proceeding until the necessary steps have been taken to remedy the situation.

They may also prescribe measures which will enable the vessel to proceed safely, where appropriate on termination of its transport operations, to a place where it will be either inspected or repaired. The authority which issued or last renewed the certificate shall be informed within seven days.

*Article 3*

A Member State which has prevented a vessel from proceeding, or has notified the owner of its intention to do so if the defects found are not corrected, shall inform the authority in the Member State which issued or last renewed the certificate, within seven days, of the decision which it has taken or intends to take.

*Article 4*

Any decision to interrupt the passage of a vessel taken pursuant to measures adopted in implementation of this Directive shall state in detail the reasons on which it is based. It shall be notified without delay to the party concerned, who shall at the same time be informed of the appeal procedures available to him under the laws in force in the Member States and of their time limits.



*ANNEX IX*

**REQUIREMENTS APPLICABLE TO SIGNAL LIGHTS, RADAR INSTALLATIONS AND RATE-OF-TURN INDICATORS**

CONTENTS

Part I:	Requirements concerning the colour and intensity of lights and the approval of signal lanterns for inland waterway vessels
Part II:	Requirements concerning the conditions for testing and approval of signal lanterns for inland waterway vessels
Part III:	Minimum requirements and test conditions for radar installations used for navigation in inland waterway vessels
Part IV:	Minimum requirements and test conditions for rate-of-turn indicators used in inland waterway vessels
Part V:	Requirements for installation and performance tests for radar equipment and rate-of-turn indicators used in inland waterway vessels
Part VI:	Model list of test institutes, approved equipment and approved installation firms

PART I

**REQUIREMENTS CONCERNING THE COLOUR AND INTENSITY OF LIGHTS AND THE APPROVAL OF SIGNAL LANTERNS FOR INLAND WATERWAY VESSELS**

CONTENTS

Chapter 1	Definitions
Article 1.01.	Signal lanterns
1.02.	Signal lights
1.03.	Light sources
1.04.	Optic
1.05.	Filter
1.06.	Relation between $I_O$ , $I_B$ and $t$
Chapter 2	Requirements for signal lights
Article 2.01.	Colour of signal lights
2.02.	Luminous intensity and range of signal lights
2.03.	Signal light dispersion
Chapter 3	Requirements for signal lanterns
Article 3.01.	Technical requirements
Chapter 4	Tests, approval and markings
Article 4.01.	Type tests
4.02.	Test procedure
4.03.	Approval certificate
4.04.	Spot checks
4.05.	Markings

*Appendix*

Model approval certificate for signal lanterns for inland waterway vessels



## CHAPTER 1

### DEFINITIONS

#### *Article 1.01*

##### **Signal lanterns**

1. 'Lantern' means a device for distributing the flux from an artificial light source; it also includes the components needed to filter, refract or reflect the light, and to hold or operate the light source.
2. Lanterns intended to give signals on board a vessel are called signal lanterns.

#### *Article 1.02*

##### **Signal lights**

1. 'Signal lights' means the light signals emitted by signal lanterns.
2. 'Masthead light' means a white light, visible throughout a horizontal arc of 225° and projecting a uniform uninterrupted beam over 112° 30' on each side, i.e. from the bow to 22° 30' abaft the beam on each side.
3. 'Side lights' means a green light to starboard and a red light to port; each of these lights shall be visible throughout a horizontal arc of 112° 30' and project a uniform uninterrupted beam, i.e. from the bow to 22° 30' abaft the beam.
4. 'Stern light' means a white light, visible throughout a horizontal arc of 135° and projecting a uniform uninterrupted beam over a sector of 67° 30' along each side from the stern.
5. 'Yellow stern light' means a yellow light, visible throughout a horizontal arc of 135° and projecting a uniform uninterrupted beam over a sector of 67° 30' along each side from the stern.
6. 'Light visible from all directions' means a light visible throughout a horizontal arc of 360° and projecting a uniform uninterrupted beam.
7. (a) 'Scintillating light' means a light flashing at a rate of 40 to 60 light periods per minute.  
(b) 'Rapidly scintillating light' means a light flashing at a rate of 100 to 120 light periods per minute.

A scintillating light is a series of regular light periods per unit time.

8. Signal lights are classified according to their luminous intensity as:
  - ordinary lights,
  - bright lights,
  - strong lights.

#### *Article 1.03*

##### **Light sources**

'Light sources' means electrical or non-electrical devices designed to produce light fluxes in signal lanterns.

#### *Article 1.04*

##### **Optic**

1. 'Optic' means a device comprising refracting, reflecting, or refracting and reflecting components, including their holders. The function of these components is to direct the rays from a light source in new specific directions.
2. 'Coloured optic' means an optic which modifies the colour and intensity of the light transmitted.
3. 'Neutral optic' means an optic which modifies the intensity of the light transmitted.

**▼B***Article 1.05***Filter**

1. 'Coloured filter' means a selective filter which modifies the colour and intensity of the light transmitted.
2. 'Neutral filter' means a non-selective component which modifies the intensity of the light transmitted.

*Article 1.06***Relation between  $I_O$ ,  $I_B$  and t**

$I_O$  means the photometric luminous intensity in candelas (cd) measured at normal voltage for electric lights.

$I_B$  means the operational luminous intensity in candelas (cd).

t means the range in kilometres (km).

Taking into account, for example, the ageing of the light source, the degree of dirtiness of the optic and variations in the voltage of the on-board grid,  $I_B$  is taken as 25 % less than  $I_O$ .

Consequently:

$$I_B = 0,75 \cdot I_O$$

The relation between  $I_B$  and t of signal lights is given by the following equation:

$$I_B = 0,2 \cdot t^2 \cdot q^{-t}$$

The atmospheric transmission coefficient q is taken as 0,76, corresponding to a meteorological visibility of 14,3 km.

## CHAPTER 2

**REQUIREMENTS FOR SIGNAL LIGHTS***Article 2.01***Colour of signal lights**

1. A five-colour signal system shall apply to the lights, comprising the following colours:
  - white,
  - red,
  - green,
  - yellow,
  - blue.

This system shall conform to the recommendations of the International Commission on Illumination, 'Colours of Signal Lights', IEC publication No 2.2. (TC-1.6) 1975.

The colours shall apply to the light fluxes emitted by the signal lantern.

2. The colour boundaries of signal lights shall be demarcated by the coordinates of the intersecting points of the chromatic diagram in IEC publication No 2.2 (TC-1.6) 1975 (see chromaticity diagram) as follows:

Colour of signal light	Coordinates of the intersecting points						
	x	0,310	0,443	0,500	0,500	0,453	0,310
White	y	0,283	0,382	0,382	0,440	0,440	0,348
	x	0,690	0,710	0,680	0,660		
Red	y	0,290	0,290	0,320	0,320		



**▼B**

Colour of signal light	Coordinates of the intersecting points					
	x	0,009	0,284	0,207	0,013	
Green	y	0,720	0,520	0,397	0,494	
	x	0,612	0,618	0,575	0,575	
Yellow	y	0,382	0,382	0,425	0,406	
	x	0,136	0,218	0,185	0,102	
Blue	y	0,040	0,142	0,175	0,105	

IEC chromaticity diagram

where 2 930 K corresponds to the light of a vacuum filament lamp

2 856 K corresponds to the light of a gas-filled filament lamp

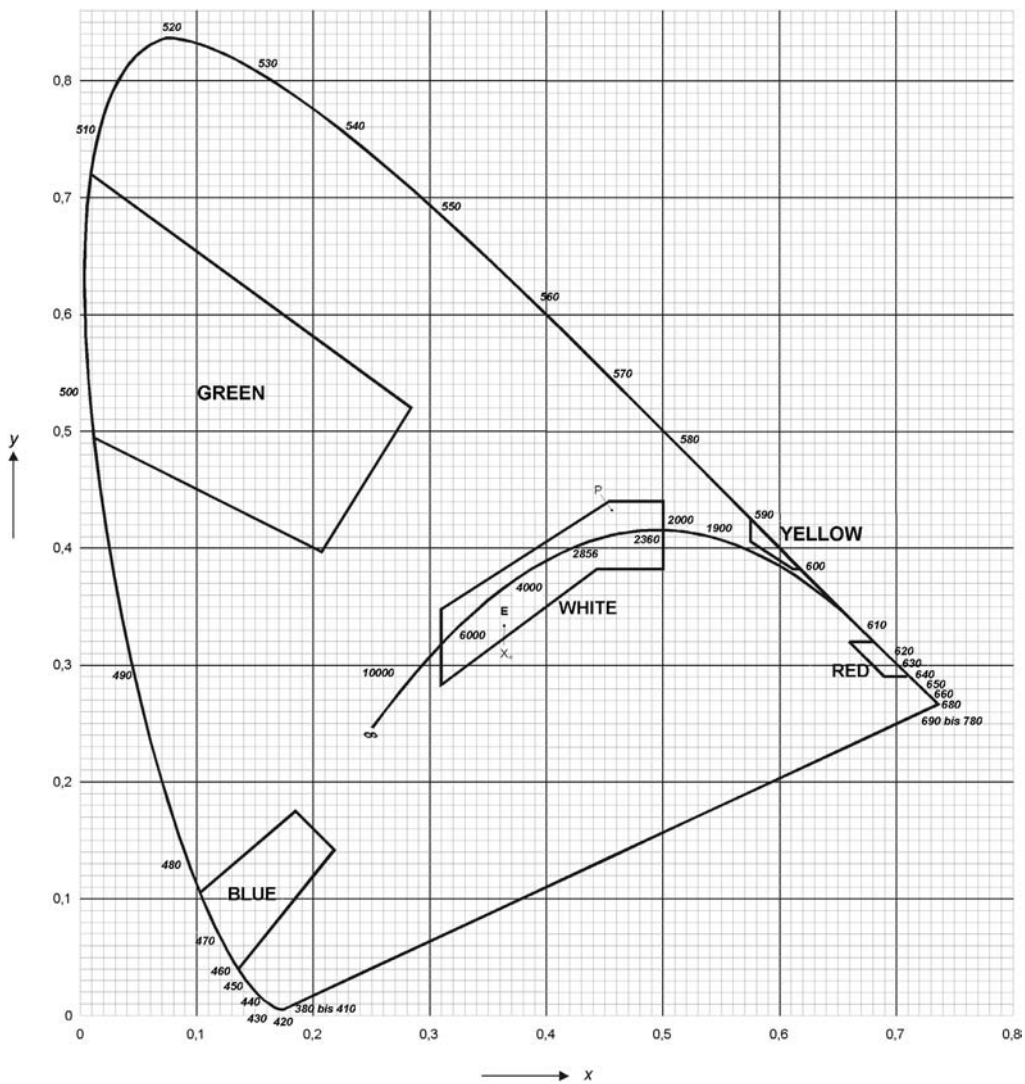

Article 2.02

**Intensity and range of the signal lights**

The table set out below contains the permitted limits for I<sub>O</sub>, I<sub>B</sub> and t (daytime and nighttime use) according to the nature of the signal lights. The values indicated shall apply to the light flux emitted by the signal lanterns.

**▼B**

$I_O$  and  $I_B$  are given in cd and  $t$  in km.

*Maximum and minimum values*

Nature of the signal lights		Colour of signal light							
		White		Green/red		Yellow		Blue	
		min.	max.	min.	max.	min.	max.	min.	max.
ordinary	$I_O$	2.7	10.0	1.2	4.7	1.1	3.2	0.9	2.7
	$I_B$	2.0	7.5	0.9	3.5	0.8	2.4	0.7	2.0
	$t$	2.3	3.7	1.7	2.8	1.6	2.5	1.5	2.3
bright	$I_O$	12.0	33.0	6.7	27.0	4.8	20.0	6.7	27.0
	$I_B$	9.0	25.0	5.0	20.0	3.6	15.0	5.0	20.0
	$t$	3.9	5.3	3.2	5.0	2.9	4.6	3.2	5.0
strong	$I_O$	47.0	133.0	-	-	47.0	133.0	-	-
	$I_B$	35.0	100.0	-	-	35.0	100.0	-	-
	$t$	5.9	8.0	-	-	5.9	8.0	-	-

However, for daytime use of the yellow scintillating lights a minimum luminous intensity ( $I_O$ ) of 900 cd shall apply.

*Article 2.03***Signal light dispersion**

1. Horizontal dispersion of the luminous intensity
  - 1.1. The luminous intensities indicated in Article 2.02 shall apply to all directions of the horizontal plane passing through the focus of the optic or the luminous centre of gravity of the correctly adjusted light source of a vertically positioned signal lantern.
  - 1.2. For the masthead lights, stern lights and side lights, the luminous intensities prescribed shall be maintained throughout the horizontal arc within the sector prescribed at least up to within  $5^\circ$  of the limits.
 

As from  $5^\circ$  within the sector prescribed up to the limit, the luminous intensity may decrease by 50 %; it shall subsequently decrease gradually in such a way that, as from  $5^\circ$  beyond the limits of the sector, only a negligible amount of light remains.
  - 1.3. The side lights shall have the prescribed luminous intensity in the direction parallel to the axis of the vessel forward. The intensities shall decrease practically to zero between  $1^\circ$  and  $3^\circ$  beyond the limits of the prescribed sector.
  - 1.4. For bi-coloured or tri-coloured lanterns, the dispersion of the luminous intensity shall be uniform so that  $3^\circ$  on either side of the prescribed sector limits, the maximum permitted intensity is not exceeded and the minimum prescribed intensity is reached.
  - 1.5. The horizontal dispersion of the luminous intensity of the lanterns shall be uniform throughout the sector, so that the minimum and maximum values observed for the photometric luminous intensity do not differ by more than a factor of 1,5.
2. Vertical dispersion of the luminous intensity
 

In the event of heeling of up to  $\pm 5^\circ$  or  $\pm 7,5^\circ$  from the horizontal, the luminous intensity shall remain at least equal to 80 % in the first case, and 60 % in the second case, of the luminous intensity corresponding to  $0^\circ$  heeling, although it shall not exceed it by more than 1,2 times.



## CHAPTER 3

## REQUIREMENTS FOR SIGNAL LANTERNS

*Article 3.01***Technical requirements**

1. The construction of and materials of signal lanterns and light sources shall be such as to ensure their safety and durability.
2. The components of the lanterns (for example, the cross braces) shall not impair the intensity, colours or dispersion of the light.
3. It shall be possible to install the signal lanterns on board simply and in the correct position.
4. It shall be easy to replace the light source.

## CHAPTER 4

## TESTS, APPROVAL AND MARKINGS

*Article 4.01***Type tests**

The type test according to the 'Conditions for testing and approval of signal lanterns in inland waterway vessels' is intended to ascertain whether the signal lanterns and their light source meet these requirements.

*Article 4.02***Test procedure**

1. An application for a type test shall be submitted to the competent testing authority, with at least two copies of the plans and two specimens of the lantern as well as the light sources required.
2. If the test does not give rise to objections, one copy of the plans accompanying the application, with the approval entered on it, and one of the approved specimen lanterns shall be returned to the applicant. The second copy and second specimen lantern shall be kept by the testing authority.
3. The manufacturer shall declare to the testing authority that all the components of the series-produced lantern conform to those of the type-tested lantern.

*Article 4.03***Approval certificate**

1. If the type test shows that these requirements have been met, the signal lantern type shall be approved and an approval certificate based on the model in the Appendix and bearing the markings referred to in Article 4.05 shall be issued to the applicant.
2. The holder of the approval certificate:
  - shall be authorised to affix the markings referred to in Article 4.05 to the various parts;
  - may undertake manufacture only in conformity with the plans approved by the testing authority and according to the technique used for the type-tested lanterns;
  - may modify the approved plans and lantern models only with the approval of the testing authority. The latter shall also decide whether the approval certificate issued only requires additions to be made to it or whether a new application for approval is needed.

**▼B***Article 4.04***Spot checks**

1. The testing authority shall be empowered to take samples of signal lanterns from the production series for testing.
2. If the test reveals serious shortcomings, the approval may be withdrawn.

*Article 4.05***Markings**

1. Approved signal lanterns, optics and light sources shall be marked as indicated below:

 e. X. YY. nnn

where ' e' is the approval mark,

'X' indicates the country of approval, where:

- 1 = Germany
- 2 = France
- 3 = Italy
- 4 = Netherlands
- 5 = Sweden
- 6 = Belgium
- 7 = Hungary
- 8 = Czech Republic
- 9 = Spain
- 11 = United Kingdom
- 12 = Austria
- 13 = Luxembourg
- 17 = Finland
- 18 = Denmark

**▼M2**

- 19 = Romania

**▼B**

- 20 = Poland
- 21 = Portugal
- 23 = Greece
- 24 = Ireland
- 26 = Slovenia
- 27 = Slovakia
- 29 = Estonia
- 32 = Latvia

**▼M2**

- 34 = Bulgaria

**▼B**

- 36 = Lithuania
- 49 = Cyprus
- 50 = Malta

'YY' are the last two figures of the year of approval, and  
'nnn' is the approval number assigned by the testing authority.

**▼B**

2. The markings shall be clearly legible and shall be indelibly affixed.
3. Markings on the housing shall be such that the signal lantern does not need to be dismantled in order to find them on board. If the optic and housing are inseparable, a marking on the housing shall suffice.
4. Only approved signal lanterns, optics and light sources may bear the markings indicated in paragraph 1 above.
5. The testing authority shall immediately inform the Committee of the marking assigned.





PART II

**REQUIREMENTS CONCERNING THE CONDITIONS FOR TESTING  
AND APPROVAL OF SIGNAL LANTERNS FOR INLAND  
WATERWAY VESSELS**

CONTENTS

Chapter 1	General provisions
Article 1.01	Standard voltages
1.02	Operating requirements
1.03	Mounting
1.04	Photometric requirements
1.05	Components
1.06	Maintenance
1.07	Safety requirements
1.08	Accessories
1.09	Non-electric signal lanterns
1.10	Double lanterns
Chapter 2	Photometric and colorimetric requirements
Article 2.01	Photometric requirements
2.02	Colorimetric requirements
Chapter 3	Manufacturing requirements
Article 3.01	Electric lanterns
3.02	Filters and optical glasses
3.03	Electric light sources
Chapter 4	Test and approval procedure
Article 4.01	General rules of procedure
4.02	Application
4.03	Test
4.04	Approval
4.05	Cessation of validity of the approval
Appendix	Environment tests
1.	Test concerning protection against splashing water and dust
2.	Humid atmosphere test
3.	Cold test
4.	Heat test
5.	Vibration test
6.	Accelerated weather resistance test
7.	Salt water and weather-resistance test (sea-fog test)

CHAPTER 1

**GENERAL PROVISIONS**

*Article 1.01*

**Standard voltages**

The standard voltages for signal lanterns for inland waterway vessels shall be 230 V, 115 V, 110 V, 24 V and 12 V. Wherever possible, 24 V appliances should be used.

**▼B***Article 1.02***Operating requirements**

The normal operation of signal lanterns and their accessories shall not be hindered by routine on-board operations. In particular, all the optical components used and major parts for mounting and adjusting them shall be so manufactured that their position, once established, cannot be modified during operation.

*Article 1.03***Mounting**

The parts for mounting signal lanterns on board shall be so made that, once they have been adjusted, the position of the lanterns, when fixed, cannot be modified during operation.

*Article 1.04***Photometric requirements**

Signal lanterns shall produce the prescribed dispersion of luminous intensity; the identifying colour of the light and the prescribed intensity shall be obtained as soon as the light is turned on.

*Article 1.05***Components**

Only components manufactured for the purpose shall be used in signal lanterns.

*Article 1.06***Maintenance**

The method of construction of signal lanterns and their accessories shall permit their regular maintenance and, if necessary, enable light sources to be changed easily, even in darkness.

*Article 1.07***Safety requirements**

Signal lanterns and their accessories shall be so manufactured and proportioned that they can be operated, controlled and monitored without danger to persons.

*Article 1.08***Accessories**

Lantern accessories shall be so designed and manufactured that their arrangement, mounting and connection shall not hinder the normal use and proper functioning of the lanterns.

*Article 1.09***Non-electric signal lanterns**

Non-electric lanterns shall be designed and manufactured in conformity with Articles 1.02 to 1.08 of this Chapter and so as to meet the requirements of Chapter 3. The requirements contained in Chapter 2 of these testing and approval conditions shall apply *mutatis mutandis*.

*Article 1.10***Double lanterns**

It shall be possible to use two lanterns mounted one above the other in one housing (double lantern) as a single lantern. Under no circumstances shall the two light sources of a double lantern be used simultaneously.





## CHAPTER 2

## PHOTOMETRIC AND COLORIMETRIC REQUIREMENTS

*Article 2.01***Photometric requirements**

1. The photometric specifications for signal lanterns are set out in Part I.
2. The construction of signal lanterns shall guarantee that the light cannot be reflected or interrupted. The use of reflectors shall not be permitted.
3. In the case of two-colour or three-colour lights, the projection of light of a colour beyond the sector limits prescribed for that colour shall be effectively prevented, including inside the glass.
4. These requirements shall apply mutatis mutandis to non-electric lights.

*Article 2.02***Colorimetric requirements**

1. The colorimetric specifications for signal lanterns are set out in Part I.
2. The colour of the light emitted by signal lanterns shall be situated, for the temperature of the colour used by the light source, in the appropriate chromatic position established in Part I.
3. The colour of signal lights shall come only from filters (optics, glasses) and optical glasses coloured throughout if the chromatic points of the transmitted light do not diverge by more than 0,01 from their coordinates in the IEC chromaticity diagram. Coloured bulbs shall not be permitted.
4. The transparency of coloured glasses (filters) shall be such that, at the temperature of the light source colour used, the luminous intensity prescribed shall be reached.
5. The reflection of the source light on the parts of the signal lantern shall not be selective, i.e. the trichromatic coordinates x and y of the source used in the signal lantern shall, at the temperature of the colour used, not deviate by more than 0,01 following reflection.
6. Colourless glass shall not, at the temperature of the colour used, selectively influence the light emitted. Similarly, following an extensive operating period, the trichromatic coordinates x and y of the light source used in the signal lantern shall not deviate by more than 0,01, once the light has passed through the glass.
7. The colour of the light of non-electric signal lanterns, at the temperature of the light source used, shall be located in the appropriate chromatic position established in Part I.
8. The colour of the light from non-electric coloured signal lanterns shall come only from silicate glass, coloured throughout. For coloured non-electric lanterns, all the coloured silicate glass shall be such that at the colour temperature nearest the non-electric light source the prescribed luminous intensity shall be reached.

## CHAPTER 3

## MANUFACTURING REQUIREMENTS

*Article 3.01***Electric signal lanterns**

1. All the parts of the lanterns shall withstand the particular operational stresses resulting from movement of the vessel, vibrations, corrosion, temperature variations, impacts during loading and navigation in ice and other influences which may be exerted on board.
2. The construction, the materials and the workmanship of the lantern shall guarantee stability and ensure that, after mechanical and thermal stresses and exposure to ultraviolet rays in accordance with these requirements, its

**▼B**

performance is unchanged; in particular, the photometric and colorimetric properties shall be preserved.

3. The components exposed to corrosion shall be made of corrosion-resistant materials or be provided with effective protection against corrosion.
4. The materials used shall not be hygroscopic where this would be detrimental to the operation of the installations, appliances and accessories.
5. The materials used shall be highly fire-resistant.
6. The testing authority may grant exemptions concerning the properties of the materials used provided that safety is guaranteed by the manufacture.
7. Signal lanterns shall be tested to ensure their suitability for use on board. The tests shall be divided between environmental and operating requirements.
8. Environmental requirements:

(a) Type of environment

— *Type of climate:*

- X Appliances intended for use in places exposed to weather conditions.
- S Appliances intended for submersion or for prolonged contact with salt water.

— *Types of vibration:*

- V Appliances and devices intended for installation on masts and at other points particularly exposed to vibrations.

— *Types of ambient conditions:*

Ambient conditions are divided into three types:

1. Normal ambient conditions:

These may regularly occur on board during a long period.

2. Extreme ambient conditions:

These may exceptionally occur on board in special cases.

3. Transport ambient conditions:

These may occur during transport and immobilisation other than during the operation of the installations, appliances and accessories.

Tests under normal ambient conditions are described as 'normal ambient tests', tests under extreme ambient conditions as 'extreme ambient tests' and tests under transport ambient conditions as 'transport ambient tests'.

(b) Requirements

Signal lanterns and their accessories shall be suited to lengthy operation under the influence of the motion of the sea, and of the vibrations, humidity and temperature variations which must be expected on board ship.

Signal lanterns and their accessories shall, on exposure to the ambient conditions listed in the Appendix, meet the requirements of their class of environment, as defined in paragraph 8(a).

9. Suitability for operation

- (a) Power supply: during fluctuations in the voltages and frequencies of the supply current from their rated values <sup>(1)</sup> within the limits specified in the table set out below and oscillations of 5 % in the alternating supply voltage, signal lanterns and their accessories shall operate within the permitted tolerances for on-board operation applicable to them on the basis of the test and approval conditions. Theoretically, the supply voltage for the lanterns shall not deviate by more than  $\pm 5$  % from the rated voltage selected.

<sup>(1)</sup> The rated voltage and frequency are those indicated by the manufacturer. Ranges of voltage and/or frequency may also be indicated.

**▼B**

Supply (Rated voltage)	Fluctuations in voltage and frequency of the supply current of lanterns and their accessories		
	Fluctuations in voltage	Fluctuations in frequency	Duration
Direct current of more than 48 V	± 10 %	± 5 %	continuous
and alternating current	± 20 %	± 10 %	max. 3 s
Direct current up to and including 48 V	± 10 %	-	continuous

Voltage peaks of up to ± 1 200 V with a rise time of between 2 and 10 µs and a maximum duration of 20 µs and the reversal of the supply voltage shall not cause damage to the signal lanterns and their accessories. After their occurrence, when safety devices may have cut in, the signal lanterns and their accessories shall operate within the permitted tolerances for on-board operation on the basis of the test and approval conditions.

- (b) Electromagnetic compatibility: all reasonable and practical measures shall be taken to eliminate or reduce the reciprocal electromagnetic effects of lanterns and their accessories and of other installations and appliances forming part of the vessels' equipment.

## 10. Ambient conditions on board vessels

The normal, extreme and transport ambient conditions referred to in paragraph 8(a) are based on the proposed additions to IEC publications 92-101 and 92-504. Other values deviating from them are marked with \*.

	Normal	Extreme	Transport
	Ambient conditions		
(a) Ambient air temperature:			
Classes of climate:	- 25 to	- 25 to	- 25 to
Climate classes X and S according to paragraph 8(a)	+ 55 °C*	+ 55 °C*	+ 70 °C*
(b) Ambient air humidity:			
Constant temperature	+ 20 °C	+ 35 °C	+ 45 °C
Maximum relative humidity	95 %	75 %	65 %
Change of temperature	Possibly reaching dewpoint		
(c) Weather conditions on deck:			
Sunlight	1 120 W/m <sup>2</sup>		
Wind	50 m/s		
Rainfall	15 mm/min		
Speed of the water during movement (waves)	10 m/s		
Water salinity	30 kg/m <sup>3</sup>		
(d) Magnetic field:			
Magnetic field from any direction	80 A/m		
(e) Vibration:			
Sinusoidal vibration from any direction			
Class of vibration V according to paragraph 8(a) (severe stress, e.g. on masts)			
Frequencies	2 to 10 Hz	2 to 13,2 Hz*	

**▼B**

Range	± 1,6 mm	± 1,6 mm
Frequencies	10 to 100 Hz	13,2 to 100 Hz*
Range of acceleration	± 7 m/s <sup>2</sup>	± 11 m/s <sup>2</sup> *

11. Signal lanterns must pass the environment tests set out in the Appendix.
12. Lantern components made of organic materials shall not be sensitive to ultraviolet radiation.  
  
After testing for 720 hours in conformity with paragraph 6 of the Appendix, there shall be no deterioration in quality and the trichromatic coordinates x and y shall not deviate by more than 0,01 from those for transparent parts which have been exposed neither to radiation nor to water.
13. The transparent parts and screens of the lanterns shall be so designed and manufactured that, given normal on-board requirements, extended operation with an excess voltage of 10 % and an ambient temperature of + 45 °C, they are not deformed, altered or destroyed.
14. With extended operation and an excess voltage of 10 % and an ambient temperature of + 60 °C, lanterns shall remain intact on their holders when subjected to a force of 1 000 N (Newton) for eight hours.
15. Lanterns shall be resistant to temporary submersion. During extended operation with an excess voltage of 10 % and an ambient temperature of + 45 °C, they shall not be affected by drenching with the contents of a receptacle containing 10 litres of water at a temperature of + 15 to + 20 °C.
16. The durability of the materials used shall be ensured under operating conditions; in particular, the materials shall be capable of withstanding, during operation, their highest continuous use temperatures.
17. If the lanterns include non-metallic components, their continuous use temperature under on-board conditions at an ambient temperature of + 45 °C shall be determined.

If the continuous use temperature of the non-metallic materials as so determined exceeds the maximum temperatures indicated in Tables X and XI in IEC publication 598, part 1, special examinations shall be carried out to determine the resistance to continuous mechanical, thermal and climatic stresses on these parts of the lanterns.

18. For the non-deformability tests of parts at continuous use temperature, the lantern shall be placed in operating position in a slight constant air flow ( $v =$  approximately 0,5 m/s) in an ambient temperature of + 45 °C and under on-board conditions. While they are being brought to temperature, and once the operating temperature is reached, the non-metallic parts shall be subjected to a mechanical stress in keeping with their purpose or with possible manipulation thereof. The transparent parts of the lanterns of materials other than silicate glass shall be subjected to the action of a 5 mm × 6 mm metallic punch exerting a continuous force of 6,5 N (equivalent to finger pressure) half way between the upper and lower sides of the transparent part.

The part shall not suffer any permanent deformation as a result of such mechanical stresses.

19. For the test of the resistance of the components to atmospheric agents, lanterns with non-metallic components exposed to the elements shall be placed in a climatic chamber, for 12 consecutive hours alternately in an atmosphere of 45 °C and 95 % relative humidity and an atmosphere of — 20 °C, and operated intermittently under on-board conditions, so that they are exposed to hot-humid and cold cycles and to changes from low to high temperatures for periods corresponding to their operating times.

The total duration of this test shall be at least 720 hours. The test shall not affect the operational capacity of the non-metallic parts of the lantern.

20. The parts of lanterns within easy reach shall not, in an ambient temperature of + 45 °C, reach temperatures higher than + 70 °C when they are made of metal or + 85 °C if they are not made of metal.

**▼B**

21. Lanterns shall be designed and manufactured according to accepted standards and comply, in particular, with IEC publication 598, part 1, 'Ships, lights — General specifications and tests'. The requirements of the following paragraphs shall be met:
  - protection of connections (7.2),
  - protection against electric shocks (8.2),
  - insulation resistance and voltage stability (10.2 and 10.3),
  - ground and overhead lines (11.2),
  - durability and heating (12.1, tables X, XI and XII),
  - resistance to heat, fire and to stray currents (13.2, 13.3 and 13.4),
  - threaded connections (14.2, 14.3 and 14.4).
22. Electric wiring shall normally have a cross-section of not less than 1,5 mm<sup>2</sup>. The wire used for the connection shall be at least of type HO 7 RN-F or equivalent.
23. The type of lantern protection for explosion danger zones shall be established and certified for the purpose by the competent testing authorities.
24. The method of manufacture of the lanterns shall make provision for:
  1. ease of cleaning, including inside the lantern, and ease of changing the light source, even in darkness;
  2. prevention of the accumulation of condensation;
  3. use of durable elastic fittings only to ensure that demountable parts are leakproof;
  4. ensuring that no light of any colour other than that provided for can escape from the lantern.
25. All lanterns to be installed shall be accompanied by positioning and installation instructions indicating where the light is to be mounted, and the purpose and the type of interchangeable parts. It shall be possible to position movable lanterns easily and safely.
26. The required mounts shall be such that, in its intended position, the horizontal plane of symmetry of the lantern is parallel to the water line of the vessel.
27. The following marks shall be placed clearly and durably on each lantern, at a point remaining visible after installation on board:
  1. the rated power of the source, in so far as different rated powers may give different ranges,
  2. the type of lantern for sector lights,
  3. the zero-direction reference, on sector lights, using a mark immediately above or below the transparent section,
  4. the type of light, e.g. 'strong',
  5. the trademark,
  6. the place for the approval mark, for example .F.91.235.

*Article 3.02***Filters and optical glasses**

1. Filters (optics and glasses) and optical glasses may be made of organic glass (synthetic glass) or inorganic glass (silicate glass).

Filters and optical glasses of silicate glass shall be made of a glass at least of the class IV hydrolytic type referred to in ISO standard 719 guaranteeing durable resistance to water.

Filters and optical glasses of synthetic glass shall have a durable resistance to water comparable with those made of silicate glass.

Optical glasses shall be manufactured in glass with low internal stress.

**▼B**

2. Filters and optical glasses shall as far as possible be free of blisters, bubbles and impurities. There shall be no surface defects such as unpolished (matt) sections, deep scratches, etc.
3. Filters and optical glasses shall meet the requirements of Article 3.01. Their photometric and colorimetric properties shall not be affected by those conditions.
4. The red and green optical glasses of the side lights shall not be interchangeable.
5. In addition to the manufacturer's mark, the approval number and the type description shall be legibly and durably marked on filters and optical glasses at a point remaining visible once they have been placed in the lanterns.

These markings shall not result in values below the minimum photometric and colorimetric requirements.

*Article 3.03***Electric light sources**

1. Only filament lamps manufactured for the purpose shall be used in signal lanterns. They shall be available in the standard voltages. Exceptions may be permitted in special cases.
2. It shall be possible to install filament lamps only in the intended position in signal lanterns. A maximum of two unequivocal positions shall be permitted in signal lanterns. Incorrect and intermediate positions shall not be possible. For the test, the less favourable position shall be selected.
3. Filament lamps shall have no special features which adversely affect their efficiency, such as scratches or stains on the bulk or faulty positioning of the filament.
4. The operating colour temperature of filament lamps shall not be less than 2 360 K.
5. The mountings and lamp holders used shall meet the special requirements of the optical system and withstand the mechanical stresses of on-board operations.
6. The cap of the filament lamp shall be strong and solidly attached to the bulk so that after operating for 100 hours at an excess voltage of 10 % it withstands uniform rotation with a moment of 25 kgcm.
7. The trademark, the rated voltage and the power rating and/or the rated luminous intensity as well as the approval number shall be marked legibly and durably on the bulk or on the cap of filament lamps.
8. Filament lamps shall meet the following tolerances:

- (a) Filament lamps for the rated voltages of 230 V, 115 V, 110 V and 24 V

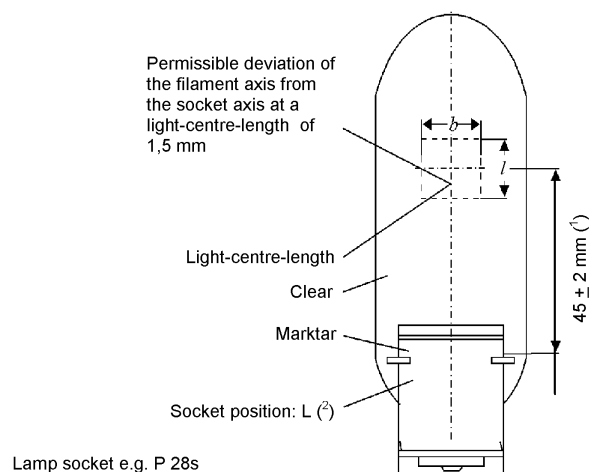

▼ **B**

Rated voltage V	Rated output W	Max. power noted <sup>3)</sup> W	Rated life h	Test values measured <sup>3)</sup>		Body of lantern mm	
				Horizontal luminous intensity <sup>4)</sup> cd	Colour temperature K	b mm	l mm
24	40	43		45	2360	$0,72^{+0,1}_0$	$13,5^{+1,35}_0$
110 or 115	60	69	1 000	to	to	$15^{+2,5}_0$	$11,5^{+1,5}_0$
230	65	69		65	2 856	$15^{+2,5}_0$	$11,5^{+1,5}_0$

*Comments*

1. Light-centre-length tolerance of the 24 V/40 W lamp:  $\pm 1,5$  mm.
2. L: the broad lug of the P 28 S cap is on the left when the lamp is upright, seen against the direction of emission.
3. Before measurement of the values at the start of the test, filament lamps shall have already been in service at the rated voltage for 60 minutes.
4. These limits shall be respected in an area extending  $\pm 10^\circ$  on either side of the horizontal line passing through the median point of the body of the lantern when the lamp is rotated through  $360^\circ$  on its axis.

## (b) Filament lamps for the rated voltages 24 V and 12 V

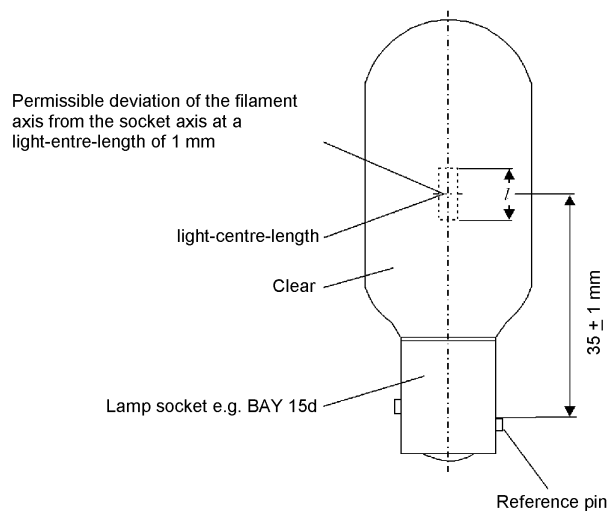

Rated voltage V	Rated output W	Max. power noted <sup>(1)</sup> W	Rated life h	Test values measured <sup>(1)</sup>		Body of lantern l mm
				Horizontal luminous intensity <sup>(2)</sup> cd	Colour temperature K	
12 24	10	18	1000	12 to 20	2 360 to 2 856	9 to 13 9 to 17
12 24	25	26.5		30 to 48		9 to 13

*Comments*

- <sup>(1)</sup> Before measurement of the values at the start of the test, filament lamps shall have already been in service at the rated voltage for 60 minutes.
- <sup>(2)</sup> These limits shall be respected in an area extending  $\pm 30^\circ$  on either side of the horizontal line passing through the median point of the body of the lantern when the lamp is rotated through  $360^\circ$  on its axis.

**▼B**

- (c) The filament lamps shall be marked on the cap with an indication of the corresponding sizes. If these marks are on the bulb, the operation of the lamp shall not be affected.
- (d) If discharge lamps are used instead of filament lamps, the same requirements as for filament lamps shall be applicable.

## CHAPTER 4

## TEST AND APPROVAL PROCEDURE

*Article 4.01***General rules of procedure**

Part I shall be applicable for the test and approval procedure.

*Article 4.02***Application**

1. The following data and documents as well as samples of the lanterns and of their accessories, if any, shall be attached to the application for approval submitted by the manufacturer or his authorised representative:
  - (a) the type of light (e.g. strong);
  - (b) the trade name and the description of the lantern type, its light source and accessories if any;
  - (c) for electric signal lanterns, the on-board voltage supply required by the lanterns depending on their purpose;
  - (d) specifications of all characteristics and capacities;
  - (e) a brief technical description indicating the materials of which the sample lantern is made and a wiring diagram with a brief technical description if accessories of the lantern likely to influence operation are included;
  - (f) for sample lanterns and, where relevant, their accessories, two copies of:
    - (i) adjustment or mounting instructions with data concerning the light source and the mounting or holding device;
    - (ii) sketch with dimensions and type names and descriptions needed to identify the test sample and lanterns installed on board and their accessories, if any;
    - (iii) other documents such as drawings, lists of parts, wiring diagrams, operating instructions and photographs which concern or may concern all the important details referred to in Chapters 1 to 3 of these test and approval conditions, in so far as they are necessary for verifying the conformity of the lanterns to be manufactured with the test sample. The following data and drawings are particularly relevant:
      - a longitudinal section showing the details of the structure of the filter and the profile of the light source (filament lamp), as well as the positioning and the mount,
      - a cross-section of the lantern halfway up the filter showing details of the layout of the light source, filter, the optical glass, if any, and the horizontal dispersion angle for sector lights,
      - a view from the rear for sector lights, with details of the holder or mount,
      - a view of circular lights with details of the holder or mount;
    - (iv) data concerning dimensional tolerances in mass produced light sources, filters, optical glasses, mounting or holding devices and of the light source placed in the lantern in relation to the filter;
    - (v) data concerning the horizontal luminous intensity of mass-produced sources at the rated voltage;



**▼B**

- (vi) data concerning mass-production tolerances for coloured glasses with regard to the colour and transparency of a standard illuminant A (2856 K) or the type of light from the intended light source.
2. Two samples ready for use shall be supplied with the application, each with 10 light sources of each rated voltage and, where relevant, five coloured filters of each signal colour, together with the mounting or positioning device.  
  
The specific additional accessories required for the approval tests shall also be made available on request.
  3. The sample shall correspond in all respects to the production models envisaged. It shall be fitted with all the accessories required for mounting and positioning it in the normal operating position in which it is to be used on board in accordance with its purpose. Some accessories may be omitted if the competent testing authority agrees.
  4. Additional samples, documents and data shall be supplied on request.
  5. The documents shall be submitted in the language of the country of the testing and approval authority.
  6. If an application for approval is submitted for an additional device, paragraphs 1 to 5 shall apply *mutatis mutandis*, on the understanding that the additional parts may be approved only in combination with the approved lanterns.
  7. Sector lights shall in principle be submitted as a complete set.

*Article 4.03***Test**

1. For tests on a new or amended version of an approved lantern or accessory, it shall be ascertained whether the sample meets the requirements of these test and approval conditions and corresponds to the documents referred to in Article 4.02(1)(f).
2. The approval test shall be based on the conditions occurring on board the vessels. The test shall cover all light sources, optical glasses and accessories which must be provided and which are intended for the signal lanterns.
3. The photometric and colorimetric test shall be carried out at the rated voltage.  
  
The evaluation of the lantern shall take into account the horizontal operating luminous intensity  $I_B$  and the operating colour temperature.
4. Parts or accessories shall be tested only with the type of lantern for which they are intended.
5. Tests done by other competent authorities may be accepted as proof of conformity with the requirements of Chapter 3, provided that they have been confirmed as equivalent to the tests set out in the Appendix.

*Article 4.04***Approval**

1. Approval of signal lanterns shall be based on Articles 4.01 to 4.05 of Part I.
2. For lanterns and accessories which are or will be mass-produced, the approval may be issued to the applicant following a test at the applicant's expense if the applicant guarantees that proper use will be made of the rights resulting from the approval.
3. In the event of approval, the approval certificate referred to in Article 4.03 of Part I shall be issued for the corresponding lantern type and an approval marking in accordance with Article 4.05 of Part I shall be allocated.

The approval marking and the serial number shall be legibly and durably affixed to each lantern manufactured in accordance with the sample, at a point which remains fully visible after installation on board. Original markings and type descriptions shall be clearly legible and shall be indelibly affixed. Marks liable to be confused with approval markings shall not be affixed to lanterns.

4. Approval may be granted for a limited period and subject to conditions.

**▼B**

5. Modifications of an approved lantern and additions to approved lanterns shall be subject to the agreement of the testing authority.
6. If approval of a lantern is withdrawn, the applicant shall be informed directly.
7. One sample of each type of lantern approved shall be left with the testing authority which approved it.

*Article 4.05***Cessation of validity of the approval**

1. The approval shall cease to be valid on the expiry of the prescribed period, or if it is revoked or withdrawn.
2. The approval may be revoked if:
  - subsequently and conclusively, the conditions for its issue no longer exist,
  - the test and approval conditions are no longer met,
  - a lantern does not correspond to the approved sample,
  - the conditions imposed are not complied with, or
  - the holder of the approval proves unreliable.

It shall be withdrawn if the conditions laid down when it was issued have not been met.
3. If manufacture of an approved signal lantern type is discontinued, the testing authority which issued the approval shall be informed immediately.
4. Withdrawal or revocation of approval shall mean that use of the approval number allocated is prohibited.
5. Once the approval ceases to be valid the certificate shall be submitted for annulment to the testing authority which issued it.

*Appendix***Environment tests**

1. **Test concerning protection against splashing water and dust**
  - 1.1. The type of lantern protection shall be guaranteed in accordance with classification IP 55 of the IEC publication — Part 598-1.
 

The test concerning protection of the sample against splashing water and against dust, and the evaluation of the results, shall be carried out in conformity with IEC publication 529, classification IP 55.

The first '5' stands for protection against dust. This means: full dust-proof protection of live components and protection against harmful deposits of dust. The penetration of dust is not completely prevented.

The second '5' stands for protection against splashing water. This means that a water jet aimed at the lantern from all directions shall have no damaging effect.
  - 1.2. The protection of the sample against water is evaluated as follows: the protection is considered to be adequate if any water which has entered has no detrimental effect on operation of the sample.
 

No water deposits shall have formed on the insulating materials, if this means that minimum vanishing point values could not be achieved. Live components shall not be wetted and shall not be affected by any water accumulating inside the lantern.
2. **Humid atmosphere test**
  - 2.1. *Purpose and application*

This test is to determine the action of humid heat and of humidity during a change of temperature, as described in Article 3.01(10)(b), during operation or during transport or storage, on nautical installations,

**▼B**

appliances and instruments, given that they could experience surface humidity from condensation.

This condensation is similar in the case of non-enclosed components to the action of a dust deposit or of a hygroscopic salt film forming during operation.

The following specification is based on IEC publication 68, Part 2-30 in conjunction with Article 3.01(10)(a) and (b). Additional information can be found in the publication.

Components and groups of components submitted non-enclosed for approval as type models shall be tested in that non-enclosed state or, if this is not possible given the nature of the components, by providing them with the minimum protection devices which the applicant considers necessary for use on board.

## 2.2. Execution

1. The test is conducted in a test chamber in which, if necessary by means of an air circulation device, the temperature and level of humidity are practically the same at all points. The movement of the air shall not noticeably cool the sample being tested, but should be sufficient to ensure that the prescribed values for air temperature and humidity are maintained in its immediate vicinity.

Condensate shall be continuously evacuated from the test chamber. No condensate shall drip on to the sample. Condensate may only be reused for humidification following reprocessing, in particular once chemicals from the sample have been eliminated.

2. The sample shall not be exposed to heat radiation from the heating of the chamber.
3. The sample shall have been out of service immediately prior to the test long enough for all its parts to be at ambient temperature.
4. The sample is placed in a test chamber at an ambient temperature of  $+ 25 \pm 10$  °C corresponding to its normal use on board.
5. The chamber is closed. The air temperature is set at  $-25 \pm 3$  °C and the relative humidity at 45 to 75 % and those conditions are maintained until the sample has reached the same temperature.
6. The relative humidity of the air is raised to not less than 95 % in a maximum time of one hour, the air temperature remaining unchanged. This increase may take place during the last hour of temperature conditioning of the sample.
7. The air temperature in the chamber is increased progressively to  $+40 \pm 2$  °C over a period of  $3 \text{ h} \pm 0,5 \text{ h}$ . As the temperature rises, the relative humidity of the air is maintained at not less than 95 %, and at not less than 90 % during the last 15 minutes. During this temperature rise, the sample becomes damp.
8. The air temperature is maintained at  $+ 40 \pm 2$  °C for a time period of  $12 \text{ h} \pm 0,5 \text{ h}$  measured from the start of phase 7, with a relative air humidity of  $93 \pm 3$  %. During the first 15 and the last 15 minutes of the period during which the temperature is  $+ 40 \pm 2$  °C, relative air humidity may be between 90 and 100 %.
9. The air temperature is reduced to  $+ 25 \pm 3$  °C over a period of three to six hours. The relative humidity of the air must be constantly maintained at over 80 %.
10. The air temperature is maintained at  $+ 25 \pm 3$  °C for a period of 24 hours from the start of phase 7, relative air humidity remaining constantly above 95 %.
11. Phase 7 is repeated.
12. Phase 8 is repeated.
13. Not earlier than 10 hours after the start of phase 12 the air conditioning equipment of the sample is switched on. When the climatic data indicated by the manufacturer for the sample have been obtained, the sample is put into operation in accordance with the manufacturer's instructions and at the rated voltage of the on-board network, with a tolerance of  $\pm 3$  %.

**▼B**

14. After the time necessary to achieve normal operation in accordance with the manufacturer's instructions has elapsed, the functions are checked and the operating data of importance for use on board recorded and noted. If the chamber needs to be opened for this purpose, it shall be reclosed as quickly as possible.

If more than 30 minutes are required to reach normal operation, this phase shall be extended sufficiently so that, once the operating state has been reached, at least 30 minutes are available to monitor the functions and measure the operating data.

15. Within a period of one to three hours, with the sample again in service, the air temperature is lowered to ambient temperature, with a tolerance of  $\pm 3$  °C, and the relative humidity of the air to under 75 %.
16. The chamber is opened and the sample exposed to the normal temperature and humidity of the ambient air.
17. After 3 hours, and when all humidity visible on the sample has evaporated, the functions of the sample are monitored again, and operating data of importance for use on board recorded and noted.
18. The sample is subjected to a visual inspection. The body of the lantern is opened and the interior examined for any effects of the climatic test and for residual condensate.

### 2.3. *Results to be obtained*

- 2.3.1. The sample shall function normally under the conditions stipulated in phases 12 to 18. No deterioration shall be observed.
- 2.3.2. The operating data for phases 12 and 18 shall be within the tolerances permitted for the sample on the basis of these test and approval conditions.
- 2.3.3. There shall be no corrosion or no residual condensate inside the lantern which, as a result of the long-term action of high atmospheric humidity, might cause it to malfunction.

## 3. **Cold test**

### 3.1. *Purpose*

This test is to determine the action of cold during operation or during transport and storage, in accordance with Article 3.01(8) and (10). Additional information may be found in IEC publication 68, Part 3-1.

### 3.2. *Execution*

1. The test is carried out in a test chamber in which, if necessary by means of an air circulation device, the temperature is practically the same at all points. The air humidity must be low enough to ensure that the sample is not wetted by condensation during any of the phases.
2. The sample is placed in a test chamber at an ambient temperature of  $+ 25 \pm 10$  °C corresponding to its normal use on board.
3. The temperature in the chamber is lowered to  $- 25 \pm 3$  °C at a rate of not more than 45 °C/h.
4. The temperature in the chamber is maintained at  $- 25 \pm 3$  °C until the sample has reached temperature equilibrium, plus at least a further 2 hours.
5. The temperature in the chamber is raised to  $0 \pm 2$  °C at a rate of not more than 45 °C/h.

For all samples referred to in Article 3.01(10)(a), the following also applies:

6. During the last hour of phase (4) in climate class X, the sample is put into operation in accordance with the manufacturer's instructions, at the rated voltage of the on-board network, with a tolerance of  $\pm 3$  %. The heat sources contained in the sample must be in operation.

**▼B**

After the time necessary to achieve normal operation has elapsed, the functions are checked and the operating data of importance for use on board recorded and noted.

7. The temperature in the chamber is raised to ambient temperature at a rate of not more than 45°C/h.
8. Once the sample has reached temperature equilibrium, the chamber is opened.
9. The functions of the sample are checked again and the operating data of importance for use on board recorded and noted.

### 3.3. *Results to be obtained*

The sample shall function normally under the conditions stipulated in phases 7, 8 and 9. No deterioration shall be observed.

The operating data for phases 7 and 9 shall be within the tolerances permitted for the sample on the basis of these test and approval conditions.

## 4. **Heat test**

### 4.1. *Purpose and application*

This test is to determine the action of heat during operation, transport and storage, in accordance with Article 3.01(8)(a) and (10)(a). The following specification is based on IEC publication 68, Part 2-2 in conjunction with Article 3.01(10)(a). Additional information can be found in the IEC publication.

	Normal	Extreme
	Environment tests	
Climate classes X and S	+ 55 °C	+ 70 °C
	Permissible tolerance $\pm 2$ °C	

The test under extreme ambient conditions shall, in principle, be performed first. If the operating data are within the tolerances applicable under normal ambient conditions, the normal ambient test may be dispensed with.

### 4.2. *Execution*

1. The test is conducted in a test chamber in which, if necessary by means of an air circulation device, the temperature is practically the same at all points. The movement of the air shall not noticeably cool the sample being tested. The sample shall not be exposed to heat radiation from the heating of the chamber. The air humidity must be low enough to ensure that the sample is not wetted by condensation during any of the phases.
2. The sample is placed in a test chamber at a temperature of  $+ 25 \pm 10$  °C corresponding to its normal use on board. The sample is put into operation in accordance with the manufacturer's instructions at the rated voltage of the on-board network with a tolerance of  $\pm 3$  %.

After the time necessary to achieve normal operation has elapsed, the functions are checked and the operating data of importance for use on board recorded and noted.

3. The air temperature in the chamber is raised to the test temperature referred to in Article 3.01(10)(a) at a rate of not more than 45 °C/h.
4. The air temperature is maintained at the test temperature until the sample reaches temperature equilibrium plus a further two hours.

During the last two hours, the functions are checked again and the operating data recorded and noted.

**▼ B**

5. The temperature is lowered to ambient temperature over a period of not less than one hour. The chamber is then opened.

After bringing the sample to ambient temperature, the functions are again checked and the operating data of importance for use on board recorded and noted.

4.3. *Results to be obtained*

The sample shall function normally under the conditions stipulated in all phases of the test. No deterioration shall be observed. The operating data for phases (2), (4) and (5) shall be within the tolerances permitted for the sample for normal ambient environment tests on the basis of these test and approval conditions.

5. **Vibration test**

5.1. *Purpose and application*

This test is to determine the functional and structural effects of the vibrations referred to in Article 3.01(10)(e). Structural effects concern the performance of the mechanical components, particularly vibrations by resonance and stress on materials leading to fatigue without necessarily producing direct effects on operation or changes in operating data.

The functional effects directly concern the operation and operating data of the sample. They may be linked to structural effects.

The following specification is based on IEC publication 68, Part 2-6 in conjunction with Article 3.01(10)(e). Values deviating from those in the abovementioned provisions are indicated by \*. Additional information may be found in IEC publication 68, Part 2-6.

Test requirements:

The test shall be conducted with sinusoidal vibrations using the following frequencies with the amplitudes indicated:

	Normal	Extreme
	Environment tests	
Vibration class V:		
Frequencies	2 to 10 Hz	2 to 13,2 Hz*
Amplitude	± 1,6 mm	± 1,6 mm
Frequencies	10 to 100 Hz	13,2 to 100 Hz*
Acceleration amplitude	± 7 m/s <sup>2</sup>	± 11 m/s <sup>2</sup>

The test under extreme ambient conditions shall, in principle, be performed first. If the operating data are within the tolerances applicable under normal ambient conditions, the normal ambient test may be dispensed with.

Samples intended to be used with shock-absorbing devices shall be tested with those devices. If, in exceptional cases, it is not possible to test with the shock-absorbers intended for normal operation, the appliances shall be tested without shock-absorbers and the stress modified to take account of the action of the shock-absorber.

A test without shock-absorbers is also acceptable for the determination of characteristic frequencies.

The vibration test shall be conducted in three main directions perpendicular to each other. For samples which on account of their construction may be subject to special stresses from vibrations at an oblique angle to the main directions, the test shall also be performed in the directions of special sensitivity.

**▼B**5.2. *Execution*

## 1. Test apparatus

The test is conducted using a vibrating device known as a vibrating table, which enables the sample to be subjected to mechanical vibrations in accordance with the following conditions:

- The basic movement shall be sinusoidal and such that the mounting points of the sample basically move in phase and along parallel lines.
- The maximum amplitude of vibration of the lateral movement of any mounting point shall not exceed 25 % of the specified amplitude of the basic movement.
- The relative importance of the spurious vibration, expressed by the formula

$$d = \frac{\sqrt{a_{\text{tot}}^2 - a_1^2}}{a_1} \cdot 100 \text{ (in \%)}$$

where  $a_1$  is the effective value of the acceleration produced by the frequency applied,

and where  $a_{\text{tot}}$  is the effective value of the total acceleration, including  $a_1$ , measured in the frequencies < 5 000 Hz,

shall not exceed 25 % at the mounting point taken as the point of reference for measurement of the acceleration.

- The vibration amplitude shall not differ from its theoretical value by more than:
  - ± 15 % at the mounting point taken as the point of reference and
  - ± 25 % at any other mounting point.

In order to determine the characteristic frequencies, it must be possible to adjust the vibration amplitude in small steps between zero and the theoretical value.

- The vibration frequency shall not differ from its theoretical value by more than
 

± 0,05 Hz	for frequencies up to 0,25 Hz,
± 20%	for frequencies higher than 0,25 Hz and up to 5 Hz,
± 1Hz	for frequencies higher than 5 Hz and up to 50 Hz,
± 2%	for frequencies higher than 50 Hz,

In order to compare the characteristic frequencies, it must be possible to adjust them at the beginning and end of the vibration test to within:

- ± 0,05 Hz for frequencies up to 0,5 Hz,
- ± 10%    ± 0,5 Hz for frequencies up to 5 Hz,  
          ± 0,5 Hz for frequencies higher than 5 Hz and up to 100 Hz,
- ± 0,5% for frequencies higher than 100 Hz.

In order to scan the frequencies, it should be possible for the vibration frequency to vary continuously and exponentially in both directions between the lower and upper limits of the frequency ranges indicated in paragraph 5.1, with a scanning speed of 1 octave/minute ± 10 %.

In order to determine the characteristic frequencies, it must be possible to slow the speed of variation of the vibration frequency as desired.

- The intensity of the magnetic field created by the vibration device in the vicinity of the sample should not exceed 20

**▼B**

kA/m. The testing authority may require lower permissible values for some samples.

2. First inspection, mounting and putting into service

The sample is inspected visually to verify that it is in impeccable condition as far as is apparent, and that the assembly is impeccable from the point of view of the construction of all the components and groups of components.

The sample is mounted on the vibrating table in accordance with the type of mount provided for on-board installation. Samples, the operation and performance of which under the influence of vibrations depend on their position in relation to the vertical, shall be tested in their normal operating position. The mounts and devices used for the mounting shall not noticeably modify the amplitude and the movements of the sample in the range of frequencies used in the test.

The sample is put into operation in accordance with the manufacturer's instructions at the rated voltage of the on-board network with a tolerance of  $\pm 3\%$ .

After the time necessary to achieve normal operation has elapsed, the functions are checked and the operating data of importance for use on board recorded and noted.

3. Preliminary inspection of performance when subjected to vibrations

This test phase shall be conducted for all samples. For samples which may be used for different purposes with varying vibratory effects, the test shall be conducted for all or some of the various uses.

A frequency cycle is effected with the vibrating table so that the frequency range indicated in paragraph 5.1, with its corresponding amplitudes, is covered from the lowest frequency to the highest and conversely, at a rate of one octave per minute. The sample is observed during this operation using the appropriate means of measurement and visually, if necessary using a stroboscope, to check thoroughly for any operating problems, modifications of operating data and mechanical phenomena such as vibrations by resonance and rattling noises occurring in specific frequencies. These frequencies are described as 'characteristic'.

If necessary, in order to determine characteristic frequencies and vibration effects, the frequency variation is slowed down, stopped or reversed and the amplitude of the vibrations reduced. During the gradual modification of the operating data, it is necessary to wait until the final value is reached while maintaining the vibration frequency, although not more than five minutes.

During the frequency scan, at least the frequencies and operating data of importance for use on board are recorded, and all characteristic frequencies are noted, with their effects, for subsequent comparison during phase (7).

If the response of the sample to mechanical vibrations cannot be adequately determined during operation, an additional vibration response test shall be performed without connecting the sample.

If during the frequency scan the operational data noticeably exceed the permissible tolerances, the operation is unacceptably disrupted or if the structural resonance vibrations are likely to cause destruction should the vibration test be continued, the test may be interrupted.

4. Test of switching functions

This test phase shall be conducted for all samples where vibratory stress may influence switching functions, for example relays.

The sample is subjected to vibrations in the frequency ranges indicated in paragraph 5.1 with frequency variation steps in accordance with the E-12 series<sup>(1)</sup> and the corresponding amplitudes. At each frequency step, all switching functions which

<sup>(1)</sup> Fundamental values of the E-12 IEC series: 1,0; 1,2; 1,5; 1,8; 2,2; 2,7; 3,3; 3,9; 4,7; 5,6; 6,8; 8,2.



**▼B**

may be sensitive to vibration, if necessary including switching-on and switching-off, are carried out at least twice.

Switching functions may also be tested at frequencies occurring between the E-12 series values.

5. Extended test

This test phase shall be conducted for all samples. For samples which may be used for different purposes with varying vibratory effects, the first part of this phase (when the sample is in service) may be conducted several times, for all or some of the various uses.

When the sample is in service as described in phase (2) above, it is subjected to five cycles during which the frequency range indicated as stress producing in paragraph 5.1, with the corresponding amplitudes, is covered each time from the lowest to the highest frequency and conversely, at a rate of one octave per minute.

After the fifth cycle, the vibrating table may be stopped, the functions are tested and the operating data of importance for on-board use recorded and noted.

6. Fixed frequency extended test

This test phase shall be conducted if, on examining vibratory performance during phase (3) above, mechanical resonances are observed during the scan of the frequency range above 5 Hz, which are acceptable for extended use on board according to the manufacturer or his authorised representative, but for which the strength of the parts concerned cannot be taken for granted. In particular, this phase concerns appliances fitted with shock absorbers with a resonance frequency within the frequency range indicated in paragraph 5.1 and higher than 5 Hz.

When the sample is in service as described in phase 2 above, for each resonance frequency concerned, it is subjected for two hours to vibrations at the amplitude provided for in the extreme ambient test and at the corresponding frequency as referred to in paragraph 5.1, the direction of vibration being that which in normal use exerts the maximum stress on the parts in question. If necessary, the frequency applied must be rectified so that the resonance vibrations continue at not less than 70 % of their maximum amplitude, or the frequency must be made to vary continuously between two values 2 % below and 2 % above the resonance frequency initially observed, at a rate of at least 0,1 but not more than 1 octave per minute. During the vibratory stress, the functions of the sample are monitored until malfunctions begin to occur, as a result of mechanical parts becoming detached or displaced or of a break in the electrical connection or of a short-circuit.

Samples for which the execution of this test phase is relevant when switched off may be tested in that state, provided the mechanical stress on the parts concerned is not less than in normal use.

7. Final inspection of performance when subjected to vibration

This test phase must be effected as necessary.

The inspection of performance when subjected to vibrations referred to in phase 3 is repeated using the frequencies and amplitudes applied in that phase. The characteristic frequencies observed and the observed effects of vibration stress are compared with the results of phase 3 in order to determine any changes which occurred during the vibration test.

8. Conclusions of the inspection

Once the vibrating table has stopped and the time necessary to arrive at an operating state without vibratory stress has elapsed, the functions are tested and the operating data of importance for on-board use recorded and noted.

Lastly, the sample is inspected visually to verify that it is in impeccable condition.

**▼B**5.3. *Results to be obtained*

The sample and its components and groups of components should not show any mechanical resonance vibrations in the frequency ranges indicated in paragraph 5.1. When resonance vibrations of this type are unavoidable, construction measures must be taken to ensure that the sample, its components and groups of components suffer no damage.

During and following the vibration test, no perceptible effect of vibratory stress shall occur, and in particular no difference between the characteristic frequencies observed in phase 7 and the values determined in phase 3 and no damage or malfunction as a result of extended vibration shall be observed.

In the case of the normal ambient test, the operating data recorded in phases 3 to 8 shall remain within the tolerances permitted on the basis of these test and approval conditions.

During the switching functions test in phase 4, no switching malfunction or breakdown shall occur.

6. **Accelerated weather resistance test**6.1. *Purpose and application*

The accelerated weather resistance test (simulation of exposure to the elements through exposure to radiation from xenon lamps with filters and by sprinkling) is conducted in accordance with Parts 2-3, 2-5 and 2-9 of IEC publication 68 plus the following additions:

According to this publication, the accelerated weather resistance test aims at simulating natural weather conditions by means of a test apparatus under specific reproducible conditions, so as to provoke rapid changes in the properties of the materials.

The accelerated test is carried out in a test apparatus with filtered radiation from xenon lamps and intermittent sprinkling. Following exposure to the elements, measured by the product of the intensity of radiation and its duration, the agreed properties of the samples are compared with those of samples of the same origin which have not been exposed to the elements. First to be specified are the properties crucial for practical use, such as colour, surface quality, shock resistance, tensile strength and solidity.

In order to compare the results with those of exposure to natural weather conditions, it is assumed that the alteration of properties by the elements is caused in particular by natural radiation and the simultaneous action of oxygen, water and heat on the materials.

For the accelerated test, particular account must be taken of the fact that the radiation in the appliance is very close to natural radiation (see the IEC publication). The radiation from the xenon lamp with a special filter simulates natural radiation.

Experience has shown that, under the test conditions indicated, there is a strong correlation between resistance to weather in the accelerated test and resistance to natural weather conditions. The accelerated test, which is independent of place, climate and season, has the advantage over natural weather conditions of being reproducible and of making it possible to shorten the duration of the test as it is independent of the alternation of day and night and of the seasons.

6.2. *Number of samples*

For the weather-resistance test, unless otherwise agreed, an adequate number of samples is used. An adequate number of samples not subjected to weather conditions is required for the purposes of comparison.

6.3. *Preparation of samples*

The samples are subjected to the tests in the state in which they are delivered, unless otherwise agreed. The samples to be used for comparison are kept in the dark at ambient temperature throughout the tests.

**▼ B**6.4. *Test apparatus*

The test apparatus consists basically of a ventilated test chamber with the radiation source in the centre. Optical filters are placed round the radiation source. The sample mounts are rotated around the longitudinal axis of the system at the required distance from the source and the filters to reach the intensity of radiation prescribed in paragraph 6.4.1.

The intensity of the radiation on any component of the total sample surfaces exposed shall not differ by more than  $\pm 10\%$  from the arithmetical mean of radiation intensity on the various surfaces.

6.4.1. *Radiation source*

A xenon lamp is used as the radiation source. The radiation flux shall be selected so that the intensity of radiation on the sample surface is  $1\,000 \pm 200\text{ W}\cdot\text{m}^{-2}$  in the 300 to 830 nm waveband (see paragraph 6.9 for the apparatus for measuring irradiation).

If air-cooled xenon lamps are used, the air already used containing ozone must not enter the test chamber and must be evacuated separately.

The experimental values show that the radiation flux from xenon lamps drops to 80 % of its initial value after approximately 1 500 hours of operation; after this period, the proportion of ultra-violet radiation is also reduced noticeably compared with other forms of radiation. The xenon lamp must therefore be replaced after this period (see also the data supplied by the xenon lamp manufacturer).

6.4.2. *Optical filters*

Optical filters must be positioned between the radiation source and the sample mounts so that the filtered radiation from the xenon lamps is as close as possible to natural radiation (see IEC publication 68, Parts 2 to 9).

All glass filters must be cleaned regularly to avoid any undesirable decrease in radiation intensity. The filters must be replaced if the similarity to natural radiation can no longer be achieved.

With regard to appropriate optical filters, the data supplied by the manufacturer of the test apparatus must be complied with. On delivery of test apparatus, the manufacturer must guarantee that it meets the requirements set out in paragraph 6.4.

6.5. *Sprinkling and air humidifying device*

The sample shall be wetted in such a way that the action is the same as that of natural rain and dew. The sample sprinkling device shall be so constructed that during sprinkling all the external surfaces of the samples are wetted. It must be controlled in such a way that the sprinkling/dry-period cycle prescribed in paragraph 6.10.3 is complied with. The air in the test chamber must be humidified so as to maintain the relative humidity prescribed in paragraph 6.10.3. The water used for sprinkling and for humidifying the air must be distilled water or fully desalinated water (conductivity  $< 5\ \mu\text{S}/\text{cm}$ ).

The tanks, pipes and sprayers for distilled or fully desalinated water must be of corrosion-resistant materials. The relative humidity of the air in the test chamber is measured using a hygrometer protected against sprinkling and direct radiation and is adjusted by means of the hygrometer.

When fully desalinated water or water in a closed circuit is used the risk exists (as in the varnish test) of the formation of a deposit on the surface of the samples or of wear on the surface by substances in suspension.

6.6. *Ventilation device*

The temperature of the black panel prescribed in paragraph 6.10.2 is maintained in the test chamber by the circulation of clean, filtered, humidified and, if necessary, temperature-controlled air over the samples. The flow and speed of the air shall be selected so as to ensure uniform tempering of all external surfaces of the mounts of the samples in the system.

**▼B**6.7. *Sample mounts*

Any mounts in stainless steel enabling the samples to be mounted as set out in paragraph 6.10.1 may be used.

6.8. *Blackpanel thermometer*

In order to measure the temperature of the black panel during the dry period of the cycle, a blackpanel thermometer is used. This thermometer consists of a stainless steel panel thermally insulated from its mounts, the same size as the sample mounts and  $0,9 \pm 0,1$  mm thick. The two sides of the panel are covered with shiny black varnish which is highly weather-resistant and has a maximum reflecting power of 5 % at wave-lengths of more than 780 nm. The temperature of the panel is measured using a bimetallic thermometer the sensor of which is placed in the middle of the panel with a good thermal contact.

It is not advisable to leave the thermometer in the apparatus throughout the test referred to in paragraph 6.10. It is sufficient for it to be inserted into the test apparatus every 250 hours, for 30 minutes or so, and for the temperature of the black panel to be taken during the dry period.

6.9. *Irradiation measuring apparatus*

Irradiation (unit of measurement:  $W \cdot s \cdot m^{-2}$ ) is the product of the intensity of irradiation (unit:  $W \cdot m^{-2}$ ) and duration of irradiation (unit: s). The irradiation of the surfaces of the sample in the test apparatus is measured with an appropriate irradiation measuring apparatus, adapted to the radiation function of the system consisting of the radiation source and the filter. The irradiation measuring apparatus shall be graduated or calibrated so that infra-red radiation over 830 nm is not taken into account.

The capacity of the irradiation measuring apparatus depends basically on whether its sensor is highly resistant to weather and to ageing and has adequate spectral sensitivity to natural radiation.

The irradiation measuring apparatus may include the following parts, for example:

- (a) a silicon photo-electric cell as radiation sensor;
- (b) an optical filter placed in front of the photo-electric cell; and
- (c) a coulometer which measures the product (unit:  $C = A \cdot s$ ) of the intensity of the current produced in the photo-electric cell in proportion to radiation intensity (unit: A) and the duration of radiation (unit: s).

The scale of the irradiation measuring apparatus shall be calibrated. The calibration shall be checked after being used for a year and corrected if necessary.

The intensity of irradiation on the surface of samples depends on the distance from the radiation source. Sample surfaces shall therefore, as far as possible, be at the same distance from the source as the sensor of the irradiation measuring apparatus. If this is not possible, the irradiation reading on the measuring apparatus shall be multiplied by a correction factor.

6.10. *Execution*

- 6.10.1. The samples are placed in mounts so that water cannot collect on the rear surface. The sample mounts must cause only the smallest possible amount of mechanical stress. In order to ensure irradiation and sprinkling are as evenly distributed as possible, the samples are rotated during the test at a rate of one to five revolutions per minute round the source-filter system and the sprinkling device. Normally, a single side of the sample is exposed to the weather conditions. Depending on the applicable provisions of the IEC publication, or as otherwise agreed, the front and back surfaces of a single sample may also be exposed. In this case, each surface is exposed to the same radiation and the same sprinkling.

The exposure of the front and back surfaces of a given sample to the same radiation and sprinkling may be produced by the periodic rotation of the sample. This can be done automatically using rotating appliances if the mount is in the form of an open frame.

**▼ B**

- 6.10.2. The temperature of the black panel at the point where the samples are placed during the dry period is set and regulated in accordance with the IEC publications applicable to the equipment in question. Unless otherwise agreed, the average temperature of the black panel must be kept at + 45 °C. Average temperature of the black panel means the arithmetic mean of the black panel temperature reached at the end of the dry period. During the dry period, a local difference of  $\pm 5$  °C is permissible, and  $\pm 3$  °C in borderline cases.

In order to maintain the required temperature of the black panel and, when necessary, ensure radiation of equal intensity on the front and back surfaces of the sample (see paragraph 6.10.1), the samples may be turned automatically through 180° after each revolution. In this case, the blackpanel thermometer and the irradiation measuring apparatus shall be included in the rotation movement.

- 6.10.3. Samples installed in mounts and the sensor of the irradiation measuring apparatus referred to in paragraph 6.9 are evenly exposed to radiation and sprinkled according to the cycle defined below, which is repeated successively:

Sprinkling: 3 minutes

Dry period:: 17 minutes

The relative humidity of the air must be 60 to 80 % during the dry period.

- 6.11. *Test duration and procedure*

The test follows procedure B in IEC publication 68, Part 2-9. The test duration is 720 hours, with the sprinkling cycle defined in paragraph 6.10.3.

It is recommended that the weather-resistance test should be carried out with one and the same sample (in the case of a non-destructive test of the modification of the properties to be considered, such as the weather-resistance test, for example) or with several samples (in the case of a destructive test, as for shock-resistance, for example) at various degrees of irradiation, to be agreed upon. The development of the modification of the properties of a piece of equipment throughout the weather test can therefore be determined.

- 6.12. *Assessment*

After the exposure to bad weather is completed, the sample is kept for at least 24 hours in darkness in an air temperature of +23 °C, a dew point of +12 °C, a relative air humidity of 50 %, an air circulation speed of 1 m/s and an atmospheric pressure of 860 to 1060 hPa. (The permissible difference may be  $\pm 2$  °C for the air temperature and  $\pm 6$  % for the relative humidity.)

These samples and those used for the comparison referred to in paragraphs 6.2 and 6.3 are inspected to determine properties in accordance with the requirements indicated in Article 2.01(1) and (2) and in Article 3.01(12).

## 7. **Salt water and weather-resistance test**

(sea-fog test)

- 7.1. *Purpose and application*

This test is to determine the action of salt water and a saline atmosphere during operation and during transport and storage in accordance with Article 3.01.

It may be restricted to the sample or to specimens of the materials used.

The following specifications are based on IEC publication 68, Part 2-52. Additional information can be found in the publication.

- 7.2. *Execution*

1. Test apparatus

**▼B**

The test is conducted in a test chamber using an atomiser and a saline solution meeting the following conditions:

- the materials of the test chamber and the atomiser must not influence the corrosive action of the salt mist,
- a fine, homogeneous, wet, thick mist must be diffused inside the test chamber; the distribution must not be affected by eddies or by the presence of the sample. The jet must not touch the sample directly. Drops forming on the inside of the chamber must not be able to fall on the sample;
- the test chamber must be adequately ventilated and the ventilation outlet protected against sudden changes in the movement of the air, so as to prevent the formation of a strong air current in the chamber,
- the saline solution used must consist, by mass, of  $5 \pm 1$  parts of pure sodium chloride, with a maximum of 0,1 % sodium iodide and 0,3 % impurities, in the dry state, to  $95 \pm 1$  parts of distilled or fully desalinated water. Its pH must be between 6,5 and 7,2 at a temperature of  $+ 20 \pm 2$  °C and be kept within these limits during the operation. Solution once sprayed must not be reused,
- the compressed air used for spraying must be free of impurities such as oil or dust and shall have a humidity level of at least 85 % in order to avoid blockage of the nozzle,
- the mist diffused in the chamber must have a density such that, in a clean receptacle with an open horizontal surface area of 80 cm<sup>2</sup>, placed anywhere in the chamber, the average precipitation over the whole time is between 1.0 ml and 2.0 ml per hour. In order to monitor the density of the mist, at least two receptacles shall be placed in the chamber in such a way as not to be covered by the sample and not to receive drops of condensation. In order to calibrate the quantity of solution sprayed, the duration of spraying shall be at least eight hours,
 

the period of humidity between phases of spraying is spent in an air-conditioned chamber in which the air can be kept at a temperature of  $+ 40 \pm 2$  °C and at a relative humidity of  $93 \pm 3$  %.

## 2. Preliminary inspection

The sample is inspected visually to verify that it is in impeccable condition, and in particular that it is correctly assembled and that all openings close properly. External surfaces soiled with grease, oil or mud are cleaned. All controls and moving parts are manipulated and checked for proper operation. The mobility of all closures, covers and moving parts intended to be detached or moved during operation or maintenance must be inspected for mobility and correctly replaced.

The sample is put into operation in accordance with the manufacturer's instructions at the rated voltage of the on-board network with a tolerance of  $\pm 3$  %.

After the time required to reach normal operation has elapsed, the functions are tested and the operating data of importance for on-board use and for assessing the action of the salt mist atmosphere are recorded and noted. The sample is then disconnected for exposure to spraying.

## 3. Spraying phase

The sample is put into the salt mist chamber and exposed to the salt mist for two hours at a temperature of  $+15$  °C to  $+35$  °C.

## 4. Humidity period

The sample is placed in the air-conditioned chamber so that the least possible amount of saline solution drips from it. It is kept in the air-conditioned chamber for seven days, at an air temperature of  $+ 40 \pm 2$  °C and a relative humidity of  $93 \pm 3$  %. It must not come into contact with any other sample or metal object. Several samples may be so arranged as to preclude any mutual influence.

## 5. Repetition of the test cycle

The test cycle, including phases 3 and 4, is repeated three times.

**▼B**

## 6. Subsequent treatment

Following the fourth test cycle, the sample is taken out of the air-conditioned chamber and immediately washed for five minutes in running tap water and rinsed in distilled or desalinated water. Drops adhering to the sample are removed by an air jet or shaken off.

The sample is exposed to the normal ambient atmosphere for at least three hours, and in any case long enough for any visible humidity to have evaporated, before being subjected to a final inspection. The sample is dried for an hour at  $+ 55 \pm 2$  °C after rinsing.

## 7. Conclusions of the inspection

The external appearance of the sample is inspected visually. The nature and extent of deterioration from its initial state are recorded in the test report, with supporting photographs if necessary.

The sample is put into operation in accordance with the manufacturer's instructions at the rated voltage of the on-board network with a tolerance of  $\pm 3$  %.

After the time required to reach normal operation has elapsed, the functions are tested and the operating data of importance for on-board use and for assessing the action of the salt mist atmosphere are recorded and noted.

All controls and moving parts are manipulated and checked for proper operation. The mobility of all closures, covers and moving parts intended to be detached or moved during operation or maintenance is checked.

7.3. *Results to be obtained*

The sample must not show any change which could:

- hinder its use and operation,
- prevent to any considerable extent the detachment of closures and covers, or the movement of moving parts in so far as this is necessary for use or maintenance,
- impair the waterproofness of the housing,
- be expected to cause malfunctions in the long run.

The operating data recorded in phases 3 and 7 must remain within the tolerances laid down in these test and approval conditions.

## PART III

**MINIMUM REQUIREMENTS AND TEST CONDITIONS FOR RADAR EQUIPMENT USED FOR NAVIGATION IN INLAND WATERWAY VESSELS**

## CONTENTS

Chapter 1:	General
Article 1.01	Scope
Article 1.02	Purpose of the radar equipment
Article 1.03	Approval testing
Article 1.04	Application for approval testing
Article 1.05	Type-approval
Article 1.06	Marking of the equipment and approval number
Article 1.07	Manufacturer's declaration
Article 1.08	Modifications to approved equipment
Chapter 2:	General minimum requirements for radar equipment
Article 2.01	Construction, design
Article 2.02	Spurious emissions and electromagnetic compatibility

**▼B**

Article 2.03	Operation
Article 2.04	Operating instructions
Article 2.05	Installation and operating tests
Chapter 3:	Minimum operational requirements for radar equipment
Article 3.01	Operational readiness of radar equipment
Article 3.02	Resolution
Article 3.03	Range scales
Article 3.04	Variable range marker
Article 3.05	Lubber line
Article 3.06	Off-centring
Article 3.07	Bearing scale
Article 3.08	Bearing facilities
Article 3.09	Facilities for reducing sea and rain clutter
Article 3.10	Reduction of interference from other radar equipment
Article 3.11	Compatibility with radar beacons
Article 3.12	Gain control
Article 3.13	Frequency tuning
Article 3.14	Nautical orientation lines and information on the screen
Article 3.15	System sensitivity
Article 3.16	Target trail
Article 3.17	Slave indicators
Chapter 4:	Minimum technical requirements for radar equipment
Article 4.01	Operation
Article 4.02	Display
Article 4.03	Radar picture characteristics
Article 4.04	Colour of the display
Article 4.05	Picture refreshment rate and persistence
Article 4.06	Display linearity
Article 4.07	Accuracy of range and azimuthal measurements
Article 4.08	Antenna characteristics and emission spectrum
Chapter 5	Test conditions and test methods for radar equipment
Article 5.01	Safety, load capacity and interference diffusion
Article 5.02	Spurious emissions and electromagnetic compatibility
Article 5.03	Test procedure
Article 5.04	Antenna measurements
Appendix 1	Angular resolution in ranges up to and including 1 200 m
Appendix 2	Test field for determination of the resolution of radar equipment

## CHAPTER 1

## GENERAL

*Article 1.01***Scope**

These provisions set out the minimum technical and operational requirements for radar equipment used for navigation in inland waterway vessels as well as the conditions for testing conformity with these minimum requirements. Inland ECDIS equipment that can be used in navigation mode counts as navigational radar equipment within the meaning of these provisions.



**▼B***Article 1.02***Purpose of the radar equipment**

The radar equipment shall facilitate the navigation of the vessel by providing an intelligible radar picture of its position in relation to buoys, shorelines and navigational structures, as well as permitting the reliable and timely recognition of other vessels and obstructions protruding above the water surface.

*Article 1.03***Approval testing**

Radar equipment may not be installed on board vessels until it has been established by means of a type test that the equipment meets the minimum requirements laid down in these provisions.

*Article 1.04***Application for approval testing**

1. Applications for a type-test of radar equipment shall be submitted to a competent testing authority in one of the Member States.

The competent testing authorities shall be made known to the Committee.

2. Each application shall be accompanied by the following documents:

- (a) two copies of a detailed technical description;
- (b) two complete sets of installation and service documents;
- (c) two copies of a detailed operator's manual; and
- (d) two copies of a summarised operator's manual.

3. By means of tests, the applicant shall establish or have it established that the radar equipment meets the minimum requirements of these provisions.

The results of the test and the measurement reports on the horizontal and vertical radiation pattern of the antenna shall be attached to the application.

These documents and the information obtained during testing shall be kept by the competent testing authority.

4. For approval testing purposes, 'applicant' means any legal or natural person under whose name, trademark or any other form of identification the equipment submitted for testing is manufactured or marketed.

*Article 1.05***Type-approval**

1. If the equipment passes the type test, the competent testing authority shall issue a certificate of conformity.

If the equipment fails to meet the minimum requirements, the applicant shall be notified in writing of the reasons for its rejection.

Approval shall be granted by the competent authority.

The competent authority shall inform the Committee of the equipment it has approved.

2. Each testing authority shall be entitled to select equipment from the production series at any time for inspection.

If this inspection reveals defects in the equipment, type-approval may be withdrawn.

The type-approval shall be withdrawn by the authority that issued it.

3. The type-approval shall be valid for a period of 10 years and may be renewed on request.

**▼ B***Article 1.06***Marking of the equipment and approval number**

1. Each component of the equipment shall be marked indelibly with the name of the manufacturer, the trade designation of the equipment, the type of equipment and the serial number.
2. The approval number assigned by the competent authority shall be affixed indelibly to the display unit in such a way that it remains clearly visible after the equipment has been installed.

Composition of an approval number:

e-NN-NNN

(e = European Union

NN = code for the country of approval, where

1 = Germany

2 = France

3 = Italy

4 = Netherlands

5 = Sweden

6 = Belgium

7 = Hungary

8 = Czech Republic

9 = Spain

11 = United Kingdom

12 = Austria

13 = Luxembourg

17 = Finland

18 = Denmark

**▼ M2**

19 = Romania

**▼ B**

20 = Poland

21 = Portugal

23 = Greece

24 = Ireland

26 = Slovenia

27 = Slovakia

29 = Estonia

32 = Latvia

**▼ M2**

34 = Bulgaria

**▼ B**

36 = Lithuania

49 = Cyprus

50 = Malta

NNN = three-digit number, to be determined by the competent authority).

3. The approval number shall be used only in conjunction with the associated approval.

It shall be the responsibility of the applicant to produce and affix the approval number.

**▼B**

4. The competent authority shall immediately inform the Committee of the approval number assigned.

*Article 1.07***Manufacturer's declaration**

Each unit of equipment shall be accompanied by a manufacturer's declaration to the effect that it meets the prevailing minimum requirements and that is identical in every respect to the equipment submitted for testing.

*Article 1.08***Modifications to approved equipment**

1. Any modification made to equipment already approved shall cause the type-approval to be withdrawn. Whenever modifications are planned, details shall be sent in writing to the competent testing authority.
2. The competent testing authority shall decide whether the approval still applies or whether an inspection or new type-test is necessary.

If a new approval is granted, a new approval number shall be assigned.

## CHAPTER 2

**GENERAL MINIMUM REQUIREMENTS FOR RADAR EQUIPMENT***Article 2.01***Construction, design**

1. Radar equipment shall be suitable for operation on board inland waterway vessels.
2. The construction and design of the equipment shall be in accordance with the state of the art, both mechanically and electrically.
3. In the absence of any specific provision in Annex II to this Directive or in these provisions, the requirements and test methods contained in IEC publication 945 'Marine Navigational Equipment General Requirements' shall apply to power supply, safety, mutual interference of shipborne equipment, compass safe distance, resistance to climatic influences, mechanical strength, environmental influences, audible noise emission and equipment markings.

Additionally, the requirements of the ITU Radio Regulations shall apply. The equipment shall satisfy all requirements of these provisions for radar display ambient temperatures between 0 and 40 °C.

*Article 2.02***Spurious emissions and electromagnetic compatibility**

1. In the frequency range of 30 to 2 000 MHz, the field strength of spurious emissions shall not exceed 500 µV/m.

In the frequency ranges of 156 to 165 MHz, 450 to 470 MHz and 1,53 to 1,544 GHz the field strength shall not exceed a value of 15 µV/m. These field strengths shall apply at a test distance of 3 metres from the equipment under test.

2. The equipment shall satisfy the minimum requirements at electromagnetic field strengths of up to 15 V/m in the immediate vicinity of the equipment under test in the frequency range of 30 to 2 000 MHz.

**▼B***Article 2.03***Operation**

1. The equipment shall not have more controls than are necessary for its correct operation.

The design, markings and manipulation of the controls shall be such as to permit their simple, unambiguous and fast operation. Their arrangement shall be such as to prevent operating mistakes as far as possible.

Controls not necessary for normal operation shall not be immediately accessible.

2. All controls and indicators shall be provided with symbols and/or markings in English. Symbols shall meet the requirements of IMO Recommendation No A.278 (VIII) 'Symbols for controls on marine navigational radar equipment' or the requirements contained in IEC publication No 417; all numerals and letters shall be at least 4 mm high.

If it can be demonstrated that, for technical reasons, numerals and letters 4 mm high are not possible and if for the purposes of operation smaller numerals and letters are acceptable, a reduction to 3 mm shall be allowed.

3. The equipment shall be designed in such a way that operating mistakes cannot cause its failure.
4. Any functions over and above the minimum requirements, such as facilities for connection to other equipment, shall be provided in such a way that the equipment meets the minimum requirements under all conditions.

*Article 2.04***Operating instructions**

1. A detailed operator's manual shall be supplied with each unit. It shall be available in Dutch, English, French and German and shall contain at least the following information:
  - (a) activation and operation;
  - (b) maintenance and servicing;
  - (c) general safety instructions (health hazards, e.g. the influencing of pace-makers, etc. by electromagnetic radiation);
  - (d) instructions for correct technical installation.
2. A summarised operator's manual in a durable form shall be supplied with each unit.

It shall be available in Dutch, English, French and German.

*Article 2.05***Installation and operating tests**

Installation, replacement and operating tests shall be in accordance with the requirements of Part V.

## CHAPTER 3

**MINIMUM OPERATIONAL REQUIREMENTS FOR RADAR EQUIPMENT***Article 3.01***Operational readiness of radar equipment**

1. From a cold start, radar equipment shall be fully operational within four minutes. After this period, it shall be possible to interrupt and activate transmission instantaneously.

**▼B**

2. It shall be possible for a single person to operate the radar equipment and watch the display simultaneously.

If the control panel is a separate unit, it shall contain all controls used directly for radar navigation.

Cordless remote controls shall not be permitted.

3. It shall be possible to read the display also when there is considerable ambient brightness. When necessary, appropriate vision aids shall be available and shall be attachable and removable simply and easily.

Vision aids shall be usable by wearers of spectacles.

*Article 3.02***Resolution**

1. Angular resolution

Angular resolution is related to range scale and distance. The required minimum resolution for shorter ranges up to and including 1 200 m is shown in Appendix 1.

Minimum resolution is understood to be the minimum azimuthal distance between two standard reflectors (see Article 5.03(2)) at which they are shown clearly separated on the radar picture.

2. Minimum range and range resolution

At all distances between 15 and 1 200 m in range scales up to and including 1 200 m, standard reflectors located 15 m apart on the same bearing shall be shown clearly separated on the radar screen.

3. Functions that can cause a deterioration of resolution shall not be switchable in range scales up to 2 000 m.

*Article 3.03***Range scales**

1. The radar equipment shall be provided with the following sequentially-switchable range scales and circles:

Range scale 1	500 m one circle every 100 m
Range scale 2	800 m one circle every 200 m
Range scale 3	1 200 m one circle every 200 m
Range scale 4	1 600 m one circle every 400 m
Range scale 5	2 000 m one circle every 400 m

2. Further sequentially-switchable range scales shall be permitted.
3. The selected range scale, the distance between range circles and the distance of the variable range marker shall be indicated in metres or kilometres.
4. The width of the range circles and the variable range marker shall, at the normal brightness setting, not exceed 2 mm.
5. Subsector display and enlargements shall not be permitted.

*Article 3.04***Variable range marker**

1. The radar equipment shall have a variable range marker.
2. Within eight seconds, it shall be possible to set the range marker to any distance.
3. The distance at which the variable range marker is set shall not change even after switchover to other range scales.
4. The range shall be displayed as a three- or four-digit number.

The accuracy for ranges up to 2 000 m shall be within 10 metres. The radius of the range marker shall correspond to the digital display.

**▼B***Article 3.05***Lubber line**

1. A lubber line shall extend from the position on the radar display that corresponds to the antenna position up to the edge of the radar screen.
2. The width of the lubber line at the edge of the screen shall not be more than 0,5°.
3. The radar unit shall have an adjusting device for correcting any azimuthal angular error in the antenna mounting.
4. Following correction of the angular error and activation of the radar unit, the deviation of the lubber line from the keel line shall not exceed 0,5°.

*Article 3.06***Off-centring**

1. To permit an extended forward view, off-centring of the radar picture shall be possible at all the range scales specified in Article 3.03(1).

Off-centring shall result exclusively in an extension of the forward view and shall be adjustable to at least 0,25, and at most 0,33, of the effective screen diameter.

2. In the range with extended forward view, the range circles shall be extended and the variable range marker shall be adjustable and readable up to the maximum of the displayed range.
3. A fixed forward extension of the range displayed in accordance with paragraph 1 is permitted provided that, for the central part of the picture, the effective diameter is not less than that specified in Article 4.03(1), and that the bearing scale is designed in such a way that a bearing can be taken in accordance with Article 3.08.

In that case the off-centring facility referred to in paragraph 1 shall not be required.

*Article 3.07***Bearing scale**

1. The radar equipment shall have a bearing scale at the edge of the screen.
2. The bearing scale shall be divided into at least 72 parts each representing 5 degrees. The graduation marks representing 10 degrees must be clearly longer than those representing 5 degrees.

The 000 mark on the bearing scale shall be positioned in the middle of the upper edge of the screen.

3. The bearing scale shall be marked in three-figure numbers from 000 to 360 degrees in a clockwise direction. Numbering shall be in Arabic numerals every 10 or every 30 degrees.

The figure 000 may be replaced by a clearly visible arrow.

*Article 3.08***Bearing facilities**

1. Facilities for taking bearings of targets shall be allowed.
2. If such facilities are provided, they shall be capable of taking a bearing of any target within approximately 5 seconds, with a maximum error of  $\pm 1$  degree.
3. If an electronic bearing line is used, it shall:
  - (a) be clearly distinguishable from the lubber line;
  - (b) be displayed quasi-continuously;
  - (c) be freely rotatable through 360 degrees left and right;
  - (d) be at most 0,5 degrees wide at the edge of the screen;
  - (e) extend from origin up to the bearing scale;

**▼B**

- (f) and complete a three- or four-figure decimal degree reading.
4. If a mechanical bearing line is used, it shall:
- (a) be freely rotatable through 360 degrees left and right;
  - (b) extend from the marked origin to the bearing scale;
  - (c) bear no further markings; and
  - (d) be designed in such a way that echo readings are not obscured unnecessarily.

*Article 3.09***Facilities for reducing sea and rain clutter**

1. The radar equipment shall have facilities with manual controls for reducing clutter from sea and rain.
2. The sea-clutter control (sensitivity time control — STC) shall, at its maximum setting, be effective up to a distance of approximately 1 200 m.
3. The radar equipment shall not be provided with automatic facilities for reducing sea and rain clutter.

*Article 3.10***Reduction of interference from other radar equipment**

1. There shall be a switchable facility for the reduction of interference caused by other radar equipment.
2. The operation of this facility shall not suppress the display of useful targets.

*Article 3.11***Compatibility with radar beacons**

Signals from radar beacons in accordance with IMO resolution A.423 (XI) shall be displayed clearly with the rain clutter suppression (fast time constant — FTC) switched off.

*Article 3.12***Gain control**

The range of the gain control shall be such that, at minimum sea-clutter suppression setting, surface movement of the water is clearly visible and that powerful radar echoes with an echo area equivalent to 10 000 m<sup>2</sup> may be cut out at any distance.

*Article 3.13***Frequency tuning**

The display unit shall be provided with a tuning indicator. The tuning scale shall have a length of at least 30 mm. The indicator shall function in all ranges, even without radar echoes. The indicator shall function equally well when the gain or suppression of close proximity echoes is activated.

A manual control to correct the tuning shall be available.

*Article 3.14***Nautical orientation lines and information on the screen**

1. Only the lubber line, bearing lines and range circles may be superimposed on the radar screen.
2. Apart from the radar picture and in addition to information on the operation of the radar equipment, only nautical information such as that listed below may be displayed:
  - (a) rate of turn;

**▼B**

- (b) speed of the vessel;
  - (c) rudder position;
  - (d) water depth;
  - (e) compass course.
3. All screen information besides the radar picture shall be displayed quasi-statically and the refreshing rate shall satisfy the operational requirements.
  4. The requirements regarding the display and accuracy of nautical information shall be the same as those applicable to the main equipment.

*Article 3.15***System sensitivity**

The system sensitivity shall be such that a standard reflector at a distance of 1 200 m appears clearly on the radar picture on every revolution of the antenna. In the case of a 1 m<sup>2</sup> reflector at the same distance, the quotient of the number of antenna revolutions with radar echo during a specific period and the total number of antenna revolutions in that same period based on 100 revolutions (blip-scan rate) shall not be less than 0,8.

*Article 3.16***Target trail**

Previous positions of targets shall be shown by means of a trail.

The representation of the target trail shall be quasi-continuous and the brightness shall be less than that of the associated target; the target trail and the radar picture shall have the same colour. The persistence of the trail shall be adjustable to operational requirements, but shall not last longer than 2 antenna revolutions.

The target trail shall not impair the radar picture.

*Article 3.17***Slave indicators**

Slave indicators shall comply with all requirements applicable to navigational radar equipment.

## CHAPTER 4

**MINIMUM TECHNICAL REQUIREMENTS FOR RADAR EQUIPMENT***Article 4.01***Operation**

1. All controls shall be so arranged that during their operation no information is concealed from view and radar navigation remains unimpaired.
2. Controls which can be used to switch off the equipment or, if activated, could lead to a malfunction must be protected against accidental operation.
3. All controls and indicators shall be provided with a dazzle-free source of lighting appropriate for all ambient lighting conditions and adjustable down to zero by means of an independent control.
4. The following functions must have their own controls with direct access:
  - (a) Stand-by/on;
  - (b) Range;
  - (c) Tuning;
  - (d) Gain;
  - (e) Seaclutter (STC);
  - (f) Rainclutter (FTC);



**▼B**

- (g) Variable range marker (VRM);
- (h) Cursor or electronic bearing line (EBL) (if fitted);
- (i) Ship's heading marker suppression (SHM).

If rotary controls are used for the abovementioned functions, concentric arrangement of the controls one above the other shall be prohibited.

5. At least the controls for gain, sea clutter and rain clutter must be adjustable by means of a rotary control with an effect proportional to the angle of rotation.
6. Adjustment of controls shall be such that movements to the right or upwards have a positive effect on the variable and movements to the left or downwards a negative effect.
7. If push-buttons are used, it shall be possible to locate and operate them by touch. They shall also have clearly perceptible contact release.
8. It must be possible to adjust the brightness of the following variables separately from zero to the value required for operational purposes:
  - (a) radar picture;
  - (b) fixed range circles;
  - (c) variable range circles;
  - (d) bearing scale;
  - (e) bearing line;
  - (f) nautical information as specified in Article 3.14(2).
9. Provided that the difference in brightness of some of the displayed values is only slight and the fixed range circle, the variable range circle and the bearing line can be switched off independently of each other, there may be four brightness controls, one for each of the following groups of values:
  - (a) radar picture and lubber line;
  - (b) fixed range circles;
  - (c) variable range circles;
  - (d) bearing line and bearing scale and nautical information as specified in Article 3.14(2).
10. The brightness of the lubber line shall be adjustable but shall not be reducible to zero.
11. To switch off the lubber line, there shall be a control with automatic reset.
12. From zero, the anti-clutter devices shall be continuously adjustable.

*Article 4.02***Display**

1. 'Radar picture' means the scaled representation of radar echoes of the surroundings and their motion relative to the vessel on the display unit's screen from one antenna revolution with the vessel's keel line and the lubber line coinciding at all times.
2. 'Display unit' means that part of the equipment that contains the screen.
3. 'Screen' means the low-reflection part of the display unit on which either the radar picture alone, or the radar picture together with additional nautical information, is shown.
4. 'Effective diameter of the radar picture' means the diameter of the largest completely circular radar picture which can be shown within the bearing scale.
5. 'Raster scan representation' means the quasi-static representation of the radar picture from a complete revolution of the antenna, in the form of a television picture.



*Article 4.03*

**Radar picture characteristics**

1. The effective diameter of the radar picture shall be not less than 270 mm.
2. The diameter of the outer range circle in the range scales specified in Article 3.03 shall be at least 90 % of the effective radar picture diameter.
3. For all range scales, the antenna position shall be visible in the radar picture.

*Article 4.04*

**Colour of the display**

The display colour shall be chosen on the basis of physiological factors. If various colours can be reproduced on the screen, the actual radar picture shall be monochrome. The reproduction of different colours shall not result in mixed colours, by superimposition, on any part of the screen.

*Article 4.05*

**Picture refreshment rate and persistence**

1. The radar picture shown by the display shall be replaced by the up-to-date radar picture within 2,5 seconds.
2. Each echo on the screen shall persist for at least the duration of one antenna revolution, but not longer than two antenna revolutions.

The persistence of the radar picture may be achieved in two fashions: either by a continuous display or by periodical picture refreshment. This periodical picture refreshment shall be effected at not less than 50 Hz.

3. The difference in brightness between the writing of an echo and its afterglow during one antenna revolution shall be as small as possible.

*Article 4.06*

**Display linearity**

1. The linearity error of the radar picture shall not exceed 5 %.
2. In all ranges up to 2 000 m a fixed straight shore line at a distance of 30 m from the radar antenna shall be displayed as a straight continuous echo structure without observable distortions.

*Article 4.07*

**Accuracy of range and azimuthal measurements**

1. The determination of the distance to a target by means of variable or fixed range circles shall be accurate to  $\pm 10$  m or  $\pm 1,5$  %, whichever is the larger.
2. The angular value of the bearing of an object shall not differ by more than 1 degree from the real value.

*Article 4.08*

**Antenna characteristics and emission spectrum**

1. The antenna drive system and the antenna shall be such as to allow correct operation at wind speeds of up to 100 km per hour.
2. The antenna drive system shall have a safety switch by means of which the transmitter and the rotator drive can be switched off.
3. The horizontal radiation pattern of the antenna, measured in one direction, shall meet the following requirements:
  - (a) - 3 dB, width of the main lobe: maximum 1,2 degrees;
  - (b) - 20 dB, width of the main lobe: maximum 3,0 degrees;
  - (c) side-lobe attenuation within  $\pm 10$  degrees around the main lobe: at least — 25 dB;

**▼B**

- (d) side-lobe attenuation outside  $\pm 10$  degrees around the main lobe: at least — 32 dB.
- 4. The vertical radiation pattern of the antenna, measured in one direction, shall meet the following requirements:
  - (a) - 3 dB, width of the main lobe: maximum 30 degrees;
  - (b) the maximum of the main lobe shall be in the horizontal axis;
  - (c) side-lobe attenuation: at least — 25 dB.
- 5. The radiated high-frequency energy shall be horizontally polarised.
- 6. The operating frequency of the equipment shall be in a range above 9 GHz which is allocated under prevailing ITU Radio Regulations to navigational radar equipment.
- 7. The frequency spectrum of the high-frequency energy radiated by the antenna shall be in conformity with ITU Radio Regulations.

## CHAPTER 5

## TEST CONDITIONS AND TEST METHODS FOR RADAR EQUIPMENT

*Article 5.01***Safety, load capacity and interference diffusion**

Power supply, safety, mutual interference of shipborne equipment, compass safe distance, resistance to climatic influences, mechanical strength, environmental impact and audible noise emission shall be tested in accordance with IEC publication 945 'Marine Navigational Equipment General Requirements'.

*Article 5.02***Spurious emissions and electromagnetic compatibility**

1. Spurious emissions shall be measured in accordance with IEC publication 945 'Marine Navigational Equipment Interference' in the frequency range of 30 to 2 000 MHz.

The requirements of Article 2.02(1) shall be met.

2. The electromagnetic compatibility requirements of Article 2.02(2) shall be met.

*Article 5.03***Test procedure**

1. The test field shown in Appendix 2 for the testing of radar equipment shall be arranged on a calm water surface at least 1,5 km long and 0,3 km wide, or on terrain with equivalent reflection properties.
2. A standard reflector shall be a radar reflector which, at a wavelength of 3,2 cm, has an equivalent radar cross-section of 10 m<sup>2</sup>.

The equivalent radar cross-section ( $\sigma$ ) of a three-axis radar reflector with triangular surfaces for a frequency of 9 GHz (3,2 cm) shall be calculated according to the following formula:

$$\sigma = \frac{4 \cdot \pi \cdot a^4}{3 \cdot 0,032^2}$$

a = edge length in m

For a standard reflector with triangular surfaces, the edge length a = 0,222 m.

The dimensions of the reflectors used for the testing of range and discrimination at a wavelength of 3,2 cm shall also be used when the radar equipment under test has a wavelength other than 3,2 cm.

3. Standard reflectors shall be set up at distances of 15 m, 30 m, 45 m, 60 m, 85 m, 300 m, 800 m, 1 170 m, 1 185 m and 1 200 m from the antenna position.

**▼B**

Beside the standard reflector at 85 m, standard reflectors shall be set up at a distance of 5 m on both sides, at right angles to the bearing line.

Beside the standard reflector at 300 m, a reflector with an equivalent radar cross-section of 300 m<sup>2</sup> shall be set up at a distance of 18 m, at right angles to the bearing line.

Further reflectors with an equivalent radar cross-section of 1 m<sup>2</sup> and 1 000 m<sup>2</sup> shall be set up at an azimuthal angle to each other of at least 15 degrees, at the same distance of 300 m from the antenna.

Beside the standard reflector at 1 200 m, standard reflectors and a reflector with a radar cross-section of 1 m<sup>2</sup> shall be set up at a distance of 30 m on both sides, at right angles to the bearing line.

4. The radar equipment shall be adjusted to the best quality of picture. The gain must be adjusted in such a way that, in the area immediately beyond the range of operation of the anti-clutter control, noise can no longer be seen.

The sea-clutter suppression control (STC) shall be set at minimum, while the rain-clutter suppression control (FTC) shall be switched off.

All controls that influence picture quality shall be left unchanged for the duration of the test at a specific antenna height and be fixed in an appropriate way.

5. The antenna shall be set up at any desired height between 5 and 10 m above the surface of the water or the ground. The reflectors shall be set up at such a height above the surface of the water or of the ground that their effective radar return corresponds to the value specified in paragraph 2.

6. All reflectors set up within the selected range shall, at all distances up to and including 1 200 m, be shown on the screen simultaneously as clearly separated targets, regardless of the azimuthal position of the test field in relation to the lubber line.

Signals from radar beacons as described in Article 3.11 shall be displayed clearly.

All requirements specified in these provisions shall be met at any antenna height between 5 and 10 m, with only essential adjustments of the controls being authorised.

*Article 5.04***Antenna measurements**

The antenna characteristics shall be measured in accordance with IEC publication 936 'Shipborne Radar'.

*Appendix 1***Angular resolution in ranges up to and including 1 200 m***Appendix 2***Test field for determination of the resolution of radar equipment**

## PART IV

**MINIMUM REQUIREMENTS AND TEST CONDITIONS FOR RATE-OF-TURN INDICATORS USED IN INLAND WATERWAY VESSELS**

## CONTENTS

Chapter 1:	General
Article 1.01	Scope
Article 1.02	Purpose of the rate-of-turn indicator
Article 1.03	Approval testing

**▼B**

Article 1.04	Application for approval testing
Article 1.05	Type-approval
Article 1.06	Marking of the equipment and approval number
Article 1.07	Manufacturer's declaration
Article 1.08	Modifications to approved equipment
Chapter 2:	General minimum requirements for rate-of-turn indicators
Article 2.01	Construction, design
Article 2.02	Spurious emissions and electromagnetic compatibility
Article 2.03	Operation
Article 2.04	Operating instructions
Article 2.05	Installation and operating tests
Chapter 3:	Minimum operational requirements for rate-of-turn indicators
Article 3.01	Operational readiness of the rate-of-turn indicator
Article 3.02	Indication of the rate of turn
Article 3.03	Measuring ranges
Article 3.04	Accuracy of the indicated rate of turn
Article 3.05	Sensitivity
Article 3.06	Monitoring of operation
Article 3.07	Insensitivity to other normal movements of the vessel
Article 3.08	Insensitivity to magnetic fields
Article 3.09	Slave indicators
Chapter 4:	Minimum technical requirements for rate-of-turn indicators
Article 4.01	Operation
Article 4.02	Damping devices
Article 4.03	Connection of additional equipment
Chapter 5:	Test conditions and procedures for rate-of-turn indicators
Article 5.01	Safety, load capacity and interference diffusion
Article 5.02	Spurious emissions and electromagnetic compatibility
Article 5.03	Test procedure
Appendix:	Maximum tolerances for indication errors of rate-of-turn indicators

**CHAPTER 1****GENERAL***Article 1.01***Scope**

These provisions set out the minimum technical and operational requirements for rate-of-turn indicators used in inland waterway vessels, as well as the conditions for testing conformity with these minimum requirements.

*Article 1.02***Purpose of the rate-of-turn indicator**

The rate-of-turn indicator is intended to facilitate radar navigation, and to measure and indicate the rate of turn of the vessel to port or starboard.

**▼B***Article 1.03***Approval testing**

Rate-of-turn indicators may not be installed on board vessels until it has been established by means of a type test that they meet the minimum requirements laid down in these provisions.

*Article 1.04***Application for approval testing**

1. Applications for a type-test of rate-of-turn indicators shall be submitted to a competent testing authority in one of the Member States.

The competent testing authorities shall be made known to the Committee.

2. Each application shall be accompanied by the following documents:

- (a) two copies of a detailed technical description;
- (b) two complete sets of installation and service documents;
- (c) two copies of an operator's manual.

3. By means of tests, the applicant shall establish or have it established that the radar equipment meets the minimum requirements of these provisions.

The results of the test and the measurement reports shall be attached to the application.

These documents and the information obtained during testing shall be kept by the competent testing authority.

4. For approval testing purposes, 'applicant' means any legal or natural person under whose name, trademark or any other form of identification the equipment submitted for testing is manufactured or marketed.

*Article 1.05***Type-approval**

1. If the equipment passes the type test, the competent testing authority shall issue a certificate of conformity.

If the equipment fails to meet the minimum requirements, the applicant shall be notified in writing of the reasons for its rejection.

Approval shall be granted by the competent authority.

The competent authority shall inform the Committee of the equipment it has approved.

2. Each testing authority shall be entitled to select equipment from the production series at any time for inspection.

If this inspection reveals defects in the equipment, type-approval may be withdrawn.

The type-approval shall be withdrawn by the authority that issued it.

3. The type-approval shall be valid for a period of 10 years and may be renewed on request.

*Article 1.06***Marking of the equipment and approval number**

1. Each component of the equipment shall be marked indelibly with the name of the manufacturer, the trade designation of the equipment, the type of equipment and the serial number.
2. The approval number assigned by the competent authority shall be affixed indelibly to the control unit in such a way that it remains clearly visible after the equipment has been installed.

**▼ B**

Composition of an approval number:

e-NN-NNN

(e = European Union

NN = code for the country of approval, where

1 = Germany

2 = France

3 = Italy

4 = Netherlands

5 = Sweden

6 = Belgium

7 = Hungary

8 = Czech Republic

9 = Spain

11 = United Kingdom

12 = Austria

13 = Luxembourg

17 = Finland

18 = Denmark

**▼ M2**

19 = Romania

**▼ B**

20 = Poland

21 = Portugal

23 = Greece

24 = Ireland

26 = Slovenia

27 = Slovakia

29 = Estonia

32 = Latvia

**▼ M2**

34 = Bulgaria

**▼ B**

36 = Lithuania

49 = Cyprus

50 = Malta

NNN = three-digit number, to be determined by the competent authority).

3. The approval number shall be used only in conjunction with the associated approval.

It shall be the responsibility of the applicant to produce and affix the approval number.

4. The competent authority shall immediately inform the Committee of the approval number assigned.

*Article 1.07*

**Manufacturer's declaration**

Each unit of equipment shall be accompanied by a manufacturer's declaration to the effect that it meets the prevailing minimum requirements and that is identical in every respect to the equipment submitted for testing.

**▼B***Article 1.08***Modifications to approved equipment**

1. Any modification made to equipment already approved shall cause the type-approval to be withdrawn.

Whenever modifications are planned, details shall be sent in writing to the competent testing authority.

2. The competent testing authority shall decide whether the approval still applies or whether an inspection or new type-test is necessary. If a new approval is granted, a new approval number shall be assigned.

## CHAPTER 2

**GENERAL MINIMUM REQUIREMENTS FOR RATE-OF-TURN INDICATORS***Article 2.01***Construction, design**

1. Rate-of-turn indicators shall be suitable for operation on board inland waterway vessels.
2. The construction and design of the equipment shall be in accordance with the state of the art, both mechanically and electrically.
3. In the absence of any specific provision in Annex II to this Directive or in these provisions, the requirements and test methods contained in IEC publication 945 'Marine Navigational Equipment General Requirements' shall apply to power supply, safety, mutual interference of shipborne equipment, compass safe distance, resistance to climatic influences, mechanical strength, environmental influences, audible noise emission and equipment markings.

Additionally, the equipment shall satisfy all requirements of these provisions at ambient temperatures between 0 and 40 °C.

*Article 2.02***Spurious emissions and electromagnetic compatibility**

1. In the frequency range of 30 to 2000 MHz, the field strength of spurious emissions shall not exceed 500 µV/m.

In the frequency ranges of 156 to 165 MHz, 450 to 470 MHz and 1,53 to 1,544 GHz the field strength shall not exceed a value of 15 µV/m. These field strengths shall apply at a test distance of 3 metres from the equipment under test.

2. The equipment shall satisfy the minimum requirements at electromagnetic field strengths of up to 15 V/m in the immediate vicinity of the equipment under test in the frequency range of 30 to 2 000 MHz.

*Article 2.03***Operation**

1. The equipment shall not have more controls than are necessary for its correct operation.

The design, markings and manipulation of the controls shall be such as to permit their simple, unambiguous and fast operation. Their arrangement shall be such as to prevent operating mistakes as far as possible.

Controls not necessary for normal operation shall not be immediately accessible.

2. All controls and indicators shall be provided with symbols and/or markings in English. Symbols shall meet the requirements contained in IEC publication No 417.

All numerals and letters shall be at least 4 mm high. If it can be demonstrated that, for technical reasons, numerals and letters 4 mm high are not possible



**▼B**

and if for the purposes of operation smaller numerals and letters are acceptable, a reduction to 3 mm shall be allowed.

3. The equipment shall be designed in such a way that operating mistakes cannot cause its failure.
4. Any functions over and above the minimum requirements, such as facilities for connection to other equipment, shall be provided in such a way that the equipment meets the minimum requirements under all conditions.

*Article 2.04***Operating instructions**

A detailed operator's manual shall be supplied with each unit. It shall be available in Dutch, English, French and German and shall contain at least the following information:

- (a) activation and operation;
- (b) maintenance and servicing;
- (c) general safety instructions.

*Article 2.05***Installation and operating tests**

1. Installation, replacement and operating tests shall be in accordance with the requirements of Part V.
2. The direction of installation in relation to the keel line shall be indicated on the rate-of-turn indicator's sensor unit. Installation instructions to ensure maximum insensitivity to other normal movements of the vessel shall be provided.

## CHAPTER 3

**MINIMUM OPERATIONAL REQUIREMENTS FOR RATE-OF-TURN INDICATORS***Article 3.01***Operational readiness of the rate-of-turn indicator**

1. From a cold start, the rate-of-turn indicator shall be fully operational within four minutes and shall operate to within the required accuracy tolerances.
2. A warning signal shall indicate that the indicator is switched on. It shall be possible to observe and operate the rate-of-turn indicator simultaneously.
3. Cordless remote controls shall not be permitted.

*Article 3.02***Indication of the rate of turn**

1. The rate of turn shall be indicated on a linear graduated scale having the zero point situated in the middle. It shall be possible to read the direction and extent of the rate of turn with the necessary accuracy. Needle indicators and bar-graphs shall be permitted.
2. The indicator scale shall be at least 20 cm long and may be circular or rectilinear.  
Rectilinear scales may be arranged horizontally only.
3. Solely digital indicators shall not be permitted.

*Article 3.03***Measuring ranges**

Rate-of-turn indicators may be provided with one or more measuring ranges. The following measuring ranges are recommended:

**▼B**

30°/minute  
 60°/minute  
 90°/minute  
 180°/minute  
 300°/minute.

*Article 3.04***Accuracy of the indicated rate of turn**

The indicated rate of turn shall not differ by more than 2 % from the measurable maximum value or by more than 10 % from the actual value, whichever is the greater (see Appendix).

*Article 3.05***Sensitivity**

The operating threshold shall be less than or equal to a change in angular speed equivalent to 1 % of the indicated value.

*Article 3.06***Monitoring of operation**

1. If the rate-of-turn indicator does not operate within the required accuracy range, this shall be indicated.
2. If a gyroscope is used, any critical fall in the rate of rotation of the gyroscope shall be signalled by an indicator. A critical fall in the rate of rotation of the gyroscope is one which lowers accuracy by 10 %.

*Article 3.07***Insensitivity to other normal movements of the vessel**

1. Rolling of the vessel of up to 10° at a rate of turn of up to 4° per second shall not give rise to measurement errors in excess of the stipulated tolerances.
2. Impacts such as those that may occur during berthing shall not give rise to measurement errors in excess of the stipulated tolerances.

*Article 3.08***Insensitivity to magnetic fields**

The rate-of-turn indicator shall be insensitive to magnetic fields which typically occur on board the vessel.

*Article 3.09***Slave indicators**

Slave indicators shall comply with all requirements applicable to rate-of-turn indicators.

## CHAPTER 4

**MINIMUM TECHNICAL REQUIREMENTS FOR RATE-OF-TURN INDICATORS***Article 4.01***Operation**

1. All controls shall be so arranged that during their operation no information is concealed from view and radar navigation remains unimpaired.

**▼B**

2. All controls and indicators shall be provided with a dazzle-free source of lighting appropriate for all ambient lighting conditions and adjustable down to zero by means of an independent control.
3. Adjustment of controls shall be such that movements to the right or upwards have a positive effect on the variable and movements to the left or downwards a negative effect.
4. If push-buttons are used, it shall be possible to locate and operate them by touch. They shall also have clearly perceptible contact release.

*Article 4.02***Damping devices**

1. The sensor system shall be damped for critical values. The damping constant (63 % of the limit value) shall not exceed 0,4 seconds.

2. The indicator shall be damped for critical values.

Controls for increasing damping shall be permitted.

Under no circumstances may the damping constant exceed five seconds.

*Article 4.03***Connection of additional equipment**

1. If the rate-of-turn indicator can be connected to slave indicators or similar equipment, the rate-of-turn indication shall remain usable as an electric signal.

The rate of turn shall continue to be indicated with galvanic earth insulation and the equivalent to an analogue voltage of 20 mV/degree  $\pm$  5 % and a maximum internal resistance of 100 ohms.

Polarity shall be positive when the vessel is turning to starboard and negative when it is turning to port.

The operating threshold shall not exceed 0,3°/minute.

Zero error shall not exceed 1°/minute at temperatures from 0 to 40°C.

With the indicator switched on and the sensor not exposed to the effects of movement, the spurious voltage at the output signal measured with a 10 Hz pass-band low-pass filter shall not exceed 10 mV.

The rate-of-turn signal shall be received without additional damping beyond the limits referred to in Article 4.02(1).

2. An external alarm switch shall be provided. The switch shall be installed as a galvanic insulation break-switch for the indicator.

The external alarm shall be triggered by contact closure:

- (a) if the rate-of-turn indicator is disconnected; or
- (b) if the rate-of-turn indicator is not in operation; or
- (c) if the operating control has reacted following an excessive error (Article 3.06).

## CHAPTER 5

**TEST CONDITIONS AND PROCEDURES FOR RATE-OF-TURN INDICATORS***Article 5.01***Safety, load capacity and interference diffusion**

Power supply, safety, mutual interference of shipborne equipment, compass safe distance, resistance to climatic influences, mechanical strength, environmental impact and audible noise emission shall be tested in accordance with IEC publication 945 'Marine Navigational Equipment General Requirements'.

**▼ B***Article 5.02***Spurious emissions and electromagnetic compatibility**

1. Spurious emissions shall be measured in accordance with IEC publication 945 'Marine Navigational Equipment Interference' in the frequency range of 30 to 2 000 MHz.

The requirements of Article 2.02(1) shall be met.

2. The electromagnetic compatibility requirements of Article 2.02(2) shall be met.

*Article 5.03***Test procedure**

1. Rate-of-turn indicators shall be brought into operation and tested under nominal and boundary conditions. In this regard, the influence of the operating voltage and of the ambient temperature shall be tested as far as the prescribed limit value.

In addition, radio transmitters shall be used to set up the maximum magnetic fields in the vicinity of the indicators.

2. Under the conditions described in paragraph 1, indicator errors shall remain within the tolerances indicated in the Appendix.

All other requirements shall be met.

▼ B

Appendix

Maximum tolerances for indication errors of rate-of-turn indicators

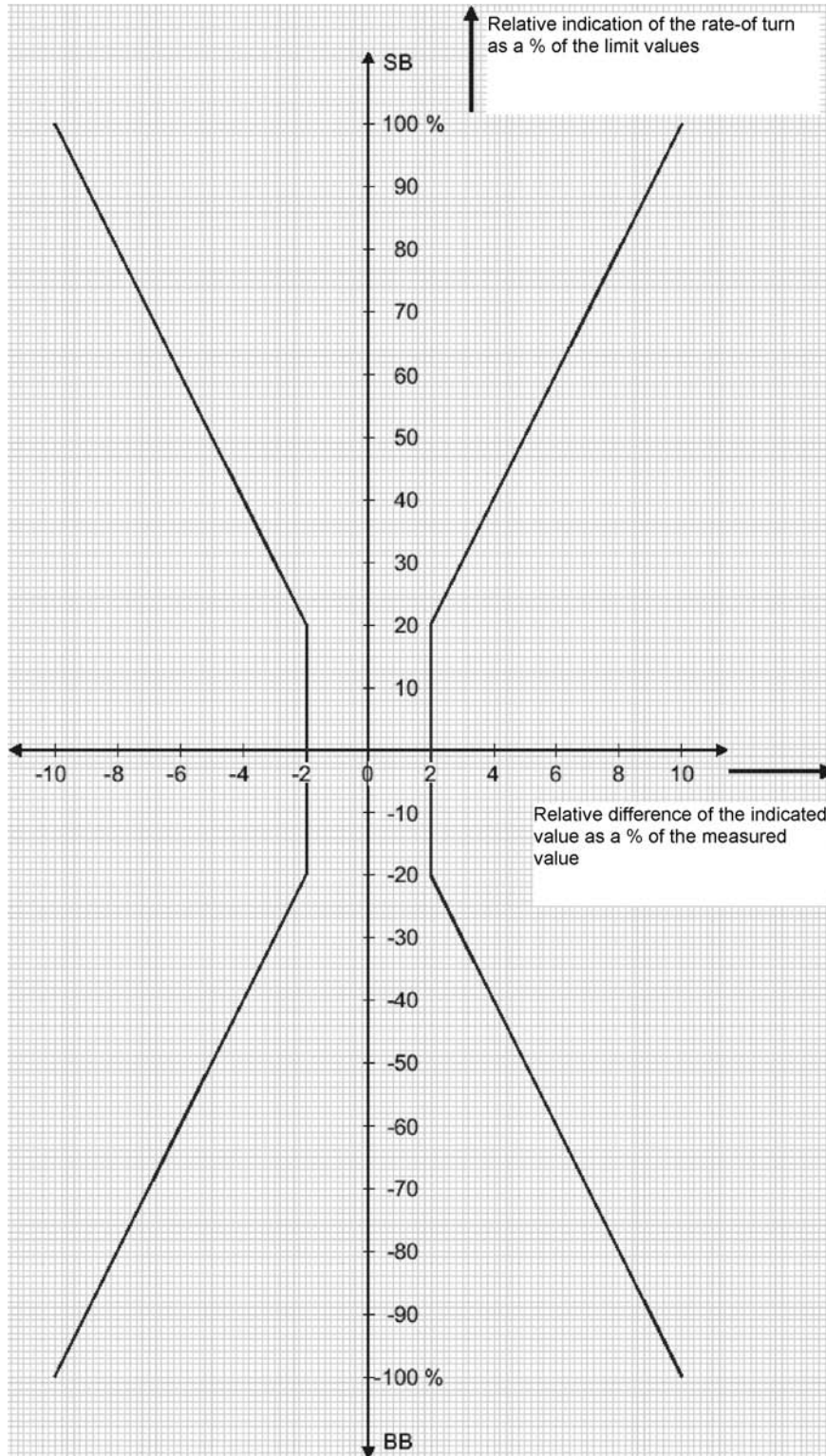



## PART V

**REQUIREMENTS FOR INSTALLATION AND PERFORMANCE TESTS  
FOR RADAR EQUIPMENT AND RATE-OF-TURN INDICATORS USED  
IN INLAND WATERWAY VESSELS**

## CONTENTS

Article 1	Scope
Article 2	Approval of equipment
Article 3	Approved specialised firms
Article 4	Requirements for on-board power supply
Article 5	Installation of the radar antenna
Article 6	Installation of the display unit and the control unit
Article 7	Installation of the rate-of-turn indicator
Article 8	Installation of the position sensor
Article 9	Installation and performance test
Article 10	Installation and performance certificate
Appendix	Model installation and performance certificate for radar equipment and rate-of-turn indicators

*Article 1***Scope**

The purpose of these requirements is to ensure that in the interest of safety and orderly radar navigation on inland waterways in the Community, navigational radar equipment and rate-of-turn indicators are installed according to optimum technical and ergonomic standards and that installation is followed by a performance test. Inland ECDIS equipment that can be used in navigation mode counts as navigational radar equipment within the meaning of these provisions.

*Article 2***Approval of equipment**

For radar navigation on inland waterways in the Community, only equipment approved according to the applicable provisions of this Directive or of the Central Commission for Navigation on the Rhine and bearing an approval number shall be authorised for installation.

*Article 3***Approved specialised firms**

1. The installation, replacement, repair or maintenance of radar equipment and rate-of-turn indicators shall be carried out only by specialised firms approved by the competent authority in accordance with Article 1.
2. Approval may be granted by the competent authority for a limited period and may be withdrawn by the competent authority at any time if the conditions in Article 1 are no longer met.
3. The competent authority shall immediately notify the Committee of the specialised firms which it has approved.

*Article 4***Requirements for on-board power supply**

All power supply leads for radar equipment and rate-of-turn indicators shall have their own separate safety devices and if possible be fail-safe.

**▼B***Article 5***Installation of the radar antenna**

1. The radar antenna shall be installed as close as possible to the fore-and-aft-line. There shall be no obstruction in the vicinity of the antenna causing false echoes or unwanted shadows; if necessary, the antenna shall be mounted on the fore-castle. The mounting and attachment of the radar antenna in its operational position shall be sufficiently stable to enable the radar equipment to perform within the required accuracy limits.
2. After the angular error in the mounting has been corrected and the equipment has been switched on, the difference between lubber line and fore-and-aft-line shall not be greater than 1 degree.

*Article 6***Installation of the display unit and the control unit**

1. The display unit and control unit shall be installed in the wheelhouse in such a way that the evaluation of the radar picture and the operation of the equipment present no difficulty. The azimuthal orientation of the radar picture shall be in accordance with the normal situation of the surroundings. Clamps and adjustable consoles are to be constructed in such a way that they can be locked in any position free of vibration.
2. During radar navigation, artificial lighting shall not be reflected in the direction of the radar operator.
3. When the control unit is not part of the display unit, it shall be located in a housing within 1 metre of the display unit. Cordless remote controls shall not be permitted.
4. If slave indicators are installed, they shall satisfy the requirements which apply to navigational radar equipment.

*Article 7***Installation of the rate-of-turn indicator**

1. The sensor system shall be installed as far as possible amidships, horizontal and aligned with the ship's fore-and-aft-line. The installation site shall as far as possible be free of vibration and be liable to modest temperature variations. The indicator unit shall if possible be installed above the radar display.
2. If slave indicators are installed, they shall satisfy the requirements which apply to rate-of-turn indicators.

*Article 8***Installation of the position sensor**

The position sensor (e.g. DGPS antenna) must be installed in such a way as to ensure that it operates with the greatest possible degree of accuracy and is not adversely affected by superstructures and transmitting equipment on board ship.

*Article 9***Installation and performance test**

Before the equipment is switched on for the first time after installation or after renewals or extensions of the ship's survey certificate (except according to Article 2.09(2) of Annex II) as well as after each modification of the vessel likely to affect the operating conditions of the equipment, an installation and performance test shall be carried out by the competent authority or by a firm authorised in accordance with Article 3. For this purpose, the following conditions shall be fulfilled:

- (a) the power supply shall have a separate safety device;
- (b) the operating voltage shall be within the tolerance (Article 2.01 of Part III);
- (c) the cabling and its installation shall satisfy the provisions of Annex II and, if necessary, the ADN;

**▼B**

- (d) the number of antenna revolutions shall reach at least 24 per minute;
- (e) there shall be no obstruction in the vicinity of the antenna which impairs navigation;
- (f) the safety switch of the antenna shall be in good working order;
- (g) the arrangement of display units, rate-of-turn indicators and control units shall be ergonomic and user-friendly;
- (h) the lubber line of the radar equipment shall not deviate from the ship's fore-and-aft-line by more than 1 degree;
- (i) the accuracy of the range and azimuthal displays shall satisfy the requirements (measurements using known targets);
- (k) linearity in short ranges shall be correct (pushing and pulling);
- (l) the displayed minimum range shall be 15 metres or less;
- (m) the centre of the picture shall be visible and its diameter shall not exceed 1 mm;
- (n) False echoes caused by reflections and unwanted shadows on the lubber line shall not occur or shall not impair the safety of navigation;
- (o) Sea-clutter and rain-clutter suppressors (STC and FTC preset) and the associated controls shall perform correctly;
- (p) the gain adjustment shall be in proper working order;
- (q) focus and picture definition shall be correct;
- (r) the ship's turning direction shall be as indicated on the rate-of-turn indicator and the zero position at dead ahead shall be correct;
- (s) the radar equipment shall not be sensitive to transmissions by the ship's radio equipment or to interference from other on-board sources;
- (t) the radar equipment and/or rate-of-turn indicator shall not interfere with other on-board equipment.

Furthermore, in the case of inland ECDIS equipment:

- (u) the statistical positional error affecting the chart shall not exceed 2 m;
- (v) the statistical phase angle error affecting the chart shall not exceed 1 degree.

*Article 10*

**Installation and performance certificate**

After successful completion of a test in accordance with Article 8, the competent authority or the approved firm shall issue a certificate based on the model in the Appendix. This certificate shall be kept permanently on board.

If the test conditions have not been met, a list of defects shall be drawn up. Any existing certificate shall be withdrawn or sent to the competent authority by the approved firm.



**▼ B**

*Appendix*

MODEL INSTALLATION AND PERFORMANCE CERTIFICATE FOR RADAR EQUIPMENT AND RATE-OF-TURN INDICATORS

Type/Name of vessel: .....

Official registration number of vessel: .....

Vessel's owner

Name: .....

Address: .....

Telephone: .....

Radar appliances ..... Number .....

Order No	Designation	Type	Approval No	Serial No

Rate-of-turn indicators ..... Number .....

Order No	Designation	Type	Approval No	Serial No

This is to certify that the radar equipment and rate-of-turn indicator of the abovementioned vessel comply with the installation and performance test requirements for radar equipment and rate-of-turn indicators used in inland waterway vessels..

Approved firm

Name: .....

Address: .....

Telephone .....

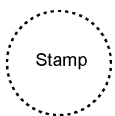

Place ..... Date .....

Firma: .....

Autoridad competente

Name: .....

Address: .....

Telephone .....



