

Council Regulation (EC) No 2187/2005 of 21 December 2005 for the conservation of fishery resources through technical measures in the Baltic Sea, the Belts and the Sound, amending Regulation (EC) No 1434/98 and repealing Regulation (EC) No 88/98 (repealed)

COUNCIL REGULATION (EC) No 2187/2005

of 21 December 2005

for the conservation of fishery resources through technical measures in the Baltic Sea, the Belts and the Sound, amending Regulation (EC) No 1434/98 and repealing Regulation (EC) No 88/98 (repealed)

THE COUNCIL OF THE EUROPEAN UNION,

Having regard to the Treaty establishing the European Community, and in particular Article 37 thereof,

Having regard to the proposal from the Commission⁽¹⁾,

Having regard to the opinion of the European Parliament⁽²⁾,

Whereas:

- (1) Pursuant to Articles 2 and 4 of Council Regulation (EC) No 2371/2002 of 20 December 2002 on the conservation and sustainable exploitation of fisheries resources under the Common Fisheries Policy⁽³⁾, the Council is to establish, taking into account available scientific, technical and economic advice, Community measures necessary to ensure exploitation of living aquatic resources that provides sustainable economic, environmental and social conditions. To that end, the Council may adopt technical measures to limit fishing mortality and the environmental impact of fishing activities.
- (2) The accession of the Community to the Convention on Fishing and Conservation of the Living Resources in the Baltic Sea and the Belts, as amended by the Protocol to the Conference of the representatives of the States Parties to the Convention (hereinafter referred to as the Gdansk Convention) was approved by Decision 83/414/EEC⁽⁴⁾.
- (3) Since it was established by the Gdansk Convention, the International Baltic Sea Fishery Commission (IBSFC) has adopted a body of measures for the conservation and management of fishery resources in the Baltic Sea. It notified the Contracting Parties of certain recommendations to modify those technical measures.
- (4) It is appropriate for the Community to give effect to such recommendations. However, since the IBSFC may be superseded by bilateral cooperation with the Russian Federation, the Community rules should not follow strictly those recommendations but should rather seek to establish a comprehensive and consistent system of technical measures for Community waters, based on the existing rules. There is scope for simplification in some cases where the existing rules are unnecessarily detailed and/or cannot be justified for the conservation of resources.

- (5) Regulation (EC) No 88/98⁽⁵⁾ laid down certain technical measures for the conservation of fishery resources in the waters of the Baltic Sea, the Belts and the Sound.
- (6) The application of Regulation (EC) No 88/98 has brought to light certain deficiencies in that Regulation which have resulted in problems of application and enforcement and which should be rectified, notably by defining target species and required catch percentages applicable for different mesh size ranges and geographical areas when fishing with certain gears.
- (7) The manner in which the percentages of target species and of other species are to be calculated should be defined.
- (8) The minimum size of each species should be fixed taking into account the selectivity of the mesh size of the fishing gear which can be used for that species.
- (9) Scientific information indicates that there are large by-catches of juvenile cod in eel fishery with trawls. The fishing of eel with active gear should therefore be prohibited.
- (10) The Gulf of Riga is a unique and rather sensitive marine ecosystem which requires special measures to ensure sustainable exploitation of its resources and to minimise the impact of fishing activities. Article 21 of the 2003 Act of Accession, therefore, provides that the Council is to amend Regulation (EC) No 88/98 before the date of accession with a view to adopting the necessary conservation measures in the Gulf of Riga.
- (11) In order to control fishing activities, access to the Gulf of Riga should be subject to special fishing permits as referred to in Council Regulation (EC) No 1627/94 of 27 June 1994 laying down general provisions concerning special fishing permits⁽⁶⁾.
- (12) Scientific information indicates that, for cod, towed gears without exit window and with normal diamond knotted netting in the codend and the extension piece are less selective than those with the BACOMA type exit window or where the netting in the codend and extension piece is turned 90°. It is therefore appropriate not to allow, within Community waters and for Community vessels, the use of towed gears without the BACOMA type exit window or without the netting in the codend and extension piece being turned 90° when cod is a target species.
- (13) Regulation (EC) No 1434/98⁽⁷⁾ laid down conditions under which herring may be landed for industrial purposes other than direct human consumption.
- (14) In order to simplify the complex rules of Regulation (EC) No 1434/98, the provisions of that Regulation that are of relevance for the Baltic Sea should be replaced by general provisions on unsorted landings in this Regulation. Regulation (EC) No 1434/98 should be amended accordingly.
- (15) The measures necessary for the implementation of this Regulation should be adopted in accordance with Council Decision 1999/468/EC of 28 June 1999 laying down the procedures for the exercise of implementing powers conferred on the Commission⁽⁸⁾.
- (16) Amendments to Annex I and to Appendices 1 and 2 to Annex II to this Regulation should also be adopted in accordance with Decision 1999/468/EC.

- (17) By reason of the number and scope of the changes to be made to the rules, Regulation (EC) No 88/98 should be repealed and replaced by a new text,

HAS ADOPTED THIS REGULATION:

CHAPTER I

SCOPE AND DEFINITIONS

Article 1

Subject matter and scope

This Regulation lays down technical conservation measures in relation to the taking and landing of fishery resources in the maritime waters under the sovereignty or jurisdiction of the Member States and situated in the geographical area specified in Annex I.

Article 2

Definitions

For the purposes of this Regulation:

- (a) ‘active gear’ means any fishing gear for which the catch operation requires an active movement of the gear, including in particular towed gears and encircling gears;
- (i) ‘trawl’ means gear which is actively towed by one or more fishing vessels and consisting of a net having a cone- or pyramid-shaped body (as trawl body) closed at the back by a codend;
- (ii) ‘beam trawl’ means gear with a trawl net open horizontally by a steel or wooden tube, the beam, and netting with ground chains, chain mats or tickler chains, actively towed on the bottom by the vessel engine;
- (iii) ‘Danish seine’ means encircling and towed gear, operated from a boat by means of two long ropes (seine ropes) designed to herd the fish towards the opening of the seine. The gear made up of net, which is similar to a bottom trawl in design and size, comprises two long wings, a body and a bag (codend);
- (iv) ‘dredges’ means a net or metal basket mounted on a frame of variable shape and size, the lower part of which carries a scraper blade, sometimes toothed;
- (v) ‘purse seine’ means encircling gear made up of net where the bottom is drawn together by means of a purse line at the bottom of the net, which passes through a series of rings along the groundrope, enabling the net to be pursed and closed;
- (b) ‘passive gear’ means any fishing gear for which the catch operation does not require an active movement of the gear, and includes gillnets, entangling nets, trammel nets, trap-nets, lines, pots and traps. The nets may consist of one or more separate nets

which are rigged with top, bottom and connecting ropes, and may be equipped with anchoring, floating and navigational gear;

- (i) 'gillnet' and 'entangling net' means gear made up of a single piece of net and held vertically in the water by floats and weights. It catches living aquatic resources by entangling or enmeshing;
- (ii) 'trammel net' means gear made up of two or more pieces of net hung jointly in parallel on a single headline and held vertically in the water by floats and weights;
- (iii) 'lines' means a number of connected lines, either set at the bottom or drifting, each bearing a large number of baited hooks;
- (c) 'hooks' means a bent, sharpened piece of steel wire usually with barb;
- (d) 'immersion time' means the period from the point of time when the nets are first put in the water until the point of time when the nets are fully recovered on board the fishing vessel;
- (e) 'square-meshed netting' means a construction of netting mounted so that of the two sets of parallel lines formed by the mesh bars, one set is parallel to, and the other at right angles to the long axis of the net;
- (f) 'codend' means the last 8 m of the trawl, having either a cylindrical shape, i.e. the same circumference throughout, or a tapering shape;
- (g) 'strengthening bag' means a cylindrical piece of netting completely surrounding the codend of a trawl and which may be attached to the codend at intervals;
- (h) 'back strap' means the rearmost round strap attached to the codend, measured when the meshes are stretched lengthwise;
- (i) 'lifting strap' means a piece of rope encircling the circumference of the codend or the strengthening bag, if any, and attached to it by means of loops or rings;
- (j) 'round strap' means a piece of rope encircling the circumference of the codend or the strengthening bag and which is attached to it;
- (k) 'flapper' means a piece of netting fastened inside an active gear net in such a way that it allows catches to pass from the front to the rear of the gear but limits their possibility of return;
- (l) 'codend buoy' means a buoyant unit attached to the codend;
- (m) 'buoy rope' means a rope connecting a cod-end buoy to that part of the fishing gear being supported or marked;
- (n) 'extension piece' means an untapered section of the trawl having a cylindrical shape, i.e. the same circumference as the codend throughout, attached to or a continuation of the codend.

CHAPTER II

NETS AND CONDITIONS FOR THEIR USE

SECTION I

Target species

Article 3

Target species and minimum mesh sizes

1 For each of the subdivisions listed in Annex I, the ranges of mesh size admissible for each target species shall be as defined in Annex II when fishing with trawls, Danish seines and similar gears and as defined in Annex III when fishing with gillnets, entangling nets and trammel nets. No part of the gears or nets shall have a mesh size less than the smallest mesh size within each mesh size range.

2 The minimum percentage of the target species among the living aquatic resources retained on board for each geographic subdivision and each range of mesh size is set out in Annex II and Annex III.

3 During any fishing voyage when dredges are carried on board, the retention on board and the landing of any quantity of living aquatic resources shall be prohibited unless at least 85 % of the live weight thereof consists of molluscs and/or *Furcellaria lumbricalis*.

4 The use, within a subdivision, of gillnets or entangling nets having mesh sizes smaller than those referred to in Annex III shall be prohibited.

5 The use, within a subdivision, of trammel nets with mesh size in that part of the net having the largest meshes that does not correspond to one of the categories set out in Annex III unless the mesh size in the part of the net having the smallest meshes is smaller than 16 mm shall be prohibited. If the mesh size in the smallest meshes is less than 16 mm, all meshes with a mesh size above 16 mm shall correspond to the categories set out in Annex III.

6 For each fishing voyage, landings shall be prohibited whenever the catch taken in the subdivisions listed in Annex I, and retained on board, does not comply with the corresponding conditions laid down in Annex II or Annex III.

Article 4

Calculation of percentages of target species

1 The percentages of target species referred to in Annexes II and III shall be calculated as the proportion by live weight of all species listed in Annexes II and III which are either retained on board after sorting or landed.

2 The percentage of target species and of other species shall be obtained by aggregating all quantities of target species and of other species listed in Annexes II and III retained on board.

3 The quantities of species listed in Annexes II and III that have been transhipped from a fishing vessel shall be taken into account when calculating the percentages of target species for that vessel.

4 The percentages of target species may be calculated on the basis of one or more representative samples.

SECTION II

Active gear

Article 5

Structure of fishing gear

1 No device shall be used which obstructs or otherwise diminishes the mesh in the codend.

2 By way of derogation from paragraph 1, it shall be permitted to attach to the outside of the lower half of the codend of any active gear, any canvas, netting or other material which has the purpose of preventing or reducing wear. Such material shall be attached along the forward and lateral edges of the codend only.

3 By way of derogation from paragraph 1, when fishing with trawls, Danish seines or similar gears with a mesh size less than 90 mm, it shall be permitted to attach to the outside of the codend a strengthening bag. The mesh size of the strengthening bag shall be at least twice as large as that of the codend and in no case less than 80 mm.

A strengthening bag may be attached at the following points:

- a at its forward edge;
- b at its rear edge; or
- c circumferentially between the rear and front part.

A strengthening bag may be laced:

- a circumferentially to the codend and the extension piece around one row of meshes; or
- b longitudinally along a single row of meshes.

4 By way of derogation from paragraph 1, it shall be permitted to:

- a use in active gear a non-return net or flapper. The flapper may be attached either inside the codend or in front of the codend. The provisions on minimum mesh sizes laid down in Annex II shall not apply to the flapper. The distance from the point of forward attachment of the flapper to the rear end of the codend shall be at least three times the length of the flapper;
- b attach to the outside of any part of the codend a sensor dedicated to the measurement of the volume of the catches;
- c use round straps and a lifting strap attached to the outside of the codend when fishing with trawls, Danish seines or similar gears with a mesh size smaller than 90 mm;
- d use one lifting strap attached to the outside of the codend when fishing with trawls, Danish seines or similar gears with a mesh size equal to or larger than 90 mm;
- e attach floats on the two lateral selvedges of the codend;
- f use a back strap attached to the outside of the codend. The distance between the back strap and the codline shall be equal to or smaller than 50 cm.

Article 6

Specific prohibited structures

Use of the following shall be prohibited:

- (a) any codend in which the number of equal sized meshes around any circumference of the codend increases from the front end to the rear end;
- (b) any extension piece in which the circumference at any point is smaller than the circumference of the foremost end of the codend to which the extension piece is joined;
- (c) any codend of mesh size equal to or greater than 32 mm in which any mesh is not diamond or square;
- (d) any trawl, Danish seine or similar gear with a mesh size equal to or larger than 90 mm to which a codend is attached by any means other than being sewn into that part of the net anterior to the codend;
- (e) any trawl, Danish seine or similar gear with a mesh size equal to or larger than 90 mm having more than 100 open diamond meshes and less than 40 open diamond meshes in any circumference of the codend, excluding the joining or the selvages;
- (f) any codend where the stretched length of the top half is not approximately equal to the stretched length of the bottom half.

Article 7

Selectivity in trawl fisheries for cod

The Commission shall, on the basis of advice from the Scientific, Technical and Economic Committee for Fisheries, present to the Council not later than September 2007 an assessment of the selectivity on cod of active gears for which cod is recognised as target species.

SECTION III

Passive gear

Article 8

Dimensions and immersion time

- 1 Where fishing is conducted using gillnets, entangling nets or trammel nets, the use of more than 9 km of nets for vessels with an overall length of up to and including 12 m and 21 km of nets for vessels with an overall length of more than 12 m shall be prohibited.
- 2 The immersion time of the nets referred to in paragraph 1 shall not exceed 48 hours.
- 3 By way of derogation from paragraph 2, the immersion time of nets referred to in paragraph 1 when fishing under the ice cover shall not be limited.

Article 9

Restrictions on driftnets

- 1 From 1 January 2008 it shall be prohibited to keep on board, or use for fishing, driftnets.
- 2 In 2006 and 2007, a vessel may keep on board, or use for fishing, driftnets if authorised to do so by the competent authorities of the flag Member State.
- 3 In 2006 and 2007, the maximum number of vessels which may be authorised by a Member State to keep on board, or use for fishing, driftnets shall not exceed 40 % and 20 % respectively of the fishing vessels which used driftnets during the period 2001 to 2003.
- 4 By way of derogation from paragraph 3, in subdivisions 25 to 32 the maximum number of vessels which may be authorised by a Member State to keep driftnets on board or use them for fishing shall not exceed 40 % of the fishing vessels which used driftnets during the period 2001 to 2003.
- 5 Member States shall communicate to the Commission by 30 April each year the list of vessels authorised to carry out fishing activities using driftnets.

Article 10

Conditions for driftnets

- 1 The master of a fishing vessel using driftnets shall keep a logbook in which he shall record the following information on a day-to-day basis:
 - a the total length of the nets on board;
 - b the total length of the nets used in each fishing operation;
 - c the quantity, date and position of by-catches of cetaceans.
- 2 All fishing vessels using driftnets shall keep on board the authorisation referred to in Article 9(2).

SECTION IV

Common provisions on gear and its use

Article 11

Determination of mesh size and twine thickness

Commission Regulation (EC) No 129/2003 of 24 January 2003 laying down detailed rules for determining the mesh size and thickness of twine of fishing nets⁽⁹⁾ shall apply.

Article 12

Reaching of required catch percentages

1 Quantities of living aquatic resources caught in excess of permitted percentages specified in Annexes II and III may not be landed but shall be returned to the sea before each landing.

2 Notwithstanding paragraph 1, whenever during a fishing voyage a vessel leaves any of the groups of subdivisions listed in Annexes II and III, the minimum percentage of target species as set out in Annexes II and III caught and retained on board from that geographical area shall be met within two hours.

Article 13

Conditions for use of gear

1 Gear that may not be used within a certain geographical area or during a certain period shall be stowed away in such a manner that it is not ready for use in the prohibited area or during the prohibited period. Reserve gear shall be stowed away separately and in such a manner that it is not ready for use.

2 Fishing gear shall be considered not ready for use if:

a in the case of trawls, Danish seines and similar gears with the exception of pair trawl:

(i) the trawl boards are made fast to the inner or outer side of the bulwark or the gallows,

(ii) sweep lines or warps are unshackled from the trawl boards or weights;

b in the case of pair trawl, the wing tip weights are unshackled and stowed away;

c in the case of lines, gillnets, entangling nets and trammel nets:

(i) the nets are stowed under a lashed cover,

(ii) the lines and hooks are kept in closed boxes;

d in the case of purse seines, the main or bottom wire is unshackled from the seine.

3 By way of derogation from paragraph 1, where any gear is used for which cod (*Gadus morhua*) is defined as a target species in accordance with Annexes II or III, no other type of gear shall be kept on board.

CHAPTER III

MINIMUM LANDING SIZE OF FISH

Article 14

Measurement of fish

1 A fish shall be regarded as undersized if it is smaller than the minimum size specified in Annex IV for the relevant species and the relevant geographical area.

2 The size of a fish shall be measured from the tip of the snout, with mouth closed, to the extreme end of the tail fin.

Article 15

Retention on board of undersized fish

1 Undersized fish shall not be retained on board or be transhipped, landed, transported, stored, sold, displayed or offered for sale, but shall be returned immediately to the sea.

2 For fish other than those defined in Annex II as target species for the mesh size categories 'smaller than 16 mm' or '16 to 31 mm' caught with trawls, Danish seines or similar gears of a mesh size less than 32 mm, or with purse seines, paragraph 1 shall not apply, provided that those fish are not sorted and not sold, displayed or offered for sale for human consumption.

CHAPTER IV

**RESTRICTIONS RELATING TO CERTAIN AREAS, TYPES
OF FISHERIES OR LIVING AQUATIC RESOURCES**

Article 16

Prohibited areas

It shall be prohibited throughout the year, to fish with any active gear in the geographical area enclosed by sequentially joining with rhumb lines the following positions, which shall be measured according to the WGS84 coordinate system:

1. 54° 23' N, 14° 35' E
2. 54° 21' N, 14° 40' E
3. 54° 17' N, 14° 33' E
4. 54° 07' N, 14° 25' E
5. 54° 10' N, 14° 21' E
6. 54° 14' N, 14° 25' E
7. 54° 17' N, 14° 17' E
8. 54° 24' N, 14° 11' E
9. 54° 27' N, 14° 25' E
10. 54° 23' N, 14° 35' E

Article 17

Restrictions on fishing for salmon and sea trout

1 The retention on board of salmon (*Salmo salar*) or sea trout (*Salmo trutta*) shall be prohibited:

- a from 1 June to 15 September in waters of subdivisions 22 to 31;
- b from 15 June to 30 September in waters of subdivision 32.

2 The area of prohibition during the closed season shall be beyond four nautical miles measured from the baselines.

3 By way of derogation from paragraph 1, the retention on board of salmon (*Salmo salar*) or sea trout (*Salmo trutta*) caught with trap-nets shall be permitted.

Article 18

Restrictions on fishing for eel

The retention on board of eel caught with any active gear shall be prohibited throughout the year.

Article 19

Restrictions on unsorted landings

1 Unsorted catches shall be landed only at ports and landings sites where a sampling programme referred to in paragraph 2 is in operation.

2 Member States shall ensure that an adequate sampling programme allowing effective monitoring of unsorted landings by species is in place.

CHAPTER V

SPECIFIC MEASURES FOR THE GULF OF RIGA

Article 20

Special fishing permit

1 In order to fish in subdivision 28-1, vessels shall hold a special fishing permit issued in accordance with Article 7 of Regulation (EC) No 1627/94.

2 Member States shall ensure that vessels, to which the special fishing permit referred to in paragraph 1 has been issued, are included in a list, containing their name and internal registration number, made publicly available via an Internet website, the address of which shall be provided to the Commission and Member States by each Member State.

- 3 Vessels included in the list shall satisfy the following conditions:
- a the total engine power (kW) of the vessels within the lists must not exceed that observed for each Member State in the years 2000-2001 in subdivision 28-1; and
 - b the engine power of a vessel must not exceed 221 kilowatts (kW) at any time.

*Article 21***Replacement of vessels or engines**

- 1 Any individual vessel on the list referred to in Article 20(2) may be replaced by another vessel or vessels, provided that:
 - a such replacement does not lead to an increase in the total engine power as indicated in Article 20(3)(a) in the Member State concerned, and
 - b the engine power of any replacement vessel does not exceed 221 kW at any time.
- 2 An engine of any individual vessel included in the list referred to in Article 20(2) may be replaced, provided that:
 - a the replacement of an engine does not lead to the vessel's engine power exceeding 221 kW at any time, and
 - b the power of the replacement engine is not such that replacement leads to an increase in the total engine power as indicated in Article 20(3)(a) for the Member State concerned.

*Article 22***Trawling prohibition**

In subdivision 28-1, fishing with trawl shall be prohibited in waters of less than 20 m in depth.

CHAPTER VI

GENERAL PROVISIONS*Article 23***Prohibited fishing gear and practices**

- 1 The catching of living aquatic resources using methods incorporating the use of explosives, poisonous or stupefying substances, electric current or any kind of projectile shall be prohibited.
- 2 The sale, display or offer for sale of living aquatic resources caught using methods referred to in paragraph 1 shall be prohibited.

*Article 24***Scientific research**

- 1 This Regulation shall not apply to fishing operations conducted solely for the purpose of scientific investigations subject to the following conditions:
 - a the fishing operations must be carried out with the permission and under the authority of the Member State or Member States concerned;

- b the Member State or Member States in whose waters the research is carried out must have been informed in advance of the fishing operations; and
 - c the vessel conducting the fishing operations must carry on board an authorisation issued by the Member State whose flag the vessel is flying.
- 2 Notwithstanding paragraph 1, living aquatic resources caught for the purposes specified in paragraph 1 cannot be sold, stored, displayed or offered for sale, unless:
- a they meet the minimum landing sizes listed in Annex IV and, for resources for which fishing opportunities are fixed, such opportunities are not exhausted; or
 - b they are sold directly for purposes other than human consumption.

Article 25

Artificial restocking and transplantation

This Regulation shall not apply to fishing operations conducted solely for the purpose of artificial restocking or transplantation of living aquatic resources which are carried out with the permission and under the authority of the Member State or Member States concerned. Where the artificial restocking or transplantation is carried out in the waters of another Member State or Member States, all the Member States concerned shall be informed in advance.

Article 26

Measures taken by Member States applying solely to fishing vessels flying their flag

- 1 Member States may, for the conservation and management of stocks or to reduce the effect of fishing on the marine eco-system, take technical measures designed to limit fishing opportunities which:
- a supplement measures set out in Community fisheries Regulations; or
 - b go beyond minimum requirements set out in Community fisheries Regulations.
- 2 Measures referred to in paragraph 1 shall apply solely to the fishermen of the Member State concerned and shall be compatible with Community law.
- 3 The Member State concerned shall communicate such measures without delay to the other Member States and the Commission.
- 4 Member States shall supply the Commission, on its request, with all information needed for the assessment of whether the measures comply with the conditions laid down in paragraph 1.
- 5 If the Commission concludes that the measures do not comply with the conditions laid down in paragraph 1 it shall adopt a decision requiring the Member State to withdraw or modify the measures.

*Article 27***Scientific assessment of gear types**

By 1 January 2008, the Commission shall ensure that a scientific assessment of the effects of using in particular gillnets, trammel nets and entangling nets on cetaceans is conducted and its findings presented to the European Parliament and Council.

CHAPTER VII

FINAL PROVISIONS*Article 28***Implementing rules**

Detailed rules for the implementation of this Regulation shall be adopted in accordance with the procedure referred to in Article 30(2) of Regulation (EC) No 2371/2002.

*Article 29***Amendments to the Annexes**

Amendments to Annex I and to Appendices 1 and 2 to Annex II shall be adopted in accordance with the procedure referred to in Article 30(3) of Regulation (EC) No 2371/2002.

*Article 30***Amendments to Regulation (EC) No 1434/98**

Regulation (EC) No 1434/98 is hereby amended as follows:

1. in Article 1, paragraph 2 shall be deleted;
2. in Article 2, paragraphs 2 and 3 shall be deleted;
3. in Article 3, paragraph 1 shall be replaced by the following:
 1. Catches of herring taken:
 - in Regions 1 and 2 with towed nets of minimum mesh size equal to or greater than 32 mm, or
 - in Region 3 with towed nets of minimum mesh size equal to or greater than 40 mm, or
 - in Regions 1, 2 or 3 with any fishing gear other than towed nets,shall not be landed for purposes other than direct human consumption unless they are first offered for sale for direct human consumption and fail to find a buyer.;
4. in Article 3, paragraph 2 shall be replaced by the following:

2. However, any herring caught with any fishing gear within the conditions specified in Article 2 may be landed for purposes other than direct human consumption.

Article 31

Repeal

Regulation (EC) No 88/98 shall be repealed.

References to the repealed Regulation shall be construed as references to this Regulation and shall be read in accordance with the correlation table in Annex V.

Article 32

Entry into force

This Regulation shall enter into force on the seventh day following its publication in the *Official Journal of the European Union*.

It shall apply from 1 January 2006.

This Regulation shall be binding in its entirety and directly applicable in all Member States.

Done at Brussels, 21 December 2005.

For the Council

The President

B. BRADSHAW

ANNEX I

Subdivisions of the geographical area referred to in Article 1
to be measured according to the WGS84 coordinate system

Subdivision 22

The waters bounded by a line drawn from Hasenøre Head (56° 09' N, 10° 44' E) on the east coast of Jutland to Griben Point (56° 01' N, 11° 18' E) on the west coast of Zealand; then along the west coast and south coast of Zealand to a point situated at longitude 12° 00' E; from there, due south to the island of Falster; then along the east coast of the island of Falster to Gedser Odde (54° 34' N, 11° 58' E); then due east to longitude 12° 00' E; then due south to the coast of Germany; then in a south-westerly direction along the coast of Germany and the east coast of Jutland as far as the point of departure.

Subdivision 23

The waters bounded by a line drawn from Gilbjerg Head (56° 08' N, 12° 18' E) on the north coast of Zealand to Kullen (56° 18' N, 12° 28' E) on the coast of Sweden; then in a southerly direction along the coast of Sweden to the Falsterbo lighthouse (55° 23' N, 12° 50' E); then through the southern entrance to the Sound to the Stevns lighthouse (55° 19' N, 12° 28' E) on the coast of Zealand; then in a northerly direction along the east coast of Zealand as far as the point of departure.

Subdivision 24

The waters bounded by a line drawn from the Stevns lighthouse (55° 19' N, 12° 28' E) on the east coast of Zealand through the southern entrance to the Sound to the Falsterbo lighthouse (55° 23' N, 12° 50' E) on the coast of Sweden; then along the south coast of Sweden to the Sandhammaren lighthouse (55° 24' N, 14° 12' E); from there to the Hammerodde lighthouse (55° 18' N, 14° 47' E) on the north coast of Bornholm; then along the west and south coasts of Bornholm to a point situated at longitude 15° 00' E; from there due south to the coast of Poland; then in a westerly direction along the coasts of Poland and Germany to a point situated at longitude 12° 00' E; then due north to a point situated at latitude 54° 34' N and longitude 12° 00' E; then due west to Gedser Odde (54° 34' N, 11° 58' E); from there, along the east and north coast of the island of Falster to a point situated at longitude 12° 00' E; from there, due north to the south coast of Zealand; then in a westerly and northerly direction along the west coast of Zealand as far as the point of departure.

Subdivision 25

The waters bounded by a line drawn from a point on the east coast of Sweden at latitude 56° 30' N and proceeding due east to the west coast of the island of Öland; then, after passing south of the island of Öland to a point on the east coast situated at latitude 56° 30' N, due east to longitude 18° 00' E; then due south to the coast of Poland; then in a westerly direction along the coast of Poland to a point situated at longitude 15° 00' E; then due north to the island of Bornholm; then along the south and west coasts of Bornholm to the Hammerodde lighthouse (55° 18' N, 14° 47' E); then to the Sandhammaren lighthouse (55° 24' N, 14° 12' E) on the south coast of Sweden; then in a northerly direction along the east coast of Sweden as far as the point of departure.

Subdivision 26

The waters bounded by a line drawn from a point situated at latitude 56° 30' N and longitude 18° 00' E and proceeding due east to the west coast of Latvia; then in a southerly direction along the coasts of Latvia, Lithuania, Russia and Poland to a point on the Polish coast situated at longitude 18° 00' E; then due north as far as the point of departure.

Subdivision 27

The waters bounded by a line drawn from a point on the east mainland coast of Sweden situated at latitude 59° 41' N and longitude 19° 00' E and proceeding due south to the north coast of

the island of Gotland; then in a southerly direction along the west coast of Gotland to a point situated at latitude 57° 00' N; then due west to longitude 18° 00' E; then due south to latitude 56° 30' N; then due west to the east coast of the island of Öland; then, after passing south of the island of Öland, to a point on its west coast situated at latitude 56° 30' N; then due west to the coast of Sweden; then in a northerly direction along the east coast of Sweden as far as the point of departure.

Subdivision 28-1

The waters bounded in the west by a line drawn from 57° 34,1234' N, 21° 42,9574' E to 57° 57,4760' N, 21° 58,2789' E, then southwards to the southernmost point of the peninsula of Sörve and then in a north-eastern direction along the east coast of the island of Saaremaa; and in the north by a line drawn from 58° 30,0' N, 23° 13,2' E to 58° 30,0' N, 23° 41,1' E.

Subdivision 28-2

The waters bounded by a line drawn from a point situated at latitude 58° 30' N and longitude 19° 00' E and proceeding due east to the west coast of the island of Saaremaa; then, southwards along the west coast of Saaremaa to latitude 57° 57,4760' N and longitude 21° 58,2789' E; then south to a point situated at latitude 57° 34,1234' N and longitude 21° 42,9574' E; then following the Latvian coast southwards to a point situated at latitude 56° 30' N; then due west to longitude 18° 00' E; then due north to latitude 57° 00' N; then due east to the west coast of the island of Gotland; then in a northerly direction to a point on the north coast of Gotland situated at longitude 19° 00' E; then due north as far as the point of departure.

Subdivision 29

The waters bounded by a line drawn from a point on the east mainland coast of Sweden situated at latitude 60° 30' N and proceeding due east to the mainland coast of Finland; then in a southerly direction along the west and south coasts of Finland to a point on the south mainland coast situated at longitude 23° 00' E; then due south to latitude 59° 00' N; then due east to the mainland coast of Estonia; then in a southerly direction along the west coast of Estonia to a point situated at latitude 58° 30' N; then due west to the east coast of the island of Saaremaa; then, after passing north of the island of Saaremaa, to a point on its west coast situated at latitude 58° 30' N; then due west to longitude 19° 00' E; then due north to a point on the east mainland coast of Sweden situated at latitude 59° 41' N; then in a northerly direction along the east coast of Sweden as far as the point of departure.

Subdivision 30

The waters bounded by a line drawn from a point on the east coast of Sweden situated at latitude 63° 30' N and proceeding due east to the mainland coast of Finland; then in a southerly direction along the coast of Finland to a point situated at latitude 60° 30' N; then due west to the mainland coast of Sweden; then in a northerly direction along the east coast of Sweden as far as the point of departure.

Subdivision 31

The waters bounded by a line drawn from a point on the east coast of Sweden situated at latitude 63° 30' N and proceeding, after passing north of the Gulf of Bothnia, to a point on the west mainland coast of Finland situated at latitude 63° 30' N; then due west as far as the point of departure.

Subdivision 32

The waters bounded by a line drawn from a point on the south coast of Finland situated at longitude 23° 00' E and proceeding, after passing east of the Gulf of Finland, to a point on the west coast of Estonia situated at latitude 59° 00' N; then due west to longitude 23° 00' E; then due north as far as the point of departure.

Status: This is the original version (as it was originally adopted).

ANNEX II

TRAWLS, DANISH SEINES AND SIMILAR GEAR: MESH SIZE RANGES,
TARGET SPECIES AND REQUIRED CATCH PERCENTAGES APPLICABLE

Target species	Mesh size range (mm)						
	< 16	16 ≤ and < 32	16 ≤ and < 105	32 ≤ and < 90	32 ≤ and < 105	≥ 90 ^c	≥ 105 ^{bc}
	Groups of subdivisions						
	22-32	22-27	28-32	22-23	24-27	22-23	22-32
Minimum percentage of target species							
	90 ^a	90 ^{ac}	90 ^a	90 ^{ad}	90 ^{ad}	90	100
Sand eels (<i>Ammodytidae</i>)	*	*	*	*	*	*	*
Sprat (<i>Sprattus sprattus</i>)		*	*	*	*	*	*
Herring (<i>Clupea harengus</i>)			*	*	*	*	*
Sole (<i>Solea vulgaris</i>)						*	*
Plaice (<i>Pleuronectes platessa</i>)						*	*
Whiting (<i>Merlangius merlangus</i>)						*	*
Brill (<i>Scophthalmus rhombus</i>)						*	*
Dab (<i>Limanda limanda</i>)						*	*
Flounder (<i>Platichthys flesus</i>)						*	*

a The catch retained on board shall consist of no more than 3 % of cod by live weight.

b Only trawls, Danish seines and similar gears with Bacoma exit window or with T90 codend and extension piece with mesh size and specifications as laid down in Appendices I and II shall be authorised.

c The use of beam trawl shall not be authorised.

d The catch retained on board may consist of up to 40 % of whiting by live weight.

e The catch retained on board may consist of up to 45 % of herring by live weight.

Status: This is the original version (as it was originally adopted).

Lemon sole (<i>Microstomus kitt</i>)						*	*
Turbot (<i>Psetta maxima</i>)						*	*
Cod (<i>Gadus morhua</i>)							*

a The catch retained on board shall consist of no more than 3 % of cod by live weight.

b Only trawls, Danish seines and similar gears with Bacoma exit window or with T90 codend and extension piece with mesh size and specifications as laid down in Appendices I and II shall be authorised.

c The use of beam trawl shall not be authorised.

d The catch retained on board may consist of up to 40 % of whiting by live weight.

e The catch retained on board may consist of up to 45 % of herring by live weight.

Appendix 1

Specifications of top window codend BACOMA

1. Description
 - (a) Identification of window
 - (i) The window shall be a rectangular section of netting in the codend. There shall be only one window.
 - (b) Size of the codend, extension piece and the rear end of the trawl
 - (i) The codend shall be constructed of two panels, joined together by selvages one on each side of equal length.
 - (ii) The minimum mesh size of the diamond meshes shall be 105 mm. The material of the yarn shall be of polyethylene threads with a single twine thickness of no more than 6 mm or with double twine thickness of no more than 4 mm respectively.
 - (iii) The use of codends and extension pieces which are made of only one piece of net material and have only one selvedge shall be prohibited.
 - (iv) The number of open diamond meshes, excluding those in the selvages, at any point on any circumference of any extension piece shall not be less or more than the maximum number of meshes on the circumference of the front end of the codend (Figure 1).
 - (c) Location of window
 - (i) The window shall be inserted into the top panel of the codend (Figure 2).
 - (ii) The window shall terminate not more than four meshes from the codline, inclusive of the hand-braided row of meshes through which the codline is passed (Figure 3 or 4).
 - (d) Size of window
 - (i) The width of the window, expressed in number of mesh bars, shall be equal to the number of open diamond meshes in the top panel divided by two. If necessary, it will be allowed to maintain at the most 20 % of the number of open diamond meshes in the top panel divided evenly on the both sides of the window panel (Figure 4).
 - (ii) The length of the window shall be at least 3,5 m.
 - (iii) By way of derogation from point ii the length of the window shall be at least 4 m if a sensor dedicated to the measurement of the volume of the catches is attached to the window.
 - (e) Netting of window
 - (i) The meshes shall have a minimum mesh opening of 110 mm. The meshes shall be square meshes i.e. all four sides of the window netting will be cut all bars.
 - (ii) The netting shall be mounted such that the bars run parallel and perpendicular to the length of the codend. The netting shall be knotless braided single twine or netting with similar proven selective properties. Knotless netting means netting which is composed of meshes of four sides in which the corners of the meshes are formed by the interweaving of the twines of two adjacent sides of the mesh.

- (iii) The diameter of the single yarn shall be at least 5 mm.
- (f) Other specifications
 - (i) The mounting specifications are defined in Figures 3 and 4.
 - (ii) The length of the lifting strap shall not be less than:
 1. 4 m for a codend of circumference of between 100 and 89 diamond meshes measured in front of the window;
 2. 3,5 m for a codend of circumference between 88 and 75 diamond meshes measured in front of the window and;
 3. 3 m for a codend of circumference of less than 75 diamond meshes measured in front of the window.
 - (iii) A back strap shall not encircle the BACOMA exit window. It shall be made of rope not more than 20 mm in diameter and be at least 2 m long.
 - (iv) A codend buoy shall be spherical in shape and have a maximum diameter of 40 cm. It shall be fastened through the buoy rope to the cod line.
 - (v) A flapper shall not overlap the BACOMA exit window.
- 2. Conditions for the repair of square mesh panels
 - (a) General conditions
 - (i) The use of a square mesh BACOMA exit window which has 10 % or more meshes repaired shall be prohibited.
 - (ii) Square meshes which have been damaged shall be repaired according to the prescribed method.
 - (iii) A repaired mesh is any mesh where the mesh opening is reduced by a repair of damaged meshes or by the joining of two pieces of knotless square mesh netting.
 - (b) Method for repairing the damaged meshes in the BACOMA exit window

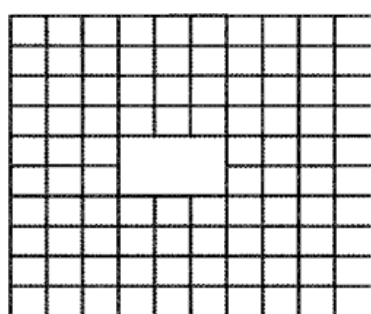

Punch

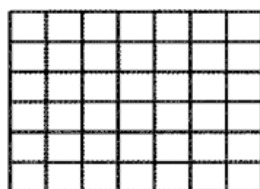

Patch

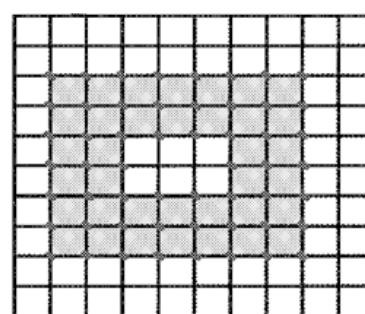

Repaired net with double meshes

- (i) Clean the hole.
- (ii) Count the meshes to be replaced. Prepare a patch using knotless braided single twine that is the same material, diameter and strength of the net needing to be patched.

- (iii) The patch should be no more than two meshes larger in each direction than the cleaned-up hole to provide sufficient netting to overlap the edges of the hole.
- (iv) Lay the patch over the hole and lace it to the existing netting using braided twine, as shown in the illustration.
- (v) Make sure to lace the crosses of the netting together.
- (vi) Continue lacing around the hole so that you have at least two rows of lacing around the patch.
- (vii) The patched hole will resemble the above illustration when finished.

Figure 1

Trawl gear can be divided into three different sections according to shape and function. The trawl body is always a tapered section. The extension piece is an untapered section normally manufactured of either one or two pieces of nets. The codend is also an untapered section often made of double twine in order to have a better resistance against heavy wearing. The part below the lifting strap is called lifting bag.

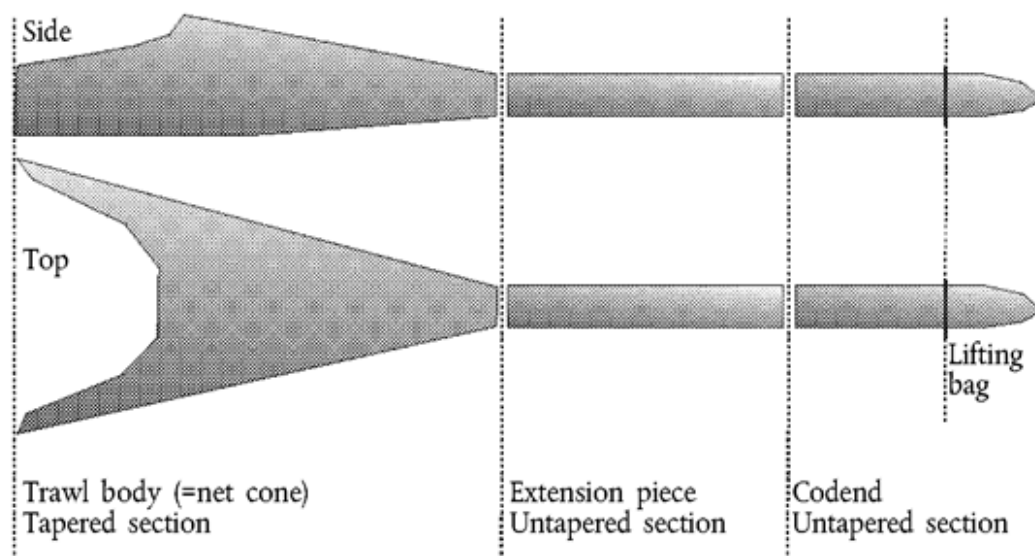

Figure 2

A	Extension piece
B	Codend
C	Escape window, square mesh panel
1	Upper panel, maximum 50 open diamond meshes
2	Lower panel, maximum 50 open diamond meshes
3	Selvages
4	Joining round or lacing
5	Lifting strap
6	Back strap
7	Codline
8	Distance of window from codline (Figures 3 and 4)
9	Buoy rope
10	Codend buoy

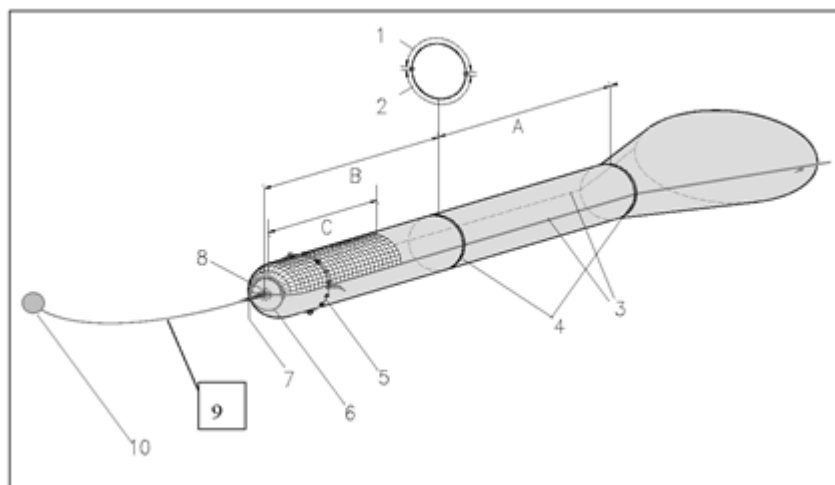

Figure 3

MOUNTING OF WINDOW PANEL

- A 110 m square mesh panel (25bars)
- B Joining of square mesh panel to selvedge
- C Joining of square mesh panel to diamond mesh net, except edge bars of window from both sides Two diamond meshes/one bar in a square mesh
- D 105 mm diamond mesh net (maximum 50 open meshes)
- E Distance of the window panel from the codline. The window shall terminate not more than four meshes from the codline, inclusive of the hand-braided row of meshes through which the codline is passed
- F One row of hand-braided codline meshes

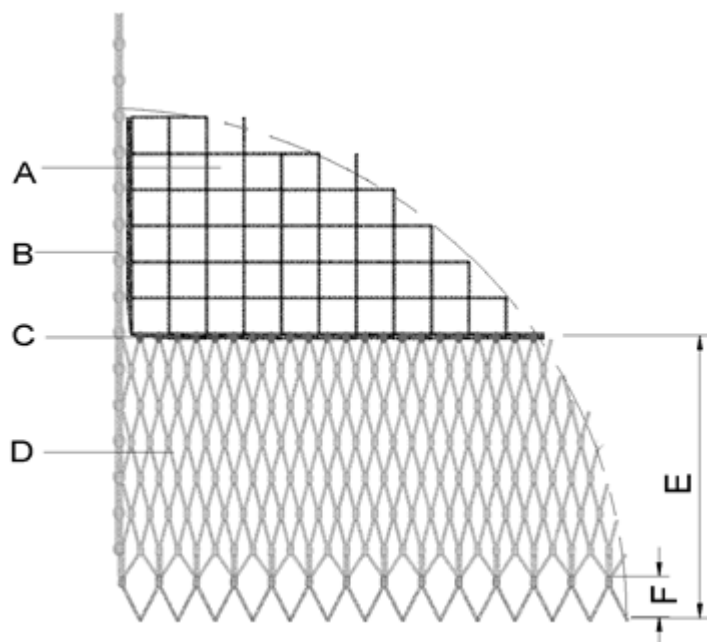
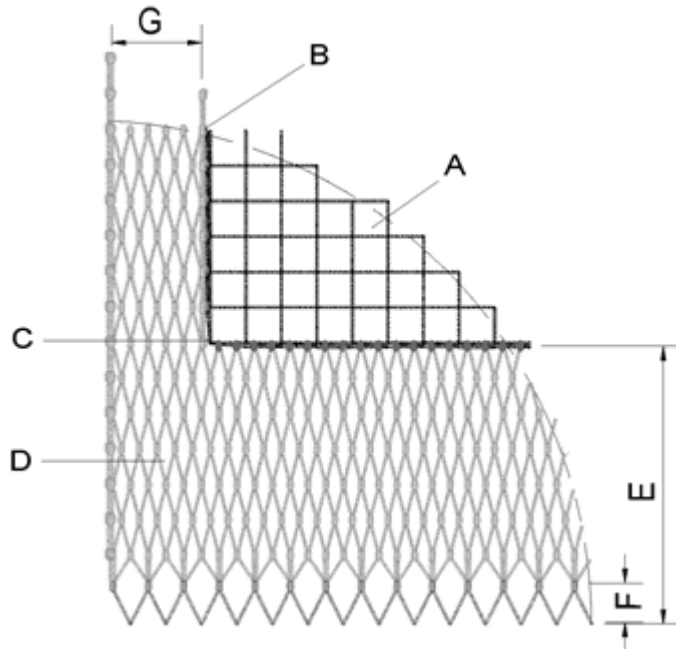

Figure 4

Status: This is the original version (as it was originally adopted).

MOUNTING OF WINDOW PANEL

- A 110 mm square mesh panel (20 bars)
- B Joining of square mesh panel to selvedge
- C Joining of square mesh panel to diamond mesh net, except edge bars of window from both sides
- D 2 diamond meshes/1 bar in a square mesh
- E 105 mm diamond mesh net (max 50 open meshes)
- F Distance of the window panel from the codline. The window shall terminate not more than 4 meshes from the codline, inclusive of the hand-braided row of meshes through which the codline is passed
- G One row of hand-braided codline meshes
- Maximum 10 % in both sides of open meshes D



Appendix 2

SPECIFICATIONS OF THE TRAWL

(a) Definition

1. T90 trawls are defined as trawls, Danish seines and similar gears having a codend and extension piece produced from diamond knotted netting turned 90° so that the main direction of run of the netting twine is parallel to the towing direction.
2. The direction of run of the netting twine in a standard diamond knotted net (A) and in a net turned 90° (B) is illustrated in Figure 1 below.

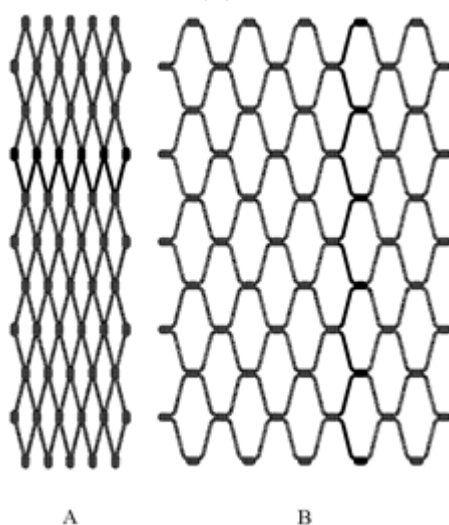

Figure 1

(b) Mesh size and measurement

The mesh size shall be at least 110 mm. By way of derogation from Article 5(1) of Regulation (EC) No 129/2003, the mesh size in the codend and the extension piece shall be measured perpendicular to the longitudinal axis of the fishing gear.

(c) Twine thickness

The material of the yarn of the codend and the extension piece shall be of polyethylene threads with a single twine thickness of no more than 6 mm or with double twine thickness of no more than 4 mm respectively. This provision shall not apply to the rear most row of meshes in the codend if fitted with a codline.

(d) Construction

1. A codend and extension of turned meshes (T90) shall be constructed from two panels of equal dimensions, with the same number of meshes in width and length, and with the mesh orientation described above, joined by two lateral selvedges. Each panel shall be constructed with non-slip knots and in such a way that the meshes remain fully open at all times when in use.
2. The number of open meshes in any circumference must be constant from the front part of the extension to the rear most part of the codend.

Status: This is the original version (as it was originally adopted).

3. At the point of attachment of the codend or extension piece to the tapered part of the trawl, the number of meshes in circumference of the codend or extension piece must be 50 % of the last row of meshes of the tapered part of the trawl.
4. A codend and extension piece is illustrated in Figure 2 below.

(e) Circumference

The number of meshes in any circumference in the codend and the extension piece, excluding joinings and selvages shall be no more than 50.

(f) Joining rounds

The forward edge of the panels composing both codend and extension piece shall be fitted out with a braided row of half meshes. The aft edge of codend panel shall be fitted out by a full row of braided meshes able to guide the codline.

(g) Lifting strap

The length of the lifting strap shall be no less than 3,5 m.

(h) Codend buoy

A codend buoy shall be spherical in shape and have a maximum diameter of 40 cm. It shall be fastened through the buoy rope to the codline.

Figure

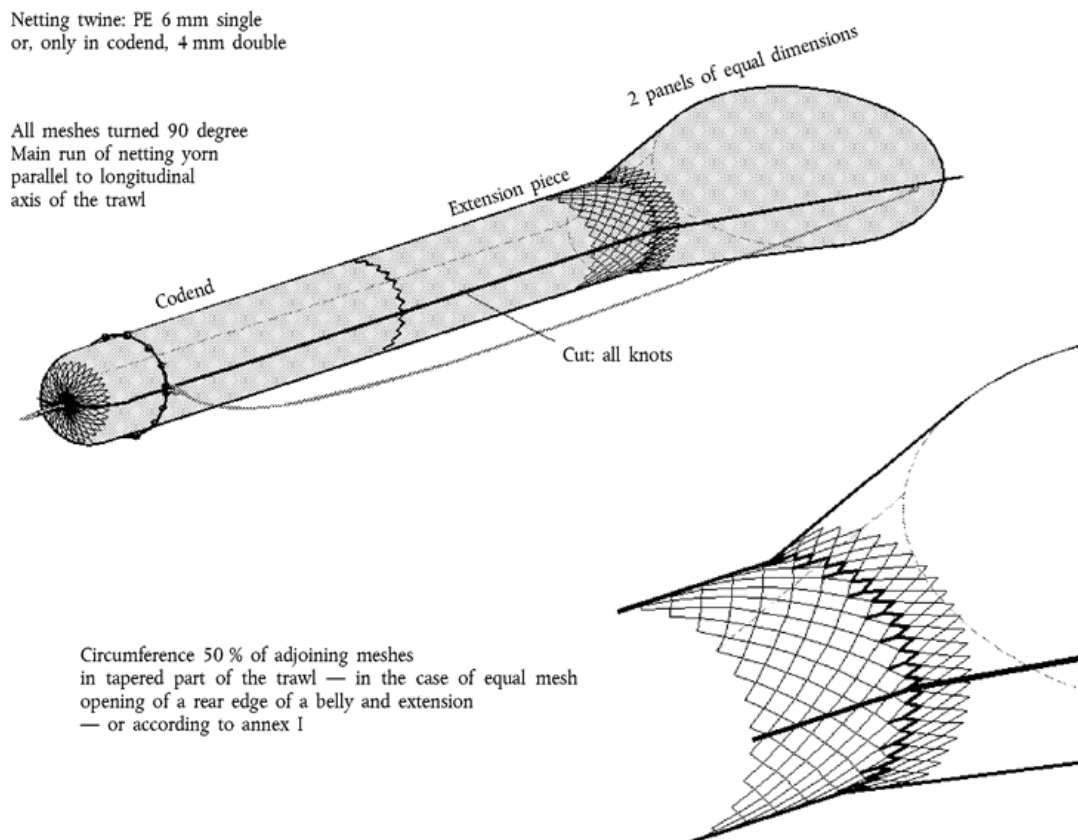

ANNEX III

GILLNETS, ENTANGLING NETS AND TRAMMEL
NETS: MESH SIZE RANGES AND TARGET SPECIES

Target species	Mesh size range (mm)				
	16 ≤ and < 110	32 ≤ and < 110	90 ≤ and < 156 ^b	110 ≤ and < 156	≥ 157
	Groups of subdivisions				
	28-32	22-27	22-23	22-32	22-32
	Minimum percentage of target species				
90 ^a	90 ^a	90	90	100	
Sprat (<i>Sprattus sprattus</i>)	*	*	*	*	*
Herring (<i>Clupea harengus</i>)	*	*	*	*	*
Sole (<i>Solea vulgaris</i>)			*	*	*
Plaice (<i>Pleuronectes platessa</i>)			*	*	*
Whiting (<i>Merlangius merlangus</i>)			*	*	*
Brill (<i>Scophthalmus rhombus</i>)			*	*	*
Dab (<i>Limanda limanda</i>)			*	*	*
Flounder (<i>Platichthys flesus</i>)			*	*	*
Lemon sole (<i>Microstomus kitt</i>)			*	*	*
Turbot (<i>Psetta maxima</i>)			*	*	*
Cod (<i>Gadus morhua</i>)				*	*

a The catch retained on board shall consist of no more than 3 % of cod by live weight.

b Such range of mesh size shall be admissible until 30 June 2006.

Status: This is the original version (as it was originally adopted).

Salmon (<i>Salmo salar</i>)					*
a The catch retained on board shall consist of no more than 3 % of cod by live weight.					
b Such range of mesh size shall be admissible until 30 June 2006.					

ANNEX IV

MINIMUM LANDING SIZES

Species	Geographical area	Minimum size
Cod (<i>Gadus morhua</i>)	Subdivisions 22-32	38 cm
Flounder (<i>Platichthys flesus</i>)	Subdivisions 22 to 25	23 cm
	Subdivisions 26 to 28	21 cm
	Subdivisions 29 to 32, south of 59° 30' N	18 cm
Plaice (<i>Pleuronectes platessa</i>)	Subdivisions 22 to 32	25 cm
Turbot (<i>Psetta maxima</i>)	Subdivisions 22 to 32	30 cm
Brill (<i>Scophthalmus rhombus</i>)	Subdivisions 22 to 32	30 cm
Eel (<i>Anguilla anguilla</i>)	Subdivisions 22 to 32	35 cm
Salmon (<i>Salmo salar</i>)	Subdivisions 22 to 30 and 32	60 cm
	Subdivision 31	50 cm
Sea trout (<i>Salmo trutta</i>)	Subdivisions 22 to 25 and 29 to 32	40 cm
	Subdivision 26 to 28	50 cm

ANNEX V

CORRELATION TABLE

Council Regulation (EC) No 88/98	This Regulation
Article 1	Article 1
Article 2	—
Article 3(1) and (2)	Article 14
Article 3(3)	Article 15(1)
Article 3(4)	—
Article 3(5)	—

Status: This is the original version (as it was originally adopted).

Article 4	—
Article 5(1) and (3)	Article 3
Article 5(2)	—
Article 6	Article 11
Article 7	Article 5
Article 8(1)	Article 13(1)
Article 8(2)	Article 13(2)
Article 8(3)	Article 16
Article 8(4)	Article 13(3)
Article 8a	Article 9
Article 8b	Article 10
Article 9(1)	Article 17
Article 9(2)	Article 8(1)
Article 10(1)	—
Article 10(2)	Article 23(1)
Article 10(3)	—
Article 10(4)	—
Article 11	Article 24
Article 12	Article 25
Article 13	Article 26
Article 14	Article 28
Article 15	Article 31
Article 16	Article 32
Annex I	Annex I
Annex II	—
Annex III	Annex IV
Annex IV	Annexes II and III
Annex V	Appendix 1 to Annex II
Annex VI	Annex V

Status: This is the original version (as it was originally adopted).

- (1) OJ C 125, 24.5.2005, p. 12.
- (2) Opinion delivered on 13 October 2005 (not yet published in the Official Journal).
- (3) OJ L 358, 31.12.2002, p. 59.
- (4) OJ L 237, 26.8.1983, p. 4.
- (5) OJ L 9, 15.1.1998, p. 1. Regulation as last amended by Regulation (EC) No 289/2005 (OJ L 49, 22.2.2005, p. 1).
- (6) OJ L 171, 6.7.1994, p. 7.
- (7) OJ L 191, 7.7.1998, p. 10.
- (8) OJ L 184, 17.7.1999, p. 23.
- (9) OJ L 22, 25.1.2003, p. 5.