

II

(Non-legislative acts)

REGULATIONS

COMMISSION REGULATION (EU) No 1299/2014**of 18 November 2014****on the technical specifications for interoperability relating to the 'infrastructure' subsystem of the rail system in the European Union****(Text with EEA relevance)**

THE EUROPEAN COMMISSION,

Having regard to the Treaty on the Functioning of the European Union,

Having regard to Directive 2008/57/EC of the European Parliament and of the Council of 17 June 2008 on the interoperability of the rail system within the Community ⁽¹⁾, and in particular Article 6(1) thereof,

Whereas:

- (1) Article 12 of Regulation (EC) No 881/2004 of the European Parliament and of the Council ⁽²⁾ requires the European Railway Agency (the Agency) to ensure that the technical specifications for interoperability (the TSIs) are adapted to technical progress, market trends and social requirements and to propose to the Commission the amendments to the TSIs which it considers necessary.
- (2) By Decision C(2010) 2576 of 29 April 2010, the Commission gave the Agency a mandate to develop and review the TSIs with a view to extending their scope to the whole rail system in the Union. Under the terms of that mandate, the Agency was requested to extend the scope of the TSI relating to the subsystem 'infrastructure', to the whole rail system in the Union.
- (3) On 21 December 2012, the Agency issued a recommendation on amendments to the TSI relating to the subsystem 'infrastructure' (ERA/REC/10-2012/INT).
- (4) In order to keep pace with technological progress and encourage modernisation, innovative solutions should be promoted and their implementation should, under certain conditions, be allowed. Where an innovative solution is proposed, the manufacturer or his authorised representative should state how it deviates from or how it complements to the relevant section of the TSI, and the innovative solution should be assessed by the Commission. If this assessment is positive, the Agency should devise the appropriate functional and interface specifications of the innovative solution and develop the relevant assessment methods.
- (5) The TSI infrastructure established by this Regulation does not deal with all essential requirements. In accordance with Article 5(6) of Directive 2008/57/EC, technical aspects which are not covered by it should be identified as 'open points' governed by national rules applicable in each Member State.
- (6) In accordance with Article 17(3) of Directive 2008/57/EC, Member States are to notify to the Commission and other Member States the conformity assessment and verification procedures to be used for the specific cases as well as the bodies responsible for carrying out these procedures. The same obligation should be provided as regards to open points.

⁽¹⁾ OJ L 191, 18.7.2008, p. 1.

⁽²⁾ Regulation (EC) No 881/2004 of the European Parliament and of the Council of 29 April 2004 establishing a European Railway Agency (OJ L 164, 30.4.2004, p. 1).

- (7) Rail traffic currently operates under existing national, bilateral, multinational or international agreements. It is important that these agreements do not hinder current and future progress towards interoperability. The Member States should therefore notify such agreements to the Commission.
- (8) In accordance with Article 11(5) of Directive 2008/57/EC, the TSI on infrastructure should allow, for a limited period of time, for interoperability constituents to be incorporated into subsystems without certification if certain conditions are met.
- (9) Commission Decisions 2008/217/EC ⁽¹⁾ and 2011/275/EU ⁽²⁾ should therefore be repealed.
- (10) In order to prevent unnecessary additional costs and administrative burden, Decisions 2008/217/EC and 2011/275/EU should continue to apply after their repeal to the subsystems and projects referred to in Article 9(1)(a) of Directive 2008/57/EC.
- (11) The measures provided for in this Regulation are in conformity with the opinion of the Committee established in accordance with Article 29(1) of Directive 2008/57/EC,

HAS ADOPTED THIS REGULATION:

Article 1

Subject matter

The technical specification for interoperability (TSI) relating to the 'infrastructure' subsystem of the rail system in the entire European Union, as set out in the Annex, is hereby adopted.

Article 2

Scope

1. The TSI shall apply to all new, upgraded or renewed 'infrastructure' of the rail system in the European Union as defined in point 2.1 of Annex I to Directive 2008/57/EC.
2. Without prejudice to Articles 7 and 8 and point 7.2 of the Annex, the TSI shall apply to new railway lines in the European Union, which are placed in service from 1 January 2015.
3. The TSI shall not apply to existing infrastructure of the rail system in the European Union, which is already placed in service on all or part of the network of any Member State on 1 January 2015, except when it is subject to renewal or upgrading in accordance with Article 20 of Directive 2008/57/EC and Section 7.3 of the Annex.
4. The TSI shall apply to the following networks:
 - (a) the trans-European conventional rail system network as defined in Annex I, point 1.1 to Directive 2008/57/EC;
 - (b) the trans-European high-speed rail system network (TEN) as defined in Annex I, point 2.1 to Directive 2008/57/EC;
 - (c) other parts of the network of the rail system in the Union;

and excludes the cases referred to in Article 1(3) of Directive 2008/57/EC.

⁽¹⁾ Commission Decision 2008/217/EC of 20 December 2007 concerning a TSI relating to the infrastructure sub-system of the trans-European high-speed rail system (OJ L 77, 19.3.2008, p. 1).

⁽²⁾ Commission Decision 2011/275/EU of 26 April 2011 concerning a TSI relating to the infrastructure sub-system of the trans-European conventional rail system (OJ L 126, 14.5.2011, p. 53).

5. The TSI shall apply to networks with the following nominal track gauges: 1 435 mm, 1 520 mm, 1 524 mm, 1 600 mm and 1 668 mm.
6. Metric gauge is excluded from the technical scope of this TSI.
7. The technical and geographical scope of this Regulation is set out in Sections 1.1 and 1.2 of the Annex.

Article 3

Open points

1. With regard to the issues classified as 'open points' set out in Appendix R of the TSI, the conditions to be complied with for verifying the interoperability pursuant to Article 17(2) of Directive 2008/57/EC shall be the national rules applicable in the Member State which authorises the placing in service of the subsystem covered by this Regulation.
2. Within six months of the entry into force of this Regulation, each Member State shall send to the other Member States and the Commission of the following information, unless such information has already been sent to them under Decisions 2008/217/EC or 2011/275/EU:
 - (a) the national rules referred to in paragraph 1;
 - (b) the conformity assessment and verification procedures to be carried out to apply the national rules referred to in paragraph 1;
 - (c) the bodies designated in accordance with Article 17(3) of Directive 2008/57/EC to carry out the conformity assessment and verification procedures with respect to the open points.

Article 4

Specific cases

1. With regard to specific cases referred to in point 7.7 of the Annex to this Regulation, the conditions to be met for the verification of interoperability pursuant to Article 17(2) of Directive 2008/57/EC shall be the national rules applicable in the Member State which authorises the placing in service of the subsystem covered by this Regulation.
2. Within six months of the entry into force of this Regulation, each Member State shall notify to the other Member States and the Commission the following information:
 - (a) the national rules referred to in paragraph 1;
 - (b) the conformity assessment and verification procedures to be carried out to apply the national rules referred to in paragraph 1;
 - (c) the bodies designated in accordance with Article 17(3) of Directive 2008/57/EC to carry out the conformity assessment and verification procedures in the specific cases set out in point 7.7 of the Annex.

Article 5

Notification of bilateral agreements

1. Member States shall notify the Commission, not later than 1 July 2015, any existing national, bilateral, multilateral or international agreements between Member States and railway undertaking(s), infrastructure managers or non-member countries which are required by the very specific or local nature of the intended rail service or which deliver significant levels of local or regional interoperability.

2. That obligation does not apply to agreements which have already been notified under Decision 2008/217/EC.
3. Member States shall forthwith notify to the Commission of any future agreements or amendments to existing agreements.

Article 6

Projects at an advanced stage of development

In accordance with Article 9(3) of Directive 2008/57/EC, each Member State shall communicate to the Commission within one year of the entry into force of this Regulation the list of projects being implemented within its territory and are at an advanced stage of development.

Article 7

'EC' certificate of verification

1. An 'EC' certificate of verification for a subsystem that contains interoperability constituents which do not have an 'EC' declaration of conformity or suitability for use, may be issued during a transitional period ending on 31 May 2021 provided that the requirements laid down in point 6.5 of the Annex are met.
2. The production, upgrade or renewal of the subsystem with use of the non-certified interoperability constituents shall be completed within the transitional period set out in paragraph 1, including its placing in service.
3. During the transitional period set out in paragraph 1:
 - (a) the reasons for non-certification of any interoperability constituents shall be properly identified by the notified body before granting the 'EC' certificate pursuant to Article 18 of Directive 2008/57/EC;
 - (b) the national safety authorities, pursuant to Article 16(2)(c) of Directive 2004/49/EC of the European Parliament and of the Council ⁽¹⁾, shall report on the use of non-certified interoperability constituents in the context of authorisation procedures in their annual report referred to in Article 18 of Directive 2004/49/EC.
4. From 1 January 2016, newly produced interoperability constituents shall be covered by the EC declaration of conformity or suitability for use.

Article 8

Conformity assessment

1. The procedures for assessment of conformity, suitability for use and 'EC' verification set out in section 6 of the Annex shall be based on the modules established in Commission Decision 2010/713/EU ⁽²⁾.
2. The type or design examination certificate of interoperability constituents shall be valid for a seven year period. During that period, new constituents of the same type are permitted to be placed into service without a new conformity assessment.
3. Certificates referred to in paragraph 2 which have been issued according to the requirements of Decision 2011/275/EU [TSI INF CR] or Decision 2008/217/EC [TSI INF HS] remain valid, without a need for a new conformity assessment, until the expiry date originally established. In order to renew a certificate the design or type shall be re-assessed only against new or modified requirements set out in the Annex to this Regulation.

⁽¹⁾ Directive 2004/49/EC of the European Parliament and of the Council of 29 April 2004 on safety on the Community's railways and amending Council Directive 95/18/EC on the licensing of railway undertakings and Directive 2001/14/EC on the allocation of railway infrastructure capacity and the levying of charges for the use of railway infrastructure and safety certification (Railway Safety Directive) (OJ L 164, 30.4.2004, p. 44).

⁽²⁾ Commission Decision 2010/713/EU of 9 November 2010 on modules for the procedures for assessment of conformity, suitability for use and EC verification to be used in the technical specifications for interoperability adopted under Directive 2008/57/EC of the European Parliament and of the Council (OJ L 319, 4.12.2010, p. 1.)

*Article 9***Implementation**

1. Section 7 of the Annex sets out the steps to be followed for the implementation of a fully interoperable infrastructure subsystem.

Without prejudice to Article 20 of Directive 2008/57/EC, Member States shall prepare a national implementation plan, describing their actions to comply with this TSI, in accordance with section 7 of the Annex. Member States shall send their national implementation plan to the other Member States and the Commission by 31 December 2015. Member States that have already sent their implementation plan do not have to send it again.

2. Pursuant to Article 20 of Directive 2008/57/EC, when a new authorisation is required and if the TSI is not fully applied, Member States shall notify the following information to the Commission:

- (a) the reason why the TSI is not fully applied;
- (b) the technical characteristics applicable instead of the TSI;
- (c) the bodies responsible for applying the verification procedure referred to in Article 18 of the Directive 2008/57/EC.

3. Member States shall send to the Commission a report on the implementation of Article 20 of Directive 2008/57/EC three years after 1 January 2015. This report shall be discussed in the Committee set up by Article 29 of Directive 2008/57/EC and, where appropriate, the TSI in the Annex shall be adapted.

*Article 10***Innovative solutions**

1. In order to keep pace with technological progress, innovative solutions may be required, which do not comply with the specifications set out in the Annex or for which the assessment methods set out in the Annex cannot be applied.

2. Innovative solutions may relate to the infrastructure subsystem, its parts and its interoperability constituents.

3. If an innovative solution is proposed, the manufacturer or his authorised representative established within the Union shall declare how it deviates from or complements to the relevant provisions of this TSI and submit the deviations to the Commission for analysis. The Commission may request the opinion of the Agency on the proposed innovative solution.

4. The Commission shall deliver an opinion on the proposed innovative solution. If this opinion is positive, the appropriate functional and interface specifications and the assessment method, which need to be included in the TSI in order to allow the use of this innovative solution, shall be developed and subsequently integrated in the TSI during the revision process pursuant to Article 6 of Directive 2008/57/EC. If the opinion is negative, the innovative solution proposed cannot be used.

5. Pending the review of the TSI, the positive opinion delivered by the Commission shall be considered as an acceptable means of compliance with the essential requirements of Directive 2008/57/EC and may be used for the assessment of the subsystem.

*Article 11***Repeal**

Decisions 2008/217/EC and 2011/275/EU are repealed with effect from 1 January 2015.

They shall however continue to apply to:

- (a) subsystems authorised in accordance with those Decisions;
- (b) projects for new, renewed or upgraded subsystems which, at the date of publication of this Regulation, are at an advanced stage of development or are the subject of an on-going contract.

*Article 12***Entry into force**

This Regulation shall enter into force on the twentieth day following that of its publication in the *Official Journal of the European Union*.

It shall apply from 1 January 2015. However, an authorisation for placing in service may be granted in accordance with the TSI as set out in the Annex to this Regulation before 1 January 2015.

This Regulation shall be binding in its entirety and directly applicable in all Member States.

Done at Brussels, 18 November 2014.

For the Commission
The President
Jean-Claude JUNCKER

ANNEX

TABLE OF CONTENTS

1.	Introduction	11
1.1.	Technical Scope	11
1.2.	Geographical Scope	11
1.3.	Content of this TSI	11
2.	Definition and scope of subsystem	11
2.1.	Definition of the infrastructure subsystem	11
2.2.	Interfaces of this TSI with other TSIs	12
2.3.	Interfaces of this TSI with the Persons with Reduced Mobility TSI	12
2.4.	Interfaces of this TSI with the Safety in Railway Tunnels TSI	12
2.5.	Relation to the safety management system	12
3.	Essential requirements	12
4.	Description of the infrastructure subsystem	15
4.1.	Introduction	15
4.2.	Functional and technical specifications of subsystem	16
4.2.1.	TSI Categories of Line	16
4.2.2.	Basic parameters characterising the infrastructure subsystem	18
4.2.3.	Line layout	20
4.2.4.	Track parameters	22
4.2.5.	Switches and crossings	27
4.2.6.	Track resistance to applied loads	27
4.2.7.	Structures resistance to traffic loads	28
4.2.8.	Immediate action limits on track geometry defects	30
4.2.9.	Platforms	33
4.2.10.	Health, safety and environment	34
4.2.11.	Provision for operation	35
4.2.12.	Fixed installations for servicing trains	36
4.3.	Functional and technical specification of the interfaces	36
4.3.1.	Interfaces with the rolling stock subsystem	37
4.3.2.	Interfaces with the energy subsystem	39
4.3.3.	Interfaces with the control command and signalling subsystem	39
4.3.4.	Interfaces with the operation and traffic management subsystem	40
4.4.	Operating rules	40

4.5.	Maintenance rules	40
4.5.1.	Maintenance file	40
4.5.2.	Maintenance plan	41
4.6.	Professional qualifications	41
4.7.	Health and safety conditions	41
5.	Interoperability constituents	41
5.1.	Basis on which interoperability constituents have been selected	41
5.2.	List of constituents	41
5.3.	Constituents performances and specifications	41
5.3.1.	The rail	41
5.3.2.	The rail fastening systems	42
5.3.3.	Track sleepers	42
6.	Assessment of conformity of interoperability constituents and EC verification of the subsystems	42
6.1.	Interoperability Constituents	42
6.1.1.	Conformity assessment procedures	42
6.1.2.	Application of modules	43
6.1.3.	Innovative solutions for interoperability constituents	43
6.1.4.	EC declaration of conformity for interoperability constituents	43
6.1.5.	Particular assessment procedures for interoperability constituents	44
6.2.	Infrastructure subsystem	44
6.2.1.	General provisions	44
6.2.2.	Application of modules	45
6.2.3.	Innovative solutions	45
6.2.4.	Particular assessment procedures for infrastructure subsystem	45
6.2.5.	Technical solutions giving presumption of conformity at design stage	48
6.3.	EC Verification when speed is used as a migration criterion	49
6.4.	Assessment of maintenance file	49
6.5.	Subsystems containing Interoperability constituents not holding an EC declaration	49
6.5.1.	Conditions	49
6.5.2.	Documentation	50
6.5.3.	Maintenance of the subsystems certified according to 6.5.1.	50
6.6.	Subsystem containing serviceable interoperability constituents that are suitable for reuse	50
6.6.1.	Conditions	50
6.6.2.	Documentation	50
6.6.3.	Use of serviceable interoperability constituents in maintenance	51

7.	Implementation of the infrastructure TSI	51
7.1.	Application of this TSI to railway lines	51
7.2.	Application of this TSI to new railway lines	51
7.3.	Application of this TSI to existing railway lines	51
7.3.1.	Upgrading of a line	51
7.3.2.	Renewal of a line	52
7.3.3.	Substitution in the framework of maintenance	52
7.3.4.	Existing lines that are not subject to a renewal or upgrading project	52
7.4.	Application of this TSI to existing platforms	53
7.5.	Speed as an implementation criterion	53
7.6.	Ascertain Compatibility of infrastructure and rolling stock after authorisation of rolling stock	53
7.7.	Specific cases	53
7.7.1.	Particular features on the Austrian network	53
7.7.2.	Particular features on the Belgian network	54
7.7.3.	Particular features on the Bulgarian network	54
7.7.4.	Particular features on the Danish network	54
7.7.5.	Particular features on the Estonian network	54
7.7.6.	Particular features on the Finnish network	55
7.7.7.	Particular features on the French network	58
7.7.8.	Particular features on the German network	58
7.7.9.	Particular features on the Hellenic network	58
7.7.10.	Particular features on the Italian network	58
7.7.11.	Particular features on the Latvian network	59
7.7.12.	Particular features on the Polish network	60
7.7.13.	Particular features on the Portuguese network	62
7.7.14.	Particular features on the Ireland network	64
7.7.15.	Particular features on the Spanish network	65
7.7.16.	Particular features on the Swedish network	68
7.7.17.	Particular features on the UK network for Great Britain	68
7.7.18.	Particular features on the UK network for Northern Ireland	70
7.7.19.	Particular features on the Slovak network	70

Appendix A — Assessment of interoperability constituents	75
Appendix B — Assessment of the infrastructure subsystem	76
Appendix C — Technical characteristics of track design and switches and crossings design	79
Appendix D — Conditions of use of track design and switches and crossings design	81
Appendix E — Capability requirements for structures according to traffic code	82
Appendix F — Capability requirements for structures according to traffic code in the United Kingdom of Great Britain and Northern Ireland	84
Appendix G — Speed conversion to miles per hour for Ireland and the United Kingdom of Great Britain and Northern Ireland	86
Appendix H — Structure gauge for the 1 520 mm track gauge system	87
Appendix I — Reverse curves with radii in the range from 150 m up to 300 m	89
Appendix J — Safety assurance over fixed obtuse crossings	91
Appendix K — Basis of minimum requirements for structures for passenger coaches and multiple units	95
Appendix L — Definition of EN line category a12 for traffic code P6	96
Appendix M — Specific case on the Estonian network	97
Appendix N — Specific cases of the Hellenic network	97
Appendix O — Specific case on the Ireland and United Kingdom of Northern Ireland networks	97
Appendix P — Structure gauge for the lower parts for the 1 668 mm track gauge on the Spanish network	98
Appendix Q — National technical rules for UK-GB Specific Cases	100
Appendix R — List of open points	101
Appendix S — Glossary	102
Appendix T — List of referenced standards	108

1. INTRODUCTION

1.1. **Technical Scope**

This TSI concerns the infrastructure subsystem and part of the maintenance subsystem of the Union rail system in accordance with Article 1 of Directive 2008/57/EC.

The infrastructure subsystem is defined in Annex II (2.1) to Directive 2008/57/EC.

The technical scope of this TSI is further defined in Article 2(1), 2(5) and 2(6) of this Regulation.

1.2. **Geographical Scope**

The geographical scope of this TSI is defined in Article 2(4) of this Regulation.

1.3. **Content of this TSI**

(1) In accordance with Article 5(3) of Directive 2008/57/EC, this TSI:

- (a) indicates its intended scope (section 2);
- (b) lays down essential requirements for the infrastructure subsystem (section 3);
- (c) establishes the functional and technical specifications to be met by the subsystem and its interfaces vis-à-vis other subsystems (section 4);
- (d) specifies the interoperability constituents and interfaces which must be covered by European specifications, including European standards, which are necessary to achieve interoperability within the Union rail system (section 5);
- (e) states, in each case under consideration, which procedures are to be used in order to assess the conformity or the suitability for use of the interoperability constituents, on the one hand, or the EC verification of the subsystems, on the other hand (section 6);
- (f) indicates the strategy for implementing this TSI (section 7);
- (g) indicates, for the staff concerned, the professional qualifications and health and safety conditions at work required for the operation and maintenance of the subsystem, as well as for the implementation of this TSI (section 4).

In accordance with Article 5(5) of the Directive 2008/57/EC, provisions for specific cases are indicated in section 7.

(2) Requirements in this TSI are valid for all track gauge systems within the scope of this TSI, unless a paragraph refers to specific track gauge systems or to specific nominal track gauges.

2. DEFINITION AND SCOPE OF SUBSYSTEM

2.1. **Definition of the infrastructure subsystem**

This TSI covers:

- (a) the infrastructure structural subsystem
- (b) the part of the maintenance functional subsystem relating to the infrastructure subsystem (that is: washing plants for external cleaning of trains, water restocking, refuelling, fixed installations for toilet discharge and electrical shore supplies).

The elements of the infrastructure subsystem are described in Annex II (2.1. Infrastructure) to Directive 2008/57/EC.

The scope of this TSI therefore includes the following aspects of the infrastructure subsystem:

- (a) Line layout,
- (b) Track parameters,

- (c) Switches and crossings,
- (d) Track resistance to applied loads,
- (e) Structures resistance to traffic loads,
- (f) Immediate action limits on track geometry defects,
- (g) Platforms,
- (h) Health, safety and environment,
- (i) Provision for operation,
- (j) Fixed installations for servicing trains.

Further details are set out in point 4.2.2 of this TSI.

2.2. Interfaces of this TSI with other TSIs

Point 4.3 of this TSI sets out the functional and technical specification of the interfaces with the following subsystems, as defined in the relevant TSIs:

- (a) Rolling stock subsystem,
- (b) Energy subsystem,
- (c) Control command and signalling subsystem,
- (d) Traffic operation and management subsystem.

Interfaces with the Persons with Reduced Mobility TSI (PRM TSI) are described in point 2.3 below.

Interfaces with the Safety in Railway Tunnels TSI (SRT TSI) are described in point 2.4 below.

2.3. Interfaces of this TSI with the Persons with Reduced Mobility TSI

All requirements relating to the infrastructure subsystem for the access of persons with reduced mobility to the railway system are set out in the Persons with Reduced Mobility TSI.

2.4. Interfaces of this TSI with the Safety in Railway Tunnels TSI

All requirements relating to the infrastructure subsystem for safety in railway tunnels are set out in the Safety in Railway Tunnels TSI.

2.5. Relation to the safety management system

Necessary processes to manage safety according to the requirements in the scope of this TSI, including interfaces to humans, organisations or other technical systems, shall be designed and implemented in the infrastructure manager's safety management system as required by Directive 2004/49/EC.

3. ESSENTIAL REQUIREMENTS

The following table indicates basic parameters of this TSI and their correspondence to the essential requirements as set out and numbered in Annex III to Directive 2008/57/EC.

Table 1

Basic Parameters of the infrastructure subsystem corresponding to the essential requirements

TSI point	Title of TSI point	Safety	Reliability Availability	Health	Environ- mental protection	Technical compa- tibility	Accessi- bility
4.2.3.1	Structure gauge	1.1.1, 2.1.1				1.5	
4.2.3.2	Distance between track centres	1.1.1, 2.1.1				1.5	

TSI point	Title of TSI point	Safety	Reliability Availability	Health	Environ- mental protection	Technical compa- tibility	Accessi- bility
4.2.3.3	Maximum gradients	1.1.1				1.5	
4.2.3.4	Minimum radius of horizontal curve	1.1.3				1.5	
4.2.3.5	Minimum radius of vertical curve	1.1.3				1.5	
4.2.4.1	Nominal track gauge					1.5	
4.2.4.2	Cant	1.1.1, 2.1.1				1.5	1.6.1
4.2.4.3	Cant deficiency	1.1.1				1.5	
4.2.4.4	Abrupt change of cant deficiency	2.1.1					
4.2.4.5	Equivalent conicity	1.1.1, 1.1.2				1.5	
4.2.4.6	Railhead profile for plain line	1.1.1, 1.1.2				1.5	
4.2.4.7	Rail inclination	1.1.1, 1.1.2				1.5	
4.2.5.1	Design geometry of switches and crossings	1.1.1, 1.1.2, 1.1.3				1.5	
4.2.5.2	Use of swing nose crossings	1.1.2, 1.1.3					
4.2.5.3	Maximum unguided length of fixed obtuse crossings	1.1.1, 1.1.2				1.5	
4.2.6.1	Track resistance to vertical loads	1.1.1, 1.1.2, 1.1.3				1.5	
4.2.6.2	Longitudinal track resistance	1.1.1, 1.1.2, 1.1.3				1.5	
4.2.6.3	Lateral track resistance	1.1.1, 1.1.2, 1.1.3				1.5	
4.2.7.1	Resistance of new bridges to traffic loads	1.1.1, 1.1.3				1.5	
4.2.7.2	Equivalent vertical loading for new earthworks and earth pressure effects imposed on new structures	1.1.1, 1.1.3				1.5	

TSI point	Title of TSI point	Safety	Reliability Availability	Health	Environ- mental protection	Technical compa- tibility	Accessi- bility
4.2.7.3	Resistance of new structures over or adjacent to tracks	1.1.1, 1.1.3				1.5	
4.2.7.4	Resistance of existing bridges and earth-works to traffic loads	1.1.1, 1.1.3				1.5	
4.2.8.1	The immediate action limit for alignment	1.1.1, 1.1.2	1.2				
4.2.8.2	The immediate action limit for longitudinal level	1.1.1, 1.1.2	1.2				
4.2.8.3	The immediate action limit for track twist	1.1.1, 1.1.2	1.2				
4.2.8.4	The immediate action limit of track gauge as isolated defect	1.1.1, 1.1.2	1.2				
4.2.8.5	The immediate action limit for cant	1.1.1, 1.1.2	1.2				
4.2.8.6	The immediate action limit for switches and crossings	1.1.1, 1.1.2	1.2			1.5	
4.2.9.1	Usable length of plat- forms	1.1.1, 2.1.1				1.5	
4.2.9.2	Platform height	1.1.1, 2.1.1				1.5	1.6.1
4.2.9.3	Platform offset	1.1.1, 2.1.1				1.5	1.6.1
4.2.9.4	Track layout alongside platforms	1.1.1, 2.1.1				1.5	1.6.1
4.2.10.1	Maximum pressure variations in tunnels	1.1.1, 2.1.1				1.5	
4.2.10.2	Effect of cross winds	1.1.1, 2.1.1	1.2			1.5	
4.2.10.3	Ballast pick-up	1.1.1	1.2			1.5	

TSI point	Title of TSI point	Safety	Reliability Availability	Health	Environ- mental protection	Technical compa- tibility	Accessi- bility
4.2.11.1	Location markers	1.1.1	1.2				
4.2.11.2	Equivalent concity in service	1.1.1, 1.1.2				1.5	
4.2.12.2	Toilet discharge	1.1.5	1.2	1.3.1		1.5	
4.2.12.3	Train external cleaning facilities		1.2			1.5	
4.2.12.4	Water restocking	1.1.5	1.2	1.3.1		1.5	
4.2.12.5	Refuelling	1.1.5	1.2	1.3.1		1.5	
4.2.12.6	Electric shore supply	1.1.5	1.2			1.5	
4.4	Operating rules		1.2				
4.5	Maintenance rules		1.2				
4.6	Professional qualifica- tions	1.1.5	1.2				
4.7	Health and safety conditions	1.1.5	1.2	1.3	1.4.1		

4. DESCRIPTION OF THE INFRASTRUCTURE SUBSYSTEM

4.1. Introduction

- (1) The Union rail system, to which Directive 2008/57/EC applies and of which the infrastructure and maintenance subsystems are parts, is an integrated system whose consistency needs to be verified. This consistency must be checked in particular with regard to the specifications of the infrastructure subsystem, its interfaces in relation to the other subsystems of the Union rail system in which it is integrated, as well as the operating and maintenance rules.
- (2) The limiting values set out in this TSI are not intended to be imposed as usual design values. However the design values must be within the limits set out in this TSI.
- (3) The functional and technical specifications of the subsystem and its interfaces, described in points 4.2 and 4.3, do not impose the use of specific technologies or technical solutions, except where this is strictly necessary for the interoperability of the Union rail system.
- (4) Innovative solutions for interoperability which do not fulfil the requirements specified in this TSI and/or which are not assessable as stated in this TSI require new specifications and/or new assessment methods. In order to allow technological innovation, these specifications and assessment methods shall be developed by the process for innovative solutions described in Article 10.

- (5) Where reference is made to EN standards, any variations called 'national deviations' in the EN do not apply, unless otherwise specified in this TSI.
- (6) Where line speeds are stated in [km/h] as a category or performance parameter in this TSI, it shall be allowed to translate the speed to equivalent [mph] as in Appendix G, for Ireland and for the United Kingdom of Great Britain and Northern Ireland networks.

4.2. Functional and technical specifications of subsystem

4.2.1. TSI Categories of Line

- (1) Annex I to Directive 2008/57/EC recognises that the Union rail network may be subdivided into different categories for the Trans-European conventional rail network (point 1.1), the Trans-European high-speed rail network (point 2.1) and the extension of the scope (point 4.1). In order to deliver interoperability cost-effectively this TSI defines performance levels for 'TSI categories of line'.
- (2) These TSI categories of line shall be used for the classification of existing lines to define a target system so that the relevant performance parameters will be met.
- (3) The TSI category of line shall be a combination of traffic codes. For lines where only one type of traffic is carried (for example a freight only line), a single code can be used to describe the requirements; where mixed traffic runs the category will be described by one or more codes for passenger and freight. The combined traffic codes describe the envelope within which the desired mix of traffic can be accommodated.
- (4) For the purpose of TSI categorisation, lines are classified generically based on the type of traffic (traffic code) characterised by the following performance parameters:
- gauge,
 - axle load,
 - line speed,
 - train length
 - usable length of platform.

The columns for 'gauge' and 'axle load' shall be treated as minimum requirements as they directly control the trains that may run. The columns for 'line speed', 'usable length of platform' and 'train length' are indicative of the range of values that are typically applied for different traffic types and they do not directly impose restrictions on the traffic that may run over the line.

- (5) The performance parameters listed in Table 2 and Table 3 are not intended to be used to directly ascertain the compatibility between rolling stock and infrastructure.
- (6) Information defining the relation between maximum axle load and maximum speed according to type of vehicle is given in Appendix E and Appendix F.
- (7) The performance levels for types of traffic are set out in Table 2 and Table 3 here-under.

Table 2

Performance parameters for passenger traffic

Traffic code	Gauge	Axle load [t]	Line speed [km/h]	Usable length of platform [m]
P1	GC	17 (*)	250-350	400
P2	GB	20 (*)	200-250	200-400
P3	DE3	22,5 (**)	120-200	200-400

Traffic code	Gauge	Axle load [t]	Line speed [km/h]	Usable length of platform [m]
P4	GB	22,5 (**)	120-200	200-400
P5	GA	20 (**)	80-120	50-200
P6	G1	12 (**)	n.a.	n.a.
P1520	S	22,5 (**)	80-160	35-400
P1600	IRL1	22,5 (**)	80-160	75-240

(*) Axle load is based on design mass in working order for power heads (and for P2 locomotives) and operational mass under normal payload for vehicles capable of carrying a payload of passengers or luggage as defined in point 2.1 of EN 15663:2009+AC:2010. The corresponding ** axle load values for vehicles capable of carrying a payload for passengers or luggage are 21,5 t for P1 and 22,5 t for P2 as defined in Appendix K to this TSI.

(**) Axle load is based on design mass in working order for power heads and locomotives as defined in point 2.1 of EN 15663:2009+AC:2010 and design mass under exceptional payload for other vehicles as defined in Appendix K to this TSI.

Table 3

Performance parameters for freight traffic

Traffic code	Gauge	Axle load [t]	Line speed [km/h]	Train length [m]
F1	GC	22,5 (*)	100-120	740-1050
F2	GB	22,5 (*)	100-120	600-1050
F3	GA	20 (*)	60-100	500-1050
F4	G1	18 (*)	n.a.	n.a.
F1520	S	25 (*)	50-120	1050
F1600	IRL1	22,5 (*)	50-100	150-450

(*) Axle load is based on design mass in working order for power heads and locomotives as defined in point 2.1 of EN 15663:2009+AC:2010 and design mass under exceptional payload for other vehicles as defined in Appendix K to this TSI.

- (8) For structures, axle load by itself is not sufficient to define the requirements for infrastructure. Requirements are specified for new structures in point 4.2.7.1.1 and for existing structures in point 4.2.7.4.
- (9) Passenger hubs, freight hubs and connecting lines are included in the above traffic codes, as appropriate.
- (10) Article 5(7) of Directive 2008/57/EC states:

‘The TSIs shall not be an impediment to decisions by the Member States concerning the use of infrastructures for the movement of vehicles not covered by the TSIs.’

It is therefore allowed to design new and upgraded lines such that will also accommodate larger gauges, higher axle loads, greater speeds, greater usable length of platform and longer trains than those specified.

- (11) Without prejudice to Section 7.6 and point 4.2.7.1.2(3), when categorising a new line as P1, it shall be ensured that 'Class I' trains, according to the HS RST TSI (Commission Decision 2008/232/EC ⁽¹⁾), for a speed greater than 250 km/h, can run on that line up to the maximum speed.
- (12) It is permissible for specific locations on the line to be designed for any or all of the performance parameters line speed, usable length of platform and train length less than those set out in Table 2 and Table 3, where duly justified to meet geographical, urban or environmental constraints.

4.2.2. *Basic parameters characterising the infrastructure subsystem*

4.2.2.1. List of Basic Parameters

The Basic Parameters characterising the infrastructure subsystem, grouped according to the aspects listed in point 2.1, are:

A. **Line layout:**

- (a) Structure gauge (4.2.3.1),
- (b) Distance between track centres (4.2.3.2),
- (c) Maximum gradients (4.2.3.3),
- (d) Minimum radius of horizontal curve (4.2.3.4),
- (e) Minimum radius of vertical curve (4.2.3.5),

B. **Track parameters:**

- (a) Nominal track gauge (4.2.4.1),
- (b) Cant (4.2.4.2),
- (c) Cant deficiency (4.2.4.3),
- (d) Abrupt change of cant deficiency (4.2.4.4),
- (e) Equivalent conicity (4.2.4.5),
- (f) Railhead profile for plain line (4.2.4.6),
- (g) Rail inclination (4.2.4.7),

C. **Switches and crossings**

- (a) Design geometry of switches and crossings (4.2.5.1),
- (b) Use of swing nose crossings (4.2.5.2),
- (c) Maximum unguided length of fixed obtuse crossings (4.2.5.3),

D. **Track resistance to applied loads**

- (a) Track resistance to vertical loads (4.2.6.1),
- (b) Longitudinal track resistance (4.2.6.2),
- (c) Lateral track resistance (4.2.6.3),

⁽¹⁾ Commission Decision 2008/232/EC of 21 February 2008 concerning a technical specification for interoperability relating to the rolling stock sub-system of the trans-European high-speed rail system (OJ L 84, 26.3.2008, p. 132).

E. Structures resistance to traffic loads

- (a) Resistance of new bridges to traffic loads (4.2.7.1),
- (b) Equivalent vertical loading for new earthworks and earth pressure effects imposed on new structures (4.2.7.2),
- (c) Resistance of new structures over or adjacent to tracks (4.2.7.3),
- (d) Resistance of existing bridges and earthworks to traffic loads (4.2.7.4),

F. Immediate action limits on track geometry defects

- (a) The immediate action limit for alignment (4.2.8.1),
- (b) The immediate action limit for longitudinal level (4.2.8.2),
- (c) The immediate action limit for track twist (4.2.8.3),
- (d) The immediate action limit of track gauge as isolated defect (4.2.8.4),
- (e) The immediate action limit for cant (4.2.8.5),
- (f) The immediate action limits for switches and crossings (4.2.8.6),

G. Platforms

- (a) Usable length of platforms (4.2.9.1),
- (b) Platform height (4.2.9.2),
- (c) Platform offset (4.2.9.3),
- (d) Track layout alongside platforms (4.2.9.4),

H. Health, safety and environment

- (a) Maximum pressure variation in tunnels (4.2.10.1),
- (b) Effect of crosswinds (4.2.10.2),
- (c) Ballast pick-up (4.2.10.3)

I. Provision for operation

- (a) Location markers (4.2.11.1),
- (b) Equivalent conicity in service (4.2.11.2)

J. Fixed installations for servicing trains

- (a) General (4.2.12.1),
- (b) Toilet discharge (4.2.12.2),
- (c) Train external cleaning facilities (4.2.12.3),
- (d) Water restocking (4.2.12.4),
- (e) Refuelling (4.2.12.5),
- (f) Electric shore supply (4.2.12.6),

K. Maintenance rules

(a) Maintenance file (4.5.1).

4.2.2.2. Requirements for Basic Parameters

- (1) These requirements are described in the following paragraphs, together with any particular conditions that may be allowed in each case for the basic parameters and interfaces concerned.
- (2) The values of basic parameters specified are only valid up to a maximum line speed of 350 km/h.
- (3) For Ireland and for the United Kingdom in respect of Northern Ireland network the values of basic parameters specified are only valid up to a maximum line speed of 165 km/h.
- (4) In case of multi-rail track, requirements of this TSI are to be applied separately to each pair of rails designed to be operated as separate track.
- (5) Requirements for lines representing specific cases are described under point 7.7.
- (6) A short section of track with devices to allow transition between different nominal track gauges is allowed.
- (7) Requirements are described for the subsystem under normal service conditions. Consequences, if any, of the execution of works, which may require temporary exceptions as far as the subsystem performance is concerned, are dealt with in point 4.4.
- (8) The performance levels of trains can be enhanced by adopting specific systems, such as vehicle body tilting. Special conditions are allowed for running such trains, provided they do not entail restrictions for other trains not equipped with such systems.

4.2.3. Line layout

4.2.3.1. Structure gauge

- (1) The upper part of the structure gauge shall be set on the basis of the gauges selected according to point 4.2.1. Those gauges are defined in Annex C and in Annex D, point D.4.8 of EN 15273-3:2013.
- (2) The lower part of the structure gauge shall be GI2 as defined in Annex C of EN 15273-3:2013. Where tracks are equipped with rail brakes, structure gauge GI1 as defined in Annex C of EN 15273-3:2013 shall apply for the lower part of the gauge.
- (3) Calculations of the structure gauge shall be done using the kinematic method in accordance with the requirements of sections 5, 7, 10 and the Annex C and Annex D, point D.4.8 of EN 15273-3:2013.
- (4) Instead of points (1) to (3), for the 1 520 mm track gauge system, all traffic codes selected according to point 4.2.1 are applied with the uniform structure gauge 'S' as defined in Appendix H to this TSI.
- (5) Instead of points (1) to (3), for the 1 600 mm track gauge system, all traffic codes selected according to point 4.2.1 are applied with the uniform structure gauge IRL1 as defined in Appendix O to this TSI.

4.2.3.2. Distance between track centres

- (1) The distance between track centres shall be set on the basis of the gauges selected according to point 4.2.1.
- (2) The nominal horizontal distance between track centres for new lines shall be specified for the design and shall not be smaller than the values from the Table 4; it considers margins for aerodynamic effects.

Table 4

Minimum nominal horizontal distance between track centres

Maximum allowed speed [km/h]	Minimum nominal horizontal distance between track centres [m]
$160 < v \leq 200$	3,80
$200 < v \leq 250$	4,00
$250 < v \leq 300$	4,20
$v > 300$	4,50

- (3) The distance between track centres shall at least satisfy the requirements for the limit installation distance between track centres, defined according section 9 of EN 15273-3:2013.
- (4) Instead of points (1) to (3), for the 1 520 mm track gauge system, the nominal horizontal distance between track centres shall be specified for the design and shall not be smaller than the values from the Table 5; it considers margins for aerodynamic effects.

Table 5

Minimum nominal horizontal distance between track centres for the 1 520 mm track gauge system

Maximum allowed speed [km/h]	Minimum nominal horizontal distance between track centres [m]
$v \leq 160$	4,10
$160 < v \leq 200$	4,30
$200 < v \leq 250$	4,50
$v > 250$	4,70

- (5) Instead of point (2), for the 1 668 mm track gauge system, the nominal horizontal distance between track centres for new lines shall be specified for the design and shall not be smaller than the values from the Table 6, it considers margins for aerodynamic effects.

Table 6

Minimum nominal horizontal distance between track centres for the 1 668 mm track gauge system

Maximum allowed speed [km/h]	Minimum nominal horizontal distance between track centres [m]
$160 < v \leq 200$	3,92
$200 < v < 250$	4,00
$250 \leq v \leq 300$	4,30
$300 < v \leq 350$	4,50

- (6) Instead of points (1) to (3), for the 1 600 mm track gauge system, the distance between track centres shall be set on the basis of the gauges selected according to point 4.2.1. The nominal horizontal distance between track centres shall be specified for the design and shall not be less than 3,57 m for gauge IRL1; it considers margins for aerodynamic effects.

4.2.3.3. Maximum gradients

- (1) Gradients of tracks through passenger platforms of new lines shall not be more than 2,5 mm/m, where vehicles are intended to be regularly attached or detached.
- (2) Gradients of new stabling tracks intended for parking rolling stock shall not be more than 2,5 mm/m unless specific provision is made to prevent the rolling stock from running away.
- (3) Gradients as steep as 35 mm/m are allowed for main tracks on new P1 lines dedicated to passenger traffic at the design phase provided the following 'envelope' requirements are observed:
- (a) the slope of the moving average profile over 10 km is less than or equal to 25 mm/m.
 - (b) the maximum length of continuous 35 mm/m gradient does not exceed 6 km.

4.2.3.4. Minimum radius of horizontal curve

The minimum design radius of horizontal curve shall be selected with regard to the local design speed of the curve.

- (1) The minimum horizontal design curve radius for new lines shall not be less than 150 m.
- (2) Reverse curves (other those in marshalling yards where wagons are shunted individually) with radii in the range from 150 m up to 300 m for new lines shall be designed to prevent buffer locking. For straight intermediate track elements between the curves, Table 43 and Table 44 of Appendix I shall apply. For non-straight intermediate track elements, a detailed calculation shall be made in order to check the magnitude of the end throw differences.
- (3) Instead of point (2), for the 1 520 mm track gauge system, reverse curves with radii in the range from 150 m up to 250 m shall be designed with a section of straight track of at least 15 m between the curves.

4.2.3.5. Minimum radius of vertical curve

- (1) The radius of vertical curves (except for humps in marshalling yards) shall be at least 500 m on a crest or 900 m in a hollow.
- (2) For humps in marshalling yards the radius of vertical curves shall be at least 250 m on a crest or 300 m in a hollow.
- (3) Instead of point (1), for the 1 520 mm track gauge system the radius of vertical curves (except the marshalling yards) shall be at least 5 000 m both on a crest and in a hollow.
- (4) Instead of point (2), for the 1 520 mm track gauge system and for humps in marshalling yards the radius of vertical curves shall be at least 350 m on a crest and 250 m in a hollow.

4.2.4. Track parameters

4.2.4.1. Nominal track gauge

- (1) European standard nominal track gauge shall be 1 435 mm.
- (2) Instead of point (1), for the 1 520 mm track gauge system the nominal track gauge shall be 1 520 mm.

(3) Instead of point (1), for the 1 668 mm track gauge system, the nominal track gauge shall be 1 668 mm.

(4) Instead of point (1), for the 1 600 mm track gauge system the nominal track gauge shall be 1 600 mm.

4.2.4.2. Cant

(1) The design cant for lines shall be limited as defined in Table 7.

Table 7

Design cant [mm]

	Freight and mixed traffic	Passenger traffic
Ballasted track	160	180
Non ballasted track	170	180

(2) The design cant on tracks adjacent to station platforms where trains are intended to stop in normal service shall not exceed 110 mm.

(3) New lines with mixed or freight traffic on curves with a radius less than 305 m and a cant transition steeper than 1 mm/m, the cant shall be restricted to the limit given by the following formula

$$D \leq (R - 50)/1,5$$

where D is the cant in mm and R is the radius in m.

(4) Instead of points (1) to (3), for the 1 520 mm track gauge system the design cant shall not exceed 150 mm.

(5) Instead of point (1), for the 1 668 mm track gauge system, the design cant shall not exceed 180 mm.

(6) Instead of point (2), for the 1 668 mm track gauge system, the design cant on tracks adjacent to station platforms where trains are intended to stop in normal service shall not exceed 125 mm.

(7) Instead of point (3), for the 1 668 mm track gauge system, for new lines with mixed or freight traffic on curves with a radius less than 250 m, the cant shall be restricted to the limit given by the following formula:

$$D \leq 0,9 * (R - 50)$$

where D is the cant in mm and R is the radius in m.

(8) Instead of point (1), for the 1 600 mm track gauge system the design cant shall not exceed 185 mm.

4.2.4.3. Cant deficiency

(1) The maximum values for cant deficiency are set out in Table 8.

Table 8

Maximum cant deficiency [mm]

Design speed [km/h]	$v \leq 160$	$160 < v \leq 300$	$v > 300$
For operation of rolling stock conforming to the Locomotives and Passenger TSI	153		100
For operation of rolling stock conforming to the Freight Wagons TSI	130	—	—

- (2) It is permissible for trains specifically designed to travel with higher cant deficiency (for example multiple units with axle loads lower than set out in table 2; vehicles with special equipment for the negotiation of curves) to run with higher cant deficiency values, subject to a demonstration that this can be achieved safely.
- (3) Instead of point (1), for all types of rolling stock of the 1 520 mm track gauge system the cant deficiency shall not exceed 115 mm. This is valid for speeds up to 200 km/h.
- (4) Instead of point (1), for the 1 668 mm track gauge system, the maximum values for cant deficiency are set out in Table 9.

Table 9

Maximum cant deficiency for the 1 668 mm track gauge system [mm]

Design speed [km/h]	$v \leq 160$	$160 < v \leq 300$	$v > 300$
For operation of rolling stock conforming to the Locomotives and Passenger TSI	175		115
For operation of rolling stock conforming to the Freight Wagons TSI	150	—	—

4.2.4.4. Abrupt change of cant deficiency

- (1) The maximum values of abrupt change of cant deficiency shall be:
- (a) 130 mm for $v \leq 60$ km/h,
 - (b) 125 mm for $60 \text{ km/h} < v \leq 200$ km/h,
 - (c) 85 mm for $200 \text{ km/h} < v \leq 230$ km/h
 - (d) 25 mm for $v > 230$ km/h.
- (2) Where $v \leq 40$ km/h and cant deficiency ≤ 75 mm both before and after an abrupt change of curvature, the value of abrupt change of cant deficiency may be raised to 150 mm.
- (3) Instead of points (1) and (2), for the 1 520 mm track gauge system the maximum values of abrupt change of cant deficiency shall be:
- (a) 115 mm for $v \leq 200$ km/h,
 - (b) 85 mm for $200 \text{ km/h} < v \leq 230$ km/h,
 - (c) 25 mm for $v > 230$ km/h.
- (4) Instead of point (1), for the 1 668 mm track gauge system, the maximum design values of abrupt change of cant deficiency shall be:
- (a) 110 mm for $v \leq 115$ km/h,
 - (b) $(399-v)/2,6$ [mm] for $115 \text{ km/h} < v \leq 220$ km/h,
 - (c) 70 mm for $220 \text{ km/h} < v \leq 230$ km/h.

Abrupt change of cant deficiency is not allowed for speeds of more than 230 km/h.

4.2.4.5. Equivalent conicity

- (1) The limiting values for equivalent conicity quoted in Table 10 shall be calculated for the amplitude (y) of the wheelset's lateral displacement:

$$\begin{aligned} &— y = 3 \text{ mm,} && \text{if } (TG - SR) \geq 7 \text{ mm} \\ &— y = \left(\frac{(TG - SR) - 1}{2} \right), && \text{if } 5 \text{ mm} \leq (TG - SR) < 7 \text{ mm} \\ &— y = 2 \text{ mm,} && \text{if } (TG - SR) < 5 \text{ mm} \end{aligned}$$

where TG is the track gauge and SR is the distance between the flange contact faces of the wheelset.

- (2) No assessment of equivalent conicity is required for switches and crossings.
- (3) Design values of track gauge, rail head profile and rail inclination for plain line shall be selected to ensure that the equivalent conicity limits set out in Table 10 are not exceeded.

Table 10

Equivalent conicity design limit values

	Wheel profile
Speed range [km/h]	S1002, GV1/40
$v \leq 60$	Assessment not required
$60 < v \leq 200$	0,25
$200 < v \leq 280$	0,20
$v > 280$	0,10

- (4) The following wheelsets shall be modelled passing over the designed track conditions (simulated by calculation according to EN 15302:2008+A1:2010):

- (a) S 1002 as defined in Annex C of EN 13715:2006+A1:2010 with SR1.
- (b) S 1002 as defined in Annex C of EN 13715:2006+A1:2010 with SR2.
- (c) GV 1/40 as defined in Annex B of EN 13715:2006+A1:2010 with SR1.
- (d) GV 1/40 as defined in Annex B of EN 13715:2006+A1:2010 with SR2.

For SR1 and SR2 the following values apply:

- (a) For the 1 435 mm track gauge system SR1 = 1 420 mm and SR2 = 1 426 mm.
- (b) For the 1 524 mm track gauge system SR1 = 1 505 mm and SR2 = 1 511 mm.
- (c) For the 1 600 mm track gauge system SR1 = 1 585 mm and SR2 = 1 591 mm.
- (d) For the 1 668 mm track gauge system SR1 = 1 653 mm and SR2 = 1 659 mm.

- (5) Instead of points (1) to (4), for the 1 520 mm track gauge system, no assessment of equivalent conicity is required.

4.2.4.6. Railhead profile for plain line

- (1) The railhead profile shall be selected from the range set out in Annex A of EN 13674-1:2011, Annex A of EN13674-4:2006+A1:2009 or shall be in accordance with as defined in point (2).
- (2) The design of railhead profiles for plain line shall comprise:
 - (a) a lateral slope on the side of the railhead angled to between vertical and 1/16 with reference to the vertical axis of the railhead;
 - (b) the vertical distance between the top of this lateral slope and the top of the rail shall be less than 20 mm;
 - (c) a radius of at least 12 mm at the gauge corner;
 - (d) the horizontal distance between the crown of the rail and the tangent point shall be between 31 and 37,5 mm.

Figure 1

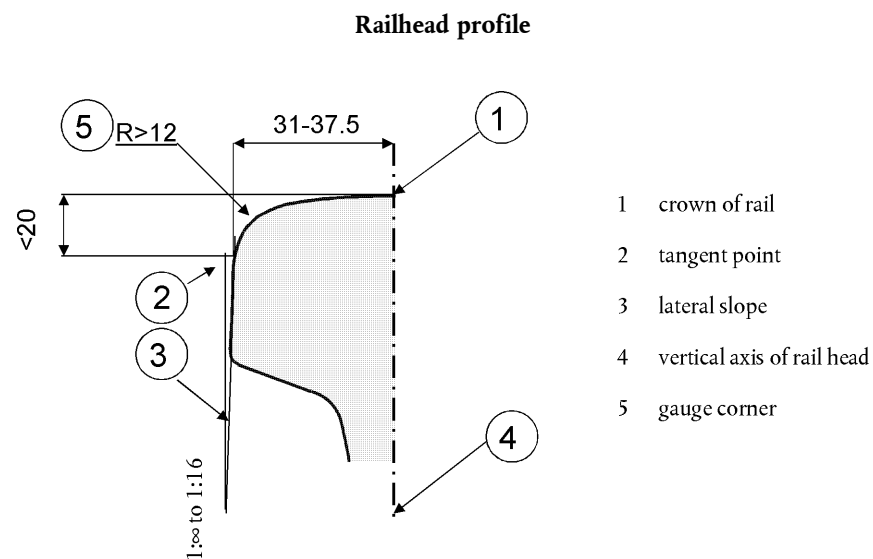

- (3) These requirements are not applicable to expansion devices.

4.2.4.7. Rail inclination

4.2.4.7.1. Plain line

- (1) The rail shall be inclined towards the centre of the track.
- (2) The rail inclination for a given route shall be selected from the range 1/20 to 1/40.
- (3) For sections of not more than 100 m between switches and crossings without inclination where the running speed is no more than 200 km/h, the laying of rails without inclination is allowed.

4.2.4.7.2. Requirements for switches and crossings

- (1) The rail shall be designed to be either vertical or inclined.
- (2) If the rail is inclined, the designed inclination shall be selected from the range 1/20 to 1/40.
- (3) The inclination can be given by the shape of the active part of the rail head profile.
- (4) Within switches and crossings where the running speed is more than 200 km/h and no more than 250 km/h, the laying of rails without inclination is allowed provided that it is limited to sections not exceeding 50 m.
- (5) For speeds of more than 250 km/h the rails shall be inclined.

4.2.5. *Switches and crossings*

4.2.5.1. Design geometry of switches and crossings

Point 4.2.8.6 of this TSI defines immediate action limits for switches and crossings that are compatible with geometrical characteristics of wheelsets as defined in the rolling stock TSIs. It will be the task of the infrastructure manager to decide geometrical design values appropriate to its maintenance plan.

4.2.5.2. Use of swing nose crossing

For speeds higher than 250 km/h switches and crossings shall be equipped with swing-nose crossings.

4.2.5.3. Maximum unguided length of fixed obtuse crossings

The design value of the maximum unguided length of fixed obtuse crossings shall be in accordance with the requirements set out in Appendix J to this TSI.

4.2.6. *Track resistance to applied loads*

4.2.6.1. Track resistance to vertical loads

The track design, including switches and crossings, shall take into account at least the following forces:

- (a) the axle load selected according to point 4.2.1;
- (b) maximum vertical wheel forces. Maximum wheel forces for defined test conditions are defined in EN 14363:2005 point 5.3.2.3.
- (c) vertical quasi-static wheel forces. Maximum quasi-static wheel forces for defined test conditions are defined in EN 14363:2005 points 5.3.2.3.

4.2.6.2. Longitudinal track resistance

4.2.6.2.1. Design forces

The track, including switches and crossings, shall be designed to withstand longitudinal forces equivalent to the force arising from braking of 2,5 m/s² for the performance parameters chosen in accordance with point 4.2.1.

4.2.6.2.2. Compatibility with braking systems

- (1) The track, including switches and crossings, shall be designed to be compatible with the use of magnetic braking systems for emergency braking.
- (2) The requirements for the design of track, including switches and crossings, which are compatible with the use of eddy current braking systems are an open point.
- (3) For the 1 600 mm track gauge system it shall be allowed not to apply point (1).

4.2.6.3. Lateral track resistance

The track design, including switches and crossings, shall take into account at least the following forces:

- (a) lateral forces; Maximum lateral forces exerted by a wheel set on the track for defined test conditions are defined in EN 14363:2005 point 5.3.2.2.
- (b) quasi-static guiding forces; Maximum quasi-static guiding forces Y_{qst} for defined radii and test conditions are defined in EN 14363:2005 point 5.3.2.3.

4.2.7. Structures resistance to traffic loads

The requirements of EN 1991-2:2003/AC:2010 and Annex A2 to EN 1990:2002 issued as EN 1990:2002/A1:2005 specified in this section of the TSI are to be applied in accordance with the corresponding points in the national annexes to these standards if they exist.

4.2.7.1. Resistance of new bridges to traffic loads

4.2.7.1.1. Vertical loads

- (1) Structures shall be designed to support vertical loads in accordance with the following load models, defined in EN 1991-2:2003/AC:2010:
 - (a) Load Model 71, as set out in EN 1991-2:2003/AC:2010 point 6.3.2 (2)P
 - (b) In addition, for continuous bridges, Load Model SW/0, as set out in EN 1991-2:2003/AC:2010 point 6.3.3 (3)P
- (2) The load models shall be multiplied by the factor alpha (a) as set out in EN 1991-2:2003/AC:2010 points 6.3.2 (3)P and 6.3.3 (5)P.
- (3) The value of factor alpha (a) shall be equal to or greater than the values set out in Table 11.

Table 11

Factor alpha (a) for the design of new structures

Type of traffic	Minimum factor alpha (a)
P1, P2, P3, P4	1,0
P5	0,91
P6	0,83
P1520	Open point
P1600	1,1
F1, F2, F3	1,0
F4	0,91
F1520	Open point
F1600	1,1

4.2.7.1.2. Allowance for dynamic effects of vertical loads

- (1) The load effects from the Load Model 71 and Load Model SW/0 shall be enhanced by the dynamic factor phi (Φ) as set out in EN 1991-2:2003/AC:2010 points 6.4.3 (1)P and 6.4.5.2 (2).

(2) For bridges for speeds over 200 km/h where EN 1991-2:2003/AC:2010 paragraph 6.4.4 requires a dynamic analysis to be carried out the structure shall additionally be designed for HSLM defined in EN 1991-2:2003/AC:2010 paragraphs 6.4.6.1.1 (3) to (6) inclusive.

(3) It is permissible to design new bridges such that they will also accommodate an individual passenger train with higher axle loads than covered by HSLM. The dynamic analysis shall be undertaken using the characteristic value of the loading from the individual train taken as the design mass under normal payload in accordance with Appendix K with an allowance for passengers in standing areas in accordance with Note 1 of Appendix K.

4.2.7.1.3. Centrifugal forces

Where the track on a bridge is curved over the whole or part of the length of the bridge, the centrifugal force shall be taken into account in the design of structures as set out in EN 1991-2:2003/AC:2010 paragraphs 6.5.1 (2), (4)P and (7).

4.2.7.1.4. Nosing forces

The nosing force shall be taken into account in the design of structures as set out in EN 1991-2:2003/AC:2010 point 6.5.2.

4.2.7.1.5. Actions due to traction and braking (longitudinal loads)

Traction and braking forces shall be taken into account in the design of structures as set out in EN 1991-2:2003/AC:2010 paragraphs 6.5.3 (2)P, (4), (5), (6).and (7)P.

4.2.7.1.6. Design track twist due to rail traffic actions

The maximum total design track twist due to rail traffic actions shall not exceed the values set out in paragraph A2.4.4.2.2(3)P in Annex A2 to EN 1990:2002 issued as EN 1990:2002/A1:2005.

4.2.7.2. Equivalent vertical loading for new earthworks and earth pressure effects

(1) Earthworks shall be designed and earth pressure effects shall be specified taking into account the vertical loads produced by the Load Model 71, as set out in EN 1991-2:2003/AC:2010 paragraph 6.3.2(2).

(2) The equivalent vertical loading shall be multiplied by the factor alpha (a) as set out in EN 1991-2:2003/AC:2010 paragraph 6.3.2 (3)P. The value of a shall be equal to or greater than the values set out in Table 11.

4.2.7.3. Resistance of new structures over or adjacent to tracks

Aerodynamic actions from passing trains shall be taken into account as set out in EN 1991-2:2003/AC:2010 paragraphs 6.6.2 to 6.6.6 inclusive.

4.2.7.4. Resistance of existing bridges and earthworks to traffic loads

(1) Bridges and earthworks shall be brought to a specified level of interoperability according to the TSI category of line as defined in point 4.2.1.

(2) The minimum capability requirements for structures for each traffic code are given in Appendix E. The values represent the minimum target level that structures must be capable of for the line to be declared interoperable.

(3) The following cases are relevant:

(a) Where an existing structure is replaced by a new structure then the new structure shall be in accordance with the requirements of point 4.2.7.1 or point 4.2.7.2.

(b) If the minimum capability of the existing structures expressed by the published EN line category in combination with the allowed speed satisfies the requirements in Appendix E then the existing structures satisfy the relevant interoperability requirements.

(c) Where the capability of an existing structure does not satisfy the requirements in Appendix E and works (e.g. strengthening) are being carried out to raise the capability of the structure to meet the requirements of this TSI (and the structure is not to be replaced by a new structure) then the structure shall be brought into conformity with the requirements in Appendix E.

(4) For the United Kingdom of Great Britain and Northern Ireland networks, in paragraphs (2) and (3) above the EN line category may be replaced by Route Availability (RA) number (delivered in accordance with the national technical rule notified for this purpose) and consequently reference to Appendix E are replaced by reference to Appendix F.

4.2.8. *Immediate action limits on track geometry defects*

4.2.8.1. The immediate action limit for alignment

(1) The immediate action limits for isolated defects in alignment are set out in point 8.5 of EN 13848-5:2008+A1:2010. Isolated defects shall not exceed the limits of wavelength range D1 as set out in Table 6 of the EN Standard

(2) The immediate action limits for isolated defects in alignment for speeds of more than 300 km/h are an open point.

4.2.8.2. The immediate action limit for longitudinal level

(1) The immediate action limits for isolated defects in longitudinal level are set out in point 8.3 of EN 13848-5:2008+A1:2010. Isolated defects shall not exceed the limits of wavelength range D1 as set out in table 5 of the EN Standard

(2) The immediate action limits for isolated defects in longitudinal level for speeds of more than 300 km/h are an open point.

4.2.8.3. The immediate action limit for track twist

(1) The immediate action limit for track twist as an isolated defect is given as a zero to peak value. Track twist is defined in EN 13848-1:2003+A1:2008 point 4.6.

(2) The track twist limit is a function of the measurement base applied according to EN 13848-5:2008+A1:2010 point 8.6.

(3) The infrastructure manager shall set out in the maintenance plan the base-length on which it will measure the track in order to check compliance with this requirement. The base-length of measurement shall include at least one base between 2 and 5 m.

(4) Instead of points (1) and (2), for the 1 520 mm track gauge system the track twist, for a base length of 10 m, shall be not more than:

(a) 16 mm for passenger lines with $v > 120$ km/h or freight lines with $v > 80$ km/h

(b) 20 mm for passenger lines with $v \leq 120$ km/h or freight lines with $v \leq 80$ km/h

(5) Instead of point (3), for the 1 520 mm track gauge system the Infrastructure Manager shall set out in the maintenance plan the base-length on which it will measure the track in order to check compliance with this requirement. The base-length of measurement shall include at least one base of 10 m.

(6) Instead of point (2), for the 1 668 mm track gauge system, the track twist limit is a function of the measurement base applied according to one of the following equations depending on the cant:

(a) Twist limit = $(20/l + 3)$ for $u \leq 0,67 \times (r - 100)$ with a maximum value of:

7 mm/m for speeds $v \leq 200$ km/h, 5 mm/m for speed $v > 200$ km/h

(b) Twist limit = $(20/l + 1,5)$ for $0,67 \times (r - 100) < u < 0,9 \times (r - 50)$ with a maximum value of:

6 mm/m for $l \leq 5$ m, 3 mm/m for $l > 13$ m

u = cant (mm), l = twist base length (m), r = horizontal curve radius (m)

4.2.8.4. The immediate action limit of track gauge as an isolated defect

- (1) The immediate action limits of track gauge as an isolated defect are set out in Table 12.

Table 12

Immediate action limits of track gauge

Speed [km/h]	Dimensions [mm]	
	Minimum track gauge	Maximum track gauge
$v \leq 120$	1 426	1 470
$120 < v \leq 160$	1 427	1 470
$160 < v \leq 230$	1 428	1 463
$v > 230$	1 430	1 463

- (2) Instead of point (1), for the 1 520 track gauge system the immediate action limits of track gauge as an isolated defect are set out in Table 13.

Table 13

Immediate action limits of track gauge for 1 520 mm track gauge system

Speed [km/h]	Dimensions [mm]	
	Minimum track gauge	Maximum track gauge
$v \leq 140$	1 512	1 548
$v > 140$	1 512	1 536

- (3) Instead of point (1), for the 1 600 track gauge system the immediate action limits of track gauge as an isolated defect are:

- (a) minimum track gauge: 1 591 mm
 (b) maximum track gauge: 1 635 mm.

4.2.8.5. The immediate action limit for cant

- (1) The maximum cant allowed in service is 180 mm.
 (2) The maximum cant allowed in service is 190 mm for dedicated passenger traffic lines.
 (3) Instead of points (1) and (2), for the 1 520 mm track gauge system, the maximum cant allowed in service is 150 mm.
 (4) Instead of points (1) and (2), for the 1 600 mm track gauge system, the maximum cant allowed in service is 185 mm.
 (5) Instead of points (1) and (2), for the 1 668 mm track gauge system, the maximum cant allowed in service is 200 mm.

4.2.8.6. The immediate action limits for switches and crossings

Figure 2

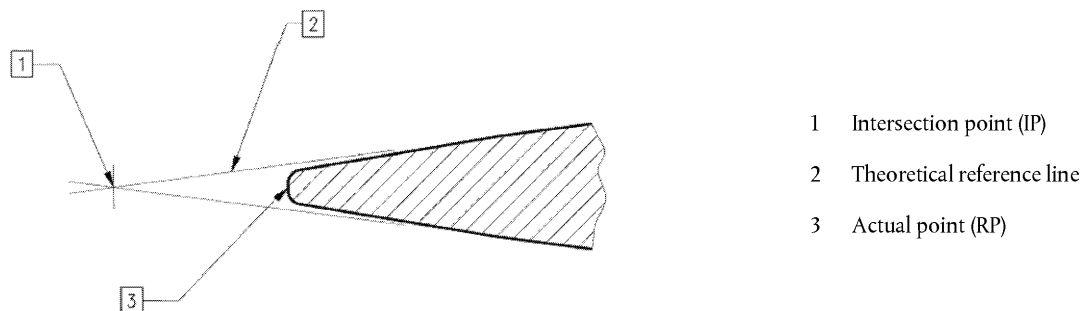
Point retraction in fixed common crossings

(1) The technical characteristics of switches and crossings shall comply with the following in-service values:

(a) Maximum value of free wheel passage in switches: 1 380 mm.

This value can be increased if the infrastructure manager demonstrates that the actuation and locking system of the switch is able to resist the lateral impact forces of a wheelset.

(b) Minimum value of fixed nose protection for common crossings: 1 392 mm.

This value is measured 14 mm below the running surface, and on the theoretical reference line, at an appropriate distance back from the actual point (RP) of the nose as indicated in Figure 2.

For crossings with point retraction, this value can be reduced. In this case the infrastructure manager shall demonstrate that the point retraction is sufficient to guarantee that the wheel will not hit the nose at the actual point (RP).

(c) Maximum value of free wheel passage at crossing nose: 1 356 mm.

(d) Maximum value of free wheel passage at check rail/wing rail entry: 1 380 mm.

(e) Minimum flangeway width: 38 mm.

(f) Minimum flangeway depth: 40 mm.

(g) Maximum height of check rail: 70 mm.

(2) All relevant requirements for switches and crossings are also applicable to other technical solutions using switch rails, for example side modifiers used in multi-rail track.

(3) Instead of point (1), for the 1 520 mm track gauge system the technical characteristics of switches and crossings shall comply with the following in-service values:

(a) Minimum value of bypass at the narrowest location between open switch rail and stock rail is 65 mm.

(b) Minimum value of fixed nose protection for common crossings is 1 472 mm

(c) This value is measured 13 mm below the running surface, and on the theoretical reference line, at an appropriate distance back from the actual point (RP) of the nose as indicated in Figure 2. For crossings with point retraction, this value can be reduced. In this case the Infrastructure Manager shall demonstrate that the point retraction is sufficient to guarantee that the wheel will not hit the nose at the actual point (RP).

- (d) Maximum value of free wheel passage at crossing nose is 1 435 mm
 - (e) Minimum flangeway width is 42 mm
 - (f) Minimum flangeway depth is 40 mm
 - (g) Maximum height of check rail is 50 mm
- (4) Instead of point (1), for the 1 600 mm track gauge system the technical characteristics of switches and crossings shall comply with the following in-service values:

- (a) Maximum value of free wheel passage in switches: 1 546 mm.

This value can be increased if the infrastructure manager demonstrates that the actuation and locking system of the switch is able to resist the lateral impact forces of a wheelset.

- (b) Minimum value of fixed nose protection for common crossings: 1 556 mm.

This value is measured 14 mm below the running surface, and on the theoretical reference line, at an appropriate distance back from the actual point (RP) of the nose as indicated in Figure 2.

For crossings with point retraction, this value can be reduced. In this case the infrastructure manager shall demonstrate that the point retraction is sufficient to guarantee that the wheel will not hit the nose at the actual point (RP).

- (c) Maximum value of free wheel passage at crossing nose: 1 520 mm.
- (d) Maximum value of free wheel passage at check rail/wing rail entry: 1 546 mm.
- (e) Minimum flangeway width: 38 mm.
- (f) Minimum flangeway depth: 40 mm.
- (g) Maximum height of check rail above head of running rail: 25 mm.

4.2.9. Platforms

- (1) The requirements of this point are only applicable to passenger platforms where trains are intended to stop in normal service.
- (2) For the requirements of this point it is permissible to design platforms required for the current service requirement provided provision is made for the reasonably foreseeable future service requirements. When specifying the interfaces with trains intended to stop at the platform, consideration shall be given to both the current service requirements and the reasonably foreseeable service requirements at least 10 years following the bringing into service of the platform.

4.2.9.1. Usable length of platforms

The usable length of a platform shall be defined according to point 4.2.1.

4.2.9.2. Platform height

- (1) The nominal platform height shall be 550 mm or 760 mm above the running surface for radii of 300 m or more.
- (2) For smaller radii the nominal platform height may be adjusted depending on the platform offset to minimise the stepping distance between the train and the platform.

- (3) For platforms where trains, which are outside the scope of the LOC&PAS TSI, are intended to stop, different provisions for the nominal platform height might apply.
- (4) Instead of points (1) and (2), for the 1 520 mm track gauge system the nominal platform height shall be 200 mm or 550 mm above the running surface.
- (5) Instead of points (1) and (2), for the 1 600 mm track gauge system the nominal platform height shall be 915 mm above the running surface.

4.2.9.3. Platform offset

- (1) The distance between the track centre and the platform edge parallel to the running plane (b_q), as defined in chapter 13 of EN 15273-3:2013, shall be set on the basis of the installation limit gauge ($b_{q\text{lim}}$). The installation limit gauge shall be calculated on the basis of the gauge G1.
- (2) The platform shall be built close to the gauge within a maximum tolerance of 50 mm. The value for b_q shall therefore respond to:

$$b_{q\text{lim}} \leq b_q \leq b_{q\text{lim}} + 50 \text{ mm.}$$

- (3) Instead of points (1) and (2), for the 1 520 mm track gauge system the platform offset shall be:

- (a) 1 920 mm for platforms with heights of 550 mm and
- (b) 1 745 mm for platforms with height of 200 mm.

- (4) Instead of points (1) and (2), for the 1 600 mm track gauge system the platform offset shall be 1 560 mm.

4.2.9.4. Track layout alongside platforms

- (1) Track adjacent to the platforms for new lines shall preferably be straight, but shall nowhere have a radius of less than 300 m.
- (2) No values are specified for an existing track alongside new, renewed or upgraded platforms.

4.2.10. Health, safety and environment

4.2.10.1. Maximum pressure variations in tunnels

- (1) Any tunnel or underground structure intended to be operated at speeds greater than or equal to 200 km/h has to provide that maximum pressure variation, caused by the passage of a train running at the maximum allowed speed in the tunnel, do not exceed 10 kPa during the time taken for the train to pass through the tunnel.
- (2) Above requirement has to be fulfilled along the outside of any train complying with the Locomotives and Passenger TSI.

4.2.10.2. Effect of crosswinds

- (1) A line is interoperable from the cross wind point of view if safety is ensured for a reference train running along that line under the most critical operational conditions.
- (2) The rules for proving conformity shall take into account the characteristic wind curves of the reference trains defined in the LOC&PAS TSI.

(3) If safety cannot be achieved without mitigating measures, either due to the geographic situation or to other specific features of the line, the infrastructure manager shall take the necessary measures to maintain the safety, for example by:

- locally reducing train speeds, possibly temporarily during periods at risk of storms,
- installing equipment to protect the track section concerned from cross winds,
- other appropriate means.

(4) It shall be demonstrated that safety is achieved after measures taken.

4.2.10.3. Ballast pick-up

(1) The aerodynamic interaction between rolling stock and infrastructure may cause the lifting and further blowing away of ballast stones from the track bed.

(2) The requirements for the infrastructure subsystem aimed at mitigating the risk for 'ballast pick up' apply only to lines with maximum speed greater than or equal to 200 km/h.

(3) The requirements of point (2) above are an open point.

4.2.11. Provision for operation

4.2.11.1. Location markers

Location markers shall be provided at nominal intervals along the track of not more than 1 000 m.

4.2.11.2. Equivalent conicity in service

(1) If ride instability is reported, the railway undertaking and the infrastructure manager shall localise the section of the line in a joint investigation according paragraphs (2) and (3) hereafter.

Note: This joint investigation is also specified in point 4.2.3.4.3.2 of TSI LOC & PAS for action on rolling stock.

(2) The infrastructure manager shall measure the track gauge and the railhead profiles at the site in question at a distance of approximate 10 m. The mean equivalent conicity over 100 m shall be calculated by modelling with the wheelsets (a) – (d) mentioned in paragraph 4.2.4.5(4) of this TSI in order to check for compliance, for the purpose of the joint investigation, with the limit equivalent conicity for the track specified in Table 14.

Table 14

Equivalent conicity in service limit values for the track (for the purpose of joint investigation)

Speed range [km/h]	Maximum value of mean equivalent conicity over 100 m
$v \leq 60$	assessment not required
$60 < v \leq 120$	0,40
$120 < v \leq 160$	0,35
$160 < v \leq 230$	0,30
$v > 230$	0,25

- (3) If the mean equivalent conicity over 100 m complies with the limit values in Table 14, a joint investigation by the railway undertaking and the infrastructure manager shall be undertaken to specify the reason for the instability.

4.2.12. *Fixed installations for servicing trains*

4.2.12.1. General

This point 4.2.12 sets out the infrastructure elements of the maintenance subsystem required for servicing trains.

4.2.12.2. Toilet discharge

Fixed installations for toilet discharge shall be compatible with the characteristics of the retention toilet system specified in the rolling stock TSI.

4.2.12.3. Train external cleaning facilities

- (1) Where a washing plant is provided it shall be able to clean the outer sides of single or double-deck trains between a height of:

- (a) 500 to 3 500 mm for a single-deck train,
- (b) 500 to 4 300 mm for double-deck trains.

- (2) The washing plant shall be designed so that trains can be driven through it at any speed between 2 km/h and 5 km/h.

4.2.12.4. Water restocking

- (1) Fixed equipment for water restocking shall be compatible with the characteristics of the water system specified in the rolling stock TSI.
- (2) Fixed equipment for drinking water supply on the interoperable network shall be supplied with drinking water meeting the requirements of Council Directive 98/83/EC ⁽¹⁾.

4.2.12.5. Refuelling

Refuelling equipment shall be compatible with the characteristics of the fuel system specified in the rolling stock TSIs.

4.2.12.6. Electrical shore supply

Where provided, electrical shore supply shall be by means of one or more of the power supply systems specified in the rolling stock TSIs.

4.3. **Functional and technical specification of the interfaces**

From the standpoint of technical compatibility, the interfaces of the infrastructure subsystem with the other subsystems are like described in the following points.

⁽¹⁾ Council Directive 98/83/EC of 3 November 1998 on the quality of water intended for human consumption (OJ L 330, 5.12.1998, p. 32).

4.3.1. *Interfaces with the rolling stock subsystem*

Table 15

Interfaces with the rolling stock subsystem, 'Locomotives and Passenger Rolling Stock TSI'

Interface	Reference Infrastructure TSI	Reference Locomotives and Passenger Rolling Stock TSI
Track gauge	4.2.4.1 Nominal track gauge 4.2.5.1 Design geometry of switches and crossings 4.2.8.6 The immediate action limits for switches and crossings	4.2.3.5.2.1 <i>Mechanical and geometrical characteristics of wheelset</i> 4.2.3.5.2.3 <i>Variable gauge wheelsets</i>
Gauge	4.2.3.1 Structure gauge 4.2.3.2 Distance between track centres 4.2.3.5 Minimum radius of vertical curve 4.2.9.3 Platform offset	4.2.3.1. <i>Gauging</i>
Axle load and axle spacing	4.2.6.1 Track resistance to vertical loads 4.2.6.3 Lateral track resistance 4.2.7.1 Resistance of new bridges to traffic loads 4.2.7.2 Equivalent vertical loading for new earthworks and earth pressure effects imposed on new structures 4.2.7.4 Resistance of existing bridges and earthworks to traffic loads	4.2.2.10 <i>Load conditions and weighed mass</i> 4.2.3.2.1 <i>Axle load parameter</i>
Running characteristics	4.2.6.1 Track resistance to vertical loads 4.2.6.3 Lateral track resistance 4.2.7.1.4 Nosing forces	4.2.3.4.2.1 <i>Limit values for running safely</i> 4.2.3.4.2.2 <i>Track loading limit values</i>
Ride stability	4.2.4.4 Equivalent conicity 4.2.4.6 Railhead profile for plain line 4.2.11.2 Equivalent conicity in service	4.2.3.4.3 <i>Equivalent conicity</i> 4.2.3.5.2.2 <i>Mechanical and geometrical characteristics of wheels</i>
Longitudinal actions	4.2.6.2 Longitudinal track resistance 4.2.7.1.5 Actions due to traction and braking (longitudinal loads)	4.2.4.5 <i>Braking performance</i>
Minimum horizontal curve radius	4.2.3.4 Minimum radius of horizontal curve	4.2.3.6 <i>Minimum curve radius</i> <i>Annex A, A.1 Buffers</i>
Running dynamic behaviour	4.2.4.3 Cant deficiency	4.2.3.4.2. <i>Running dynamic behaviour</i>
Maximum deceleration	4.2.6.2 Longitudinal track resistance 4.2.7.1.5 Actions due to traction and braking	4.2.4.5 <i>Braking performance</i>

Interface	Reference Infrastructure TSI	Reference Locomotives and Passenger Rolling Stock TSI
Aerodynamic effect	4.2.3.2 Distance between track centres 4.2.7.3 Resistance of new structures over or adjacent to tracks 4.2.10.1 Maximum pressure variations in tunnels 4.2.10.3 Ballast pick up	4.2.6.2.1 <i>Slipstream effects on passengers on platforms and on trackside workers</i> 4.2.6.2.2 <i>Head pressure pulse</i> 4.2.6.2.3 <i>Maximum pressure variations in tunnels</i> 4.2.6.2.5 <i>Aerodynamic effect on ballasted tracks</i>
Crosswind	4.2.10.2 Effect of crosswinds	4.2.6.2.4 <i>Crosswind</i>
Installations for servicing trains	4.2.12.2 Toilet discharge 4.2.12.3 Train external cleaning facilities 4.2.12.4 Water restocking 4.2.12.5 Refuelling 4.2.12.6 Electric shore supply	4.2.11.3 <i>Toilet discharge system</i> 4.2.11.2.2 <i>Exterior cleaning through a washing plant</i> 4.2.11.4 <i>Water refilling equipment</i> 4.2.11.5 <i>Interface for water refilling</i> 4.2.11.7 <i>Refuelling equipment</i> 4.2.11.6 <i>Special requirements for stabling of trains</i>

Table 16

Interfaces with the rolling stock subsystem, 'Freight Wagons TSI'

Interface	Reference Infrastructure TSI	Reference Conventional Rail Freight Wagons TSI
Track gauge	4.2.4.1 Nominal track gauge 4.2.4.6 Railhead profile for plain line 4.2.5.1 Design geometry of switches and crossings 4.2.8.6 The immediate action limits for switches and crossings	4.2.3.6.2 <i>Characteristics of wheelsets</i> 4.2.3.6.3 <i>Characteristics of wheels</i>
Gauge	4.2.3.1 Structure gauge 4.2.3.2 Distance between track centres 4.2.3.5 Minimum radius of vertical curve 4.2.9.3 Platform offset	4.2.3.1 <i>Gauging</i>
Axle load and axle spacing	4.2.6.1 Track resistance to vertical loads 4.2.6.3 Lateral track resistance 4.2.7.1 Resistance of new bridges to traffic loads 4.2.7.2 Equivalent vertical loading for new earthworks and earth pressure effects imposed on new structures 4.2.7.4 Resistance of existing bridges and earthworks to traffic loads	4.2.3.2 <i>Compatibility with load carrying capacity of lines</i>

Interface	Reference Infrastructure TSI	Reference Conventional Rail Freight Wagons TSI
Running dynamic behaviour	4.2.8 Immediate action limits on track geometry defects	4.2.3.5.2 <i>Running dynamic behaviour</i>
Longitudinal actions	4.2.6.2 Longitudinal track resistance 4.2.7.1.5 Actions due to traction and braking (longitudinal loads)	4.2.4.3.2 <i>Brake performance</i>
Minimum curve radius	4.2.3.4 Minimum radius of horizontal curve	4.2.2.1. <i>Mechanical interface</i>
Vertical curve	4.2.3.5 Minimum radius of vertical curve	4.2.3.1 <i>Gauging</i>
Crosswind	4.2.10.2 Effect of crosswinds	4.2.6.3 <i>Cross winds</i>

4.3.2. *Interfaces with the energy subsystem*

Table 17

Interfaces with the energy subsystem

Interface	Reference Infrastructure TSI	Reference Energy TSI
Gauge	4.2.3.1 Structure gauge	4.2.10 <i>Pantographs gauge</i>

4.3.3. *Interfaces with the control command and signalling subsystem*

Table 18

Interfaces with the control command and signalling subsystem

Interface	Reference Infrastructure TSI	Reference Control Command and Signalling TSI
Structure gauge set for CCS installations. Visibility of track-side CCS objects.	4.2.3.1 Structure gauge	4.2.5.2 <i>Eurobalise communication (space for installation)</i> 4.2.5.3 <i>Euroloop communication (space for installation)</i> 4.2.10 <i>Train detection systems (space for installation)</i> 4.2.15 <i>Visibility of track-side control-command and signalling objects</i>

4.3.4. *Interfaces with the operation and traffic management subsystem*

Table 19

Interfaces with the operation and traffic management subsystem

Interface	Reference Infrastructure TSI	Reference Operation and Traffic Management TSI
Ride stability	4.2.11.2 Equivalent conicity in service	4.2.3.4.4. <i>Operational quality</i>
Use of eddy current brakes	4.2.6.2 Longitudinal track resistance	4.2.2.6.2 <i>Braking performance</i>
Crosswinds	4.2.10.2 Effect of crosswinds	4.2.3.6.3 <i>Contingency arrangements</i>
Operating rules	4.4 Operating rules	4.1.2.2.2 <i>Modifications to information contained in the route book</i> 4.2.3.6 <i>Degraded operation</i>
Staff competences	4.6 Professional competences	2.2.1 <i>Staff and trains</i>

4.4. **Operating rules**

- (1) Operating rules are developed within the procedures described in the infrastructure manager's safety management system. These rules take into account the documentation related to operation which forms a part of the technical file as required in Article 18(3) and set out in Annex VI (point I.2.4) of Directive 2008/57/EC.
- (2) In certain situations involving pre-planned works, it may be necessary to temporarily suspend the specifications of the infrastructure subsystem and its interoperability constituents defined in sections 4 and 5 of this TSI.

4.5. **Maintenance rules**

- (1) Maintenance rules are developed within the procedures described in the infrastructure manager's safety management system.
- (2) The maintenance file shall be prepared before placing a line into service as the part of the technical file accompanying the declaration of verification
- (3) The maintenance plan shall be drawn up for the subsystem to ensure that the requirements set out in this TSI are maintained during its lifetime.

4.5.1. *Maintenance file*

A maintenance file shall contain at least:

- (a) a set of values for immediate action limits,
 - (b) the measures taken (for example speed restriction, repair time) when prescribed limits are not met,
- related to track geometric quality and limits on isolated defects.

4.5.2. *Maintenance plan*

The infrastructure manager shall have a maintenance plan containing the items listed in point 4.5.1 together with at least the following items related to the same elements:

- (a) a set of values for intervention limits and alert limits,
- (b) a statement about the methods, professional competences of staff and personal protective safety equipment necessary to be used,
- (c) the rules to be applied for the protection of people working on or near the track,
- (d) the means used to check that in-service values are respected.

4.6. **Professional qualifications**

The professional qualifications of staff required for operation and maintenance of the infrastructure subsystem are not set out in this TSI but are described in the infrastructure manager's safety management system.

4.7. **Health and safety conditions**

- (1) The health and safety conditions of staff required for the operation and maintenance of the infrastructure subsystem shall be compliant with the the relevant European and national legislation.
- (2) The issue is covered by the procedures described in the infrastructure manager's safety management system.

5. INTEROPERABILITY CONSTITUENTS

5.1. **Basis on which interoperability constituents have been selected**

- (1) The requirements of point 5.3 are based on a traditional design of ballasted track with Vignole (flat-bottom) rail on concrete or wooden sleepers and fastening providing resistance to longitudinal slip by bearing on the rail foot.
- (2) Components and subassemblies used for the construction of other designs of track are not considered to be interoperability constituents.

5.2. **List of constituents**

- (1) For the purposes of this technical specification for interoperability, only the following elements, whether individual components or subassemblies of the track are declared to be 'interoperability constituents':
 - (a) the rail (5.3.1),
 - (b) the rail fastening systems (5.3.2),
 - (c) track sleepers (5.3.3).
- (2) The following points describe the specifications applicable to each of these constituents.
- (3) Rails, fastenings and sleepers used for short length of track for specific purposes, for example in switches and crossings, at expansion devices, transition slabs and special structures, are not considered to be interoperability constituents.

5.3. **Constituents performances and specifications**

5.3.1. *The rail*

The specifications of the 'rail' interoperability constituent concern the following parameters:

- (a) railhead profile,
- (b) rail steel.

5.3.1.1. Railhead profile

The rail head profile shall fulfil the requirements of point 4.2.4.6 'Railhead profile for plain line'.

5.3.1.2. Rail steel

(1) The rail steel is relevant to the requirements of point 4.2.6 'Track resistance to applied loads'.

(2) The rail steel shall meet the following requirements:

- (a) The rail hardness shall be at least 200 HBW.
- (b) The tensile strength shall be at least 680 MPa.
- (c) Minimum number of cycles at fatigue test without failure shall be at least 5×10^6 .

5.3.2. *The rail fastening systems*

(1) The rail fastening system is relevant to the requirements of point 4.2.6.1 for 'Track resistance to vertical loads', point 4.2.6.2 for 'Longitudinal track resistance' and point 4.2.6.3 for 'Lateral track resistance'.

(2) The rail fastening system shall comply in laboratory test conditions with the following requirements:

- (a) the longitudinal force required to cause the rail to begin to slip (i.e. move in an inelastic way) through a single rail fastening assembly shall be at least 7 kN and for speeds of more than 250 km/h shall be at least 9 kN,
- (b) the rail fastening shall resist application of 3 000 000 cycles of the typical load applied in a sharp curve, such that the performance of the fastening in terms of clamping force and longitudinal restraint is not degraded by more than 20 % and vertical stiffness is not degraded by more than 25 %. The typical load shall be appropriate to:
 - the maximum axle load the rail fastening system is designed to accommodate,
 - the combination of rail, rail inclination, rail pad and type of sleepers with which the fastening system may be used.

5.3.3. *Track sleepers*

(1) Track sleepers shall be designed such that when they are used with a specified rail and rail fastening system they will have properties that are consistent with the requirements of point 4.2.4.1 for 'Nominal track gauge', point 4.2.4.7 for 'Rail inclination' and point 4.2.6 for 'Track resistance to applied loads'.

(2) For the nominal track gauge system of 1 435 mm, the design track gauge for track sleepers shall be 1 437 mm.

6. ASSESSMENT OF CONFORMITY OF INTEROPERABILITY CONSTITUENTS AND EC VERIFICATION OF THE SUBSYSTEMS

Modules for the procedures for assessment of conformity and suitability for use and EC verification are defined in Article 8 of this Regulation.

6.1. **Interoperability Constituents**

6.1.1. *Conformity assessment procedures*

(1) The conformity assessment procedure of interoperability constituents as defined in section 5 of this TSI shall be carried out by application of the relevant modules.

(2) Serviceable interoperability constituents that are suitable for reuse are not subject to the conformity assessment procedures.

6.1.2. *Application of modules*

- (1) The following modules for conformity assessment of interoperability constituents are used:
- (a) CA 'Internal production control'
 - (b) CB 'EC type examination'
 - (c) CC 'Conformity to type based on internal production control'
 - (d) CD 'Conformity to type based on quality management system of the production process'
 - (e) CF 'Conformity to type based on product verification'
 - (f) CH 'Conformity based on full quality management system'
- (2) The modules for conformity assessment of interoperability constituents shall be chosen from those shown in Table 20.

Table 20

Modules for conformity assessment to be applied for interoperability constituents

Procedures	Rail	Rail fastening system	Track sleepers
Placed on the EU market before entry into force of relevant TSIs	CA or CH	CA or CH	
Placed on the EU market after entry into force of relevant TSIs	CB + CC or CB + CD or CB + CF or CH		

- (3) In the case of products placed on the market before the publication of relevant TSIs, the type is considered to have been approved and therefore EC type examination (module CB) is not necessary, provided that the manufacturer demonstrates that tests and verification of interoperability constituents have been considered successful for previous applications under comparable conditions and are in conformity with the requirements of this TSI. In this case these assessments shall remain valid in the new application. If it is not possible to demonstrate that the solution is positively proven in the past, the procedure for interoperability constituents placed on the EU market after publication of this TSI applies.
- (4) The conformity assessment of interoperability constituents shall cover the phases and characteristics as indicated in Table 36 of Appendix A to this TSI.

6.1.3. *Innovative solutions for interoperability constituents*

If an innovative solution is proposed for an interoperability constituent, the procedure described in Article 10 shall apply.

6.1.4. *EC declaration of conformity for interoperability constituents*6.1.4.1. *Interoperability constituents subject to other European Union Directives*

- (1) Article 13(3) of Directive 2008/57/EC, states 'Where the interoperability constituents are the subject of other Community Directives covering other aspects, the EC declaration of conformity or suitability for use shall, in such instances, state that the interoperability constituents also meet the requirements of those other Directives.'
- (2) According to Annex IV (3) of Directive 2008/57/EC, the EC declaration of conformity shall be accompanied by the statement setting out the condition of use.

6.1.4.2. EC declaration of conformity for rails

No statement setting out the conditions of use is required.

6.1.4.3. EC declaration of conformity for rail fastening systems

The EC declaration of conformity shall be accompanied by statement setting out:

- (a) the combination of rail, rail inclination, rail pad and type of sleepers with which the fastening system may be used
- (b) the maximum axle load the rail fastening system is designed to accommodate.

6.1.4.4. EC declaration of conformity for track sleepers

The EC declaration of conformity shall be accompanied by statement setting out:

- (a) the combination of rail, rail inclination and type of rail fastening system with which the sleeper may be used,
- (b) the nominal and design track gauge,
- (c) the combinations of axle load and train speed the track sleeper is designed to accommodate.

6.1.5. *Particular assessment procedures for interoperability constituents*

6.1.5.1. Assessment of rails

Assessment of rail steel shall be done according to the following requirements:

- (a) Rail hardness shall be tested for position RS according to EN 13674-1:2011 paragraph 9.1.8, measured using one specimen (control sample out of production).
- (b) Tensile strength shall be tested according to EN 13674-1:2011 paragraph 9.1.9, measured using one specimen (control sample out of production).
- (c) Fatigue test shall be done according to EN 13674-1:2011 paragraph 8.1 and paragraph 8.4.

6.1.5.2. Assessment of sleepers

- (1) Until 31 May 2021 a design track gauge for track sleepers below 1 437 mm shall be allowed.
- (2) For polyvalent gauge and multiple gauge track sleepers it is allowed not to assess the design track gauge for the nominal track gauge of 1 435 mm.

6.2. **Infrastructure subsystem**

6.2.1. *General provisions*

- (1) At the request of the applicant, the notified body carries out the EC verification of the infrastructure subsystem in accordance with Article 18 of Directive 2008/57/EC and in accordance with the provisions of the relevant modules.
- (2) If the applicant demonstrates that tests or assessments of an infrastructure subsystem or parts of the subsystem are the same as have been successful for previous applications of a design, the notified body shall consider the results of these tests and assessments for the EC verification.
- (3) The EC verification of the infrastructure subsystem shall cover the phases and characteristics indicated in Table 37 in Appendix B to this TSI.
- (4) Performance parameters as set out in point 4.2.1 of this TSI are not subject to the EC verification of the subsystem.

- (5) Particular assessment procedures for specific basic parameters of infrastructure subsystem are set out in point 6.2.4.
- (6) The applicant shall draw up the EC declaration of verification for the infrastructure subsystem in accordance with Article 18 and Annex V of Directive 2008/57/EC.

6.2.2. *Application of modules*

For the EC verification procedure of the infrastructure subsystem, the applicant may choose either:

- (a) Module SG: EC verification based on unit verification, or
- (b) Module SH1: EC verification based on full quality management system plus design examination.

6.2.2.1. *Application of module SG*

In the case where EC verification is most effectively undertaken by using information collected by the infrastructure manager, contracting entity or the main contractors involved (for example data obtained using track recording vehicle or other measuring devices), the notified body shall take this information into account to assess conformity.

6.2.2.2. *Application of module SH1*

The SH1 module may be chosen only where the activities contributing to the proposed subsystem to be verified (design, manufacturing, assembling, installation) are subject to a quality management system for design, production, final product inspection and testing, approved and surveyed by a notified body.

6.2.3. *Innovative solutions*

If an innovative solution is proposed for the infrastructure subsystem, the procedure described in Article 10 shall apply.

6.2.4. *Particular assessment procedures for infrastructure subsystem*

6.2.4.1. *Assessment of Structure gauge*

- (1) Assessment of structure gauge as a design review shall be done against characteristic cross sections using the results of calculations made by infrastructure manager or the contracting entity on the basis of sections 5, 7, 10, Annex C and point D.4.8 of Annex D of EN 15273-3:2013.
- (2) Characteristic cross sections are:
 - (a) track without cant,
 - (b) track with maximum cant,
 - (c) track with a civil engineering structure over the line
 - (d) any other location where the designed installation limit gauge is approached by less than 100 mm or the installation nominal gauge or uniform gauge is approached by less than 50 mm.
- (3) After assembly before putting into service clearances shall be verified at locations where the designed installation limit gauge is approached by less than 100 mm or the installation nominal gauge or uniform gauge is approached by less than 50 mm.
- (4) Instead of point (1), for the 1 520 mm track gauge system assessment of structure gauge as a design review is to be made against characteristic cross sections using the uniform structure gauge 'S' as defined in Appendix H to this TSI.
- (5) Instead of point (1), for the 1 600 mm track gauge system assessment of structure gauge as a design review is to be made against characteristic cross sections using the structure gauge 'IRL1' as defined in Appendix O to this TSI.

6.2.4.2. Assessment of distance between track centres

- (1) A design review for assessment of the distance between track centres shall be done using the results of calculations made by the Infrastructure Manager or the contracting entity on the basis of chapter 9 of EN 15273-3:2013. The nominal distance between track centres shall be checked at the line layout where distances are given in parallel to the horizontal plane. The limit installation distance between track centres shall be checked with the radius and relevant cant.
- (2) After assembly before putting into service, distance between track centres shall be verified at critical locations where the limit installation distance between track centres as defined according chapter 9 of EN 15273-3:2013 is approached by less than 50 mm.
- (3) Instead of point (1), for the 1 520 mm track gauge system a design review for assessment of the distance between track centres is to be made using the results of calculations made by the infrastructure manager or the contracting entity. The nominal distance between track centres shall be checked at the line layout where distances are given in parallel to the horizontal plane. The limit installation distance between track centres shall be checked with the radius and relevant cant.
- (4) Instead of point (2), for the 1 520 mm track gauge system after assembly before putting into service, distance between track centres shall be verified at critical locations where the limit installation distance between track centres is approached by less than 50 mm.

6.2.4.3. Assessment of nominal track gauge

- (1) Assessment of the nominal track gauge at design review shall be done by checking the self-declaration of the applicant.
- (2) Assessment of the nominal track gauge at assembly before putting into service shall be done by checking the interoperability constituent sleeper's certificate. For non-certified interoperability constituents assessment of the nominal track gauge shall be done by checking the self-declaration of the applicant.

6.2.4.4. Assessment of track layout

- (1) At design review the curvature, cant, cant deficiency and abrupt change of cant deficiency shall be assessed against the local design speed.
- (2) Assessment of switches and crossings layout is not required.

6.2.4.5. Assessment of cant deficiency for trains designed to travel with higher cant deficiency

Point 4.2.4.3(2) states that 'It is permissible for trains specifically designed to travel with higher cant deficiency (for example multiple units with lower axle loads; vehicles with special equipment for the negotiation of curves) to run with higher cant deficiency values, subject to a demonstration that this can be achieved safely'. This demonstration is outside the scope of this TSI and thus not subject to a notified body verification of the infrastructure subsystem. The demonstration shall be undertaken by the RU, if necessary in cooperation with the IM.

6.2.4.6. Assessment of design values for equivalent conicity

Assessment of design values for equivalent conicity shall be done using the results of calculations made by the infrastructure manager or the contracting entity on the basis of EN 15302:2008+A1:2010.

6.2.4.7. Assessment of railhead profile

- (1) The design profile of new rails shall be checked against point 4.2.4.6.
- (2) Reused serviceable rails shall not be subject to the requirements for railhead profile as set out in point 4.2.4.6.

6.2.4.8. Assessment of switches and crossings

Assessment of switches and crossings related to points 4.2.5.1 to 4.2.5.3 shall be done by checking that a self-declaration of the infrastructure manager or contracting entity exists.

6.2.4.9. Assessment of new structures, earthworks and earth pressure effects

- (1) Assessment of new structures shall be done by checking the traffic loads and the track twist limit used for design against the minimum requirements of points 4.2.7.1 and 4.2.7.3. The notified body is not required to review the design nor carry out any calculations. When reviewing the value of factor alpha used in the design according to point 4.2.7.1 it is only necessary to check that the value of factor alpha satisfies Table 11.
- (2) Assessment of new earthworks and earth pressure effects shall be done by checking the vertical loads used for design according to requirements of point 4.2.7.2. When reviewing the value of factor alpha used in the design according to point 4.2.7.2 it is only necessary to check that the value of factor alpha satisfies Table 11. The notified body is not required to review the design nor carry out any calculations.

6.2.4.10. Assessment of existing structures

- (1) Assessment of existing structures against the requirements of point 4.2.7.4(3) (b) and (c) shall be done by one of the following methods:
 - (a) check that the values of EN line categories, in combination with the allowed speed published or intended to be published for the lines containing the structures, is in line with the requirements of Appendix E of this TSI,
 - (b) check that the values of EN line categories, in combination with the allowed speed specified for the structures or for the design, is in line with the requirements of Appendix E of this TSI,
 - (c) check the traffic loads specified for the structures or for the design against the minimum requirements of points 4.2.7.1.1 and 4.2.7.1.2. When reviewing the value of factor alpha according to point 4.2.7.1.1 it is only necessary to check that the value of factor alpha is in line with the value of factor alpha mentioned in Table 11.
- (2) It is not required to review the design nor carry out any calculations.
- (3) For existing structures assessment point 4.2.7.4(4) applies respectively.

6.2.4.11. Assessment of platform offset

- (1) Assessment of the distance between the track centre and the platform edge as a design review shall be done using the results of calculations made by the Infrastructure Manager or the contracting entity on the basis of chapter 13 of EN 15273-3:2013.
- (2) After assembly before putting into service clearances shall be verified. The offset is checked at the ends of the platform and every 30 m in straight track and every 10 m in curved track.
- (3) Instead of point (1), for the 1 520 mm track gauge system assessment of the distance between the track centre and the platform edge as a design review shall be done against requirements of point 4.2.9.3. Point (2) applies accordingly.
- (4) Instead of point (1), for the 1 600 mm track gauge system assessment of the distance between the track centre and the platform edge as a design review shall be done against requirements of point 4.2.9.3(4). Point (2) applies accordingly.

6.2.4.12. Assessment of maximum pressure variations in tunnels

- (1) Assessment of maximum pressure variation in the tunnel (10 kPa criterion) shall be done using the results of numerical simulations according to chapters 4 and 6 of EN 14067-5:2006+A1:2010 made by the infrastructure manager or the contracting entity on the basis of all expected operational conditions with the trains complying with the Locomotives and Passengers TSI and intended to run at speeds greater than or equal to 200 km/h in the specific tunnel to be assessed.
- (2) The input parameters to be used are to be such that the reference characteristic pressure signature of the trains set out in the locomotives and passenger rolling stock TSI is fulfilled.

- (3) The reference cross section areas of the interoperable trains (constant along a train) to be considered is to be, independently to each motor or trailer vehicle:
 - (a) 12 m² for vehicles designed for GC and DE3 reference kinematic profile,
 - (b) 11 m² for vehicles designed for GA and GB reference kinematic profile,
 - (c) 10 m² for vehicles designed for G1 reference kinematic profiles.

The vehicle gauge to be considered shall be set on the basis of the gauges selected according to point 4.2.1.

- (4) The assessment may take into account construction features which reduce the pressure variation if any, as well as the tunnel length.
- (5) The pressure variations due to atmospheric or geographical conditions can be neglected.

6.2.4.13. Assessment of effect of crosswinds

This demonstration of the safety is outside the scope of this TSI and thus not subject to a notified body verification. The demonstration shall be undertaken by the infrastructure manager, if necessary in co-operation with the railway undertaking.

6.2.4.14. Assessment of fixed installations for servicing trains

Assessment of fixed installations for servicing trains is in the responsibility of the Member State concerned.

6.2.5. *Technical solutions giving presumption of conformity at design stage*

Presumption of conformity at design stage for technical solutions may be assessed prior and independent from a specific project.

6.2.5.1. Assessment of track resistance for plain line

- (1) The demonstration of conformity of the track to the requirements of point 4.2.6 may be done by reference to an existing track design which meets the operating conditions intended for the subsystem concerned.
- (2) A track design shall be defined by the technical characteristics as set out in Appendix C.1 to this TSI and by its operating conditions as set out in Appendix D.1 to this TSI.
- (3) A track design is considered to be existing, if both of the following conditions are met:
 - (a) the track design has been in normal operation for at least one year and
 - (b) the total tonnage over the track was at least 20 million gross tons for the period of normal operation.
- (4) The operating conditions for an existing track design refer to conditions which have been applied in normal operation.
- (5) The assessment to confirm an existing track design shall be performed by checking that the technical characteristics as set out in Appendix C.1 to this TSI and conditions of use as set out in Appendix D.1 to this TSI are specified and that the reference to the previous use of the track design is available.
- (6) When a previously assessed existing track design is used in a project, the notified body shall only assess that the conditions of use are respected.
- (7) For new track designs that are based on existing track designs, a new assessment can be performed by verifying the differences and evaluating their impact on the track resistance. This assessment may be supported for example by computer simulation or by laboratory or in situ testing.
- (8) A track design is considered to be new, if at least one of the technical characteristics set out in Appendix C to this TSI or one of conditions of use set out in Appendix D to this TSI is changed.

6.2.5.2. Assessment for switches and crossing

- (1) The provisions as set out in point 6.2.5.1 are applicable for the assessment of track resistance for switches and crossings. Appendix C.2 sets out the technical characteristics of switches and crossings design and Appendix D.2 sets out the conditions of use of switches and crossings design.
- (2) Assessment of design geometry of switches and crossings shall be done according to point 6.2.4.8 of this TSI.
- (3) Assessment of maximum unguided length of fixed obtuse crossings shall be done according to point 6.2.4.8 of this TSI.

6.3. **EC Verification when speed is used as a migration criterion**

- (1) Point 7.5 allows a line to be put into service at a lower speed than the ultimate intended speed. This point sets out requirements for EC verification in this case.
- (2) Some limiting values set out in section 4 depend on the intended speed of the route. Conformity should be assessed at the intended ultimate speed; however it is permissible to assess speed dependant characteristics at the lower speed at the time of placing in service.
- (3) The conformity of the other characteristics for the intended speed of the route remains valid.
- (4) To declare the interoperability at this intended speed, it is only necessary to assess the conformity of the characteristics temporarily not respected, when they are brought up to the required level.

6.4. **Assessment of maintenance file**

- (1) Point 4.5 requires the infrastructure manager to have for each interoperable line a maintenance file for the infrastructure subsystem.
- (2) The notified body shall confirm that the maintenance file exists and contains the items listed in point 4.5.1. The notified body is not responsible for assessing the suitability of the detailed requirements set out in the maintenance file.
- (3) The notified body shall include a reference to the maintenance file required by point 4.5.1 of this TSI in the technical file referred to in Article 18(3) of Directive 2008/57/EC.

6.5. **Subsystems containing Interoperability constituents not holding an EC declaration**

6.5.1. *Conditions*

- (1) Until 31 May 2021, a notified body is allowed to issue an EC certificate of verification for a subsystem even if some of the interoperability constituents incorporated within the subsystem are not covered by the relevant EC declarations of conformity and/or suitability for use according to this TSI, if the following criteria are complied with:
 - (a) the conformity of the subsystem has been checked against the requirements of section 4 and in relation to sections 6.2 to 7 (except point 7.7 'Specific Cases') of this TSI by the notified body. Furthermore the conformity of the ICs to section 5 and 6.1 does not apply, and
 - (b) the interoperability constituents, which are not covered by the relevant EC declaration of conformity and/or suitability for use, have been used in a subsystem already approved and put in service in at least one of the Member State before the entry in force of this TSI.
- (2) EC declarations of conformity and/or suitability for use shall not be drawn up for the interoperability constituents assessed in this manner.

6.5.2. *Documentation*

- (1) The EC certificate of verification of the subsystem shall indicate clearly which interoperability constituents have been assessed by the notified body as part of the subsystem verification.
- (2) The EC declaration of verification of the subsystem shall indicate clearly:
 - (a) Which interoperability constituents have been assessed as part of the subsystem;
 - (b) Confirmation that the subsystem contains the interoperability constituents identical to those verified as part of the subsystem;
 - (c) For those interoperability constituents, the reason(s) why the manufacturer did not provide an EC Declaration of conformity and/or suitability for use before its incorporation into the subsystem, including the application of national rules notified under Article 17 of Directive 2008/57/EC.

6.5.3. *Maintenance of the subsystems certified according to 6.5.1.*

- (1) During and after the transition period and until the subsystem is upgraded or renewed (taking into account the decision of Member State on application of TSIs), the interoperability constituents which do not hold an EC Declaration of conformity and/or suitability for use and are of the same type are allowed to be used as maintenance related replacements (spare parts) for the subsystem, under the responsibility of the body responsible for maintenance.
- (2) In any case the body responsible for maintenance must ensure that the components for maintenance related replacements are suitable for their applications, are used within their area of use and enable interoperability to be achieved within the rail system while at the same time meeting the essential requirements. Such components must be traceable and certified in accordance with any national or international rule or any code of practice widely acknowledged in the railway domain.

6.6. **Subsystem containing serviceable interoperability constituents that are suitable for reuse**

6.6.1. *Conditions*

- (1) A notified body is allowed to issue an EC certificate of verification for a subsystem even if some of the interoperability constituents incorporated within the subsystem are serviceable interoperability constituents that are suitable for reuse, if the following criteria are complied with:
 - (a) the conformity of the subsystem has been checked against the requirements of section 4 and in relation to sections 6.2 to 7 (except point 7.7 'Specific Cases') of this TSI by the notified body. Furthermore the conformity of the ICs to 6.1 does not apply, and
 - (b) the interoperability constituents are not covered by the relevant EC declaration of conformity and/or suitability for use.
- (2) EC declarations of conformity and/or suitability for use shall not be drawn up for the interoperability constituents assessed in this manner.

6.6.2. *Documentation*

- (1) The EC certificate of verification of the subsystem shall indicate clearly which interoperability constituents have been assessed by the notified body as part of the subsystem verification.
- (2) The EC declaration of verification of the subsystem shall indicate clearly:
 - (a) Which interoperability constituents are serviceable interoperability constituents that are suitable for reuse;
 - (b) Confirmation that the subsystem contains the interoperability constituents identical to those verified as part of the subsystem.

6.6.3. *Use of serviceable interoperability constituents in maintenance*

- (1) Serviceable interoperability constituents that are suitable for reuse are allowed to be used as maintenance related replacements (spare parts) for the subsystem, under the responsibility of the body responsible for maintenance.
- (2) In any case the body responsible for maintenance must ensure that the components for maintenance related replacements are suitable for their applications, are used within their area of use, and enable interoperability to be achieved within the rail system while at the same time meeting the essential requirements. Such components must be traceable and certified in accordance with any national or international rule, or any code of practice widely acknowledged in the railway domain.

7. IMPLEMENTATION OF THE INFRASTRUCTURE TSI

Member States shall develop a national plan for the implementation of this TSI, considering the coherence of the entire rail system of the European Union. This plan shall include all projects subject to renewal and upgrade of infrastructure subsystems, in line with the details mentioned in points 7.1 to 7.7 here below.

7.1. **Application of this TSI to railway lines**

Sections 4 to 6 and any specific provisions in points 7.2 to 7.6 here below apply in full to the lines within the geographical scope of this TSI, which will be placed in service as interoperable lines after this TSI enters into force.

7.2. **Application of this TSI to new railway lines**

- (1) For the purpose of this TSI a 'new line' means a line that creates a route where none currently exists.
- (2) The following situations, for example to increase speed or capacity, may be considered as an upgraded line rather than a new line:
 - (a) the realignment of part of an existing route,
 - (b) the creation of a bypass,
 - (c) the addition of one or more tracks on an existing route, regardless of the distance between the original tracks and the additional tracks.

7.3. **Application of this TSI to existing railway lines**

7.3.1. *Upgrading of a line*

- (1) In accordance with Article 2(m) of Directive 2008/57/EC, 'upgrading' means any major modification work on a subsystem or part of a subsystem which improves the overall performance of the subsystem.
- (2) The infrastructure subsystem of a line is considered to be upgraded in the context of this TSI when at least the performance parameters axle load or gauge, as defined in point 4.2.1, are changed in order to meet the requirements of another traffic code.
- (3) For other TSI performance parameters, according to Article 20(1) of the Directive 2008/57/EC, Member States decide to what extent the TSI needs to be applied to the project.
- (4) Where Article 20(2) of Directive 2008/57/EC applies because the upgrading is subject of an authorisation of placing into service, Member States shall decide which requirements of the TSI must be applied.
- (5) Where article 20(2) of Directive 2008/57/EC does not apply because the upgrading is not subject of an authorisation of placing into service, compliance with this TSI is recommended. Where compliance is not possible to reach, the contracting entity shall inform the Member State of the reasons thereof.
- (6) For a project including elements not being TSI compliant, the procedures for the assessment of conformity and EC verification to be applied should be agreed with the Member State.

7.3.2. *Renewal of a line*

- (1) In accordance with Article 2(n) of Directive 2008/57/EC, 'renewal' means any major substitution work on a subsystem or part subsystem which does not change the overall performance of the subsystem.
- (2) For this purpose major substitution should be interpreted as a project undertaken to systematically replace elements of a line or a section of a line. Renewal differs from a substitution in the framework of maintenance, referred to in point 7.3.3 below, since it gives the opportunity to achieve a TSI compliant route. A renewal is the same case as upgrading, but without a change in performance parameters.
- (3) Where article 20(2) of Directive 2008/57/EC applies because the renewal is subject of an authorisation of placing into service, Member States shall decide which requirements of the TSI must be applied.
- (4) Where article 20(2) of Directive 2008/57/EC does not apply because the renewal is not subject of an authorisation of placing into service, the conformity with this TSI is recommended. Where compliance is not possible to reach, the contracting entity informs the Member State of the reasons thereof.
- (5) For a project including elements not being TSI compliant, the procedures for the assessment of conformity and EC verification to be applied should be agreed with the Member State.

7.3.3. *Substitution in the framework of maintenance*

- (1) Where the parts of a subsystem on a line are maintained, the formal verification and authorisation for placing into service is not required in accordance with this TSI. However, maintenance replacements should be, as far as it is reasonably practicable, undertaken in accordance with the requirements of this TSI.
- (2) The objective should be that maintenance replacements progressively contribute the development of an interoperable line.
- (3) In order to bring progressively an important part of the infrastructure subsystem in a process towards interoperability, the following group of basic parameters should be adapted together:
 - (a) Line layout,
 - (b) Track parameters,
 - (c) Switches and crossings,
 - (d) Track resistance to applied loads,
 - (e) Structures resistance to traffic loads,
 - (f) Platforms.
- (4) In such cases, it is noted that each of the above elements taken separately cannot ensure compliance of the whole subsystem. The conformity of a subsystem can only be stated when all the elements are compliant with the TSI.

7.3.4. *Existing lines that are not subject to a renewal or upgrading project*

The demonstration of the level of compliance of existing lines with the basic parameters of the TSI is voluntary. The procedure for this demonstration shall be in accordance with Commission Recommendation 2014/881/EU of 18 November 2014 ⁽¹⁾.

⁽¹⁾ Commission Recommendation 2014/881/EU of 18 November 2014 on the procedure for demonstrating the level of compliance of existing railway lines with the basic parameters of the technical specifications for interoperability (See page 520 of this Official Journal).

7.4. **Application of this TSI to existing platforms**

In case of upgrade or renewal of the infrastructure subsystem, the following conditions related to platform height governed by point 4.2.9.2 of this TSI, shall apply:

- (a) It shall be allowed to apply other nominal platform heights for consistency with a particular upgrade or renewal programme of a line or a section of a line.
- (b) It shall be allowed to apply other nominal platform heights, if the work requires structural alterations to any load bearing element.

7.5. **Speed as an implementation criterion**

- (1) It is permissible to bring a line into service as an interoperable line at a lower speed than its intended ultimate line speed. However, when it is the case the line should not be constructed in a way that inhibits future adoption of the intended ultimate line speed.
- (2) For example the distance between track centres shall be suitable for the intended ultimate line speed but the cant will need to be appropriate to the speed at the time the line is brought into service.
- (3) Requirements for assessment of conformity in this case are set out in section 6.3.

7.6. **Ascertain Compatibility of infrastructure and rolling stock after authorisation of rolling stock**

- (1) Rolling stock complying with the rolling stock TSIs is not automatically compatible with all lines complying with this Infrastructure TSI. For example, a GC gauge vehicle is not compatible with a GB gauge tunnel. The process of ascertaining route compatibility to be followed shall be in accordance with Commission Recommendation on the authorisation for the placing in service of structural subsystems and vehicles under Directive 2008/57/EC ⁽¹⁾.
- (2) The design of the TSI categories of line as defined in section 4 is generally compatible with the operation of vehicles categorised in accordance with EN 15528:2008+A1:2012 at up to the maximum speed as shown in Appendix E. However there may be a risk of excessive dynamic effects including resonance in certain bridges which may further impact the compatibility of vehicles and infrastructure.
- (3) Checks, based on specific operational scenarios agreed between the infrastructure manager and the railway undertaking, may be undertaken to demonstrate the compatibility of vehicles operating above the maximum speed shown in Appendix E.
- (4) As stated in point 4.2.1 of this TSI, it is permissible to design new and upgraded lines such that they will also accommodate larger gauges, higher axle loads, greater speeds, greater usable length of platform and longer trains than those specified.

7.7. **Specific cases**

The following specific cases may be applied on particular networks. The specific cases are classified as:

- (a) 'P' cases: permanent cases;
- (b) 'T' cases: temporary cases, where it is recommended that the target system is reached by 2020 (an objective set out in Decision No 1692/96/EC of the European Parliament and Council ⁽²⁾).

7.7.1. *Particular features on the Austrian network*

7.7.1.1. Platform height (4.2.9.2)

P cases

For other parts of the Union rail network as set out in Article 2(4) of this Regulation, for renewal and upgrading, the nominal platform height of 380 mm above the running surface shall be allowed.

⁽¹⁾ Not yet published in the Official Journal.

⁽²⁾ Decision No 1692/96/EC of the European Parliament and of the Council of 23 July 1996 on Community guidelines for the development of the trans-European transport network (OJ L 228, 9.9.1996, p. 1), as amended by Decision No 884/2004/EC (OJ L 167, 30.4.2004, p. 1).

7.7.2. *Particular features on the Belgian network*

7.7.2.1. Platform offset (4.2.9.3)

P cases

For platform heights of 550 mm and 760 mm, the conventional value b_{q0} of platform offset shall be calculated according to the following formulas:

$$b_{q0} = 1\,650 + \frac{5\,000}{R} \quad \text{In curve with a radius } 1\,000 \leq R \leq \infty \text{ (m)}$$

$$b_{q0} = 1\,650 + \frac{26\,470}{R} - 21,5 \quad \text{In curve with a radius } R < 1\,000 \text{ (m)}$$

7.7.3. *Particular features on the Bulgarian network*

7.7.3.1. Platform height (4.2.9.2)

P cases

For upgraded or renewed platforms, the nominal platform height of 300 mm and 1 100 mm above the running surface shall be allowed.

7.7.3.2. Platform offset (4.2.9.3)

P cases

Instead of points 4.2.9.3(1) and 4.2.9.3(2), the platform offset shall be:

(a) 1 650 mm for platforms with heights of 300 mm and

(b) 1 750 mm for platforms with height of 1 100 mm.

7.7.4. *Particular features on the Danish network*

7.7.4.1. Platform height (4.2.9.2)

P cases

For S-Tog services the nominal platform height of 920 mm above the running surface shall be allowed.

7.7.5. *Particular features on the Estonian network*

7.7.5.1. Nominal track gauge (4.2.4.1)

P cases

Instead of point 4.2.4.1(2), for the 1 520 mm track gauge system the nominal track gauge shall be either 1 520 mm or 1 524 mm.

7.7.5.2. Resistance of new bridges to traffic loads (4.2.7.1)

P cases

For the 1 520 mm track gauge system, for lines with an axle load of 30 t, it shall be allowed to design structures to support vertical loads in accordance with the load model set out in Appendix M to this TSI.

7.7.5.3. The immediate action limit for switches and crossing (4.2.8.6)

P cases

Instead of sub-point 4.2.8.6(3)(a), for the 1 520 mm track gauge system, the minimum value of bypass at the narrowest location between open switch rail and stock rail is 54 mm.

7.7.6. Particular features on the Finnish network

7.7.6.1. TSI Categories of line (4.2.1)

P cases

Instead of gauges specified in the columns 'Gauge' in Table 2 and Table 3 of point 4.2.1(6), for the nominal track gauge of 1 524 mm, it shall be allowed to use gauge FIN1.

7.7.6.2. Structure gauge (4.2.3.1)

P cases

(1) Instead of points 4.2.3.1(1) and 4.2.3.1(2), for the nominal track gauge of 1 524 mm, both the upper and lower part of the structure gauge shall be set on the basis of the gauge FIN1. Those gauges are defined in Annex D, section D4.4 of EN 15273-3:2013.

(2) Instead of point 4.2.3.1(3), for the nominal track gauge of 1 524 mm, calculations of the structure gauge shall be done using the static method in accordance with the requirements of sections 5, 6, 10 and Annex D Section D.4.4 of EN 15273-3:2013.

7.7.6.3. Distance between track centres (4.2.3.2)

P cases

(1) Instead of point 4.2.3.2(1), for the nominal track gauge of 1 524 mm, the distance between track centres shall be set on the basis of the gauge FIN1.

(2) Instead of point 4.2.3.2(2), for the nominal track gauge of 1 524 mm, the nominal horizontal distance between track centres for new lines shall be specified for the design and shall not be smaller than the values mentioned in Table 21; it considers margins for aerodynamic effects.

Table 21

Minimum nominal horizontal distance between track centres

Maximum allowed speed [km/h]	Minimum nominal horizontal distance between track centres [m]
$v \leq 120$	4,10
$120 < v \leq 160$	4,30
$160 < v \leq 200$	4,50
$200 < v \leq 250$	4,70
$v > 250$	5,00

(3) Instead of point 4.2.3.2(3), for the nominal track gauge of 1 524 mm, the distance between track centres shall at least satisfy the requirements for the limit installation distance between track centres, defined according Annex D, Section D4.4.5 of EN 15273-3:2013.

7.7.6.4. Minimum radius of horizontal curve (4.2.3.4)

P cases

Instead of point 4.2.3.4(3), for the nominal track gauge of 1 524 mm, reverse curves (other than reverse curves in marshalling yards where wagons are shunted individually) with radii in the range from 150 m up to 275 m for new lines shall be designed in accordance with Table 22 to prevent buffer locking.

Table 22

Limits for the length of a straight intermediate element between two long circular curves in the opposite directions [m] (*)

Alignment chain (*)	Limits for tracks for mixed traffic [m]
R = 150 m — straight — R = 150 m	16,9
R = 160 m — straight — R = 160 m	15,0

Alignment chain (*)	Limits for tracks for mixed traffic [m]
R = 170 m — straight — R = 170 m	13,5
R = 180 m — straight — R = 180 m	12,2
R = 190 m — straight — R = 190 m	11,1
R = 200 m — straight — R = 200 m	10,00
R = 210 m — straight — R = 210 m	9,1
R = 220 m — straight — R = 220 m	8,2
R = 230 m — straight — R = 230 m	7,3
R = 240 m — straight — R = 240 m	6,4
R = 250 m — straight — R = 250 m	5,4
R = 260 m — straight — R = 260 m	4,1
R = 270 m — straight — R = 270 m	2,0
R = 275 m — straight — R = 275 m	0

(*) Note: For reverse curves with different radii the radius of the smaller curve shall be used when designing straight element between the curves.

7.7.6.5. Nominal track gauge (4.2.4.1)

P cases

Instead of point 4.2.4.1(1), the nominal track gauge shall be 1 524 mm.

7.7.6.6. Cant (4.2.4.2)

P cases

(1) Instead of point 4.2.4.2(1), for the nominal track gauge of 1 524 mm, the design cant shall not exceed 180 mm for ballasted or non-ballasted track.

(2) Instead of point 4.2.4.2(3), for the nominal track gauge of 1 524 mm, new lines with mixed or freight traffic on curves with a radius less than 320 m and a cant transition steeper than 1 mm/m, the cant shall be restricted to the limit given by the following formula

$$D \leq (R - 50) \times 0,7$$

where D is the cant in mm and R is the radius in m.

7.7.6.7. Maximum unguided length of fixed obtuse crossings (4.2.5.3)

P cases

In paragraph (1) of Appendix J, for the nominal track gauge of 1 524 mm:

(a) Instead of subparagraph (J.1)(b), the minimum radius through obtuse crossing shall be 200 m; for radius between 200-220 m small radius shall be compensated with track gauge widening

(b) Instead of subparagraph (J.1)(c), the minimum check rail height shall be 39 mm

7.7.6.8. The immediate action limit of track gauge as an isolated defect (4.2.8.4)

P cases

Instead of point 4.2.8.4(1), for the nominal track gauge of 1 524 mm, the immediate action limits of track gauge as an isolated defect are set out in Table 23.

Table 23

Immediate action limits of track gauge for the nominal track gauge of 1 524 mm

Speed [km/h]	Dimensions [mm]	
	Minimum track gauge	Maximum track gauge
$v \leq 60$	1 515	1 554
$60 < v \leq 120$	1 516	1 552
$120 < v \leq 160$	1 517	1 547
$160 < v \leq 200$	1 518	1 543
$200 < v \leq 250$	1 519	1 539
$v > 250$	1 520	1 539

7.7.6.9. The immediate action limit of cant (4.2.8.5)

P cases

Instead of point 4.2.8.5(1), for the nominal track gauge of 1 524 mm, the maximum cant allowed in service is 190 mm.

7.7.6.10. The immediate action limits for switches and crossings (4.2.8.6)

P cases

Instead of point 4.2.8.6(1), for the nominal track gauge of 1 524 mm, the technical characteristics of switches and crossings shall comply with the following in-service values:

(a) Maximum value of free wheel passage in switches: 1 469 mm.

This value can be increased if the Infrastructure Manager demonstrates that the actuation and locking system of the switch is able to resist the lateral impact forces of a wheel set.

(b) Minimum value of fixed nose protection for common crossings: 1 476 mm.

This value is measured 14 mm below the running surface, and on the theoretical reference line, at an appropriate distance back from the actual point (RP) of the nose as indicated in Figure 2.

For crossings with point retraction, this value can be reduced. In this case the Infrastructure Manager shall demonstrate that the point retraction is sufficient to guarantee that the wheel will not hit the nose at the actual point (RP).

(c) Maximum value of free wheel passage at crossing nose: 1 440 mm.

(d) Maximum value of free wheel passage at check rail/wing rail entry: 1 469 mm.

(e) Minimum flangeway width: 42 mm.

(f) Minimum flangeway depth: 40 mm.

(g) Maximum excess height of check rail: 55 mm.

7.7.6.11. Platform offset (4.2.9.3)

P cases

Instead of point 4.2.9.3(1), for the nominal track gauge of 1 524 mm, the distance between the track centre and the platform edge, parallel to the running plane, shall be set on the basis of the installation limit gauge and is defined in chapter 13 of EN 15273-3:2013. The installation limit gauge shall be set on the basis of the gauge FIN1. The minimum distance of b_{qim} , calculated as in chapter 13 of EN15273-3:2013 is hereafter referred to as b_{qim} .

7.7.6.12. Train external cleaning facilities (4.2.12.3)

P cases

Instead of point 4.2.12.3(1), for the nominal track gauge of 1 524 mm, where a washing plant is provided it shall be able to clean the outer sides of single or double-deck trains between a height of:

- (a) 330 to 4 367 mm for a single-deck train,
- (b) 330 to 5 300 mm for double-deck trains.

7.7.6.13. Assessment of structure gauge (6.2.4.1)

P cases

Instead of point 6.2.4.1(1), for the nominal track gauge of 1 524 mm, assessment of structure gauge as a design review shall be done against characteristic cross sections using the results of calculations made by the Infrastructure Manager or the contracting entity on the basis of sections 5, 6, 10 and Annex D, Section D.4.4 of EN 15273-3:2013.

7.7.7. *Particular features on the French network*

7.7.7.1. Platform height (4.2.9.2)

P cases

For the rail network of Ile-de-France the nominal platform height of 920 mm above the running surface shall be allowed.

7.7.8. *Particular features on the German network*

7.7.8.1. Platform height (4.2.9.3)

P cases

For S-Bahn services the nominal platform height of 960 mm above the running surface shall be allowed.

7.7.9. *Particular features on the Hellenic network*

7.7.9.1. Platform height (4.2.9.2)

P cases

The nominal platform height shall be allowed to be 300 mm above the running surface.

7.7.10. *Particular features on the Italian network*

7.7.10.1. Platform offset (4.2.9.3)

P cases

Instead of point 4.2.9.3(1), for the platforms with the height of 550 mm, the distance b_{qim} [mm] between the the track centre and the platform edge, parallel to the running plane, shall be calculated from the formula:

- (a) on straight track and inside the curves:

$$b_{qim} = 1\,650 + 3\,750/R + (g - 1\,435)/2 + 11,5$$

- (b) outside the curves:

$$b_{qim} = 1\,650 + 3\,750/R + (g - 1\,435)/2 + 11,5 + 220 * \tan\delta$$

where R is the radius of the track, in metres, g is the track gauge, δ is the angle of the cant with the horizontal line.

7.7.10.2. Equivalent conicity (4.2.4.5)

P cases

- (1) Instead of point 4.2.4.5.(3) design values of track gauge, rail head profile and rail inclination for plain line shall be selected to ensure that the equivalent conicity limits set out in Table 24 are not exceeded.

Table 24

Equivalent conicity design limit values

Speed range [km/h]	Wheel profile	
	S1002, GV1/40	EPS
$v \leq 60$	Assessment not required	
$60 < v \leq 200$	0,25	0,30
$200 < v \leq 280$	0,20	N.A.
$v > 280$	0,10	N.A.

- (2) Instead of point 4.2.4.5. (4) the following wheelsets shall be modelled passing over the designed track conditions (simulated by calculation according to EN 15302:2008+A1:2010):

- (a) S 1002 as defined in Annex C of EN 13715:2006+A1:2010 with SR1.
- (b) S 1002 as defined in Annex C of EN 13715:2006+A1:2010 with SR2.
- (c) GV 1/40 as defined in Annex B of EN 13715:2006+A1:2010 with SR1.
- (d) GV 1/40 as defined in Annex B of EN 13715:2006+A1:2010 with SR2.
- (e) EPS as defined in Annex D of EN 13715:2006+A1:2010 with SR1.

For SR1 and SR2 the following values apply:

- (f) For the 1 435 mm track gauge system SR1 = 1 420 mm and SR2 = 1 426 mm.

7.7.10.3. Equivalent conicity in service (4.2.11.2)

P cases

Instead of point 4.2.11.2.(2) the infrastructure manager shall measure the track gauge and the railhead profiles at the site in question at a distance of approximate 10 m. The mean equivalent conicity over 100 m shall be calculated by modelling with the wheelsets (a) – (e) mentioned in paragraph 7.7.10.2 (2) of this TSI in order to check for compliance, for the purpose of the joint investigation, with the limit equivalent conicity for the track specified in Table 14.

7.7.11. Particular features on the Latvian network

7.7.11.1. Resistance of new bridges to traffic loads — vertical loads (4.2.7.1.1)

P cases

- (1) For sub-point 4.2.7.1.1(1)(a), for the 1 520 mm track gauge system, load model 71 shall be applied with a distributed load q_{vk} of 100 kN/m.
- (2) Instead of point 4.2.7.1.1(3), for the 1 520 mm track gauge system, the value of factor alpha (α) shall in all cases be equal to 1,46.

7.7.12. Particular features on the Polish network

7.7.12.1. TSI Categories of line (4.2.1)

P cases

In point 4.2.1(7), Table 2 line P3, instead of gauge DE3, on upgraded or renewed railway lines in Poland gauge G2 is allowed.

7.7.12.2. Distance between track centres (4.2.3.2)

P cases

Instead of point 4.2.3.2(4), for 1 520 mm track gauge, for station tracks for direct reloading of goods from wagon to wagon the nominal horizontal minimum distance of 3,60 m shall be allowed.

7.7.12.3. Minimum radius of horizontal curve (4.2.3.4)

P cases

Instead of point 4.2.3.4(3), for the 1 520 mm track gauge, on tracks other than main tracks, reverse curves with radii in the range from 150 m up to 250 m shall be designed with a section of straight track of at least 10 m between the curves.

7.7.12.4. Minimum radius of vertical curve (4.2.3.5)

P cases

Instead of point 4.2.3.5(3), for the 1 520 mm track gauge, the radius of vertical curves (except the marshalling yards) shall be at least 2 000 m both on a crest and in a hollow.

7.7.12.5. Cant deficiency (4.2.4.3)

P cases

Instead of point 4.2.4.3(3), for all types of rolling stock of the 1 520 mm track gauge the cant deficiency shall not exceed 130 mm.

7.7.12.6. Abrupt change of cant deficiency (4.2.4.4)

P cases

Instead of point 4.2.4.4(3), for 1 520 mm track gauge, requirements of points 4.2.4.4(1) and 4.2.4.4(2) shall be applied.

7.7.12.7. The immediate action limit for track twist (4.2.8.3)

P cases

Instead of point 4.2.8.3(4) and 4.2.8.3(5), for 1 520 mm track gauge points from 4.2.8.3(1) to 4.2.8.3(3) shall be applied.

7.7.12.8. The immediate action limit of track gauge as an isolated defect (4.2.8.4)

P cases

Instead of requirements of Table 13 in point 4.2.8.4(2) the limit values for 1 520 mm track gauge in Poland are given in following table:

Table 25

Immediate action limits of track gauge for 1 520 mm track gauge in Poland

Speed [km/h]	Dimensions [mm]	
	Minimum track gauge	Maximum track gauge
$v < 50$	1 511	1 548
$50 \leq v \leq 140$	1 512	1 548
$v > 140$	1 512	1 536

7.7.12.9. The immediate action limits for switches and crossings (4.2.8.6)

P cases

(1) Instead of sub-point 4.2.8.6(1)(d), for certain types of switches of $R = 190$ m and crossings with slants of 1:9 and 1:4,444 the maximum value of free wheel passage at check rail/wing rail entry of 1 385 mm shall be allowed.

(2) Instead of point 4.2.8.6(3), for the 1 520 mm track gauge the technical characteristics of switches and crossings shall comply with the following in-service values:

(a) Maximum value of free wheel passage in switches: 1 460 mm.

This value can be increased if the Infrastructure Manager demonstrates that the actuation and locking system of the switch is able to resist the lateral impact forces of a wheelset.

(b) Minimum value of fixed nose protection for common crossings: 1 472 mm.

This value is measured 14 mm below the running surface, and on the theoretical reference line, at an appropriate distance back from the actual point (RP) of the nose as indicated in Figure 2.

For crossings with point retraction, this value can be reduced. In this case the Infrastructure Manager shall demonstrate that the point retraction is sufficient to guarantee that the wheel will not hit the nose at the actual point (RP).

(c) Maximum value of free wheel passage at crossing nose: 1 436 mm.

(d) Minimum flangeway width: 38 mm.

(e) Minimum flangeway depth: 40 mm.

(f) Maximum excess height of check rail: 55 mm.

7.7.12.10. Platform height (4.2.9.2)

P cases

(1) For platforms used for urban or suburban railway services the nominal platform height of 960 mm above running surface shall be allowed.

(2) For upgraded or renewed lines with maximum speed of no more than 160 km/h the nominal platform height from 220 mm to 380 mm above running surface shall be allowed.

7.7.12.11. Equivalent conicity in service (4.2.11.2)

T cases

Until introduction of equipment for measurement of elements required for calculation of equivalent conicity in service, it is allowed in Poland not to assess this parameter.

7.7.12.12. Track sleepers (5.3.3)

P cases

The requirement of point 5.3.3(2) shall be applied for speeds above 250 km/h.

7.7.13. Particular features on the Portuguese network

7.7.13.1. Structure gauge (4.2.3.1)

P cases

- (1) Instead of point 4.2.3.1(1), for the nominal track gauge of 1 668 mm, the upper part of the structure gauge shall be set on the basis of the gauges set out in Table 26 and Table 27, which are defined in Annex D Section D.4.3 of EN 15273-3:2013.

Table 26

Portuguese gauges for passenger traffic

Traffic code	Gauge
P1	PTc
P2	PTb+
P3	PTc
P4	PTb+
P5	PTb
P6	PTb

Table 27

Portuguese gauges for freight traffic

Traffic code	Gauge
F1	PTc
F2	PTb+
F3	PTb
F4	PTb

- (2) Instead of point 4.2.3.1(2), for the nominal track gauge of 1 668 mm the lower part of the structure gauge shall be in accordance with Annex D Section D.4.3.4 of EN 15273-3:2013.
- (3) Instead of point 4.2.3.1(3), for the nominal track gauge of 1 668 mm, calculations of the structure gauge shall be done using the kinematic method in accordance with the requirements of Annex D Section D.4.3. of EN 15273-3:2013.

7.7.13.2. Distance between track centres (4.2.3.2)

P cases

Instead of point 4.2.3.2(1), for the nominal track gauge of 1 668 mm, the distance between track centres shall be set on the basis of the reference contours PTb, PTb+ or PTc, which are defined in Annex D Section D.4.3 of EN 15273-3:2013.

7.7.13.3. The immediate action limit of track gauge as an isolated defect (4.2.8.4)

P cases

Instead of point 4.2.8.4(1), for the nominal track gauge of 1 668 mm, the immediate action limits of track gauge as an isolated defect are set out in Table 28.

Table 28

Immediate action limits of Portuguese track gauge

Speed [km/h]	Dimensions [mm]	
	Minimum track gauge	Maximum track gauge
$v \leq 120$	1 657	1 703
$120 < v \leq 160$	1 658	1 703
$160 < v \leq 230$	1 661	1 696
$v > 230$	1 663	1 696

7.7.13.4. The immediate action limit for switches and crossings (4.2.8.6)

P cases

Instead of point 4.2.8.6(1), for the nominal track gauge of 1 668 mm, the technical characteristics of switches and crossings shall comply with the following in-service values:

- (a) Maximum value of free wheel passage in switches: 1 618 mm.

This value can be increased if the Infrastructure Manager demonstrates that the actuation and locking system of the switch is able to resist the lateral impact forces of a wheelset.

- (b) Minimum value of fixed nose protection for common crossings: 1 625 mm.

This value is measured 14 mm below the running surface, and on the theoretical reference line, at an appropriate distance back from the actual point (RP) of the nose as indicated in Figure 2.

For crossings with point retraction, this value can be reduced. In this case the Infrastructure Manager shall demonstrate that the point retraction is sufficient to guarantee that the wheel will not hit the nose at the actual point (RP).

- (c) Maximum value of free wheel passage at crossing nose: 1 590 mm.

- (d) Maximum value of free wheel passage at check rail/wing rail entry: 1 618 mm.

- (e) Minimum flangeway width: 38 mm.

- (f) Minimum flangeway depth: 40 mm.

- (g) Maximum excess height of check rail: 70 mm.

7.7.13.5. Platform height (4.2.9.2)

P cases

For the nominal track gauge of 1 668 mm, for upgraded or renewed platforms the nominal platform height of 685 and 900 mm above the running surface for radii of more than 300 m shall be allowed.

7.7.13.6. Platform offset (4.2.9.3)

P cases

(1) Instead of point 4.2.9.3(1), for the nominal track gauge of 1 668 mm, the distance between the track centre and the platform edge parallel to the running plane (b_q), as defined in chapter 13 of EN 15273-3:2013, shall be set on the basis of the installation limit gauge ($b_{q\text{lim}}$). The installation limit gauge shall be calculated on the basis of the gauge PTb+ defined in Annex D, Section D 4.3 of EN 15273-3:2013.

(2) For a three-rail track, the installation limit gauge shall be the outside envelope resultant from the overlaying of the installation gauge centred on the track gauge 1 668 mm, and the installation gauge set in 4.2.9.3(1) centred on the track gauge 1 435 mm.

7.7.13.7. Assessment of structure gauge (6.2.4.1)

P cases

Instead of point 6.2.4.1(1), for the nominal track gauge of 1 668 mm, assessment of structure gauge as a design review shall be done against characteristic cross sections using the results of calculations made by the Infrastructure Manager or the contracting entity on the basis of chapters 5, 7, 10 and section D.4.3 of EN 15273-3:2013.

7.7.13.8. Assessment of maximum pressure variations in tunnels (6.2.4.12)

P cases

Instead of point 6.2.4.12(3), for the nominal track gauge of 1 668 mm, the reference cross section area (constant along a train) to be considered is to be, independently to each motor or trailer vehicle:

(a) 12 m² for vehicles designed for P_{Tc} reference kinematic profile,

(b) 11 m² for vehicles designed for P_{Tb} and P_{Tb+} reference kinematic profile.

The vehicle gauge to be considered shall be set on the basis of the gauge selected according to point 7.7.13.1.

7.7.14. *Particular features on the Ireland network*

7.7.14.1. Structure gauge (4.2.3.1)

P cases

Instead of point 4.2.3.1(5), for the nominal track gauge of 1 600 mm, it shall be allowed to apply the uniform structure gauge IRL2 as set out in Appendix O to this TSI.

7.7.14.2. Distance between track centres (4.2.3.2)

P cases

Instead of point 4.2.3.2(6), for the 1 600 mm track gauge, the distance between track centres shall be set on the basis of the gauges selected according to point 7.7.14.1. The nominal horizontal distance between track centres shall be specified for the design and shall not be less than 3,47 m for gauge IRL2; it considers margins for aerodynamic effects.

7.7.14.3. Assessment of structure gauge (6.2.4.1)

P cases

Instead of point 6.2.4.1(5), for the 1 600 mm track gauge, assessment of structure gauge as a design review is to be made against characteristic cross sections using the structure gauge 'IRL2' as defined in Appendix O to this TSI.

7.7.15. Particular features on the Spanish network

7.7.15.1. Structure gauge (4.2.3.1)

P cases

- (1) Instead of point 4.2.3.1(1), for the nominal track gauge of 1 668 mm, the upper part of the structure gauge for new lines shall be set on the basis of the gauges set out in Table 29 and Table 30 which are defined in Annex D, Section D.4.11 of EN 15273-3:2013.

Table 29

Gauges for passenger traffic on the Spanish network

Traffic code	Gauge of upper parts
P1	GEC16
P2	GEB16
P3	GEC16
P4	GEB16
P5	GEB16
P6	GHE16

Table 30

Gauges for freight traffic on the Spanish network

Traffic code	Gauge of upper parts
F1	GEC16
F2	GEB16
F3	GEB16
F4	GHE16

For renewed or upgraded lines the upper part of the structure gauge shall be set on the basis of the gauge GHE16 which is defined in Annex D, Section D.4.11 of EN 15273-3:2013.

- (2) Instead of point 4.2.3.1(2), for the nominal track gauge of 1 668 mm the lower part of the structure gauge shall be GEI2 as set out in Appendix P to this TSI. Where tracks are equipped with rail brakes, structure gauge GEI1 shall be applied for the lower part of the gauge, as set out in Appendix P to this TSI.
- (3) Instead of point 4.2.3.1(3), for the nominal track gauge of 1 668 mm calculations of the structure gauge shall be done using the kinematic method in accordance with the requirements of Annex D, Section D.4.11 of EN 15273-3:2013 for the upper parts and Appendix P to this TSI for the lower parts.

7.7.15.2. Distance between track centres (4.2.3.2)

P cases

Instead of point 4.2.3.2(1), for the nominal track gauge of 1 668 mm, the distance between track centres shall be set on the basis of gauges of upper parts GHE16, GEB16 or GEC16, which are defined in Annex D, Section D.4.11 of EN 15273-3:2013.

7.7.15.3. Design track twist due to rail traffic actions (4.2.7.1.6)

P cases

Instead of point 4.2.7.1.6, for the nominal track gauge of 1 668 mm, the maximum total design track twist due to rail traffic actions shall not exceed 8mm/3m.

7.7.15.4. The immediate action limit of track gauge as an isolated defect (4.2.8.4)

P cases

Instead of point 4.2.8.4(1), for the nominal track gauge of 1 668 mm, the immediate action limits of track gauge as an isolated defect are set out in Table 31.

Table 31

Immediate action limits of 1 668 mm track gauge

Speed [km/h]	Dimensions [mm]	
	Minimum track gauge	Maximum track gauge
$v \leq 80$	1 659	1 698
$80 < v \leq 120$	1 659	1 691
$120 < v \leq 160$	1 660	1 688
$160 < v \leq 200$	1 661	1 686
$200 < v \leq 240$	1 663	1 684
$240 < v \leq 280$	1 663	1 682
$280 < v \leq 320$	1 664	1 680
$320 < v \leq 350$	1 665	1 679

7.7.15.5. The immediate action limits for switches and crossings (4.2.8.6)

P cases

Instead of point 4.2.8.6(1), for the nominal track gauge of 1 668 mm, the technical characteristics of switches and crossings shall comply with the following in-service values:

- (a) Maximum value of free wheel passage in switches: 1 618 mm.

This value can be increased if the Infrastructure Manager demonstrates that the actuation and locking system of the switch is able to resist the lateral impact forces of a wheelset.

- (b) Minimum value of fixed nose protection for common crossings: 1 626 mm.

This value is measured 14 mm below the running surface, and on the theoretical reference line, at an appropriate distance back from the actual point (RP) of the nose as indicated in Figure 2.

For crossings with point retraction, this value can be reduced. In this case the Infrastructure Manager shall demonstrate that the point retraction is sufficient to guarantee that the wheel will not hit the nose at the actual point (RP).

- (c) Maximum value of free wheel passage at crossing nose: 1 590 mm.
- (d) Maximum value of free wheel passage at check rail/wing rail entry: 1 620 mm.
- (e) Minimum flangeway width: 38 mm.
- (f) Minimum flangeway depth: 40 mm.
- (g) Maximum height of check rail: 70 mm.

7.7.15.6. Platform height (4.2.9.2)

P cases

The nominal platform height dedicated for:

- (a) commuter or regional traffic or
- (b) commuter and long-distance traffic
- (c) regional traffic and long-distance traffic

stopping in normal service, shall be allowed to be 680 mm for radii of 300 m and more above the running surface.

7.7.15.7. Platform offset (4.2.9.3)

P cases

- (1) Instead of point 4.2.9.3(1), for the nominal track gauge of 1 668 mm, the distance between the track centre and the platform edge, parallel to the running plane (b_q), as defined in chapter 13 of EN 15273-3:2013, shall be set on the basis of the installation limit gauge ($b_{q\text{lim}}$). The installation limit gauge shall be calculated on the basis of the gauges of upper parts GHE16 or GEC16 defined in Annex D, Section D.4.11 of EN 15273-3:2013.
- (2) For a three-rail track, the installation limit gauge shall be the outside envelope resultant from the overlaying of the installation limit gauge centred on the track gauge 1 668 mm, and the installation limit gauge set in 4.2.9.3(1) centred on the track gauge 1 435 mm.

7.7.15.8. Assessment of structure gauge (6.2.4.1)

P cases

Instead of point 6.2.4.1(1), for the nominal track gauge of 1 668 mm, assessment of structure gauge as a design review shall be done against characteristic cross sections using the results of calculations made by the Infrastructure Manager or the contracting entity on the basis of chapters 5, 7, 10 and Annex D, Section D.4.11 of EN 15273-3:2013 for the upper parts and Appendix P to this TSI for the lower parts.

7.7.15.9. Assessment of maximum pressure variations in tunnels (6.2.4.12)

P cases

Instead of point 6.2.4.12(3), for the nominal track gauge of 1 668 mm, the reference cross section area to be considered is to be, independently to each motor or trailer vehicle:

- (a) 12 m² for vehicles designed for GEC16 reference kinematic profile,
- (b) 11 m² for vehicles designed for GEB16, and GHE16 reference kinematic profile.

The vehicle gauge to be considered shall be set on the basis of the gauge selected according to point 7.7.15.1.

7.7.16. *Particular features on the Swedish network*

7.7.16.1. General

P cases

On infrastructure with direct connection to the Finnish network and for infrastructure in harbours, the particular features of the Finnish network as specified in point 7.7.6 of this TSI may be applied on tracks, which are dedicated for 1 524 mm nominal track gauge vehicles.

7.7.16.2. Platform offset (4.2.9.3)

P cases

As set out in point 4.2.9.3(1), the distance between the track centre and the platform edge parallel to the running plane (b_q), as defined in chapter 13 of EN 15273-3:2013, shall be calculated with the following values for allowed additional overthrow (S_{kin}):

(a) on the inside of the curve: $S_{kin} = 40,5/R$,

(b) on the outside of the curve: $S_{kin} = 31,5/R$.

7.7.17. *Particular features on the UK network for Great Britain*

7.7.17.1. TSI categories of line (4.2.1)

P cases

(1) Where line speeds are stated in kilometres per hour [km/h] as a category or performance parameter in this TSI, it shall be allowed to translate the speed to equivalent miles per hour [mph] as in Appendix G, for the United Kingdom national network in Great Britain.

(2) Instead of the column 'Gauge' in Table 2 and Table 3 of point 4.2.1(7), for the gauge of all lines except new, dedicated high speed lines of traffic code P1, it shall be allowed to use national technical rules as set out in Appendix Q.

7.7.17.2. Structure gauge (4.2.3.1)

P cases

Instead of point 4.2.3.1, for national gauges selected according to point 7.7.17.1(2), the structure gauge shall be set according to Appendix Q.

7.7.17.3. Distance between track centres (4.2.3.2)

P cases

(1) Instead of point 4.2.3.2, the nominal distance between track centres shall be 3 400 mm on straight track and curved track with a radius of 400 m or greater.

(2) Where topographical constraints prevent a nominal distance of 3 400 mm between track centres being achieved, it is permissible to reduce the distance between track centres provided special measures are put in place to ensure a safe passing clearance between trains.

(3) Reduction in the distance between track centres shall be in accordance with the national technical rule set out in Appendix Q.

7.7.17.3.bis Equivalent concity (4.2.4.5)

P cases

- (1) Instead of point 4.2.4.5.(3) design values of track gauge, rail head profile and rail inclination for plain line shall be selected to ensure that the equivalent concity limits set out in Table 32 are not exceeded

Table 32

Equivalent concity design limit values

Speed range [km/h]	Wheel profile	
	S1002, GV1/40	EPS
$v \leq 60$	Assessment not required	
$60 < v \leq 200$	0,25	0,30
$200 < v \leq 280$	0,20	0,20
$v > 280$	0,10	0,15

- (2) Instead of point 4.2.4.5. (4) the following wheelsets shall be modelled passing over the designed track conditions (simulated by calculation according to EN 15302:2008+A1:2010):

- (a) S 1002 as defined in Annex C of EN 13715:2006+A1:2010 with SR1.
- (b) S 1002 as defined in Annex C of EN 13715:2006+A1:2010 with SR2.
- (c) GV 1/40 as defined in Annex B of EN 13715:2006+A1:2010 with SR1.
- (d) GV 1/40 as defined in Annex B of EN 13715:2006+A1:2010 with SR2.
- (e) EPS as defined in Annex D of EN 13715:2006+A1:2010 with SR1.

For SR1 and SR2 the following values apply:

- (f) For the 1 435 mm track gauge system SR1 = 1 420 mm and SR2 = 1 426 mm.

7.7.17.4. Maximum unguided length of fixed obtuse crossings (4.2.5.3)

P cases

Instead of point 4.2.5.3, the design value of the maximum unguided length of fixed obtuse crossing shall be in accordance with the national technical rule set out in Appendix Q.

7.7.17.5. The immediate action limits for switches and crossings (4.2.8.6)

P cases

Instead of point 4.2.8.6(1)(b), for the 'CEN56 Vertical' design of switches and crossings, a minimum value of fixed nose protection for common crossings of 1 388 mm is allowed (measured 14 mm below the running surface, and on the theoretical reference line, at an appropriate distance back from the actual (RP) of the nose as indicated in Figure 2).

7.7.17.6. Platform height (4.2.9.2)

P cases

Instead of point 4.2.9.2, for platform height, national technical rules as set out in Appendix Q shall be allowed.

7.7.17.7. Platform offset (4.2.9.3)

P cases

Instead of point 4.2.9.3, for platform offset, national technical rules as set out in Appendix Q shall be allowed.

7.7.17.8. Equivalent conicity in service (4.2.11.2)

P cases

Instead of point 4.2.11.2.(2) the infrastructure manager shall measure the track gauge and the railhead profiles at the site in question at a distance of approximate 10 m. The mean equivalent conicity over 100 m shall be calculated by modelling with the wheelsets (a) — (e) mentioned in paragraph 7.7.17.3(2) of this TSI in order to check for compliance, for the purpose of the joint investigation, with the limit equivalent conicity for the track specified in Table 14.

7.7.17.9. Assessment of structure gauge (6.2.4.1)

P cases

Instead of point 6.2.4.1, it shall be allowed to assess structure gauge in accordance with the national technical rules as set out in Appendix Q.

7.7.17.10. Assessment of distance between track centres (6.2.4.2)

P cases

Instead of point 6.2.4.2, it shall be allowed to assess distance between track centres in accordance with the national technical rules as set out in Appendix Q.

7.7.17.11. Assessment of platform offset (6.2.4.11)

P cases

Instead of point 6.2.4.11, it shall be allowed to assess platform offset in accordance with the national technical rules as set out in Appendix Q.

7.7.18. *Particular features on the UK network for Northern Ireland*

7.7.18.1. Structure gauge (4.2.3.1)

P cases

Instead of point 4.2.3.1(5), for the nominal track gauge of 1 600 mm, it shall be allowed to apply the uniform structure gauge IRL3 as set out in Appendix O to this TSI.

7.7.18.2. Distance between track centres (4.2.3.2)

P cases

Instead of point 4.2.3.2(6), for the 1 600 mm track gauge, the distance between track centres shall be set on the basis of the gauges selected according to point 7.7.17.1. The nominal horizontal distance between track centres shall be specified for the design and shall consider margins for aerodynamic effects. The minimum allowed value for the uniform structure gauge IRL3 is an open point.

7.7.18.3. Assessment of structure gauge (6.2.4.1)

P cases

Instead of point 6.2.4.1(5), for the 1 600 mm track gauge, assessment of structure gauge as a design review is to be made against characteristic cross sections using the structure gauge 'IRL3' as defined in Appendix O to this TSI.

7.7.19. *Particular features on the Slovak network*

7.7.19.1. TSI categories of line (4.2.1)

P cases

For the Traffic Code F1520 as defined in Table 3 of point 4.2.1(7), for the 1 520 mm track gauge system, it shall be allowed to use axle load 24,5 t and train length in the range from 650 m up to 1 050 m.

Table 34

Limits for length of a straight intermediate element between two long circular curves in the opposite directions (m); for passenger trains with speeds up to 40 km/h for other tracks than main tracks

R_1/R_2	150	160	170	180	190	200	220	230	250
150	11,0	10,7	10,4	10,0	9,8	9,5	9,0	8,7	8,1
160	10,7	10,4	10,0	9,8	9,5	9,0	8,6	8,1	7,6
170	10,4	10,0	9,8	9,5	9,0	8,5	8,1	7,6	6,7
180	10,0	9,8	9,5	9,0	8,5	8,0	7,5	6,6	6,4
190	9,8	9,5	9,0	8,5	8,0	7,5	6,5	6,3	6,0
200	9,5	9,0	8,5	8,0	7,5	6,7	6,2	6,0	5,3
220	9,0	8,6	8,1	7,5	6,5	6,2	6,0	5,3	4,0
230	8,7	8,1	7,6	6,6	6,3	6,0	5,3	4,0	4,0
250	8,1	7,6	6,7	6,4	6,0	5,3	4,0	4,0	4,0
280	7,6	6,7	6,4	6,0	5,4	4,0	4,0	4,0	4,0
300	6,7	6,4	6,0	5,5	4,5	4,0	4,0	4,0	4,0
325	6,4	6,0	5,7	5,0	4,0	4,0	4,0	4,0	4,0
350	6,3	5,8	5,2	4,0	4,0	4,0	4,0	4,0	4,0
400	6,0	5,2	4,0	4,0	4,0	4,0	4,0	4,0	4,0
450	5,5	4,5	4,0	4,0	4,0	4,0	4,0	4,0	4,0
500	5,0	4,0	4,0	4,0	4,0	4,0	4,0	4,0	4,0
600	4,0	4,0	4,0	4,0	4,0	4,0	4,0	4,0	4,0

7.7.19.3. Minimum radius of vertical curve (4.2.3.5)

P cases

- (1) Instead of point 4.2.3.5(1), only for side track with maximum speed up to 10 km/h, the radius of vertical curves (except for humps in marshalling yards) shall be at least 500 m in both in a crest and in a hollow.
- (2) Instead of point 4.2.3.5(3), for 1 520 mm track gauge system, the radius of vertical curves (except the marshalling yards) shall be at least 2 000 m both on a crest and in a hollow, in cramped conditions (e.g. insufficient space) at least 1 000 m both on a crest and in hollow.
- (3) For side track with maximum speed up to 10 km/h, it shall be allowed to use the radius of vertical curves at least 500 m both on a crest and in a hollow.
- (4) Instead of point 4.2.3.5(4), for the 1 520 mm track gauge system for humps in marshalling yards the radius of vertical curves shall be at least 300 m on a crest and 250 m in a hollow.

7.7.19.4. Cant deficiency (4.2.4.3)

P cases

Instead of point 4.2.4.3(3), for all types of rolling stock of the 1 520 mm track gauge system the cant deficiency shall not exceed 137 mm. For passenger traffic, this limit is valid for speeds up to 230 km/h. For mixed traffic, this limit is valid for speed up to 160 km/h.

7.7.19.5. The immediate action limit for track twist (4.2.8.3)

P cases

Instead of point 4.2.8.3(4) and 4.2.8.3(5), for the 1 520 mm track gauge system, points from 4.2.8.3(1) to 4.2.8.3(3) shall be applied.

7.7.19.6. The immediate action limit of track gauge as an isolated defect (4.2.8.4)

P cases

Instead of point 4.2.8.4(2), for 1 520 mm track gauge system, the immediate action limits of track gauge as an isolated defects are set out in Table 35.

Table 35

Immediate action limits of track gauge for 1 520 mm track gauge system in Slovak republic

Speed [km/h]	Dimensions [mm]	
	Minimum track gauge	Maximum track gauge
$v \leq 80$	1 511	1 555
$80 < v \leq 120$	1 512	1 550
$120 < v \leq 160$	1 513	1 545
$160 < v \leq 230$	1 514	1 540

7.7.19.7. The immediate action limit for cant (4.2.8.5)

P cases

Instead of point 4.2.8.5(3), for the 1 520 mm track gauge system, the maximum cant allowed in service is 170 mm.

7.7.19.8. The immediate action limits for switches and crossings (4.2.8.6)

P cases

Instead of point 4.2.8.6(3), for the 1 520 mm track gauge system, the technical characteristics of switches and crossings shall comply with the following in-service values:

- (a) Minimum value of bypass at the narrowest location between open switch rail and stock rail is 60 mm.
- (b) Minimum value of fixed nose protection for common crossings is 1 472 mm. This value is measured 14 mm below the running surface, and on the theoretical reference line, at an appropriate distance back from the actual point (RP) of the nose as indicated in Figure 2. For crossings with point retraction, this value can be reduced. In this case the Infrastructure Manager shall demonstrate that the point retraction is sufficient to guarantee that the wheel will not hit the nose at the actual point (RP).
- (c) Maximum value of free wheel passage at crossing nose is 1 436 mm
- (d) Minimum flangeway width is 40 mm
- (e) Minimum flangeway depth is 40 mm
- (f) Maximum excess height of check rail is 54 mm

7.7.19.9. Platform height (4.2.9.2)

P cases

For renewed lines with maximum speed of no more than 120 km/h the nominal platform height shall be allowed from 200 mm to 300 mm above the running surface.

7.7.19.10. Equivalent conicity in service (4.2.11.2)

T cases

Until introduction of equipment for measurement of elements required for calculation of equivalent conicity in service, it is allowed in Slovak republic not to assess this parameter.

7.7.19.11. Track sleepers (5.3.3)

P cases

The requirement of point 5.3.3(2) shall be applied for speeds above 250 km/h.

Appendix A

Assessment of interoperability constituents

The characteristics of the interoperability constituents to be assessed by the notified body or the manufacturer in accordance with the selected module, in the different phases of design, development and production, are marked by 'X' in Table 36. Where no assessment is required, this is marked by 'n.a.' in the table.

There are no particular assessment procedures required for interoperability constituents of the infrastructure subsystem.

Table 36

Assessment of interoperability constituents for the EC declaration of conformity

Characteristics to be assessed	Assessment in the following phase			
	Design and development phase			Production phase Manufacturing process + product test
	Design review	Review of manufacturing process	Type test	Product quality (series)
5.3.1 The rail				
5.3.1.1 Railhead profile	X	n.a.	X	X
5.3.1.2 Rail hardness	X	X	X	X
5.3.2 The rail fastening systems	n.a.	n.a.	X	X
5.3.3 Track sleepers	X	X	n.a.	X

Appendix B

Assessment of the infrastructure subsystem

The characteristics of the subsystem to be assessed in the different phases of design, construction and operation are marked by 'X' in Table 37.

Where no assessment by a notified body is required, this is marked by 'n.a.' in the table. This does not prevent the need for other assessments to be performed in the framework of other phases.

Definition of assessment phases:

- (1) 'Design review': it includes checking of correctness of values/parameters against applicable TSI requirements related to the final design.
- (2) 'Assembly before putting into service': checking on site that the actual product or subsystem complies with the relevant design parameters just before putting it into operation.

Column 3 gives references to point 6.2.4 'Particular assessment procedures for subsystem' and to point 6.2.5 'Technical solutions giving presumption of conformity at design stage'.

Table 37

Assessment of the infrastructure subsystem for the EC verification of conformity

Characteristics to be assessed	New line or upgrading/renewal project		Particular assessment procedures
	Design review	Assembly before putting into service	
	1	2	
Structure gauge (4.2.3.1)	X	X	6.2.4.1
Distance between track centres (4.2.3.2)	X	X	6.2.4.2
Maximum gradients (4.2.3.3)	X	n.a.	
Minimum radius of horizontal curve (4.2.3.4)	X	X	6.2.4.4
Minimum radius of vertical curve (4.2.3.5)	X	n.a.	6.2.4.4
Nominal track gauge (4.2.4.1)	X	X	6.2.4.3
Cant (4.2.4.2)	X	X	6.2.4.4
Cant deficiency (4.2.4.3)	X	n.a.	6.2.4.4 6.2.4.5
Abrupt change of cant deficiency (4.2.4.4)	X	n.a.	6.2.4.4
Assessment of design values for equivalent conicity (4.2.4.5)	X	n.a.	6.2.4.6
Railhead profile for plain line (4.2.4.6)	X	n.a.	6.2.4.7
Rail inclination (4.2.4.7)	X	n.a.	

Characteristics to be assessed	New line or upgrading/renewal project		Particular assessment procedures
	Design review	Assembly before putting into service	
	1	2	
Design geometry of switches and crossings (4.2.5.1)	X	n.a.	6.2.4.8
Use of swing nose crossings (4.2.5.2)	X	n.a.	6.2.4.8
Maximum unguided length of fixed obtuse crossings (4.2.5.3)	X	n.a.	6.2.4.8
Track resistance to vertical loads (4.2.6.1)	X	n.a.	6.2.5
Longitudinal track resistance (4.2.6.2)	X	n.a.	6.2.5
Lateral track resistance (4.2.6.3)	X	n.a.	6.2.5
Resistance of new bridges to traffic loads (4.2.7.1)	X	n.a.	6.2.4.9
Equivalent vertical loading for new earthworks and earth pressure effects (4.2.7.2)	X	n.a.	6.2.4.9
Resistance of new structures over or adjacent to tracks (4.2.7.3)	X	n.a.	6.2.4.9
Resistance of existing bridges and earthworks to traffic loads (4.2.7.4)	X	n.a.	6.2.4.10
The immediate action limit for alignment (4.2.8.1)	n.a.	n.a.	
The immediate action limit for longitudinal level (4.2.8.2)	n.a.	n.a.	
The immediate action limit for track twist (4.2.8.3)	n.a.	n.a.	
The immediate action limit of track gauge as an isolated defect (4.2.8.4)	n.a.	n.a.	
The immediate action limit for cant (4.2.8.5)	n.a.	n.a.	
The immediate action limit for switches and crossings (4.2.8.6)	n.a.	n.a.	
Usable length of platforms (4.2.9.1)	X	n.a.	
Platform height (4.2.9.2)	X	X	
Platform offset (4.2.9.3)	X	X	6.2.4.11
Track layout along platforms (4.2.9.4)	X	n.a.	
Maximum pressure variation in tunnels (4.2.10.1)	X	n.a.	6.2.4.12
Effect of crosswinds (4.2.10.2)	n.a.	n.a.	6.2.4.13
Location markers (4.2.11.1)	n.a.	n.a.	

Characteristics to be assessed	New line or upgrading/renewal project		Particular assessment procedures
	Design review	Assembly before putting into service	
	1	2	3
Equivalent conicity in service (4.2.11.2)	n.a.	n.a.	
Toilet discharge (4.2.12.2)	n.a.	n.a.	6.2.4.14
Train external cleaning facilities (4.2.12.3)	n.a.	n.a.	6.2.4.14
Water restocking (4.2.12.4)	n.a.	n.a.	6.2.4.14
Refuelling (4.2.12.5)	n.a.	n.a.	6.2.4.14
Electric shore supply (4.2.12.6)	n.a.	n.a.	6.2.4.14
Application of Interoperability Constituents	n.a.	X	

*Appendix C***Technical characteristics of track design and switches and crossings design**

*Appendix C.1***Technical characteristics of track design**

Track design shall be at least defined by the technical characteristics as follows:

- (a) Rail
 - Profile(s) & grades
 - Continuous welded rail or length of rails (for jointed track sections)
 - (b) Fastening system
 - Type
 - Pad stiffness
 - Clamping force
 - Longitudinal restraint
 - (c) Sleeper
 - Type
 - Resistance to vertical loads:
 - Concrete: design bending moments
 - Wood: compliance to EN 13145:2001
 - Steel: moment of inertia of cross section
 - Resistance to longitudinal and lateral loads: geometry and weight
 - Nominal and design track gauge
 - (d) Rail inclination
 - (e) Ballast cross sections (ballast shoulder — ballast thickness)
 - (f) Ballast type (grading = granulometrie)
 - (g) Sleeper spacing
 - (h) Special devices: for example sleeper anchors, third/fourth rail, ...
-

*Appendix C.2***Technical characteristics of switches and crossings design**

Switches and crossings design shall be at least defined by the technical characteristics as follows:

- (a) Rail
 - Profile(s) & grades (switch rail, stock rail)
 - Continuous welded rail or length of rails (for jointed track sections)
 - (b) Fastening system
 - Type
 - Pad stiffness
 - Clamping force
 - Longitudinal restraint
 - (c) Sleeper
 - Type
 - Resistance to vertical loads:
 - Concrete: design bending moments
 - Wood: compliance to EN 13145:2001
 - Steel: moment of inertia of cross section
 - Resistance to longitudinal and lateral loads: geometry and weight
 - Nominal and design track gauge
 - (d) Rail inclination
 - (e) Ballast cross sections (ballast shoulder — ballast thickness)
 - (f) Ballast type (grading = granulometrie)
 - (g) Type of crossing (fixed or movable point)
 - (h) Type of locking (switch pannel, movable point of crossing)
 - (i) Special devices: for example sleeper anchors, third/fourth rail, ...
 - (j) Generic switches and crossings drawing indicating
 - Geometrical diagram (triangle) describing the length of the turnout and the tangents at the end of the turnout
 - Main geometrical characteristics like the main radii in switch, closure and crossing panel, crossing angle
 - Sleeper spacing
-

*Appendix D***Conditions of use of track design and switches and crossings design**

*Appendix D.1***Conditions of use of track design**

Conditions of use of track design are defined to be as follows:

- (a) Maximum axle load [t]
 - (b) Maximum line speed [km/h]
 - (c) Minimum horizontal curve radius [m]
 - (d) Maximum cant [mm]
 - (e) Maximum cant deficiency [mm]
-

*Appendix D.2***Conditions of use of switches and crossings design**

Conditions of use of switches and crossings design are defined to be as follows:

- (a) Maximum axle load [t]
 - (b) Maximum line speed [km/h] on through route and diverging track of switches
 - (c) Rules for curved turnouts based on generic designs, giving minimum curvatures (for through route and diverging track of switches)
-

Appendix E

Capability requirements for structures according to traffic code

The minimum capability requirements for structures are defined in Table 38 and Table 39 according to the traffic codes given in Table 2 and Table 3. The capability requirements are defined in Table 38 and Table 39 by a combined quantity comprising of the EN line category and a corresponding maximum speed. The EN line category and associated speed shall be considered as a single combined quantity.

EN line category is a function of axle load and geometrical aspects relating to the spacing of axles. EN line categories are set out in Annex A of EN 15528:2008+A1:2012.

Table 38

EN Line Category –Associated Speed ⁽¹⁾ ⁽⁶⁾ [km/h] — Passenger traffic

Traffic code	Passenger Carriages (including Coaches, Vans and Car Carriers) and Light Freight Wagons ⁽²⁾ ⁽³⁾	Locomotives and Power Heads ⁽²⁾ ⁽⁴⁾	Electric or Diesel Multiple Units, Power Units and Railcars ⁽²⁾ ⁽³⁾
P1	Open point		
P2	Open point		
P3a (> 160 km/h)	A – 200 B1 – 160	D2 – 200 ⁽¹¹⁾	Open point
P3b (≤ 160 km/h)	B1 – 160	D2 – 160	C2 ⁽⁸⁾ – 160 D2 ⁽⁹⁾ – 120
P4a (> 160 km/h)	A – 200 B1 – 160	D2 – 200 ⁽¹¹⁾	Open point
P4b (≤ 160 km/h)	A – 160 B1 – 140	D2 – 160	B1 ⁽⁷⁾ – 160 C2 ⁽⁸⁾ – 140 D2 ⁽⁹⁾ – 120
P5	B1 – 120	C2 – 120 ⁽⁵⁾	B1 ⁽⁷⁾ – 120
P6	a12 ⁽¹⁰⁾		
P1520	Open point		
P1600	Open point		

Table 39

EN Line Category –Associated Speed ⁽¹⁾ ⁽⁶⁾ [km/h] — Freight traffic

Traffic code	Freight wagons and other vehicles	Locomotives ⁽²⁾
F1	D4 – 120	D2 – 120
F2	D2 – 120	D2 – 120

Traffic code	Freight wagons and other vehicles	Locomotives ⁽²⁾
F3	C2 – 100	C2 – 100
F4	B2 – 100	B2 – 100
F1520	Open point	
F1600	Open point	

Notes:

- (1) The indicated speed value in the table represents the maximum requirement for the line and may be lower in accordance with the requirements in point 4.2.1(10). When checking individual structures on the line, it is acceptable to take account of the type of vehicle and local allowed speed.
- (2) Passenger Carriages (including Coaches, Vans, Car Carriers), Other Vehicles, Locomotives, Power Heads, Diesel and Electric Multiple Units, Power Units and Railcars are defined in the RST TSI. Light Freight Wagons are defined as vans except that they are allowed to be conveyed in formations which are not intended to convey passengers.
- (3) The requirements for structures are compatible with Passenger Coaches, Vans, Car Carriers, Light Freight Wagons and vehicles in Diesel and Electric Multiple Units and Power Units with a length of; 18 m to 27,5 m for conventional and articulated vehicles and with a length of 9 m to 14 m for regular single axles.
- (4) The requirements for structures are compatible with up to two adjacent coupled locomotives and/or power heads. The requirements for structures are compatible with a maximum speed of 120 km/h for three or more adjacent coupled locomotives and/or power heads (or a train of locomotives and/or power heads) subject to the locomotives and/or power heads satisfying the corresponding limits for freight wagons.
- (5) For traffic code P5 the Member State may indicate whether the requirements for locomotives and power heads apply.
- (6) When checking the compatibility of individual trains and structures, the basis of the compatibility check shall be in accordance with Appendix K to this TSI.
- (7) The requirements for structures are compatible with an average mass per unit length over the length of each coach/vehicle of 2,75 t/m
- (8) The requirements for structures are compatible with an average mass per unit length over the length of each coach/vehicle of 3,1 t/m
- (9) The requirements for structures are compatible with an average mass per unit length over the length of each coach/vehicle of 3,5 t/m
- (10) See Appendix L to this TSI
- (11) Only 4 axle vehicles allowed. The spacing of the axles in a bogie shall be at least 2,6 m. The average mass per unit length over the length of the vehicle shall not exceed 5,0 t/m.

Appendix F

Capability requirements for structures according to traffic code in the United Kingdom of Great Britain and Northern Ireland

The minimum capability requirements for structures are defined in Table 40 and Table 41 according to the traffic codes given in Table 2 and Table 3. The capability requirements are defined in Table 40 and Table 41 by a combined quantity comprising of the Route Availability number and a corresponding maximum speed. The Route Availability number and associated speed shall be considered as a single combined quantity.

The Route Availability number is a function of axle load and geometrical aspects relating to the spacing of axles. Route Availability numbers are defined in the national technical rules notified for this purpose.

Table 40

Route Availability number – Associated Speed ⁽¹⁾ ⁽⁵⁾ [miles per hour] — Passenger traffic

Traffic code	Passenger Carriages (including Coaches, Vans and Car Carriers) and Light Freight Wagons ⁽²⁾ ⁽³⁾ ⁽⁶⁾	Locomotives and Power Heads ⁽²⁾ ⁽⁴⁾	Electric or Diesel Multiple Units, Power Units and Railcars ⁽²⁾ ⁽³⁾ ⁽⁶⁾
P1	Open point		
P2	Open point		
P3a (> 160 km/h)	RA1 – 125 RA2 – 90	RA7 – 125 ⁽⁷⁾ RA8 – 110 ⁽⁷⁾ RA8 – 100 ⁽⁸⁾ RA5 – 125 ⁽⁹⁾	Open point
P3b (≤ 160 km/h)	RA1 – 100 RA2 – 90	RA8 – 100 ⁽⁸⁾ RA5 – 100 ⁽⁹⁾	RA3 – 100
P4a (> 160 km/h)	RA1 – 125 RA2 – 90	RA7 – 125 ⁽⁷⁾ RA7 – 100 ⁽⁸⁾ RA4 – 125 ⁽⁹⁾	Open point
P4b (≤ 160 km/h)	RA1 – 100 RA2 – 90	RA7 – 100 ⁽⁸⁾ RA4 – 100 ⁽⁹⁾	RA3 – 100
P5	RA1 – 75	RA5 – 75 ⁽⁸⁾ ⁽¹⁰⁾ RA4 – 75 ⁽⁹⁾ ⁽¹⁰⁾	RA3 – 75
P6	RA1		
P1600	Open point		

Table 41

Route Availability number — Associated Speed ⁽¹⁾ ⁽⁵⁾ [miles per hour] — Freight traffic

Traffic code	Freight wagons and other vehicles	Locomotives ⁽²⁾ ⁽⁴⁾ ⁽⁸⁾
F1	RA8 – 75	RA7 – 75
F2	RA7 – 75	RA7 – 75

Traffic code	Freight wagons and other vehicles	Locomotives ^(?) ⁽⁴⁾ ⁽⁸⁾
F3	RA5 – 60	RA7 – 60
F4	RA4 – 60	RA5 – 60
F1600	Open point	

Notes:

- (1) The indicated speed value in the table represents the maximum requirement for the line and may be lower in accordance with the requirements in point 4.2.1(10). When checking individual structures on the line, it is acceptable to take account of the type of vehicle and local allowed speed.
- (2) Passenger Carriages (including Coaches, Vans, Car Carriers), Other Vehicles, Locomotives, Power Heads, Diesel and Electric Multiple Units, Power Units and Railcars are defined in the RST TSI. Light Freight Wagons are defined as vans except that they are allowed to be conveyed in formations which are not intended to convey passengers.
- (3) The requirements for structures are compatible with Passenger Coaches, Vans, Car Carriers, Light Freight Wagons and vehicles in Diesel and Electric Multiple Units and Power Units with a length of; 18 m to 27,5 m for conventional and articulated vehicles and with a length of 9 m to 14 m for regular single axles.
- (4) The requirements for structures are compatible with up to two adjacent coupled locomotives and/or power heads. The requirements for structures are compatible up to a maximum speed of 75 mph for up to five adjacent coupled locomotives and/or power heads (or a train of locomotives and/or power heads) subject to the locomotives and/or power heads satisfying the corresponding limits for freight wagons.
- (5) When checking the compatibility of individual trains and structures, the basis of the compatibility check shall be in accordance with Appendix K except where modified by the national technical rules notified for this purpose.
- (6) The requirements for structures are compatible with an average mass per unit length over the length of each coach/vehicle of 3,0 t/m
- (7) Only 4 axle vehicles allowed. The spacing of the axles in a bogie shall be at least 2,6 m. The average mass per unit length over the length of the vehicle shall not exceed 4,6 t/m.
- (8) 4 or 6 axle vehicles allowed.
- (9) Powerhead, only 4 axle vehicles allowed. Also includes locomotives where difference in length between locomotive and hauled vehicles is less than 15 % of length of hauled vehicles for speeds over 90 mph.
- (10) For traffic code P5 the Member State may indicate whether the requirements for locomotives and power heads apply.

Appendix G

Speed conversion to miles per hour for Ireland and the United Kingdom of Great Britain and Northern Ireland

Table 42

Speed conversion from [km/h] to [mph]

Speed [km/h]	Speed [mph]
2	1
3	1
5	3
10	5
15	10
20	10
30	20
40	25
50	30
60	40
80	50
100	60
120	75
140	90
150	95
160	100
170	105
180	110
190	120
200	125
220	135
225	140
230	145
250	155
280	175
300	190
320	200
350	220

Appendix H

Structure gauge for the 1 520 mm track gauge system

Figure 3

Structure gauge S for the 1 520 mm track gauge system [dimensions in mm]

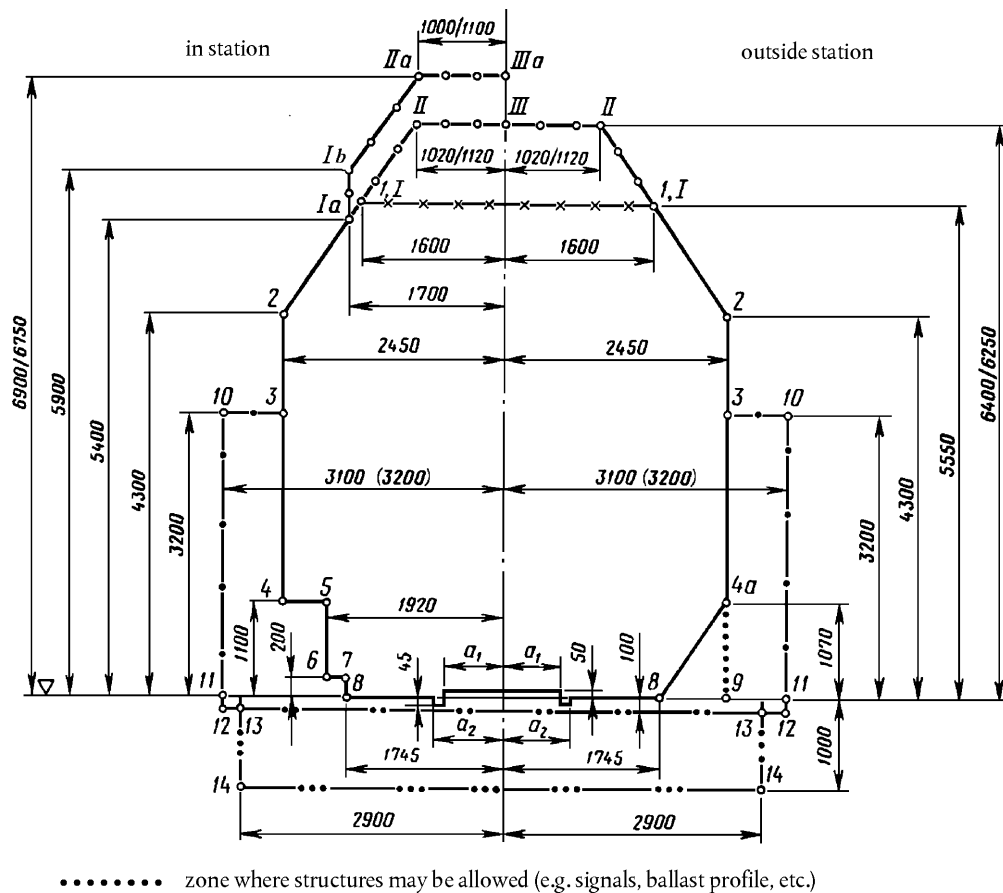

Clarifications for Figure 3:

All horizontal dimensions shall be measured from the centre of the track, and all vertical dimensions shall be measured from the top of the rail head level.

Left side of contour — applications for tracks in the railway station, stop/halt and for branch tracks/industry track (except contour Ia, Ib, IIa, IIIa),

Right side of contour — applications for tracks on the plain line.

Application of specific parts of the contour:

1,I — 1, I — contour of structure gauge for non-electrified tracks,

1,I — II — III — II — 1,I — contour of structure gauge for electrified tracks — for tracks on the plain (open) line and for tracks in the railway station and for branch/industry tracks, where standing of vehicles is not expected,

Ia — Ib — IIa — IIIa — contour of structure gauge for electrified tracks — for other station tracks and other branch/industry tracks

Note: Values of 1 000 mm, 1 020 mm, 6 900 mm and 6 400 mm given in the numerators are for contact system with carrying cable.

Values of 1 100 mm, 1 120 mm, 6 750 mm and 6 250 mm given in the denominator are for contact system without carrying cable,

11 — 10 — 3 — contour of structure gauge for structures and equipment (except tunnel, bridge, platform, ramp) on the outside of 'edge' tracks;

9 — 4a — contour of structure gauge for tunnel, for railing on the bridge, elevated track (ballast profile), signals, embankment wall and for railing on the other structures of railway subgrade,

12-12 — contour from which (on track between stations or in stations within usable length of track) any device could not be above (higher), except level crossing covering, locomotive signaling inductors, switches mechanism and their near situated signaling and safety equipment

14-14 — contour of building (or foundation), underground cables, steel cables, pipes and other not railway structures (except signalling and safety equipment)

For nominal track gauge of 1 520 mm $a_1 = 670$ mm and $a_2 = 760$ mm.

For nominal track gauge of 1 524 mm $a_1 = 672$ mm and $a_2 = 762$ mm.

Figure 4

Reference profile of the lower parts on tracks fitted with double slip

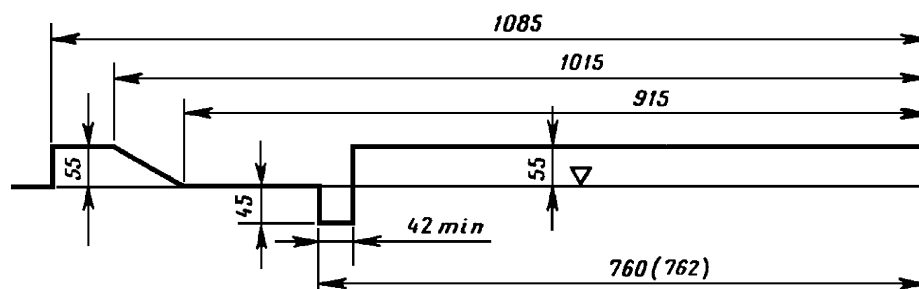

Clarification for Figure 4:

The distance of 760 mm is for track gauge 1 520 mm, and 762 mm for track gauge 1 524 mm.

Figure 5

Reference profile of the lower parts on marshalling yards fitted with rail brakes

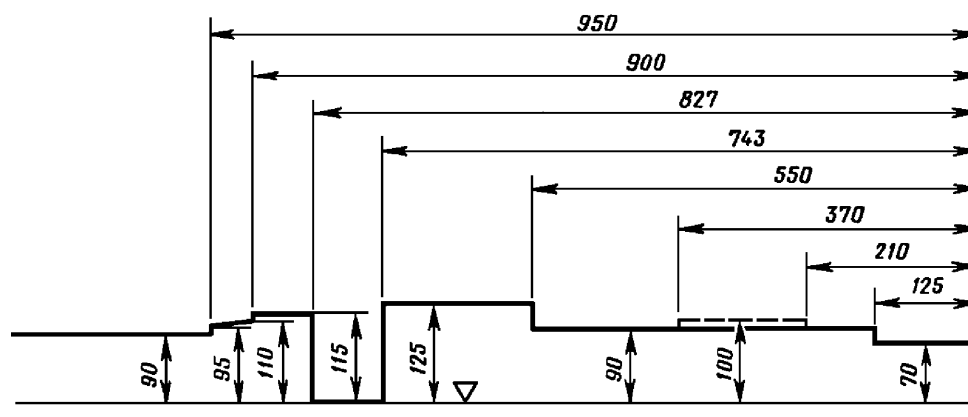

Appendix J

Safety assurance over fixed obtuse crossings

(J.1) The fixed obtuse crossings should be designed in order not to have a too long unguided length. In obtuse crossing check rails cannot be constructed to assure guidance over the whole length. This unguided length can be accepted up to a certain limit, defined by a reference situation defining:

- (a) Minimum crossing angle: tangent 1 in 9 ($\text{tga} = 0,11$, $\alpha = 6^{\circ}20'$)
- (b) Minimum radius through obtuse crossing: 450 m
- (c) Minimum height of check rail: 45 mm
- (d) Nose shape as defined in the figure below

Figure 6

Obtuse crossing

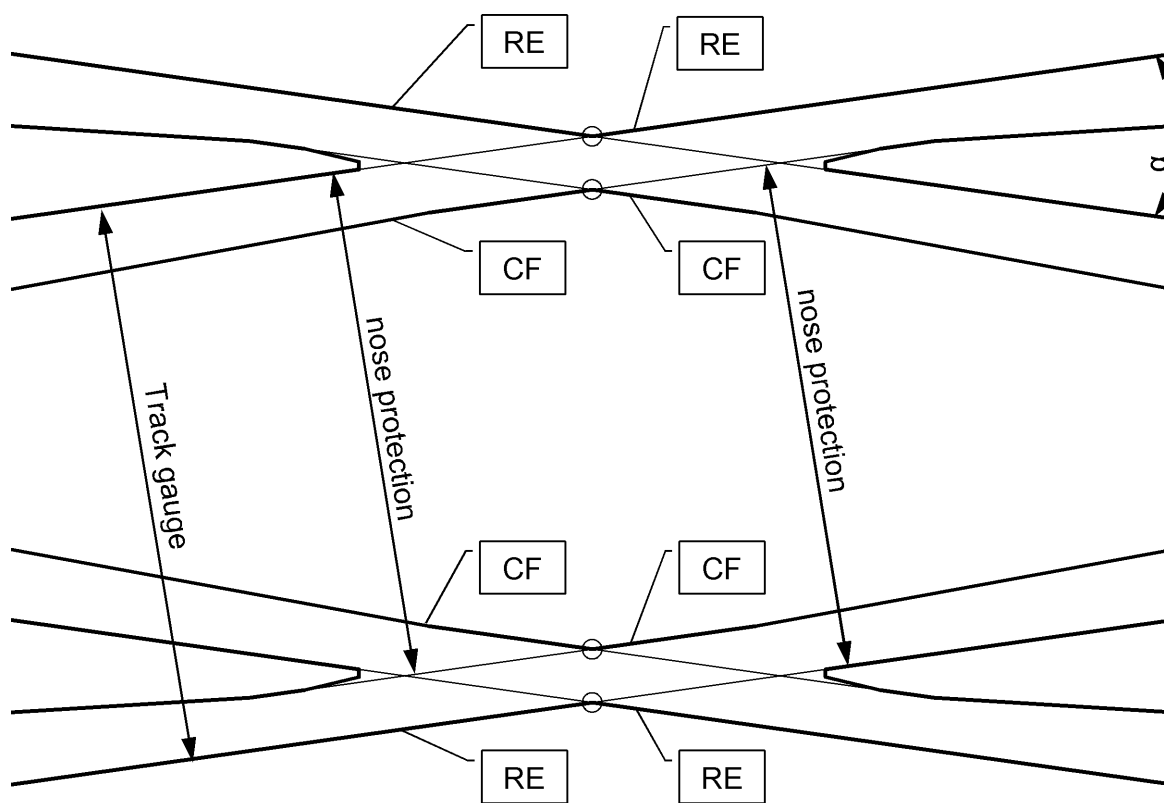

RE = running edge
CF = check face (guiding edge)

Figure 7

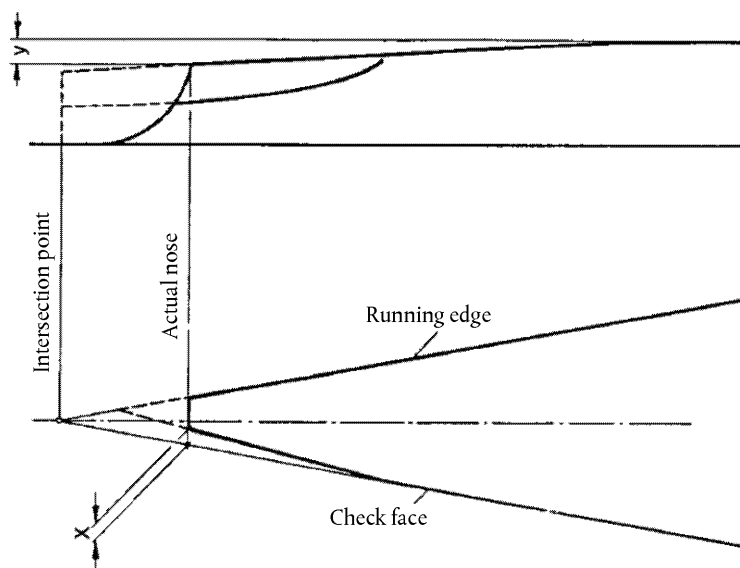
Point retraction X on check face

$X = 3 \text{ mm}$ (over a length of 150 mm).

$Y = 8 \text{ mm}$ (over a length of 200 to 500 mm approximately)

- (j.2) If one or more of the above requirements is not respected, the design shall be checked, verifying either the equivalence of the unguided length or acceptance of the interference between wheel and nose when they get in contact.
- (j.3) The design shall be checked for wheels with diameter between 630 mm and 840 mm. For wheel diameters between 330 mm and 630 mm specific demonstrations are required.
- (j.4) The following graphs allow simple verification of unguided length for specific situation with different crossing angles, height of check rail and different crossing curvature.

The graphs consider the following maximum track tolerances:

- (a) Track gauge between 1 433 mm and 1 439 mm inclusive
- (b) Nose protection between 1 393 mm and 1 398 mm inclusive
- (c) Free wheel passage $\leq 1 356 \text{ mm}$

Figure 8 allows to specify the minimum wheel diameter that can run on curved obtuse crossings with a radius of 450 m, Figure 9 allows it for straight obtuse crossings.

For other situations specific calculations can be performed.

- (j.5) For track gauge systems other than 1 435 mm, specific calculations shall be performed.

Figure 8

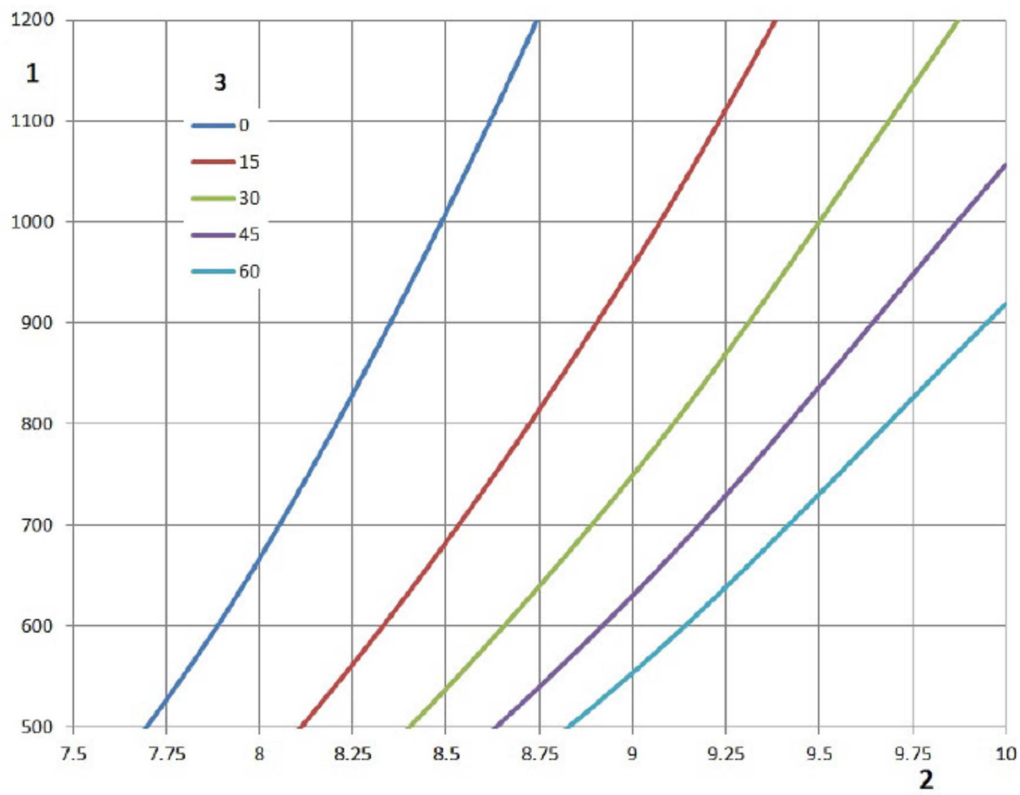
Minimum wheel diameter against crossing angle for 450 m radius of obtuse crossing

1 Minimum wheel diameter [mm]

2 N for crossing angle tangent 1 in N

3 Height of check rail [mm] (Z3)

Figure 9

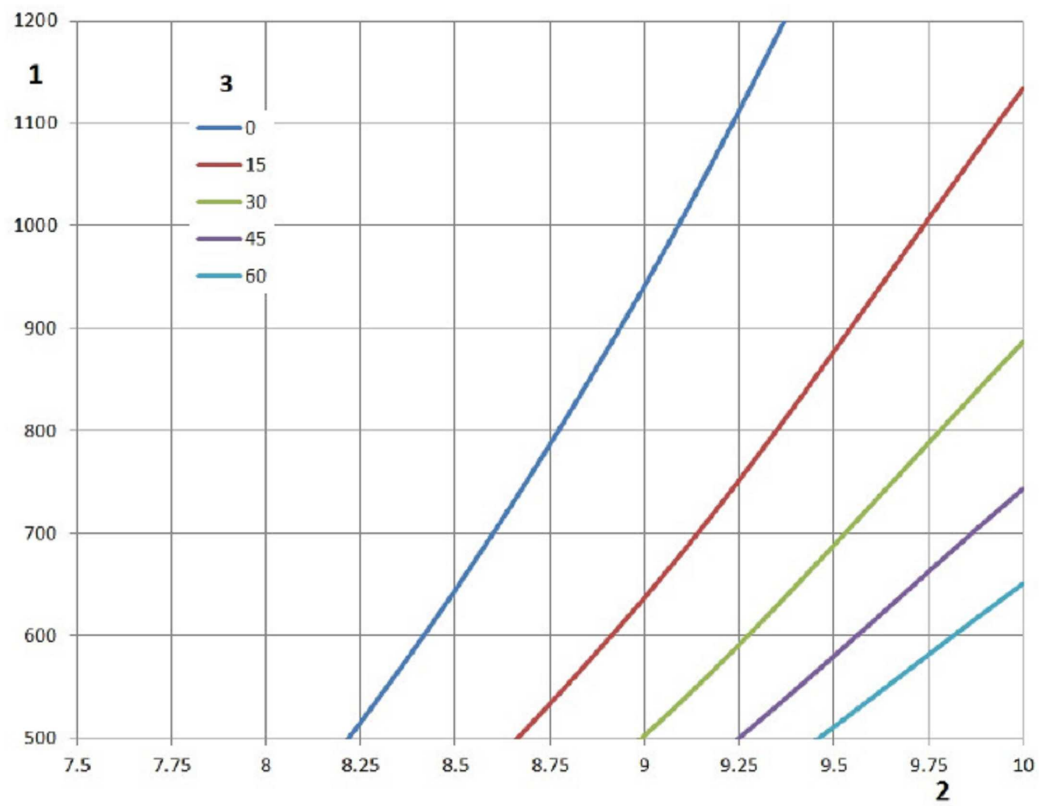
Minimum wheel diameter against crossing angle for straight obtuse crossing

1 Minimum wheel diameter [mm]

2 N for crossing angle tangent 1 in N

3 Height of check rail [mm] (Z3)

Appendix K

Basis of minimum requirements for structures for passenger coaches and multiple units

The following mass definitions for passenger carriages and multiple units form the basis of the minimum requirements for structures and checking the compatibility of structures with passenger coaches and multiple units.

The EN line categories in Appendix E are based upon the design mass under exceptional payload according to section 2.1 of EN 15663:2009+AC:2010 taking the values for passenger payload in standing areas given in Table 45 into account.

Where checks on the dynamic response of rail bridges are required to specify the load carrying capacity of the bridge, the load capacity of the bridge should be specified and expressed in terms of the design mass under normal payload according to section 2.1 of EN 15663:2009+AC:2010 taking the values for passenger payload in standing areas given in Table 45 into account.

It is anticipated that the next revision of EN15528+A1:2012 will specify that these mass definitions shall be used when checking the compatibility of infrastructure and rolling stock.

Table 45

Passenger payload in standing areas in kg/m²

Type of trains	Normal payload to specify Dynamic Compatibility	Exceptional payload to specify Line Category (Static Compatibility)
High speed and long distance trains Table 3 in EN 15663:2009+AC:2010	160 ⁽¹⁾	320
High speed and long distance trains Reservation Obligatory Table 3 in EN 15663:2009+AC:2010	0	320
Others (regional, commuter, suburban trains) Table 4 in EN 15663:2009+AC:2010	280	500 ⁽²⁾

Notes:

⁽¹⁾ Normal payload of Table 3 of EN 15663:2009+AC:2010 plus an additional 160 kg/m² for standing areas

⁽²⁾ For certain types of commuter services (e.g. RATP Paris) the passenger payload in standing areas is 700 kg/m²

Appendix L

Definition of EN line category a12 for traffic code P6

Traffic code P6 is defined by EN line category **a12**.

EN line category **a12** is defined by a load model comprising of an unlimited number of the reference wagon **a12** as defined in Figure 11. The reference wagon **a12** is defined by axle load, the geometrical characteristics of the spacing of axles and the mass per unit length as defined in Figure 10.

Figure 10

Reference wagon of EN line category a12

Reference wagon	Axle load P (t)	Mass per unit length p (t/m)	Geometrical characteristics
a12	12,0	2,4	

Figure 11

Load model of EN line category a12

Line category	Arrangement of reference wagons n ... unlimited number
a12	

For the classification of infrastructure, EN line category **a12** shall be used in accordance with chapter 5 of EN 15528:2008+A1:2012.

General information concerning the use of EN line category **a12** for the categorisation of vehicles into EN line categories is given in chapter 6.1 of EN 15528:2008+A1:2012 and shall be read in conjunction with Appendix K of this TSI.

It is anticipated that the next revision of EN 15528+A1:2012 will include line category a12.

Appendix M

Specific case on the Estonian network

(1) Locomotive

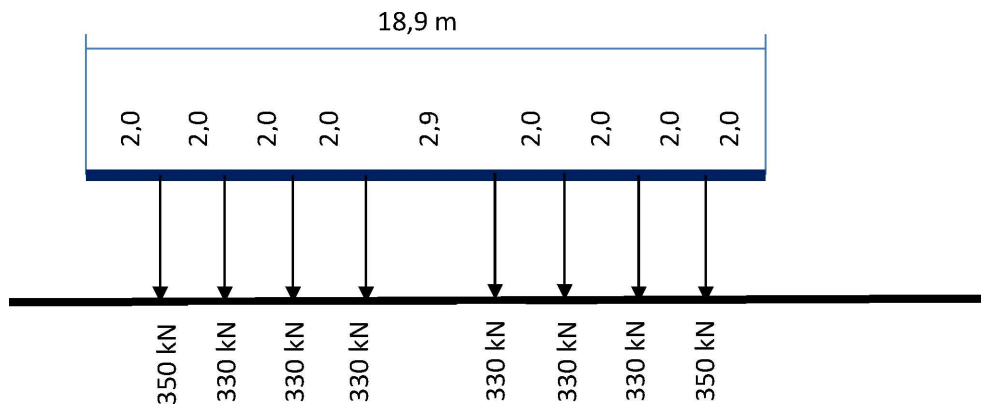

(2) Distributed load: 140 kN/m

(3) Wagon

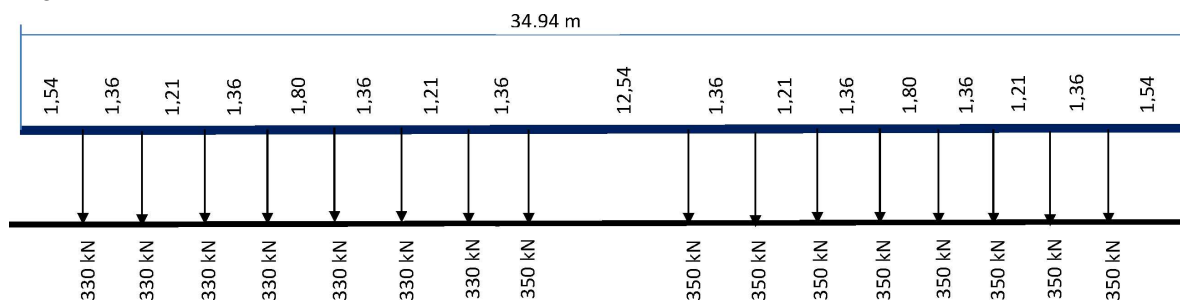

Appendix N

Specific cases of the Hellenic network

Deleted

Appendix O

Specific case on the Ireland and United Kingdom of Northern Ireland networks

Rules and drawings related to gauges IRL1, IRL2 and IRL3 are an open point.

Appendix P

Structure gauge for the lower parts for the 1 668 mm track gauge on the Spanish network

Structures gauges shall be obtained on the basis of the kinematic reference profiles and associated rules.

Calculations of structure gauge shall be done using the kinematic method in accordance with the requirements of chapters 5, 7 and 10 of EN 15273-3:2013 with the kinematic reference profiles and associated rules defined in this Appendix.

P.1. REFERENCE PROFILES

P.1.1. Kinematic reference profile GEI1

Figure 12 shows the reference profile for kinematic gauge GEI1 for vehicles which can pass over rail brakes in an active position.

Figure 12

Reference profile of lower parts of kinematic gauge GEI1 for vehicles which can pass over rail brakes in an active position (l = track gauge)

(Dimensions in millimeters)

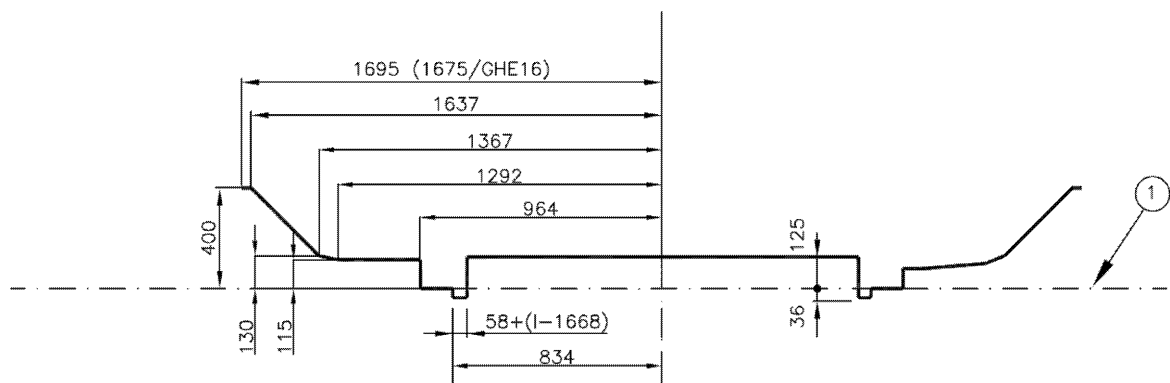

(1) Running surface.

P.1.2. Kinematic reference profile GEI2

Figure 13 shows the reference profile for kinematic gauge GEI2 for vehicles which may pass over rail brakes in a non-active position.

Figure 13

Reference profile of lower parts of kinematic gauge GEI2 for vehicles which may pass over rail brakes in a non-active position (l = track gauge)

(Dimensions in millimeters)

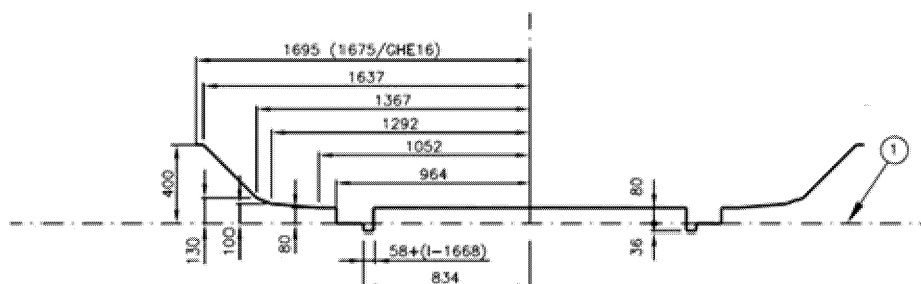

(1) Running surface.

P.2. ASSOCIATED RULES

Table 46 shows the additional overthrows for gauges GEI1 and GEI2.

Table 46

Rules for additional overthrows S for gauges GEI1 and GEI2

Additional overthrows for track gauge 'l' and height 'h' compared to the running surface	
Radius	$h \leq 0,4 \text{ m}$
$250 \leq R < \infty$	$S_{icin} = S_{acin} = \frac{2,5}{R} + \frac{l - 1,668}{2}$
$150 \leq R < 250$	$S_{icin} = \frac{50}{R} - 0,19 + \frac{l - 1,668}{2}$ $S_{acin} = \frac{60}{R} - 0,23 + \frac{l - 1,668}{2}$

P.3. VERTICAL LOWERING

The heights of the lower part must be reduced by the value $50/R_v$ (m), the radius being in metres.

The vertical curve radius R_v is limited to 500 m. Heights not exceeding 80 mm shall be considered as zero within a radius R_v between 500 m and 625 m

Appendix Q

National technical rules for UK-GB Specific Cases

The National Technical Rules for UK-GB specific cases referred to in point 7.7.17 of this TSI are contained in the documents listed in Table 47. All documents are available on www.rgsonline.co.uk.

Table 47

Notified national technical rules for UK-GB Specific Cases

Specific Case	TSI Point	Requirement	NTR Ref	NTR Title
7.7.17.1	4.2.1: Table 2 & Table 3	Categories of line: Gauge	GC/RT5212	Requirements for Defining and Maintaining Clearances
			GE/RT8073	Requirements for the Application of Standard Vehicle Gauges
			GI/RT7016	Interface between Station Platforms, Track and Trains
7.7.17.2 & 7.7.17.8	4.2.3.1 & 6.2.4.1	Structure gauge	GC/RT5212	Requirements for Defining and Maintaining Clearances
			GE/RT8073	Requirements for the Application of Standard Vehicle Gauges
			GI/RT7016	Interface between Station Platforms, Track and Trains
7.7.17.3 & 7.7.17.9	4.2.3.2: Table 4 & 6.2.4.2	Distance between track centres	GC/RT5212	Requirements for Defining and Maintaining Clearances
7.7.17.4	4.2.5.3 & Annex J	Maximum unguided length of fixed obtuse crossings	GC/RT5021	Track System Requirements
			GM/RT2466	Railway Wheelsets
7.7. 17.6	4.2.9.2	Platform height	GI/RT7016	Interface between Station Platforms, Track and Trains
7.7. 17.7 & 7.7. 17.10	4.2.9.3 & 6.2.4.11	Platform offset	GI/RT7016	Interface between Station Platforms, Track and Trains
			GC/RT5212	Requirements for Defining and Maintaining Clearances

*Appendix R***List of open points**

- (1) Requirements for the design of track, including switches and crossings, which are compatible with the use of eddy current braking systems (4.2.6.2.2)
 - (2) Minimum factor alpha (a) for Traffic codes P1520 and F1520 (4.2.7.1.1)
 - (3) Immediate action limits for isolated defects in alignment for speeds of more than 300 km/h (4.2.8.1)
 - (4) Immediate action limits for isolated defects in longitudinal level for speeds of more than 300 km/h (4.2.8.2)
 - (5) The minimum allowed value of distance between track centres for the uniform structure gauge IRL3 is an open point (7.7.18.2)
 - (6) EN Line Category –Associated Speed [km/h] for Traffic codes P1, P2, P3a, P4a, P1520, P1600, F1520 and F1600 (Appendix E, Tables 38 and 39)
 - (7) EN Line Category –Associated Speed [km/h] for Traffic codes P1, P2, P1600 and F1600 (Appendix F, Tables 40 and 41)
 - (8) Rules and drawings related to gauges IRL1, IRL2 and IRL3 are an open point (Appendix O)
 - (9) Requirements for mitigating the risk related to the 'ballast pick up' phenomenon (point 4.2.10.3) (open point also in the LOC&PAS TSI)
-

Appendix S

Glossary

Table 48

Terms

Defined term	TSI point	Definition
Actual point (RP)/ Praktischer Herzpunkt/ Pointe de coeur	4.2.8.6	Physical end of a crossing vee. See Figure 2, which shows the relationship between the actual point (RP) and the intersection point (IP).
Alert limit/ Auslösewert/ Limite d'alerte	4.5.2	Refers to the value which, if exceeded, requires that the track geometry condition is analysed and considered in the regularly planned maintenance operations.
Axle load/ Achsfahrmasse/ Charge à l'essieu	4.2.1, 4.2.6.1	Sum of the static vertical wheel forces exerted on the track through a wheelset or a pair of independent wheels divided by acceleration of gravity.
Braking systems independent of wheel-rail adhesion conditions'	4.2.6.2.2	
Cant/ Überhöhung/ Dévers de la voie	4.2.4.2 4.2.8.5	Difference in height, relative to the horizontal, of the two rails of one track at a particular location, measured at the centrelines of the heads of the rails.
Cant deficiency/Überhöhungs- fehlbetrag/Insuffisance de devers	4.2.4.3	Difference between the applied cant and a higher equilibrium cant.
Common crossing/ Starres Herzstück/ Coeur de croisement	4.2.8.6	Arrangement ensuring intersection of two opposite running edges of turnouts or diamond crossings and having one crossing vee and two wing rails.
Crosswind/ Seitenwind/ Vents traversiers	4.2.10.2	Strong wind blowing laterally to a line which may adversely affect the safety of trains running.
Design value/ Planungswert/ Valeur de conception	4.2.3.4, 4.2.4.2, 4.2.4.5, 4.2.5.1, 4.2.5.3	Theoretical value without manufacturing, construction or maintenance tolerances.
Design track gauge/ Konstruktionsspurweite/ Ecartement de conception de la voie	5.3.3	A single value which is obtained when all the components of the track conform precisely to their design dimensions or their median design dimension when there is a range.
Distance between track centres/ Gleisabstand/ Entraxe de voies	4.2.3.2	The distance between points of the centre lines of the two tracks under consideration, measured parallel to the running surface of the reference track namely the less canted track.

Defined term	TSI point	Definition
Dynamic lateral force/Dynamische Querkraft/ Effort dynamique transversal	4.2.6.3	The sum of dynamic forces exerted by a wheelset on the track in lateral direction.
Earthworks/ Erdbauwerke/ Ouvrages en terre	4.2.7.2, 4.2.7.4	Soil structures and soil-retaining structures that are subject to railway traffic loading.
EN Line Category/ EN Streckenklasse/ EN Catégorie de ligne	4.2.7.4, Appendix E	The result of the classification process set out in EN 15528:2008 +A1:2012 Annex A and referred to in that standard as 'Line Category'. It represents the ability of the infrastructure to withstand the vertical loads imposed by vehicles on the line or section of line for regular service.
Equivalent conicity/ Äquivalente Konizität/ Conicité équivalente	4.2.4.5, 4.2.11.2	The tangent of the cone angle of a wheelset with coned wheels whose lateral movement has the same kinematic wavelength as the given wheelset on straight track and large-radius curves.
Fixed nose protection/ Leitweite/ Cote de protection de pointe	4.2.5.3, Appendix J	Dimension between the crossing nose and check rail (see dimension No 2 on Figure 14 below).
Flangeway depth/ Rillentiefe/ Profondeur d'ornière	4.2.8.6.	Dimension between the running surface and the bottom of flangeway (see dimension No 6 on Figure 14 below).
Flangeway width/ Rillenweite/ Largeur d'ornière	4.2.8.6.	Dimension between a running rail and an adjacent check or wing rail (see dimension No 5 on Figure 14 below).
Free wheel passage at check rail/ wing rail entry/ Freier Raddurchlauf im Radlenker-Einlauf/ Flügelschienen-Einlauf/Côte d'équilibrage du contre-rail	4.2.8.6.	Dimension between the working face of the crossing check rail or wing rail and the gauge face of the running rail opposite across the gauge measured at entry to check rail or wing rail respectively. (see dimensions No 4 on Figure 14 below). The entry to the check rail or wing rail is the point at which the wheel is allowed to contact the check rail or wing rail.
Free wheel passage at crossing nose/ Freier Raddurchlauf im Bereich der Herzspitze/ Cote de libre passage dans le croisement	4.2.8.6.	Dimension between the working face of the crossing wing rail and check rail opposite across the gauge (see dimension No 3 on Figure 14 below).
Free wheel passage in switches/ Freier Raddurchlauf im Bereich der Zungen-vorrichtung/Côte de libre passage de l'aiguillage	4.2.8.6.	Dimension from the gauge face of one switch rail to the back edge of the opposite switch rail (see dimension No 1 on Figure 14 below).

Defined term	TSI point	Definition
Gauge/ Begrenzungslinie/ Gabarit	4.2.1, 4.2.3.1	Set of rules including a reference contour and its associated calculation rules allowing definition of the outer dimensions of the vehicle and the space to be cleared by the infrastructure.
HBW/HBW/HBW	5.3.1.2	The non SI unit for steel hardness defined in EN ISO 6506-1:2005 Metallic materials — Brinell hardness test. Test method.
Height of check rail/ Radlenkerüberhöhung/ Surélévation du contre rail	4.2.8.6, Appendix J	Height of the check rail above the running surface (see dimension 7 on Figure 14 below).
Immediate Action Limit/Sofort- eingriffsschwelle/ Limite d'intervention immédiate	4.2.8, 4.5	The value which, if exceeded, requires taking measures to reduce the risk of derailment to an acceptable level.
Infrastructure Manager/ Betreiber der Infrastruktur/ Gestionnaire de l'Infrastructure	4.2.5.1, 4.2.8.3, 4.2.8.6, 4.2.11.2 4.4, 4.5.2, 4.6, 4.7, 6.2.2.1, 6.2.4, 6.4	As defined in Article 2h) of Directive 2001/14/EC of 26 February 2001 on the allocation of railway infrastructure capacity and the levying of charges for the use of railway infrastructure and safety certification (OJ L 75, 15.3.2001, p. 29).
In service value/ Wert im Betriebszustand/ Valeur en exploitation	4.2.8.5, 4.2.11.2	Value measured at any time after the infrastructure has been placed into service.
Intersection point (IP)/ Theoretischer Herzpunkt/ Point d'intersection théorique	4.2.8.6	Theoretical intersection point of the running edges at the centre of the crossing (see Figure 2).
Intervention Limit/Eingriffsschwelle/ Valeur d'intervention	4.5.2	The value, which, if exceeded, requires corrective maintenance in order that the immediate action limit shall not be reached before the next inspection;
Isolated defect/ Einzelfehler/ Défaut isolé	4.2.8	A discrete track geometry fault.
Line speed/ Streckengeschwindigkeit/ Vitesse de la ligne	4.2.1	Maximum speed for which a line has been designed.
Maintenance file/ Instandhaltungsdossier/ Dossier de maintenance	4.5.1	Elements of the technical file relating to conditions and limits of use and instructions for maintenance.
Maintenance plan/ Instandhaltungsplan/ Plan de maintenance	4.5.2	A series of documents setting out the infrastructure maintenance procedures adopted by an Infrastructure Manager.

Defined term	TSI point	Definition
Multi-rail track/ Mehrschienengleis/ Voie à multi écartement	4.2.2.2	Track with more than two rails, where at least two pairs of respective rails are designed to be operated as separate single tracks, with or without different track gauges.
Nominal track gauge/ Nennspurweite/ Ecartement nominal de la voie	4.2.4.1	A single value which identifies the track gauge but may differ from the design track gauge.
Normal service/ Regelbetrieb/ Service régulier	4.2.2.2 4.2.9	The railway operating to a planned timetable service.
Passive provision/ Vorsorge für künftige Erweiterungen/Réservation pour extension future	4.2.9	Provision for the future construction of a physical extension to a structure (for example: increased platform length).
Performance Parameter/ Leistungskennwert/ Paramètre de performance	4.2.1	Parameter describing a TSI Category of Line used as the basis for the design of infrastructure subsystem elements and as the indication of the performance level of a line.
Plain line/ Freie Strecke/ Voie courante	4.2.4.5 4.2.4.6 4.2.4.7	Section of track without switches and crossings.
Point retraction/ Spitzenbeihoblung/ Dénivellation de la pointe de cœur	4.2.8.6	The reference line in a fixed common crossing can deviate from the theoretical reference line. From a certain distance to the crossing point, the reference line of the vee can, depending on the design, be retracted from this theoretical line away from the wheel flange in order to avoid contact between both elements. This situation is described in Figure 2.
Rail inclination/ Schienenneigung/ Inclinaison du rail	4.2.4.5 4.2.4.7	An angle defining the inclination of the head of a rail when installed in the track relative to the plane of the rails (running surface), equal to the angle between the axis of symmetry of the rail (or of an equivalent symmetrical rail having the same rail head profile) and the perpendicular to the plane of the rails.
Rail pad/ Schienenzwischenlage/ Semelle sous rail	5.3.2	A resilient layer fitted between a rail and the supporting sleeper or baseplate.
Reverse curve/ Gegenbogen/ Courbes et contre-courbes	4.2.3.4	Two abutting curves of opposite flexure or hand
Structure gauge/ Lichtraum/ Gabarit des obstacles	4.2.3.1	Defines the space in relation to the reference track that shall be cleared of all objects or structures and of the traffic on the adjacent tracks, in order to allow safe operation on the reference track. It is defined on the basis of the reference contour by application of the associated rules.
Swing nose	4.2.5.2	

Defined term	TSI point	Definition
Switch/ Zungenvorrichtung/ aiguillage	4.2.8.6	A unit of track comprising two fixed rails (stock rails) and two movable rails (switch rails) used to direct vehicles from one track to another track.
Switches and crossings/ Weichen und Kreuzungen/ Appareil de voie	4.2.4.5, 4.2.4.7, 4.2.5, 4.2.6, 4.2.8.6, 5.2, 6.2.4.4, 6.2.4.8, 6.2.5.2, 7.3.3, Appendix C and D,	Track constructed from sets of switches and individual crossings and the rails connecting them.
Through route/ Stammgleis/ Voie directe	Appendix D	In the context of switches and crossings a route which perpetuate the general alignment of the track.
Track design	4.2.6, 6.2.5, Appendix C and D	The track design consists of cross-section defining basic dimensions and track components (for example rail, rail fastenings, sleepers, ballast) used together with operating conditions with an impact on forces related to 4.2.6., such as axle load, speed and radius of horizontal curvature.
Track gauge/ Spurweite/ Ecartement de la voie	4.2.4.1, 4.2.4.5, 4.2.8.4, 5.3.3, 6.1.5.2, 6.2.4.3, Appendix H	The smallest distance between lines perpendicular to the running surface intersecting each rail head profile in a range from 0 to 14 mm below the running surface.
Track twist/ Gleisverwindung/ Gauche	4.2.7.1.6 4.2.8.3, 6.2.4.9,	Track twist is defined as the algebraic difference between two cross levels taken at a defined distance apart, usually expressed as a gradient between the two points at which the cross level is measured.
Train length/ Zuglänge/ Longueur du train	4.2.1	The length of a train, which can run on a certain line in normal operation.
Unguided length of an obtuse crossing/ Führungslose Stelle/ Lacune dans la traversée	4.2.5.3, Appendix J	Portion of obtuse crossing where there is no guidance of the wheel described as 'unguided distance' in EN 13232-3:2003.
Usable length of a platform/ Bahnsteignutzlänge/ Longueur utile de quai	4.2.1, 4.2.9.1	The maximum continuous length of that part of platform in front of which a train is intended to remain stationary in normal operating conditions for passengers to board and alight from the train, making appropriate allowance for stopping tolerances. Normal operating conditions means that railway is operating in a non-degraded mode (e.g. rail adhesion is normal, signals are working, everything is working as planned).

Figure 14

Geometry of switches and crossings

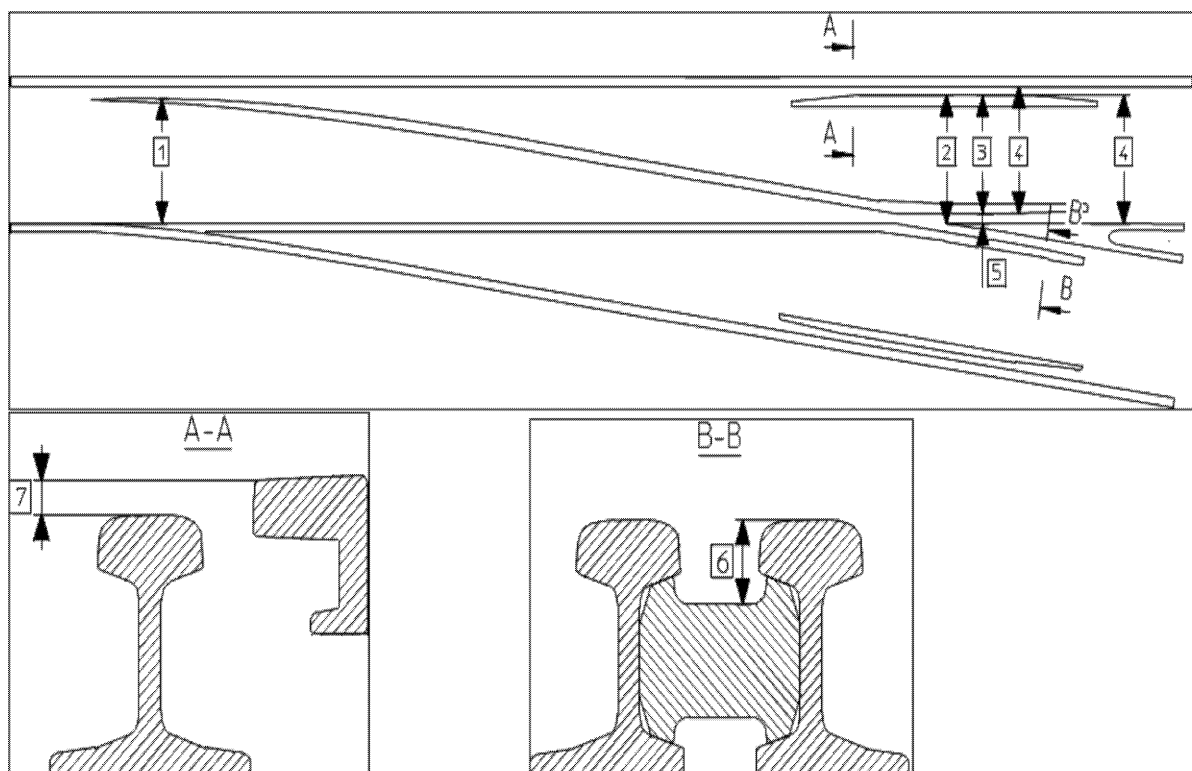

- (1) Free wheel passage in switches
- (2) Fixed nose protection
- (3) Free wheel passage at crossing nose
- (4) Free wheel passage at check rail/wing rail entry
- (5) Flangeway width
- (6) Flangeway depth
- (7) Height of check rail

Appendix T

List of referenced standards

Table 49

List of referenced standards

Index No.	Reference	Document name	Version (year)	BP(s) concerned
1	EN 13674-1	Railway applications — Track — Rail Part 1: Vignole railway rails 46 kg/m and above	2011	Railhead profile for plain line (4.2.4.6), Assessment of rails (6.1.5.1)
2	EN 13674-4	Railway applications — Track — Rail — Part 4: Vignole railway rails from 27 kg/m to, but excluding 46 kg/m (with Amendment A1:2009)	2006	Railhead profile for plain line (4.2.4.6)
3	EN 13715	Railway applications — Wheelsets and boogies — Wheels — Wheels tread (with Amendment A1:2010)	2006 A1:2010	Equivalent conicity (4.2.4.5)
4	EN 13848-1	Track geometry quality — Part 1: Characterisation of track geometry (with Amendment A1:2008)	2003	The immediate action limit for track twist (4.2.8.3), Assessment of minimum value of mean track gauge (6.2.4.5)
5	EN 13848-5	Railway applications — Track — Track geometry quality — Part 5: Geometric quality levels — Plain line (with Amendment A1:2010)	2008	The immediate action limit for alignment (4.2.8.1), The immediate action limit for longitudinal level (4.2.8.2), The immediate action limit for track twist (4.2.8.3)
6	EN 14067-5	Railway applications — Aerodynamics — Part 5: Requirements and test procedures for aerodynamics in tunnels (with Amendment A1:2010)	2006	Assessment of maximum pressure variations in tunnels (6.2.4.12)
7	EN 15273-3	Railway applications — Gauges — Part 3: Structure gauges	2013	Structure gauge (4.2.3.1), Distance between track centres (4.2.3.2), Platform offset (4.2.9.3), Assessment of structure gauge (6.2.4.1), Assessment of distance between track centres (6.2.4.2), Assessment of platform offset (6.2.4.11)
8	EN 15302	Railway applications — Method for specifying the equivalent conicity (with Amendment A1:2010)	2008	Equivalent conicity (4.2.4.5), Assessment of design values for equivalent conicity (6.2.4.6)
9	EN 15528	Railway applications — Line categories for managing the interface between load limits of vehicles and infrastructure (with Amendment A1:2012)	2008	Ascertain compatibility of infrastructure and rolling stock after authorisation of rolling stock (7.6), Capability requirements for structures according to traffic code (Appendix E), Basis of minimum requirements for structures for passenger coaches and multiple units (Appendix K), Definition of line category a12 for traffic code p6 (Appendix L)

Index No.	Reference	Document name	Version (year)	BP(s) concerned
10	EN 15663	Railway applications — Definition of vehicle reference masses (with Corrections AC:2010)	2009	TSI categories of line (4.2.1), Basis of minimum requirements for structures for passenger coaches and multiple units (Appendix K)
11	EN 1990	Eurocode — Basis of structural design (with Amendment A1:2005 and Correction AC:2010)	2002	Structures resistance to traffic loads (4.2.7), Resistance of new bridges to traffic loads (4.2.7.1)
12	EN 1991-2	Eurocode 1 — Actions on structures — Part 2: Traffic load on bridges (with Correction AC:2010)	2003	Structures resistance to traffic loads (4.2.7), Resistance of new bridges to traffic loads (4.2.7.1), Equivalent vertical loading for new earthworks and earth pressure effects (4.2.7.2), Resistance of new structures over or adjacent to tracks (4.2.7.3)
13	EN 14363:2005	Railway applications — Testing for the acceptance of running characteristics of railway vehicles — Testing of running behaviour and stationary tests	2005	Track resistance to vertical load (4.2.6.1), Lateral track resistance (4.2.6.3),