

Commission Regulation (EU) 2017/1151 of 1 June 2017 supplementing Regulation (EC) No 715/2007 of the European Parliament and of the Council on type-approval of motor vehicles with respect to emissions from light passenger and commercial vehicles (Euro 5 and Euro 6) and on access to vehicle repair and maintenance information, amending Directive 2007/46/EC of the European Parliament and of the Council, Commission Regulation (EC) No 692/2008 and Commission Regulation (EU) No 1230/2012 and repealing Commission Regulation (EC) No 692/2008 (Text with EEA relevance)

COMMISSION REGULATION (EU) 2017/1151

of 1 June 2017

supplementing Regulation (EC) No 715/2007 of the European Parliament and of the Council on type-approval of motor vehicles with respect to emissions from light passenger and commercial vehicles (Euro 5 and Euro 6) and on access to vehicle repair and maintenance information, amending Directive 2007/46/EC of the European Parliament and of the Council, Commission Regulation (EC) No 692/2008 and Commission Regulation (EU) No 1230/2012 and repealing Commission Regulation (EC) No 692/2008

(Text with EEA relevance)

THE EUROPEAN COMMISSION,

Having regard to the Treaty on the Functioning of the European Union,

Having regard to Regulation (EC) No 715/2007 of the European Parliament and of the Council of 20 June 2007 on type-approval of motor vehicles with respect to emissions from light passenger and commercial vehicles (Euro 5 and Euro 6) and on access to vehicle repair and maintenance information⁽¹⁾, and in particular Articles 8 and 14(3) thereof,

Having regard to Directive 2007/46/EC of the European Parliament and of the Council of 5 September 2007 establishing a framework for the approval of motor vehicles and their trailers, and of systems, components and separate technical units intended for such vehicles (Framework Directive)⁽²⁾, and in particular Article 39(2) thereof.

Whereas:

- (1) Commission Regulation (EC) No 692/2008 implementing and amending Regulation (EC) No 715/2007⁽³⁾ provides for light-duty vehicles to be tested in accordance with the New European Driving Cycle (NEDC).
- (2) Based on the continuous review of the relevant procedures, test cycles and test results provided for in Article 14(3) of Regulation (EC) No 715/2007, it is evident that the information about fuel consumption and CO₂ emissions provided by testing vehicles in accordance with the NEDC is no longer adequate and no longer reflects real world emissions.

Status: Point in time view as at 01/06/2017.

Changes to legislation: There are outstanding changes not yet made to Commission Regulation (EU) 2017/1151. Any changes that have already been made to the legislation appear in the content and are referenced with annotations. (See end of Document for details)

- (3) Against that background, it is appropriate to provide for a new regulatory test procedure by implementing the Worldwide harmonised Light-duty vehicles Test Procedures (WLTP) into Union legislation.
- (4) The WLTP was developed at the level of the United Nations Economic Commission for Europe (UNECE) and was adopted as Global Technical Regulation (GTR) No 15 by the World Forum for Harmonization of Vehicle Regulations (WP.29) in March 2014.
- (5) In addition to more realistic information about fuel consumption and CO₂ emissions for consumer and regulatory purposes, the WLTP also creates a global framework for vehicle testing, leading to a closer international harmonisation of test requirements.
- (6) The WLTP provides a full description of a vehicle test cycle for CO₂ and regulated pollutant emissions under standardised ambient conditions. In order to adapt it to the EU type-approval system, it is necessary to complement it by further improving the transparency requirements for technical parameters that will allow independent parties to reproduce the type approval test results and by reducing testing flexibilities.
- (7) This proposal also specifies a revised procedure for the conformity of production (CoP) assessment of vehicles. Since under the new provisions the CoP evolution coefficient as described in point 4.2.4.1 of Annex I is likely to be determined more often by specific testing of the manufacturer instead of using a default value, the respective test procedure will need to be revised in due course.
- (8) While the WLTP specifies a new test cycle and procedure for measuring emissions, other obligations, such as those linked to durability of pollution control devices, in-service conformity or consumer information on CO₂ emissions and fuel consumption, remain essentially the same as those laid down in Regulation (EC) No 692/2008.
- (9) In order to allow approval authorities and manufacturers to put in place the necessary procedures to comply with the requirements of this Regulation, as well as to follow as much as possible the established calendar for the application of emissions requirements, it should apply to new type-approvals from 1 September 2017 in the case of categories M1, M2 and category N1 class I vehicles and from 1 September 2018 in the case of N1 vehicles of class II and III and category N2 vehicles, and to new vehicles from 1 September 2018 in the case of categories M1, M2 and category N1 class I vehicles, and from 1 September 2019 in the case of N1 vehicles of class II and III and category N2 vehicles.
- (10) As the purpose of this Regulation is the introduction of the WLTP into European legislation, the timetable and the transitional provisions for introducing the real driving emissions test procedure remain unchanged with respect to those lined out previously in Commission Regulations (EU) 2016/427⁽⁴⁾ and (EU) 2016/646⁽⁵⁾.
- (11) The measures provided for in this Regulation are in accordance with the opinion of the Technical Committee – Motor Vehicles,

HAS ADOPTED THIS REGULATION:

Article 1

Subject matter

This Regulation lays down measures for the implementation of Regulation (EC) No 715/2007.

Article 2

Definitions

For the purposes of this Regulation, the following definitions shall apply:

- (1) ‘vehicle type with regard to emissions and vehicle repair and maintenance information’ means a group of vehicles which:
 - (a) do not differ with respect to the criteria constituting an "interpolation family" as defined in point 5.6 of Annex XXI;
 - (b) fall in a single "CO₂ interpolation range" as defined in point 1.2.3.2 of sub-Annex 6 to Annex XXI;
 - (c) do not differ with respect to any characteristics that have a non-negligible influence on tailpipe emissions, such as, but not limited to, the following:
 - types and sequence of pollution control devices (e.g. three-way catalyst, oxidation catalyst, lean NO_x trap, SCR, lean NO_x catalyst, particulate trap or combinations thereof in a single unit);
 - exhaust gas recirculation (with or without, internal/external, cooled/non-cooled, low/high pressure).
- (2) ‘EC type-approval of a vehicle with regard to emissions and vehicle repair and maintenance information’ means an EC type-approval of the vehicles contained in a ‘vehicle type with regard to emissions and vehicle repair and maintenance information’ with regard to their tailpipe emissions, crankcase emissions, evaporative emissions, fuel consumption and access to vehicle OBD and vehicle repair and maintenance information;
- (3) ‘odometer’ means that part of the odometer equipment which indicates to the driver the total distance recorded by the vehicle since its entry into service;
- (4) ‘starting aid’ means glow plugs, modifications to the injection timing and other devices which assist the engine to start without enrichment of the air/fuel mixture of the engine;
- (5) ‘engine capacity’ means either of the following:
 - (a) for reciprocating piston engines, the nominal engine swept volume;
 - (b) for rotary piston (Wankel) engines, double the nominal engine swept volume;
- (6) ‘periodically regenerating system’ means an exhaust emissions control device (e.g. catalytic converter, particulate trap) that requires a periodical regeneration process in less than 4 000 km of normal vehicle operation;

Status: Point in time view as at 01/06/2017.

Changes to legislation: There are outstanding changes not yet made to Commission Regulation (EU) 2017/1151. Any changes that have already been made to the legislation appear in the content and are referenced with annotations. (See end of Document for details)

- (7) ‘original replacement pollution control device’ means a pollution control device or an assembly of pollution control devices whose types are indicated in Appendix 4 to Annex I to this Regulation but are offered on the market as separate technical units by the holder of the vehicle type-approval;
- (8) ‘type of pollution control device’ means catalytic converters and particulate filters which do not differ in any of the following essential aspects:
- (a) number of substrates, structure and material;
 - (b) type of activity of each substrate;
 - (c) volume, ratio of frontal area and substrate length;
 - (d) catalyst material content;
 - (e) catalyst material ratio;
 - (f) cell density;
 - (g) dimensions and shape;
 - (h) thermal protection;
- (9) ‘mono fuel vehicle’ means a vehicle that is designed to run primarily on one type of fuel;
- (10) ‘mono fuel gas vehicle’ means a mono fuel vehicle that primarily runs on LPG, NG/ biomethane, or hydrogen but may also have a petrol system for emergency purposes or starting only, where the petrol tank does not contain more than 15 litres of petrol;
- (11) ‘bi fuel vehicle’ means a vehicle with two separate fuel storage systems that can run part-time on two different fuels and is designed to run on only one fuel at a time;
- (12) ‘bi fuel gas vehicle’ means a bi fuel vehicle that can run on petrol and also on either LPG, NG/biomethane or hydrogen;
- (13) ‘flex fuel vehicle’ means a vehicle with one fuel storage system that can run on different mixtures of two or more fuels;
- (14) ‘flex fuel ethanol vehicle’ means a flex fuel vehicle that can run on petrol or a mixture of petrol and ethanol up to an 85 per cent ethanol blend (E85);
- (15) ‘flex fuel biodiesel vehicle’ means a flex fuel vehicle that can run on mineral diesel or a mixture of mineral diesel and biodiesel;
- (16) ‘hybrid electric vehicle’ (HEV) means a hybrid vehicle where one of the propulsion energy converters is an electric machine;
- (17) ‘properly maintained and used’ means, for the purpose of a test vehicle, that such a vehicle satisfies the criteria for acceptance of a selected vehicle laid down in section 2 of Appendix 3 to UN/ECE Regulation No 83⁽⁶⁾;
- (18) ‘emission control system’ means, in the context of the OBD system, the electronic engine management controller and any emission-related component in the exhaust or evaporative system which supplies an input to or receives an output from this controller;

Status: Point in time view as at 01/06/2017.

Changes to legislation: There are outstanding changes not yet made to Commission Regulation (EU) 2017/1151. Any changes that have already been made to the legislation appear in the content and are referenced with annotations. (See end of Document for details)

- (19) ‘malfunction indicator’ (MI) means a visible or audible indicator that clearly informs the driver of the vehicle in the event of a malfunction of any emission-related component connected to the OBD system, or of the OBD system itself;
- (20) ‘malfunction’ means the failure of an emission-related component or system that would result in emissions exceeding the limits in section 2.3 of Annex XI or if the OBD system is unable to fulfil the basic monitoring requirements set out in Annex XI;
- (21) ‘secondary air’ means the air introduced into the exhaust system by means of a pump or aspirator valve or other means that is intended to aid in the oxidation of HC and CO contained in the exhaust gas stream;
- (22) ‘driving cycle’, means, in respect of vehicle OBD systems, the engine start-up, driving mode where a malfunction would be detected if present, and engine shut-off;
- (23) ‘access to information’ means the availability of all vehicle OBD and vehicle repair and maintenance information, required for the inspection, diagnosis, servicing or repair of the vehicle.
- (24) ‘deficiency’ means, in the context of the OBD system, that up to two separate components or systems which are monitored contain temporary or permanent operating characteristics that impair the otherwise efficient OBD monitoring of those components or systems or do not meet all of the other detailed requirements for OBD;
- (25) ‘deteriorated replacement pollution control device’ means a pollution control device as defined in Article 3(11) of Regulation (EC) No 715/2007 that has been aged or artificially deteriorated to such an extent that it fulfils the requirements laid out in section 1 to Appendix 1 to Annex XI of UN/ECE Regulation No 83;
- (26) ‘vehicle OBD information’ means information relating to an on-board diagnostic system for any electronic system on the vehicle
- (27) ‘reagent’ means any product other than fuel that is stored on-board the vehicle and is provided to the exhaust after-treatment system upon request of the emission control system;
- (28) ‘mass in running order’ means the mass of the vehicle, with its fuel tank(s) filled to at least 90 per cent of its or their capacity/capacities, including the mass of the driver, fuel and liquids, fitted with the standard equipment in accordance with the manufacturer's specifications and, when they are fitted, the mass of the bodywork, the cabin, the coupling and the spare wheel(s) as well as the tools;
- (29) ‘engine misfire’ means lack of combustion in the cylinder of a positive ignition engine due to absence of spark, poor fuel metering, poor compression or any other cause;
- (30) ‘cold start system or device’ means a system which temporarily enriches the air/fuel mixture of the engine thus assisting the engine to start;
- (31) ‘power take-off operation or unit’ means an engine-driven output provision for the purposes of powering auxiliary, vehicle mounted, equipment;
- (32) ‘small volume manufacturers’ means vehicle manufacturers whose worldwide annual production is less than 10 000 units;
- (33) ‘Electric power train’ means a system consisting of one or more electric energy storage devices, one or more electric power conditioning devices and one or more electric

Status: Point in time view as at 01/06/2017.

Changes to legislation: There are outstanding changes not yet made to Commission Regulation (EU) 2017/1151. Any changes that have already been made to the legislation appear in the content and are referenced with annotations. (See end of Document for details)

- machines that convert stored electric energy to mechanical energy delivered at the wheels for propulsion of the vehicle;
- (34) ‘Pure electric vehicle’ (PEV) means a vehicle equipped with a powertrain containing exclusively electric machines as propulsion energy converters and exclusively rechargeable electric energy storage systems as propulsion energy storage systems.
- (35) ‘Fuel cell’ means an energy converter transforming chemical energy (input) into electrical energy (output) or vice versa.
- (36) ‘Fuel cell vehicle’ (FCV) means a vehicle equipped with a powertrain containing exclusively fuel cell(s) and electric machine(s) as propulsion energy converter(s).
- (37) ‘net power’ means the power obtained on a test bench at the end of the crankshaft or its equivalent at the corresponding engine or motor speed with the auxiliaries, tested in accordance with Annex XX (Measurements of net power and the maximum 30 minutes power of electric drive train), and determined under reference atmospheric conditions;
- (38) ‘rated engine power (P_{rated})’ means maximum engine power in kW as per the requirements of Annex XX to this Regulation;
- (39) ‘maximum 30 minutes power’ means the maximum net power of an electric drive train at DC voltage as set out in paragraph 5.3.2. of UN/ECE Regulation No 85⁽⁷⁾;
- (40) ‘cold start’ means, in the context of the in use performance ratio of OBD monitors, an engine coolant temperature or equivalent temperature at engine start less than or equal to 35 °C and less than or equal to 7 °C higher than ambient temperature, if available;
- (41) ‘Real driving emissions (RDE)’ means the emissions of a vehicle under its normal conditions of use;
- (42) ‘Portable emissions measurement system’ (PEMS) means a portable emissions measurement system meeting the requirements specified in Appendix 1 to Annex IIIA;
- (43) ‘Base Emission Strategy’, (‘BES’) means an emission strategy that is active throughout the speed and load operating range of the vehicle unless an Auxiliary Emission Strategy is activated;
- (44) ‘Auxiliary Emission Strategy’, (‘AES’) means an emission strategy that becomes active and replaces or modifies a BES for a specific purpose and in response to a specific set of ambient or operating conditions and only remains operational as long as those conditions exist.
- (45) ‘Fuel Storage System’ means devices which allow storing the fuel, comprising of the fuel tank, the fuel filler, the filler cap and the fuel pump;
- (46) ‘Permeability Factor (PF)’ means the hydrocarbon emissions as reflected in the permeability of the fuel storage system;
- (47) ‘Monolayer tank’ means a fuel tank constructed with a single layer of material;
- (48) ‘Multilayer tank’ means a fuel tank constructed with at least two different layered materials, one of which is impermeable to hydrocarbons, including ethanol;

Status: Point in time view as at 01/06/2017.

Changes to legislation: There are outstanding changes not yet made to Commission Regulation (EU) 2017/1151. Any changes that have already been made to the legislation appear in the content and are referenced with annotations. (See end of Document for details)

Article 3

Requirements for type-approval

1 In order to receive an EC type-approval with regard to emissions and vehicle repair and maintenance information, the manufacturer shall demonstrate that the vehicles comply with the requirements of this Regulation when tested in accordance with the test procedures specified in Annexes IIIA to VIII, XI, XIV, XVI, XX and XXI. The manufacturer shall also ensure that the reference fuels comply with the specifications set out in Annex IX.

2 Vehicles shall be subject to the tests specified in Figure I.2.4 of Annex I.

3 As an alternative to the requirements contained in Annexes II, V to VIII, XI, XVI and XXI, small volume manufacturers may request the granting of EC type-approval to a vehicle type which was approved by an authority of a third country on the basis of the legislative acts listed in section 2.1 of Annex I.

The emissions tests for roadworthiness purposes set out in Annex IV, tests for fuel consumption and CO₂ emissions set out in Annex XXI and the requirements for access to vehicle OBD and vehicle repair and maintenance information set out in Annex XIV shall be required to obtain EC type-approval with regard to emissions and vehicle repair and maintenance information under this paragraph.

The approval authority shall inform the Commission of the circumstances of each type approval granted under this paragraph.

4 Specific requirements for inlets to fuel tanks and electronic system security are laid down in Section 2.2 and 2.3 of Annex I.

5 The manufacturer shall take technical measures so as to ensure that the tailpipe and evaporative emissions are effectively limited, in accordance with this Regulation, throughout the normal life of the vehicle and under normal conditions of use.

These measures shall include ensuring that the security of hoses, joints and connections, used within the emission control systems, are constructed so as to conform with the original design intent.

6 The manufacturer shall ensure that the emissions test results comply with the applicable limit value under the specified test conditions of this Regulation.

7 For the Type 1 test set out in Annex XXI, vehicles that are fuelled with LPG or NG/biomethane shall be tested in the Type 1 test for variation in the composition of LPG or NG/biomethane, as set out in Annex XII. Vehicles that can be fuelled either with petrol or LPG or NG/biomethane shall be tested on both the fuels, tests on LPG or NG/biomethane being performed for variation in the composition of LPG or NG/biomethane, as set out in Annex XII.

Notwithstanding the requirement of the previous sub-paragraph, vehicles that can be fuelled with either petrol or a gaseous fuel, but where the petrol system is fitted for emergency purposes or starting only and which the petrol tank cannot contain more than 15 litres of petrol will be regarded for the Type 1 test as vehicles that can only run on a gaseous fuel.

8 For the Type 2 test set out in Appendix 1 to Annex IV, at normal engine idling speed, the maximum permissible carbon monoxide content in the exhaust gases shall be that stated by

Status: Point in time view as at 01/06/2017.

Changes to legislation: There are outstanding changes not yet made to Commission Regulation (EU) 2017/1151. Any changes that have already been made to the legislation appear in the content and are referenced with annotations. (See end of Document for details)

the vehicle manufacturer. However, the maximum carbon monoxide content shall not exceed 0,3 % vol.

At high engine idling speed, the carbon monoxide content by volume of the exhaust gases shall not exceed 0,2 %, with the engine speed being at least 2 000 min⁻¹ and Lambda being $1 \pm 0,03$ or in accordance with the specifications of the manufacturer.

9 The manufacturer shall ensure that for the Type 3 test set out in Annex V, the engine's ventilation system does not permit the emission of any crankcase gases into the atmosphere.

10 The Type 6 test measuring emissions at low temperatures set out in Annex VIII shall not apply to diesel vehicles.

However, when applying for type-approval, manufacturers shall present to the approval authority with information showing that the NO_x after-treatment device reaches a sufficiently high temperature for efficient operation within 400 seconds after a cold start at - 7 °C as described in the Type 6 test.

In addition, the manufacturer shall provide the approval authority with information on the operating strategy of the exhaust gas recirculation system (EGR), including its functioning at low temperatures.

This information shall also include a description of any effects on emissions.

The approval authority shall not grant type-approval if the information provided is insufficient to demonstrate that the after-treatment device actually reaches a sufficiently high temperature for efficient operation within the designated period of time.

At the request of the Commission, the approval authority shall provide information on the performance of NO_x after-treatment devices and EGR system at low temperatures.

11 The manufacturer shall ensure that, throughout the normal life of a vehicle which is type approved in accordance with Regulation (EC) No 715/2007, its emissions as determined in accordance with the requirements set out in Annex IIIA and emitted at an RDE test performed in accordance with that Annex, shall not exceed the values set out therein.

Type approval in accordance with Regulation (EC) No 715/2007 may only be issued if the vehicle is part of a validated PEMS test family according to Appendix 7 of Annex IIIA.

Article 4

Requirements for type-approval regarding the OBD system

1 The manufacturer shall ensure that all vehicles are equipped with an OBD system.

2 The OBD system shall be designed, constructed and installed on a vehicle so as to enable it to identify types of deterioration or malfunction over the entire life of the vehicle.

3 The OBD system shall comply with the requirements of this Regulation during normal conditions of use.

4 When tested with a defective component in accordance with Appendix 1 of Annex XI, the OBD system malfunction indicator shall be activated.

The OBD system malfunction indicator may also activate during this test at levels of emissions below the OBD thresholds limits specified in section 2.3 of Annex XI.

Status: Point in time view as at 01/06/2017.

Changes to legislation: There are outstanding changes not yet made to Commission Regulation (EU) 2017/1151. Any changes that have already been made to the legislation appear in the content and are referenced with annotations. (See end of Document for details)

5 The manufacturer shall ensure that the OBD system complies with the requirements for in-use performance set out in section 3 of Appendix 1 to Annex XI of this Regulation under all reasonably foreseeable driving conditions.

6 In-use performance related data to be stored and reported by a vehicle's OBD system according to the provisions of Section 7.6 of Appendix 1 to Annex XI of UN/ECE Regulation No 83 shall be made readily available by the manufacturer to national authorities and independent operators without any encryption.

Article 5

Application for EC type-approval of a vehicle with regard to emissions and access to vehicle repair and maintenance information

1 The manufacturer shall submit to the approval authority an application for EC type-approval of a vehicle with regard to emissions and access to vehicle repair and maintenance information.

2 The application referred to in paragraph 1 shall be drawn up in accordance with the model of the information document set out in Appendix 3 to Annex I.

3 In addition, the manufacturer shall submit the following information:

- a in the case of vehicles equipped with positive-ignition engines, a declaration by the manufacturer of the minimum percentage of misfires out of a total number of firing events that either would result in emissions exceeding the limits given in section 2.3 of Annex XI if that percentage of misfire had been present from the start of a type 1 test as chosen for the demonstration according to Annex XI to this Regulation or could lead to an exhaust catalyst, or catalysts, overheating prior to causing irreversible damage;
- b detailed written information fully describing the functional operation characteristics of the OBD system, including a listing of all relevant parts of the emission control system of the vehicle that are monitored by the OBD system;
- c a description of the malfunction indicator used by the OBD system to signal the presence of a fault to a driver of the vehicle;
- d a declaration by the manufacturer that the OBD system complies with the provisions of section 3 of Appendix 1 to Annex XI relating to in-use performance under all reasonably foreseeable driving conditions;
- e a plan describing the detailed technical criteria and justification for incrementing the numerator and denominator of each monitor that must fulfil the requirements of paragraphs 7.2 and 7.3. of Appendix 1 to Annex XI of UN/ECE Regulation No 83, as well as for disabling numerators, denominators and the general denominator under the conditions outlined in paragraph 7.7 of Appendix 1 to Annex XI of UN/ECE Regulation No 83;
- f a description of the provisions taken to prevent tampering with and modification of the emission control computer, odometer including the recording of mileage values for the purposes of the requirements of Annexes XI and XVI;
- g if applicable, the particulars of the vehicle family as referred to in Appendix 2 to Annex 11 to UN/ECE Regulation No 83;
- h where appropriate, copies of other type-approvals with the relevant data to enable extension of approvals and establishment of deterioration factors.

Status: Point in time view as at 01/06/2017.

Changes to legislation: There are outstanding changes not yet made to Commission Regulation (EU) 2017/1151. Any changes that have already been made to the legislation appear in the content and are referenced with annotations. (See end of Document for details)

4 For the purposes of point (d) of paragraph 3, the manufacturer shall use the model of manufacturer's certificate of compliance with the OBD in-use performance requirements set out in Appendix 7 of Annex I

5 For the purposes of point (e) of paragraph 3, the approval authority that grants the approval shall make the information referred to in that point available to the approval authorities or the Commission upon request.

6 For the purposes of points (d) and (e) of paragraph 3, approval authorities shall not approve a vehicle if the information submitted by the manufacturer is inappropriate for fulfilling the requirements of section 3 of Appendix 1 to Annex XI.

Paragraphs 7.2, 7.3 and 7.7 of Appendix 1 to Annex XI of UN/ECE Regulation No 83 shall apply under all reasonably foreseeable driving conditions.

For the assessment of the implementation of the requirements set out in these paragraphs, the approval authorities shall take into account the state of technology.

7 For the purposes of point (f) of paragraph 3, the provisions taken to prevent tampering with and modification of the emission control computer shall include the facility for updating using a manufacturer-approved programme or calibration.

8 For the tests specified in Figure I.2.4 of Annex I the manufacturer shall submit to the technical service responsible for the type-approval tests a vehicle representative of the type to be approved.

9 The application for type-approval of mono fuel, bi-fuel and flex-fuel vehicles shall comply with the additional requirements laid down in Sections 1.1 and 1.2 of Annex I.

10 Changes to the make of a system, component or separate technical unit that occur after a type-approval shall not automatically invalidate a type approval, unless its original characteristics or technical parameters are changed in such a way that the functionality of the engine or pollution control system is affected.

11 The manufacturer shall also provide an extended documentation package with the following information:

- a information on the operation of all AES and BES, including a description of the parameters that are modified by any AES and the boundary conditions under which the AES operate, and indication of the AES or BES which are likely to be active under the conditions of the test procedures set out in this Regulation;
- b a description of the fuel system control logic, timing strategies and switch points during all modes of operation.
- c a description of the coastdown mode, if any, as referred to in paragraph 4.2.1.8.5. of Sub-Annex 4 to Annex XXI, and a description of the vehicle's dynamometer operation mode, if any, as referred to in paragraph 1.2.4. of Sub-Annex 6 to Annex XXI.

12 The extended documentation package referred to in paragraph 11 (a) and (b) shall remain strictly confidential. It may be kept by the approval authority, or, at the discretion of the approval authority, may be retained by the manufacturer. In the case the manufacturer retains the documentation package, that package shall be identified and dated by the approval authority once reviewed and approved. It shall be made available for inspection by the approval authority at the time of approval or at any time during the validity of the approval.

Status: Point in time view as at 01/06/2017.

Changes to legislation: There are outstanding changes not yet made to Commission Regulation (EU) 2017/1151. Any changes that have already been made to the legislation appear in the content and are referenced with annotations. (See end of Document for details)

Article 6

Administrative provisions for EC type-approval of a vehicle with regard to emissions and access to vehicle repair and maintenance information

1 If all the relevant requirements are met, the approval authority shall grant an EC type-approval and issue a type-approval number in accordance with the numbering system set out in Annex VII to Directive 2007/46/EC.

Without prejudice to the provisions of Annex VII to Directive 2007/46/EC, Section 3 of the type-approval number shall be drawn up in accordance with Appendix 6 to Annex I to this Regulation.

An approval authority shall not assign the same number to another vehicle type.

2 By way of derogation from paragraph 1, at the request of the manufacturer, a vehicle with an OBD system may be accepted for type-approval with regard to emissions and vehicle repair and maintenance information, even though the system contains one or more deficiencies such that the specific requirements of Annex XI are not fully met, provided that the specific administrative provisions set out in Section 3 of that Annex are complied with.

The approval authority shall notify the decision to grant such a type approval to all approval authorities in the other Member States in accordance with the requirements set out in Article 8 of Directive 2007/46/EC.

3 When granting an EC type approval under paragraph 1, the approval authority shall issue an EC type-approval certificate using the model set out in Appendix 4 to Annex I.

Article 7

Amendments to type-approvals

Articles 13, 14 and 16 of Directive 2007/46/EC shall apply to any amendments to the type-approvals granted in accordance to Regulation (EC) No 715/2007.

At the manufacturer's request the provisions specified in Section 3 of Annex I shall apply without the need for additional testing only to vehicles of the same type.

Article 8

Conformity of production

1 Measures to ensure the conformity of production shall be taken in accordance with the provisions of Article 12 of Directive 2007/46/EC.

In addition, the provisions laid down in Section 4 of Annex I to this Regulation and the relevant statistical method in Appendices 1 and 2 to that Annex shall apply.

2 Conformity of production shall be checked on the basis of the description in the type-approval certificate set out in Appendix 4 to Annex I to this Regulation.

Status: Point in time view as at 01/06/2017.

Changes to legislation: There are outstanding changes not yet made to Commission Regulation (EU) 2017/1151. Any changes that have already been made to the legislation appear in the content and are referenced with annotations. (See end of Document for details)

Article 9

In service conformity

1 Measures to ensure in-service conformity of vehicles type-approved under this Regulation shall be taken in accordance with Annex X to Directive 2007/46/EC and Annex II to this Regulation.

2 The in-service conformity measures shall be appropriate for confirming the functionality of the pollution control devices during the normal life of the vehicles under normal conditions of use as specified in Annex II to this Regulation.

3 The in-service conformity measures shall be checked for a period of up to 5 years of age or 100 000 km, whichever is the sooner.

4 The manufacturer shall not be obliged to carry out an audit of in-service conformity if the number of vehicles sold precludes obtaining sufficient samples to test. Therefore, an audit shall not be required if the annual sales of that vehicle type are less than 5 000 across the Union.

However, the manufacturer of such small series vehicles shall provide the approval authority with a report of any emissions related warranty and repair claims and OBD faults as set out in paragraph 9.2.3 of UN/ECE Regulation No 83. In addition, the type-approval authority may require such vehicle types to be tested in accordance with Appendix 3 to UN/ECE Regulation No 83.

5 With regard to vehicles type-approved under this Regulation, where the approval authority is not satisfied with the results of the tests in accordance with the criteria defined in Appendix 4 to UN/ECE Regulation No 83, the remedial measures referred to in Article 30(1) and in Annex X to Directive 2007/46/EC shall be extended to vehicles in service belonging to the same vehicle type which are likely to be affected with the same defects in accordance with section 6 of Appendix 3 to UN/ECE Regulation No 83.

The plan of remedial measures presented by the manufacturer according to section 6.1 of Appendix 3 to UN/ECE Regulation No 83 shall be approved by the approval authority. The manufacturer shall be responsible for the execution of the approved remedial plan.

The approval authority shall notify its decision to all Member States within 30 days. Member States may require that the same plan of remedial measures be applied to all vehicles of the same type registered in their territory.

6 If an approval authority has established that a vehicle type does not conform to the applicable requirements of Appendix 3 to UN/ECE Regulation No 83, it shall notify without delay the Member State which granted the original type-approval in accordance with the requirements of Article 30(3) of Directive 2007/46/EC.

Following that notification and subject to the provision of Article 30(6) of Directive 2007/46/EC, the approval authority which granted the original type-approval shall inform the manufacturer that a vehicle type fails to satisfy the requirements of these provisions and that certain measures are expected of the manufacturer. The manufacturer shall submit to that authority, within two months after this notification, a plan of measures to overcome the defects, the substance of which should correspond to the requirements of sections 6.1 to 6.8 of Appendix 3 to UN/ECE Regulation No 83. The approval authority which granted the original type-approval shall, within two months, consult the manufacturer in order to secure agreement on a plan of measures and on the

Status: Point in time view as at 01/06/2017.

Changes to legislation: There are outstanding changes not yet made to Commission Regulation (EU) 2017/1151. Any changes that have already been made to the legislation appear in the content and are referenced with annotations. (See end of Document for details)

carrying out the plan. If the approval authority which granted the original type-approval establishes that no agreement can be reached, the procedure pursuant to Article 30(3) and (4) of Directive 2007/46/EC shall be initiated.

Article 10

Pollution control devices

1 The manufacturer shall ensure that replacement pollution control devices intended to be fitted to EC type-approved vehicles covered by the scope of Regulation (EC) No 715/2007 are EC type-approved, as separate technical units within the meaning of Article 10(2) of Directive 2007/46/EC, in accordance with Article 12, Article 13 and Annex XIII to this Regulation.

Catalytic converters and particulate filters shall be considered to be pollution control devices for the purposes of this Regulation.

The relevant requirements shall be deemed to be met if all the following conditions are fulfilled:

- a the requirements of Article 13 are met;
- b the replacement pollution control devices have been approved according to UN/ECE Regulation No 103⁽⁸⁾.

In the case referred to in the third subparagraph Article 14 shall also apply.

2 Original equipment replacement pollution control devices, which fall within the type covered by point 2.3 of the Addendum to Appendix 4 to Annex I and are intended for fitment to a vehicle to which the relevant type-approval document refers, do not need to comply with Annex XIII provided they fulfil the requirements of points 2.1 and 2.2 of that Annex.

3 The manufacturer shall ensure that the original pollution control device carries identification markings.

4 The identification markings referred to in paragraph 3 shall comprise the following:

- a the vehicle or engine manufacturer's name or trade mark;
- b the make and identifying part number of the original pollution control device as recorded in the information referred to in point 3.2.12.2 of Appendix 3 to Annex I.

Article 11

Application for EC type-approval of a type of replacement pollution control device as a separate technical unit

1 The manufacturer shall submit to the approval authority an application for EC type-approval of a type of replacement pollution control device as a separate technical unit.

The application shall be drawn up in accordance with the model of the information document set out in Appendix 1 to Annex XIII.

2 In addition to the requirements laid down in paragraph 1, the manufacturer shall submit to the technical service responsible for the type-approval test all of the following:

- a a vehicle or vehicles of a type approved in accordance with this Regulation equipped with a new original equipment pollution control device;
- b one sample of the type of the replacement pollution control device;

Status: Point in time view as at 01/06/2017.

Changes to legislation: There are outstanding changes not yet made to Commission Regulation (EU) 2017/1151. Any changes that have already been made to the legislation appear in the content and are referenced with annotations. (See end of Document for details)

- c an additional sample of the type of the replacement pollution control device, in the case of a replacement pollution control device intended to be fitted to a vehicle equipped with an OBD system.

3 For the purposes of point (a) of paragraph 2, the test vehicles shall be selected by the applicant with the agreement of the technical service.

The test vehicles shall comply with the requirements set out in Section 3.2 of Annex 4a to UN/ECE Regulation No 83.

The test vehicles shall respect all of the following requirements:

- a they shall have no emission control system defects;
- b any excessively worn out or malfunctioning emission-related original part shall be repaired or replaced;
- c they shall be tuned properly and set to manufacturer's specification prior to emission testing.

4 For the purposes of points (b) and (c) of paragraph 2, the sample shall be clearly and indelibly marked with the applicant's trade name or mark and its commercial designation.

5 For the purposes of point (c) of paragraph 2, the sample shall have been deteriorated as defined under point (25) of Article 2.

Article 12

Administrative provisions for EC type-approval of replacement pollution control device as separate technical unit

1 If all the relevant requirements are met, the type approval authority shall grant an EC type-approval for replacement pollution control devices as separate technical unit and issue a type-approval number in accordance with the numbering system set out in Annex VII to Directive 2007/46/EC.

The approval authority shall not assign the same number to another replacement pollution control device type.

The same type-approval number may cover the use of that replacement pollution control device type on a number of different vehicle types.

2 For the purposes of paragraph 1, the approval authority shall issue an EC type-approval certificate established in accordance with the model set out in Appendix 2 to Annex XIII.

3 If the applicant for type-approval is able to demonstrate to the approval authority or technical service that the replacement pollution control device is of a type indicated in section 2.3 of the Addendum to Appendix 4 to Annex I, the granting of a type-approval shall not be dependent on verification of compliance with the requirements specified in section 4 of Annex XIII.

Article 13

Access to vehicle OBD and vehicle repair and maintenance information

1 Manufacturers shall put in place the necessary arrangements and procedures, in accordance with Articles 6 and 7 of Regulation (EC) No 715/2007 and Annex XIV of this

regulation, to ensure that vehicle OBD and vehicle repair and maintenance information is readily accessible.

2 Approval authorities shall only grant type-approval after receiving from the manufacturer a Certificate on Access to Vehicle OBD and Vehicle Repair and Maintenance Information.

3 The Certificate on Access to Vehicle OBD and Vehicle Repair and Maintenance Information shall serve as the proof of compliance with Article 6(7) of Regulation (EC) No 715/2007.

4 The Certificate on Access to Vehicle OBD and Vehicle Repair and Maintenance Information shall be drawn up in accordance with the model set out in Appendix 1 of Annex XIV.

5 If the vehicle OBD and vehicle repair and maintenance information is not available, or does not conform to Article 6 and 7 of Regulation (EC) No 715/2007 and Annex XIV of this Regulation, when the application for type-approval is made, the manufacturer shall provide that information within six months of the date of type approval.

6 The obligations to provide information within the period specified in paragraph 5 shall apply only if, following type-approval, the vehicle is placed on the market.

When the vehicle is placed on the market more than six months after type-approval, the information shall be provided on the date on which the vehicle is placed on the market.

7 The approval authority may presume that the manufacturer has put in place satisfactory arrangements and procedures with regard to access to vehicle OBD and vehicle repair and maintenance information, on the basis of a completed Certificate on Access to Vehicle OBD and Vehicle Repair and Maintenance Information, providing that no complaint was made, and that the manufacturer provides this information within the period set out in paragraph 5.

8 In addition to the requirements for the access to OBD information that are specified in Section 4 of Annex XI, the manufacturer shall make available to interested parties the following information:

- a relevant information to enable the development of replacement components which are critical to the correct functioning of the OBD system;
- b information to enable the development of generic diagnostic tools.

For the purposes of point (a), the development of replacement components shall not be restricted by: the unavailability of pertinent information, the technical requirements relating to malfunction indication strategies if the OBD thresholds are exceeded or if the OBD system is unable to fulfil the basic OBD monitoring requirements of this Regulation; specific modifications to the handling of OBD information to deal independently with vehicle operation on petrol or on gas; and the type-approval of gas-fuelled vehicles that contain a limited number of minor deficiencies.

For the purposes of point (b), where manufacturers use diagnostic and test tools in accordance with ISO 22900 Modular Vehicle Communication Interface (MVICI) and ISO 22901 Open Diagnostic Data Exchange (ODX) in their franchised networks, the ODX files shall be accessible to independent operators via the web site of the manufacturer.

9 The Forum on Access to Vehicle Information (the Forum).

Status: Point in time view as at 01/06/2017.

Changes to legislation: There are outstanding changes not yet made to Commission Regulation (EU) 2017/1151. Any changes that have already been made to the legislation appear in the content and are referenced with annotations. (See end of Document for details)

The Forum shall consider whether access to information affects the advances made in reducing vehicle theft and shall make recommendations for improving the requirements relating to access to information. In particular, the Forum shall advise the Commission on the introduction of a process for approving and authorising independent operators by accredited organisations to access information on vehicle security.

The Commission may decide to keep the discussions and findings of the Forum confidential.

Article 14

Compliance with the obligations regarding access to vehicle OBD and vehicle repair and maintenance information

1 An approval authority may, at any time, whether on its own initiative, on the basis of a complaint, or on the basis of an assessment by a technical service, check the compliance of a manufacturer with the provisions of Regulation (EC) No 715/2007, this Regulation, and the terms of the Certificate on Access to Vehicle OBD and Vehicle Repair and Maintenance Information.

2 Where an approval authority finds that the manufacturer has failed to comply with its obligations regarding access to vehicle OBD and vehicle repair and maintenance information, the approval authority which granted the relevant type approval shall take appropriate steps to remedy the situation.

3 The steps referred to in paragraph 2 may include withdrawal or suspension of type-approval, fines, or other measures adopted in accordance with Article 13 of Regulation (EC) No 715/2007.

4 The approval authority shall proceed to an audit in order to verify compliance by the manufacturer with the obligations concerning access to vehicle OBD and vehicle repair and maintenance information, if an independent operator or a trade association representing independent operators files a complaint to the approval authority.

5 When carrying out the audit, the approval authority may ask a technical service or any other independent expert to carry out an assessment to verify whether these obligations are met.

Article 15

Transitional provisions

1 Until 31 August 2017 in the case of categories M1, M2 and category N1 class I vehicles, and until 31 August 2018 in the case of N1 vehicles of class II and III and category N2 vehicles manufacturers may request type-approval to be granted in accordance with this Regulation. Where such request is not made, Regulation (EC) No 692/2008 shall apply.

2 With effect from 1 September 2017 in the case of categories M1, M2 and category N1 class I vehicles, and from 1 September 2018 in the case of N1 vehicles of class II and III and category N2 vehicles, national authorities shall refuse, on grounds relating to emissions or fuel consumption, to grant EC type approval or national type approval, in respect to new vehicle types which do not comply with this Regulation.

3 With effect from 1 September 2018 in the case of categories M1, M2 and category N1 class I vehicles, and from 1 September 2019 in the case of N1 vehicles of class II and III

Status: Point in time view as at 01/06/2017.

Changes to legislation: There are outstanding changes not yet made to Commission Regulation (EU) 2017/1151. Any changes that have already been made to the legislation appear in the content and are referenced with annotations. (See end of Document for details)

and category N2 vehicles, national authorities shall, on grounds relating to emissions or fuel consumption, in the case of new vehicles which do not comply with this Regulation, consider certificates of conformity to be no longer valid for the purposes of Article 26 of Directive 2007/46/EC and shall prohibit the registration, sale or entry into service of such vehicles.

4 Until three years after the dates specified in Article 10(4) of Regulation (EC) No 715/2007 in the case of new vehicle types and four years after the dates specified in Article 10(5) of that Regulation in the case of new vehicles, the following provisions shall apply:

- a the requirements of point 2.1 of Annex IIIA shall not apply;
- b the requirements of Annex IIIA other than that in point 2.1, including the requirements with regard to RDE tests to be performed and data to be recorded and made available, shall apply only to new type approvals granted in accordance with Regulation (EC) No 715/2007 from 27 July 2017;
- c the requirements of Annex IIIA shall not apply to type approvals granted to small volume manufacturers;
- d where the requirements set out in Appendices 5 and 6 of Annex IIIA are satisfied for only one of the two data evaluation methods described in those Appendices, one additional RDE test shall be performed;

where those requirements are again satisfied for only one method, the analysis of the completeness and normality shall be recorded for both methods and the calculation required by point 9.3 of Annex IIIA may be limited to the method for which the completeness and normality requirements are satisfied; the data of both RDE tests and of the analysis of the completeness and normality shall be recorded and made available for examining the difference in the results of the two data evaluation methods;

- e the power at the wheels of the test vehicle shall be determined either by wheel hub torque measurement or from the CO₂ mass flow using ‘Velines’ in accordance with point 4 of Appendix 6 to Annex IIIA.

5 Until 8 years after the dates given in Article 10(4) of Regulation (EC) No 715/2007:

- a type 1/I tests performed and completed in accordance to Regulation (EC) No 692/2008 until 3 years after the dates given in Article 10(4) of Regulation (EC) No 715/2007 shall be valid for the purposes of fulfilling the requirements of Annex VII and/or Appendix 1 to Annex XI to this Regulation;
- b procedures performed in accordance with section 3.13. of Annex III to Regulation (EC) No 692/2008 until 3 years after the dates given in Article 10(4) of Regulation (EC) 715/2007 shall be accepted by the approval authority for the purposes of fulfilling the requirements of the second paragraph of point 1.1 of Appendix 1 to Sub-Annex 6 to Annex XXI of this Regulation.

6 In order to ensure a fair treatment of previously existing type-approvals, the Commission shall examine the consequences of Chapter V of Directive 2007/46/EC for the purposes of this Regulation.

Article 16

Amendments to Directive 2007/46/EC

Directive 2007/46/EC is amended in accordance with Annex XVIII to this Regulation.

Status: Point in time view as at 01/06/2017.

Changes to legislation: There are outstanding changes not yet made to Commission Regulation (EU) 2017/1151. Any changes that have already been made to the legislation appear in the content and are referenced with annotations. (See end of Document for details)

Article 17

Amendments to Regulation (EC) No 692/2008

Regulation (EC) No 692/2008 is amended as follows:

(1) In Article 6, paragraph 1, shall be replaced by the following text:

1. If all the relevant requirements are met, the approval authority shall grant an EC type-approval and issue a type-approval number in accordance with the numbering system set out in Annex VII to Directive 2007/46/EC.

Without prejudice to the provisions of Annex VII to Directive 2007/46/EC, Section 3 of the type-approval number shall be drawn up in accordance with Appendix 6 to Annex I to this Regulation.

An approval authority shall not assign the same number to another vehicle type.

The requirements of Regulation (EC) No 715/2007 shall be deemed to be met if all the following conditions are fulfilled:

- a the requirements of Article 3(10) of this Regulation are met;
- b the requirements of Article 13 of this Regulation are met;
- c the vehicle has been approved according to UN/ECE Regulations No 83, series of amendments 07; No 85 and its supplements, No 101, Revision 3 (comprising series of amendments 01 and their supplements) and in the case of compression ignition vehicles No 24 Part III, series of amendments 03.
- d the requirements of Article 5(11) and (12) are met.

(2) the following Article 16a is added:

Article 16a

Transitional provisions

With effect from 1 September 2017 in the case of categories M1, M2 and category N1 class I vehicles, and from 1 September 2018 in the case of N1 vehicles of class II and III and category N2 vehicles, this Regulation shall only apply for the purposes of assessing the following requirements of vehicles type-approved in accordance with this Regulation before those dates:

- (a) conformity of production in accordance with Article 8;
- (b) in-service conformity in accordance with Article 9;
- (c) access to vehicle OBD and vehicle repair and maintenance information in accordance with Article 13;

This Regulation shall also apply for the purposes of the correlation procedure set out in Commission Implementing Regulations (EU) 2017/1152⁽⁹⁾ and (EU) 2017/1153⁽¹⁰⁾.

(3) Annex I is amended in accordance with Annex XVII to this Regulation.

Status: Point in time view as at 01/06/2017.

Changes to legislation: There are outstanding changes not yet made to Commission Regulation (EU) 2017/1151. Any changes that have already been made to the legislation appear in the content and are referenced with annotations. (See end of Document for details)

Article 18

Amendments to Commission Regulation (EU) No 1230/2012⁽¹⁾

In Regulation (EU) No 1230/2012, Article 2(5) is replaced by the following:

- (5) “Mass of the optional equipment” means the maximum mass of the combinations of optional equipment which may be fitted to the vehicle in addition to the standard equipment in accordance with the manufacturer's specifications;

Article 19

Repeal

Regulation (EC) No 692/2008 is repealed as from 1 January 2022.

Article 20

Entry into force and application

This Regulation shall enter into force on the twentieth day following its publication in the *Official Journal of the European Union*.

This Regulation shall be binding in its entirety and directly applicable in all Member States.

Done at Brussels, 1 June 2017.

For the Commission

The President

Jean-Claude JUNCKER

Status: Point in time view as at 01/06/2017.

Changes to legislation: There are outstanding changes not yet made to Commission Regulation (EU) 2017/1151. Any changes that have already been made to the legislation appear in the content and are referenced with annotations. (See end of Document for details)

LIST OF ANNEXES

ANNEX I	Administrative provisions for EC type-approval
Appendix 1	Verification of conformity of production for Type 1 test — statistical method
Appendix 2	Calculations for Conformity of Production for EVs
Appendix 3	Model information document
Appendix 4	Model EC type-approval certificate
Appendix 5	OBD related information
Appendix 6	EC type-approval certificate numbering system
Appendix 7	Manufacturer's certificate of compliance with OBD in-use performance requirements
Appendix 8a	Type 1 test Test Report template (including ATCT) with minimum reporting requirements
	Annex for reporting Co2mpass
Appendix 8b	Road Load Test Report template with minimum reporting requirements
Appendix 8c	Test Sheet template
ANNEX II	In-service conformity
Appendix 1	In-service conformity check
Appendix 2	Statistical procedure for tailpipe emissions in-service conformity testing
Appendix 3	Responsibilities for in-service conformity
ANNEX IIIA	Real Driving Emissions (RDE)
ANNEX IV	Emissions data required at type-approval for roadworthiness purposes
Appendix 1	Measuring carbon monoxide emissions at engine idling speeds (Type 2 test)
Appendix 2	Measurement of smoke opacity
ANNEX V	Verifying emissions of crankcase gases (Type 3 test)
ANNEX VI	Determination of evaporative emissions (Type 4 test)
ANNEX VII	Verifying the durability of pollution control devices (Type 5 test)
Appendix 1	Standard Bench Cycle (SBC)

Status: Point in time view as at 01/06/2017.

Changes to legislation: There are outstanding changes not yet made to Commission Regulation (EU) 2017/1151. Any changes that have already been made to the legislation appear in the content and are referenced with annotations. (See end of Document for details)

Appendix 2	Standard Diesel Bench Cycle (SDBC)
Appendix 3	Standard Road Cycle (SRC)
ANNEX VIII	Verifying the average exhaust emissions at low ambient temperatures (Type 6 test)
ANNEX IX	Specifications of reference fuels
ANNEX X	Reserved
ANNEX XI	On-board diagnostics (OBD) for motor vehicles
Appendix 1	Functional aspects of OBD systems
Appendix 2	Essential characteristics of the vehicle family
ANNEX XII	Type-Approval of vehicles fitted with eco-innovations and Determination of CO ₂ emissions and fuel consumption from N1 vehicles submitted to multi-stage type-approval
ANNEX XIII	EC Type-approval of replacement pollution control devices as separate technical unit
Appendix 1	Model information document
Appendix 2	Model EC type-approval certificate
Appendix 3	Model EC type-approval mark
ANNEX XIV	Access to vehicle OBD and vehicle repair and maintenance information
Appendix 1	Certificate of compliance
ANNEX XV	Reserved
ANNEX XVI	Requirements for vehicles that use a reagent for the exhaust after-treatment system
ANNEX XVII	Amendments to Regulation (EC) No 692/2008
ANNEX XVIII	Amendments to Directive 2007/46/EC
ANNEX XIX	Amendments to Regulation (EU) No 1230/2012
ANNEX XX	Measurement of net engine power
ANNEX XXI	Type 1 emissions test procedures

ANNEX I

ADMINISTRATIVE PROVISIONS FOR EC TYPE-APPROVAL

1. ADDITIONAL REQUIREMENTS FOR GRANTING OF EC TYPE-APPROVAL

Status: Point in time view as at 01/06/2017.

Changes to legislation: There are outstanding changes not yet made to Commission Regulation (EU) 2017/1151. Any changes that have already been made to the legislation appear in the content and are referenced with annotations. (See end of Document for details)

1.1. Additional requirements for mono fuel gas vehicles, and bi-fuel gas vehicles.

1.1.1. The additional requirements for granting of type-approval for mono fuel gas vehicles, and bi-fuel gas vehicles shall be those set out in sections 1, 2 and 3 and Appendices 1 and 2 to Annex 12 to UN/ECE Regulation No 83, with the exceptions set out below.

1.1.2. The reference in paragraphs 3.1.2. and 3.1.4. of Annex 12 to UN/ECE Regulation No 83 to reference fuels of Annex 10a shall be understood as being reference to the appropriate reference fuel specifications in Section A of Annex IX to this Regulation.

1.2. Additional requirements for flex fuel vehicles

The additional requirements for granting of type-approval for flex fuel vehicles shall be those set out in paragraph 4.9. of UN/ECE Regulation No 83.

2. ADDITIONAL TECHNICAL REQUIREMENTS AND TESTS

2.1. Small volume manufacturers

2.1.1. List of legislative acts referred to in Article 3(3):

Legislative Act	Requirements
The California Code of Regulations, Title 13, Sections 1961(a) and 1961(b)(1)(C) (1) applicable to 2001 and later model year vehicles, 1968.1, 1968.2, 1968.5, 1976 and 1975, published by Barclay's Publishing	Type-approval must be granted under the California Code of Regulations applicable to the most recent model year of light-duty vehicle.

2.2. Inlets to fuel tanks

2.2.1. The requirements for inlets to fuel tanks shall be those specified in paragraphs 5.4.1. and 5.4.2. of Annex XXI and point 2.2.2 below.

2.2.2. Provision shall be made to prevent excess evaporative emissions and fuel spillage caused by a missing fuel filler cap. This may be achieved by using one of the following:

- (a) an automatically opening and closing, non-removable fuel filler cap,
- (b) design features which avoid excess evaporative emissions in the case of a missing fuel filler cap,
- (c) any other provision which has the same effect. Examples may include, but are not limited to, a tethered filler cap, a chained filler cap or one utilizing the same locking key for the filler cap as for the vehicle's ignition. In this case the key shall be removable from the filler cap only in the locked condition.

2.3. Provisions for electronic system security

2.3.1. The provisions for electronic system security shall be those specified in paragraph 5.5 of Annex XXI and points 2.3.2 and 2.3.3 below.

2.3.2. In the case of mechanical fuel-injection pumps fitted to compression-ignition engines, manufacturers shall take adequate steps to protect the maximum fuel delivery setting from tampering while a vehicle is in service.

Status: Point in time view as at 01/06/2017.

Changes to legislation: There are outstanding changes not yet made to Commission Regulation (EU) 2017/1151. Any changes that have already been made to the legislation appear in the content and are referenced with annotations. (See end of Document for details)

2.3.3. Manufacturers shall effectively deter reprogramming of the odometer readings, in the board network, in any powertrain controller as well as in the transmitting unit for remote data exchange if applicable. Manufacturers shall include systematic tamper-protection strategies and write-protect features to protect the integrity of the odometer reading. Methods giving an adequate level of tamper protection shall be approved by the approval authority.

2.4. Application of tests

2.4.1. Figure I.2.4 illustrates the application of the tests for type-approval of a vehicle. The specific test procedures are described in Annexes II, 111A, IV, V, VI, VII, VIII, XI, XVI, XX and XXI.

Figure I.2.4

Application of test requirements for type-approval and extensions

	Vehicles with positive ignition engines including hybrids ¹								Vehicles with compression ignition engines including hybrids	Pure electric vehicles	Hydrogen fuel cell vehicles
	Mono fuel				Bi-fuel ³			Flex-fuel ³			
Reference fuel category	Petrol (E10)	LPG	NG/Biomethane (GNC)	Hydrogen (H ₂)	Petrol (E10)	Petrol (E10)	Petrol (E10)	Petrol (E10)	Diesel (B7) ⁵	—	Hydrogen (Fuel Cell)
					LPG	NG/Biomethane (GNC)	Hydrogen (H ₂) ⁴	Ethanol (E85)			
Gaseous pollutants (Type 1 test)	Yes	Yes	Yes	Yes ⁴	Yes (both fuels)	Yes (both fuels)	Yes (both fuels)	Yes (both fuels)	Yes	—	—
PM (Type 1 test)	Yes ²	—	—	—	Yes ² (petrol only)	Yes ² (petrol only)	Yes ² (petrol only)	Yes ² (both fuels)	Yes	—	—
PN	Yes ²	—	—	—	Yes ² (petrol only)	Yes ² (petrol only)	Yes ² (petrol only)	Yes ² (both fuels)	Yes	—	—
Gaseous pollutants, RDE (Type 1A test)	Yes	Yes	Yes	Yes ⁽⁴⁾	Yes (both fuels)	Yes (both fuels)	Yes (both fuels)	Yes (both fuels)	Yes	—	—

Status: Point in time view as at 01/06/2017.

Changes to legislation: There are outstanding changes not yet made to Commission Regulation (EU) 2017/1151. Any changes that have already been made to the legislation appear in the content and are referenced with annotations. (See end of Document for details)

Figure I.2.4

Application of test requirements for type-approval and extensions

PN, RDE (Type 1A test)	Yes	—	—	—	Yes (both fuels)	Yes (both fuels)	Yes (both fuels)	Yes (both fuels)	Yes	—	—
Idle emissions (Type 2 test)	Yes	Yes	Yes	—	Yes (both fuels)	Yes (both fuels)	Yes (petrol only)	Yes (both fuels)	—	—	—
Crankcase emissions (Type 3 test)	Yes	Yes	Yes	—	Yes (petrol only)	Yes (petrol only)	Yes (petrol only)	Yes (petrol only)	—	—	—
Evaporative emissions (Type 4 test)	Yes	—	—	—	Yes (petrol only)	Yes (petrol only)	Yes (petrol only)	Yes (petrol only)	—	—	—
Durability (Type 5 test)	Yes	Yes	Yes	Yes	Yes (petrol only)	Yes (petrol only)	Yes (petrol only)	Yes (petrol only)	Yes	—	—
Low temperature emissions (Type 6 test)	Yes	—	—	—	Yes (petrol only)	Yes (petrol only)	Yes (petrol only)	Yes (both fuels)	—	—	—
In-service conformity	Yes	Yes	Yes	Yes	Yes (both fuels)	Yes (both fuels)	Yes (both fuels)	Yes (both fuels)	Yes	—	—
On-board diagnostics	Yes	Yes	Yes	Yes	Yes	Yes	Yes	Yes	Yes	—	—
CO ₂ emissions, fuel consumption, electric energy consumption and electric range	Yes	Yes	Yes	Yes	Yes (both fuels)	Yes (both fuels)	Yes (both fuels)	Yes (both fuels)	Yes	Yes	Yes
Smoke opacity	—	—	—	—	—	—	—	—	Yes	—	—

Status: Point in time view as at 01/06/2017.

Changes to legislation: There are outstanding changes not yet made to Commission Regulation (EU) 2017/1151. Any changes that have already been made to the legislation appear in the content and are referenced with annotations. (See end of Document for details)

Figure I.2.4

Application of test requirements for type-approval and extensions

Engine power	Yes	Yes	Yes	Yes	Yes	Yes	Yes	Yes	Yes	Yes	Yes
--------------	-----	-----	-----	-----	-----	-----	-----	-----	-----	-----	-----

3. EXTENSIONS TO TYPE-APPROVALS

3.1. **Extensions for tailpipe emissions (type 1 and type 2 tests)**

3.1.1. The type-approval shall be extended to vehicles if they conform to the criteria of Article 2 (1).

3.1.2. Vehicles with periodically regenerating systems

For Ki tests undertaken under Appendix 1 to Sub-Annex VI to Annex XXI (WLTP), the type-approval shall be extended to vehicles if they conform to the criteria of paragraph 5.9. of Annex XXI.

For Ki tests undertaken under Annex 13 of UN/ECE Regulation No 83 (NEDC) the type-approval shall be extended to vehicles according to the requirements of Section 3.1.4. of Annex I to Regulation (EC) No 692/2008.

3.2. **Extensions for evaporative emissions (type 4 test)**

3.2.1. The type-approval shall be extended to vehicles equipped with a control system for evaporative emissions which meet the following conditions:

3.2.1.1. The basic principle of fuel/air metering (e.g. single point injection) is the same.

3.2.1.2. The shape of the fuel tank and the material of the fuel tank and liquid fuel hoses are identical.

3.2.1.3. The worst-case vehicle with regard to the cross-section and approximate hose length shall be tested. Whether non-identical vapour/liquid separators are acceptable is decided by the technical service responsible for the type-approval tests.

3.2.1.4. The fuel tank volume is within a range of $\pm 10\%$.

3.2.1.5. The setting of the fuel tank relief valve is identical.

3.2.1.6. The method of storage of the fuel vapour is identical, i.e. trap form and volume, storage medium, air cleaner (if used for evaporative emission control), etc.

3.2.1.7. The method of purging of the stored vapour is identical (e.g. air flow, start point or purge volume over the preconditioning cycle).

3.2.1.8. The method of sealing and venting of the fuel metering system is identical.

3.2.2. The type-approval shall be extended to vehicles with:

3.2.2.1. different engine sizes;

3.2.2.2. different engine powers;

3.2.2.3. automatic and manual gearboxes;

3.2.2.4. two and four wheel transmissions;

Status: Point in time view as at 01/06/2017.

Changes to legislation: There are outstanding changes not yet made to Commission Regulation (EU) 2017/1151. Any changes that have already been made to the legislation appear in the content and are referenced with annotations. (See end of Document for details)

3.2.2.5. different body styles; and

3.2.2.6. different wheel and tyre sizes.

3.3. Extensions for durability of pollution control devices (type 5 test)

3.3.1. The type-approval shall be extended to different vehicle types, provided that the vehicle, engine or pollution control system parameters specified below are identical or remain within the prescribed tolerances:

3.3.1.1. Vehicle:

Inertia category: the two inertia categories immediately above and any inertia category below.

Total road load at 80 km/h: + 5 % above and any value below.

3.3.1.2. Engine

(a) engine cylinder capacity ($\pm 15\%$),

(b) number and control of valves,

(c) fuel system,

(d) type of cooling system,

(e) combustion process.

3.3.1.3. Pollution control system parameters:

(a) Catalytic converters and particulate filters:

number of catalytic converters, filters and elements,

size of catalytic converters and filters (volume of monolith $\pm 10\%$),

type of catalytic activity (oxidizing, three-way, lean NO_x trap, SCR, lean NO_x catalyst or other),

precious metal load (identical or higher),

precious metal type and ratio ($\pm 15\%$),

substrate (structure and material),

cell density,

temperature variation of no more than 50 K at the inlet of the catalytic converter or filter. This temperature variation shall be checked under stabilized conditions at a vehicle speed of 120 km/h and the load setting of the type 1 test.

(b) Air injection:

with or without

type (pulsair, air pumps, other(s))

(c) EGR:

with or without

type (cooled or non-cooled, active or passive control, high pressure or low pressure).

3.3.1.4. The durability test may be carried out using a vehicle, which has a different body style, gear box (automatic or manual) and size of the wheels or tyres, from those of the vehicle type for which the type-approval is sought.

3.4. Extensions for on-board diagnostics

3.4.1. The type-approval shall be extended to different vehicles with identical engine and emission control systems as defined in Annex XI, Appendix 2. The type-approval shall be extended regardless of the following vehicle characteristics:

- (a) engine accessories;
- (b) tyres;
- (c) equivalent inertia;
- (d) cooling system;
- (e) overall gear ratio;
- (f) transmission type; and
- (g) type of bodywork.

3.5. Extensions for low temperature test (type 6 test)

3.5.1. Vehicles with different reference masses

3.5.1.1. The type-approval shall be extended only to vehicles with a reference mass requiring the use of the next two higher equivalent inertia or any lower equivalent inertia.

3.5.1.2. For category N vehicles, the approval shall be extended only to vehicles with a lower reference mass, if the emissions of the vehicle already approved are within the limits prescribed for the vehicle for which extension of the approval is requested.

3.5.2. Vehicles with different overall transmission ratios

3.5.2.1. The type-approval shall be extended to vehicles with different transmission ratios only under certain conditions.

3.5.2.2. To determine whether type-approval can be extended, for each of the transmission ratios used in the type 6 test, the proportion,

$$(E) = (V_2 - V_1) / V_1$$

shall be determined where, at an engine speed of 1 000 min⁻¹, V₁ is the speed of the vehicle-type approved and V₂ is the speed of the vehicle type for which extension of the approval is requested.

3.5.2.3. If, for each transmission ratio, E ≤ 8 %, the extension shall be granted without repeating the type 6 test.

3.5.2.4. If, for at least one transmission ratio, E > 8 %, and if, for each gear ratio, E ≤ 13 %, the type 6 test shall be repeated. The tests may be performed in a laboratory chosen by the manufacturer subject to the approval of the technical service. The report of the tests shall be sent to the technical service responsible for the type-approval tests.

3.5.3. Vehicles with different reference masses and transmission ratios

The type-approval shall be extended to vehicles with different reference masses and transmission ratios, provided that all the conditions prescribed in paragraphs 3.5.1 and 3.5.2 are fulfilled.

4. CONFORMITY OF PRODUCTION

Status: Point in time view as at 01/06/2017.

Changes to legislation: There are outstanding changes not yet made to Commission Regulation (EU) 2017/1151. Any changes that have already been made to the legislation appear in the content and are referenced with annotations. (See end of Document for details)

4.1. Introduction

- 4.1.1. Every vehicle produced under a Type Approval according to this Regulation shall be so manufactured as to conform to the type approval requirements of this Regulation. The Manufacturer shall implement adequate arrangements and documented control plans and carry-out at specified intervals as given in this regulation the necessary emission and OBD tests to verify continued conformity with the approved type. The approval authority shall verify and agree with these arrangements and control plans of the manufacturer and perform audits and conduct emission and OBD tests at specific intervals, as given in this regulation, at the premises of the manufacturer, including production and test facilities as part of the product conformity and continued verification arrangements as described in Annex X of Directive 2007/46/EC.
- 4.1.2. The manufacturer shall check the conformity of production by testing the emissions of pollutants (given in Table 2 of Annex I to Regulation (EC) No 715/2007), the emission of CO₂ (along with the measurement of electric energy consumption, EC), the crankcase emissions, evaporative emissions and the OBD. The verification shall therefore include the tests of types 1, 3, 4 and the test for OBD, as described in section 2.4 of this Annex and the relevant annexes quoted therein. The specific procedures for conformity of production are set out in Sections 4.2 to 4.7 and Appendixes 1 and 2.
- 4.1.3. For the purposes of the manufactures conformity of production check, the family means the CO₂ interpolation family for tests of Type 1 and 3, includes for the Type 4 test the extensions described in paragraph 3.2 of this Annex and the OBD family with the extensions described in paragraph 3.3 of this Annex for the OBD tests.
- 4.1.4. The frequency for product verification performed by the manufacturer shall be based on a risk assessment methodology consistent with the international standard ISO 31000:2009 — Risk Management — Principles and guidelines and at least for Type 1 with a minimum frequency of one verification per 5 000 vehicles produced per family or once per year, whichever comes first.
- 4.1.5. The Approval Authority which has granted type-approval may at any time verify the conformity control methods applied in each production facility.

For the purpose of this regulation the Approval Authority shall perform audits for verifying the manufacturers arrangements and documented control plans at the premises of the manufacturer on a risk assessment methodology consistent with the international standard ISO 31000:2009 — Risk Management — Principles and guidelines and, in all cases, with a minimum frequency of one audit per year.

If the Approval Authority is not satisfied with the auditing procedure of the manufacturer, physical test shall directly be carried out on production vehicles as described in Sections 4.2 to 4.9.

- 4.1.6. The normal frequency of physical test verifications by the Approval Authority shall be based on the results of the auditing procedure of the manufacturer on a risk assessment methodology and in all cases with a minimum frequency of one verification test per three years. The Approval Authority shall conduct these physical emission tests and OBD tests on production vehicles as described in Sections 4.2 to 4.9.

In the case of the manufacturer running the physical tests, the Approval Authority shall witness the tests at the manufacturer's facility.

Status: Point in time view as at 01/06/2017.

Changes to legislation: There are outstanding changes not yet made to Commission Regulation (EU) 2017/1151. Any changes that have already been made to the legislation appear in the content and are referenced with annotations. (See end of Document for details)

4.1.7. The Approval Authority shall report the results of all audit checks and physical tests performed on verifying conformity of the manufacturers and file it for a period of minimum 10 years. These reports should be available for other type approval authorities and the European Commission on request.

4.1.8. In case of non-conformity Article 30 of Directive 2007/46/EC shall apply.

4.2. **Checking the conformity of the vehicle for a type 1 test**

4.2.1. The Type 1 test shall be carried out on production vehicles of a valid member of the CO₂ interpolation family as described in the TA certificate. The limit values against which to check conformity for pollutants are set out in Table 2 of Annex I to Regulation (EC) No 715/2007. As regards CO₂ emissions, the limit value shall be the value determined by the manufacturer for the selected vehicle in accordance with the interpolation methodology set out in Sub-Annex 7 of Annex XXI. The interpolation calculation shall be verified by the approval authority.

4.2.2. A sample of three vehicles shall be selected at random in the family. After selection by the approval authority, the manufacturer shall not undertake any adjustment to the vehicles selected.

4.2.2.1. The selection shall only include finalised production vehicles which have completed a maximum of 80 km and those vehicles will be referred to as zero km vehicles for the purposes of checking conformity against Type 1 test. The vehicle shall be tested on the appropriate WLTP cycle as described in Annex XXI to this Regulation notwithstanding the requirements for test repetitions, or km of vehicles. The test results shall be the values after all corrections according to this regulation are applied.

4.2.3. The statistical method for calculating the test criteria is described in Appendix 1.

The production of a family shall be deemed to not conform when a fail decision is reached for one or more of the pollutants and CO₂ values, according to the test criteria in Appendix 1.

The production of a family shall be deemed to conform once a pass decision is reached for all the pollutants and CO₂ values according to the test criteria in Appendix 1.

When a pass decision has been reached for one pollutant, that decision shall not be changed by any additional tests carried out to reach a decision for the other pollutants and CO₂ values.

If a pass decision is not reached for all the pollutants and CO₂ values, a test shall be carried out on another vehicle, up to the maximum of 16 vehicles, and the procedure described in Appendix 1 for taking a pass or fail decision shall be repeated (see Figure I.4.2).

Status: Point in time view as at 01/06/2017.

Changes to legislation: There are outstanding changes not yet made to Commission Regulation (EU) 2017/1151. Any changes that have already been made to the legislation appear in the content and are referenced with annotations. (See end of Document for details)

Figure

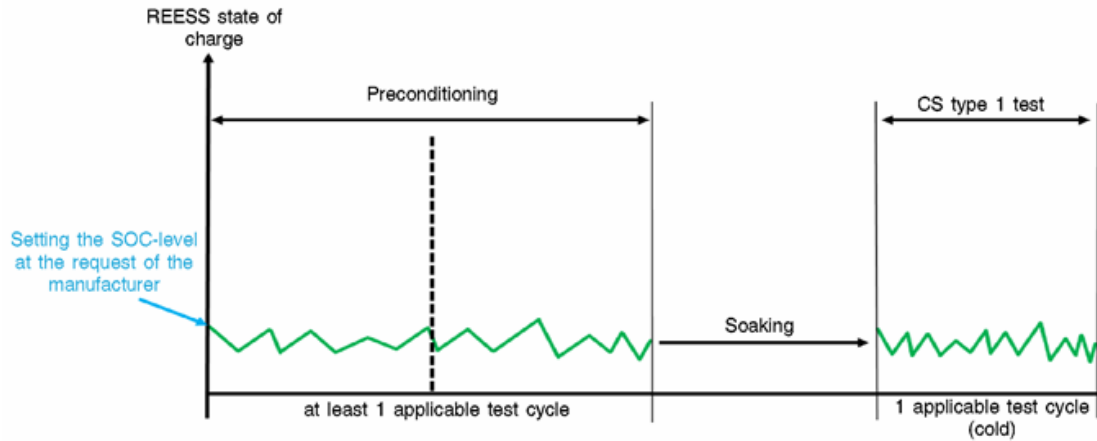

I.4.2

4.2.4. At the request of the manufacturer and with the acceptance of the approval authority, tests may be carried out on a vehicle of the family with a maximum of 15 000 km in order to establish measured evolution coefficients EvC for pollutants/CO₂ for each family. The running-in procedure shall be conducted by the manufacturer, who shall not to make any adjustments to these vehicles.

4.2.4.1. In order to establish a measured evolution coefficient with a run-in vehicle the procedure shall be as follows:

- (a) the pollutants/CO₂ shall be measured at a mileage of at most 80 km and at 'x' km of the first tested vehicle;
- (b) the evolution coefficient (EvC) of the pollutants/CO₂ between 80 km and 'x' km shall be calculated as:

$$EvC_{meas} = \text{values at } x \text{ km} / \text{values at 80 km}$$

- (c) the other vehicles in the interpolation family shall not be run in, but their zero km emissions/EC/CO₂ shall be multiplied by the evolution coefficient of the first run-in vehicle. In this case, the values to be taken for testing as in Appendix 1 shall be:

- (i) the values at 'x' km for the first vehicle;
- (ii) the values at zero km multiplied by the relevant evolution coefficient for the other vehicles.

4.2.4.2. All these tests shall be conducted with commercial fuel. However, at the manufacturer's request, the reference fuels described in Annex IX may be used.

4.2.4.3. When checking the conformity of production for CO₂, as an alternative to the procedure mentioned in Section 4.2.4.1 the vehicle manufacturer may use a fixed evolution coefficient EvC of 0,98 and multiply all values of CO₂ measured at zero km by this factor.

4.2.5 Tests for conformity of production of vehicles fuelled by LPG or NG/biomethane may be performed with a commercial fuel of which the C3/C4 ratio lies between those of the reference fuels in the case of LPG, or of one of the high or low caloric fuels in the case of NG/biomethane. In all cases a fuel analysis shall be presented to the approval authority.

Status: Point in time view as at 01/06/2017.

Changes to legislation: There are outstanding changes not yet made to Commission Regulation (EU) 2017/1151. Any changes that have already been made to the legislation appear in the content and are referenced with annotations. (See end of Document for details)

4.2.6. Vehicles fitted with eco-innovations

4.2.6.1. In the case of a vehicle type fitted with one or more eco-innovations, within the meaning of Article 12 of Regulation (EC) No 443/2009 for M1 vehicles or Article 12 of Regulation (EU) No 510/2011 for N1 vehicles, the conformity of production shall be demonstrated with respect to the eco-innovations, by checking the presence of the correct eco-innovation(s) in question.

4.3. **PEVs**

4.3.1 Measures to ensure the conformity of production with regard to electric energy consumption (EC) shall be checked on the basis of the type-approval certificate set out in Appendix 4 to this Annex.

4.3.2. Electric energy consumption verification for conformity of production

4.3.2.1. During the conformity of production procedure, the break-off criterion for the Type 1 test procedure according to paragraph 3.4.4.1.3 of Sub-Annex 8 to Annex XXI of this Regulation (consecutive cycle procedure) and paragraph 3.4.4.2.3. of Sub-Annex 8 to Annex XXI of this Regulation (Shortened Test Procedure) shall be replaced with the following:

The break-off criterion for the conformity of production procedure shall be reached with having finished the first applicable WLTP test cycle.

4.3.2.2. During this first applicable WLTP test cycle, the DC energy from the REESS(s) shall be measured according to the method described in Appendix 3 of Sub-Annex 8 to Annex XXI of this Regulation and divided by the driven distance in this applicable WLTP test cycle.

4.3.2.3. The value determined according to paragraph 4.3.2.2 shall be compared to the value determined according to paragraph 1.2 of Appendix 2.

4.3.2.4. Conformity for EC shall be checked using the statistical procedures described in Section 4.2 and Appendix 1. For the purposes of this conformity check, the terms pollutants/CO₂ shall be replaced by EC.

4.4. **OVC-HEVs**

4.4.1. Measures to ensure the conformity of production with regard to CO₂ mass emission and electric energy consumption from OVC-HEV shall be checked on the basis of the description in the type-approval certificate set out in Appendix 4 to this Annex.

4.4.2. CO₂ mass emission verification for conformity of production

4.4.2.1. The vehicle shall be tested according to the charge-sustaining Type 1 test as described in paragraph 3.2.5. of Sub-Annex 8 to Annex XXI of this Regulation.

4.4.2.2. During this test, the charge-sustaining CO₂ mass emission shall be determined according to Table A8/5 of Sub-Annex 8 to Annex XXI of this Regulation and compared to the charge-sustaining CO₂ mass emission according to paragraph 2.3 of Appendix 2.

4.4.2.3. Conformity for CO₂ emissions shall be checked using the statistical procedures described in Section 4.2 and Appendix 1.

4.4.3. Electric energy consumption verification for conformity of production

Status: Point in time view as at 01/06/2017.

Changes to legislation: There are outstanding changes not yet made to Commission Regulation (EU) 2017/1151. Any changes that have already been made to the legislation appear in the content and are referenced with annotations. (See end of Document for details)

- 4.4.3.1. During the conformity of production procedure, the end of the charge-depleting Type 1 test procedure according to paragraph 3.2.4.4. of Sub-Annex 8 to Annex XXI of this Regulation shall be replaced with the following:

The end of the charge-depleting Type 1 test procedure for the conformity of production procedure shall be reached with having finished the first applicable WLTP test cycle.

- 4.4.3.2. During this first applicable WLTP test cycle, the DC energy from the REESS(s) shall be measured according to the method described in Appendix 3 of Sub-Annex 8 to Annex XXI of this Regulation and divided by the driven distance in this applicable WLTP test cycle.

- 4.4.3.3. The value determined according to paragraph 4.5.3.2. of this Regulation shall be compared to the value determined according to paragraph 2.4. of Appendix 2.

- 4.4.1.4. Conformity for EC shall be checked using the statistical procedures described in Section 4.2 and Appendix 1. For the purposes of this conformity check, the terms pollutants/CO₂ shall be replaced by EC.

4.5. Checking the conformity of the vehicle for a Type 3 test

- 4.5.1. If a verification of the Type 3 test is to be carried out, it shall be conducted in accordance with the following requirements:

- 4.5.1.1. When the approval authority determines that the quality of production seems unsatisfactory, a vehicle shall be randomly taken from the family and subjected to the tests described in Annex V.

- 4.5.1.2. The production shall be deemed to conform if this vehicle meets the requirements of the tests described in Annex V.

- 4.5.1.3. If the vehicle tested does not satisfy the requirements of Section 4.5.1.1, a further random sample of four vehicles shall be taken from the same family and subjected to the tests described in Annex V. The tests may be carried out on vehicles which have completed a maximum of 15 000 km with no modifications.

- 4.5.1.4. The production shall be deemed to conform if at least three vehicles meet the requirements of the tests described in Annex V.

4.6. Checking the conformity of the vehicle for a Type 4 test

- 4.6.1. If a verification of the Type 4 test is to be carried out, it shall be conducted in accordance with the following requirements:

- 4.6.1.1. When the approval authority determines that the quality of production seems unsatisfactory, a vehicle shall be randomly taken from the family and subjected to the tests described in Annex VI, or at least as in paragraph 7 of Annex 7 of UN Regulation 83.

- 4.6.1.2. The production shall be deemed to conform if this vehicle meets the requirements of the tests described in Annex VI, or paragraph 7 of Annex 7 of UN Regulation 83 depending on the test performed.

- 4.6.1.3. If the vehicle tested does not satisfy the requirements of section 4.6.1.1, a further random sample of four vehicles shall be taken from the same family and subjected to the tests described in Annex VI, or at least as in paragraph 7 of Annex 7 of UN

Status: Point in time view as at 01/06/2017.

Changes to legislation: There are outstanding changes not yet made to Commission Regulation (EU) 2017/1151. Any changes that have already been made to the legislation appear in the content and are referenced with annotations. (See end of Document for details)

Regulation 83. The tests may be carried out on vehicles which have completed a maximum of 15 000 km with no modifications.

4.6.1.4. The production shall be deemed to conform if at least three vehicles meet the requirements of the tests described in Annex VI, or paragraph 7 of Annex 7 of UN Regulation 83 depending on the test performed.

4.7. **Checking the conformity of the vehicle for On-board Diagnostics (OBD)**

4.7.1. If a verification of the performance of the OBD system is to be carried out, it shall be conducted in accordance with the following requirements:

4.7.1.1. When the approval authority determines that the quality of production seems unsatisfactory, a vehicle shall be randomly taken from the family and subjected to the tests described in Appendix 1 to Annex XI.

4.7.1.2. The production shall be deemed to conform if this vehicle meets the requirements of the tests described in Appendix 1 to Annex XI.

4.7.1.3. If the vehicle tested does not satisfy the requirements of section 4.7.1.1, a further random sample of four vehicles shall be taken from the same family and subjected to the tests described in Appendix 1 to Annex XI. The tests may be carried out on vehicles which have completed a maximum of 15 000 km with no modifications.

4.7.1.4. The production shall be deemed to conform if at least three vehicles meet the requirements of the tests described in Appendix 1 to Annex XI.

Appendix 1

Verification of conformity of production for Type 1 test—statistical method

1. This appendix describes the procedure to be used to verify the production conformity requirements for the Type 1 test for pollutants/CO₂, including conformity requirements for PEVs and OVC-HEVs.
2. Measurements of the pollutants specified in Table 2 of Annex I to Regulation (EC) No 715/2007 and the emission of CO₂ shall be carried out on a minimum number of 3 vehicles, and consecutively increase until a pass or fail decision is reached.

From the number of N tests: x_1, x_2, \dots, x_N , the average X_{tests} and the variance VAR are to be determined from all N measurements:

$$X_{tests} = (x_1 + x_2 + x_3 + \dots + x_N) / N$$

and

$$VAR = \left((x_1 - X_{tests})^2 + (x_2 - X_{tests})^2 + \dots + (x_N - X_{tests})^2 \right) / (N - 1)$$

3. For each number of tests, one of the three following decisions (see (i) to ((iii) below) can be reached for pollutants based on the limit value L for each pollutant, the average of all N tests: X_{tests} , the variance of the test results VAR and the number of tests N :

(i) Pass the family if

$$X_{tests} < A \times L - VAR / L$$

(ii) Fail the family if

Status: Point in time view as at 01/06/2017.

Changes to legislation: There are outstanding changes not yet made to Commission Regulation (EU) 2017/1151. Any changes that have already been made to the legislation appear in the content and are referenced with annotations. (See end of Document for details)

$$X_{\text{tests}} > A \times L - ((N - 3)/13) \times \text{VAR} / L$$

(iii) Take another measurement if:

$$A \times L - \text{VAR} / L \leq X_{\text{tests}} < A \times L - ((N - 3)/13) \times \text{VAR} / L$$

For the measurement of pollutants the factor A is set at 1,05 in order to take into account inaccuracies in the measurements.

4. For CO₂ and EC the normalised values for CO₂ and EC shall be used:

$$x_i = \text{CO}_{2\text{test}-i} / \text{CO}_{2\text{declared}}$$

$$x_i = \text{EC}_{\text{test}-i} / \text{EC}_{\text{DC, COP}}$$

In the case of CO₂ and EC the factor A is set at 1.01 and the value for L is set at 1. So in the case of CO₂ and EC the criteria are simplified to:

(i) Pass the family if

$$X_{\text{tests}} < A - \text{VAR}$$

(ii) Fail the family if

$$X_{\text{tests}} > A - ((N - 3)/13) \times \text{VAR}$$

(iii) Take another measurement if:

$$A - \text{VAR} \leq X_{\text{tests}} < A - ((N - 3)/13) \times \text{VAR}$$

The A values for pollutants, EC and CO₂ will be reviewed and may change according to the available evidence. For this reason the Type Approval Authorities will need to provide the Commission with all relevant data at least for the initial period of 5 years.

Appendix 2

Calculations for Conformity of Production of EVs

1. Calculations for conformity of production values for PEVs

1.1 Interpolating of individual electric energy consumption of PEVs

$$\text{EC}_{\text{DC-ind,COP}} = \text{EC}_{\text{DC-L,COP}} + K_{\text{ind}} \times (\text{EC}_{\text{DC-H,COP}} - \text{EC}_{\text{DC-L,COP}})$$

where:

EC_{DC-ind,COP} is the electric energy consumption of an individual vehicle for the conformity of production, Wh/km;

EC_{DC-L,COP} is the electric energy consumption of vehicle L for the conformity of production, Wh/km;

EC_{DC-H,COP} is the electric energy consumption of vehicle H for the conformity of production, Wh/km;

K_{ind} is the interpolation coefficient for the considered individual vehicle for the applicable WLTP test cycle.

1.2 Electric Consumption for PEVs

The following value shall be declared and used for verifying the conformity of production with respect to the electric consumption:

$$\text{EC}_{\text{DC,COP}} = \text{EC}_{\text{DC,CD,first WLTC}} \times \text{AF}_{\text{EC}}$$

where:

Status: Point in time view as at 01/06/2017.

Changes to legislation: There are outstanding changes not yet made to Commission Regulation (EU) 2017/1151. Any changes that have already been made to the legislation appear in the content and are referenced with annotations. (See end of Document for details)

$EC_{DC,COP}$	is the electric energy consumption based on the REESS depletion of the first applicable WLTC test cycle provided for the verification during the conformity of production test procedure;
$EC_{DC,CD,first\ WLTC}$	is the electric energy consumption based on the REESS depletion of the first applicable WLTC test cycle according to paragraph 4.3. of Sub-Annex 8 to Annex XXI, in Wh/km;
AF_{EC}	is the adjustment factor which compensates the difference between the charge-depleting electric energy consumption value declared after having performed the Type 1 test procedure during homologation and the measured test result determined during the conformity of production procedure

and

$$AF_{EC} = \frac{EC_{WLTC,declared}}{EC_{WLTC}}$$

where

$EC_{WLTC,declared}$	is the declared electric energy consumption for PEVs according to paragraph 1.1.2.3. of Sub-Annex 6 of Annex XXI
EC_{WLTC}	is the measured electric energy consumption according to paragraph 4.3.4.2. of Sub-Annex 8 to Annex XXI.

2. Calculations for conformity of production values for OVC-HEVs

2.1 Individual charge-sustaining CO₂ mass emission of OVC-HEVs for conformity of production

$$M_{CO_2-ind,CS,COP} = M_{CO_2-L,CS,COP} + K_{ind} \times (M_{CO_2-H,CS,COP} - M_{CO_2-L,CS,COP})$$

where:

$M_{CO_2-ind,CS,COP}$	is the charge-sustaining CO ₂ mass emission of an individual vehicle for the conformity of production, g/km;
$M_{CO_2-L,CS,COP}$	is the charge-sustaining CO ₂ mass emission of vehicle L for the conformity of production, g/km;
$M_{CO_2-H,CS,COP}$	is the charge-sustaining CO ₂ mass emission of vehicle H for the conformity of production, g/km;
K_{ind}	is the interpolation coefficient for the considered individual vehicle for the applicable WLTP test cycle.

2.2 Individual charge-depleting electric energy consumption of OVC-HEVs for conformity of production

$$EC_{DC-ind,CD,COP} = EC_{DC-L,CD,COP} + K_{ind} \times (EC_{DC-H,CD,COP} - EC_{DC-L,CD,COP})$$

where:

$EC_{DC-ind,CD,COP}$	is the charge-depleting electric energy consumption of an individual vehicle for the conformity of production, Wh/km;
$EC_{DC-L,CD,COP}$	is the charge-depleting electric energy consumption of vehicle L for the conformity of production, Wh/km;
$EC_{DC-H,CD,COP}$	is the charge-depleting electric energy consumption of vehicle H for the conformity of production, Wh/km;
K_{ind}	is the interpolation coefficient for the considered individual vehicle for the applicable WLTP test cycle.

2.3 Charge-sustaining CO₂ mass emission value for conformity of production

Status: Point in time view as at 01/06/2017.

Changes to legislation: There are outstanding changes not yet made to Commission Regulation (EU) 2017/1151. Any changes that have already been made to the legislation appear in the content and are referenced with annotations. (See end of Document for details)

The following value shall be declared and used for the verification of the conformity of production with respect to the charge-sustaining CO₂ mass emission:

$$M_{CO_2,CS,COP} = M_{CO_2,CS} \times AF_{CO_2,CS}$$

where:

$M_{CO_2,CS,COP}$ is the charge-sustaining CO₂ mass emission value of the charge-sustaining Type 1 test provided for the verification during the conformity of production test procedure;

$M_{CO_2,CS}$ is the charge-sustaining CO₂ mass emission of the charge-sustaining Type 1 test according to paragraph 4.1.1. of Annex XXI, g/km;

$AF_{CO_2,CS}$ is the adjustment factor which compensates the difference between the value declared after having performed the Type 1 test procedure during homologation and the measured test result determined during the conformity of production procedure

And

$$AF_{CO_2,CS} = \frac{M_{CO_2,CS,c,declared}}{M_{CO_2,CS,c,6}}$$

where

$M_{CO_2,CS,c,declared}$ is the declared charge-sustaining CO₂ mass emission of the charge-sustaining Type 1 test according to step 7 of Table A8/5 of Sub-Annex 8 to Annex XXI.

$M_{CO_2,CS,c,6}$ is the measured charge-sustaining CO₂ mass emission of the charge-sustaining Type 1 test according to step 6 of Table A8/5 of Sub-Annex 8 to Annex XXI.

2.4 Charge-depleting electric energy consumption for conformity of production

The following value shall be declared and used for verifying the conformity of production with respect to the charge-depleting electric energy consumption

$$EC_{DC,CD,COP} = EC_{DC,CD,first\ WLTC} \times AF_{EC,AC,CD}$$

where:

$EC_{DC,CD,COP}$ is the charge-depleting electric energy consumption based on the REESS depletion of the first applicable WLTC test cycle of the charge-depleting Type 1 test provided for the verification during the conformity of production test procedure;

$EC_{DC,CD,first\ WLTC}$ is the charge-depleting electric energy consumption based on the REESS depletion of the first applicable WLTC test cycle of the charge-depleting Type 1 test according to paragraph 4.3. of Sub-Annex 8 to Annex XXI, Wh/km;

$AF_{EC,AC,CD}$ is the adjustment factor for the charge-depleting electric energy consumption which compensates the difference between the value declared after having performed the Type 1 test procedure during homologation and the measured test result determined during the conformity of production procedure

and

$$AF_{EC,AC,CD} = \frac{EC_{AC,CD,declared}}{EC_{AC,CD}}$$

where

Status: Point in time view as at 01/06/2017.

Changes to legislation: There are outstanding changes not yet made to Commission Regulation (EU) 2017/1151. Any changes that have already been made to the legislation appear in the content and are referenced with annotations. (See end of Document for details)

EC _{AC,CD,declared}	is the declared charge-depleting electric energy consumption of the charge-depleting Type 1 test according to paragraph 1.1.2.3. of Sub-Annex 6 to Annex XXI.
EC _{AC,CD}	is the measured charge-depleting electric energy consumption of the charge-depleting Type 1 test according to paragraph 4.3.1. of Sub-Annex 8 to Annex XXI.

Appendix 3

MODELINFORMATION DOCUMENT No ...

RELATING TO EC TYPE-APPROVAL OF A VEHICLE WITH REGARD TO EMISSIONS AND ACCESS TO VEHICLE REPAIR AND MAINTENANCE INFORMATION

The following information, if applicable, must be supplied in triplicate and include a list of contents. Any drawings must be supplied in appropriate scale and in sufficient detail on size A4 or on a folder of A4 format. Photographs, if any, must show sufficient detail.

If the systems, components or separate technical units have electronic controls, information concerning their performance must be supplied.

0	GENERAL
0.1.	Make (trade name of manufacturer): ...
0.2.	Type: ...
0.2.1.	Commercial name(s) (if available): ...
0.4.	Category of vehicle (°): ...
0.8.	Name(s) and address(es) of assembly plant(s): ...
0.9.	Name and address of the manufacturer's representative (if any): ...
1	GENERAL CONSTRUCTION CHARACTERISTICS
1.1.	Photographs and/or drawings of a representative vehicle/component/separate technical unit (¹):
1.3.3.	Powered axles (number, position, interconnection): ...
2	MASSES AND DIMENSIONS (²) (³) (⁴) (in kg and mm) (Refer to drawing where applicable)
2.6.	Mass in running order (⁵) (a) maximum and minimum for each variant: ... (b) mass of each version (a matrix must be provided): ...

Status: Point in time view as at 01/06/2017.

Changes to legislation: There are outstanding changes not yet made to Commission Regulation (EU) 2017/1151. Any changes that have already been made to the legislation appear in the content and are referenced with annotations. (See end of Document for details)

2.8.	Technically permissible maximum laden mass stated by the manufacturer (ⁱ) (³): ...
3	PROPULSION ENERGY CONVERTER (^k)
3.1.	Manufacturer of the propulsion energy converter(s): ...
3.1.1.	Manufacturer's code (as marked on the propulsion energy converter or other means of identification): ...
3.2.	Internal combustion engine
3.2.1.1.	Working principle: positive ignition/ compression ignition/dual fuel (^l) Cycle: four stroke/two stroke/rotary (^l)
3.2.1.2.	Number and arrangement of cylinders: ...
3.2.1.2.1.	Bore (^l): ... mm
3.2.1.2.2.	Stroke (^l): ... mm
3.2.1.2.3.	Firing order: ...
3.2.1.3.	Engine capacity (^m): ... cm ³
3.2.1.4.	Volumetric compression ratio (²): ...
3.2.1.5.	Drawings of combustion chamber, piston crown and, in the case of positive ignition engines, piston rings: ...
3.2.1.6.	Normal engine idling speed (²): ... min ⁻¹
3.2.1.6.1.	High engine idling speed (²): ... min ⁻¹
3.2.1.8.	Rated engine power (ⁿ): ... kW at ... min ⁻¹ (manufacturer's declared value)
3.2.1.9.	Maximum permitted engine speed as prescribed by the manufacturer: ... min ⁻¹
3.2.1.10.	Maximum net torque (ⁿ): ... Nm at ... min ⁻¹ (manufacturer's declared value)
3.2.2.	Fuel
3.2.2.1.	Light-duty vehicles: Diesel/Petrol/LPG/NG or Biomethane/Ethanol (E85)/Biodiesel/ Hydrogen/H ₂ NG (¹) (⁶)
3.2.2.1.1.	RON, unleaded: ...
3.2.2.4.	Vehicle fuel type: Mono fuel, Bi fuel, Flex fuel (¹)

Status: Point in time view as at 01/06/2017.

Changes to legislation: There are outstanding changes not yet made to Commission Regulation (EU) 2017/1151. Any changes that have already been made to the legislation appear in the content and are referenced with annotations. (See end of Document for details)

3.2.2.5.	Maximum amount of biofuel acceptable in fuel (manufacturer's declared value): ... % by volume
3.2.4.	Fuel feed
3.2.4.1.	By carburettor(s): yes/no ⁽¹⁾
3.2.4.2.	By fuel injection (compression ignition or dual fuel only): yes/no ⁽¹⁾
3.2.4.2.1.	System description (common rail/unit injectors/distribution pump etc.): ...
3.2.4.2.2.	Working principle: direct injection/pre-chamber/swirl chamber ⁽¹⁾
3.2.4.2.3.	Injection/Delivery pump
3.2.4.2.3.1.	Make(s): ...
3.2.4.2.3.2.	Type(s): ...
3.2.4.2.3.3.	Maximum fuel delivery ⁽¹⁾ ⁽²⁾ : ... mm ³ / stroke or cycle at an engine speed of: ... min ⁻¹ ¹ or, alternatively, a characteristic diagram: ... (When boost control is supplied, state the characteristic fuel delivery and boost pressure versus engine speed)
3.2.4.2.4.	Engine speed limitation control
3.2.4.2.4.2.1.	Speed at which cut-off starts under load: ... min ⁻¹
3.2.4.2.4.2.2.	Maximum no-load speed: ... min ⁻¹
3.2.4.2.6.	Injector(s)
3.2.4.2.6.1.	Make(s): ...
3.2.4.2.6.2.	Type(s): ...
3.2.4.2.8.	Auxiliary starting aid
3.2.4.2.8.1.	Make(s): ...
3.2.4.2.8.2.	Type(s): ...
3.2.4.2.8.3.	System description: ...
3.2.4.2.9.	Electronic controlled injection: yes/no ⁽¹⁾
3.2.4.2.9.1.	Make(s): ...
3.2.4.2.9.2.	Type(s):
3.2.4.2.9.3	Description of the system: ...
3.2.4.2.9.3.1.	Make and type of the control unit (ECU): ...
3.2.4.2.9.3.1.1.	Software version of the ECU: ...

Status: Point in time view as at 01/06/2017.

Changes to legislation: There are outstanding changes not yet made to Commission Regulation (EU) 2017/1151. Any changes that have already been made to the legislation appear in the content and are referenced with annotations. (See end of Document for details)

3.2.4.2.9.3.2.	Make and type of the fuel regulator: ...
3.2.4.2.9.3.3.	Make and type of the air-flow sensor: ...
3.2.4.2.9.3.4.	Make and type of fuel distributor: ...
3.2.4.2.9.3.5.	Make and type of the throttle housing: ...
3.2.4.2.9.3.6.	Make and type or working principle of water temperature sensor: ...
3.2.4.2.9.3.7.	Make and type or working principle of air temperature sensor: ...
3.2.4.2.9.3.8.	Make and type or working principle of air pressure sensor: ...
3.2.4.3.	By fuel injection (positive ignition only): yes/no ⁽¹⁾
3.2.4.3.1.	Working principle: intake manifold (single-/ multi-point/direct injection ⁽¹⁾ /other (specify): ...
3.2.4.3.2.	Make(s): ...
3.2.4.3.3.	Type(s): ...
3.2.4.3.4.	System description (In the case of systems other than continuous injection give equivalent details): ...
3.2.4.3.4.1.	Make and type of the control unit (ECU): ...
3.2.4.3.4.1.1.	Software version of the ECU: ...
3.2.4.3.4.3.	Make and type or working principle of air- flow sensor: ...
3.2.4.3.4.8.	Make and type of throttle housing: ...
3.2.4.3.4.9.	Make and type or working principle of water temperature sensor: ...
3.2.4.3.4.10.	Make and type or working principle of air temperature sensor: ...
3.2.4.3.4.11.	Make and type or working principle of air pressure sensor: ...
3.2.4.3.5.	Injectors
3.2.4.3.5.1.	Make: ...
3.2.4.3.5.2.	Type: ...
3.2.4.3.7.	Cold start system
3.2.4.3.7.1.	Operating principle(s): ...
3.2.4.3.7.2.	Operating limits/settings ⁽¹⁾ ⁽²⁾ : ...
3.2.4.4.	Feed pump

Status: Point in time view as at 01/06/2017.

Changes to legislation: There are outstanding changes not yet made to Commission Regulation (EU) 2017/1151. Any changes that have already been made to the legislation appear in the content and are referenced with annotations. (See end of Document for details)

3.2.4.4.1.	Pressure (²): ... kPa or characteristic diagram (²): ...
3.2.4.4.2.	Make(s): ...
3.2.4.4.3.	Type(s): ...
3.2.5.	Electrical system
3.2.5.1.	Rated voltage: ... V, positive/negative ground (¹)
3.2.5.2.	Generator
3.2.5.2.1.	Type: ...
3.2.5.2.2.	Nominal output: ... VA
3.2.6.	Ignition system (spark ignition engines only)
3.2.6.1.	Make(s): ...
3.2.6.2.	Type(s): ...
3.2.6.3.	Working principle: ...
3.2.6.6.	Spark plugs
3.2.6.6.1.	Make: ...
3.2.6.6.2.	Type: ...
3.2.6.6.3.	Gap setting: ... mm
3.2.6.7.	Ignition coil(s)
3.2.6.7.1.	Make: ...
3.2.6.7.2.	Type: ...
3.2.7.	Cooling system: liquid/air (¹)
3.2.7.1.	Nominal setting of the engine temperature control mechanism: ...
3.2.7.2.	Liquid
3.2.7.2.1.	Nature of liquid: ...
3.2.7.2.2.	Circulating pump(s): yes/no (¹)
3.2.7.2.3.	Characteristics: ... or
3.2.7.2.3.1.	Make(s): ...
3.2.7.2.3.2.	Type(s): ...
3.2.7.2.4.	Drive ratio(s): ...
3.2.7.2.5.	Description of the fan and its drive mechanism: ...
3.2.7.3.	Air
3.2.7.3.1.	Fan: yes/no (¹)

Status: Point in time view as at 01/06/2017.

Changes to legislation: There are outstanding changes not yet made to Commission Regulation (EU) 2017/1151. Any changes that have already been made to the legislation appear in the content and are referenced with annotations. (See end of Document for details)

3.2.7.3.2.	Characteristics: ... or
3.2.7.3.2.1.	Make(s): ...
3.2.7.3.2.2.	Type(s): ...
3.2.7.3.3.	Drive ratio(s): ...
3.2.8.	Intake system
3.2.8.1.	Pressure charger: yes/no ⁽¹⁾
3.2.8.1.1.	Make(s): ...
3.2.8.1.2.	Type(s): ...
3.2.8.1.3.	Description of the system (e.g. maximum charge pressure: ... kPa; wastegate if applicable): ...
3.2.8.2.	Intercooler: yes/no ⁽¹⁾
3.2.8.2.1.	Type: air-air/air-water ⁽¹⁾
3.2.8.3.	Intake depression at rated engine speed and at 100 % load (compression ignition engines only)
3.2.8.4.	Description and drawings of inlet pipes and their accessories (plenum chamber, heating device, additional air intakes, etc.): ...
3.2.8.4.1.	Intake manifold description (include drawings and/or photos): ...
3.2.8.4.2.	Air filter, drawings: ... or
3.2.8.4.2.1.	Make(s): ...
3.2.8.4.2.2.	Type(s): ...
3.2.8.4.3.	Intake silencer, drawings: ... or
3.2.8.4.3.1.	Make(s): ...
3.2.8.4.3.2.	Type(s): ...
3.2.9.	Exhaust system
3.2.9.1.	Description and/or drawing of the exhaust manifold: ...
3.2.9.2.	Description and/or drawing of the exhaust system: ...
3.2.9.3.	Maximum allowable exhaust back pressure at rated engine speed and at 100 % load (compression ignition engines only): ... kPa
3.2.10.	Minimum cross-sectional areas of inlet and outlet ports: ...
3.2.11.	Valve timing or equivalent data

Status: Point in time view as at 01/06/2017.

Changes to legislation: There are outstanding changes not yet made to Commission Regulation (EU) 2017/1151. Any changes that have already been made to the legislation appear in the content and are referenced with annotations. (See end of Document for details)

3.2.11.1.	Maximum lift of valves, angles of opening and closing, or timing details of alternative distribution systems, in relation to dead centres. For variable timing system, minimum and maximum timing: ...
3.2.11.2.	Reference and/or setting ranges ⁽¹⁾ : ...
3.2.12.	Measures taken against air pollution
3.2.12.1.	Device for recycling crankcase gases (description and drawings): ...
3.2.12.2.	Pollution control devices (if not covered by another heading)
3.2.12.2.1.	Catalytic converter
3.2.12.2.1.1.	Number of catalytic converters and elements (provide the information below for each separate unit): ...
3.2.12.2.1.2.	Dimensions, shape and volume of the catalytic converter(s): ...
3.2.12.2.1.3.	Type of catalytic action: ...
3.2.12.2.1.4.	Total charge of precious metals: ...
3.2.12.2.1.5.	Relative concentration: ...
3.2.12.2.1.6.	Substrate (structure and material): ...
3.2.12.2.1.7.	Cell density: ...
3.2.12.2.1.8.	Type of casing for the catalytic converter(s): ...
3.2.12.2.1.9.	Location of the catalytic converter(s) (place and reference distance in the exhaust line): ...
3.2.12.2.1.10.	Heat shield: yes/no ⁽¹⁾
3.2.12.2.1.11.	Normal operating temperature range: ... °C
3.2.12.2.1.12.	Make of catalytic converter: ...
3.2.12.2.1.13.	Identifying part number: ...
3.2.12.2.2.	Sensors
3.2.12.2.2.1.	Oxygen sensor: yes/no ⁽¹⁾
3.2.12.2.2.1.1.	Make: ...
3.2.12.2.2.1.2.	Location: ...
3.2.12.2.2.1.3.	Control range: ...
3.2.12.2.2.1.4.	Type or working principle: ...
3.2.12.2.2.1.5.	Identifying part number: ...

Status: Point in time view as at 01/06/2017.

Changes to legislation: There are outstanding changes not yet made to Commission Regulation (EU) 2017/1151. Any changes that have already been made to the legislation appear in the content and are referenced with annotations. (See end of Document for details)

3.2.12.2.2.2.	NO _x sensor: yes/no ⁽¹⁾
3.2.12.2.2.2.1.	Make: ...
3.2.12.2.2.2.2.	Type: ...
3.2.12.2.2.2.3.	Location
3.2.12.2.2.3.	Particulate sensor: yes/no ⁽¹⁾
3.2.12.2.2.3.1.	Make: ...
3.2.12.2.2.3.2.	Type: ...
3.2.12.2.2.3.3.	Location: ...
3.2.12.2.3.	Air injection: yes/no ⁽¹⁾
3.2.12.2.3.1.	Type (pulse air, air pump, etc.): ...
3.2.12.2.4.	Exhaust gas recirculation (EGR): yes/no ⁽¹⁾
3.2.12.2.4.1.	Characteristics (make, type, flow, high pressure/low pressure/combined pressure, etc.): ...
3.2.12.2.4.2.	Water-cooled system (to be specified for each EGR system e.g. low pressure/high pressure/combined pressure: yes/no ⁽¹⁾
3.2.12.2.5.	Evaporative emissions control system (petrol and ethanol engines only): yes/no ⁽¹⁾
3.2.12.2.5.1.	Detailed description of the devices: ...
3.2.12.2.5.2.	Drawing of the evaporative control system: ...
3.2.12.2.5.3.	Drawing of the carbon canister: ...
3.2.12.2.5.4.	Mass of dry charcoal: ... g
3.2.12.2.5.5.	Schematic drawing of the fuel tank with indication of capacity and material (petrol and ethanol engines only): ...
3.2.12.2.5.6.	Description and schematic of the heat shield between tank and exhaust system: ...
3.2.12.2.6.	Particulate trap (PT): yes/no ⁽¹⁾
3.2.12.2.6.1.	Dimensions, shape and capacity of the particulate trap: ...
3.2.12.2.6.2.	Design of the particulate trap: ...
3.2.12.2.6.3.	Location (reference distance in the exhaust line): ...
3.2.12.2.6.4.	Make of particulate trap: ...
3.2.12.2.6.5.	Identifying part number: ...

Status: Point in time view as at 01/06/2017.

Changes to legislation: There are outstanding changes not yet made to Commission Regulation (EU) 2017/1151. Any changes that have already been made to the legislation appear in the content and are referenced with annotations. (See end of Document for details)

3.2.12.2.7	On-board-diagnostic (OBD) system: yes/no ⁽¹⁾
3.2.12.2.7.1.	Written description and/or drawing of the MI: ...
3.2.12.2.7.2.	List and purpose of all components monitored by the OBD system: ...
3.2.12.2.7.3.	Written description (general working principles) for
3.2.12.2.7.3.1	Positive-ignition engines
3.2.12.2.7.3.1.1.	Catalyst monitoring: ...
3.2.12.2.7.3.1.2.	Misfire detection: ...
3.2.12.2.7.3.1.3.	Oxygen sensor monitoring: ...
3.2.12.2.7.3.1.4.	Other components monitored by the OBD system: ...
3.2.12.2.7.3.2.	Compression-ignition engines: ...
3.2.12.2.7.3.2.1.	Catalyst monitoring: ...
3.2.12.2.7.3.2.2.	Particulate trap monitoring: ...
3.2.12.2.7.3.2.3.	Electronic fuelling system monitoring: ...
3.2.12.2.7.3.2.5.	Other components monitored by the OBD system: ...
3.2.12.2.7.4.	Criteria for MI activation (fixed number of driving cycles or statistical method): ...
3.2.12.2.7.5.	List of all OBD output codes and formats used (with explanation of each): ...
3.2.12.2.7.6.	The following additional information shall be provided by the vehicle manufacturer for the purposes of enabling the manufacture of OBD-compatible replacement or service parts and diagnostic tools and test equipment.
3.2.12.2.7.6.1.	A description of the type and number of the preconditioning cycles used for the original type approval of the vehicle.
3.2.12.2.7.6.2.	A description of the type of the OBD demonstration cycle used for the original type-approval of the vehicle for the component monitored by the OBD system.
3.2.12.2.7.6.3.	A comprehensive document describing all sensed components with the strategy for fault detection and MI activation (fixed number of driving cycles or statistical method), including a list of relevant secondary sensed parameters for each component monitored

Status: Point in time view as at 01/06/2017.

Changes to legislation: There are outstanding changes not yet made to Commission Regulation (EU) 2017/1151. Any changes that have already been made to the legislation appear in the content and are referenced with annotations. (See end of Document for details)

					by the OBD system. A list of all OBD output codes and format used (with an explanation of each) associated with individual emission related power-train components and individual non-emission related components, where monitoring of the component is used to determine MI activation, including in particular a comprehensive explanation for the data given in service \$05 Test ID \$21 to FF and the data given in service \$06. In the case of vehicle types that use a communication link in accordance with ISO 15765-4 'Road vehicles, diagnostics on controller area network (CAN) — Part 4: requirements for emissions-related systems', a comprehensive explanation for the data given in service \$06 Test ID \$00 to FF, for each OBD monitor ID supported, shall be provided.		
3.2.12.2.7.6.4.	The information required above may be defined by completing a table as described below.						
3.2.12.2.7.6.4.1.	Light-duty vehicles						
Component	Fault code	Monitoring strategy	Fault detection criteria	MI activation criteria	Secondary parameters	Preconditioning	Demonstration test
Catalyst	P0420	Oxygen sensor 1 and sensor 2 signals	Difference between sensor 1 and sensor 2 signals-	3rd cycle	Engine speed load, A/F mode, catalyst temperature	Two type I cycles	Type I
3.2.12.2.8.	Other system: ...						
3.2.12.2.8.2.	Driver inducement system						
3.2.12.2.8.2.3.	Type of inducement system: no engine restart after countdown/no start after refuelling/fuel-lockout/performance restriction						
3.2.12.2.8.2.4.	Description of the inducement system						
3.2.12.2.8.2.5.	Equivalent to the average driving range of the vehicle with a complete tank of fuel: ... km						
3.2.12.2.10.	Periodically regenerating system: (provide the information below for each separate unit)						
3.2.12.2.10.1.	Method or system of regeneration, description and/or drawing: ...						

Status: Point in time view as at 01/06/2017.

Changes to legislation: There are outstanding changes not yet made to Commission Regulation (EU) 2017/1151. Any changes that have already been made to the legislation appear in the content and are referenced with annotations. (See end of Document for details)

3.2.12.2.10.2.	The number of Type 1 operating cycles, or equivalent engine test bench cycles, between two cycles where regenerative phases occur under the conditions equivalent to Type 1 test (Distance 'D' in Figure A6.App1/1 in Appendix 1 to Sub-Annex 6 of Annex XXI to Regulation (EU) 2017/1151 or figure A13/1 in Annex 13 to UN/ECE Regulation 83 (as applicable)): ...
3.2.12.2.10.2.1.	Applicable Type 1 cycle (indicate the applicable procedure: Annex XXI, Sub-Annex 4 or UN/ECE Regulation 83): ...
3.2.12.2.10.3.	Description of method employed to determine the number of cycles between two cycles where regenerative phases occur: ...
3.2.12.2.10.4.	Parameters to determine the level of loading required before regeneration occurs (i.e. temperature, pressure etc.): ...
3.2.12.2.10.5.	Description of method used to load system in the test procedure described in paragraph 3.1., Annex 13 to UN/ECE Regulation 83: ...
3.2.12.2.11.	Catalytic converter systems using consumable reagents (provide the information below for each separate unit) yes/no ⁽¹⁾
3.2.12.2.11.1.	Type and concentration of reagent needed: ...
3.2.12.2.11.2.	Normal operational temperature range of reagent: ...
3.2.12.2.11.3.	International standard: ...
3.2.12.2.11.4.	Frequency of reagent refill: continuous/maintenance (where appropriate):
3.2.12.2.11.5.	Reagent indicator: (description and location)
3.2.12.2.11.6.	Reagent tank
3.2.12.2.11.6.1.	Capacity: ...
3.2.12.2.11.6.2.	Heating system: yes/no
3.2.12.2.11.6.2.1.	Description or drawing
3.2.12.2.11.7.	Reagent control unit: yes/no ⁽¹⁾
3.2.12.2.11.7.1.	Make: ...
3.2.12.2.11.7.2.	Type: ...
3.2.12.2.11.8.	Reagent injector (make type and location): ...
3.2.13.	Smoke opacity

Status: Point in time view as at 01/06/2017.

Changes to legislation: There are outstanding changes not yet made to Commission Regulation (EU) 2017/1151. Any changes that have already been made to the legislation appear in the content and are referenced with annotations. (See end of Document for details)

3.2.13.1.	Location of the absorption coefficient symbol (compression ignition engines only): ...
3.2.14.	Details of any devices designed to influence fuel economy (if not covered by other items):.
3.2.15.	LPG fuelling system: yes/no ⁽¹⁾
3.2.15.1.	Type-approval number according to Regulation (EC) No 661/2009 (OJ L 200, 31.7.2009, p. 1): ...
3.2.15.2.	Electronic engine management control unit for LPG fuelling
3.2.15.2.1.	Make(s): ...
3.2.15.2.2.	Type(s): ...
3.2.15.2.3.	Emission-related adjustment possibilities: ...
3.2.15.3.	Further documentation
3.2.15.3.1.	Description of the safeguarding of the catalyst at switch-over from petrol to LPG or back: ...
3.2.15.3.2.	System lay-out (electrical connections, vacuum connections compensation hoses, etc.): ...
3.2.15.3.3.	Drawing of the symbol: ...
3.2.16.	NG fuelling system: yes/no ⁽¹⁾
3.2.16.1.	Type-approval number according to Regulation (EC) No 661/2009: ...
3.2.16.2.	Electronic engine management control unit for NG fuelling
3.2.16.2.1.	Make(s): ...
3.2.16.2.2.	Type(s): ...
3.2.16.2.3.	Emission-related adjustment possibilities: ...
3.2.16.3.	Further documentation
3.2.16.3.1.	Description of the safeguarding of the catalyst at switch-over from petrol to NG or back: ...
3.2.16.3.2.	System lay-out (electrical connections, vacuum connections compensation hoses, etc.): ...
3.2.16.3.3.	Drawing of the symbol: ...
3.2.18.	Hydrogen fuelling system: yes/no ⁽¹⁾

Status: Point in time view as at 01/06/2017.

Changes to legislation: There are outstanding changes not yet made to Commission Regulation (EU) 2017/1151. Any changes that have already been made to the legislation appear in the content and are referenced with annotations. (See end of Document for details)

3.2.18.1.	EC type-approval number in accordance with Regulation (EC) No 79/2009: ...
3.2.18.2.	Electronic engine management control unit for hydrogen fuelling
3.2.18.2.1.	Make(s): ...
3.2.18.2.2.	Type(s): ...
3.2.18.2.3.	Emission-related adjustment possibilities: ...
3.2.18.3.	Further documentation
3.2.18.3.1.	Description of the safeguarding of the catalyst at switch-over from petrol to hydrogen or back: ...
3.2.18.3.2.	System lay-out (electrical connections, vacuum connections compensation hoses, etc.): ...
3.2.18.3.3.	Drawing of the symbol: ...
3.2.19.4.	Further documentation
3.2.19.4.1.	Description of the safeguarding of the catalyst at switch-over from petrol to H ₂ NG or back: ...
3.2.19.4.2.	System lay-out (electrical connections, vacuum connections compensation hoses, etc.): ...
3.2.19.4.3.	Drawing of the symbol: ...
3.2.20.	Heat storage information
3.2.20.1.	Active heat storage device: yes/no ⁽¹⁾
3.2.20.1.1.	Enthalpy: ... (J)
3.2.20.2.	Insulation materials
3.2.20.2.1.	Insulation material: ...
3.2.20.2.2.	Insulation volume: ...
3.2.20.2.3.	Insulation weight: ...
3.2.20.2.4.	Insulation location: ...
3.3.	Electric machine
3.3.1.	Type (winding, excitation): ...
3.3.1.2.	Operating voltage: ... V
3.4.	Combinations of propulsion energy converters
3.4.1.	Hybrid electric vehicle: yes/no ⁽¹⁾

Status: Point in time view as at 01/06/2017.

Changes to legislation: There are outstanding changes not yet made to Commission Regulation (EU) 2017/1151. Any changes that have already been made to the legislation appear in the content and are referenced with annotations. (See end of Document for details)

3.4.2.	Category of hybrid electric vehicle: off-vehicle charging/not off-vehicle charging: ⁽¹⁾
3.4.3.	Operating mode switch: with/without ⁽¹⁾
3.4.3.1.	Selectable modes
3.4.3.1.1.	Pure electric: yes/no ⁽¹⁾
3.4.3.1.2.	Pure fuel consuming: yes/no ⁽¹⁾
3.4.3.1.3.	Hybrid modes: yes/no ⁽¹⁾ (if yes, short description): ...
3.4.4.	Description of the energy storage device: (REESS, capacitor, flywheel/generator)
3.4.4.1.	Make(s): ...
3.4.4.2.	Type(s): ...
3.4.4.3.	Identification number: ...
3.4.4.4.	Kind of electrochemical couple: ...
3.4.4.5.	Energy: ... (for REESS: voltage and capacity Ah in 2 h, for capacitor: J, ...)
3.4.4.6.	Charger: on board/external/without ⁽¹⁾
3.4.5.	Electric machine (describe each type of electric machine separately)
3.4.5.1.	Make: ...
3.4.5.2.	Type: ...
3.4.5.3.	Primary use: traction motor/generator ⁽¹⁾
3.4.5.3.1.	When used as traction motor: single-/multimotors (number) ⁽¹⁾ : ...
3.4.5.4.	Maximum power: ... kW
3.4.5.5.	Working principle
3.4.5.5.1	Direct current/alternating current/number of phases: ...
3.4.5.5.2.	Separate excitation/series/compound ⁽¹⁾
3.4.5.5.3.	Synchronous/asynchronous ⁽¹⁾
3.4.6.	Control unit
3.4.6.1.	Make(s): ...
3.4.6.2.	Type(s): ...
3.4.6.3.	Identification number: ...
3.4.7.	Power controller

Status: Point in time view as at 01/06/2017.

Changes to legislation: There are outstanding changes not yet made to Commission Regulation (EU) 2017/1151. Any changes that have already been made to the legislation appear in the content and are referenced with annotations. (See end of Document for details)

3.4.7.1.	Make: ...
3.4.7.2.	Type: ...
3.4.7.3.	Identification number: ...
3.4.9.	Manufacturer's recommendation for preconditioning: ...
3.5.	Manufacturer's declared values for determination of CO ₂ emissions/fuel consumption/electric consumption/electric range and details of eco-innovations (where applicable) (°)
3.5.7.	Manufacturer's declared values
3.5.7.1.	Test vehicle parameters
3.5.7.1.1	Vehicle high
3.5.7.1.1.1.	Cycle Energy Demand (J): ...
3.5.7.1.1.2.	Road load coefficients
3.5.7.1.1.2.1.	f ₀ , N: ...
3.5.7.1.1.2.2.	f ₁ , N/(km/h): ...
3.5.7.1.1.2.3.	f ₂ , N/(km/h) ² : ...
3.5.7.1.2.	Vehicle Low (if applicable)
3.5.7.1.2.1.	Cycle Energy Demand (J)
3.5.7.1.2.2.	Road load coefficients
3.5.7.1.2.2.1.	f ₂ , N: ...
3.5.7.1.2.2.2.	f ₁ , N/(km/h): ...
3.5.7.1.2.2.3.	f ₂ , N/(km/h) ² : ...
3.5.7.1.3.	Vehicle M (if applicable)
3.5.7.1.3.1.	Cycle Energy Demand (J)
3.5.7.1.3.2.	Road load coefficients
3.5.7.1.3.2.1.	f ₀ , N: ...
3.5.7.1.3.2.2.	f ₁ , N/(km/h): ...
3.5.7.1.3.2.3.	f ₂ , N/(km/h) ² : ...
3.5.7.2.	Combined CO ₂ mass emissions
3.5.7.2.1.	CO ₂ mass emission for ICE
3.5.7.2.1.1.	Vehicle High: ... g/km
3.5.7.2.1.2.	Vehicle low (if applicable): ... g/km

Status: Point in time view as at 01/06/2017.

Changes to legislation: There are outstanding changes not yet made to Commission Regulation (EU) 2017/1151. Any changes that have already been made to the legislation appear in the content and are referenced with annotations. (See end of Document for details)

3.5.7.2.2.	Charge Sustaining CO ₂ mass emission for OVC-HEVs and NOVC-HEVs
3.5.7.2.2.1.	Vehicle high: ... g/km
3.5.7.2.2.2.	Vehicle low (if applicable): ... g/km
3.5.7.2.2.3.	Vehicle M (if applicable): ... g/km
3.5.7.2.3.	Charge Depleting CO ₂ mass emission for OVC-HEVs
3.5.7.2.3.1.	Vehicle high: ... g/km
3.5.7.2.3.2.	Vehicle low (if applicable): ... g/km
3.5.7.2.3.3.	Vehicle M (if applicable): ... g/km
3.5.7.3.	Electric range for electrified vehicles
3.5.7.3.1.	Pure Electric Range (PER) for PEVs
3.5.7.3.1.1.	Vehicle high: ... km
3.5.7.3.1.2.	Vehicle low (if applicable): ... km
3.5.7.3.2.	All Electric Range AER for OVC-HEVs
3.5.7.3.2.1.	Vehicle high: ... km
3.5.7.3.2.2.	Vehicle low (if applicable): ... km
3.5.7.3.2.3.	Vehicle M (if applicable): ... km
3.5.7.4.	Charge Sustaining fuel consumption (FC _{CS}) for FCHVs
3.5.7.4.1.	Vehicle high: ... kg/100 km
3.5.7.4.2.	Vehicle low (if applicable): ... kg/100 km
3.5.7.4.3.	Vehicle M (if applicable): ... kg/100 km
3.5.7.5.	Electric energy consumption for electrified vehicles
3.5.7.5.1.	Combined electric energy consumption (EC _{WLTC}) for Pure electric vehicles
3.5.7.5.1.1.	Vehicle high: ... Wh/km
3.5.7.5.1.2.	Vehicle low (if applicable): ... Wh/km
3.5.7.5.2.	UF-weighted charge-depleting electric consumption EC _{AC,CD} (combined)
3.5.7.5.2.1.	Vehicle high: ... Wh/km
3.5.7.5.2.2.	Vehicle low (if applicable): ... Wh/km
3.5.7.5.2.3.	Vehicle M (if applicable): ... Wh/km
3.5.8.	Vehicle fitted with an eco-innovation within the meaning of Article 12 of Regulation (EC) No 443/2009 for M1 vehicles or Article 12

Status: Point in time view as at 01/06/2017.

Changes to legislation: There are outstanding changes not yet made to Commission Regulation (EU) 2017/1151. Any changes that have already been made to the legislation appear in the content and are referenced with annotations. (See end of Document for details)

	of Regulation (EU) No 510/2011 for N1 vehicles: yes/no ⁽¹⁾
3.5.8.1.	Type/Variant/Version of the baseline vehicle as referred to in Article 5 of Regulation (EU) No 725/2011 for M1 vehicles or Article 5 of Regulation (EU) No 427/2014 for N1 vehicles (if applicable): ...
3.5.8.2.	Existence of interactions between different eco-innovations: yes/no ⁽¹⁾
3.5.8.3.	Emissions data related to the use of eco-innovations (repeat the table for each reference fuel tested) ^(w1)

Decision approving the eco-innovation ^(w2)	Code of the eco-innovation ^(w3)	1. CO ₂ emissions of the baseline vehicle (g/km)	2. CO ₂ emissions of the eco-innovation vehicle (g/km)	3. CO ₂ emissions of the baseline vehicle under type 1 test-cycle ^(w4)	4. CO ₂ emissions of the eco-innovation vehicle under type 1 test-cycle	5. Usage factor (UF), i.e. temporal share of technology usage in normal operation conditions	CO ₂ emissions savings ((1 – 2) – (3 – 4))*5
xxxx/201x							
Total CO ₂ emissions saving (g/km) ^(w5)							

(w) Eco-innovations.

(w1) Expand the table if necessary, using one extra row per eco-innovation.

(w2) Number of the Commission Decision approving the eco-innovation.

(w3) Assigned in the Commission Decision approving the eco-innovation.

(w4) Under agreement of the type-approval authority, if a modelling methodology is applied instead of the type 1 test cycle, this value shall be the one provided by the modelling methodology.

(w5) Sum of the CO₂ emissions savings of each individual eco-innovation.

3.6.	Temperatures permitted by the manufacturer
3.6.1.	Cooling system
3.6.1.1.	Liquid cooling Maximum temperature at outlet: ... K
3.6.1.2.	Air cooling
3.6.1.2.1.	Reference point: ...

Status: Point in time view as at 01/06/2017.

Changes to legislation: There are outstanding changes not yet made to Commission Regulation (EU) 2017/1151. Any changes that have already been made to the legislation appear in the content and are referenced with annotations. (See end of Document for details)

3.6.1.2.2.	Maximum temperature at reference point: ... K
3.6.2.	Maximum outlet temperature of the inlet intercooler: ... K
3.6.3.	Maximum exhaust temperature at the point in the exhaust pipe(s) adjacent to the outer flange(s) of the exhaust manifold or turbocharger: ... K
3.6.4.	Fuel temperature Minimum: ... K — maximum: ... K For diesel engines at injection pump inlet, for gas fuelled engines at pressure regulator final stage
3.6.5.	Lubricant temperature Minimum: ... K — maximum: ... K
3.8.	Lubrication system
3.8.1.	Description of the system
3.8.1.1.	Position of lubricant reservoir: ...
3.8.1.2.	Feed system (by pump/injection into intake/mixing with fuel, etc.) (¹)
3.8.2.	Lubricating pump
3.8.2.1.	Make(s): ...
3.8.2.2.	Type(s): ...
3.8.3.	Mixture with fuel
3.8.3.1.	Percentage: ...
3.8.4.	Oil cooler: yes/no (¹)
3.8.4.1.	Drawing(s): ... or
3.8.4.1.1.	Make(s): ...
3.8.4.1.2.	Type(s): ...
4	TRANSMISSION (^P)
4.3.	Moment of inertia of engine flywheel: ...
4.3.1.	Additional moment of inertia with no gear engaged: ...
4.4.	Clutch(es)
4.4.1.	Type: ...
4.4.2.	Maximum torque conversion: ...
4.5.	Gearbox

Status: Point in time view as at 01/06/2017.

Changes to legislation: There are outstanding changes not yet made to Commission Regulation (EU) 2017/1151. Any changes that have already been made to the legislation appear in the content and are referenced with annotations. (See end of Document for details)

4.5.1.	Type (manual/automatic/CVT (continuously variable transmission)) ⁽¹⁾
4.5.1.1.	Predominant mode: yes/no ⁽¹⁾
4.5.1.2.	Best mode (if no predominant mode): ...
4.5.1.3.	Worst mode (if no predominant mode): ...
4.5.1.4.	Torque rating: ...
4.5.1.5.	Number of clutches: ...
4.6.	Gear ratios

Gear	Internal gearbox ratios (ratios of engine to gearbox output shaft revolutions)	Final drive ratio(s) (ratio of gearbox output shaft to driven wheel revolutions)	Total gear ratios
Maximum for CVT			
1			
2			
3			
...			
Minimum for CVT			
Reverse			

4.7.	Maximum vehicle design speed (in km/h) ⁽⁹⁾ : ...
6	SUSPENSION
6.6.	Tyres and wheels
6.6.1.	Tyre/wheel combination(s)
6.6.1.1.	Axles
6.6.1.1.1.	Axle 1: ...
6.6.1.1.1.1.	Tyre size designation
6.6.1.1.2.	Axle 2: ...
6.6.1.1.2.1.	Tyre size designation
	etc.
6.6.2.	Upper and lower limits of rolling radii
6.6.2.1.	Axle 1: ...
6.6.2.2.	Axle 2: ...
6.6.3.	Tyre pressure(s) as recommended by the vehicle manufacturer: ... kPa

Status: Point in time view as at 01/06/2017.

Changes to legislation: There are outstanding changes not yet made to Commission Regulation (EU) 2017/1151. Any changes that have already been made to the legislation appear in the content and are referenced with annotations. (See end of Document for details)

9	BODYWORK
9.1.	Type of bodywork using the codes defined in Part C of Annex II of Directive 2007/46/EC: ...
9.10.3.	Seats
9.10.3.1.	Number of seating positions (s): ...
16	ACCESS TO VEHICLE REPAIR AND MAINTENANCE INFORMATION
16.1.	Address of principal website for access to vehicle repair and maintenance information: ...
16.1.1.	Date from which it is available (no later than 6 months from the date of type-approval): ...
16.2.	Terms and conditions of access to website: ...
16.3.	Format of the vehicle repair and maintenance information accessible through website: ...

Appendix to
information document

INFORMATION ON TEST CONDITIONS

1. Lubricants used

1.1. Engine lubricant

1.1.1. Make: ...

1.1.2. Type: ...

1.2. Gearbox lubricant

1.2.1. Make: ...

1.2.2. Type: ...

(state percentage of oil in mixture if lubricant and fuel mixed)

2. Road load information

2.1. Gearbox type (manual/automatic/CVT)

VL (if existing)	VH
2.2. Vehicle bodywork type (variant/version)	2.2. Vehicle bodywork type (variant/version)

Status: Point in time view as at 01/06/2017.

Changes to legislation: There are outstanding changes not yet made to Commission Regulation (EU) 2017/1151. Any changes that have already been made to the legislation appear in the content and are referenced with annotations. (See end of Document for details)

2.3.	Road load method used (measurement or calculation by road load family)	2.3.	Road load method used (measurement or calculation by road load family)
2.4.	Road load information from the test	2.4.	Road load information from the test
2.4.1.	Tyres make and type:	2.4.1.	Tyres make and type:
2.4.2.	Tyre dimensions (front/rear):	2.4.2.	Tyre dimensions (front/rear):
2.4.4.	Tyre pressure (front/rear) (kPa):	2.4.4.	Tyre pressure (front/rear) (kPa):
2.4.5.	Tyre rolling resistance (front/rear) (kg/t):	2.4.5.	Tyre rolling resistance (front/rear) (kg/t):
2.4.6.	Vehicle test mass (kg):	2.4.6.	Vehicle test mass (kg):
2.4.7.	Delta Cd.A compared to VH (m ²)		
2.4.8.	Road load coefficient f ₀ , f ₁ , f ₂	2.4.8.	Road load coefficient f ₀ , f ₁ , f ₂

Appendix 4

MODEL OF EC TYPE-APPROVAL CERTIFICATE (Maximum format: A4 (210 × 297 mm))

EC TYPE-APPROVAL CERTIFICATE

Stamp of administration

Communication concerning the:

- EC type-approval ⁽¹⁾,
- extension of EC type-approval ⁽¹⁾,
- refusal of EC type-approval ⁽¹⁾,
- withdrawal of EC type-approval ⁽¹⁾,
- of a type of system/type of a vehicle with regard to a system ⁽¹⁾ with regard to Regulation (EC) No 715/2007 ⁽²⁾ and Regulation (EU) 2017/1151 ⁽³⁾

EC type-approval number: ...

Reason for extension: ...

SECTION 0.1.

I Make (trade name of manufacturer): ...

0.2. Type: ...

0.2.1. Commercial name(s) (if available): ...

Status: Point in time view as at 01/06/2017.

Changes to legislation: There are outstanding changes not yet made to Commission Regulation (EU) 2017/1151. Any changes that have already been made to the legislation appear in the content and are referenced with annotations. (See end of Document for details)

- 0.3. Means of identification of type if marked on the vehicle ⁽⁴⁾
- 0.3.1. Location of that marking: ...
- 0.4. Category of vehicle ⁽⁵⁾
- 0.5. Name and address of manufacturer: ...
- 0.8. Name(s) and address(es) of assembly plant(s): ...
- 0.9. Representative of the manufacturer: ...

SECTION II —

to be repeated for each interpolation family, as defined in paragraph 5.6. of Annex XXI

- 0. Interpolation family identifier as defined in paragraph 5.0 of Annex XXI
- 1. Additional information (where applicable): (see addendum)
- 2. Technical service responsible for carrying out the tests: ...
- 3. Date of type 1 test report: ...
- 4. Number of the type 1 test report: ...
- 5. Remarks (if any): (see addendum)
- 6. Place: ...
- 7. Date: ...
- 8. Signature: ...

<i>Attachments:</i>	Information package ⁽⁶⁾ .
---------------------	--------------------------------------

Addendum to EC type-approval certificate No ...

concerning the type-approval of a vehicle with regard to emissions and access to vehicle repair and maintenance information according to Regulation (EC) No 715/2007

Cross references to information in Test Report or Information Document should be avoided when completing the TA certificate.

- 0. INTERPOLATION FAMILY IDENTIFIER AS DEFINED IN PARAGRAPH 5.0 OF ANNEX XXI
- 1. ADDITIONAL INFORMATION
 - 1.1. Mass of the vehicle in running order: ...
 - 1.2. Maximum mass: ...
 - 1.3. Reference mass: ...

Status: Point in time view as at 01/06/2017.

Changes to legislation: There are outstanding changes not yet made to Commission Regulation (EU) 2017/1151. Any changes that have already been made to the legislation appear in the content and are referenced with annotations. (See end of Document for details)

- 1.4. Number of seats: ...
- 1.6. Type of bodywork:
 - 1.6.1. for M1, M2: saloon, hatchback, station wagon, coupé, convertible, multipurpose vehicle⁽¹²⁾
 - 1.6.2. for N1, N2: lorry, van⁽¹²⁾
- 1.7. Drive wheels: front, rear, 4×4 ⁽¹²⁾
- 1.8. Pure electric vehicle: yes/no⁽¹²⁾
- 1.9. Hybrid electric vehicle: yes/no⁽¹²⁾
 - 1.9.1. Category of Hybrid Electric vehicle: Off Vehicle Charging/Not Off Vehicle charging / Fuel Cell⁽¹²⁾
 - 1.9.2. Operating mode switch: with/without⁽¹²⁾
- 1.10. Engine identification:
 - 1.10.1. Engine displacement:
 - 1.10.2. Fuel supply system: direct injection/indirect injection⁽¹²⁾
 - 1.10.3. Fuel recommended by the manufacturer:
 - 1.10.4.1. Maximum power: kW at min^{-1}
 - 1.10.4.2. Maximum torque: Nm at min^{-1}
 - 1.10.5. Pressure charging device: yes/no⁽¹²⁾
 - 1.10.6. Ignition system: compression ignition/positive ignition⁽¹²⁾
- 1.11. Power train (for pure electric vehicle or hybrid electric vehicle)⁽¹²⁾
 - 1.11.1. Maximum net power: ... kW, at: ... to ... min^{-1}
 - 1.11.2. Maximum thirty minutes power: ... kW
 - 1.11.3. Maximum net torque: ... Nm, at ... min^{-1}
- 1.12. Traction battery (for pure electric vehicle or hybrid electric vehicle)
 - 1.12.1. Nominal voltage: V
 - 1.12.2. Capacity (2 h rate): Ah
- 1.13. Transmission: ..., ...
 - 1.13.1. Type of gearbox: manual/automatic/variable transmission⁽¹²⁾
 - 1.13.2. Number of gear ratios:
 - 1.13.3. Total gear ratios (including the rolling circumferences of the tyres under load): (vehicle speed (km/h)) / (engine speed (1 000 (min^{-1})))

Status: Point in time view as at 01/06/2017.

Changes to legislation: There are outstanding changes not yet made to Commission Regulation (EU) 2017/1151. Any changes that have already been made to the legislation appear in the content and are referenced with annotations. (See end of Document for details)

First gear: ...	Sixth gear: ...
Second gear: ...	Seventh gear: ...
Third gear: ...	Eighth gear: ...
Fourth gear: ...	Overdrive: ...
Fifth gear: ...	

1.13.4. Final drive ratio:

1.14. Tyres: ..., ..., ...

Type: radial/bias/...⁽¹³⁾

Dimensions: ...

Rolling circumference under load:

Rolling circumference of tyres used for the Type 1 test

2. TEST RESULTS

2.1. Tailpipe emissions test results

Emissions classification: Euro 6

Type 1 test results, where applicable

Type approval number if not parent vehicle⁽¹²⁾: ...

Test 1

Type 1 Result	CO(mg/km)	THC(mg/km)	NMHC(mg/km)	NO _x (mg/km)	THC + NO _x (mg/km)	PM(mg/km)	PN(#.10 ¹¹ /km)
Measured ⁽⁸⁾ ⁽⁹⁾							
Ki (*) ⁽⁸⁾ ⁽¹⁰⁾					⁽¹¹⁾		
Ki (+) ⁽⁸⁾ ⁽¹⁰⁾					⁽¹¹⁾		
Mean value calculated with Ki (M.Ki or M+Ki) ⁽⁹⁾					⁽¹²⁾		
DF (+) ⁽⁸⁾ ⁽¹⁰⁾							

Status: Point in time view as at 01/06/2017.

Changes to legislation: There are outstanding changes not yet made to Commission Regulation (EU) 2017/1151. Any changes that have already been made to the legislation appear in the content and are referenced with annotations. (See end of Document for details)

DF (*) ⁽⁸⁾ (¹⁰)							
Final mean value calculated with Ki and DF ⁽¹³⁾							
Limit value							

Test 2 (if applicable)

Repeat Test 1 table with the second test results.

Test 3 (if applicable)

Repeat Test 1 table with the third test results.

Repeat Test 1, test 2 (if applicable) and test 3 (if applicable) for Vehicle Low (if applicable), and VM (if applicable)

Information about regeneration strategy

- D — number of operating cycles between 2 cycles where regenerative phases occur: ...
- d — number of operating cycles required for regeneration: ...

Applicable Type 1 cycle: (Annex XXI, Sub-Annex 4 or UN/ECE Regulation No 83)⁽¹⁴⁾: ...

ATCT TEST

CO ₂ Emission (g/km)	Combined
ATCT (14 °C) M _{CO2,Treg}	
Type 1 (23 °C) M _{CO2,23°}	
Family correction factor (FCF)	

Difference between engine coolant end temperature and average soak area temperature of the last 3 hours ΔT_{ATCT} (°C): ...

The minimum soaking time t_{soak_ATCT} (s): ...

Location of temperature sensor: ...

Type 2: (including data required for roadworthiness testing):

Test	CO value(% vol)	Lambda (⁷)	Engine speed(min ⁻¹)	Engine oil temperature(°C)
Low idle test		N/A		
High idle test				

Status: Point in time view as at 01/06/2017.

Changes to legislation: There are outstanding changes not yet made to Commission Regulation (EU) 2017/1151. Any changes that have already been made to the legislation appear in the content and are referenced with annotations. (See end of Document for details)

Type 3: ...

Type 4: ... g/test

Type 5 : — Durability test: whole vehicle test/bench ageing test/none⁽¹²⁾
 — Deterioration factor DF: calculated/assigned⁽¹²⁾
 — Specify the values: ...
 — Applicable Type 1 cycle (Annex XXI, Sub-Annex 4 or UN/ECE Regulation No 83)⁽¹⁴⁾: ...

Type 6	CO (g/km)	THC (g/km)
Measured value		

2.1.1. For bi fuel vehicles, the type 1 table shall be repeated for both fuels. For flex fuel vehicles, when the type 1 test is to be performed on both fuels according to Figure I.2.4 of Annex I, and for vehicles running on LPG or NG/Biomethane, either mono fuel or bi fuel, the table shall be repeated for the different reference gases used in the test, and an additional table shall display the worst results obtained. When applicable, in accordance with section 3.1.4 of Annex 12 to UN/ECE Regulation No 83, it shall be shown if the results are measured or calculated.

2.1.2. Written description and/or drawing of the MI: ...

2.1.3. List and function of all components monitored by the OBD system: ...

2.1.4. Written description (general working principles) for: ...

2.1.4.1. Misfire detection⁽¹⁵⁾: ...

2.1.4.2. Catalyst monitoring⁽¹⁵⁾: ...

2.1.4.3. Oxygen sensor monitoring⁽¹⁵⁾: ...

2.1.4.4. Other components monitored by the OBD system⁽¹⁵⁾: ...

2.1.4.5. Catalyst monitoring⁽¹⁶⁾: ...

2.1.4.6. Particulate trap monitoring⁽¹⁶⁾: ...

2.1.4.7. Electronic fuelling system actuator monitoring⁽¹⁶⁾: ...

2.1.4.8. Other components monitored by the OBD system: ...

2.1.5. Criteria for MI activation (fixed number of driving cycles or statistical method): ...

2.1.6. List of all OBD output codes and formats used (with explanation of each): ...

2.2. Reserved

2.3. Catalytic converters yes/no⁽¹²⁾

2.3.1. Original equipment catalytic converter tested to all relevant requirements of this Regulation yes/no⁽¹²⁾

2.4. Smoke opacity test results⁽¹²⁾

Status: Point in time view as at 01/06/2017.

Changes to legislation: There are outstanding changes not yet made to Commission Regulation (EU) 2017/1151. Any changes that have already been made to the legislation appear in the content and are referenced with annotations. (See end of Document for details)

- 2.4.1. At steady engine speeds: See technical service test report number: ...
- 2.4.2. Free acceleration tests
 - 2.4.2.1. Measured value of the absorption coefficient: ... m⁻¹
 - 2.4.2.2. Corrected value of the absorption coefficient: ... m⁻¹
 - 2.4.2.3. Location of the absorption coefficient symbol on the vehicle: ...
- 2.5. CO₂ emissions and fuel consumption test results
 - 2.5.1. Internal combustion engine vehicle and Not Externally Chargeable (NOVC) Hybrid Electric Vehicle
 - 2.5.1.1. Vehicle High
 - 2.5.1.1.1. Cycle Energy Demand: ... J
 - 2.5.1.1.2. Road load coefficients
 - 2.5.1.1.2.1. f_0 , N: ...
 - 2.5.1.1.2.2. f_1 , N/(km/h): ...
 - 2.5.1.1.2.3. f_2 , N/(km/h)²: ...
 - 2.5.1.1.3. CO₂ mass emissions (provide values for each reference fuel tested, for the phases: the measured values, for the combined see paragraphs 1.1.2.3.8 and 1.1.2.3.9 of Sub-Annex 6 to Annex XXI)

CO ₂ Emission (g/km)	Test	Low	Medium	High	Extra High	Combined
M _{CO₂,p,5} / M _{CO₂,c,5}	1					
	2					
	3					
M _{CO₂,p,H} / M _{CO₂,c,H}						

- 2.5.1.1.4. Fuel consumption (provide values for each reference fuel tested, for the phases: the measured values for the combined see paragraphs 1.1.2.3.8 and 1.1.2.3.9 of Sub-Annex 6 to Annex XXI)

Fuel consumption (l/100 km) or m ³ /100 km or kg/100 km (1)	Low	Medium	High	Extra High	Combined

Status: Point in time view as at 01/06/2017.

Changes to legislation: There are outstanding changes not yet made to Commission Regulation (EU) 2017/1151. Any changes that have already been made to the legislation appear in the content and are referenced with annotations. (See end of Document for details)

Final values FC _{p,H} / FC _{c,H}					
---	--	--	--	--	--

2.5.1.2. Vehicle Low (if applicable)

2.5.1.2.1. Cycle Energy Demand: ... J

2.5.1.2.2. Road load coefficients

2.5.1.2.2.1. f_0 , N: ...

2.5.1.2.2.2. f_1 , N/(km/h): ...

2.5.1.2.2.3. f_2 , N/(km/h)²: ...

2.5.1.2.2. CO₂ mass emissions (provide values for each reference fuel tested, for the phases: the measured values for the combined see paragraphs 1.1.2.3.8 and 1.1.2.3.9 of Sub-Annex 6 to Annex XXI)

CO ₂ Emission (g/km)	Test	Low	Medium	High	Extra High	Combined
M _{CO2,p,5} / M _{CO2,c,5}	1					
	2					
	3					
M _{CO2,p,L} / M _{CO2,c,L}						

2.5.1.2.3. Fuel consumption (provide values for each reference fuel tested, for the phases: the measured values for the combined see paragraphs 1.1.2.3.8 and 1.1.2.3.9 of Sub-Annex 6 to Annex XXI)

Fuel consumption (l/100 km) or m ³ /100 km or kg/100 km (1)	Low	Medium	High	Extra High	Combined
Final values FC _{p,H} / FC _{c,H}					

2.5.1.3. For vehicles powered by an internal combustion engine only which are equipped with periodically regenerating systems as defined in paragraph 6 of Article 2 of this Regulation, the test results shall be adjusted by the Ki factor as specified in Appendix 1 to Sub-Annex 6 of Annex XXI.

2.5.1.3.1. Information about regeneration strategy for CO₂ emissions and fuel consumption

Status: Point in time view as at 01/06/2017.

Changes to legislation: There are outstanding changes not yet made to Commission Regulation (EU) 2017/1151. Any changes that have already been made to the legislation appear in the content and are referenced with annotations. (See end of Document for details)

D — number of operating cycles between 2 cycles where regenerative phases occur: ...

d — number of operating cycles required for regeneration: ...

Applicable Type 1 cycle (Annex XXI, Sub-Annex 4 or UN/ECE Regulation 83)⁽¹⁴⁾: ...

	Low	Mid	High	Extra High	Combined
Ki (additive / multiplicative) (¹)Values for CO ₂ and fuel consumption (¹⁰)					

2.5.2. Pure electric vehicles⁽¹²⁾

2.5.2.1. Electric energy consumption (declared value)

2.5.2.1.1. Electric energy consumption:

EC (Wh/km)	Test	City	Combined
Calculated EC	1		
	2		
	3		
Declared value	—		

2.5.2.1.2. Total time out of tolerance for the conduct of the cycle: ... sec

2.5.2.2. Pure Electric Range

PER (km)	Test	City	Combined
Measured Pure Electric Range	1		
	2		
	3		
Declared value	—		

2.5.3. Externally chargeable (OVC) Hybrid Electric Vehicle:

2.5.3.1. CO₂ mass emission Charge Sustaining

VEHICLE HIGH

CO ₂ Emission (g/km)	Test	Low	Medium	High	Extra High	Combined

Status: Point in time view as at 01/06/2017.

Changes to legislation: There are outstanding changes not yet made to Commission Regulation (EU) 2017/1151. Any changes that have already been made to the legislation appear in the content and are referenced with annotations. (See end of Document for details)

M _{CO₂,p,5} / M _{CO₂,c,5}	1					
	2					
	3					
M _{CO₂,p,H} / M _{CO₂,c,H}						

VEHICLE LOW (IF APPLICABLE)

CO ₂ Emission (g/km)	Test	Low	Medium	High	Extra High	Combined
M _{CO₂,p,5} / M _{CO₂,c,5}	1					
	2					
	3					
M _{CO₂,p,L} / M _{CO₂,c,L}						

VEHICLE M (IF APPLICABLE)

CO ₂ Emission (g/km)	Test	Low	Medium	High	Extra High	Combined
M _{CO₂,p,5} / M _{CO₂,c,5}	1					
	2					
	3					
M _{CO₂,p,M} / M _{CO₂,c,M}						

2.5.3.2. CO₂ mass emission Charge Depleting

VEHICLE HIGH

CO ₂ Emission (g/km)	Test	Combined
M _{CO₂,CD}	1	
	2	
	3	
M _{CO₂,CD,H}		

VEHICLE LOW (IF APPLICABLE)

CO ₂ Emission (g/km)	Test	Combined
M _{CO₂,CD}	1	
	2	
	3	

Status: Point in time view as at 01/06/2017.

Changes to legislation: There are outstanding changes not yet made to Commission Regulation (EU) 2017/1151. Any changes that have already been made to the legislation appear in the content and are referenced with annotations. (See end of Document for details)

M _{CO2,CD,L}	
-----------------------	--

VEHICLE M (IF APPLICABLE)

CO ₂ Emission (g/km)	Test	Combined
M _{CO2,CD}	1	
	2	
	3	
M _{CO2,CD,M}		

2.5.3.3. CO₂ mass emission (weighted, combined)⁽¹⁷⁾:

Vehicle High: M_{CO2,weighted} ... g/km

Vehicle Low (if applicable): M_{CO2,weighted} ... g/km

Vehicle M (if applicable): M_{CO2,weighted} ... g/km

2.5.3.4. Fuel consumption Charge Sustaining

VEHICLE HIGH

Fuel Consumption (l/100 km)	Low	Medium	High	Extra High	Combined
Final values FC _{p,H} / FC _{c,H}					

VEHICLE LOW (IF APPLICABLE)

Fuel Consumption (l/100 km)	Low	Medium	High	Extra High	Combined
Final values FC _{p,L} / FC _{c,L}					

VEHICLE M (IF APPLICABLE)

Fuel Consumption (l/100 km)	Low	Medium	High	Extra High	Combined
Final values FC _{p,M} / FC _{c,M}					

2.5.3.5. Fuel consumption Charge Depleting

Status: Point in time view as at 01/06/2017.

Changes to legislation: There are outstanding changes not yet made to Commission Regulation (EU) 2017/1151. Any changes that have already been made to the legislation appear in the content and are referenced with annotations. (See end of Document for details)

VEHICLE HIGH

Fuel consumption (l/100 km)	Test	Combined
FC _{CD}	1	
	2	
	3	
FC _{CD,H}		

VEHICLE LOW (IF APPLICABLE)

Fuel consumption (l/100 km)	Test	Combined
FC _{CD}	1	
	2	
	3	
FC _{CD,L}		

VEHICLE M (IF APPLICABLE)

Fuel consumption (l/100 km)	Test	Combined
FC _{CD}	1	
	2	
	3	
FC _{CD,M}		

2.5.3.6. Fuel consumption (weighted, combined)⁽¹⁷⁾:

Vehicle High: FC_{weighted} ... l/100 km

Vehicle Low (if applicable): FC_{weighted} ... l/100 km

Vehicle M (if applicable): FC_{weighted} ... l/100 km

2.5.3.7. Ranges:

2.5.3.7.1. All Electric Range AER

AER (km)	Test	City	Combined
AER values	1		
	2		
	3		
Final values AER			

Status: Point in time view as at 01/06/2017.

Changes to legislation: There are outstanding changes not yet made to Commission Regulation (EU) 2017/1151. Any changes that have already been made to the legislation appear in the content and are referenced with annotations. (See end of Document for details)

2.5.3.7.2. Equivalent All Electric Range EAER

EAER (km)	City	Combined
EAER values		

2.5.3.7.3. Actual Charge Depleting Range R_{CDA}

R _{CDA} (km)	Combined
R _{CDA} values	

2.5.3.7.4. Charge Depleting Cycle Range R_{CDC}

R _{CDC} (km)	Test	Combined
R _{CDC} values	1	
	2	
	3	
Final values R _{CDC}		

2.5.3.8. Electric consumption

2.5.3.8.1. Electric Consumption EC

EC (Wh/km)	Low	Medium	High	Extra High	City	Combined
Electric consumption values						

2.5.3.8.2. UF-weighted charge-depleting electric consumption EC_{AC,CD} (combined)

EC _{AC,CD} (Wh/km)	Test	Combined
EC _{AC,CD} values	1	
	2	
	3	
Final values EC _{AC,CD}		

2.5.3.8.3. UF-weighted electric consumption EC_{AC,weighted} (combined)

EC _{AC,weighted} (Wh/km)	Test	Combined
EC _{AC,weighted} values	1	

Status: Point in time view as at 01/06/2017.

Changes to legislation: There are outstanding changes not yet made to Commission Regulation (EU) 2017/1151. Any changes that have already been made to the legislation appear in the content and are referenced with annotations. (See end of Document for details)

	2	
	3	
Final values EC _{AC,weighted}		

2.6. Test results of eco-innovations⁽¹⁸⁾⁽¹⁹⁾

Decision approving the eco-innovation ⁽²⁰⁾	Code of the eco-innovation ⁽²¹⁾	Type 1/I cycle ⁽²²⁾	1. CO ₂ emissions of the baseline vehicle (g/km)	2. CO ₂ emissions of the eco-innovation vehicle (g/km)	3. CO ₂ emissions of the baseline vehicle under type 1 test-cycle ⁽²³⁾	4. CO ₂ emissions of the eco-innovation vehicle under type 1 test-cycle	5. Usage factor (UF) i.e. temporal share of technology usage in normal operation conditions	CO ₂ emissions savings ((1 - 2) - (3 - 4)) * 5
xxx/201x								
	Total CO ₂ emissions saving on NEDC (g/km) ⁽²⁴⁾							
	Total CO ₂ emissions saving on WLTP (g/km) ⁽²⁵⁾							

2.6.1. General code of the eco-innovation(s)⁽²⁰⁾: ...

3. VEHICLE REPAIR INFORMATION

3.1. Address of website for access to vehicle repair and maintenance information: ...

3.1.1. Date from which it is available (up to 6 months from the date of type approval): ...

3.2. Terms and conditions of access (i.e. duration of access, price of access on an hourly, daily, monthly, annual and per-transaction basis) to websites referred to in point 3.1):
...

3.3. Format of vehicle repair and maintenance information accessible through website referred to in point 3.1: ...

3.4. Manufacturer's certificate on access to vehicle repair and maintenance information provided: ...

4. POWER MEASUREMENT

Maximum engine net power of internal combustion engine, net power and maximum 30 minutes power of electric drive train

Status: Point in time view as at 01/06/2017.

Changes to legislation: There are outstanding changes not yet made to Commission Regulation (EU) 2017/1151. Any changes that have already been made to the legislation appear in the content and are referenced with annotations. (See end of Document for details)

4.1. **Internal combustion engine net power**

- 4.1.1. Engine speed (min^{-1}) ...
- 4.1.2. Measured fuel flow (g/h) ...
- 4.1.3. Measured torque (Nm) ...
- 4.1.4. Measured power (kW) ...
- 4.1.5. Barometric pressure (kPa) ...
- 4.1.6. Water vapour pressure (kPa) ...
- 4.1.7. Intake air temperature (K) ...
- 4.1.8. Power correction factor when applied ...
- 4.1.9. Corrected power (kW) ...
- 4.1.10. Auxiliary power (kW) ...
- 4.1.11. Net power (kW) ...
- 4.1.12. Net torque (Nm) ...
- 4.1.13. Corrected specific fuel consumption (g/kWh) ...

4.2. **Electric drive train(s):**

- 4.2.1. Declared figures
- 4.2.2. Maximum net power: ... kW, at ... min^{-1}
- 4.2.3. Maximum net torque: ... Nm, at ... min^{-1}
- 4.2.4. Maximum net torque at zero engine speed: ... Nm
- 4.2.5. Maximum 30 minutes power: ... kW
- 4.2.6. Essential characteristics of the electric drive train
- 4.2.7. Test DC voltage: ... V
- 4.2.8. Working principle: ...
- 4.2.9. Cooling system:
- 4.2.10. Motor: liquid/air⁽¹²⁾
- 4.2.11. Variator: liquid/air⁽¹²⁾

5. REMARKS: ...

Explanatory Notes

(²) [OJ L 171, 29.6.2007, p. 1.](#)

(³) [OJ L 175, 7.7.2017, p. 1.](#)

Status: Point in time view as at 01/06/2017.

Changes to legislation: There are outstanding changes not yet made to Commission Regulation (EU) 2017/1151. Any changes that have already been made to the legislation appear in the content and are referenced with annotations. (See end of Document for details)

- (⁴) If the means of identification of type contains characters not relevant to describe the vehicle, component or separate technical unit types covered by this information, such characters shall be represented in the documentation by the symbol ‘?’ (e.g. ABC?? 123??)
- (⁵) As defined in Annex II, Section A
- (⁶) As defined in article 3, paragraph 39 of Directive 2007/46/EC
- (⁸) Where applicable.
- (⁹) Round to 2 decimal places
- (¹⁰) Round to 4 decimal places
- (¹¹) Not applicable
- (¹²) Mean value calculated by adding mean values (M.Ki) calculated for THC and NOx.
- (¹³) Round to 1 decimal place more than limit value.
- (²⁰) Number of the Commission Decision approving the eco-innovation.
- (²¹) Assigned in the Commission Decision approving the eco-innovation.
- (²²) Applicable Type 1 cycle: Annex XXI, Sub-Annex 4 or UN/ECE Regulation 83
- (²³) If modelling is applied instead of the type 1 test-cycle, this value shall be the one provided by the modelling methodology.
- (²⁴) Sum of the emissions saving of each individual eco-innovation on Type I according to UN/ECE Regulation 83.
- (²⁵) Sum of the emissions saving of each individual eco-innovation on Type 1 according to Annex XXI, Sub-Annex 4 of this regulation

Appendix to the Addendum to
the Type Approval Certificate

Transitional period (correlation output)

(Transitional provision):

1. CO₂ emissions results from Co2mpas
 - 1.1 Co2mpas version
 - 1.2. Vehicle High
 - 1.2.1. CO₂ mass emissions (for each reference fuel tested)

CO ₂ Emission (g/km)	Urban	Extra Urban	Combined
M _{CO₂,NEDC_H,co2mpas}			

Status: Point in time view as at 01/06/2017.

Changes to legislation: There are outstanding changes not yet made to Commission Regulation (EU) 2017/1151. Any changes that have already been made to the legislation appear in the content and are referenced with annotations. (See end of Document for details)

1.3. Vehicle Low (if applicable)

1.3.1. CO₂ mass emissions (for each reference fuel tested)

CO ₂ Emission (g/km)	Urban	Extra Urban	Combined
M _{CO2,NEDC_L,co2mpas}			

2. CO₂ emissions test results (if applicable)

2.1. Vehicle High

2.1.1. CO₂ mass emissions (for each reference fuel tested)

CO ₂ Emission (g/km)	Urban	Extra Urban	Combined
M _{CO2,NEDC_H,test}			

2.2. Vehicle Low (if applicable)

2.2.1. CO₂ mass emissions (for each reference fuel tested)

CO ₂ Emission (g/km)	Urban	Extra Urban	Combined
M _{CO2,NEDC_L,test}			

3. Deviation factors (determined in accordance with point 3.2.8 of Annex I to Implementing Regulations (EU) 2017/1152 and (EU) 2017/1153)

Deviation factors	Vehicle High	Vehicle Low(if applicable)
De		

Appendix 5

Vehicle OBD information

1. The information required in this Appendix shall be provided by the vehicle manufacturer for the purposes of enabling the manufacture of OBD-compatible replacement or service parts and diagnostic tools and test equipment.
2. Upon request, the following information shall be made available to any interested component, diagnostic tools or test equipment manufacturer, on a non-discriminatory basis:
 - 2.1. A description of the type and number of the preconditioning cycles used for the original type-approval of the vehicle;

Status: Point in time view as at 01/06/2017.

Changes to legislation: There are outstanding changes not yet made to Commission Regulation (EU) 2017/1151. Any changes that have already been made to the legislation appear in the content and are referenced with annotations. (See end of Document for details)

- 2.2. A description of the type of the OBD demonstration cycle used for the original type-approval of the vehicle for the component monitored by the OBD system;
- 2.3. A comprehensive document describing all sensed components with the strategy for fault detection and MI activation (fixed number of driving cycles or statistical method), including a list of relevant secondary sensed parameters for each component monitored by the OBD system and a list of all OBD output codes and format used (with an explanation of each) associated with individual emission-related power-train components and individual non-emission related components, where monitoring of the component is used to determine MI activation. In particular, a comprehensive explanation for the data given in service \$ 05 Test ID \$ 21 to FF and the data given in service \$ 06 shall be provided. In the case of vehicle types that use a communication link in accordance with ISO 15765-4 'Road vehicles — Diagnostics on Controller Area Network (CAN) — Part 4: Requirements for emissions-related systems', a comprehensive explanation for the data given in service \$ 06 Test ID \$ 00 to FF, for each OBD monitor ID supported, shall be provided.

This information may be provided in the form of a table, as follows:

Component	Fault code	Monitoring strategy	Fault detection criteria	MI activation criteria	Secondary parameters	Precondition	Demonstration test
Catalyst	P0420	Oxygen sensor 1 and 2 signals	Difference between sensor 1 and sensor 2 signals	3rd cycle	Engine speed, engine load, A/F mode, catalyst temperature	e.g. Two Type 1 cycles (as described in Annex III of Regulation (EC) No 692/2008 or in Annex XXI to Regulation (EU) 2017/1151)	e.g. Type 1 test (as described in Annex III of Regulation (EC) No 692/2008 or in Annex XXI to Regulation (EU) 2017/1151)

3. INFORMATION REQUIRED FOR THE MANUFACTURE OF DIAGNOSTIC TOOLS

In order to facilitate the provision of generic diagnostic tools for multi-make repairers, vehicle manufacturers shall make available the information referred to in the points 3.1 to 3.3. through their repair information web-sites. This information shall include all diagnostic tool functions and all the links to repair information and troubleshooting instructions. The access to this information may be subject to the payment of a reasonable fee.

3.1. Communication Protocol Information

The following information shall be required indexed against vehicle make, model and variant, or other workable definition such as VIN or vehicle and systems identification:

Status: Point in time view as at 01/06/2017.

Changes to legislation: There are outstanding changes not yet made to Commission Regulation (EU) 2017/1151. Any changes that have already been made to the legislation appear in the content and are referenced with annotations. (See end of Document for details)

- (a) Any additional protocol information system necessary to enable complete diagnostics in addition to the standards prescribed in Section 4 of Annex XI, including any additional hardware or software protocol information, parameter identification, transfer functions, ‘keep alive’ requirements, or error conditions;
- (b) Details of how to obtain and interpret all fault codes not in accordance with the standards prescribed in Section 4 of Annex XI;
- (c) A list of all available live data parameters including scaling and access information;
- (d) A list of all available functional tests including device activation or control and the means to implement them;
- (e) Details of how to obtain all component and status information, time stamps, pending DTC and freeze frames;
- (f) Resetting adaptive learning parameters, variant coding and replacement component setup, and customer preferences;
- (g) ECU identification and variant coding;
- (h) Details of how to reset service lights;
- (i) Location of diagnostic connector and connector details;
- (j) Engine code identification.

3.2. **Test and diagnosis of OBD monitored components**

The following information shall be required:

- (a) A description of tests to confirm its functionality, at the component or in the harness
- (b) Test procedure including test parameters and component information
- (c) Connection details including minimum and maximum input and output and driving and loading values
- (d) Values expected under certain driving conditions including idling
- (e) Electrical values for the component in its static and dynamic states
- (f) Failure mode values for each of the above scenarios
- (g) Failure mode diagnostic sequences including fault trees and guided diagnostics elimination.

3.3. **Data required to perform the repair**

The following information shall be required:

- (a) ECU and component initialisation (in the event of replacements being fitted)
- (b) Initialisation of new or replacement ECUs where relevant using pass-through (re-) programming techniques.

Status: Point in time view as at 01/06/2017.

Changes to legislation: There are outstanding changes not yet made to Commission Regulation (EU) 2017/1151. Any changes that have already been made to the legislation appear in the content and are referenced with annotations. (See end of Document for details)

Appendix 6

EC Type-Approval Certification Numbering System

1. Section 3 of the EC type-approval number issued according to Article 6(1) shall be composed by the number of the implementing regulatory act or the latest amending regulatory act applicable to the EC type-approval. This number shall be followed by one or more characters reflecting the different categories in accordance with Table 1.

Character	Emission standard	OBD standard	Vehicle category and class	Engine	Implementation date: new types	Implementation date: new vehicles	date of registration
AA	Euro 6c	Euro 6-1	M, N1 class I	PI, CI			31.8.2018
AB	Euro 6c	Euro 6-1	N1 class II	PI, CI			31.8.2019
AC	Euro 6c	Euro 6-1	N1 class III, N2	PI, CI			31.8.2019
AD	Euro 6c	Euro 6-2	M, N1 class I	PI, CI		1.9.2018	31.8.2019
AE	Euro 6c	Euro 6-2	N1 class II	PI, CI		1.9.2019	31.8.2020
AF	Euro 6c	Euro 6-2	N1 class III, N2	PI, CI		1.9.2019	31.8.2020
AG	Euro 6d-TEMP	Euro 6-2	M, N1 class I	PI, CI	1.9.2017	1.9.2019	31.12.2020
AH	Euro 6d-TEMP	Euro 6-2	N1 class II	PI, CI	1.9.2018	1.9.2020	31.12.2021
AI	Euro 6d-TEMP	Euro 6-2	N1 class III, N2	PI, CI	1.9.2018	1.9.2020	31.12.2021
AJ	Euro 6d	Euro 6-2	M, N1 class I	PI, CI	1.1.2020	1.1.2021	
AK	Euro 6d	Euro 6-2	N1 class II	PI, CI	1.1.2021	1.1.2022	

Key:

'Euro 6-1' OBD standard = Full Euro 6 OBD requirements but with preliminary OBD threshold limits as defined in point 2.3.4 of Annex XI and partially relaxed IUPR;

'Euro 6-2' OBD standard = Full Euro 6 OBD requirements but with final OBD threshold limits as defined in point 2.3.3 of Annex XI;

'Euro 6c' emissions standard = RDE testing for monitoring only (no NTE emission limits applied), otherwise full Euro 6 emission requirements;

'Euro 6d-TEMP' emissions standard = RDE testing against temporary conformity factors, otherwise full Euro 6 emission requirements;"

'Euro 6d' emissions standard = RDE testing against final conformity factors, otherwise full Euro 6 emission requirements.

Status: Point in time view as at 01/06/2017.

Changes to legislation: There are outstanding changes not yet made to Commission Regulation (EU) 2017/1151. Any changes that have already been made to the legislation appear in the content and are referenced with annotations. (See end of Document for details)

AL	Euro 6d	Euro 6-2	N1 class III, N2	PI, CI	1.1.2021	1.1.2022	
AX	n.a.	n.a.	All vehicles	Battery full electric	1.9.2009	1.1.2011	
AY	n.a.	n.a.	All vehicles	Battery full electric	1.9.2009	1.1.2011	
AZ	n.a.	n.a.	All vehicles using certificates according to point 2.1.1 of Annex I	PI, CI	1.9.2009	1.1.2011	

Key:

'Euro 6-1' OBD standard = Full Euro 6 OBD requirements but with preliminary OBD threshold limits as defined in point 2.3.4 of Annex XI and partially relaxed IUPR;

'Euro 6-2' OBD standard = Full Euro 6 OBD requirements but with final OBD threshold limits as defined in point 2.3.3 of Annex XI;

'Euro 6c' emissions standard = RDE testing for monitoring only (no NTE emission limits applied), otherwise full Euro 6 emission requirements;

'Euro 6d-TEMP' emissions standard = RDE testing against temporary conformity factors, otherwise full Euro 6 emission requirements;"

'Euro 6d' emissions standard = RDE testing against final conformity factors, otherwise full Euro 6 emission requirements.

2. EXAMPLES OF TYPE-APPROVAL CERTIFICATION NUMBERS

2.1 An example is provided below of an approval of a Euro 6 light passenger car to the 'Euro 6d' emission standard and 'Euro 6-2' OBD standard, identified by the characters AJ according to table 1, issued by Luxembourg, identified by the code e13. The approval was granted for the base Regulation (EC) 715/2007 and its implementing Regulation (EC) xxx/2016 without any amendments. It is the 17th approval of this kind without any extension, so the fourth and fifth components of the certification number are 0017 and 00, respectively.

e13 × 715 / 2007 × xxx / 2016AJ × 0017 × 00

2.2 This second example shows an approval of a Euro 6 N1 class II light commercial vehicle to the 'Euro 6d-TEMP' emission standard and 'Euro 6-2' OBD standard, identified by the characters AH according to table 1, issued by Romania, identified by the code e19. The approval was granted for the base Regulation (EC) 715/2007 and its implementing legislation as last amended by a Regulation xyz/2018. It is the 1st approval of this kind without extension, so the fourth and fifth components of the certification number are 0001 and 00, respectively.

e19 × 715 / 2007 × xyz / 2018AH × 0001 × 00

Status: Point in time view as at 01/06/2017.

Changes to legislation: There are outstanding changes not yet made to Commission Regulation (EU) 2017/1151. Any changes that have already been made to the legislation appear in the content and are referenced with annotations. (See end of Document for details)

Appendix 7

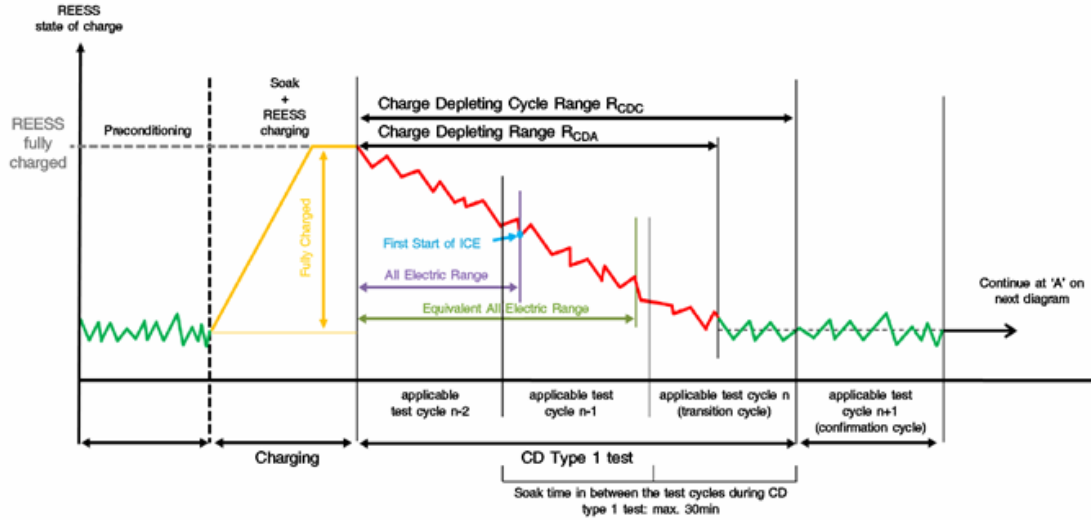

Appendix 8a

Test Report

The Test Report is the report issued by the technical service responsible for conducting the tests according to this regulation.

A separate Test Report shall be prepared for each interpolation family, as defined in paragraph 5.6. of Annex XXI

The following information, if applicable, is the minimum data required for the Type 1 test and Ambient Temperature Correction Test (ATCT) test.

REPORT NUMBER

APPLICANT	
Manufacturer	
SUBJECT	Determination of a vehicle road load
Object submitted to tests	
	Make :
	Type :
CONCLUSION	The object submitted to tests complies with the requirements mentioned in the subject.
PLACE,	DD/MM/YYYY

Remarks:

Status: Point in time view as at 01/06/2017.

Changes to legislation: There are outstanding changes not yet made to Commission Regulation (EU) 2017/1151. Any changes that have already been made to the legislation appear in the content and are referenced with annotations. (See end of Document for details)

- The references to the relevant sections of Regulation (EU) No 692/2008 are highlighted in grey
- (ATCT) means only for Ambient Temperature Correction Test (ATCT) test report
- (not ATCT) means not relevant for ATCT test report
- No reference to ATCT means needed for both ‘type 1’ test report and ATCT test report

General notes:

If there are several options (references), the one tested should be described in the test report

If there are not, a single reference to the information document at the start of the test report may be sufficient.

Every Technical Service is free to include some additional information

- (a) Specific to positive ignition engine
- (b) Specific to compression ignition engine

1. DESCRIPTION OF TESTED VEHICLE(S): HIGH, LOW AND M (IF APPLICABLE)

1.1. GENERAL

Vehicle numbers	:	Prototype number and VIN
Category Annex I Appendix 3 & 4 §0.4	:	
Number of seats including the driver Annex I Appendix 3 §9.10.3 & Appendix 4 addendum §1.4	:	
Bodywork Annex I Appendix 3 §9.1 & Appendix 4 addendum §1.6	:	
Drive wheels Annex I Appendix 3 §1.3.3 & Appendix 4 addendum §1.7	:	

1.1.1. POWERTRAIN ARCHITECTURE

Powertrain architecture	:	internal combustion, hybrid, electric or fuel cell
-------------------------	---	---

1.1.2. INTERNAL COMBUSTION ENGINE (if applicable)

For more than one ICE, please repeat the paragraph

Make	:	
Type	:	

Status: Point in time view as at 01/06/2017.

Changes to legislation: There are outstanding changes not yet made to Commission Regulation (EU) 2017/1151. Any changes that have already been made to the legislation appear in the content and are referenced with annotations. (See end of Document for details)

Annex I Appendix 3 §3.1.1 & Appendix 4 addendum §1.10					
Working principle Annex I Appendix 3 §3.2.1.1	:	two/four stroke			
Cylinders number and arrangement Annex I Appendix 3 §3.2.1.2	:				
Engine capacity (cm ³) Annex I Appendix 3 §3.2.1.3 & Appendix 4 addendum §1.10.1	:				
Engine idling speed (min ⁻¹) Annex I Appendix 3 §3.2.1.6	:		+	-	
High engine idling speed (min ⁻¹ (a) Annex I Appendix 3 §3.2.1.6.1	:		+	-	
n _{min} drive(rpm)	:				
Rated engine power Annex I Appendix 3	:		kW	at	rpm

Status: Point in time view as at 01/06/2017.

Changes to legislation: There are outstanding changes not yet made to Commission Regulation (EU) 2017/1151. Any changes that have already been made to the legislation appear in the content and are referenced with annotations. (See end of Document for details)

§3.2.1.8 & Appendix 4 addendum §1.10.4						
Maximum net torque Annex I Appendix 3 §3.2.1.10 & Appendix 4 addendum §1.11.3	:		Nm	at		rpm
Engine lubricant	:	Manufacturer specification (If there are several references in the information document)				
Cooling system Annex I Appendix 3 §3.2.7	:	Type: air/water/oil				
Insulation	:	material, amount, location, volume and weight				

1.1.3. TEST FUEL FOR TYPE 1 TEST (if applicable)

For more than one test fuel, please repeat the paragraph

Make	:	
Type Annex I Appendix 3 §3.2.2.1 & Appendix 4 addendum §1.10.3	:	petrol E10 - Diesel B7 – LPG – NG - ...
Density at 15°C Annex IX	:	
Sulphur content sub annex 3 of annex XXI Annex IX	:	Only for Diesel B7 and Petrol E10
Batch number	:	
Willans factors (for ICE) for CO ₂ emission (gCO ₂ /km)	:	

1.1.4. FUEL FEED SYSTEM (if applicable)

For more than one fuel feed system, please repeat the paragraph

Direct injection	:	yes/no or description
Vehicle fuel type	:	Monofuel / bifuel / flex fuel

Status: Point in time view as at 01/06/2017.

Changes to legislation: There are outstanding changes not yet made to Commission Regulation (EU) 2017/1151. Any changes that have already been made to the legislation appear in the content and are referenced with annotations. (See end of Document for details)

Annex I Appendix 3 §3.2.2.4		
Control unit		
Part reference Annex I Appendix 3 § 3.2.4.2.9.3.1	:	same as information document
Software tested Annex I Appendix 3 § 3.2.4.2.9.3.1.1	:	read via scantool, for example
Air flowmeter Annex I Appendix 3 § 3.2.4.2.9.3.3	:	
Throttle body Annex I Appendix 3 § 3.2.4.2.9.3.5	:	
Pressure sensor Annex I Appendix 3 § 3.2.4.3.4.11	:	
Injection pump Annex I Appendix 3 § 3.2.4.2.3	:	
Injector(s) Annex I Appendix 3 § 3.2.4.2.6	:	

1.1.5. INTAKE SYSTEM (if applicable)

For more than one intake system, please repeat the paragraph

Pressure charger Annex I Appendix 3 § 3.2.8.1	:	Yes/no make & type ⁽¹⁾
Intercooler Annex I Appendix 3 § 3.2.8.2	:	yes/no type (air/air – air/water) ⁽¹⁾
Air filter (element) ⁽¹⁾ Annex I Appendix 3 § 3.2.8.4.2	:	make & type
Intake silencer ⁽¹⁾ Annex I Appendix 3 § 3.2.8.4.3	:	make & type

1.1.6. EXHAUST SYSTEM AND ANTI-EVAPORATIVE SYSTEM (if applicable)

For more than one, please repeat the paragraph

First catalytic converter	:	make & reference ⁽¹⁾
---------------------------	---	---------------------------------

Status: Point in time view as at 01/06/2017.

Changes to legislation: There are outstanding changes not yet made to Commission Regulation (EU) 2017/1151. Any changes that have already been made to the legislation appear in the content and are referenced with annotations. (See end of Document for details)

Annex I Appendix 3 §3.2.12.2.1.12.& 3.2.12.2.1.13	:	principle: three way / oxidising / NOx trap / Selective Catalyst Reduction
Second catalytic converter	:	make & reference ⁽¹⁾ principle: three way / oxidising / NOx trap / Selective Catalyst Reduction
Particulate trap Annex I Appendix 3 §3.2.12.2.6	:	with/without/not applicable make & reference ⁽¹⁾
Reference and position of oxygen sensor(s) Annex I Appendix 3 §3.2.12.2.2	:	before catalyst / after catalyst
Air injection Annex I Appendix 3 §3.2.12.2.3	:	with/without/not applicable
EGR Annex I Appendix 3 §3.2.12.2.4	:	with/without/not applicable cooled/non-cooled
Evaporative emission control system Annex I Appendix 3 §3.2.12.2.5	:	with/without/not applicable
Reference and position of NOx sensor(s)	:	Before/ after
General description ⁽¹⁾ Annex I Appendix 3 §3.2.9.2	:	

1.1.7. HEAT STORAGE DEVICE (if applicable)

For more than one Heat Storage System, please repeat the paragraph

Heat storage device	:	yes/no
Heat capacity (enthalpy stored J)	:	
Time for heat release (s)	:	

1.1.8. TRANSMISSION (if applicable)

For more than one Transmission, please repeat the paragraph

Gearbox	:	manual / automatic / continuous variation
---------	---	---

Status: Point in time view as at 01/06/2017.

Changes to legislation: There are outstanding changes not yet made to Commission Regulation (EU) 2017/1151. Any changes that have already been made to the legislation appear in the content and are referenced with annotations. (See end of Document for details)

Annex I Appendix 3 § 4.5.1 & Appendix 4 addendum §1.13.1		
Gear shifting procedure		
Predominant mode	:	yes/no normal / drive / eco/...
Best case mode for CO ₂ emissions and fuel consumption (if applicable)	:	
Worst case mode for CO ₂ emissions and fuel consumption (if applicable)	:	
Control unit	:	
Gearbox lubricant	:	Manufacturer's specification (If there are several references in the information document)

Tyres

Annex I Appendix 3 §6.6 & Appendix 4 addendum §1.14

Make	:	
Type	:	
Dimensions front/rear Annex I Appendix 3 §6.6.1	:	
Circumference (m)	:	
Tyre pressure (kPa) Annex I Appendix 3 §6.6.3	:	

Transmission ratios (R.T.), primary ratios (R.P.) and (vehicle speed (km/h)) / (engine speed (1 000 (min⁻¹)) (V_{1 000})) for each of the gearbox ratios (R.B.).

Annex I Appendix 3 §4.6 & Appendix 4 addendum §1.13.3

R.B.	R.P.	R.T.	V _{1 000}
1 st	1/1		
2 nd	1/1		
3 rd	1/1		
4 th	1/1		
5 th	1/1		
...			

Status: Point in time view as at 01/06/2017.

Changes to legislation: There are outstanding changes not yet made to Commission Regulation (EU) 2017/1151. Any changes that have already been made to the legislation appear in the content and are referenced with annotations. (See end of Document for details)

1.1.9. **ELECTRIC MACHINE (if applicable)**

For more than one Electric Machine, please repeat the paragraph

Make	:	
Type	:	
Peak Power	:	

1.1.10. **TRACTION REESS (if applicable)**

For more than one Traction REESS, please repeat the paragraph

Make	:	
Type	:	
Capacity	:	
Nominal Voltage	:	

1.1.12. **FUEL CELL (if applicable)**

For more than one Fuel Cell, please repeat the paragraph

Make	:	
Type	:	
Maximum Power	:	
Nominal Voltage	:	

1.1.13. **POWER ELECTRONICS (if applicable)**

Can be more than one PE (propulsion converter, low voltage system or charger)

Make	:	
Type	:	
Power	:	

1.2. **VEHICLE HIGH DESCRIPTION (TYPE 1) OR VEHICLE DESCRIPTION (ATCT)**

1.2.1. **MASS**

Test mass of VH (kg)	:	
----------------------	---	--

1.2.2. **ROAD LOAD PARAMETERS**

Status: Point in time view as at 01/06/2017.

Changes to legislation: There are outstanding changes not yet made to Commission Regulation (EU) 2017/1151. Any changes that have already been made to the legislation appear in the content and are referenced with annotations. (See end of Document for details)

f_0 (N)	:	
f_1 (N/(km/h))	:	
f_2 (N/(km/h) ²)	:	
f_{2_TReg} (N/(km/h) ²)	:	(ATCT)
Cycle energy demand (Ws) Annex XXI §3.5.6	:	
Road load test report reference	:	

1.2.3. CYCLE SELECTION PARAMETERS

Cycle (without downscaling)	:	Class 1 / 2 / 3a / 3b
Ratio of rated power to mass in running order (PMR)(W/ kg)	:	(if applicable)
Capped speed process used during measurement Annex XXI sub-annex 1 §9	:	yes/no
Maximum speed of the vehicle Annex I appendix 3 §4.7	:	
Downscaling (if applicable)	:	yes/no
Downscaling factor f_{dsc}	:	
Cycle distance (m)	:	
Constant speed (in the case of the shortened test procedure)	:	if applicable

1.2.4. GEAR SHIFT POINT (IF APPLICABLE)

Gear shifting	:	Average gear for $v \geq 1$ km/h, rounded to four places of decimal
---------------	---	---

1.3. VEHICLE LOW DESCRIPTION (IF APPLICABLE)

1.3.1. MASS

Test mass of VL(kg)	:	
---------------------	---	--

1.3.2. ROAD LOAD PARAMETERS

Status: Point in time view as at 01/06/2017.

Changes to legislation: There are outstanding changes not yet made to Commission Regulation (EU) 2017/1151. Any changes that have already been made to the legislation appear in the content and are referenced with annotations. (See end of Document for details)

f_0 (N)	:	
f_1 (N/(km/h))	:	
f_2 (N/(km/h) ²)	:	
Cycle energy demand (Ws)	:	
$\Delta(C_D \times A_f)_{LH}$:	
Road load test report reference	:	

1.3.3. CYCLE SELECTION PARAMETERS

Cycle (without downscaling)	:	Class 1 / 2 / 3a / 3b
Ratio of rated power to mass in running order (PMR)(W/kg)	:	(if applicable)
Capped speed process used during measurement Annex XXI sub-annex 1 §9	:	yes/no
Maximum speed of the vehicle Annex I appendix 3 §4.7	:	
Downscaling (if applicable)	:	yes/no
Downscaling factor f_{dsc}	:	
Cycle distance (m)	:	
Constant speed (in the case of the shortened test procedure)	:	if applicable

1.3.4. GEAR SHIFT POINT (IF APPLICABLE)

Gear shifting	:	Average gear for $v \geq 1$ km/h, rounded to four places of decimal
---------------	---	---

1.4. VEHICLE M DESCRIPTION (IF APPLICABLE)

1.4.1. MASS

Test mass of VL(kg)	:	
---------------------	---	--

1.4.2. ROAD LOAD PARAMETERS

f_0 (N)	:	
-----------	---	--

Status: Point in time view as at 01/06/2017.

Changes to legislation: There are outstanding changes not yet made to Commission Regulation (EU) 2017/1151. Any changes that have already been made to the legislation appear in the content and are referenced with annotations. (See end of Document for details)

f_1 (N/(km/h))	:	
f_2 (N/(km/h) ²)	:	
Cycle energy demand (Ws)	:	
$\Delta(C_D \times A_f)_{LH}$:	

1.4.3. CYCLE SELECTION PARAMETERS

Cycle (without downscaling)	:	Class 1 / 2 / 3a / 3b
Ratio of rated power to mass in running order (PMR)(W/kg)	:	(if applicable)
Capped speed process used during measurement Annex XXI sub-annex 1 §9	:	yes/no
Maximum speed of the vehicle Annex I appendix 3 §4.7	:	
Downscaling (if applicable)	:	yes/no
Downscaling factor f_{dsc}	:	
Cycle distance (m)	:	
Constant speed (in the case of the shortened test procedure)	:	if applicable

1.4.4. GEAR SHIFT POINT (IF APPLICABLE)

Gear shifting	:	Average gear for $v \geq 1$ km/h, rounded to four places of decimal
---------------	---	---

2. TEST RESULTS

2.1. TYPE 1 TEST or ATCT TEST

Method of chassis dyno setting	:	Fixed run / iterative / alternative with its own warmup cycle
Dynamometer operation mode Ann XXI sub-ann6 §1.2.4.2.2.	:	yes/no
Coastdown mode Ann XXI sub-ann4 §4.2.1.8.5	:	yes/no

Status: Point in time view as at 01/06/2017.

Changes to legislation: There are outstanding changes not yet made to Commission Regulation (EU) 2017/1151. Any changes that have already been made to the legislation appear in the content and are referenced with annotations. (See end of Document for details)

Additional preconditioning	:	yes/no description
Deterioration factors	:	assigned / tested

2.1.1. Vehicle high (used for ATCT, also)

Date of tests	:	(day/month/year)
Place of the test	:	
Height of the lower edge above ground of cooling fan (cm)	:	
Lateral position of fan centre (if modified as request by the manufacturer)	:	in the vehicle centre-line/...
Distance from the front of the vehicle (cm)	:	

2.1.1.1. Pollutant emissions (if applicable)

2.1.1.1.1. Pollutant emissions of vehicles with at least one combustion engine, of NOVC-HEVs and of OVC-HEVs in case of a charge-sustaining Type 1 test

For each operating modes tested the paragraphs below has to be repeated (predominant mode or best case mode and worst case, mode if applicable)

Test 1

Pollutants	CO(mg/km)	THC (a)(mg/km)	NMHC (a)(mg/km)	NO _x (mg/km)	THC +NO _x (b)(mg/km)	Particulate Matter(mg/km)	Particle Number(#.10 ¹¹ /km)
Measured values							
Regeneration factors (Ki)(2) Additive							
Regeneration factors (Ki)(2) Multiplicative							
Deterioration factors (DF) additive							
Deterioration factors							

Status: Point in time view as at 01/06/2017.

Changes to legislation: There are outstanding changes not yet made to Commission Regulation (EU) 2017/1151. Any changes that have already been made to the legislation appear in the content and are referenced with annotations. (See end of Document for details)

(DF) multiplicative							
Final values							
Limit values							

(2)	See Ki family report(s)	:	
Type 1/I performed for Ki determination	:		Annex XXI, Sub-Annex 4 or UN/ECE Regulation No 83 ^a

a Indicate as applicable

Test 2 if applicable: for CO₂ reason (d_{CO2}¹) / for pollutants reason (90 % of the limits) / for both

Same paragraph

Test 3 if applicable: for CO₂ reason (d_{CO2}²)

Same paragraph

2.1.1.1.2. **Pollutant emissions of OVC-HEVs in case of a charge-depleting Type 1 test**

Test 1

Pollutant emission limits have to be fulfilled and the following paragraph has to be repeated for each driven test cycle.

Pollutants	CO(mg/km)	THC (a)(mg/km)	NMHC (a)(mg/km)	NO _x (mg/km)	THC +NO _x (b)(mg/km)	Particulate Matter(mg/km)	Particle Number(#.10 ¹¹ /km)
Measured single cycle values							
Limit single cycle values							

Test 2 (if applicable): for CO₂ reason (d_{CO2}¹) / for pollutants reason (90 % of the limits) / for both

Same paragraph

Test 3 (if applicable): for CO₂ reason (d_{CO2}²)

Same paragraph

2.1.1.1.3. **UF-WEIGHTED POLLUTANT EMISSIONS OF OVC-HEVS**

Status: Point in time view as at 01/06/2017.

Changes to legislation: There are outstanding changes not yet made to Commission Regulation (EU) 2017/1151. Any changes that have already been made to the legislation appear in the content and are referenced with annotations. (See end of Document for details)

Pollutants	CO(mg/km)	THC (a)(mg/km)	NMHC (a)(mg/km)	NO _x (mg/km)	THC +NO _x (b)(mg/km)	Particulate Matter(mg/km)	Particle Number(#.10 ¹¹ /km)
Calculated values							

2.1.1.2. CO₂ emission (if applicable)

2.1.1.2.1. CO₂ Emission of vehicles with at least one combustion engine, of NOVC-HEV and of OVC-HEV in case of a charge-sustaining Type 1 test (not ATCT)

For each operating mode tested the paragraphs below have to be repeated (predominant mode or best case mode and worst case, mode if applicable)

Test 1

CO ₂ Emission	Low	Medium	High	Extra High	Combined
Measured value M _{CO2,p,1} / M _{CO2,c,2}					
RCB correction coefficient: ^b					
M _{CO2,p,3} / M _{CO2,c,3}					
Regeneration factors (Ki) Additive					
Regeneration factors (Ki) Multiplicative					
M _{CO2,c,4}	—				
AF _{Ki} = M _{CO2,c,3} / M _{CO2,c,4}	—				
M _{CO2,p,4} / M _{CO2,c,4}					—
ATCT correction (FCF) ^a					

a FCF: family correction factor for correcting for representative regional temperature conditions (ATCT)
See FCF family report(s):

b correction as referred to in Sub-Annex 6 Appendix 2 of Annex XXI of this Regulation for ICE vehicles, K_{CO2} for HEVs

Status: Point in time view as at 01/06/2017.

Changes to legislation: There are outstanding changes not yet made to Commission Regulation (EU) 2017/1151. Any changes that have already been made to the legislation appear in the content and are referenced with annotations. (See end of Document for details)

Temporary values $M_{CO_2,p,5}$ / $M_{CO_2,c,5}$					
Declared value	—	—	—	—	
$d_{CO_2}^1$ * declared value	—	—	—	—	
a	FCF: family correction factor for correcting for representative regional temperature conditions (ATCT) See FCF family report(s):				
b	correction as referred to in Sub-Annex 6 Appendix 2 of Annex XXI of this Regulation for ICE vehicles, K_{CO_2} for HEVs				

Test 2 (if applicable)

Same paragraph with $d_{CO_2}^2$

Test 3 (if applicable)

Same paragraph

Conclusion

CO₂ Emission (g/km)	Low	Medium	High	Extra High	Combined
Averaging $M_{CO_2,p,6}$ / $M_{CO_2,c,6}$					
Alignment $M_{CO_2,p,7}$ / $M_{CO_2,c,7}$					
Final values $M_{CO_2,p,H}$ / $M_{CO_2,c,H}$					

2.1.1.2.2. ATCT CO₂ Emission of vehicles with at least one combustion engine, of NOVC-HEV and of OVC-HEV in case of a charge-sustaining Type 1 test (ATCT)

Test at 14°C (ATCT)

CO₂ Emission (g/km)	Low	Medium	High	Extra High	Combined
Measured value $M_{CO_2,p,1}$ / $M_{CO_2,c,2}$					

Status: Point in time view as at 01/06/2017.

Changes to legislation: There are outstanding changes not yet made to Commission Regulation (EU) 2017/1151. Any changes that have already been made to the legislation appear in the content and are referenced with annotations. (See end of Document for details)

RCB correction coefficient (5)					
$M_{CO_2,p,3} / M_{CO_2,c,3}$					

Conclusion (ATCT)

CO ₂ Emission (g/km)	Combined
ATCT (14°C) $M_{CO_2,Treg}$	
Type 1 (23°C) $M_{CO_2,23^\circ}$	
Family correction factor (FCF)	

2.1.1.2.3. CO₂ Mass Emission of OVC-HEVs in case of a charge-depleting Type 1 test

Test 1:

CO ₂ Mass Emission (g/km)	Combined
Calculated value $M_{CO_2,CD}$	
Declared value	
$d_{CO_2}^1$	

Test 2 (if applicable)

Same paragraph with $d_{CO_2}^2$

Test 3 (if applicable)

Same paragraph

Conclusion

CO ₂ Mass Emission (g/km)	Combined
Averaging $M_{CO_2,CD}$	
Final value $M_{CO_2,CD}$	

2.1.1.2.4. UF-WEIGHTED CO₂ Mass Emission of OVC-HEVs

CO ₂ Mass Emission (g/km)	Combined
Calculated value $M_{CO_2,weighted}$	

2.1.1.3 FUEL CONSUMPTION (IF APPLICABLE, NOT ATCT)

2.1.1.3.1. Fuel consumption of vehicles with only a combustion engine, of NOVC-HEVs and of OVC-HEVs in case of a charge-sustaining Type 1 test

Status: Point in time view as at 01/06/2017.

Changes to legislation: There are outstanding changes not yet made to Commission Regulation (EU) 2017/1151. Any changes that have already been made to the legislation appear in the content and are referenced with annotations. (See end of Document for details)

For each operating modes tested the paragraphs below has to be repeated (predominant mode or best case mode and worst case, mode if applicable)

Consumption (l/100 km)	Low	Medium	High	Extra High	Combined
Final values FC _{p,H} / FC _{c,H} ^a					

^a Calculated from aligned CO₂ values

2.1.1.3.2. *Fuel consumption of OVC-HEVs in case of a charge-depleting Type 1 test*

Test 1:

Fuel Consumption (l/100 km)	Combined
Calculated value FC _{CD}	

Test 2 (if applicable)

Same paragraph

Test 3 (if applicable)

Same paragraph

Conclusion

Fuel Consumption (l/100 km)	Combined
Averaging FC _{CD}	
Final value FC _{CD}	

2.1.1.3.3. *UF-Weighted Fuel consumption of OVC-HEVs*

Fuel Consumption (l/100 km)	Combined
Calculated value FC _{weighted}	

2.1.1.3.4. *Fuel consumption of vehicles of NOVC-FCHVs in case of a charge-sustaining Type 1 test*

For each operating modes tested the paragraphs below has to be repeated (predominant mode or best case mode and worst case, mode if applicable)

Consumption (kg/100 km)	Low	Medium	High	Extra High	Combined
Measured values					
RCB correction coefficient					

Status: Point in time view as at 01/06/2017.

Changes to legislation: There are outstanding changes not yet made to Commission Regulation (EU) 2017/1151. Any changes that have already been made to the legislation appear in the content and are referenced with annotations. (See end of Document for details)

Final values FC _p / FC _c					
---	--	--	--	--	--

2.1.1.4. RANGES (IF APPLICABLE)

2.1.1.4.1. Ranges for OVC-HEVs (if applicable)

2.1.1.4.1.1. All electric Range

Test 1

AER (km)	City	Combined
Measured/Calculated values AER		
Declared value	—	

Test 2 (if applicable)

Same paragraph

Test 3 (if applicable)

Same paragraph

Conclusion

AER (km)	City	Combined
Averaging AER (if applicable)		
Final values AER		

2.1.1.4.1.2. Equivalent All electric Range

EAER (km)	City	Combined
Final values EAER		

2.1.1.4.1.3. Actual Charge-Depleting Range

R _{CDA} (km)	Combined
Final value R _{CDA}	

2.1.1.4.1.4. Charge-Depleting Cycle Range

Test 1

R _{CDC} (km)	Combined
Final value R _{CDC}	
Index Number of the transition cycle	
REEC of confirmation-cycle (%)	

Status: Point in time view as at 01/06/2017.

Changes to legislation: There are outstanding changes not yet made to Commission Regulation (EU) 2017/1151. Any changes that have already been made to the legislation appear in the content and are referenced with annotations. (See end of Document for details)

Test 2 (if applicable)

Same paragraph

Test 3 (if applicable)

Same paragraph

2.1.1.4.2. Ranges for PEVs - Pure electric Range (if applicable)

Test 1

PER (km)	City	Combined
Calculated values PER		
Declared value	—	

Test 2 (if applicable)

Same paragraph

Test 3 (if applicable)

Same paragraph

Conclusion

PER (km)	City	Combined
Averaging PER		
Final values PER		

2.1.1.5. ELECTRIC CONSUMPTION (IF APPLICABLE)

2.1.1.5.1. Electric Consumption of OVC-HEVs (if applicable)

2.1.1.5.1.1. Electric consumption EC

EC (Wh/km)	Low	Medium	High	Extra High	City	Combined
Final values EC						

2.1.1.5.1.1.1. *WIF*-weighted charge-depleting electric consumption

Test 1

EC _{AC,CD} (Wh/km)	Combined
Calculated value EC _{AC,CD}	

Test 2 (if applicable)

Same paragraph

Test 3 (if applicable)

Same paragraph

Conclusion (if applicable)

Status: Point in time view as at 01/06/2017.

Changes to legislation: There are outstanding changes not yet made to Commission Regulation (EU) 2017/1151. Any changes that have already been made to the legislation appear in the content and are referenced with annotations. (See end of Document for details)

EC_{AC,CD} (Wh/km)	Combined
Averaging EC _{AC,CD}	
Final value	

2.1.1.5.1. *WIF*-weighted electric consumption

Test 1

EC_{AC,weighted} (Wh)	Combined
Calculated value EC _{AC,weighted}	

Test 2 (if applicable)

Same paragraph

Test 3 (if applicable)

Same paragraph

Conclusion (if applicable)

EC_{AC,weighted} (Wh/km)	Combined
Averaging EC _{AC,weighted}	
Final value	

2.1.1.5.2. Electric consumption of PEVs (if applicable)

Test 1

EC (Wh/km)	City	Combined
Calculated values EC		
Declared value	—	

Test 2 (if applicable)

Same paragraph

Test 3 (if applicable)

Same paragraph

EC (Wh/km)	Low	Medium	High	Extra High	City	Combined
Averaging EC						
Final values EC						

2.1.2. VEHICLE LOW (IF APPLICABLE)

Repeat § 2.1.1.

Status: Point in time view as at 01/06/2017.

Changes to legislation: There are outstanding changes not yet made to Commission Regulation (EU) 2017/1151. Any changes that have already been made to the legislation appear in the content and are referenced with annotations. (See end of Document for details)

2.1.3. VEHICLE M (IF APPLICABLE)

Repeat § 2.1.1.

2.1.4. FINAL CRITERIA EMISSIONS VALUES (IF APPLICABLE)

Pollutants	CO(mg/km)	THC (a)(mg/km)	NMHC (a)(mg/km)	NO _x (mg/km)	THC +NO _x (b)(mg/km)	PM(mg/km)	PN(#.10 ¹¹ /km)
Highest values ^a							

^a for each pollutant within all test results of VH, VL (if applicable) and VIM (if applicable)

2.2. TYPE 2 (a) TEST (not ATCT)

Included the emissions data required for roadworthiness testing

Test	CO (% vol)	Lambda	Engine speed (min ⁻¹)	Oil temperature (°C)
Idle		—		
High idle				

2.3. TYPE 3 (a) TEST (not ATCT)

Emission of crankcase gases into the atmosphere: none

2.4. TYPE 4 (a) TEST (not ATCT)

See report(s)	:	
---------------	---	--

2.5. TYPE 5 (a) TEST (not ATCT)

See durability family report(s)	:	
Type 1/I cycle for criteria emissions testing	:	Annex XXI, Sub-Annex 4 or UN/ECE Regulation No 83 ^a

^a Indicate as applicable

2.6. RDE TEST (not ATCT)

RDE family number	:	MSxxxx
See family report(s)	:	

Status: Point in time view as at 01/06/2017.

Changes to legislation: There are outstanding changes not yet made to Commission Regulation (EU) 2017/1151. Any changes that have already been made to the legislation appear in the content and are referenced with annotations. (See end of Document for details)

2.7. TYPE 6 (a) TEST (not ATCT)

Date of tests	:	(day/month/year)
Place of tests	:	
Method of setting of the chassis dyno	:	coast down (road load reference)
Inertia mass (kg)	:	
If deviation from the vehicle of type 1	:	
Tyres	:	
Make	:	
Type	:	
Dimensions front/rear	:	
Circumference (m)	:	
Tyre pressure (kPa)	:	

Pollutants		CO(g/km)	HC(g/km)
Test	1		
	2		
	3		
Average			
Limit			

2.8. ON BOARD DIAGNOSTIC SYSTEM (not ATCT)

See family report(s)	:	
----------------------	---	--

2.9. SMOKE OPACITY (b) TEST (not ATCT)

2.9.1. STEADY SPEEDS TEST

See family report(s)	:	
----------------------	---	--

2.9.2. FREE ACCELERATION TEST

Measured absorption value (m ⁻¹)	:	
Corrected absorption value (m ⁻¹)	:	

Status: Point in time view as at 01/06/2017.

Changes to legislation: There are outstanding changes not yet made to Commission Regulation (EU) 2017/1151. Any changes that have already been made to the legislation appear in the content and are referenced with annotations. (See end of Document for details)

2.10. ENGINE POWER (not ATCT)

See family report(s)	:	
----------------------	---	--

2.11. TEMPERATURE INFORMATION RELATED TO VEHICLE HIGH (VH)

Engine coolant temperature at the end of soaking time (°C) sub-ann6a §3.9.2	:	
Average soak area temperature over the 3 last hours (°C) sub-ann6a §3.9.2	:	
Difference between engine coolant end temperature and average soak area temperature of the last 3 hours ΔT_{ATCT} (°C) sub-ann6a §3.9.3	:	
The minimum soaking time t_{soak_ATCT} (s) sub-ann6a §3.9.1	:	
Location of temperature sensor sub-ann6a §3.9.5	:	

Annex of the test report (not applicable ATCT test and PEV),

- 1 — By electronic format, all the input data for the correlation tool, listed in Annex 1 point 2.4 to Implementing Regulations (EU) 2017/1152 and (EU) 2017/1153.

Reference of input file: ...

- 2 — Co2mpas output:
3 — NEDC test results (if applicable):

Appendix 8b

Road Load Test Report

The following information, if applicable, is the minimum data required for the road load determination test.

REPORT NUMBER

APPLICANT	
------------------	--

Status: Point in time view as at 01/06/2017.

Changes to legislation: There are outstanding changes not yet made to Commission Regulation (EU) 2017/1151. Any changes that have already been made to the legislation appear in the content and are referenced with annotations. (See end of Document for details)

Manufacturer			
SUBJECT	Determination of a vehicle road load		
Object submitted to tests			
	Make	:	
	Type	:	
CONCLUSION	The object submitted to tests complies with the requirements mentioned in the subject.		
PLACE,		DD/MM/YYYY	

1. CONCERNED VEHICLE(S)

Make(s) concerned	:	
Type(s) concerned	:	
Commercial description	:	
Maximal speed (km/h)	:	
Powered axle(s)	:	

2. DESCRIPTION OF TESTED VEHICLES

2.1. GENERAL

If no interpolation: the worst-case vehicle (regarding energy demand) has to be described

2.1.1. Vehicle High

Make	:	
Type	:	
Version	:	
Cycle energy demand over a complete WLTC Class 3 cycle independent of the vehicle class	:	
Deviation from production series	:	
Mileage	:	

2.1.2. Vehicle Low

Make	:	
Type	:	

Status: Point in time view as at 01/06/2017.

Changes to legislation: There are outstanding changes not yet made to Commission Regulation (EU) 2017/1151. Any changes that have already been made to the legislation appear in the content and are referenced with annotations. (See end of Document for details)

Version	:	
Cycle energy demand over a complete WLTC Class 3 cycle independent of the vehicle class	:	(4 to 35% based on H _R)
Deviation from production series	:	
Mileage	:	

2.1.3. Representative vehicle of the road load matrix family (if applicable)

Make	:	
Type	:	
Version	:	
Cycle energy demand over a complete WLTC	:	
Deviation from production series	:	
Mileage	:	

2.2. MASSES

2.2.1. Vehicle High

Test mass (kg)	:	
Average mass m_{av} (kg)	:	(average before and after the test)
Rotational mass m_r (kg)	:	3% of (MRO+25kg) or measured
Weight distribution		
Front	:	
Rear	:	

2.2.2. Vehicle Low

Repeat §2.2.1. with VL data

2.2.3. Representative vehicle of the road load matrix family (if applicable)

Test mass (kg)	:	
Average mass m_{av} (kg)	:	(average before and after the test)

Status: Point in time view as at 01/06/2017.

Changes to legislation: There are outstanding changes not yet made to Commission Regulation (EU) 2017/1151. Any changes that have already been made to the legislation appear in the content and are referenced with annotations. (See end of Document for details)

Technically permissible maximum laden mass ($\geq 3000\text{kg}$)	:	
Estimated arithmetic average of the mass of optional equipment	:	
Weight distribution		
Front	:	
Rear	:	

2.3. TYRES

2.3.1. Vehicle High

Size designation	:	front/rear if different
Make	:	front/rear if different
Type	:	front/rear if different
Rolling resistance (kgf/1 000 kg)		
Front	:	
Rear	:	
Front pressure (kPa)	:	
Rear pressure (kPa)	:	

2.3.2. Vehicle Low

Repeat §2.3.1. with VL data

2.3.3. Representative vehicle of the road load matrix family (if applicable)

Repeat §2.3.1. with the representative vehicle data

2.4. BODYWORK

2.4.1. Vehicle High

Type	:	AA/AB/AC/AD/AE/AF BA/BB/BC/BD
Version	:	
Aerodynamic devices	:	
Movable aerodynamic body parts	:	y/n and list if applicable
Installed aerodynamic options list	:	

Status: Point in time view as at 01/06/2017.

Changes to legislation: There are outstanding changes not yet made to Commission Regulation (EU) 2017/1151. Any changes that have already been made to the legislation appear in the content and are referenced with annotations. (See end of Document for details)

2.4.2. Vehicle Low

Repeat §2.4.1. with VL data

Delta $(C_d * A_f)_{LH}$ compared to VH	:	
---	---	--

2.4.3. Representative vehicle of the road load matrix family (if applicable)

Body shape description	:	Square box (if no representative body shape for a complete vehicle can be determined)
------------------------	---	---

Repeat §2.4.1. with the representative vehicle data if applicable

Frontal area A_{fr}	:	
-----------------------	---	--

2.5. POWERTRAIN

2.5.1. Vehicle High

Engine code	:																												
Transmission type	:	manual, automatic, CVT																											
Transmission model (manufacturer's codes)	:	(torque rating and no of clutches → to be included in info doc)																											
Covered transmission models (manufacturer's codes)	:																												
Engine rotational speed divided by vehicle speed	:	<table border="1"> <thead> <tr> <th>Gear</th> <th>Gear ratio</th> <th>N/V ratio</th> </tr> </thead> <tbody> <tr> <td>1st</td> <td>1/..</td> <td></td> </tr> <tr> <td>2nd</td> <td>1..</td> <td></td> </tr> <tr> <td>3rd</td> <td>1/..</td> <td></td> </tr> <tr> <td>4th</td> <td>1/..</td> <td></td> </tr> <tr> <td>5th</td> <td>1/..</td> <td></td> </tr> <tr> <td>6th</td> <td>1/..</td> <td></td> </tr> <tr> <td>..</td> <td></td> <td></td> </tr> <tr> <td>..</td> <td></td> <td></td> </tr> </tbody> </table>	Gear	Gear ratio	N/V ratio	1 st	1/..		2 nd	1..		3 rd	1/..		4 th	1/..		5 th	1/..		6 th	1/..			
Gear	Gear ratio	N/V ratio																											
1 st	1/..																												
2 nd	1..																												
3 rd	1/..																												
4 th	1/..																												
5 th	1/..																												
6 th	1/..																												
..																													
..																													
Electric machine(s) coupled in position N	:	n.a. (no electric machine or no coastdown mode)																											

Status: Point in time view as at 01/06/2017.

Changes to legislation: There are outstanding changes not yet made to Commission Regulation (EU) 2017/1151. Any changes that have already been made to the legislation appear in the content and are referenced with annotations. (See end of Document for details)

Type and number of electric machines	:	construction type: asynchronous/ synchronous...
Type of coolant	:	air, liquid,...

2.5.2. Vehicle Low

Repeat §2.5.1. with VL data

2.6. TEST RESULTS

2.6.1. Vehicle High

Dates of tests	:	dd/mm/yyyy
----------------	---	------------

ON ROAD (ANNEX XXI, SUB ANNEX 4, §4)

Method of the test	:	coastdown (Annex XXI, Sub Annex 4, §4.3.) or torque meter method (Annex XXI, Sub Annex 4, §4.4.)
Facility (name / location / track's reference)	:	
Coastdown mode	:	y/n
Wheel alignment	:	Toe and camber values
Maximum reference speed (km/h) Annex XXI, Sub Annex 4, §4.2.4.1.2.	:	
Anemometry	:	stationary or on board: influence of anemometry ($c_d \cdot A$) and if it was corrected.
Number of split(s)	:	
Wind	:	average, peaks and direction in conjunction with direction of the test track
Air pressure	:	
Temperature (mean value)	:	
Wind correction	:	y/n
Tyre pressure adjustment	:	y/n
Raw results	:	Torque method: c0= c1=

Status: Point in time view as at 01/06/2017.

Changes to legislation: There are outstanding changes not yet made to Commission Regulation (EU) 2017/1151. Any changes that have already been made to the legislation appear in the content and are referenced with annotations. (See end of Document for details)

		c2= Coastdown method: f0 f1 f2
Final results		Torque method: c0= c1= c2= and f0= f1= f2= Coastdown method: f0= f1= f2=

Or

WIND TUNNEL METHOD (ANNEX XXI, SUB ANNEX 4, §6)

Facility (name/location/ dynamometer's reference)	:		
Qualification of the facilities	:	Report reference and date	
Dynamometer			
Type of dynamometer	:	flat belt or chassis dynamometer	
Method	:	stabilised speeds or deceleration method	
Warm up	:	warm-up by dyno or by driving the vehicle	
Correction of the roller curve (Annex XXI, Sub Annex 4, §6.6.3.)	:	(for chassis dynamometer, if applicable)	
Method of chassis dynamometer setting	:	Fixed run / iterative / alternative with its own warmup cycle	
Measured aerodynamic drag coefficient multiplied by the frontal area	:	Velocity (km/h)	$C_d * A$ (m²)
	
	
Result	:	f0= f1= f2=	

Status: Point in time view as at 01/06/2017.

Changes to legislation: There are outstanding changes not yet made to Commission Regulation (EU) 2017/1151. Any changes that have already been made to the legislation appear in the content and are referenced with annotations. (See end of Document for details)

Or

ROAD LOAD MATRIX (ANNEX XXI, SUB ANNEX 4, §5)

Method of the test	:	coastdown (Annex XXI, Sub Annex 4, §4.3) or torque meter method (Annex XXI, Sub Annex 4, §4.4)
Facility (name/location/track's reference)	:	
Coastdown mode	:	y/n
Wheel alignment	:	Toe and camber values
Maximum reference speed (km/h) Annex XXI, Sub Annex 4, §4.2.4.1.2.	:	
Anemometry	:	stationary or on board: influence of anemometry (cd*A) and if it was corrected.
Number of split(s)	:	
Wind	:	average, peaks and direction in conjunction with direction of the test track
Air pressure	:	
Temperature (mean value)	:	
Wind correction	:	y/n
Tyre pressure adjustment	:	y/n
Raw results	:	Torque method: c0r= c1r= c2r= Coastdown method: f0r f1r f2r
Final results	:	Torque method: c0r= c1r= c2r= and f0r= f1r= f2r= Coastdown method:

Status: Point in time view as at 01/06/2017.

Changes to legislation: There are outstanding changes not yet made to Commission Regulation (EU) 2017/1151. Any changes that have already been made to the legislation appear in the content and are referenced with annotations. (See end of Document for details)

	f0r=
	f1r=
	f2r=

2.6.2. Vehicle Low

Repeat §2.6.1. with VL data

Appendix 8c

Template for Test Sheet

The 'test sheet' shall include the test data that are recorded, but not included in any test report.

The test sheet(s) shall be retained by the technical service or the manufacturer for at least 10 years.

The following information, if applicable, is the minimum data required for test sheets.

Adjustable wheel alignment parameters Annex XXI, Sub-Annex 4, § 4.2.1.8.3.	:		
The coefficients, c0, c1 and c2,	:	c0=	
		c1=	
		c2=	
The coastdown times measured on the chassis dynamometer Annex XXI, Sub-Annex 4, §4.4.4.	:	Vehicle speed (km/h)	Coastdown time (s)
		125-115	
		115-105	
		105-95	
		95-85	
		85-75	
		75-65	
		65-55	
		55-45	
		45-35	
		35-25	
25-15			
15-05			

Status: Point in time view as at 01/06/2017.

Changes to legislation: There are outstanding changes not yet made to Commission Regulation (EU) 2017/1151. Any changes that have already been made to the legislation appear in the content and are referenced with annotations. (See end of Document for details)

Additional weight may be placed on or in the vehicle to eliminate tyre slippage Annex XXI, Sub-Annex 4, §7.1.1.1.1.	:	weight (kg) on/in the vehicle																											
The coastdown times after performing the vehicle coast down procedure according paragraph 4.3.1.3 of Annex XXI, Sub-Annex 4 Annex XXI, Sub-Annex 4, §8.2.4.2.	:	<table border="1"> <thead> <tr> <th data-bbox="991 530 1166 629">Vehicle speed (km/h)</th> <th data-bbox="1166 530 1340 629">Coastdown time (s)</th> </tr> </thead> <tbody> <tr> <td data-bbox="991 629 1166 680">125-115</td> <td data-bbox="1166 629 1340 680"></td> </tr> <tr> <td data-bbox="991 680 1166 732">115-105</td> <td data-bbox="1166 680 1340 732"></td> </tr> <tr> <td data-bbox="991 732 1166 784">105-95</td> <td data-bbox="1166 732 1340 784"></td> </tr> <tr> <td data-bbox="991 784 1166 835">95-85</td> <td data-bbox="1166 784 1340 835"></td> </tr> <tr> <td data-bbox="991 835 1166 887">85-75</td> <td data-bbox="1166 835 1340 887"></td> </tr> <tr> <td data-bbox="991 887 1166 938">75-65</td> <td data-bbox="1166 887 1340 938"></td> </tr> <tr> <td data-bbox="991 938 1166 990">65-55</td> <td data-bbox="1166 938 1340 990"></td> </tr> <tr> <td data-bbox="991 990 1166 1041">55-45</td> <td data-bbox="1166 990 1340 1041"></td> </tr> <tr> <td data-bbox="991 1041 1166 1093">45-35</td> <td data-bbox="1166 1041 1340 1093"></td> </tr> <tr> <td data-bbox="991 1093 1166 1144">35-25</td> <td data-bbox="1166 1093 1340 1144"></td> </tr> <tr> <td data-bbox="991 1144 1166 1196">25-15</td> <td data-bbox="1166 1144 1340 1196"></td> </tr> <tr> <td data-bbox="991 1196 1166 1227">15-05</td> <td data-bbox="1166 1196 1340 1227"></td> </tr> </tbody> </table>		Vehicle speed (km/h)	Coastdown time (s)	125-115		115-105		105-95		95-85		85-75		75-65		65-55		55-45		45-35		35-25		25-15		15-05	
		Vehicle speed (km/h)	Coastdown time (s)																										
		125-115																											
		115-105																											
		105-95																											
		95-85																											
		85-75																											
		75-65																											
		65-55																											
		55-45																											
		45-35																											
35-25																													
25-15																													
15-05																													
NOx converter efficiency Indicated concentrations (a); (b), (c), (d), and the concentration when the NOx analyser is in the NO mode so that the calibration gas does not pass through the converter Annex XXI, Sub-Annex 5, §5.5	:	(a)= (b)= (c)= (d)= Concentration in NO mode=																											
The distance actually driven by the vehicle Annex XXI, Sub-Annex 6, §1.2.6.4.6. and 1.2.12.6.	:																												
For manual shift transmission vehicle, MT vehicle that cannot follow the cycle trace:																													
The deviations from the driving cycle	:																												
Annex XXI, Sub-Annex 6, §1.2.6.5.1																													
Drive trace indices:																													

Status: Point in time view as at 01/06/2017.

Changes to legislation: There are outstanding changes not yet made to Commission Regulation (EU) 2017/1151. Any changes that have already been made to the legislation appear in the content and are referenced with annotations. (See end of Document for details)

The following indices shall be calculated according to SAE J2951(Revised JAN2014):		
(a) : Energy Rating ER	:	
(b) : Distance Rating DR	:	
(c) : Energy Economy EER Rating	:	
(d) : Absolute Speed ASCR Change Rating	:	
(e) : Inertial Work Rating IWR	:	
(f) : Root Mean Squared RMSSSpeed Error	:	
Annex XXI, Sub-Annex 6, §1.2.8.5. and 7.		
Particulate sample filter weighing		
Filter before the test	:	
Filter after the test	:	
Reference filter	:	
Annex XXI, Sub-Annex 6, §1.2.10.1.2 and 1.2.14.3.1		
Content of each of the compounds measured after stabilization of the measuring device Annex XXI, Sub-Annex 6, §1.2.14.2.8	:	
Regeneration factor determination		
The number of cycles D between two WLTCs where regeneration events occur	:	
The number of cycles over which emission measurements are made n	:	
The mass emissions measurement M'_{sij} for each compound i over each cycle j	:	

Status: Point in time view as at 01/06/2017.

Changes to legislation: There are outstanding changes not yet made to Commission Regulation (EU) 2017/1151. Any changes that have already been made to the legislation appear in the content and are referenced with annotations. (See end of Document for details)

Annex XXI, Sub-Annex 6, Appendix 1, §2.1.3.		
Regeneration factor determination		
The number of applicable test cycles d measured for complete regeneration	:	
Annex XXI, Sub-Annex 6, Appendix 1, § 2.2.6.		
Regeneration factor determination		
M_{si}	:	
M_{pi}	:	
K_i	:	
Annex XXI, Sub-Annex 6, Appendix 1, §3.1.1		
ATCT		
The air temperature and humidity of the test cell measured at the vehicle cooling fan outlet at a minimum frequency of 1 Hz.	:	Temperature set point = T_{reg}
Annex XXI, Sub-Annex 6a, §3.2.1.1.		Actual temperature value $\pm 3\text{ }^{\circ}\text{C}$ at the start of the test $\pm 5\text{ }^{\circ}\text{C}$ during the test
The temperature of the soak area measured continuously at a minimum frequency of 1 Hz.	:	Temperature set point = T_{reg}
Annex XXI, Sub-Annex 6a, §3.2.2.1.		Actual temperature value $\pm 3\text{ }^{\circ}\text{C}$ at the start of the test $\pm 5\text{ }^{\circ}\text{C}$ during the test
The time of transfer from the preconditioning to the soak area Annex XXI, Sub-Annex 6a, §3.6.2.	:	≤ 10 minutes
The time between the end of the Type 1 test and the cool down procedure	:	≤ 10 minutes
The measured soaking time, and shall be recorded in all relevant test sheets.	:	time between the measurement of the end temperature and the end of the Type 1 test at $23\text{ }^{\circ}\text{C}$

Status: Point in time view as at 01/06/2017.

Changes to legislation: There are outstanding changes not yet made to Commission Regulation (EU) 2017/1151. Any changes that have already been made to the legislation appear in the content and are referenced with annotations. (See end of Document for details)

Annex XXI, Sub-Annex 6a, §3.9.2.		
-------------------------------------	--	--

ANNEX II

IN-SERVICE CONFORMITY

1. INTRODUCTION

1.1. This Annex sets out the tailpipe emissions and OBD (inclusive IUPR_M) in-service conformity requirements for vehicles type approved to this Regulation.

2. REQUIREMENTS

The in-service conformity requirements shall be those specified in paragraph 9 and Appendices 3, 4 and 5 of UN/ECE Regulation No 83 with exceptions described in the following sections.

2.1. Paragraph 9.2.1. of UN/ECE Regulation No 83 shall be understood as being as follows:

The audit of in-service conformity by the approval authority shall be conducted on the basis of any relevant information that the manufacturer has, under the same procedures as those for the conformity of production defined in Article 12(1) and (2) of Directive 2007/46/EC and in points 1 and 2 of Annex X to that Directive. If information is provided to the approval authority from any approval authority or Member State surveillance testing, it shall complement the in-service monitoring reports supplied by the manufacturer.

2.2. Paragraph 9.3.5.2 of UN/ECE Regulation No 83 shall be amended with the addition of the following new sub-paragraph:

...

Vehicles of small series productions with less than 1 000 vehicles per OBD family are exempted from minimum IUPR requirements as well as the requirement to demonstrate these to the approval authority.

2.3. References to ‘Contracting Parties’ shall be understood as references to ‘Member States’.

2.4. Paragraph 2.6. of Appendix 3 to UN/ECE Regulation No 83 shall be replaced with the following:

The vehicle shall belong to a vehicle type that is type-approved under this Regulation and covered by a certificate of conformity in accordance with Directive 2007/46/EC. It shall be registered and have been used in the Union.

2.5. The reference in paragraph 2.2. of Appendix 3 to UN/ECE Regulation No 83 to the ‘1958 Agreement’ shall be understood as reference to Directive 2007/46/EC.

2.6. Paragraph 2.6. of Appendix 3 to UN/ECE Regulation No 83 shall be replaced with the following:

The lead content and sulphur content of a fuel sample from the vehicle tank shall meet the applicable standards laid down in Directive 2009/30/EC of the European Parliament and of the Council⁽²¹⁾ and there shall be no evidence of mis-fuelling. Checks may be done in the tailpipe.

Status: Point in time view as at 01/06/2017.

Changes to legislation: There are outstanding changes not yet made to Commission Regulation (EU) 2017/1151. Any changes that have already been made to the legislation appear in the content and are referenced with annotations. (See end of Document for details)

- 2.7. Reference in paragraph 4.1. of Appendix 3 to UN/ECE Regulation No 83 to ‘emissions tests in accordance with Annex 4a’ shall be understood as being to ‘emissions tests conducted in accordance with Annex XXI to this Regulation’.
- 2.8. Reference in paragraph 4.1. of Appendix 3 to UN/ECE Regulation No 83 to ‘paragraph 6.3. of Annex 4a’ shall be understood as being to ‘paragraph 1.2.6. of Sub-Annex 6 to Annex XXI to this Regulation’.
- 2.9. Reference in paragraph 4.4. of Appendix 3 to UN/ECE Regulation No 83 to ‘the 1958 Agreement’ shall be understood as reference to ‘Article 13(1) or (2) of Directive 2007/46/EC’.
- 2.10. In paragraph 3.2.1., paragraph 4.2. and footnotes 1 and 2 of Appendix 4 to UN/ECE Regulation No 83, the reference to the limit values given in Table 1 of paragraph 5.3.1.4. shall be understood as reference to Table 1 of Annex I to Regulation (EC) No 715/2007.

ANNEX III

[Reserved]

ANNEX IIIA

VERIFYING REAL DRIVING EMISSIONS

1. INTRODUCTION, DEFINITIONS AND ABBREVIATIONS

1.1. Introduction

This Annex describes the procedure to verify the Real Driving Emissions (RDE) performance of light passenger and commercial vehicles.

1.2. Definitions

1.2.1. ‘Accuracy’ means the deviation between a measured or calculated value and a traceable reference value.

1.2.2. ‘Analyser’ means any measurement device that is not part of the vehicle but installed to determine the concentration or the amount of gaseous or particle pollutants.

1.2.3. ‘Axis intercept’ of a linear regression (a_0) means:

$$a_0 = \bar{y} - (a_1 \times \bar{x})$$

where:

a_1

is the slope of the regression line

is the mean value of the reference parameter

\bar{x}

is the mean value of the parameter to be verified

\bar{y}

Status: Point in time view as at 01/06/2017.

Changes to legislation: There are outstanding changes not yet made to Commission Regulation (EU) 2017/1151. Any changes that have already been made to the legislation appear in the content and are referenced with annotations. (See end of Document for details)

1.2.4. ‘*Calibration*’ means the process of setting the response of an analyser, flow-measuring instrument, sensor, or signal so that its output agrees with one or multiple reference signals.

1.2.5. ‘*Coefficient of determination*’ (r^2) means:

$$r^2 = 1 - \frac{\sum_{i=1}^{n-1} (y_i - a_0 - a_1 x_i)^2}{\sum_{i=1}^{n-1} (y_i - \bar{y})^2}$$

where:

a_0	is the axis intercept of the linear regression line
a_1	is the slope of the linear regression line
x_i	is the measured reference value
y_i	is the measured value of the parameter to be verified
\bar{y}	is the mean value of the parameter to be verified
n	is the number of values

1.2.6. ‘*Cross-correlation coefficient*’ (r) means:

$$r = \frac{\sum_{i=1}^{n-1} (x_i - \bar{x})(y_i - \bar{y})}{\sqrt{\sum_{i=1}^{n-1} (x_i - \bar{x})^2} \times \sqrt{\sum_{i=1}^{n-1} (y_i - \bar{y})^2}}$$

where:

x_i	is the measured reference value
y_i	is the measured value of the parameter to be verified
\bar{x}	is the mean reference value
\bar{y}	is the mean value of the parameter to be verified
n	is the number of values

1.2.7. ‘*Delay time*’ means the time from the gas flow switching (t_0) until the response reaches 10 per cent (t_{10}) of the final reading.

1.2.8. ‘*Engine control unit (ECU) signals or data*’ means any vehicle information and signal recorded from the vehicle network using the protocols specified in point 3.4.5. of Appendix 1.

1.2.9. ‘*Engine control unit*’ means the electronic unit that controls various actuators to ensure the optimal performance of the powertrain.

1.2.10. ‘*Emissions*’ also referred to as ‘*components*’, ‘*pollutant components*’ or ‘*pollutant emissions*’ means the regulated gaseous or particle constituents of the exhaust.

1.2.11. ‘*Exhaust*’, also referred to as exhaust gas, means the total of all gaseous and particulate components emitted at the exhaust outlet or tailpipe as the result of fuel combustion within the vehicle’s internal combustion engine.

1.2.12. ‘*Exhaust emissions*’ means the emissions of particles, characterized as particulate matter and particle number, and of gaseous components at the tailpipe of a vehicle.

1.2.13. ‘*Full scale*’ means the full range of an analyser, flow-measuring instrument or sensor as specified by the equipment manufacturer. If a sub-range of the analyser, flow-measuring instrument or sensor is used for measurements, full scale shall be understood as the maximum reading.

Status: Point in time view as at 01/06/2017.

Changes to legislation: There are outstanding changes not yet made to Commission Regulation (EU) 2017/1151. Any changes that have already been made to the legislation appear in the content and are referenced with annotations. (See end of Document for details)

- 1.2.14. ‘*Hydrocarbon response factor*’ of a particular hydrocarbon species means the ratio between the reading of a FID and the concentration of the hydrocarbon species under consideration in the reference gas cylinder, expressed as ppmC₁.
- 1.2.15. ‘*Major maintenance*’ means the adjustment, repair or replacement of an analyser, flow-measuring instrument or sensor that could affect the accuracy of measurements.
- 1.2.16. ‘*Noise*’ means two times the root mean square of ten standard deviations, each calculated from the zero responses measured at a constant recording frequency of at least 1.0 Hz during a period of 30 seconds.
- 1.2.17. ‘*Non-methane hydrocarbons*’ (NMHC) means the total hydrocarbons (THC) excluding methane (CH₄).
- 1.2.18. ‘*Particle number*’ (PN) means as the total number of solid particles emitted from the vehicle exhaust as defined by the measurement procedure provided for by this Regulation for assessing compliance with the respective Euro 6 emission limit defined in Table 2 of Annex I to Regulation 715/2007.
- 1.2.19. ‘*Precision*’ means 2.5 times the standard deviation of 10 repetitive responses to a given traceable standard value.
- 1.2.20. ‘*Reading*’ means the numerical value displayed by an analyser, flow-measuring instrument, sensor or any other measurement device applied in the context of vehicle emission measurements.
- 1.2.21. ‘*Response time*’ (*t*₉₀) means the sum of the delay time and the rise time.
- 1.2.22. ‘*Rise time*’ means the time between the 10 per cent and 90 per cent response (*t*₉₀ – *t*₁₀) of the final reading.
- 1.2.23. ‘*Root mean square*’ (*x*_{rms}) means the square root of the arithmetic mean of the squares of values and defined as:
- $$x_{\text{rms}} = \sqrt{\frac{1}{n}(x_1^2 + x_2^2 + \dots + x_n^2)}$$
- where:
- | | |
|----------|-------------------------------------|
| <i>x</i> | is the measured or calculated value |
| <i>n</i> | is the number of values |
- 1.2.24. ‘*Sensor*’ means any measurement device that is not part of the vehicle itself but installed to determine parameters other than the concentration of gaseous and particle pollutants and the exhaust mass flow.
- 1.2.25. ‘*Span*’ means the calibration of an analyser, flow-measuring instrument, or sensor so that it gives an accurate response to a standard that matches as closely as possible the maximum value expected to occur during the actual emissions test.
- 1.2.26. ‘*Span response*’ means the mean response to a span signal over a time interval of at least 30 seconds.
- 1.2.27. ‘*Span response drift*’ means the difference between the mean response to a span signal and the actual span signal that is measured at a defined time period after an analyser, flow-measuring instrument or sensor was accurately spanned.
- 1.2.28. ‘*Slope*’ of a linear regression (*a*₁) means:

Status: Point in time view as at 01/06/2017.

Changes to legislation: There are outstanding changes not yet made to Commission Regulation (EU) 2017/1151. Any changes that have already been made to the legislation appear in the content and are referenced with annotations. (See end of Document for details)

$$a_1 = \frac{\sum_{i=1}^{n-1} (y_i - \bar{y}) \times (x_i - \bar{x})}{\sum_{i=1}^{n-1} (x_i - \bar{x})^2}$$

where:

\bar{x}	is the mean value of the reference parameter
\bar{y}	is the mean value of the parameter to be verified
x_i	is the actual value of the reference parameter
y_i	is the actual value of the parameter to be verified
n	is the number of values

1.2.29. ‘Standard error of estimate’ (SEE) means:

$$SEE = \frac{1}{x_{\max}} \times \sqrt{\frac{\sum_{i=1}^{n-1} (y_i - \hat{y})^2}{(n-2)}}$$

where:

\hat{y}	is the estimated value of the parameter to be verified
y_i	is the actual value of the parameter to be verified
x_{\max}	is the maximum actual value of the reference parameter
n	is the number of values

1.2.30. ‘Total hydrocarbons’ (THC) means the sum of all volatile compounds measurable by a flame ionization detector (FID).

1.2.31. ‘Traceable’ means the ability to relate a measurement or reading through an unbroken chain of comparisons to a known and commonly agreed standard.

1.2.32. ‘Transformation time’ means the time difference between a change of concentration or flow (t_0) at the reference point and a system response of 50 per cent of the final reading (t_{50}).

1.2.33. ‘Type of analyser’, also referred to as ‘analyser type’ means a group of analysers produced by the same manufacturer that apply an identical principle to determine the concentration of one specific gaseous component or the number of particles.

1.2.34. ‘Type of exhaust mass flow meter’ means a group of exhaust mass flow meters produced by the same manufacturer that share a similar tube inner diameter and function on an identical principle to determine the mass flow rate of the exhaust gas.

1.2.35. ‘Validation’ means the process of evaluating the correct installation and functionality of a Portable Emissions Measurement System and the correctness of exhaust mass flow rate measurements as obtained from one or multiple non-traceable exhaust mass flow meters or as calculated from sensors or ECU signals.

1.2.36. ‘Verification’ means the process of evaluating whether the measured or calculated output of an analyser, flow-measuring instrument, sensor or signal agrees with a reference signal within one or more predetermined thresholds for acceptance.

1.2.37. ‘Zero’ means the calibration of an analyser, flow-measuring instrument or sensor so that it gives an accurate response to a zero signal.

1.2.38. ‘Zero response’ means the mean response to a zero signal over a time interval of at least 30 seconds.

Status: Point in time view as at 01/06/2017.

Changes to legislation: There are outstanding changes not yet made to Commission Regulation (EU) 2017/1151. Any changes that have already been made to the legislation appear in the content and are referenced with annotations. (See end of Document for details)

1.2.39. ‘Zero response drift’ means the difference between the mean response to a zero signal and the actual zero signal that is measured over a defined time period after an analyser, flow-measuring instrument or sensor has been accurately zero calibrated.

1.3. Abbreviations

Abbreviations refer generically to both the singular and the plural forms of abbreviated terms.

CH ₄	— Methane
CLD	— ChemiLuminescence Detector
CO	— Carbon Monoxide
CO ₂	— Carbon Dioxide
CVS	— Constant Volume Sampler
DCT	— Dual Clutch Transmission
ECU	— Engine Control Unit
EFM	— Exhaust mass Flow Meter
FID	— Flame Ionisation Detector
FS	— full scale
GPS	— Global Positioning System
H ₂ O	— Water
HC	— HydroCarbons
HCLD	— Heated ChemiLuminescence Detector
HEV	— Hybrid Electric Vehicle
ICE	— Internal Combustion Engine
ID	— identification number or code
LPG	— Liquid Petroleum Gas
MAW	— Moving Average Window
max	— maximum value
N ₂	— Nitrogen
NDIR	— Non-Dispersive InfraRed analyser
NDUV	— Non-Dispersive UltraViolet analyser
NEDC	— New European Driving Cycle
NG	— Natural Gas
NMC	— Non-Methane Cutter
NMC-FID	— Non-Methane Cutter in combination with a Flame-Ionisation Detector
NMHC	— Non-Methane HydroCarbons
NO	— Nitrogen Monoxide
No.	— number
NO ₂	— Nitrogen Dioxide
NO _x	— Nitrogen Oxides
NTE	— Not-to-exceed
O ₂	— Oxygen
OBD	— On-Board Diagnostics
PEMS	— Portable Emissions Measurement System
PHEV	— Plug-in Hybrid Electric Vehicle
PN	— particle number
RDE	— Real Driving Emissions
RPA	— Relative Positive Acceleration
SCR	— Selective Catalytic Reduction
SEE	— Standard Error of Estimate
THC	— Total HydroCarbons
UN/ECE	— United Nations Economic Commission for Europe
VIN	— Vehicle Identification Number

Status: Point in time view as at 01/06/2017.

Changes to legislation: There are outstanding changes not yet made to Commission Regulation (EU) 2017/1151. Any changes that have already been made to the legislation appear in the content and are referenced with annotations. (See end of Document for details)

WLTC — Worldwide harmonized Light vehicles Test Cycle
 WWH-OBD — WorldWide Harmonised On-Board Diagnostics

2. GENERAL REQUIREMENTS

2.1 Not-to-exceed emission limits

Throughout the normal life of a vehicle type approved according to Regulation (EC) No 715/2007, its emissions determined in accordance with the requirements of this Annex and emitted at any possible RDE test performed in accordance with the requirements of this Annex, shall not be higher than the following pollutant-specific not-to-exceed (NTE) values:

$$NTE_{\text{pollutant}} = CF_{\text{pollutant}} \times TF(p_1, \dots, p_n) \times \text{EURO-6}$$

where EURO-6 is the applicable Euro 6 emission limit laid down in Table 2 of Annex I to Regulation (EC) No 715/2007.

2.1.1 Final Conformity Factors

The conformity factor $CF_{\text{pollutant}}$ for the respective pollutant is specified as follows:

Pollutant	Mass of oxides of nitrogen (NO _x)	Number of particles (PN)	Mass of carbon monoxide (CO) ^a	Mass of total hydrocarbons (THC)	Combined mass of total hydrocarbons and oxides of nitrogen (THC + NO _x)
$CF_{\text{pollutant}}$	1 + margin with margin = 0,5	to be determined	—	—	—

a CO emissions shall be measured and recorded at RDE tests. *margin* is a parameter taking into account the additional measurement uncertainties introduced by the PEMS equipment, which are subject to an annual review and shall be revised as a result of the improved quality of the PEMS procedure or technical progress.

2.1.2 Temporary Conformity Factors

By way of exception to the provisions of point 2.1.1, during a period of 5 years and 4 months following the dates specified in Article 10(4) and (5) of Regulation (EC) 715/2007 and upon request of the manufacturer, the following temporary conformity factors may apply:

Pollutant	Mass of oxides of nitrogen (NO _x)	Number of particles (PN)	Mass of carbon monoxide (CO) ^a	Mass of total hydrocarbons (THC)	Combined mass of total hydrocarbons and oxides of nitrogen (THC + NO _x)
$CF_{\text{pollutant}}$	2,1	to be determined	—	—	—

a CO emissions shall be measured and recorded at RDE tests.

Status: Point in time view as at 01/06/2017.

Changes to legislation: There are outstanding changes not yet made to Commission Regulation (EU) 2017/1151. Any changes that have already been made to the legislation appear in the content and are referenced with annotations. (See end of Document for details)

The application of temporary conformity factors shall be recorded in the certificate of conformity of the vehicle.

2.1.3 Transfer functions

The transfer function $TF(p_1, \dots, p_n)$ referred to in point 2.1 is set to 1 for the entire range of parameters p_i ($i = 1, \dots, n$).

If the transfer function $TF(p_1, \dots, p_n)$ is amended, this shall be done in a manner which is not detrimental to the environmental impact and the effectiveness of the RDE test procedures. In particular the following condition shall hold:

$$\int TF(p_1, \dots, p_n) \times Q(p_1, \dots, p_n) dp = \int Q(p_1, \dots, p_n) dp$$

Where:

- dp represents the integral over the entire space of the parameters p_i ($i = 1, \dots, n$)
 - $Q(p_1, \dots, p_n)$, is the probability density of an event corresponding to the parameters p_i ($i = 1, \dots, n$) in real driving The manufacturer shall confirm compliance with point 2.1 by completing the certificate set out in Appendix 9.
- 2.2. The RDE tests required by this Annex at type approval and during the lifetime of a vehicle provide a presumption of conformity with the requirement set out in point 2.1. The presumed conformity may be reassessed by additional RDE tests.
 - 2.3. Member States shall ensure that vehicles can be tested with PEMS on public roads in accordance with the procedures under their own national law, while respecting local road traffic legislation and safety requirements.
 - 2.4. Manufacturers shall ensure that vehicles can be tested with PEMS by an independent party on public roads, e.g. by making available suitable adapters for exhaust pipes, granting access to ECU signals and making the necessary administrative arrangements. If the respective PEMS test is not required by this Regulation the manufacturer may charge a reasonable fee as set out in Article 7(1) of Regulation (EC) No 715/2007.
- ### 3. RDE TEST TO BE PERFORMED
- 3.1. The following requirements apply to PEMS tests referred to in Article 3(10), second sub-paragraph.
 - 3.1.0. The requirements of point 2.1 shall be fulfilled for the urban part and the complete PEMS trip. Upon the choice of the manufacturer the conditions of at least one of the two points below shall be fulfilled:
 - 3.1.0.1. $M_{gas,d,t} \leq NTE_{pollutant}$ and $M_{gas,d,u} \leq NTE_{pollutant}$ with the definitions of point 2.1 of this Annex and points 6.1 and 6.3 of Appendix 5 and the setting $gas = pollutant$.
 - 3.1.0.2. $M_{w,gas,d} \leq NTE_{pollutant}$ and $M_{w,gas,d,u} \leq NTE_{pollutant}$ with the definitions of point 2.1 of this Annex and point 3.9 of Appendix 6 and the setting $gas = pollutant$.
 - 3.1.1. For type approval, the exhaust mass flow shall be determined by measurement equipment functioning independently from the vehicle and no vehicle ECU data shall be used in this respect. Outside the type approval context, alternative methods to determine the exhaust mass flow can be used according to Appendix 2, Section 7.2.
 - 3.1.2. If the approval authority is not satisfied with the data quality check and validation results of a PEMS test conducted according to Appendices 1 and 4, the approval

Status: Point in time view as at 01/06/2017.

Changes to legislation: There are outstanding changes not yet made to Commission Regulation (EU) 2017/1151. Any changes that have already been made to the legislation appear in the content and are referenced with annotations. (See end of Document for details)

authority may consider the test to be void. In such case, the test data and the reasons for voiding the test shall be recorded by the approval authority.

3.1.3. Reporting and dissemination of RDE test information

3.1.3.1. A technical report prepared by the manufacturer in accordance with Appendix 8 shall be made available to the approval authority.

3.1.3.2. The manufacturer shall ensure that the following information is made available on a publicly accessible website without costs:

3.1.3.2.1. By entering the vehicle type approval number and the information on type, variant and version as defined in sections 0.10 and 0.2 of the vehicle's EC certificate of conformity provided by Annex IX of Directive (EC) 2007/46, the unique identification number of a PEMS test family to which a given vehicle emission type belongs, as set out in point 5.2 of Appendix 7.

3.1.3.2.2. By entering the unique identification number of a PEMS test family:

- the full information as required by point 5.1 of Appendix 7,
- the lists described in points 5.3 and 5.4 of Appendix 7;
- the results of the PEMS tests as set out in points 6.3 of Appendix 5 and 3.9 of Appendix 6 for all vehicle emission types in the list described in point 5.4 of Appendix 7.

3.1.3.3. Upon request, without costs and within 30 days, the manufacturer shall make available the technical report referred to in point 3.1.3.1 to any interested party.

3.1.3.4. Upon request, the type approval authority shall make available the information listed under points 3.1.3.1 and 3.1.3.2 within 30 days of receiving the request. The type approval authority may charge a reasonable and proportionate fee, which does not discourage an inquirer with a justified interest from requesting the respective information or exceed the internal costs of the authority for making the requested information available.

4. GENERAL REQUIRMENTS

4.1. The RDE performance shall be demonstrated by testing vehicles on the road operated over their normal driving patterns, conditions and payloads. The RDE test shall be representative for vehicles operated on their real driving routes, with their normal load.

4.2. The manufacturer shall demonstrate to the approval authority that the chosen vehicle, driving patterns, conditions and payloads are representative for the vehicle family. The payload and altitude requirements, as specified in points 5.1 and 5.2, shall be used ex-ante to determine whether the conditions are acceptable for RDE testing.

4.3. The approval authority shall propose a test trip in urban, rural and motorway environments meeting the requirements of point 6. For the purpose of trip selection, the definition of urban, rural and motorway operation shall be based on a topographic map.

4.4. If for a vehicle the collection of ECU data influences the vehicle's emissions or performance the entire PEMS test family to which the vehicle belongs as defined in Appendix 7 shall be considered as non-compliant. Such functionality shall be considered as a 'defeat device' as defined in Article 3(10) of Regulation (EC) 715/2007.

5. BOUNDARY CONDITIONS

Status: Point in time view as at 01/06/2017.

Changes to legislation: There are outstanding changes not yet made to Commission Regulation (EU) 2017/1151. Any changes that have already been made to the legislation appear in the content and are referenced with annotations. (See end of Document for details)

5.1. Vehicle payload and test mass

5.1.1. The vehicle's basic payload shall comprise the driver, a witness of the test (if applicable) and the test equipment, including the mounting and the power supply devices.

5.1.2. For the purpose of testing some artificial payload may be added as long as the total mass of the basic and artificial payload does not exceed 90% of the sum of the 'mass of the passengers' and the 'pay-mass' defined in points 19 and 21 of Article 2 of Commission Regulation (EU) No 1230/2012⁽²²⁾.

5.2. Ambient conditions

5.2.1. The test shall be conducted under ambient conditions laid down in this section. The ambient conditions become 'extended' when at least one of the temperature and altitude conditions is extended.

5.2.2. Moderate altitude conditions: Altitude lower or equal to 700 meters above sea level.

5.2.3. Extended altitude conditions: Altitude higher than 700 meters above sea level and lower or equal to 1300 meters above sea level.

5.2.4. Moderate temperature conditions: Greater than or equal to 273 K (0 °C) and lower than or equal to 303 K (30 °C)

5.2.5. Extended temperature conditions: Greater than or equal to 266 K (- 7 °C) and lower than 273 K (0 °C) or greater than 303 K (30 °C) and lower than or equal to 308 K (35 °C)

5.2.6. By way of derogation from the provisions of points 5.2.4 and 5.2.5 the lower temperature for moderate conditions shall be greater or equal to 276 K (3 °C) and the lower temperature for extended conditions shall be greater or equal to 271K (- 2 °C) between the start of the application of binding NTE emission limits as defined in section 2.1 and until five years after the dates given in paragraphs 4 and 5 of Article 10 of Regulation (EC) No 715/2007.

5.3. Not applicable.

5.4. Dynamic conditions

The dynamic conditions encompass the effect of road grade, head wind and driving dynamics (accelerations, decelerations) and auxiliary systems upon energy consumption and emissions of the test vehicle. The verification of the normality of dynamic conditions shall be done after the test is completed, using the recorded PEMS data. This verification shall be conducted in 2 steps:

5.4.1. The overall excess or insufficiency of driving dynamics during the trip shall be checked using the methods described in Appendix 7a to this Annex.

5.4.2. If the trip results as valid following the verifications according to point 5.4.1, the methods for verifying the normality of the test conditions as laid down in Appendices 5 and 6 to this Annex must be applied. Each method includes a reference for test conditions, ranges around the reference and the minimum coverage requirements to achieve a valid test.

5.5. Vehicle condition and operation

5.5.1. Auxiliary systems

Status: Point in time view as at 01/06/2017.

Changes to legislation: There are outstanding changes not yet made to Commission Regulation (EU) 2017/1151. Any changes that have already been made to the legislation appear in the content and are referenced with annotations. (See end of Document for details)

The air conditioning system or other auxiliary devices shall be operated in a way which corresponds to their possible use by a consumer at real driving on the road.

5.5.2. Vehicles equipped with periodically regenerating systems

5.5.2.1. 'Periodically regenerating systems' shall be understood according to the definition in Article 2(6).

5.5.2.2. If periodic regeneration occurs during a test, the test may be voided and repeated once at the request of the manufacturer.

5.5.2.3. The manufacturer may ensure the completion of the regeneration and precondition the vehicle appropriately prior to the second test.

5.5.2.4. If regeneration occurs during the repetition of the RDE test, pollutants emitted during the repeated test shall be included in the emissions evaluation.

6. TRIP REQUIREMENTS

6.1. The shares of urban, rural and motorway driving, classified by instantaneous speed as described in points 6.3 to 6.5, shall be expressed as a percentage of the total trip distance.

6.2. The trip sequence shall consist of urban driving followed by rural and motorway driving according to the shares specified in point 6.6. The urban, rural and motorway operation shall be run continuously. Rural operation may be interrupted by short periods of urban operation when driving through urban areas. Motorway operation may be interrupted by short periods of urban or rural operation, e.g., when passing toll stations or sections of road work. If another testing order is justified for practical reasons, the order of urban, rural and motorway operation may be altered, after obtaining approval from the approval authority.

6.3. Urban operation is characterised by vehicle speeds lower than or equal to 60 km/h.

6.4. Rural operation is characterised by vehicle speeds higher than 60 and lower than or equal to 90 km/h.

6.5. Motorway operation is characterised by speeds above 90 km/h.

6.6. The trip shall consist of approximately 34 % per cent urban, 33 % per cent rural and 33 % per cent motorway driving classified by speed as described in points 6.3 to 6.5 above. 'Approximately' shall mean the interval of ± 10 per cent points around the stated percentages. The urban driving shall however never be less than 29% of the total trip distance.

6.7. The vehicle velocity shall normally not exceed 145 km/h. This maximum speed may be exceeded by a tolerance of 15 km/h for not more than 3 % of the time duration of the motorway driving. Local speed limits remain in force during a PEMS test, notwithstanding other legal consequences. Violations of local speed limits per se do not invalidate the results of a PEMS test.

6.8. The average speed (including stops) of the urban driving part of the trip should be between 15 and 40 km/h. Stop periods, defined as vehicle speed of less than 1 km/h, shall account for 6 to 30 % of the time duration of urban operation. Urban operation shall contain several stop periods of 10s or longer. If a stop period lasts more the 180 s, the emission events during the 180 s following such an excessively long stop period shall be excluded from the emissions evaluation.

Status: Point in time view as at 01/06/2017.

Changes to legislation: There are outstanding changes not yet made to Commission Regulation (EU) 2017/1151. Any changes that have already been made to the legislation appear in the content and are referenced with annotations. (See end of Document for details)

6.9. The speed range of the motorway driving shall properly cover a range between 90 and at least 110 km/h. The vehicle's velocity shall be above 100 km/h for at least 5 minutes.

6.10. The trip duration shall be between 90 and 120 minutes.

6.11. The start and the end point shall not differ in their elevation above sea level by more than 100 m. In addition, the proportional cumulative positive altitude gain shall be less than 1 200 m/100km) and be determined according to Appendix 7b.

6.12. The minimum distance of each, the urban, rural and motorway operation shall be 16 km.

7. OPERATIONAL REQUIREMENTS

7.1. The trip shall be selected in such a way that the testing is uninterrupted and the data continuously recorded to reach the minimum test duration defined in point 6.10.

7.2. Electrical power shall be supplied to the PEMS by an external power supply unit and not from a source that draws its energy either directly or indirectly from the engine of the test vehicle.

7.3. The installation of the PEMS equipment shall be done in a way to influence the vehicle emissions or performance or both to the minimum extent possible. Care should be exercised to minimize the mass of the installed equipment and potential aerodynamic modifications of the test vehicle. The vehicle payload shall be in accordance with point 5.1.

7.4. RDE tests shall be conducted on working days as defined for the Union in Council Regulation (EEC, Euratom) No 1182/71⁽²³⁾

7.5. RDE tests shall be conducted on paved roads and streets (e.g. off road operation is not permitted).

7.6. Prolonged idling shall be avoided after the first ignition of the combustion engine at the beginning of the emissions test. If the engine stalls during the test, it may be restarted, but the sampling shall not be interrupted.

8. LUBRICATING OIL, FUEL AND REAGENT

8.1. The fuel, lubricant and reagent (if applicable) used for RDE testing shall be within the specifications issued by the manufacturer for vehicle operation by the customer.

8.2. Samples of fuel, lubricant and reagent (if applicable) shall be taken and kept for at least 1 year.

9. EMISSIONS AND TRIP EVALUATION

9.1. The test shall be conducted in accordance with Appendix 1 of this Annex.

9.2. The trip shall fulfil the requirements set out in points 4 to 8.

9.3. It shall not be permitted to combine data of different trips or to modify or remove data from a trip with exception of provisions for long stops as described in 6.8.

9.4. After establishing the validity of a trip according to Point 9.2 emission results shall be calculated using the methods laid down in Appendices 5 and 6 of this Annex.

Status: Point in time view as at 01/06/2017.

Changes to legislation: There are outstanding changes not yet made to Commission Regulation (EU) 2017/1151. Any changes that have already been made to the legislation appear in the content and are referenced with annotations. (See end of Document for details)

- 9.5. If during a particular time interval the ambient conditions are extended in accordance with point 5.2, the pollutant emissions during this particular time interval, calculated according to Appendix 4, shall be divided by a value of 1,6 before being evaluated for compliance with the requirements of this Annex. This provision does not apply to carbon dioxide emissions.
- 9.6. The cold start is defined in accordance with point 4 of Appendix 4 of this Annex. Until specific requirements for emissions at cold start are applied, the latter shall be recorded but excluded from the emissions evaluation.

Appendix 1

Test procedure for vehicle emissions testing with a Portable Emissions Measurement System (PEMS)

1. INTRODUCTION

This Appendix describes the test procedure to determine exhaust emissions from light passenger and commercial vehicles using a Portable Emissions Measurement System.

2. SYMBOLS, PARAMETERS AND UNITS

\leq	— smaller or equal
#	— number
$\#/m^3$	— number per cubic metre
%	— per cent
$^{\circ}C$	— degree centigrade
g	— gramme
g/s	— gramme per second
h	— hour
Hz	— hertz
K	— kelvin
kg	— kilogramme
kg/s	— kilogramme per second
km	— kilometre
km/h	— kilometre per hour
kPa	— kilopascal
kPa/min	— kilopascal per minute
l	— litre
l/min	— litre per minute
m	— metre
m^3	— cubic-metre
mg	— milligram
min	— minute
p_e	— evacuated pressure [kPa]
q_{vs}	— volume flow rate of the system [l/min]
ppm	— parts per million
ppmC ₁	— parts per million carbon equivalent
rpm	— revolutions per minute
s	— second
V_s	— system volume [l]

Status: Point in time view as at 01/06/2017.

Changes to legislation: There are outstanding changes not yet made to Commission Regulation (EU) 2017/1151. Any changes that have already been made to the legislation appear in the content and are referenced with annotations. (See end of Document for details)

3. GENERAL REQUIREMENTS

3.1. PEMS

The test shall be carried out with a PEMS, composed of components specified in points 3.1.1 to 3.1.5. If applicable, a connection with the vehicle ECU may be established to determine relevant engine and vehicle parameters as specified in point 3.2.

- 3.1.1. Analysers to determine the concentration of pollutants in the exhaust gas.
- 3.1.2. One or multiple instruments or sensors to measure or determine the exhaust mass flow.
- 3.1.3. A Global Positioning System to determine the position, altitude and, speed of the vehicle.
- 3.1.4. If applicable, sensors and other appliances being not part of the vehicle, e.g., to measure ambient temperature, relative humidity, air pressure, and vehicle speed.
- 3.1.5. An energy source independent of the vehicle to power the PEMS.

3.2. Test parameters

Test parameters as specified in Table 1 of this Appendix shall be measured, recorded at a constant frequency of 1.0 Hz or higher and reported according to the requirements of Appendix 8. If ECU parameters are obtained, these should be made available at a substantially higher frequency than the parameters recorded by PEMS. The PEMS analysers, flow-measuring instruments and sensors shall comply with the requirements laid down in Appendices 2 and 3 of this Annex.

TABLE 1

Test parameters

Parameter	Recommended unit	Source ^h
THC concentration ^{a, d}	ppm	Analyser
CH ₄ concentration ^{a, d}	ppm	Analyser
NMHC concentration ^{a, d}	ppm	Analyser ^f
CO concentration ^{a, d}	ppm	Analyser
CO ₂ concentration ^a	ppm	Analyser
NO _x concentration ^{a, d}	ppm	Analyser ^g

a to be measured on a wet basis or to be corrected as described in point 8.1 of Appendix 4

b to be determined only if indirect methods are used to calculate exhaust mass flow rate as described in paragraphs 10.2 and 10.3 of Appendix 4

c method to be chosen according to point 4.7

d parameter only mandatory if measurement required by Annex IIIA, section 2.1

e to be determined only if necessary to verify the vehicle status and operating conditions

f may be calculated from THC and CH₄ concentrations according to point 9.2 of Appendix 4

g may be calculated from measured NO and NO₂ concentrations

h Multiple parameter sources may be used.

i The preferable source is the ambient pressure sensor.

Status: Point in time view as at 01/06/2017.

Changes to legislation: There are outstanding changes not yet made to Commission Regulation (EU) 2017/1151. Any changes that have already been made to the legislation appear in the content and are referenced with annotations. (See end of Document for details)

PN concentration ^d	#/m ³	Analyser
Exhaust mass flow rate	kg/s	EFM, any methods described in point 7 of Appendix 2
Ambient humidity	%	Sensor
Ambient temperature	K	Sensor
Ambient pressure	kPa	Sensor
Vehicle speed	km/h	Sensor, GPS, or ECU ^e
Vehicle latitude	Degree	GPS
Vehicle longitude	Degree	GPS
Vehicle altitude ^{e, i}	M	GPS or Sensor
Exhaust gas temperature ^e	K	Sensor
Engine coolant temperature ^e	K	Sensor or ECU
Engine speed ^e	rpm	Sensor or ECU
Engine torque ^e	Nm	Sensor or ECU
Torque at driven axle ^e	Nm	Rim torque meter
Pedal position ^e	%	Sensor or ECU
Engine fuel flow ^b	g/s	Sensor or ECU
Engine intake air flow ^b	g/s	Sensor or ECU
Fault status ^e	—	ECU
Intake air flow temperature	K	Sensor or ECU
Regeneration status ^e	—	ECU
Engine oil temperature ^e	K	Sensor or ECU
Actual gear ^e	#	ECU
Desired gear (e.g. gear shift indicator) ^e	#	ECU

a to be measured on a wet basis or to be corrected as described in point 8.1 of Appendix 4

b to be determined only if indirect methods are used to calculate exhaust mass flow rate as described in paragraphs 10.2 and 10.3 of Appendix 4

c method to be chosen according to point 4.7

d parameter only mandatory if measurement required by Annex IIIA, section 2.1

e to be determined only if necessary to verify the vehicle status and operating conditions

f may be calculated from THC and CH₄ concentrations according to point 9.2 of Appendix 4

g may be calculated from measured NO and NO₂ concentrations

h Multiple parameter sources may be used.

i The preferable source is the ambient pressure sensor.

Status: Point in time view as at 01/06/2017.

Changes to legislation: There are outstanding changes not yet made to Commission Regulation (EU) 2017/1151. Any changes that have already been made to the legislation appear in the content and are referenced with annotations. (See end of Document for details)

Other vehicle data ^e	unspecified	ECU
a	to be measured on a wet basis or to be corrected as described in point 8.1 of Appendix 4	
b	to be determined only if indirect methods are used to calculate exhaust mass flow rate as described in paragraphs 10.2 and 10.3 of Appendix 4	
c	method to be chosen according to point 4.7	
d	parameter only mandatory if measurement required by Annex IIIA, section 2.1	
e	to be determined only if necessary to verify the vehicle status and operating conditions	
f	may be calculated from THC and CH ₄ concentrations according to point 9.2 of Appendix 4	
g	may be calculated from measured NO and NO ₂ concentrations	
h	Multiple parameter sources may be used.	
i	The preferable source is the ambient pressure sensor.	

3.3. Preparation of the vehicle

The preparation of the vehicle shall include a general verification of the correct technical functioning of the test vehicle.

3.4. Installation of PEMS

3.4.1. General

The installation of the PEMS shall follow the instructions of the PEMS manufacturer and the local health and safety regulations. The PEMS should be installed as to minimize during the test electromagnetic interferences as well as exposure to shocks, vibration, dust and variability in temperature. The installation and operation of the PEMS shall be leak-tight and minimize heat loss. The installation and operation of PEMS shall not change the nature of the exhaust gas nor unduly increase the length of the tailpipe. To avoid the generation of particles, connectors shall be thermally stable at the exhaust gas temperatures expected during the test. It is recommended to avoid the use of a material which may emit volatile components to connect the vehicle exhaust outlet and the connecting tube. Elastomer connectors, if used, shall have a minimum exposure to the exhaust gas to avoid artefacts at high engine load.

3.4.2. Permissible backpressure

The installation and operation of the PEMS shall not unduly increase the static pressure at the exhaust outlet. If technically feasible, any extension to facilitate the sampling or connection with the exhaust mass flow meter shall have an equivalent, or larger, cross sectional area than the exhaust pipe.

3.4.3. Exhaust mass flow meter

Whenever used, the exhaust mass flow meter shall be attached to the vehicle's tailpipe(s) according to the recommendations of the EFM manufacturer. The measurement range of the EFM shall match the range of the exhaust mass flow rate expected during the test. The installation of the EFM and any exhaust pipe adaptors or junctions shall not adversely affect the operation of the engine or exhaust after-treatment system. A minimum of four pipe diameters or 150 mm of straight tubing, whichever is larger, shall be placed at either side of the flow-sensing element. When testing a multi-cylinder engine with a branched exhaust manifold, it is recommended to combine the manifolds upstream of the exhaust mass flow meter and to increase the cross section of the piping appropriately as to minimize backpressure in the exhaust. If this is not feasible, exhaust flow measurements with several exhaust mass flow meters shall be considered. The wide variety of exhaust pipe configurations, dimensions and exhaust mass

Status: Point in time view as at 01/06/2017.

Changes to legislation: There are outstanding changes not yet made to Commission Regulation (EU) 2017/1151. Any changes that have already been made to the legislation appear in the content and are referenced with annotations. (See end of Document for details)

flow rates may require compromises, guided by good engineering judgement, when selecting and installing the EFM(s). If measurement accuracy requires, it is permissible to install an EFM with a diameter smaller than that of the exhaust outlet or the total cross-sectional area of multiple outlets, providing it does not adversely affect the operation or the exhaust after-treatment as specified in point 3.4.2.

3.4.4. *Global Positioning System (GPS)*

The GPS antenna should be mounted, e.g. at the highest possible location, as to ensure good reception of the satellite signal. The mounted GPS antenna shall interfere as little as possible with the vehicle operation.

3.4.5. *Connection with the Engine Control Unit (ECU)*

If desired, relevant vehicle and engine parameters listed in Table 1 can be recorded by using a data logger connected with the ECU or the vehicle network through standards, such as ISO 15031-5 or SAE J1979, OBD-II, EOBD or WWH-OBD. If applicable, manufacturers shall disclose labels to allow the identification of required parameters.

3.4.6. *Sensors and auxiliary equipment*

Vehicle speed sensors, temperature sensors, coolant thermocouples or any other measurement device not part of the vehicle shall be installed to measure the parameter under consideration in a representative, reliable and accurate manner without unduly interfering with the vehicle operation and the functioning of other analysers, flow-measuring instruments, sensors and signals. Sensors and auxiliary equipment shall be powered independently of the vehicle. It is permitted to power any safety-related illumination of fixtures and installations of PEMS components outside of the vehicle's cabin by the vehicle's battery.

3.5. **Emissions sampling**

Emissions sampling shall be representative and conducted at locations of well-mixed exhaust where the influence of ambient air downstream of the sampling point is minimal. If applicable, emissions shall be sampled downstream of the exhaust mass flow meter, respecting a distance of at least 150 mm to the flow sensing element. The sampling probes shall be fitted at least 200 mm or three times the inner diameter of the exhaust pipe, whichever is larger, upstream of the point at which the exhaust exits the PEMS sampling installation into the environment. If the PEMS feeds back a flow to the tail pipe, this shall occur downstream of the sampling probe in a manner that does not affect during engine operation the nature of the exhaust gas at the sampling point(s). If the length of the sampling line is changed, the system transport times shall be verified and if necessary corrected.

If the engine is equipped with an exhaust after-treatment system, the exhaust sample shall be taken downstream of the exhaust after-treatment system. When testing a vehicle with a multi-cylinder engine and branched exhaust manifold, the inlet of the sampling probe shall be located sufficiently far downstream so as to ensure that the sample is representative of the average exhaust emissions of all cylinders. In multi-cylinder engines, having distinct groups of manifolds, such as in a 'V' engine configuration, the manifolds shall be combined upstream of the sampling probe. If this is technically not feasible, multi-point sampling at locations of well-mixed exhaust free of ambient air shall be considered. In this case, the number and location of sampling probes shall match as far as possible those of the exhaust mass flow meters. In case of unequal exhaust flows, proportional sampling or sampling with multiple analysers shall be considered.

Status: Point in time view as at 01/06/2017.

Changes to legislation: There are outstanding changes not yet made to Commission Regulation (EU) 2017/1151. Any changes that have already been made to the legislation appear in the content and are referenced with annotations. (See end of Document for details)

If particles are measured, the exhaust shall be sampled from the centre of the exhaust stream. If several probes are used for emissions sampling, the particle sampling probe shall be placed upstream of the other sampling probes.

If hydrocarbons are measured, the sampling line shall be heated to 463 ± 10 K (190 ± 10 °C). For the measurement of other gaseous components with or without cooler, the sampling line shall be kept at a minimum of 333 K (60 °C) to avoid condensation and to ensure appropriate penetration efficiencies of the various gases. For low pressure sampling systems, the temperature can be lowered corresponding to the pressure decrease provided that the sampling system ensures a penetration efficiency of 95 % for all regulated gaseous pollutants. If particles are sampled, the sampling line from the raw exhaust sample point shall be heated to a minimum of 373 K (100 °C). The residence time of the sample in the particle sampling line shall be less than 3 s until reaching first dilution or the particle counter.

4. PRE-TEST PROCEDURES

4.1. PEMS leak check

After the installation of the PEMS is completed, a leak check shall be performed at least once for each PEMS-vehicle installation as prescribed by the PEMS manufacturer or as follows. The probe shall be disconnected from the exhaust system and the end plugged. The analyser pump shall be switched on. After an initial stabilization period all flow meters shall read approximately zero in the absence of a leak. Else, the sampling lines shall be checked and the fault be corrected.

The leakage rate on the vacuum side shall not exceed 0.5 per cent of the in-use flow rate for the portion of the system being checked. The analyser flows and bypass flows may be used to estimate the in-use flow rate.

Alternatively, the system may be evacuated to a pressure of at least 20 kPa vacuum (80 kPa absolute). After an initial stabilization period the pressure increase Δp (kPa/min) in the system shall not exceed:

$$\Delta p = \frac{P_0}{V_0} \times q_{in} \times 0.005$$

Alternatively, a concentration step change at the beginning of the sampling line shall be introduced by switching from zero to span gas while maintaining the same pressure conditions as under normal system operation. If for a correctly calibrated analyser after an adequate period of time the reading is ≤ 99 per cent compared to the introduced concentration, the leakage problem shall be corrected.

4.2. Starting and stabilizing the PEMS

The PEMS shall be switched on, warmed up and stabilized according to the specifications of the PEMS manufacturer until, e.g., pressures, temperatures and flows have reached their operating set points.

4.3. Preparing the sampling system

The sampling system, consisting of the sampling probe, sampling lines and the analysers, shall be prepared for testing by following the instruction of the PEMS manufacturer. It shall be ensured that the sampling system is clean and free of moisture condensation.

4.4. Preparing the Exhaust mass Flow Meter (EFM)

If used for measuring the exhaust mass flow, the EFM shall be purged and prepared for operation in accordance with the specifications of the EFM manufacturer. This procedure shall, if applicable, remove condensation and deposits from the lines and the associated measurement ports.

Status: Point in time view as at 01/06/2017.

Changes to legislation: There are outstanding changes not yet made to Commission Regulation (EU) 2017/1151. Any changes that have already been made to the legislation appear in the content and are referenced with annotations. (See end of Document for details)

4.5. **Checking and calibrating the analysers for measuring gaseous emissions**

Zero and span calibration adjustments of the analysers shall be performed using calibration gases that meet the requirements of point 5 of Appendix 2. The calibration gases shall be chosen to match the range of pollutant concentrations expected during the RDE test. To minimize analyser drift, one should conduct the zero and span calibration of analysers at an ambient temperature that resembles, as closely as possible, the temperature experienced by the test equipment during the trip.

4.6. **Checking the analyser for measuring particle emissions**

The zero level of the analyser shall be recorded by sampling HEPA filtered ambient air. The signal shall be recorded at a constant frequency of at least 1.0 Hz over a period of 2 min and averaged; the permissible concentration value shall be determined once suitable measurement equipment becomes available.

4.7. **Determining vehicle speed**

Vehicle speed shall be determined by at least one of the following methods:

- (a) a GPS; if vehicle speed is determined by a GPS, the total trip distance shall be checked against the measurements of another method according to point 7 of Appendix 4.
- (b) a sensor (e.g., optical or micro-wave sensor); if vehicle speed is determined by a sensor, the speed measurements shall comply with the requirements of point 8 of Appendix 2, or alternatively, the total trip distance determined by the sensor shall be compared with a reference distance obtained from a digital road network or topographic map. The total trip distance determined by the sensor shall deviate by no more than 4 % from the reference distance.
- (c) the ECU; if vehicle speed is determined by the ECU, the total trip distance shall be validated according to point 3 of Appendix 3 and the ECU speed signal adjusted, if necessary to fulfil the requirements of point 3.3 of Appendix 3. Alternatively, the total trip distance as determined by the ECU can be compared with a reference distance obtained from a digital road network or topographic map. The total trip distance determined by the ECU shall deviate by no more than 4 % from the reference.

4.8. **Check of PEMS set up**

The correctness of connections with all sensors and, if applicable, the ECU shall be verified. If engine parameters are retrieved, it shall be ensured that the ECU reports values correctly (e.g., zero engine speed [rpm] while the combustion engine is in key-on-engine-off status). The PEMS shall function free of warning signals and error indication.

5. **EMISSIONS TEST**

5.1. **Test start**

Sampling, measurement and recording of parameters shall begin prior to the start of the engine. To facilitate time alignment, it is recommended to record the parameters that are subject to time alignment either by a single data recording device or with a synchronised time stamp. Before and directly after engine start, it shall be confirmed that all necessary parameters are recorded by the data logger.

5.2. **Test**

Status: Point in time view as at 01/06/2017.

Changes to legislation: There are outstanding changes not yet made to Commission Regulation (EU) 2017/1151. Any changes that have already been made to the legislation appear in the content and are referenced with annotations. (See end of Document for details)

Sampling, measurement and recording of parameters shall continue throughout the on-road test of the vehicle. The engine may be stopped and started, but emissions sampling and parameter recording shall continue. Any warning signals, suggesting malfunctioning of the PEMS, shall be documented and verified. Parameter recording shall reach a data completeness of higher than 99 %. Measurement and data recording may be interrupted for less than 1 % of the total trip duration but for no more than a consecutive period of 30 s solely in the case of unintended signal loss or for the purpose of PEMS system maintenance. Interruptions may be recorded directly by the PEMS. It is not permissible to introduce interruptions in the recorded parameter via the pre-processing, exchange or post-processing of data. If conducted, auto zeroing shall be performed against a traceable zero standard similar to the one used to zero the analyser. If necessary it is strongly recommended to initiate PEMS system maintenance during periods of zero vehicle speed.

5.3. Test end

The end of the test is reached when the vehicle has completed the trip and the combustion engine is switched off. Excessive idling of the engine after the completion of the trip shall be avoided. The data recording shall continue until the response time of the sampling systems has elapsed.

6. POST-TEST PROCEDURE

6.1. Checking the analysers for measuring gaseous emissions

The zero and span of the analysers of gaseous components shall be checked by using calibration gases identical to the ones applied under point 4.5 to evaluate the analyser's zero and response drift compared to the pre-test calibration. It is permissible to zero the analyser prior to verifying the span drift, if the zero drift was determined to be within the permissible range. The post-test drift check shall be completed as soon as possible after the test and before the PEMS, or individual analysers or sensors, are turned off or have switched into a non-operating mode. The difference between the pre-test and post-test results shall comply with the requirements specified in Table 2.

TABLE 2

Permissible analyser drift over a PEMS test

Pollutant	Zero response drift	Span response drift ^a
CO ₂	≤ 2 000 ppm per test	≤ 2 % of reading or ≤ 2 000 ppm per test, whichever is larger
CO	≤ 75 ppm per test	≤ 2 % of reading or ≤ 75 ppm per test, whichever is larger
NO ₂	≤ 5 ppm per test	≤ 2 % of reading or ≤ 5 ppm per test, whichever is larger
NO/NO _x	≤ 5 ppm per test	≤ 2 % of reading or ≤ 5 ppm per test, whichever is larger
CH ₄	≤ 10 ppmC ₁ per test	≤ 2 % of reading or ≤ 10 ppmC ₁ per test, whichever is larger

^a If the zero drift is within the permissible range, it is permissible to zero the analyser prior to verifying the span drift.

Status: Point in time view as at 01/06/2017.

Changes to legislation: There are outstanding changes not yet made to Commission Regulation (EU) 2017/1151. Any changes that have already been made to the legislation appear in the content and are referenced with annotations. (See end of Document for details)

THC	$\leq 10 \text{ ppmC}_1$ per test	$\leq 2 \%$ of reading or $\leq 10 \text{ ppmC}_1$ per test, whichever is larger
<p>a If the zero drift is within the permissible range, it is permissible to zero the analyser prior to verifying the span drift.</p>		

If the difference between the pre-test and post-test results for the zero and span drift is higher than permitted, all test results shall be voided and the test repeated.

6.2. Checking the analyser for measuring particle emissions

The zero level of the analyser shall be recorded by sampling HEPA filtered ambient air. The signal shall be recorded over a period of 2 min and averaged; the permissible final concentration shall be defined once suitable measurement equipment becomes available. If the difference between the pre-test and post-test check is higher than permitted, all test results shall be voided and the test repeated.

6.3. Checking the on-road emission measurements

The calibrated range of the analysers shall account at least for 90 % of the concentration values obtained from 99 % of the measurements of the valid parts of the emissions test. It is permissible that 1 % of the total number of measurements used for evaluation exceeds the calibrated range of the analysers by up to a factor of two. If these requirements are not met, the test shall be voided.

Appendix 2

Specifications and calibration of PEMS components and signals

1. INTRODUCTION

This appendix sets out the specifications and calibration of PEMS components and signals.

2. SYMBOLS, PARAMETERS AND UNITS

>	— larger than
\geq	— larger than or equal to
%	— per cent
\leq	— smaller than or equal to
<i>A</i>	— undiluted CO ₂ concentration [%]
<i>a</i> ₀	— y-axis intercept of the linear regression line
<i>a</i> ₁	— slope of the linear regression line
<i>B</i>	— diluted CO ₂ concentration [%]
<i>C</i>	— diluted NO concentration [ppm]
<i>c</i>	— analyser response in the oxygen interference test
<i>c</i> _{FS,b}	— full scale HC concentration in step (b) [ppmC ₁]
<i>c</i> _{FS,d}	— full scale HC concentration in step (d) [ppmC ₁]
<i>c</i> _{HC(w/NMC)}	— HC concentration with CH ₄ or C ₂ H ₆ flowing through the NMC [ppmC ₁]
<i>c</i> _{HC(w/o NMC)}	— HC concentration with CH ₄ or C ₂ H ₆ bypassing the NMC [ppmC ₁]
<i>c</i> _{m,b}	— measured HC concentration in step (b) [ppmC ₁]
<i>c</i> _{m,d}	— measured HC concentration in step (d) [ppmC ₁]
<i>c</i> _{ref,b}	— reference HC concentration in step (b) [ppmC ₁]
<i>c</i> _{ref,d}	— reference HC concentration in step (d) [ppmC ₁]
°C	— degree centigrade

Status: Point in time view as at 01/06/2017.

Changes to legislation: There are outstanding changes not yet made to Commission Regulation (EU) 2017/1151. Any changes that have already been made to the legislation appear in the content and are referenced with annotations. (See end of Document for details)

D	— undiluted NO concentration [ppm]
D_e	— expected diluted NO concentration [ppm]
E	— absolute operating pressure [kPa]
E_{CO_2}	— per cent CO ₂ quench
E_E	— ethane efficiency
E_{H_2O}	— per cent water quench
E_M	— methane efficiency
E_{O_2}	— oxygen interference
F	— water temperature [K]
G	— saturation vapour pressure [kPa]
g	— gram
gH ₂ O/kg	— gramme water per kilogram
h	— hour
H	— water vapour concentration [%]
H_m	— maximum water vapour concentration [%]
Hz	— hertz
K	— kelvin
kg	— kilogramme
km/h	— kilometre per hour
kPa	— kilopascal
max	— maximum value
NO _{X,dry}	— moisture-corrected mean concentration of the stabilized NO _X recordings
NO _{X,m}	— mean concentration of the stabilized NO _X recordings
NO _{X,ref}	— reference mean concentration of the stabilized NO _X recordings
ppm	— parts per million
ppmC ₁	— parts per million carbon equivalents
r^2	— coefficient of determination
s	— second
t_0	— time point of gas flow switching [s]
t_{10}	— time point of 10 % response of the final reading
t_{50}	— time point of 50 % response of the final reading
t_{90}	— time point of 90 % response of the final reading
td	— to be determined
x	— independent variable or reference value
χ_{min}	— minimum value
y	— dependent variable or measured value

3. LINEARITY VERIFICATION

3.1. General

The linearity of analysers, flow-measuring instruments, sensors and signals, shall be traceable to international or national standards. Any sensors or signals that are not directly traceable, e.g., simplified flow-measuring instruments shall be calibrated alternatively against chassis dynamometer laboratory equipment that has been calibrated against international or national standards.

3.2. Linearity requirements

All analysers, flow-measuring instruments, sensors and signals shall comply with the linearity requirements given in Table 1. If air flow, fuel flow, the air-to-fuel ratio or the exhaust mass flow

Status: Point in time view as at 01/06/2017.

Changes to legislation: There are outstanding changes not yet made to Commission Regulation (EU) 2017/1151. Any changes that have already been made to the legislation appear in the content and are referenced with annotations. (See end of Document for details)

rate is obtained from the ECU, the calculated exhaust mass flow rate shall meet the linearity requirements specified in Table 1.

TABLE 1

Linearity requirements of measurement parameters and systems

Measurement parameter/ instrument	$ x_{min} \times (a_1 - 1) + a_0 $	Slope a_1	Standard errorSEE	Coefficient of determination r^2
Fuel flow rate ^a	≤ 1 % max	0,98 - 1,02	≤ 2 % max	≥ 0,99
Air flow rate ^a	≤ 1 % max	0,98 - 1,02	≤ 2 % max	≥ 0,99
Exhaust mass flow rate	≤ 2 % max	0,97 - 1,03	≤ 2 % max	≥ 0,99
Gas analysers	≤ 0,5 % max	0,99 - 1,01	≤ 1 % max	≥ 0,998
Torque ^b	≤ 1 % max	0,98-1,02	≤ 2 % max	≥ 0,99
PN analysers ^c	tbd	tbd	tbd	tbd

a Optional to determine exhaust mass flow.

b Optional parameter.

c To be decided once equipment becomes available.

3.3. Frequency of linearity verification

The linearity requirements according to point 3.2 shall be verified:

- (a) for each analyser at least every three months or whenever a system repair or change is made that could influence the calibration;
- (b) for other relevant instruments, such as exhaust mass flow meters and traceably calibrated sensors, whenever damage is observed, as required by internal audit procedures, by the instrument manufacturer or by ISO 9000 but no longer than one year before the actual test.

The linearity requirements according to point 3.2 for sensors or ECU signals that are not directly traceable shall be performed with a traceably calibrated measurement device on the chassis dynamometer once for each PEMS setup.

3.4. Procedure of linearity verification

3.4.1. General requirements

The relevant analysers, instruments and sensors shall be brought to their normal operating condition according to the recommendations of their manufacturer. The analysers, instruments and sensors shall be operated at their specified temperatures, pressures and flows.

3.4.2. General procedure

The linearity shall be verified for each normal operating range by executing the following steps:

- (a) The analyser, flow-measuring instrument or sensor shall be set to zero by introducing a zero signal. For gas analysers, purified synthetic air or nitrogen shall be introduced to the analyser port via a gas path that is as direct and short as possible.

Status: Point in time view as at 01/06/2017.

Changes to legislation: There are outstanding changes not yet made to Commission Regulation (EU) 2017/1151. Any changes that have already been made to the legislation appear in the content and are referenced with annotations. (See end of Document for details)

- (b) The analyser, flow-measuring instrument or sensor shall be spanned by introducing a span signal. For gas analysers, an appropriate span gas shall be introduced to the analyser port via a gas path that is as direct and short as possible.
- (c) The zero procedure of (a) shall be repeated.
- (d) The linearity shall be verified by introducing at least 10, approximately equally spaced and valid, reference values (including zero). The reference values with respect to the concentration of components, the exhaust mass flow rate or any other relevant parameter shall be chosen to match the range of values expected during the emissions test. For measurements of exhaust mass flow, reference points below 5 % of the maximum calibration value can be excluded from the linearity verification.
- (e) For gas analysers, known gas concentrations in accordance with point 5 shall be introduced to the analyser port. Sufficient time for signal stabilisation shall be given.
- (f) The values under evaluation and, if needed, the reference values shall be recorded at a constant frequency of at least 1.0 Hz over a period of 30 seconds.
- (g) The arithmetic mean values over the 30 seconds period shall be used to calculate the least squares linear regression parameters, with the best-fit equation having the form:

$$y = a_1 x + a_0$$

where:

y	is the actual value of the measurement system
a_1	is the slope of the regression line
x	is the reference value
a_0	is the y intercept of the regression line

The standard error of estimate (SEE) of y on x and the coefficient of determination (r^2) shall be calculated for each measurement parameter and system.

- (h) The linear regression parameters shall meet the requirements specified in Table 1.

3.4.3. Requirements for linearity verification on a chassis dynamometer

Non-traceable flow-measuring instruments, sensors or ECU signals that cannot directly be calibrated according to traceable standards, shall be calibrated on a chassis dynamometer. The procedure shall follow as far as applicable, the requirements of Annex 4a to UN/ECE Regulation No 83. If necessary, the instrument or sensor to be calibrated shall be installed on the test vehicle and operated according to the requirements of Appendix 1. The calibration procedure shall follow whenever possible the requirements of point 3.4.2; at least 10 appropriate reference values shall be selected as to ensure that at least 90 % of the maximum value expected to occur during the RDE test is covered.

If a not directly traceable flow-measuring instrument, sensor or ECU signal for determining exhaust flow is to be calibrated, a traceably calibrated reference exhaust mass flow meter or the CVS shall be attached to the vehicle's tailpipe. It shall be ensured that the vehicle exhaust is accurately measured by the exhaust mass flow meter according to point 3.4.3 of Appendix 1. The vehicle shall be operated by applying constant throttle at a constant gear selection and chassis dynamometer load.

4. ANALYSERS FOR MEASURING GASEOUS COMPONENTS

4.1. Permissible types of analysers

4.1.1. Standard analysers

Status: Point in time view as at 01/06/2017.

Changes to legislation: There are outstanding changes not yet made to Commission Regulation (EU) 2017/1151. Any changes that have already been made to the legislation appear in the content and are referenced with annotations. (See end of Document for details)

The gaseous components shall be measured with analysers specified in points 1.3.1 to 1.3.5 of Appendix 3, Annex 4A to UN/ECE Regulation No 83, 07 series of amendments. If an NDUV analyser measures both NO and NO₂, a NO₂/NO converter is not required.

4.1.2. *Alternative analysers*

Any analyser not meeting the design specifications of point 4.1.1 is permissible provided that it fulfils the requirements of point 4.2. The manufacturer shall ensure that the alternative analyser achieves an equivalent or higher measurement performance compared to a standard analyser over the range of pollutant concentrations and co-existing gases that can be expected from vehicles operated with permissible fuels under moderate and extended conditions of valid RDE testing as specified in points 5, 6 and 7 of this Annex. Upon request, the manufacturer of the analyser shall submit in writing supplemental information, demonstrating that the measurement performance of the alternative analyser is consistently and reliably in line with the measurement performance of standard analysers. Supplemental information shall contain:

- (a) a description of the theoretical basis and the technical components of the alternative analyser;
- (b) a demonstration of equivalency with the respective standard analyser specified in point 4.1.1 over the expected range of pollutant concentrations and ambient conditions of the type-approval test defined in Annex 4a to UN/ECE Regulation No 83, 07 series of amendments as well as a validation test as described in point 3 of Appendix 3 for a vehicle equipped with a spark-ignition and compression-ignition engine; the manufacturer of the analyser shall demonstrate the significance of equivalency within the permissible tolerances given in point 3.3 of Appendix 3.
- (c) a demonstration of equivalency with the respective standard analyser specified in point 4.1.1 with respect to the influence of atmospheric pressure on the measurement performance of the analyser; the demonstration test shall determine the response to span gas having a concentration within the analyser range to check the influence of atmospheric pressure under moderate and extended altitude conditions defined in point 5.2 of this Annex. Such a test can be performed in an altitude environmental test chamber.
- (d) a demonstration of equivalency with the respective standard analyser specified in point 4.1.1 over at least three on-road tests that fulfil the requirements of this Annex.
- (e) a demonstration that the influence of vibrations, accelerations and ambient temperature on the analyser reading does not exceed the noise requirements for analysers set out in point 4.2.4.

Approval authorities may request additional information to substantiate equivalency or refuse approval if measurements demonstrate that an alternative analyser is not equivalent to a standard analyser.

4.2. **Analyser specifications**

4.2.1. *General*

In addition to the linearity requirements defined for each analyser in point 3, the compliance of analyser types with the specifications laid down in points 4.2.2 to 4.2.8 shall be demonstrated by the analyser manufacturer. Analysers shall have a measuring range and response time appropriate to measure with adequate accuracy the concentrations of the exhaust gas components at the applicable emissions standard under transient and steady state conditions. The sensitivity of the analysers to shocks, vibration, aging, variability in temperature and air

Status: Point in time view as at 01/06/2017.

Changes to legislation: There are outstanding changes not yet made to Commission Regulation (EU) 2017/1151. Any changes that have already been made to the legislation appear in the content and are referenced with annotations. (See end of Document for details)

pressure as well as electromagnetic interferences and other impacts related to vehicle and analyser operation shall be limited as far as possible.

4.2.2. Accuracy

The accuracy, defined as the deviation of the analyser reading from the reference value, shall not exceed 2 % of reading or 0.3 % of full scale, whichever is larger.

4.2.3. Precision

The precision, defined as 2.5 times the standard deviation of 10 repetitive responses to a given calibration or span gas, shall be no greater than 1 % of the full scale concentration for a measurement range equal or above 155 ppm (or ppmC₁) and 2 % of the full scale concentration for a measurement range of below 155 ppm (or ppmC₁).

4.2.4. Noise

The noise, defined as two times the root mean square of ten standard deviations, each calculated from the zero responses measured at a constant recording frequency of at least 1.0 Hz during a period of 30 seconds, shall not exceed 2 % of full scale. Each of the 10 measurement periods shall be interspersed with an interval of 30 seconds in which the analyser is exposed to an appropriate span gas. Before each sampling period and before each span period, sufficient time shall be given to purge the analyser and the sampling lines.

4.2.5. Zero response drift

The drift of the zero response, defined as the mean response to a zero gas during a time interval of at least 30 seconds, shall comply with the specifications given in Table 2.

4.2.6. Span response drift

The drift of the span response, defined as the mean response to a span gas during a time interval of at least 30 seconds, shall comply with the specifications given in Table 2.

TABLE 2

Permissible zero and span response drift of analysers for measuring gaseous components under laboratory conditions

Pollutant	Zero response drift	Span response drift
CO ₂	≤1,0 ppm over 4 h	≤2 % of reading or ≤1,0 ppm over 4 h, whichever is larger
CO	≤50 ppm over 4 h	≤2 % of reading or ≤50 ppm over 4 h, whichever is larger
NO ₂	≤5 ppm over 4 h	≤2 % of reading or ≤5 ppm over 4 h, whichever is larger
NO/NO _x	≤5 ppm over 4 h	≤2 % of reading or 5 ppm over 4h, whichever is larger
CH ₄	≤10 ppmC ₁	≤2 % of reading or ≤10 ppmC ₁ over 4 h, whichever is larger

Status: Point in time view as at 01/06/2017.

Changes to legislation: There are outstanding changes not yet made to Commission Regulation (EU) 2017/1151. Any changes that have already been made to the legislation appear in the content and are referenced with annotations. (See end of Document for details)

THC	$\leq 10 \text{ ppmC}_1$	$\leq 2 \%$ of reading or $\leq 10 \text{ ppmC}_1$ over 4 h, whichever is larger
-----	--------------------------	--

4.2.7. Rise time

The rise time, defined as the time between the 10 per cent and 90 per cent response of the final reading ($t_{90} - t_{10}$; see point 4.4), shall not exceed 3 seconds.

4.2.8. Gas drying

Exhaust gases may be measured wet or dry. A gas-drying device, if used, shall have a minimal effect on the composition of the measured gases. Chemical dryers are not permitted.

4.3. Additional requirements

4.3.1. General

The provisions in points 4.3.2 to 4.3.5 define additional performance requirements for specific analyser types and apply only to cases, in which the analyser under consideration is used for RDE emission measurements.

4.3.2. Efficiency test for NO_x converters

If a NO_x converter is applied, for example to convert NO_2 into NO for analysis with a chemiluminescence analyser, its efficiency shall be tested by following the requirements of point 2.4 of Appendix 3 of Annex 4a to UN/ECE Regulation No 83, 07 series of amendments. The efficiency of the NO_x converter shall be verified no longer than one month before the emissions test.

4.3.3. Adjustment of the Flame Ionisation Detector (FID)

(a) Optimization of the detector response

If hydrocarbons are measured, the FID shall be adjusted at intervals specified by the analyser manufacturer by following point 2.3.1 of Appendix 3 of Annex 4a to UN/ECE Regulation No 83, 07 series of amendments. A propane-in-air or propane-in-nitrogen span gas shall be used to optimize the response in the most common operating range.

(b) Hydrocarbon response factors

If hydrocarbons are measured, the hydrocarbon response factor of the FID shall be verified by following the provisions of point 2.3.3 of Appendix 3 of Annex 4a to UN/ECE Regulation No 83, 07 series of amendments, using propane-in-air or propane-in-nitrogen as span gases and purified synthetic air or nitrogen as zero gases, respectively.

(c) Oxygen interference check

The oxygen interference check shall be performed when introducing a FID into service and after major maintenance intervals. A measuring range shall be chosen in which the oxygen interference check gases fall in the upper 50 per cent. The test shall be conducted with the oven temperature set as required. The specifications of the oxygen interference check gases are described in point 5.3.

The following procedure applies:

(i) The analyser shall be set at zero;

Status: Point in time view as at 01/06/2017.

Changes to legislation: There are outstanding changes not yet made to Commission Regulation (EU) 2017/1151. Any changes that have already been made to the legislation appear in the content and are referenced with annotations. (See end of Document for details)

- (ii) The analyser shall be spanned with a 0 per cent oxygen blend for positive ignition engines and a 21 per cent oxygen blend for compression ignition engines;
- (iii) The zero response shall be rechecked. If it has changed by more than 0.5 per cent of full scale, steps (i) and (ii) shall be repeated;
- (iv) The 5 per cent and 10 per cent oxygen interference check gases shall be introduced;
- (v) The zero response shall be rechecked. If it has changed by more than ± 1 per cent of full scale, the test shall be repeated;
- (vi) The oxygen interference E_{O_2} shall be calculated for each oxygen interference check gas in step (iv) as follows:

$$E_{O_2} = \frac{(c_{ref,d} - c)}{c_{ref,d}} \times 100$$

where the analyser response is:

$$c = \frac{(c_{ref,d} \times c_{FS,b})}{c_{m,b}} \times \frac{c_{m,b}}{c_{FS,d}}$$

where:

$c_{ref,b}$	is the reference HC concentration in step (ii) [ppmC ₁]
$c_{ref,d}$	is the reference HC concentration in step (iv) [ppmC ₁]
$c_{FS,b}$	is the full scale HC concentration in step (ii) [ppmC ₁]
$c_{FS,d}$	is the full scale HC concentration in step (iv) [ppmC ₁]
$c_{m,b}$	is the measured HC concentration in step (ii) [ppmC ₁]
$c_{m,d}$	is the measured HC concentration in step (iv) [ppmC ₁]

- (vii) The oxygen interference E_{O_2} shall be less than ± 1.5 per cent for all required oxygen interference check gases.
- (viii) If the oxygen interference E_{O_2} is higher than ± 1.5 per cent, corrective action may be taken by incrementally adjusting the air flow (above and below the manufacturer's specifications), the fuel flow and the sample flow.
- (ix) The oxygen interference check shall be repeated for each new setting.

4.3.4. Conversion efficiency of the non-methane cutter (NMC)

If hydrocarbons are analysed, a NMC can be used to remove non-methane hydrocarbons from the gas sample by oxidizing all hydrocarbons except methane. Ideally, the conversion for methane is 0 per cent and for the other hydrocarbons represented by ethane is 100 per cent. For the accurate measurement of NMHC, the two efficiencies shall be determined and used for the calculation of the NMHC emissions (see point 9.2 of Appendix 4). It is not necessary to determine the methane conversion efficiency in case the NMC-FID is calibrated according to method (b) in point 9.2 of Appendix 4 by passing the methane/air calibration gas through the NMC.

(a) Methane conversion efficiency

Methane calibration gas shall be flown through the FID with and without bypassing the NMC; the two concentrations shall be recorded. The methane efficiency shall be determined as:

$$E_M = 1 - \frac{c_{HC(w/NMC)}}{c_{HC(w/wNMC)}}$$

where:

Status: Point in time view as at 01/06/2017.

Changes to legislation: There are outstanding changes not yet made to Commission Regulation (EU) 2017/1151. Any changes that have already been made to the legislation appear in the content and are referenced with annotations. (See end of Document for details)

$c_{\text{HC(w/NMC)}}$ is the HC concentration with CH₄ flowing through the NMC [ppmC₁]
 $c_{\text{HC(w/o NMC)}}$ is the HC concentration with CH₄ bypassing the NMC [ppmC₁]

(b) Ethane conversion efficiency

Ethane calibration gas shall be flown through the FID with and without bypassing the NMC; the two concentrations shall be recorded. The ethane efficiency shall be determined as:

$$E_E = 1 - \frac{c_{\text{HC(w/NMC)}}}{c_{\text{HC(w/o NMC)}}}$$

where:

$c_{\text{HC(w/NMC)}}$ is the HC concentration with C₂H₆ flowing through the NMC [ppmC₁]
 $c_{\text{HC(w/o NMC)}}$ is the HC concentration with C₂H₆ bypassing the NMC [ppmC₁]

4.3.5. Interference effects

(a) General

Other gases than the ones being analysed can affect the analyser reading. A check for interference effects and the correct functionality of analysers shall be performed by the analyser manufacturer prior to market introduction at least once for each type of analyser or device addressed in points (b) to (f).

(b) CO analyser interference check

Water and CO₂ can interfere with the measurements of the CO analyser. Therefore, a CO₂ span gas having a concentration of 80 to 100 per cent of full scale of the maximum operating range of the CO analyser used during the test shall be bubbled through water at room temperature and the analyser response recorded. The analyser response shall not be more than 2 per cent of the mean CO concentration expected during normal on-road testing or ± 50 ppm, whichever is larger. The interference check for H₂O and CO₂ may be run as separate procedures. If the H₂O and CO₂ levels used for the interference check are higher than the maximum levels expected during the test, each observed interference value shall be scaled down by multiplying the observed interference with the ratio of the maximum expected concentration value during the test and the actual concentration value used during this check. Separate interference checks with concentrations of H₂O that are lower than the maximum concentration expected during the test may be run and the observed H₂O interference shall be scaled up by multiplying the observed interference with the ratio of the maximum H₂O concentration value expected during the test and the actual concentration value used during this check. The sum of the two scaled interference values shall meet the tolerance specified in this point.

(c) NO_x analyser quench check

The two gases of concern for CLD and HCLD analysers are CO₂ and water vapour. The quench response to these gases is proportional to the gas concentrations. A test shall determine the quench at the highest concentrations expected during the test. If the CLD and HCLD analysers use quench compensation algorithms that utilize H₂O or CO₂ measurement analysers or both, quench shall be evaluated with these analysers active and with the compensation algorithms applied.

(i) CO₂ quench check

A CO₂ span gas having a concentration of 80 to 100 per cent of the maximum operating range shall be passed through the NDIR analyser; the CO₂ value shall be recorded as A. The CO₂ span gas shall then be diluted by approximately 50 per cent with NO span gas and passed through the

Status: Point in time view as at 01/06/2017.

Changes to legislation: There are outstanding changes not yet made to Commission Regulation (EU) 2017/1151. Any changes that have already been made to the legislation appear in the content and are referenced with annotations. (See end of Document for details)

NDIR and CLD or HCLD; the CO₂ and NO values shall be recorded as B and C, respectively. The CO₂ gas flow shall then be shut off and only the NO span gas shall be passed through the CLD or HCLD; the NO value shall be recorded as D. The per cent quench shall be calculated as:

$$E_{\text{CO}_2} = \left[1 - \left(\frac{C \times A}{(D \times A) - (D \times B)} \right) \right] \times 100$$

where:

A	is the undiluted CO ₂ concentration measured with the NDIR [%]
B	is the diluted CO ₂ concentration measured with the NDIR [%]
C	is the diluted NO concentration measured with the CLD or HCLD [ppm]
D	is the undiluted NO concentration measured with the CLD or HCLD [ppm]

Alternative methods of diluting and quantifying of CO₂ and NO span gas values such as dynamic mixing/blending are permitted upon approval of the approval authority.

(ii) Water quench check

This check applies to measurements of wet gas concentrations only. The calculation of water quench shall consider dilution of the NO span gas with water vapour and the scaling of the water vapour concentration in the gas mixture to concentration levels that are expected to occur during an emissions test. A NO span gas having a concentration of 80 per cent to 100 per cent of full scale of the normal operating range shall be passed through the CLD or HCLD; the NO value shall be recorded as *D*. The NO span gas shall then be bubbled through water at room temperature and passed through the CLD or HCLD; the NO value shall be recorded as *C*. The analyser's absolute operating pressure and the water temperature shall be determined and recorded as *E* and *F*, respectively. The mixture's saturation vapour pressure that corresponds to the water temperature of the bubbler *F* shall be determined and recorded as *G*. The water vapour concentration *H* [%] of the gas mixture shall be calculated as:

$$H = \frac{G}{E} = 100$$

The expected concentration of the diluted NO-water vapour span gas shall be recorded as *D_e* after being calculated as:

$$D_e = D \times \left(1 - \frac{H}{100} \right)$$

For diesel exhaust, the maximum concentration of water vapour in the exhaust gas (in per cent) expected during the test shall be recorded as *H_m* after being estimated, under the assumption of a fuel H/C ratio of 1.8/1, from the maximum CO₂ concentration in the exhaust gas *A* as follows:

$$H_m = 0,9 \times A$$

The per cent water quench shall be calculated as:

$$E_{\text{H}_2\text{O}} = \left(\left(\frac{D_e - C}{D_e} \right) \times \left(\frac{H_m}{H} \right) \right) \times 100$$

where:

<i>D_e</i>	is the expected diluted NO concentration [ppm]
<i>C</i>	is the measured diluted NO concentration [ppm]
<i>H_m</i>	is the maximum water vapour concentration [%]
<i>H</i>	is the actual water vapour concentration [%]

(iii) Maximum allowable quench

The combined CO₂ and water quench shall not exceed 2 per cent of full scale.

Status: Point in time view as at 01/06/2017.

Changes to legislation: There are outstanding changes not yet made to Commission Regulation (EU) 2017/1151. Any changes that have already been made to the legislation appear in the content and are referenced with annotations. (See end of Document for details)

(d) Quench check for NDUV analysers

Hydrocarbons and water can positively interfere with NDUV analysers by causing a response similar to that of NO_x. The manufacturer of the NDUV analyser shall use the following procedure to verify that quench effects are limited:

- (i) The analyser and chiller shall be set up by following the operating instructions of the manufacturer; adjustments should be made as to optimise the analyser and chiller performance.
- (ii) A zero calibration and span calibration at concentration values expected during emissions testing shall be performed for the analyser.
- (iii) A NO₂ calibration gas shall be selected that matches as far as possible the maximum NO₂ concentration expected during emissions testing.
- (iv) The NO₂ calibration gas shall overflow at the gas sampling system's probe until the NO_x response of the analyser has stabilised.
- (v) The mean concentration of the stabilized NO_x recordings over a period of 30 s shall be calculated and recorded as NO_{x,ref}.
- (vi) The flow of the NO₂ calibration gas shall be stopped and the sampling system saturated by overflowing with a dew point generator's output, set at a dew point of 50 °C. The dew point generator's output shall be sampled through the sampling system and chiller for at least 10 minutes until the chiller is expected to be removing a constant rate of water.
- (vii) Upon completion of (iv), the sampling system shall again be overflowed by the NO₂ calibration gas used to establish NO_{x,ref} until the total NO_x response has stabilized.
- (viii) The mean concentration of the stabilized NO_x recordings over a period of 30 s shall be calculated and recorded as NO_{x,m}.
- (ix) NO_{x,m} shall be corrected to NO_{x,dry} based upon the residual water vapour that passed through the chiller at the chiller's outlet temperature and pressure.

The calculated NO_{x,dry} shall at least amount to 95 % of NO_{x,ref}.

(e) Sample dryer

A sample dryer removes water, which can otherwise interfere with the NO_x measurement. For dry CLD analysers, it shall be demonstrated that at the highest expected water vapour concentration H_m the sample dryer maintains the CLD humidity at ≤ 5 g water/kg dry air (or about 0.8 per cent H₂O), which is 100 per cent relative humidity at 3.9 °C and 101.3 kPa or about 25 per cent relative humidity at 25 °C and 101.3 kPa. Compliance may be demonstrated by measuring the temperature at the outlet of a thermal sample dryer or by measuring the humidity at a point just upstream of the CLD. The humidity of the CLD exhaust might also be measured as long as the only flow into the CLD is the flow from the sample dryer.

(f) Sample dryer NO₂ penetration

Liquid water remaining in an improperly designed sample dryer can remove NO₂ from the sample. If a sample dryer is used in combination with a NDUV analyser without an NO₂/NO converter upstream, water could therefore remove NO₂ from the sample prior to the NO_x

Status: Point in time view as at 01/06/2017.

Changes to legislation: There are outstanding changes not yet made to Commission Regulation (EU) 2017/1151. Any changes that have already been made to the legislation appear in the content and are referenced with annotations. (See end of Document for details)

measurement. The sample dryer shall allow for measuring at least 95 per cent of the NO₂ contained in a gas that is saturated with water vapour and consists of the maximum NO₂ concentration expected to occur during emission testing.

4.4. Response time check of the analytical system

For the response time check, the settings of the analytical system shall be exactly the same as during the emissions test (i.e. pressure, flow rates, filter settings in the analysers and all other parameters influencing the response time). The response time shall be determined with gas switching directly at the inlet of the sample probe. The gas switching shall be done in less than 0.1 second. The gases used for the test shall cause a concentration change of at least 60 per cent full scale of the analyser.

The concentration trace of each single gas component shall be recorded. The delay time is defined as the time from the gas switching (t_0) until the response is 10 per cent of the final reading (t_{10}). The rise time is defined as the time between 10 per cent and 90 per cent response of the final reading ($t_{90} - t_{10}$). The system response time (t_{90}) consists of the delay time to the measuring detector and the rise time of the detector.

For time alignment of the analyser and exhaust flow signals, the transformation time is defined as the time from the change (t_0) until the response is 50 per cent of the final reading (t_{50}).

The system response time shall be ≤ 12 s with a rise time of ≤ 3 seconds for all components and all ranges used. When using a NMC for the measurement of NMHC, the system response time may exceed 12 seconds.

5. GASES

5.1. General

The shelf life of calibration and span gases shall be respected. Pure and mixed calibration and span gases shall fulfil the specifications of points 3.1 and 3.2 of Appendix 3 of Annex 4A to UN/ECE Regulation No 83, 07 series of amendments. In addition, NO₂ calibration gas is permissible. The concentration of the NO₂ calibration gas shall be within two per cent of the declared concentration value. The amount of NO contained in the NO₂ calibration gas shall not exceed 5 per cent of the NO₂ content.

5.2. Gas dividers

Gas dividers, i.e., precision blending devices that dilute with purified N₂ or synthetic air, can be used to obtain calibration and span gases. The accuracy of the gas divider shall be such that the concentration of the blended calibration gases is accurate to within ± 2 per cent. The verification shall be performed at between 15 and 50 per cent of full scale for each calibration incorporating a gas divider. An additional verification may be performed using another calibration gas, if the first verification has failed.

Optionally, the gas divider may be checked with an instrument which by nature is linear, e.g. using NO gas in combination with a CLD. The span value of the instrument shall be adjusted with the span gas directly connected to the instrument. The gas divider shall be checked at the settings typically used and the nominal value shall be compared with the concentration measured by the instrument. The difference shall in each point be within ± 1 per cent of the nominal concentration value.

5.3. Oxygen interference check gases

Status: Point in time view as at 01/06/2017.

Changes to legislation: There are outstanding changes not yet made to Commission Regulation (EU) 2017/1151. Any changes that have already been made to the legislation appear in the content and are referenced with annotations. (See end of Document for details)

Oxygen interference check gases consist of a blend of propane, oxygen and nitrogen and shall contain propane at a concentration of 350 ± 75 ppmC₁. The concentration shall be determined by gravimetric methods, dynamic blending or the chromatographic analysis of total hydrocarbons plus impurities. The oxygen concentrations of the oxygen interference check gases shall meet the requirements listed in Table 3; the remainder of the oxygen interference check gas shall consist of purified nitrogen.

TABLE 3

Oxygen interference check gases

	Engine type	
	Compression ignition	Positive ignition
O₂ concentration	21 ± 1 %	10 ± 1 %
	10 ± 1 %	5 ± 1 %
	5 ± 1 %	0,5 ± 0,5 %

6. ANALYSERS FOR MEASURING PARTICLE NUMBER EMISSIONS

This sections will define future requirement for analysers for measuring particle number emissions, once their measurement becomes mandatory.

7. INSTRUMENTS FOR MEASURING EXHAUST MASS FLOW

7.1. General

Instruments, sensors or signals for measuring the exhaust mass flow rate shall have a measuring range and response time appropriate for the accuracy required to measure the exhaust mass flow rate under transient and steady state conditions. The sensitivity of instruments, sensors and signals to shocks, vibration, aging, variability in temperature, ambient air pressure, electromagnetic interferences and other impacts related to vehicle and instrument operation shall be on a level as to minimize additional errors.

7.2. Instrument specifications

The exhaust mass flow rate shall be determined by a direct measurement method applied in either of the following instruments:

- (a) Pitot-based flow devices;
- (b) Pressure differential devices like flow nozzle (details see ISO 5167);
- (c) Ultrasonic flow meter;
- (d) Vortex flow meter.

Each individual exhaust mass flow meter shall fulfil the linearity requirements set out in point 3. Furthermore, the instrument manufacturer shall demonstrate the compliance of each type of exhaust mass flow meter with the specifications in points 7.2.3 to 7.2.9.

It is permissible to calculate the exhaust mass flow rate based on air flow and fuel flow measurements obtained from traceably calibrated sensors if these fulfil the linearity requirements of point 3, the accuracy requirements of point 8 and if the resulting exhaust mass flow rate is validated according to point 4 of Appendix 3.

Status: Point in time view as at 01/06/2017.

Changes to legislation: There are outstanding changes not yet made to Commission Regulation (EU) 2017/1151. Any changes that have already been made to the legislation appear in the content and are referenced with annotations. (See end of Document for details)

In addition, other methods that determine the exhaust mass flow rate based on not directly traceable instruments and signals, such as simplified exhaust mass flow meters or ECU signals are permissible if the resulting exhaust mass flow rate fulfils the linearity requirements of point 3 and is validated according to point 4 of Appendix 3.

7.2.1. *Calibration and verification standards*

The measurement performance of exhaust mass flow meters shall be verified with air or exhaust gas against a traceable standard such as, e.g. a calibrated exhaust mass flow meter or a full flow dilution tunnel.

7.2.2. *Frequency of verification*

The compliance of exhaust mass flow meters with points 7.2.3 and 7.2.9 shall be verified no longer than one year before the actual test.

7.2.3. *Accuracy*

The accuracy, defined as the deviation of the EFM reading from the reference flow value, shall not exceed ± 2 percent of the reading, 0,5 % of full scale or $\pm 1,0$ per cent of the maximum flow at which the EFM has been calibrated, whichever is larger.

7.2.4. *Precision*

The precision, defined as 2,5 times the standard deviation of 10 repetitive responses to a given nominal flow, approximately in the middle of the calibration range, shall not exceed 1 per cent of the maximum flow at which the EFM has been calibrated.

7.2.5. *Noise*

The noise, defined as two times the root mean square of ten standard deviations, each calculated from the zero responses measured at a constant recording frequency of at least 1,0 Hz during a period of 30 seconds, shall not exceed 2 per cent of the maximum calibrated flow value. Each of the 10 measurement periods shall be interspersed with an interval of 30 seconds in which the EFM is exposed to the maximum calibrated flow.

7.2.6. *Zero response drift*

The zero response drift is defined as the mean response to zero flow during a time interval of at least 30 seconds. The zero response drift can be verified based on the reported primary signals, e.g., pressure. The drift of the primary signals over a period of 4 hours shall be less than ± 2 per cent of the maximum value of the primary signal recorded at the flow at which the EFM was calibrated.

7.2.7. *Span response drift*

The span response drift is defined as the mean response to a span flow during a time interval of at least 30 seconds. The span response drift can be verified based on the reported primary signals, e.g., pressure. The drift of the primary signals over a period of 4 hours shall be less than ± 2 per cent of the maximum value of the primary signal recorded at the flow at which the EFM was calibrated.

7.2.8. *Rise time*

The rise time of the exhaust flow instruments and methods should match as far as possible the rise time of the gas analysers as specified in point 4.2.7 but shall not exceed 1 second.

7.2.9. *Response time check*

Status: Point in time view as at 01/06/2017.

Changes to legislation: There are outstanding changes not yet made to Commission Regulation (EU) 2017/1151. Any changes that have already been made to the legislation appear in the content and are referenced with annotations. (See end of Document for details)

The response time of exhaust mass flow meters shall be determined by applying similar parameters as those applied for the emissions test (i.e., pressure, flow rates, filter settings and all other response time influences). The response time determination shall be done with gas switching directly at the inlet of the exhaust mass flow meter. The gas flow switching shall be done as fast as possible, but highly recommended in less than 0,1 second. The gas flow rate used for the test shall cause a flow rate change of at least 60 per cent full scale of the exhaust mass flow meter. The gas flow shall be recorded. The delay time is defined as the time from the gas flow switching (t_0) until the response is 10 per cent (t_{10}) of the final reading. The rise time is defined as the time between 10 per cent and 90 per cent response ($t_{90} - t_{10}$) of the final reading. The response time (t_{90}) is defined as the sum of the delay time and the rise time. The exhaust mass flow meter response time (t_{90}) shall be ≤ 3 seconds with a rise time ($t_{90} - t_{10}$) of ≤ 1 second in accordance with point 7.2.8.

8. SENSORS AND AUXILIARY EQUIPMENT

Any sensor and auxiliary equipment used to determine, e.g., temperature, atmospheric pressure, ambient humidity, vehicle speed, fuel flow or intake air flow shall not alter or unduly affect the performance of the vehicle's engine and exhaust after-treatment system. The accuracy of sensors and auxiliary equipment shall fulfil the requirements of Table 4. Compliance with the requirements of Table 4 shall be demonstrated at intervals specified by the instrument manufacturer, as required by internal audit procedures or in accordance with ISO 9000.

TABLE 4

Accuracy requirements for measurement parameters

Measurement parameter	Accuracy
Fuel flow ^a	± 1 % of reading ^c
Air flow ^a	± 2 % of reading
Vehicle speed ^b	$\pm 1,0$ km/h absolute
Temperatures ≤ 600 K	± 2 K absolute
Temperatures > 600 K	$\pm 0,4$ % of reading in Kelvin
Ambient pressure	$\pm 0,2$ kPa absolute
Relative humidity	± 5 % absolute
Absolute humidity	± 10 % of reading or, 1 gH ₂ O/kg dry air, whichever is larger

a optional to determine exhaust mass flow

b This requirement applies to the speed sensor only; if vehicle speed is used to determine parameters like acceleration, the product of speed and positive acceleration, or RPA, the speed signal shall have an accuracy of 0,1 % above 3 km/h and a sampling frequency of 1 Hz. This accuracy requirement can be met by using the signal of a wheel rotational speed sensor.

c The accuracy shall be 0,02 per cent of reading if used to calculate the air and exhaust mass flow rate from the fuel flow according to point 10 of Appendix 4.

Status: Point in time view as at 01/06/2017.

Changes to legislation: There are outstanding changes not yet made to Commission Regulation (EU) 2017/1151. Any changes that have already been made to the legislation appear in the content and are referenced with annotations. (See end of Document for details)

Appendix 3

Validation of PEMS and non-traceable exhaust mass flow rate

1. INTRODUCTION

This appendix describes the requirements to validate under transient conditions the functionality of the installed PEMS as well as the correctness of the exhaust mass flow rate obtained from non-traceable exhaust mass flow meters or calculated from ECU signals.

2. SYMBOLS, PARAMETERS AND UNITS

%	— per cent
#/km	— number per kilometre
a_0	— y intercept of the regression line
a_1	— slope of the regression line
g/km	— gramme per kilometre
Hz	— hertz
km	— kilometre
m	— metre
mg/km	— milligramme per kilometre
r^2	— coefficient of determination
x	— actual value of the reference signal
y	— actual value of the signal under validation

3. VALIDATION PROCEDURE FOR PEMS

3.1. Frequency of PEMS validation

It is recommended to validate the installed PEMS once for each PEMS-vehicle combination either before the RDE test or, alternatively, after the completion of the test.

3.2. PEMS validation procedure

3.2.1. PEMS installation

The PEMS shall be installed and prepared according to the requirements of Appendix 1. The PEMS installation shall be kept unchanged in the time period between the validation and the RDE test.

3.2.2. Test conditions

The validation test shall be conducted on a chassis dynamometer, as far as applicable, under type approval conditions by following the requirements of Annex 4a to UN/ECE Regulation No 83, 07 series of amendments or any other adequate measurement method. It is recommended to conduct the validation test with the Worldwide harmonized Light vehicles Test Cycle (WLTC) as specified in Annex 1 to UNECE Global Technical Regulation No. 15. The ambient temperature shall be within the range specified in point 5.2 of this Annex.

It is recommended to feed the exhaust flow extracted by the PEMS during the validation test back to the CVS. If this is not feasible, the CVS results shall be corrected for the extracted exhaust mass. If the exhaust mass flow rate is validated with an exhaust mass flow meter, it is recommended to cross-check the mass flow rate measurements with data obtained from a sensor or the ECU.

3.2.3. Data analysis

Status: Point in time view as at 01/06/2017.

Changes to legislation: There are outstanding changes not yet made to Commission Regulation (EU) 2017/1151. Any changes that have already been made to the legislation appear in the content and are referenced with annotations. (See end of Document for details)

The total distance-specific emissions [g/km] measured with laboratory equipment shall be calculated following Annex 4a to UN/ECE Regulation No 83, 07 series of amendments. The emissions as measured with the PEMS shall be calculated according to point 9 of Appendix 4, summed to give the total mass of pollutant emissions [g] and then divided by the test distance [km] as obtained from the chassis dynamometer. The total distance-specific mass of pollutants [g/km], as determined by the PEMS and the reference laboratory system, shall be evaluated against the requirements specified in point 3.3. For the validation of NO_x emission measurements, humidity correction shall be applied following point 6.6.5 of Annex 4a to UN/ECE Regulation No 83, 07 series of amendments.

3.3. Permissible tolerances for PEMS validation

The PEMS validation results shall fulfil the requirements given in Table 1. If any permissible tolerance is not met, corrective action shall be taken and the PEMS validation shall be repeated.

TABLE 1

Permissible tolerances

Parameter [Unit]	Permissible tolerance
Distance [km] ^a	± 250 m of the laboratory reference
THC ^b [mg/km]	± 15 mg/km or 15 % of the laboratory reference, whichever is larger
CH ₄ ^b [mg/km]	± 15 mg/km or 15 % of the laboratory reference, whichever is larger
NMHC ^b [mg/km]	± 20 mg/km or 20 % of the laboratory reference, whichever is larger
PN ^b [# /km]	^c
CO ^b [mg/km]	± 150 mg/km or 15 % of the laboratory reference, whichever is larger
CO ₂ [g/km]	± 10 g/km or 10 % of the laboratory reference, whichever is larger
NO _x ^b [mg/km]	± 15 mg/km or 15 % of the laboratory reference, whichever is larger
a	Only applicable if vehicle speed is determined by the ECU; to meet the permissible tolerance it is permitted to adjust the ECU vehicle speed measurements based on the outcome of the validation test
b	Parameter only mandatory if measurement required by point 2.1 of this Annex.
c	Still to be determined.

4. VALIDATION PROCEDURE FOR THE EXHAUST MASS FLOW RATE DETERMINED BY NON-TRACEABLE INSTRUMENTS AND SENSORS

4.1. Frequency of validation

In addition to fulfilling the linearity requirements of point 3 of Appendix 2 under steady-state conditions, the linearity of non-traceable exhaust mass flow meters or the exhaust mass flow rate calculated from non-traceable sensors or ECU signals shall be validated under transient conditions for each test vehicle against a calibrated exhaust mass flow meter or the CVS. The validation can be executed without the installation of the PEMS but shall generally follow the

Status: Point in time view as at 01/06/2017.

Changes to legislation: There are outstanding changes not yet made to Commission Regulation (EU) 2017/1151. Any changes that have already been made to the legislation appear in the content and are referenced with annotations. (See end of Document for details)

requirements defined in Annex 4a to UN/ECE Regulation No 83, 07 series of amendments and the requirements pertinent to exhaust mass flow meters defined in Appendix 1.

4.2. Validation procedure

The validation shall be conducted on a chassis dynamometer under type approval conditions, as far as applicable, by following the requirements of Annex 4a to UN/ECE Regulation No 83, 07 series of amendments. The test cycle shall be the Worldwide harmonized Light vehicles Test Cycle (WLTC) as specified in Annex 1 to UNECE Global Technical Regulation No. 15. As reference, a traceably calibrated flow meter shall be used. The ambient temperature can be any within the range specified in point 5.2 of this Annex. The installation of the exhaust mass flow meter and the execution of the test shall fulfil the requirement of point 3.4.3 of Appendix 1 of this Annex.

The following calculation steps shall be taken to validate the linearity:

- (a) The signal under validation and the reference signal shall be time corrected by following, as far as applicable, the requirements of point 3 of Appendix 4.
- (b) Points below 10 % of the maximum flow value shall be excluded from the further analysis.
- (c) At a constant frequency of at least 1,0 Hz, the signal under validation and the reference signal shall be correlated using the best-fit equation having the form:

$$y = a_1 x + a_0$$

where:

- y is the actual value of the signal under validation
- a_1 is the slope of the regression line
- x is the actual value of the reference signal
- a_0 is the y intercept of the regression line

The standard error of estimate (SEE) of y on x and the coefficient of determination (r^2) shall be calculated for each measurement parameter and system.

- (d) The linear regression parameters shall meet the requirements specified in Table 2.

4.3. Requirements

The linearity requirements given in Table 2 shall be fulfilled. If any permissible tolerance is not met, corrective action shall be taken and the validation shall be repeated.

TABLE 2

Linearity requirements of calculated and measured exhaust mass flow

Measurement parameter/system	a_0	Slope a_1	Standard error SEE	Coefficient of determination r^2
Exhaust mass flow	0,0 ± 3,0 kg/h	1,00 ± 0,075	≤10 % max	≥ 0,90

Status: Point in time view as at 01/06/2017.

Changes to legislation: There are outstanding changes not yet made to Commission Regulation (EU) 2017/1151. Any changes that have already been made to the legislation appear in the content and are referenced with annotations. (See end of Document for details)

Appendix 4

Determination of emissions

1. INTRODUCTION

This appendix describes the procedure to determine the instantaneous mass and particle number emissions [g/s; #/s] that shall be used for the subsequent evaluation of a RDE trip and the calculation of the final emission result as described in Appendices 5 and 6.

2. SYMBOLS, PARAMETERS AND UNITS

%	— per cent
<	— smaller than
#/s	— number per second
α	— molar hydrogen ratio (H/C)
β	— molar carbon ratio (C/C)
γ	— molar sulphur ratio (S/C)
δ	— molar nitrogen ratio (N/C)
$\Delta t_{t,i}$	— transformation time t of the analyser [s]
$\Delta t_{t,m}$	— transformation time t of the exhaust mass flow meter [s]
ε	— molar oxygen ratio (O/C)
ρ_e	— density of the exhaust
ρ_{gas}	— density of the exhaust component 'gas'
λ	— excess air ratio
λ_i	— instantaneous excess air ratio
A/F_{st}	— stoichiometric air-to-fuel ratio [kg/kg]
$^{\circ}\text{C}$	— degrees centigrade
c_{CH_4}	— concentration of methane
c_{CO}	— dry CO concentration [%]
c_{CO_2}	— dry CO ₂ concentration [%]
c_{dry}	— dry concentration of a pollutant in ppm or per cent volume
$c_{\text{gas},i}$	— instantaneous concentration of the exhaust component 'gas' [ppm]
c_{HCw}	— wet HC concentration [ppm]
$c_{\text{HC(w/NMC)}}$	— HC concentration with CH ₄ or C ₂ H ₆ flowing through the NMC [ppmC ₁]
$c_{\text{HC(w/oNMC)}}$	— HC concentration with CH ₄ or C ₂ H ₆ bypassing the NMC [ppmC ₁]
$c_{i,c}$	— time-corrected concentration of component i [ppm]
$c_{i,r}$	— concentration of component i [ppm] in the exhaust
c_{NMHC}	— concentration of non-methane hydrocarbons
c_{wet}	— wet concentration of a pollutant in ppm or per cent volume
E_E	— ethane efficiency
E_M	— methane efficiency
g	— gramme
g/s	— gramme per second
H_a	— intake air humidity [g water per kg dry air]
i	— number of the measurement
kg	— kilogramme
kg/h	— kilogramme per hour
kg/s	— kilogramme per second
k_w	— dry-wet correction factor
m	— metre
$m_{\text{gas},i}$	— mass of the exhaust component 'gas' [g/s]

Status: Point in time view as at 01/06/2017.

Changes to legislation: There are outstanding changes not yet made to Commission Regulation (EU) 2017/1151. Any changes that have already been made to the legislation appear in the content and are referenced with annotations. (See end of Document for details)

$q_{maw,i}$	— instantaneous intake air mass flow rate [kg/s]
$q_{m,c}$	— time-corrected exhaust mass flow rate [kg/s]
$q_{mew,i}$	— instantaneous exhaust mass flow rate [kg/s]
$q_{mf,i}$	— instantaneous fuel mass flow rate [kg/s]
$q_{m,r}$	— raw exhaust mass flow rate [kg/s]
r	— cross-correlation coefficient
r^2	— coefficient of determination
r_h	— hydrocarbon response factor
rpm	— revolutions per minute
s	— second
u_{gas}	— u value of the exhaust component 'gas'

3. TIME CORRECTION OF PARAMETERS

For the correct calculation of distance-specific emissions, the recorded traces of component concentrations, exhaust mass flow rate, vehicle speed, and other vehicle data shall be time corrected. To facilitate the time correction, data which are subject to time alignment shall be recorded either in a single data recording device or with a synchronised timestamp following point 5.1 of Appendix 1. The time correction and alignment of parameters shall be carried out by following the sequence described in points 3.1 to 3.3.

3.1. Time correction of component concentrations

The recorded traces of all component concentrations shall be time corrected by reverse shifting according to the transformation times of the respective analysers. The transformation time of analysers shall be determined according to point 4.4 of Appendix 2:

$$c_{i,c}(t - \Delta t_{t,i}) = c_{i,r}(t)$$

where:

$c_{i,c}$	is the time-corrected concentration of component i as function of time t
$c_{i,r}$	is the raw concentration of component i as function of time t
$\Delta t_{t,i}$	is the transformation time t of the analyser measuring component i

3.2. Time correction of exhaust mass flow rate

The exhaust mass flow rate measured with an exhaust flow meter shall be time corrected by reverse shifting according to the transformation time of the exhaust mass flow meter. The transformation time of the mass flow meter shall be determined according to point 4.4.9 of Appendix 2:

$$q_{m,c}(t - \Delta t_{t,m}) = q_{m,r}(t)$$

where:

$q_{m,c}$	is the time-corrected exhaust mass flow rate as function of time t
$q_{m,r}$	is the raw exhaust mass flow rate as function of time t
$\Delta t_{t,m}$	is the transformation time t of the exhaust mass flow meter

In case the exhaust mass flow rate is determined by ECU data or a sensor, an additional transformation time shall be considered and obtained by cross-correlation between the calculated exhaust mass flow rate and the exhaust mass flow rate measured following point 4 of Appendix 3.

3.3. Time alignment of vehicle data

Status: Point in time view as at 01/06/2017.

Changes to legislation: There are outstanding changes not yet made to Commission Regulation (EU) 2017/1151. Any changes that have already been made to the legislation appear in the content and are referenced with annotations. (See end of Document for details)

Other data obtained from a sensor or the ECU shall be time-aligned by cross-correlation with suitable emission data (e.g., component concentrations).

3.3.1. *Vehicle speed from different sources*

To time align vehicle speed with the exhaust mass flow rate, it is first necessary to establish one valid speed trace. In case vehicle speed is obtained from multiple sources (e.g., the GPS, a sensor or the ECU), the speed values shall be time aligned by cross-correlation.

3.3.2. *Vehicle speed with exhaust mass flow rate*

Vehicle speed shall be time aligned with the exhaust mass flow rate by cross-correlation between the exhaust mass flow rate and the product of vehicle speed and positive acceleration.

3.3.3. *Further signals*

The time alignment of signals whose values change slowly and within a small value range, e.g. ambient temperature, can be omitted.

4. COLD START

The cold start period covers the first 5 minutes after initial start of the combustion engine. If the coolant temperature can be reliably determined, the cold start period ends once the coolant has reached 343 K (70 °C) for the first time but no later than 5 min after initial engine start. Cold start emissions shall be recorded.

5. EMISSION MEASUREMENTS DURING ENGINE STOP

Any instantaneous emissions or exhaust flow measurements obtained while the combustion engine is deactivated shall be recorded. In a separate step, the recorded values shall afterward be set to zero by the data post processing. The combustion engine shall be considered as deactivated if two of the following criteria apply: the recorded engine speed is < 50 rpm; the exhaust mass flow rate is measured at < 3 kg/h; the measured exhaust mass flow rate drops to <15 % of the steady-state exhaust mass flow rate at idling.

6. CONSISTENCY CHECK OF VEHICLE ALTITUDE

In case well-reasoned doubts exist that a trip has been conducted above of the permissible altitude as specified in point 5.2 of this Annex and in case altitude has only been measured with a GPS, the GPS altitude data shall be checked for consistency and, if necessary, corrected. The consistency of data shall be checked by comparing the latitude, longitude and altitude data obtained from the GPS with the altitude indicated by a digital terrain model or a topographic map of suitable scale. Measurements that deviate by more than 40 m from the altitude depicted in the topographic map shall be manually corrected and marked.

7. CONSISTENCY CHECK OF GPS VEHICLE SPEED

The vehicle speed as determined by the GPS shall be checked for consistency by calculating and comparing the total trip distance with reference measurements obtained from either a sensor, the validated ECU or, alternatively, from a digital road network or topographic map. It is mandatory to correct GPS data for obvious errors, e.g., by applying a dead reckoning sensor, prior to the consistency check. The original and uncorrected data file shall be retained and any corrected data shall be marked. The corrected data shall not exceed an uninterrupted time period of 120 s or a total of 300 s. The total trip distance as calculated from the corrected GPS data shall deviate by no more than 4 % from the reference. If the GPS data do not meet these requirements and no other reliable speed source is available, the test results shall be voided.

8. CORRECTION OF EMISSIONS

Status: Point in time view as at 01/06/2017.

Changes to legislation: There are outstanding changes not yet made to Commission Regulation (EU) 2017/1151. Any changes that have already been made to the legislation appear in the content and are referenced with annotations. (See end of Document for details)

8.1. Dry-wet correction

If the emissions are measured on a dry basis, the measured concentrations shall be converted to a wet basis as:

where:

$$c_{\text{wet}} = k_w \times c_{\text{dry}}$$

c_{wet} is the wet concentration of a pollutant in ppm or per cent volume
 c_{dry} is the dry concentration of a pollutant in ppm or per cent volume
 k_w is the dry-wet correction factor

The following equation shall be used to calculate k_w :

$$k_w = \left(\frac{1}{1 + \alpha \times 0,005 \times (c_{\text{CO}_2} + c_{\text{CO}})} - k_{w1} \right) \times 1,008$$

where:

$$k_{w1} = \frac{1,608 \times H_a}{1000 + (1,608 \times H_a)}$$

where:

H_a is the intake air humidity [g water per kg dry air]
 c_{CO_2} is the dry CO₂ concentration [%]
 c_{CO} is the dry CO concentration [%]
 α is the molar hydrogen ratio

8.2. Correction of NO_x for ambient humidity and temperature

NO_x emissions shall not be corrected for ambient temperature and humidity.

9. DETERMINATION OF THE INSTANTANEOUS GASEOUS EXHAUST COMPONENTS

9.1. Introduction

The components in the raw exhaust shall be measured with the measurement and sampling analysers described in Appendix 2. The raw concentrations of relevant components shall be measured in accordance with Appendix 1. The data shall be time corrected and aligned in accordance with point 3.

9.2. Calculating NMHC and CH₄ concentrations

For methane measurement using a NMC-FID, the calculation of NMHC depends on the calibration gas/method used for the zero/span calibration adjustment. When a FID is used for THC measurement without a NMC, it shall be calibrated with propane/air or propane/N₂ in the normal manner. For the calibration of the FID in series with a NMC, the following methods are permitted:

- the calibration gas consisting of propane/air bypasses the NMC;
- the calibration gas consisting of methane/air passes through the NMC.

It is strongly recommended to calibrate the methane FID with methane/air through the NMC.

In method (a), the concentrations of CH₄ and NMHC shall be calculated as follows:

$$c_{\text{CH}_4} = \frac{c_{\text{HC(w)/NMC}} \times (1 - E_M) - c_{\text{HC(w)/NMC}}}{(E_B - E_M)}$$

Status: Point in time view as at 01/06/2017.

Changes to legislation: There are outstanding changes not yet made to Commission Regulation (EU) 2017/1151. Any changes that have already been made to the legislation appear in the content and are referenced with annotations. (See end of Document for details)

$$c_{\text{NMHC}} = \frac{c_{\text{HC(w/NMC)}} - c_{\text{HC(w/oNMC)}} \times (1 - E_E)}{r_h \times (E_E - E_M)}$$

In method (b), the concentration of CH₄ and NMHC shall be calculated as follows:

$$c_{\text{CH}_4} = \frac{c_{\text{HC(w/NMC)}} \times r_h \times (1 - E_M) - c_{\text{HC(w/oNMC)}} \times (1 - E_E)}{r_h \times (E_E - E_M)}$$

$$c_{\text{NMHC}} = \frac{c_{\text{HC(w/oNMC)}} \times (1 - E_M) - c_{\text{HC(w/NMC)}} \times r_h \times (1 - E_M)}{(E_E - E_M)}$$

where:

$c_{\text{HC(w/oNMC)}}$	is the HC concentration with CH ₄ or C ₂ H ₆ bypassing the NMC [ppmC ₁]
$c_{\text{HC(w/NMC)}}$	is the HC concentration with CH ₄ or C ₂ H ₆ flowing through the NMC [ppmC ₁]
r_h	is the hydrocarbon response factor as determined in point 4.3.3.(b) of Appendix 2
E_M	is the methane efficiency as determined in point 4.3.4.(a) of Appendix 2
E_E	is the ethane efficiency as determined in point 4.3.4(b) of Appendix 2

If the methane FID is calibrated through the cutter (method b), then the methane conversion efficiency as determined in point 4.3.4.(a) of Appendix 2 is zero. The density used for calculating the NMHC mass shall be equal to that of total hydrocarbons at 273,15 K and 101,325 kPa and is fuel-dependent.

10. DETERMINATION OF EXHAUST MASS FLOW RATE

10.1. Introduction

The calculation of instantaneous mass emissions according to points 11 and 12 requires determining the exhaust mass flow rate. The exhaust mass flow rate shall be determined by one of the direct measurement methods specified in point 7.2 of Appendix 2. Alternatively, it is permissible to calculate the exhaust mass flow rate as described in points 10.2 to 10.4.

10.2. Calculation method using air mass flow rate and fuel mass flow rate

The instantaneous exhaust mass flow rate can be calculated from the air mass flow rate and the fuel mass flow rate as follows:

$$q_{\text{mew},i} = q_{\text{maw},i} + q_{\text{mf},i}$$

where:

$q_{\text{mew},i}$	is the instantaneous exhaust mass flow rate [kg/s]
$q_{\text{maw},i}$	is the instantaneous intake air mass flow rate [kg/s]
$q_{\text{mf},i}$	is the instantaneous fuel mass flow rate [kg/s]

If the air mass flow rate and the fuel mass flow rate or the exhaust mass flow rate are determined from ECU recording, the calculated instantaneous exhaust mass flow rate shall meet the linearity requirements specified for the exhaust mass flow rate in point 3 of Appendix 2 and the validation requirements specified in point 4.3 of Appendix 3.

10.3. Calculation method using air mass flow and air-to-fuel ratio

The instantaneous exhaust mass flow rate can be calculated from the air mass flow rate and the air-to-fuel ratio as follows:

$$q_{\text{mew},i} = q_{\text{maw},i} \times \left(1 + \frac{1}{A/F_{st} \times \lambda_t}\right)$$

where:

Status: Point in time view as at 01/06/2017.

Changes to legislation: There are outstanding changes not yet made to Commission Regulation (EU) 2017/1151. Any changes that have already been made to the legislation appear in the content and are referenced with annotations. (See end of Document for details)

$$A / F_{st} = \frac{138,0 \times \left(1 + \frac{\alpha}{4} - \frac{\epsilon}{2} + \gamma\right)}{12,011 + 1,008 \times \alpha + 15,9904 \times \epsilon + 14,0067 \times \delta + 32,0673 \times \gamma}$$

$$\lambda_i = \frac{\left(100 - \frac{c_{CO} \times 10^{-4}}{2} - c_{HCw} \times 10^{-4}\right) + \left(\frac{\alpha}{4} \times \frac{1 - \frac{2 \times c_{CO} \times 10^{-4}}{3,5 \times c_{CO2}}}{1 + \frac{c_{CO} \times 10^{-4}}{3,5 \times c_{CO2}}} - \frac{\epsilon}{2} - \frac{\delta}{2}\right) \times (c_{CO2} + c_{CO} \times 10^{-4})}{4,764 \times \left(1 + \frac{\alpha}{4} - \frac{\epsilon}{2} + \gamma\right) \times (c_{CO2} + c_{CO} \times 10^{-4} + c_{HCw} \times 10^{-4})}$$

where:

$q_{maw,i}$	is the instantaneous intake air mass flow rate [kg/s]
A/F_{st}	is the stoichiometric air-to-fuel ratio [kg/kg]
λ_i	is the instantaneous excess air ratio
c_{CO2}	is the dry CO ₂ concentration [%]
c_{CO}	is the dry CO concentration [ppm]
c_{HCw}	is the wet HC concentration [ppm]
α	is the molar hydrogen ratio (H/C)
β	is the molar carbon ratio (C/C)
γ	is the molar sulphur ratio (S/C)
δ	is the molar nitrogen ratio (N/C)
ϵ	is the molar oxygen ratio (O/C)

Coefficients refer to a fuel C_β H_α O_ε N_δ S_γ with β = 1 for carbon based fuels. The concentration of HC emissions is typically low and may be omitted when calculating λ_i.

If the air mass flow rate and air-to-fuel ratio are determined from ECU recording, the calculated instantaneous exhaust mass flow rate shall meet the linearity requirements specified for the exhaust mass flow rate in point 3 of Appendix 2 and the validation requirements specified in point 4.3 of Appendix 3.

10.4. Calculation method using fuel mass flow and air-to-fuel ratio

The instantaneous exhaust mass flow rate can be calculated from the fuel flow and the air-to-fuel ratio (calculated with A/F_{st} and λ_i according to point 10.3) as follows:

$$q_{mew,i} = q_{mf,i} \times (1 + A / F_{st} \times \lambda_i)$$

The calculated instantaneous exhaust mass flow rate shall meet the linearity requirements specified for the exhaust gas mass flow rate in point 3 of Appendix 2 and the validation requirements specified in point 4.3 of Appendix 3.

11. CALCULATING THE INSTANTANEOUS MASS EMISSIONS OF GASEOUS COMPONENTS

The instantaneous mass emissions [g/s] shall be determined by multiplying the instantaneous concentration of the pollutant under consideration [ppm] with the instantaneous exhaust mass flow rate [kg/s], both corrected and aligned for the transformation time, and the respective u value of Table 1. If measured on a dry basis, the dry-wet correction according to point 8.1 shall be applied to the instantaneous component concentrations before executing any further calculations. If occurring, negative instantaneous emission values shall enter all subsequent data evaluations. Parameter values shall enter the calculation of instantaneous emissions [g/s] as reported by the analyser, flow-measuring instrument, sensor or the ECU. The following equation shall be applied:

where:

$$m_{gas,i} = u_{gas} \times c_{gas,i} \times q_{mew,i}$$

$m_{gas,i}$ is the mass of the exhaust component 'gas' [g/s]

Status: Point in time view as at 01/06/2017.

Changes to legislation: There are outstanding changes not yet made to Commission Regulation (EU) 2017/1151. Any changes that have already been made to the legislation appear in the content and are referenced with annotations. (See end of Document for details)

u_{gas}	is the ratio of the density of the exhaust component ‘gas’ and the overall density of the exhaust as listed in Table 1
$c_{\text{gas},i}$	is the measured concentration of the exhaust component ‘gas’ in the exhaust [ppm]
$q_{\text{mew},i}$	is the measured exhaust mass flow rate [kg/s]
gas	is the respective component
i	number of the measurement

TABLE 1

Raw exhaust gas u values depicting the ratio between the densities of exhaust component or pollutant i [kg/m^3] and the density of the exhaust gas [kg/m^3]⁰

Fuel	ρ_e [kg/m^3]	Component or pollutant i					
		NO _x	CO	HC	CO ₂	O ₂	CH ₄
		ρ_{gas} [kg/m^3]					
		2,053	1,25	^a	1,9636	1,4277	0,716
		u_{gas} ^{b f}					
Diesel (B7)	1,2943	0,001586	0,000966	0,000482	0,001517	0,001103	0,000553
Ethanol (ED95)	1,2768	0,001609	0,00098	0,00078	0,001539	0,001119	0,000561
CNG ^c	1,2661	0,001621	0,000987	0,000528 ^d	0,001551	0,001128	0,000565
Propane	1,2805	0,001603	0,000976	0,000512	0,001533	0,001115	0,000559
Butane	1,2832	0,0016	0,000974	0,000505	0,00153	0,001113	0,000558
LPG ^e	1,2811	0,001602	0,000976	0,00051	0,001533	0,001115	0,000559
Petrol (E10)	1,2931	0,001587	0,000966	0,000499	0,001518	0,001104	0,000553
Ethanol (E85)	1,2797	0,001604	0,000977	0,00073	0,001534	0,001116	0,000559

a depending on fuel

b at $\lambda = 2$, dry air, 273 K, 101.3 kPa

c u values accurate within 0,2 % for mass composition of: C=66-76 %; H=22-25 %; N=0-12 %

d NMHC on the basis of CH_{2,93} (for THC the u_{gas} coefficient of CH₄ shall be used)

e u accurate within 0,2 % for mass composition of: C₃=70-90 %; C₄=10-30 %

f u_{gas} is a unitless parameter; the u_{gas} values include unit conversions to ensure that the instantaneous emissions are obtained in the specified physical unit, i.e., g/s

12. CALCULATING THE INSTANTANEOUS PARTICLE NUMBER EMISSIONS

This sections will define the requirement for calculating instantaneous particle number emissions, once their measurement becomes mandatory.

13. DATA REPORTING AND EXCHANGE

Status: Point in time view as at 01/06/2017.

Changes to legislation: There are outstanding changes not yet made to Commission Regulation (EU) 2017/1151. Any changes that have already been made to the legislation appear in the content and are referenced with annotations. (See end of Document for details)

The data shall be exchanged between the measurement systems and the data evaluation software by a standardised reporting file as specified in point 2 of Appendix 8. Any pre-processing of data (e.g. time correction according to point 3 or the correction of the GPS vehicle speed signal according to point 7) shall be done with the control software of the measurement systems and shall be completed before the data reporting file is generated. If data are corrected or processed prior to entering the data reporting file, the original raw data shall be kept for quality assurance and control. Rounding of intermediate values is not permitted.

Appendix 5

Verification of trip dynamic conditions and calculation of the final RDE emissions result with method 1 (Moving Averaging Window)

1. INTRODUCTION

The Moving Averaging Window method provides an insight on the real-driving emissions (RDE) occurring during the test at a given scale. The test is divided in sub-sections (windows) and the subsequent statistical treatment aims at identifying which windows are suitable to assess the vehicle RDE performance.

The ‘normality’ of the windows is conducted by comparing their CO₂ distance-specific emissions⁽²⁴⁾ with a reference curve. The test is complete when the test includes a sufficient number of normal windows, covering different speed areas (urban, rural, motorway).

- | | |
|---------|---|
| Step 1. | Segmentation of the data and exclusion of cold start emissions (section 4 in Appendix 4); |
| Step 2. | Calculation of emissions by sub-sets or ‘windows’ (section 3.1); |
| Step 3. | Identification of normal windows (section 4); |
| Step 4. | Verification of trip completeness and normality (section 5); |
| Step 5. | Calculation of emissions using the normal windows (section 6). |

2. SYMBOLS, PARAMETERS AND UNITS

Index (i) refers to the time step

Index (j) refers to the window

Index (k) refers to the category (t=total, u=urban, r=rural, m=motorway) or to the CO₂ characteristic curve (cc)

Index ‘gas’ refers to the regulated exhaust gas components (e.g. NO_x, CO, PN)

Δ	– difference
\geq	– larger or equal
#	– number
%	– per cent
\leq	– smaller or equal
a_1, b_1	– coefficients of the CO ₂ characteristic curve
a_2, b_2	– coefficients of the CO ₂ characteristic curve
d_j	– distance covered by window j [km]
f_k	– weighting factors for urban, rural and motorway shares
h	– distance of windows to the CO ₂ characteristic curve [%]
h_j	– distance of window j to the CO ₂ characteristic curve [%]

Status: Point in time view as at 01/06/2017.

Changes to legislation: There are outstanding changes not yet made to Commission Regulation (EU) 2017/1151. Any changes that have already been made to the legislation appear in the content and are referenced with annotations. (See end of Document for details)

\bar{h}_k	– severity index for urban, rural and motorway shares and the complete trip
k_{11}, k_{12}	– coefficients of the weighting function
k_{21}, k_{21}	– coefficients of the weighting function
$M_{CO_2,ref}$	– reference CO ₂ mass [g]
M_{gas}	– mass or particle number of the exhaust component ‘gas’ [g] or [#]
$M_{gas,j}$	– mass or particle number of the exhaust component ‘gas’ in window j [g] or [#]
$M_{gas,d}$	– distance-specific emission for the exhaust component ‘gas’ [g/km] or [#km]
$M_{gas,d,j}$	– distance-specific emission for the exhaust component ‘gas’ in window j [g/km] or [#km]
N_k	– number of windows for urban, rural, and motorway shares
P_1, P_2, P_3	– reference points
t	– time [s]
$t_{1,j}$	– first second of the j^{th} averaging window [s]
$t_{2,j}$	– last second of the j^{th} averaging window [s]
t_i	– total time in step i [s]
$t_{i,j}$	– total time in step i considering window j [s]
tol_1	– primary tolerance for the vehicle CO ₂ characteristic curve [%]
tol_2	– secondary tolerance for the vehicle CO ₂ characteristic curve [%]
t_t	– duration of a test [s]
v	– vehicle speed [km/h]
\bar{v}	– average speed of windows [km/h]
v_i	– actual vehicle speed in time step i [km/h]
\bar{v}_j	– average vehicle speed in window j [km/h]
$\bar{v}_{p1} = 19 \text{ km/h}$	– average speed of the Low Speed phase of the WLTP cycle
$\bar{v}_{p2} = 56,6 \text{ km/h}$	– average speed of the High Speed phase of the WLTP cycle
$\bar{v}_{p3} = 92,3 \text{ km/h}$	– average speed of the Extra High Speed phase of the WLTP cycle
w	– weighting factor for windows
w_j	– weighting factor of window j

3. MOVING AVERAGING WINDOWS

3.1. Definition of averaging windows

The instantaneous emissions calculated according to Appendix 4 shall be integrated using a moving averaging window method, based on the reference CO₂ mass. The principle of the calculation is as follows: The mass emissions are not calculated for the complete data set, but for sub-sets of the complete data set, the length of these sub-sets being determined so as to match the CO₂ mass emitted by the vehicle over the reference laboratory cycle. The moving average calculations are conducted with a time increment Δt corresponding to the data sampling frequency. These sub-sets used to average the emissions data are referred to as ‘averaging windows’. The calculation described in the present point may be run from the last point (backwards) or from the first point (forward).

The following data shall not be considered for the calculation of the CO₂ mass, the emissions and the distance of the averaging windows:

- The periodic verification of the instruments and/or after the zero drift verifications;
- The cold start emissions, defined according to Appendix 4, point 4.4;
- Vehicle ground speed < 1 km/h;

Status: Point in time view as at 01/06/2017.

Changes to legislation: There are outstanding changes not yet made to Commission Regulation (EU) 2017/1151. Any changes that have already been made to the legislation appear in the content and are referenced with annotations. (See end of Document for details)

— Any section of the test during which the combustion engine is switched off.

The mass (or particle number) emissions $M_{gas,j}$ shall be determined by integrating the instantaneous emissions in g/s (or #/s for PN) calculated as specified in Appendix 4.

Figure 1

Vehicle speed versus time - Vehicle averaged emissions versus time, starting from the first averaging window

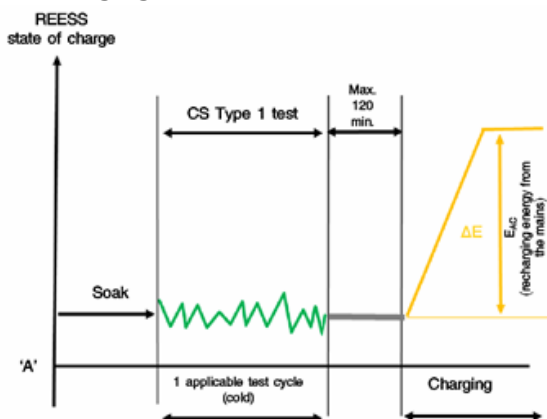
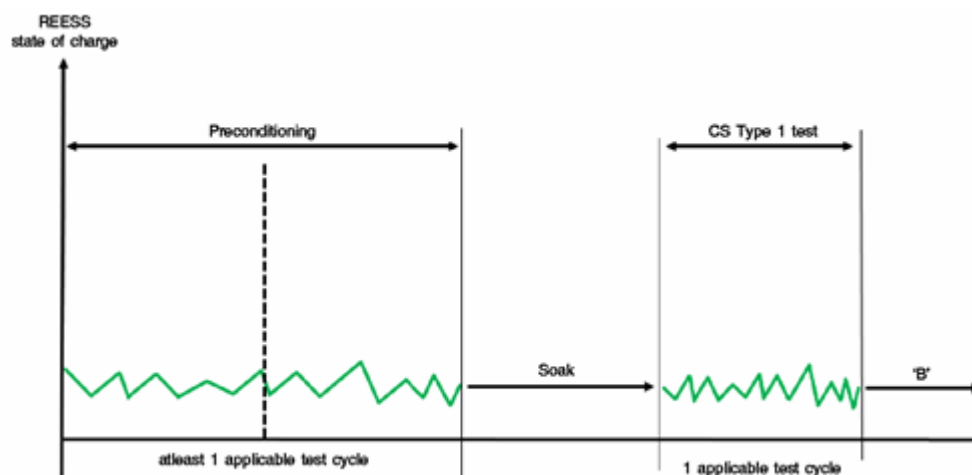

Figure 2

Definition of CO₂ mass based on averaging windows



The duration

$$(t_{2,j} - t_{1,j})$$

of the j^{th} averaging window is determined by:

$$M_{CO_2}(t_{2,j}) - M_{CO_2}(t_{1,j}) \geq M_{CO_2,ref}$$

where:

$$M_{CO_2}(t_{1,j})$$

is the CO₂ mass measured between the test start and time $(t_{2,j})$ [g];

$$M_{CO_2,ref}$$

Status: Point in time view as at 01/06/2017.

Changes to legislation: There are outstanding changes not yet made to Commission Regulation (EU) 2017/1151. Any changes that have already been made to the legislation appear in the content and are referenced with annotations. (See end of Document for details)

is the half of the CO₂ mass [g] emitted by the vehicle over the Worldwide harmonized Light vehicles Test Cycle (WLTC) described in the UNECE Global Technical Regulation No. 15 - Worldwide harmonized Light vehicles Test Procedure (ECE/TRANS/180/Add.15; Type I test, including cold start);

$t_{2,j}$ shall be selected such as:

$$M_{CO_2}(t_{2j} - \Delta t) - M_{CO_2}(t_{1j}) < M_{CO_2,ref} \leq M_{CO_2}(t_{2j}) - M_{CO_2}(t_{1j})$$

where Δt is the data sampling period.

The CO₂ masses are calculated in the windows by integrating the instantaneous emissions calculated as specified in Appendix 4 to this Annex.

3.2. Calculation of window emissions and averages

The following shall be calculated for each window determined in accordance with point 3.1.,

- The distance-specific emissions $M_{gas,d,j}$ for all the pollutants specified in this annex;
- The distance-specific CO₂ emissions $M_{CO_2,d,j}$;
- The average vehicle speed
 \bar{v}_j

4. EVALUATION OF WINDOWS

4.1. Introduction

The reference dynamic conditions of the test vehicle are set out from the vehicle CO₂ emissions versus average speed measured at type approval and referred to as ‘vehicle CO₂ characteristic curve’.

To obtain the distance-specific CO₂ emissions, the vehicle shall be tested on the chassis dynamometer by applying the vehicle road load settings as determined following the procedure prescribed in Annex 4 of the UNECE Global Technical Regulation No. 15 - Worldwide harmonized Light vehicles Test Procedure (ECE/TRANS/180/Add.15). The road loads shall not account for the mass added to the vehicle during the RDE test, e.g. the co-pilot and the PEMS equipment.

4.2. CO₂ characteristic curve reference points

The reference points P_1 , P_2 and P_3 required to define the curve shall be established as follows:

4.2.1. Point P_1

$$v_{P_1} = 19 \text{ km/h}$$

(average speed of the Low Speed phase of the WLTP cycle)

$$M_{CO_2,d,P_1}$$

= Vehicle CO₂ emissions over the Low Speed phase of the WLTP cycle x 1,2 [g/km]

4.2.2. Point P_2

$$v_{P_2} = 56,6 \text{ km/h}$$

(average speed of the High Speed phase of the WLTP cycle)

$$M_{CO_2,d,P_2}$$

= Vehicle CO₂ emissions over the High Speed phase of the WLTP cycle x 1.1 [g/km]

Status: Point in time view as at 01/06/2017.

Changes to legislation: There are outstanding changes not yet made to Commission Regulation (EU) 2017/1151. Any changes that have already been made to the legislation appear in the content and are referenced with annotations. (See end of Document for details)

4.2.4. Point P_3

4.2.5. $\bar{v}_{P_3} = 92,3 \text{ km/h}$
 (average speed of the Extra High Speed phase of the WLTP cycle)

M_{CO_2,d,P_3}

= Vehicle CO₂ emissions over the Extra High Speed phase of the WLTP cycle x 1,05 [g/km]

4.3. CO₂ characteristic curve definition

Using the reference points defined in section 4.2, the characteristic curve CO₂ emissions are calculated as a function of the average speed using two linear sections (P_1, P_2) and (P_2, P_3). The section (P_2, P_3) is limited to 145 km/h on the vehicle speed axis. The characteristic curve is defined by equations as follows:

For the section (P_1, P_2):

$$M_{CO_2,d,CC}(\bar{v}) = a_1 \bar{v} + b_1$$

with $a_1 = (M_{CO_2,d,P_2} - M_{CO_2,d,P_1}) / (\bar{v}_{P_2} - \bar{v}_{P_1})$

and $b_1 = M_{CO_2,d,P_1} - a_1 \bar{v}_{P_1}$

For the section (P_2, P_3):

$$M_{CO_2,d,CC}(\bar{v}) = a_2 \bar{v} + b_2$$

with $a_2 = (M_{CO_2,d,P_3} - M_{CO_2,d,P_2}) / (\bar{v}_{P_3} - \bar{v}_{P_2})$

and $b_2 = M_{CO_2,d,P_2} - a_2 \bar{v}_{P_2}$

Figure 3

Vehicle CO₂ characteristic curve

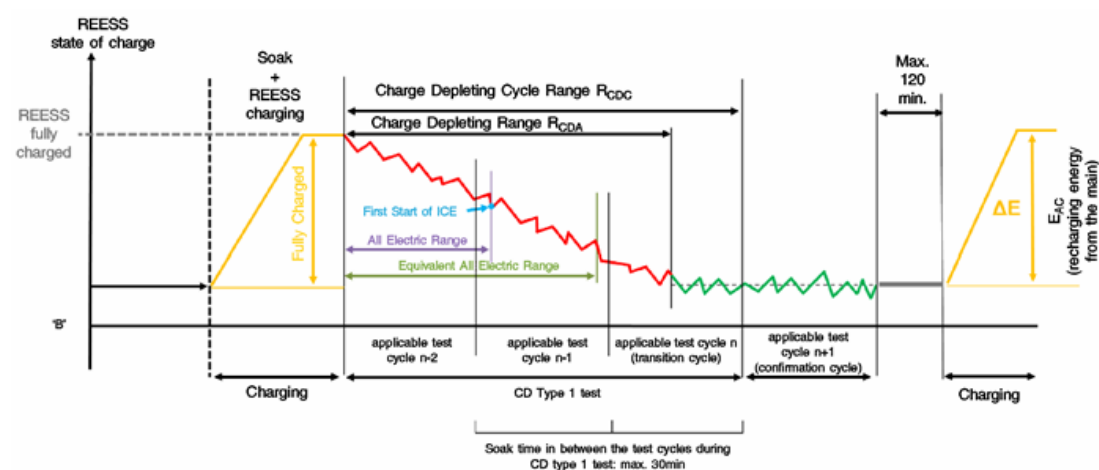

4.4. Urban, rural and motorway windows

4.4.1. Urban windows are characterized by average vehicle ground speeds \bar{v}_j smaller than 45 km/h,

4.4.2. Rural windows are characterized by average vehicle ground speeds \bar{v}_j greater than or equal to 45 km/h and smaller than 80 km/h,

Status: Point in time view as at 01/06/2017.

Changes to legislation: There are outstanding changes not yet made to Commission Regulation (EU) 2017/1151. Any changes that have already been made to the legislation appear in the content and are referenced with annotations. (See end of Document for details)

4.4.3. Motorway windows are characterized by average vehicle ground speeds

\bar{v}_j
greater than or equal to 80 km/h and smaller than 145 km/h

Figure 4

Vehicle CO₂ characteristic curve: urban, rural and motorway driving definitions

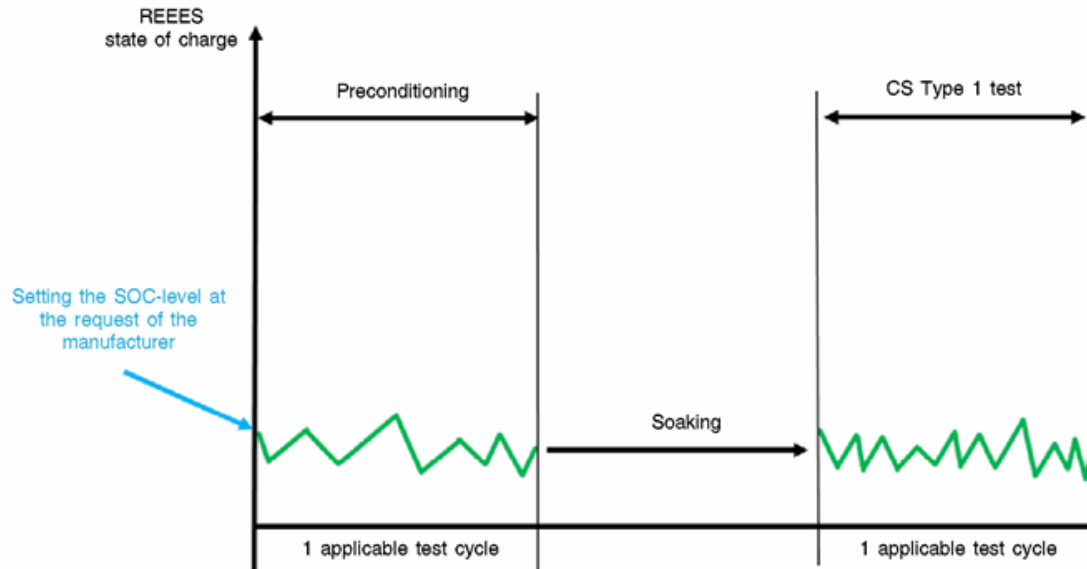

5. VERIFICATION OF TRIP COMPLETENESS AND NORMALITY

5.1. Tolerances around the vehicle CO₂ characteristic curve

The primary tolerance and the secondary tolerance of the vehicle CO₂ characteristic curve are respectively $tol_1 = 25\%$ and $tol_2 = 50\%$.

5.2. Verification of test completeness

The test shall be complete when it comprises at least 15 % of urban, rural and motorway windows, out of the total number of windows.

5.3. Verification of test normality

The test shall be normal when at least 50 % of the urban, rural and motorway windows are within the primary tolerance defined for the characteristic curve.

If the specified minimum requirement of 50 % is not met, the upper positive tolerance tol_1 may be increased by steps of 1 percentage point until the 50 % of normal windows target is reached. When using this approach, tol_1 shall never exceed 30 %.

6. CALCULATION OF EMISSIONS

6.1. Calculation of weighted distance-specific emissions

The emissions shall be calculated as a weighted average of the windows' distance-specific emissions separately for the urban, rural and motorway categories and the complete trip.

$$M_{gwa,d,k} = \frac{\sum(w_j M_{gwa,d,j})}{\sum w_j} \quad k = u, r, m$$

Status: Point in time view as at 01/06/2017.

Changes to legislation: There are outstanding changes not yet made to Commission Regulation (EU) 2017/1151. Any changes that have already been made to the legislation appear in the content and are referenced with annotations. (See end of Document for details)

The weighting factor w_j for each window shall be determined as such:

If

$$M_{CO_2,d,CC}(\bar{v}_j) \times (1 - tol_1 / 100) \leq M_{CO_2,d,j} \leq M_{CO_2,d,C}(\bar{v}_j) \times (1 + tol_1 / 100)$$

Then

$$w_j = 1$$

If

$$M_{CO_2,d,CC}(\bar{v}_j) \times (1 + tol_1 / 100) < M_{CO_2,d,j} \leq M_{CO_2,d,CC}(\bar{v}_j) \times (1 + tol_2 / 100)$$

Then

$$w_j = k_{11} h_j + k_{12}$$

With

$$k_{11} = 1 / (tol_1 - tol_2)$$

and

$$k_{12} = tol_2 / (tol_2 - tol_1)$$

If

$$M_{CO_2,d,CC}(\bar{v}_j) \times (1 - tol_2 / 100) \leq M_{CO_2,d,j} < M_{CO_2,d,CC}(\bar{v}_j) \times (1 - tol_1 / 100)$$

Then

$$w_j = k_{21} h_j + k_{22}$$

with

$$k_{21} = 1 / (tol_2 - tol_1)$$

and

$$k_{22} = k_{12} = tol_2 / (tol_2 - tol_1)$$

If

$$M_{CO_2,d,j} < M_{CO_2,d,CC}(\bar{v}_j) \times (1 - tol_2 / 100)$$

or

$$M_{CO_2,d,j} > M_{CO_2,d,CC}(\bar{v}_j) \times (1 + tol_2 / 100)$$

Then

$$w_j = 0$$

where:

$$h_j = 100 \times \frac{M_{CO_2,d,j} - M_{CO_2,d,CC}(\bar{v}_j)}{M_{CO_2,d,CC}(\bar{v}_j)}$$

Figure 5 Averaging window weighting function

Status: Point in time view as at 01/06/2017.

Changes to legislation: There are outstanding changes not yet made to Commission Regulation (EU) 2017/1151. Any changes that have already been made to the legislation appear in the content and are referenced with annotations. (See end of Document for details)

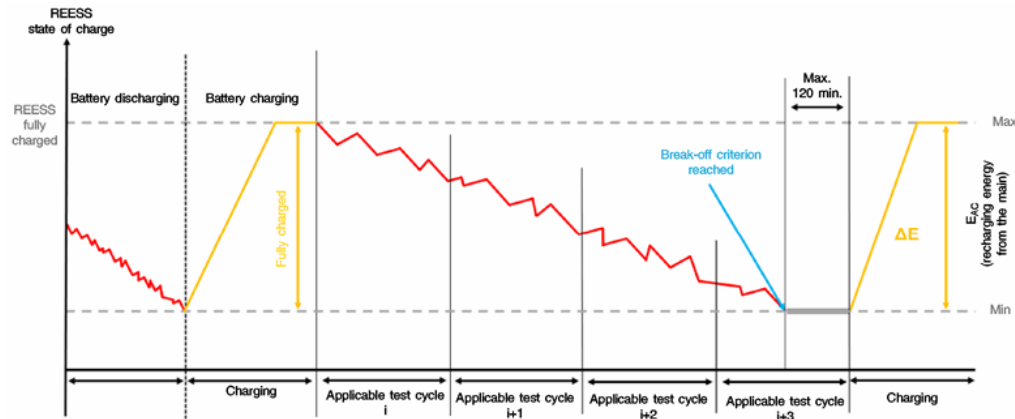

6.2. Calculation of severity indices

The severity indices shall be calculated separately for the urban, rural and motorway categories:

$$\bar{h}_k = \frac{1}{N_k} \sum h_{jk} \quad k = u, r, m$$

and the complete trip:

$$\bar{h}_t = \frac{f_u \bar{h}_u + f_r \bar{h}_r + f_m \bar{h}_m}{f_u + f_r + f_m}$$

where f_u , f_r , f_m are equal to 0,34, 0,33 and 0,33 respectively.

6.3. Calculation of emissions for the total trip

Using the weighted distance-specific emissions calculated under point 6.1, the distance-specific emissions in [mg/km] shall be calculated for the complete trip each gaseous pollutant in the following way:

$$M_{gas,d,t} = 1000 \times \frac{f_u \times M_{gas,d,u} + f_r \times M_{gas,d,r} + f_m \times M_{gas,d,m}}{(f_u + f_r + f_m)}$$

And for particle number:

$$M_{PN,d,t} = \frac{f_u \times M_{PN,d,u} + f_r \times M_{PN,d,r} + f_m \times M_{PN,d,m}}{(f_u + f_r + f_m)}$$

Where f_u , f_r , f_m are respectively equal to 0,34, 0,33 and 0,33.

7. NUMERICAL EXAMPLES

7.1. Averaging window calculations

TABLE 1

Main calculation settings

$M_{CO_2,ref}$ [g]	610
Direction for averaging window calculation	Forward
Acquisition Frequency [Hz]	1

Status: Point in time view as at 01/06/2017.

Changes to legislation: There are outstanding changes not yet made to Commission Regulation (EU) 2017/1151. Any changes that have already been made to the legislation appear in the content and are referenced with annotations. (See end of Document for details)

Figure 6 shows how averaging windows are defined on the basis of data recorded during an on-road test performed with PEMS. For sake of clarity, only the first 1 200 seconds of the trip are shown hereafter.

Seconds 0 up to 43 as well as seconds 81 to 86 are excluded due to operation under zero vehicle speed.

The first averaging window starts at $t_{1,1} = 0s$ and ends at second $t_{2,1} = 524s$ (Table 3).

Figure 6

Instantaneous CO₂ emissions recorded during on-road test with PEMS as a function of time. Rectangular frames indicate the duration of the jth window. Data series named ‘Valid=100 / Invalid=0’ shows second by second data to be excluded from analysis.

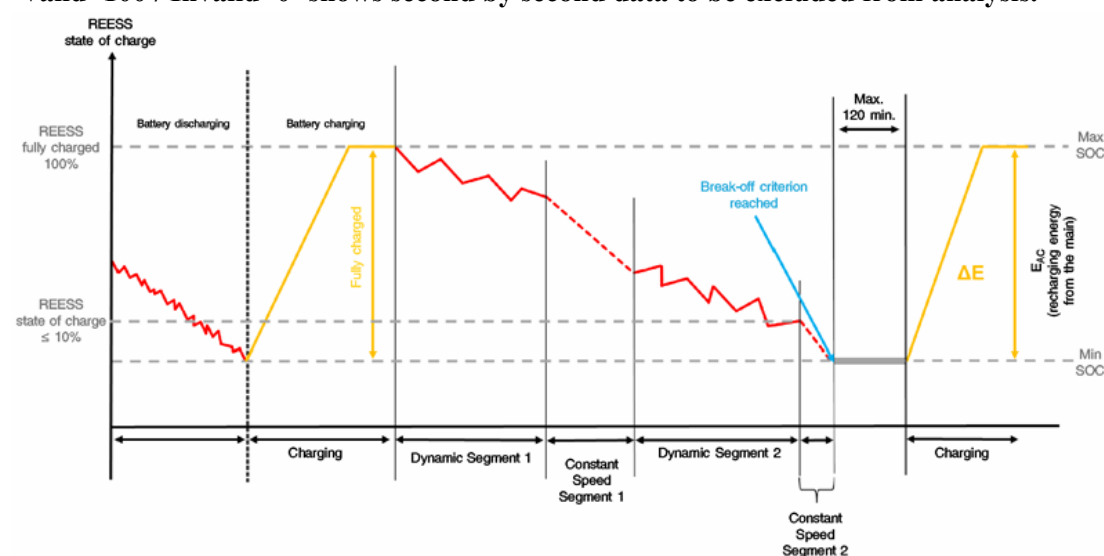

7.2. Evaluation of windows

TABLE 2

Calculation settings for the CO₂ characteristic curve

CO ₂ Low Speed WLTC × 1,2 (P ₁) [g/km]	154
CO ₂ High Speed WLTC × 1,1 (P ₂) [g/km]	96
CO ₂ Extra-High Speed WLTC × 1,05 (P ₃) [g/km]	120

Reference Point		
P ₁	$\bar{v}_{P_1} = 19,0 \text{ km / h}$	$M_{CO_2,d,P_1} = 154 \text{ g / km}$
P ₂	$\bar{v}_{P_2} = 56,6 \text{ km / h}$	$M_{CO_2,d,P_2} = 96 \text{ g / km}$
P ₃	$\bar{v}_{P_3} = 92.3 \text{ km / h}$	$M_{CO_2,d,P_3} = 120 \text{ g / km}$

The definition of the CO₂ characteristic curve is as follows:

For the section (P₁, P₂):

Status: Point in time view as at 01/06/2017.

Changes to legislation: There are outstanding changes not yet made to Commission Regulation (EU) 2017/1151. Any changes that have already been made to the legislation appear in the content and are referenced with annotations. (See end of Document for details)

$$M_{CO_2,d}(\bar{v}) = a_1 \bar{v} + b_1$$

with

$$a_1 = (96 - 154) / (56.6 - 19.0) = -\frac{58}{37.6} = -1.543$$

and

$$b_1 = 154 - (-1.543) \times 19.0 = 154 + 29.317 = 183.317$$

For the section (P_2, P_3):

$$M_{CO_2,d}(\bar{v}) = a_2 \bar{v} + b_2$$

with

$$a_2 = (120 - 96) / (92.3 - 56.6) = \frac{24}{35.7} = 0.672$$

and

$$b_2 = 96 - 0.672 \times 56.6 = 96 - 38.035 = 57.965$$

Examples of calculation for the weighting factors and the window categorisation as urban, rural or motorway are:

For window #45:

$$M_{CO_2,d,45} = 122.62 \text{ g / km}$$

$$\bar{v}_{45} = 38.12 \text{ km / h}$$

The average speed of the window is lower than 45 km/h, therefore it is an urban window.

For the characteristic curve:

$$M_{CO_2,d,CC}(\bar{v}_{45}) = a_1 \bar{v}_{45} + b_1 = -1.543 \times 38.12 + 183.317 = 124.498 \text{ g / km}$$

Verification of:

$$M_{CO_2,d,CC}(\bar{v}_j) \times (1 - \text{tol}_1 / 100) \leq M_{CO_2,d,j} \leq M_{CO_2,d,CC}(\bar{v}_j) \times (1 + \text{tol}_1 / 100)$$

$$M_{CO_2,d,CC}(\bar{v}_{45}) \times (1 - \text{tol}_1 / 100) \leq M_{CO_2,d,45} \leq M_{CO_2,d,CC}(\bar{v}_{45}) \times (1 + \text{tol}_1 / 100)$$

$$124.498 \times (1 - 25 / 100) \leq 122.62 \leq 124.498 \times (1 + 25 / 100)$$

$$93.373 \leq 122.62 \leq 155.622$$

Leads to:

$$w_{45} = 1$$

For window #556:

$$M_{CO_2,d,556} = 72.15 \text{ g / km}$$

$$\bar{v}_{556} = 50.12 \text{ km / h}$$

The average speed of the window is higher than 45 km/h but lower than 80 km/h, therefore it is a rural window.

For the characteristic curve:

$$M_{CO_2,d,CC}(\bar{v}_{556}) = a_1 \bar{v}_{556} + b_1 = -1.543 \times 50.12 + 183.317 = 105.982 \text{ g / km}$$

Verification of:

$$M_{CO_2,d,CC}(\bar{v}_j) \times (1 - \text{tol}_2 / 100) \leq M_{CO_2,d,j} < M_{CO_2,d,CC}(\bar{v}_j) \times (1 - \text{tol}_1 / 100)$$

$$M_{CO_2,d,CC}(\bar{v}_{556}) \times (1 - \text{tol}_2 / 100) \leq M_{CO_2,d,556} < M_{CO_2,d,CC}(\bar{v}_{556}) \times (1 - \text{tol}_1 / 100)$$

$$105.982 \times (1 - 50 / 100) \leq 72.15 < 105.982 \times (1 - 25 / 100)$$

$$52.991 \leq 72.15 < 79.487$$

Leads to:

Status: Point in time view as at 01/06/2017.

Changes to legislation: There are outstanding changes not yet made to Commission Regulation (EU) 2017/1151. Any changes that have already been made to the legislation appear in the content and are referenced with annotations. (See end of Document for details)

$$h_{556} = 100 \times \frac{M_{CO_2,A,556} - M_{CO_2,A,CC}(v_{556})}{M_{CO_2,A,CC}(v_{556})} = 100 \times \frac{72,15 - 105,982}{105,982} = -31,922$$

$$w_{556} = k_{21} h_{556} + k_{22} = 0,04 \times (-31,922) + 2 = 0,723$$

with

$$k_{21} = 1 / (tol_2 - tol_1) = 1 / (50 - 25) = 0,04$$

and

$$k_{22} = k_{12} = tol_2 / (tol_2 - tol_1) = 50 / (50 - 25) = 2$$

TABLE 3

Emissions numerical data

Window[#]	$t_{1,j}$ [s]	$t_{2,j} - \Delta t$ [s]	$t_{2,j}$ [s]	$M_{CO_2}(t_{2,j} - \Delta t) - M_{CO_2}(t_{2,j})$ [g]	$M_{CO_2}(t_{2,j}) - M_{CO_2}(t_{1,j}) \geq CO_{2,ref}$ [g]
1	0	523	524	609,06	610,22
2	1	523	524	609,06	610,22
...
43	42	523	524	609,06	610,22
44	43	523	524	609,06	610,22
45	44	523	524	609,06	610,22
46	45	524	525	609,68	610,86
47	46	524	525	609,17	610,34
...
100	99	563	564	609,69	612,74
...
200	199	686	687	608,44	610,01
...
474	473	1 024	1 025	609,84	610,6
475	474	1 029	1 030	609,8	610,49
...
556	555	1 173	1 174	609,96	610,59
557	556	1 174	1 175	609,09	610,08
558	557	1 176	1 177	609,09	610,59
559	558	1 180	1 181	609,79	611,23

7.3. Urban, rural and motorway windows - Trip completeness

In this numerical example, the trip consists of 7 036 averaging windows. Table 5 lists the number of windows classified in urban, rural and motorway according to their average vehicle speed

Status: Point in time view as at 01/06/2017.

Changes to legislation: There are outstanding changes not yet made to Commission Regulation (EU) 2017/1151. Any changes that have already been made to the legislation appear in the content and are referenced with annotations. (See end of Document for details)

and divided in regions with respect to their distance to the CO₂ characteristic curve. The trip is complete since it comprises at least 15 % of urban, rural and motorway windows out of the total number of windows. In addition the trip is characterized as normal since at least 50 % of the urban, rural and motorway windows are within the primary tolerances defined for the characteristic curve.

TABLE 4

Verification of trip completeness and normality

Driving Conditions	Numbers	Percentage of windows
All Windows		
Urban	1 909	1 909/7 036*100=27,1 > 15
Rural	2 011	2 011/7 036*100=28,6 > 15
Motorway	3 116	3 116/7 036*100=44,3 > 15
Total	1 909 + 2 011 + 3 116=7 036	
Normal Windows		
Urban	1 514	1 514/1 909*100=79,3 > 50
Rural	1 395	1 395/2 011*100=69,4 > 50
Motorway	2 708	2 708/3 116*100=86,9 > 50
Total	1 514 + 1 395+2 708=5 617	

Appendix 6

Verification of trip dynamic conditions and calculation of the final RDE emissions result with method 2 (Power Binning)

1. INTRODUCTION

This Appendix describes the data evaluation according to the power binning method, named in this appendix ‘evaluation by normalisation to a standardised power frequency (SPF) distribution’

2. SYMBOLS, PARAMETERS AND UNITS

$a_{ref}...$	Reference acceleration for P_{drive} , [0,45 m/s ²]
$D_{WLTC}...$	intercept of the Veline from WLTC
$f_0, f_1, f_2...$	Driving resistance coefficients [N], [N/(km/h)], [N/(km/h) ²]
$i...$	Time step for instantaneous measurements, minimum resolution 1Hz
$j...$	Wheel power class, j=1 to 9
$k...$	Time step for the 3 second moving average values
$k_{WLTC}...$	Slope of the Veline from WLTC
$m_{gas, i}...$	Instantaneous mass of the exhaust component ‘gas’ at time step i, [g/s]; for PN in [#s]
$m_{gas, 3s, k}...$	3 second moving average mass flow of the exhaust gas component ‘gas’ in time step k given in 1 Hz resolution [g/s]; for PN in [#s]
$\bar{m}_{gas, j}$	Average emission value of an exhaust gas component in the wheel power class j, [g/s]; for PN in [#s]
...	

Status: Point in time view as at 01/06/2017.

Changes to legislation: There are outstanding changes not yet made to Commission Regulation (EU) 2017/1151. Any changes that have already been made to the legislation appear in the content and are referenced with annotations. (See end of Document for details)

$\bar{m}_{gas,U}$	Weighted emission value of an exhaust gas component ‘gas’ for the subsample of all seconds i with $v_i < 60$ km/h, [g/s]; for PN in [#s]
...	
$M_{w, gas,d...}$	Weighted distance-specific emissions for the exhaust gas component ‘gas’ for the entire trip, [g/km]; for PN in [#km]
$M_{w, PN,d...}$	Weighted distance-specific emissions for the exhaust gas component ‘PN’ for the entire trip, [#km]
$M_{w,gas,d,U...}$	Weighted distance-specific emissions for the exhaust gas component ‘gas’ for the subsample of all seconds i with $v_i < 60$ km/h, [g/km]
$M_{w,PN,d,U...}$	Weighted distance-specific emissions for the exhaust gas component ‘PN’ for the subsample of all seconds i with $v_i < 60$ km/h, [#km]
$p...$	Phase of WLTC (low, medium, high and extra-high), $p=1-4$
$P_{drag...}$	Engine drag power in the Veline approach where fuel injection is zero, [kW]
$P_{rated...}$	Maximum rated engine power as declared by the manufacturer, [kW]
$P_{required,i...}$	Power to overcome road load and inertia of a vehicle at time step i , [kW]
$P_{r,i...}$	Same as $P_{required,i}$ defined above used in longer equations
$P_{wot}(P_{norm})$	Full load power curve, [kW]
...	
$P_{c,j...}$	Wheel power class limits for class number j , [kW] ($P_{c,j}$, lower bound represents the lower limit $P_{c,j}$, upper bound the upper limit)
$P_{c,norm,j...}$	Wheel power class limits for class j as normalised power value, [-]
$P_{r,i...}$	Power demand at the vehicles wheel hubs to overcome driving resistances in time step i [kW]
$P_{w,3s,k...}$	3 second moving average power demand at the vehicles wheel hubs to overcome driving resistances in in time step k in 1 Hz resolution [kW]
$P_{drive...}$	Power demand at the wheel hubs for a vehicle at reference speed and acceleration [kW]
$P_{norm...}$	Normalised power demand at the wheel hubs [-]
$t_i...$	Total time in step i , [s]
$t_{c,j...}$	Time share of the wheel power class j , [%]
$ts...$	Start time of the WLTC phase p , [s]
$te...$	end time of the WLTC phase p , [s]
$TM...$	Test mass of the vehicle, [kg]; to be specified per section: real test weight in PEMS test, NEDC inertia class weight or WLTP masses (TM_L , TM_H or TM_{ind})
$SPF...$	Standardised Power Frequency distribution
$V_i...$	Actual vehicle speed in time step i , [km/h]
\bar{v}_j	Average vehicle speed in the wheel power class j , km/h
...	
$V_{ref...}$	Reference velocity for P_{drive} , [70 km/h]
$V_{3s,k...}$	3 seconds moving average of the vehicle velocity in time step k , [km/h]
\bar{v}_V	Weighted vehicle speed in the wheel power class j , [km/h]
...	

3. EVALUATION OF THE MEASURED EMISSIONS USING A STANDARDISED WHEEL POWER FREQUENCY DISTRIBUTION

The power binning method uses the instantaneous emissions of the pollutants, $m_{gas, i}$ (g/s) calculated in accordance with Appendix 4.

Status: Point in time view as at 01/06/2017.

Changes to legislation: There are outstanding changes not yet made to Commission Regulation (EU) 2017/1151. Any changes that have already been made to the legislation appear in the content and are referenced with annotations. (See end of Document for details)

The $m_{\text{gas},i}$ values shall be classified in accordance with the corresponding power at the wheels and the classified average emissions per power class shall be weighted to obtain the emission values for a test with a normal power distribution according to the following points.

3.1. Sources for the actual wheel power

The actual wheel power $P_{r,i}$ shall be the total power to overcome air resistance, rolling resistance, road gradients, longitudinal inertia of the vehicle and rotational inertia of the wheels.

When measured and recorded, the wheel power signal shall use a torque signal meeting the linearity requirements laid down in Appendix 2, point 3.2. The reference point for measurement are the wheel hubs of the driven wheels.

As an alternative, the actual wheel power may be determined from the instantaneous CO₂ emissions following the procedure laid down in point 4 of this Appendix.

3.2. Calculation of the moving averages of the instantaneous test data

Three second moving averages shall be calculated from all relevant instantaneous test data to reduce influences of possibly imperfect time alignment between emission mass flow and wheel power. The moving average values shall be computed in a 1 Hz frequency:

$$m_{\text{gas},3s,k} = \frac{\sum_{i=k-2}^{i+k} m_{\text{gas},i}}{3}$$

$$P_{w,3s,k} = \frac{\sum_{i=k-2}^{i+k} P_{w,i}}{3}$$

$$v_{3s,k} = \frac{\sum_{i=k-2}^{i+k} v_i}{3}$$

Where

k... time step for moving average values
i... time step from instantaneous test data

3.3. Classification of the moving averages to urban, rural and motorway

The standard power frequencies are defined for urban driving and for the total trip (see paragraph 3.4) and a separate evaluation of the emissions shall be made for the total trip and for the urban part. For the later evaluation of the urban part of the trip, the three second moving averages calculated according to paragraph 3.2 shall be allocated to urban driving conditions according to the three second moving average of the velocity signal ($v_{3s,k}$) following the speed range defined in Table 1-1. The sample for the total trip evaluation shall cover all speed ranges including also the urban part.

TABLE 1-1

Speed ranges for the allocation of test data to urban, rural and motorway conditions in the power binning method

v_i [km/h]	Urban	Rural ^a	Motorway ^a
	0 to ≤ 60	> 60 to # 90	> 90

^a Not used in the actual regulatory evaluation

3.4. Set up of the wheel power classes for emission classification

3.4.1. The power classes and the corresponding time shares of the power classes in normal driving are defined for normalized power values to be representative for any LDV (Table 1).

Status: Point in time view as at 01/06/2017.

Changes to legislation: There are outstanding changes not yet made to Commission Regulation (EU) 2017/1151. Any changes that have already been made to the legislation appear in the content and are referenced with annotations. (See end of Document for details)

TABLE 1

Normalized standard power frequencies for urban driving and for a weighted average for a total trip consisting of 1/3 urban, 1/3 road, 1/3 motorway mileage

Powerclass No.	P _{c,norm,j} [-]		Urban	Total trip
	From >	to ≤	Time share, t _{c,j}	
1		– 0,1	21,9700 %	18,5611 %
2	– 0,1	0,1	28,7900 %	21,8580 %
3	0,1	1	44,0000 %	43,4582 %
4	1	1,9	4,7400 %	13,2690 %
5	1,9	2,8	0,4500 %	2,3767 %
6	2,8	3,7	0,0450 %	0,4232 %
7	3,7	4,6	0,0040 %	0,0511 %
8	4,6	5,5	0,0004 %	0,0024 %
9	5,5		0,0003 %	0,0003 %

The P_{c,norm} columns in Table 1 shall be de-normalised by multiplication with P_{drive}, where P_{drive} is the actual wheel power of the tested car in the type approval settings at the chassis dynamometer at v_{ref} and a_{ref}.

$$P_{c,j} \text{ [kW]} = P_{c,norm,j} * P_{drive}$$

$$P_{drive} = \frac{v_{ref}}{3,6} \times (f_0 + f_1 \times v_{ref} + f_2 \times v_{ref}^2 + TM_{NEDC} \times a_{ref}) \times 0,001$$

Where:

- *j* is the power class index according to Table 1
- The driving resistance coefficients *f*₀, *f*₁, *f*₂ should be calculated with a least squares regression analysis from the following definition:

$$P_{Corrected} / v = f_0 + f_1 \times v + f_2 \times v^2$$

with (P_{Corrected}/v) being the road load force at vehicle velocity v for the NEDC test cycle defined in point 5.1.1.2.8 of Appendix 7 to Annex 4a of UNECE Regulation 83 - 07 series of amendments.

- TM_{NEDC} is the inertia class of the vehicle in the type approval test, [kg]

3.4.2. *Correction of the wheel power classes*

The maximum wheel power class to be considered is the highest class in Table 1 which includes (P_{rated} × 0.9). The time shares of all excluded classes shall be added to the highest remaining class.

From each P_{c,norm,j} the corresponding P_{c,j} shall be calculated to define the upper and lower bounds in kW per wheel power class for the tested vehicle as shown in Figure 1.

Figure 1

Status: Point in time view as at 01/06/2017.

Changes to legislation: There are outstanding changes not yet made to Commission Regulation (EU) 2017/1151. Any changes that have already been made to the legislation appear in the content and are referenced with annotations. (See end of Document for details)

Schematic picture for converting the normalized standardised power frequency into a vehicle specific power frequency

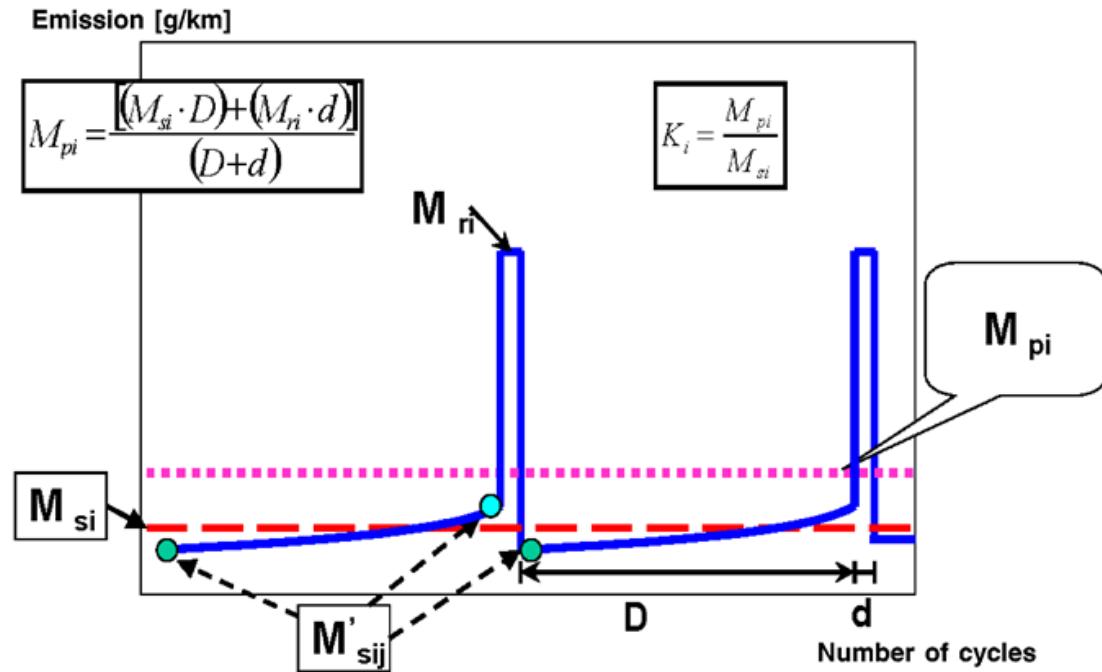

An example for this de-normalisation is given below.

EXAMPLE FOR INPUT DATA

Parameter	Value
f_0 [N]	79,19
f_1 [N/(km/h)]	0,73
f_2 [N/(km/h) ²]	0,03
TM [kg]	1,47
P_{rated} [kW]	120 (Example 1)
P_{rated} [kW]	75 (Example 2)

Corresponding results (see Table 2, Table 3):

$$P_{drive} = 70[\text{km} / \text{h}] / 3,6 \times (79,19 + 0,73[\text{N} / (\text{km} / \text{h})] \times 70[\text{km} / \text{h}] + 0,03[\text{N} / (\text{km} / \text{h})^2] \times (70[\text{km} / \text{h}])^2 + 1470[\text{kg}] \times 0,45[\text{m} / \text{s}^2]) \times 0,001$$

$$P_{drive} = 18,25 \text{ kW}$$

TABLE 2

De-normalised standard power frequency values from Table 1. (for Example 1)

Powerclass No.	$P_{c,j}$ [kW]		Urban	Total trip
	From >	to ≤	Time share, $t_{C,j}$ [%]	

a The highest wheel power class to be considered is the one containing $0,9 \times Prated$. Here $0,9 \times 120 = 108$.

Status: Point in time view as at 01/06/2017.

Changes to legislation: There are outstanding changes not yet made to Commission Regulation (EU) 2017/1151. Any changes that have already been made to the legislation appear in the content and are referenced with annotations. (See end of Document for details)

1	All < -1,825	-1,825	21,97 %	18,5611 %
2	-1,825	1,825	28,79 %	21,8580 %
3	1,825	18,25	44,00 %	43,4583 %
4	18,25	34,675	4,74 %	13,2690 %
5	34,675	51,1	0,45 %	2,3767 %
6	51,1	67,525	0,045 %	0,4232 %
7	67,525	83,95	0,004 %	0,0511 %
8	83,95	100,375	0,0004 %	0,0024 %
9 ^a	100,375	All > 100,375	0,00025 %	0,0003 %

a The highest wheel power class to be considered is the one containing $0,9 \times \text{Prated}$. Here $0,9 \times 120 = 108$.

TABLE 3

De-normalised standard power frequency values from Table 1.(for Example 2)

Powerclass No.	P _{c,j} [kW]		Urban	Total trip
	From >	to ≤	Time share, t _{c,j} [%]	
1	All < -1,825	-1,825	21,97 %	18,5611 %
2	-1,825	1,825	28,79 %	21,8580 %
3	1,825	18,25	44,00 %	43,4583 %
4	18,25	34,675	4,74 %	13,2690 %
5	34,675	51,1	0,45 %	2,3767 %
6 ^a	51,1	All > 51,1	0,04965 %	0,4770 %
7	67,525	83,95	—	—
8	83,95	100,375	—	—
9	100,375	All > 100,375	—	—

a The highest class wheel power class to be considered is the one containing $0,9 \times \text{Prated}$. Here $0,9 \times 75 = 67,5$.

3.5. Classification of the moving average values

The cold start emissions, defined according to Appendix 4, point 4.4, shall be excluded from the following evaluation.

Each moving average value calculated according to point 3.2 shall be sorted into the de-normalized wheel power class into which the actual 3 second moving average wheel power P_{w,3s,k} fits. The de-normalised wheel power class limits have to be calculated according to point 3.3.

The classification shall be done for all three second moving averages of the entire valid trip data including also all urban trip parts. Additionally all moving averages classified to urban according to the velocity limits defined in table 1-1 shall be classified into one set of urban power classes independently of the time when the moving average appeared in the trip.

Status: Point in time view as at 01/06/2017.

Changes to legislation: There are outstanding changes not yet made to Commission Regulation (EU) 2017/1151. Any changes that have already been made to the legislation appear in the content and are referenced with annotations. (See end of Document for details)

Then the average of all three second moving average values within a wheel power class shall be calculated for each wheel power class per parameter. The equations are described below and shall be applied once for the urban data set and once for the total data set.

Classification of the 3-second moving average values into power class j ($j = 1$ to 9):

if $P_{C,j \text{ lower bound}} < P_{w,3,k} \leq P_{C,j \text{ upper bound}}$

then: class index for emissions and velocity = j

The number of 3-second moving average values shall be counted for each power class:

if $P_{C,j \text{ lower bound}} < P_{w,3,k} \leq P_{C,j \text{ upper bound}}$

then: $\text{counts}_j = n + 1$ (counts_j is counting the number of 3 second moving average emission values in a power class to check later the minimum coverage demands)

3.6. Check of power class coverage and of normality of power distribution

For a valid test the time shares of the single wheel power classes shall be in the ranges listed in Table 4.

TABLE 4

Minimum and maximum shares per power class for a valid test

Powerclass No.	$P_{c,norm,j}$ [-]		Total trip		Urban trip parts	
	From >	to ≤	lower bound	upper bound	lower bound	upper bound
Sum 1+2 ^a		0,1	15 %	60 %	5 % ^a	60 %
3	0,1	1	35 %	50 %	28 %	50 %
4	1	1,9	7 %	25 %	0,7 %	25 %
5	1,9	2,8	1,0 %	10 %	> 5 counts	5 %
6	2,8	3,7	> 5 counts	2,5 %	0 %	2 %
7	3,7	4,6	0 %	1,0 %	0 %	1 %
8	4,6	5,5	0 %	0,5 %	0 %	0,5 %
9	5,5		0 %	0,25 %	0 %	0,25 %

^a Representing the total of motoring and low power conditions

In addition to the requirements in Table 4, a minimum coverage of 5 counts is demanded for the total trip in each wheel power class up to the class containing 90 % of the rated power to provide a sufficient sample size.

A minimum coverage of 5 counts is required for the urban part of the trip in each wheel power class up to class No. 5. If the counts in the urban part of the trip in a wheel power class above number 5 are less than 5, the average class emission value shall be set to zero.

3.7. Averaging of the measured values per wheel power class

The moving averages sorted in each wheel power class shall be averaged as follows:

$$\bar{m}_{gas,j} = \frac{\sum_{\text{all } k \text{ in class } j} m_{gas,3,k}}{\text{counts}_j}$$

$$\bar{v}_j = \frac{\sum_{\text{all } k \text{ in class } j} v_{3,k}}{\text{counts}_j}$$

Status: Point in time view as at 01/06/2017.

Changes to legislation: There are outstanding changes not yet made to Commission Regulation (EU) 2017/1151. Any changes that have already been made to the legislation appear in the content and are referenced with annotations. (See end of Document for details)

Where

j ...	wheel power class 1 to 9 according to Table 1
$\bar{m}_{g_{gas,j}}$	average emission value of an exhaust gas component in a wheel power class (separate value for total trip data and for the urban parts of the trip), [g/s]
...	
\bar{v}_j	average velocity in a wheel power class (separate value for total trip data and for the urban parts of the trip), [km/h]
...	
k ...	time step for moving average values

3.8. Weighting of the average values per wheel power class

The average values of each wheel power class shall be multiplied with the time share, $t_{c,j}$ per class according to Table 1 and summed up to produce the weighted average value for each parameter. This value represents the weighted result for a trip with the standardised power frequencies. The weighted averages shall be computed for the urban part of the test data using the time shares for urban power distribution as well as for the total trip using the time shares for the total.

The equations are described below and shall be applied once for the urban data set and once for the total data set.

$$\bar{m}_{gas} = \sum_{j=1}^{j-1} \bar{m}_{gas,j} \times t_{c,j}$$

$$\bar{v} = \sum_{j=1}^9 \bar{v}_j \times t_{c,j}$$

3.9 Calculation of the weighted distance-specific emission value

The time based weighted averages of the emissions in the test shall be converted into distance based emissions once for the urban data set and once for the total data set as follows:

For the total trip : $M_{w,gas,d} = \frac{\bar{m}_{gas} \times 3600}{\bar{v}}$

For the urban part : $M_{w,gas,d,U} = \frac{\bar{m}_{gas,U} \times 3600}{\bar{v}_U}$

of the trip

For particle number the same method as for gaseous pollutants shall be applied but the unit [# / s] shall be used for

\bar{m}_{PN}
 and [# / km] shall be used for $M_{w,PN}$:

For the total trip : $M_{w,PN,d} = \frac{\bar{m}_{PN} \times 3600}{\bar{v}}$

For the urban part : $M_{w,PN,d,U} = \frac{\bar{m}_{PN,U} \times 3600}{\bar{v}_U}$

of the trip

4. ASSESSMENT OF THE WHEEL POWER FROM THE INSTANTANEOUS CO₂ MASS FLOW

The power at the wheels ($P_{w,i}$) can be computed from the measured CO₂ mass flow in 1 Hz. For this calculation the vehicle specific CO₂ line ('Veline') shall be used.

The Veline shall be calculated from the vehicle type approval test in the WLTC according to the test procedure described in UNECE Global Technical Regulation No. 15 - Worldwide harmonized Light vehicles Test Procedure (ECE/TRANS/180/Add.15).

The average wheel power per WLTC phase shall be calculated in 1 Hz from the driven velocity and from the chassis dynamometer settings. For all wheel power values below the drag power shall be set to the drag power value.

Status: Point in time view as at 01/06/2017.

Changes to legislation: There are outstanding changes not yet made to Commission Regulation (EU) 2017/1151. Any changes that have already been made to the legislation appear in the content and are referenced with annotations. (See end of Document for details)

$$P_{w,i} = \frac{v_i}{3,6} \times (f_0 + f_1 \times v_i + f_2 \times v_i^2 + TM \times a_i) \times 0,001$$

With $f_0, f_1, f_2 \dots$ road load coefficients used in in the WLTP test performed with the vehicle

TM... test mass of the vehicle in the WLTP test performed with the vehicle in [kg]

$$P_{drag} = -0,04 \times P_{rated}$$

if $P_{w,i} < P_{drag}$ then $P_{w,i} = P_{drag}$

The average power per WLTC phase is calculated from the 1 Hz wheel power according to:

$$P_{w,p} = \frac{\sum_{t_s}^{t_e} P_{w,i}}{t_e - t_s}$$

With

p	phase of WLTC (low, medium, high and extra-high)
t_s	Start time of the WLTC phase p, [s]
t_e	end time of the WLTC phase p, [s]

Then a linear regression shall be made with the CO₂ mass flow from the bag values of the WLTC on the y-axis and from the average wheel power $P_{w,p}$ per phase on the x-axis as illustrated in Figure 2.

The resulting Veline equation defines the CO₂ mass flow as function of the wheel power:

$$CO_{2,i} = k_{WLTC} \times P_{w,i} + D_{WLTC} \text{ CO}_2 \text{ in [g / h]}$$

Where

k_{WLTC} ... slope of the Veline from WLTC, [g/kWh]

D_{WLTC} ... intercept of the Veline from WLTC, [g/h]

Figure 2

Status: Point in time view as at 01/06/2017.

Changes to legislation: There are outstanding changes not yet made to Commission Regulation (EU) 2017/1151. Any changes that have already been made to the legislation appear in the content and are referenced with annotations. (See end of Document for details)

Schematic picture of setting up the vehicle specific Veline from the CO₂ test results in the 4 phases of the WLTC

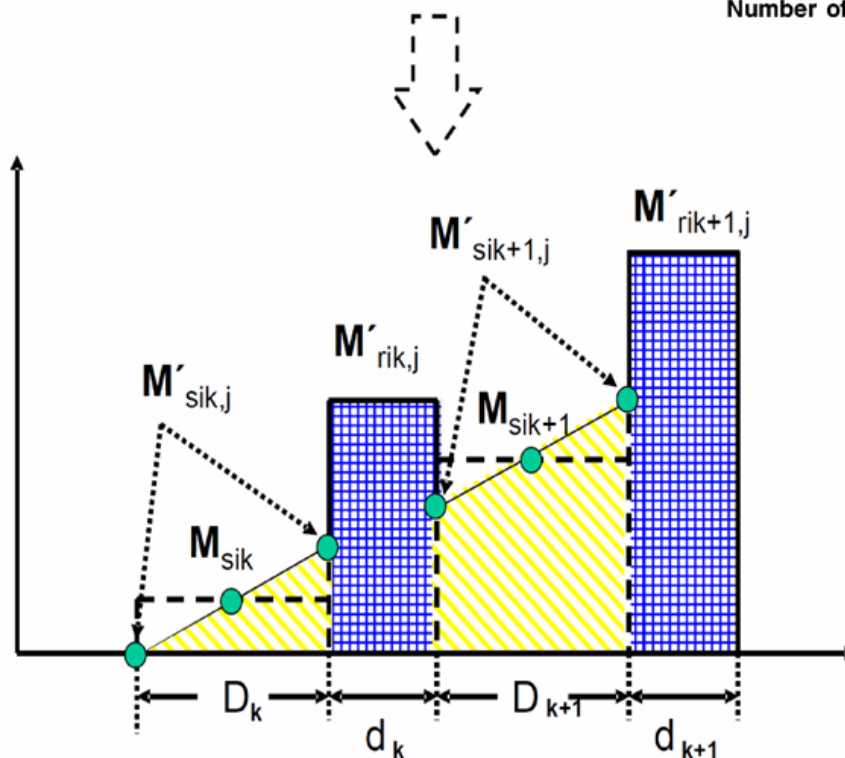
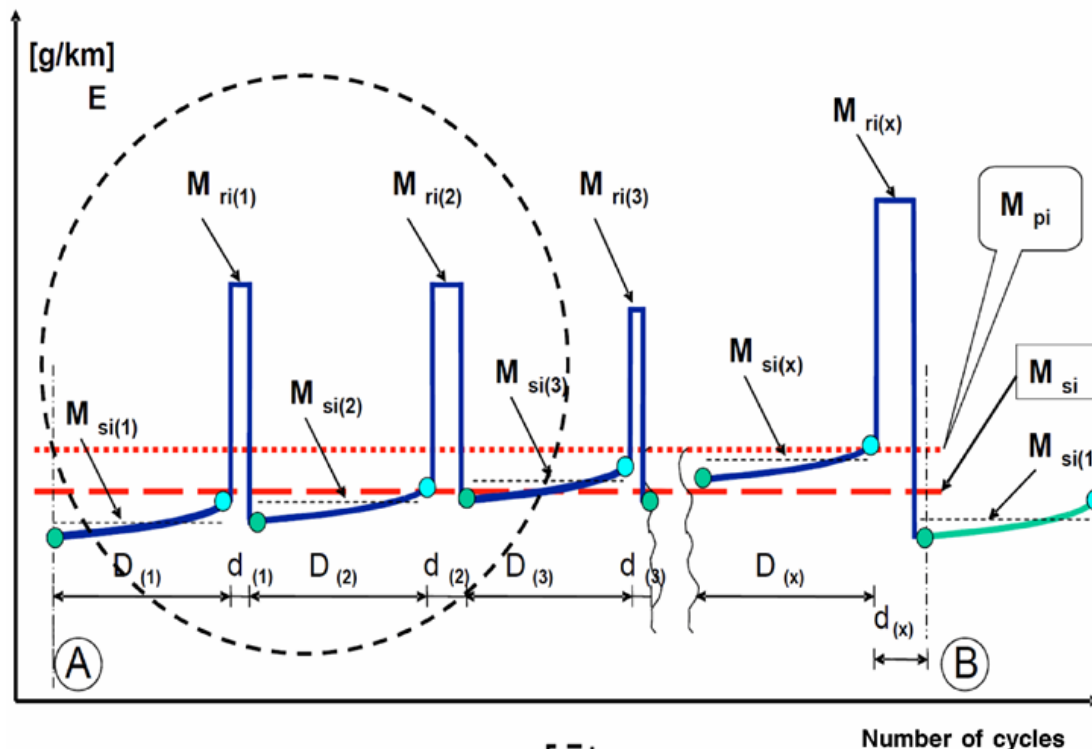

The actual wheel power shall be calculated from the measured CO₂ mass flow according to:

$$P_{w,i} = \frac{CO_{2i} - D_{WLTC}}{k_{WLTC}}$$

Status: Point in time view as at 01/06/2017.

Changes to legislation: There are outstanding changes not yet made to Commission Regulation (EU) 2017/1151. Any changes that have already been made to the legislation appear in the content and are referenced with annotations. (See end of Document for details)

With CO_2 in [g/h]
 P_{Wj} in [kW]

The above equation can be used to provide P_{Wi} for the classification of the measured emissions as described in point 3 with following additional conditions in the calculation

- (I) *if $v_i < 0,5$ and if $a_i < 0$ then $P_{w,i} = 0$* v in [m/s]
 (II) *if $CO_{2i} < 0,5 \times D_{WLTC}$ then $P_{w,i} = P_{drag}$*

In time steps where (I) and (II) are valid, condition (II) shall be applied.

Appendix 7

Selection of vehicles for PEMS testing at initial type approval

1. INTRODUCTION

Due to their particular characteristics, PEMS tests are not required to be performed for each ‘*vehicle type with regard to emissions and vehicle repair and maintenance information*’ as defined in Article 2(1) of this Regulation, which is called in the following ‘*vehicle emission type*’. Several vehicle emission types may be put together by the vehicle manufacturer to form a ‘*PEMS test family*’ according to the requirements of point 3, which shall be validated according to the requirements of point 4.

2. SYMBOLS, PARAMETERS AND UNITS

N	— Number of vehicle emission types
NT	— Minimum number of vehicle emission types
PMR_H	— highest power-to-mass-ratio of all vehicles in the PEMS test family
PMR_L	— lowest power-to-mass-ratio of all vehicles in the PEMS test family
V_{eng_max}	— maximum engine volume of all vehicles within the PEMS test family

3. PEMS TEST FAMILY BUILDING

A PEMS test family shall comprise vehicles with similar emission characteristics. Upon the choice of the manufacturer vehicle emission types may be included in a PEMS test family only if they are identical with respect to the characteristics in points 3.1. and 3.2.

3.1. Administrative criteria

- 3.1.1. The approval authority issuing the emission type approval according to Regulation (EC) No 715/2007 (‘authority’)
 3.1.2. A single vehicle manufacturer.

3.2. Technical criteria

- 3.2.1. Propulsion type (e.g. ICE, HEV, PHEV)
 3.2.2. Type(s) of fuel(s) (e.g. petrol, diesel, LPG, NG, ...). Bi- or flex-fuelled vehicles may be grouped with other vehicles, with which they have one of the fuels in common.
 3.2.3. Combustion process (e.g. two stroke, four stroke)
 3.2.4. Number of cylinders

Status: Point in time view as at 01/06/2017.

Changes to legislation: There are outstanding changes not yet made to Commission Regulation (EU) 2017/1151. Any changes that have already been made to the legislation appear in the content and are referenced with annotations. (See end of Document for details)

3.2.5. Configuration of the cylinder block (e.g. in-line, V, radial, horizontally opposed)

3.2.6. Engine volume

The vehicle manufacturer shall specify a value V_{eng_max} (= maximum engine volume of all vehicles within the PEMS test family). The engine volumes of vehicles in the PEMS test family shall not deviate more than – 22 % from V_{eng_max} if $V_{eng_max} \geq 1\,500$ ccm and – 32 % from V_{eng_max} if $V_{eng_max} < 1\,500$ ccm.

3.2.7. Method of engine fuelling (e.g. indirect or direct or combined injection)

3.2.8. Type of cooling system (e.g. air, water, oil)

3.2.9. Method of aspiration such as naturally aspirated, pressure charged, type of pressure charger (e.g. externally driven, single or multiple turbo, variable geometries ...)

3.2.10. Types and sequence of exhaust after-treatment components (e.g. three-way catalyst, oxidation catalyst, lean NO_x trap, SCR, lean NO_x catalyst, particulate trap).

3.2.11. Exhaust gas recirculation (with or without, internal/external, cooled/non-cooled, low/high pressure)

3.3. **Extension of a PEMS test family**

An existing PEMS test family may be extended by adding new vehicle emission types to it. The extended PEMS test family and its validation must also fulfil the requirements of points 3 and 4. This may in particular require the PEMS testing of additional vehicles to validate the extended PEMS test family according to point 4.

3.4. **Alternative PEMS test family**

As an alternative to the provisions of points 3.1 to 3.2 the vehicle manufacturer may define a PEMS test family, which is identical to a single vehicle emission type. In this the requirement of point 4.1.2 for validating the PEMS test family shall not apply.

4. VALIDATION OF A PEMS TEST FAMILY

4.1. **General requirements for validating a PEMS test family**

4.1.1. The vehicle manufacturer presents a representative vehicle of the PEMS test family to the authority. The vehicle shall be subject to a PEMS test carried out by a Technical Service to demonstrate compliance of the representative vehicle with the requirements of this Annex.

4.1.2. The authority selects additional vehicles according to the requirements of point 4.2 of this Appendix for PEMS testing carried out by a Technical Service to demonstrate compliance of the selected vehicles with the requirements of this Annex. The technical criteria for selection of an additional vehicle according to point 4.2 of this Appendix shall be recorded with the test results.

4.1.3. With agreement of the authority, a PEMS test can also be driven by a different operator witnessed by a Technical Service, provided that at least the tests of the vehicles required by points 4.2.2 and 4.2.6 of this Appendix and in total at least 50 % of the PEMS tests required by this Appendix for validating the PEMS test family are driven by a Technical Service. In such case the Technical Service remains responsible for the proper execution of all PEMS tests pursuant to the requirements of this Annex.

Status: Point in time view as at 01/06/2017.

Changes to legislation: There are outstanding changes not yet made to Commission Regulation (EU) 2017/1151. Any changes that have already been made to the legislation appear in the content and are referenced with annotations. (See end of Document for details)

- 4.1.4. A PEMS test results of a specific vehicle may be used for validating different PEMS test families according to the requirements of this Appendix under the following conditions:
- the vehicles included in all PEMS test families to be validated are approved by a single authority according to the requirements of Regulation (EC) 715/2007 and this authority agrees to the use of the specific vehicle's PEMS test results for validating different PEMS test families;
 - each PEMS test family to be validated includes a vehicle emission type, which comprises the specific vehicle;

For each validation the applicable responsibilities are considered to be borne by the manufacturer of the vehicles in the respective family, regardless of whether this manufacturer was involved in the PEMS test of the specific vehicle emission type.

4.2. Selection of vehicles for PEMS testing when validating a PEMS test family

By selecting vehicles from a PEMS test family it should be ensured that the following technical characteristics relevant for pollutant emissions are covered by a PEMS test. One vehicle selected for testing can be representative for different technical characteristics. For the validation of a PEMS test family vehicles shall be selected for PEMS testing as follows:

- 4.2.1. For each combination of fuels (e.g. petrol-LPG, petrol-NG, petrol only), on which some vehicle of the PEMS test family can operate, at least one vehicle that can operate on this combination of fuels shall be selected for PEMS testing.
- 4.2.2. The manufacturer shall specify a value PMR_H (= highest power-to-mass-ratio of all vehicles in the PEMS test family) and a value PMR_L (= lowest power-to-mass-ratio of all vehicles in the PEMS test family). Here the 'power-to-mass-ratio' corresponds to the ratio of the maximum net power of the internal combustion engine as indicated in point 3.2.1.8 of Appendix 3 to Annex I of this Regulation and of the reference mass as defined in Article 3(3) of Regulation (EC) No 715/2007. At least one vehicle configuration representative for the specified PMR_H and one vehicle configuration representative for the specified PMR_L of a PEMS test family shall be selected for testing. If the power-to-mass ratio of a vehicle deviates by not more than 5 % from the specified value for PMR_H , or PMR_L , the vehicle should be considered as representative for this value.
- 4.2.3. At least one vehicle for each transmission type (e.g., manual, automatic, DCT) installed in vehicles of the PEMS test family shall be selected for testing.
- 4.2.4. At least one four-wheel drive vehicle (4x4 vehicle) shall be selected for testing if such vehicles are part of the PEMS test family.
- 4.2.5. For each engine volume occurring on a vehicle in the PEMS family at least one representative vehicle shall be tested.
- 4.2.6. At least one vehicle for each number of installed exhaust after-treatment components shall be selected for testing.
- 4.2.7. Notwithstanding the provisions in points 4.2.1 to 4.2.6, at least the following number of vehicle emission types of a given PEMS test family shall be selected for testing:

Status: Point in time view as at 01/06/2017.

Changes to legislation: There are outstanding changes not yet made to Commission Regulation (EU) 2017/1151. Any changes that have already been made to the legislation appear in the content and are referenced with annotations. (See end of Document for details)

Number N of vehicle emission types in a PEMS test family	Minimum number NT of vehicle emission types selected for PEMS testing
1	1
from 2 to 4	2
from 5 to 7	3
from 8 to 10	4
from 11 to 49	$NT = 3 + 0,1 \times N^a$
more than 49	$NT = 0,15 \times N^a$

a NT shall be rounded to the next higher integer number.

5. REPORTING

- 5.1. The vehicle manufacturer provides a full description of the PEMS test family, which includes in particular the technical criteria described in point 3.2 and submits it to the authority.
- 5.2. The manufacturer attributes a unique identification number of the format *MS-OEM-X-Y* to the PEMS test family and communicates it to the authority. Here *MS* is the distinguishing number of the Member State issuing the EC type-approval⁽²⁵⁾, *OEM* is the 3 character manufacturer, *X* is a sequential number identifying the original PEMS test family and *Y* is a counter for its extensions (starting with 0 for a PEMS test family not extended yet).
- 5.3. The authority and the vehicle manufacturer shall maintain a list of vehicle emission types being part of a given PEMS test family on the basis of emission type approval numbers. For each emission type all corresponding combinations of vehicle type approval numbers, types, variants and versions as defined in sections 0.10 and 0.2 of the vehicle's EC certificate of conformity shall be provided as well.
- 5.4. The authority and the vehicle manufacturer shall maintain a list of vehicle emission types selected for PEMS testing in order to validate a PEMS test family in accordance with point 4, which also provides the necessary information on how the selection criteria of point 4.2 are covered. This list shall also indicate whether the provisions of point 4.1.3 were applied for a particular PEMS test.

Appendix 7a

Verification of overall trip dynamics

1. INTRODUCTION

This Appendix describes the calculation procedures to verify the overall trip dynamics, to determine the overall excess or absence of dynamics during urban, rural and motorway driving.

2. SYMBOLS, PARAMETERS AND UNITS

RPA Relative Positive Acceleration

Status: Point in time view as at 01/06/2017.

Changes to legislation: There are outstanding changes not yet made to Commission Regulation (EU) 2017/1151. Any changes that have already been made to the legislation appear in the content and are referenced with annotations. (See end of Document for details)

Δ	— difference
$>$	— larger
\geq	— larger or equal
$\%$	— per cent
$<$	— smaller
\leq	— smaller or equal
a	— acceleration [m/s^2]
a_i	— acceleration in time step i [m/s^2]
a_{pos}	— positive acceleration greater than $0,1 \text{ m/s}^2$ [m/s^2]
$a_{pos,i,k}$	— positive acceleration greater than $0,1 \text{ m/s}^2$ in time step i considering the urban, rural and motorway shares [m/s^2]
a_{res}	— acceleration resolution [m/s^2]
d_i	— distance covered in time step i [m]
$d_{i,k}$	— distance covered in time step i considering the urban, rural and motorway shares [m]
Index (i)	— discrete time step
Index (j)	— discrete time step of positive acceleration datasets
Index (k)	— refers to the respective category (t=total, u=urban, r=rural, m=motorway)
M_k	— number of samples for urban, rural and motorway shares with positive acceleration greater than $0,1 \text{ m/s}^2$
N_k	— total number of samples for the urban, rural and motorway shares and the complete trip
RPA_k	— relative positive acceleration for urban, rural and motorway shares [m/s^2 or $\text{kWs}/(\text{kg}\cdot\text{km})$]
t_k	— duration of the urban, rural and motorway shares and the complete trip [s]
T4253H	— compound data smoother
v	— vehicle speed [km/h]
v_i	— actual vehicle speed in time step i [km/h]
$v_{i,k}$	— actual vehicle speed in time step i considering the urban, rural and motorway shares [km/h]
$(v \times a)_i$	— actual vehicle speed per acceleration in time step i [m^2/s^3 or W/kg]
$(v \times a_{pos})_{j,k}$	— actual vehicle speed per positive acceleration greater than $0,1 \text{ m/s}^2$ in time step j considering the urban, rural and motorway shares [m^2/s^3 or W/kg].
$(v \times a_{pos})_{k-95}$	— 95 th percentile of the product of vehicle speed per positive acceleration greater than $0,1 \text{ m/s}^2$ for urban, rural and motorway shares [m^2/s^3 or W/kg]
\bar{v}_k	— average vehicle speed for urban, rural and motorway shares [km/h]

3. TRIP INDICATORS

3.1. Calculations

3.1.1. Data pre-processing

Dynamic parameters like acceleration,

$v \times a_{pos}$

Status: Point in time view as at 01/06/2017.

Changes to legislation: There are outstanding changes not yet made to Commission Regulation (EU) 2017/1151. Any changes that have already been made to the legislation appear in the content and are referenced with annotations. (See end of Document for details)

or RPA shall be determined with a speed signal of an accuracy of 0,1 % for all speed values above 3 km/h and a sampling frequency of 1 Hz. This accuracy requirement is generally fulfilled by signals obtained from a wheel (rotational) speed sensor.

The speed trace shall be checked for faulty or implausible sections. The vehicle speed trace of such sections is characterised by steps, jumps, terraced speed traces or missing values. Short faulty sections shall be corrected, for example by data interpolation or benchmarking against a secondary speed signal. Alternatively, short trips containing faulty sections could be excluded from the subsequent data analysis. In a second step the acceleration values shall be calculated and ranked in ascending order, as to determine the acceleration resolution

$$a_{res} = (\text{minimum acceleration value} > 0)$$

.

If

$$a_{res} \leq 0,01 \text{ m} / \text{s}^2$$

, the vehicle speed measurement is sufficiently accurate.

If

$$0,01 \text{ m} / \text{s}^2 < a_{res}$$

, data smoothing by using a T4253H Hanning filter shall be performed

The T4235 Hanning filter performs the following calculations: The smoother starts with a running median of 4, which is centred by a running median of 2. The filter then re-smoothes these values by applying a running median of 5, a running median of 3, and hanning (running weighted averages). Residuals are computed by subtracting the smoothed series from the original series. This whole process is then repeated on the computed residuals. Finally, the smoothed final speed values are computed by summing up the smoothed values obtained the first time through the process with the computed residuals.

The correct speed trace builds the basis for further calculations and binning as described in paragraph 8.1.2.

3.1.1.2. Calculation of distance, acceleration and

$$v \times a$$

The following calculations shall be performed over the whole time based speed trace (1 Hz resolution) from second 1 to second t_t (last second).

The distance increment per data sample shall be calculated as follows:

$$d_i = \frac{v_i}{3}, i = 1 \text{ to } N_t$$

where:

d_i is the distance covered in time step i [m]
 v_i is the actual vehicle speed in time step i [km/h]
 N_t is the total number of samples

The acceleration shall be calculated as follows:

$$a_i = (v_{i+1} - v_{i-1}) / (2 \times 3,6), i = 1 \text{ to } N_t$$

where:

a_i is the acceleration in time step i [m/s^2]. For $i = 1$:
 $v_{i-1} = 0$
 , for
 $i = N_t$

Status: Point in time view as at 01/06/2017.

Changes to legislation: There are outstanding changes not yet made to Commission Regulation (EU) 2017/1151. Any changes that have already been made to the legislation appear in the content and are referenced with annotations. (See end of Document for details)

$$\begin{aligned} & \vdots \\ & v_{i+1} = 0 \\ & \vdots \end{aligned}$$

The product of vehicle speed per acceleration shall be calculated as follows:

$$(v \times a)_i = v_i \times a_i / 3,6, i = 1 \text{ to } N_t$$

where:

$(v \times a)_i$ is the product of the actual vehicle speed per acceleration in time step i [m^2/s^3 or W/kg].

3.1.3. Binning of the results

After the calculation of a_i and

$$(v \times a)_i$$

, the values v_i , d_i , a_i and

$$(v \times a)_i$$

shall be ranked in ascending order of the vehicle speed.

All datasets with

$$v_i \leq 60 \text{ km} / \text{h}$$

belong to the ‘urban’ speed bin, all datasets with

$$60 \text{ km} / \text{h} < v_i \leq 90 \text{ km} / \text{h}$$

belong to the ‘rural’ speed bin and all datasets with

$$v_i > 90 \text{ km} / \text{h}$$

belong to the ‘motorway’ speed bin.

The number of datasets with acceleration values

$$a_i > 0,1 \text{ m} / \text{s}^2$$

shall be bigger or equal to 150 in each speed bin.

For each speed bin the average vehicle speed

$$\bar{v}_k$$

shall be calculated as follows:

$$\bar{v}_k = (\sum_i v_{i,k}) / N_k, i = 1 \text{ to } N_k, k = \text{u,r,m}$$

where:

N_k is the total number of samples of the urban, rural, and motorway shares.

3.1.4. Calculation of

$$v \times a_{\text{pos-[95]}}$$

per speed bin

The 95th percentile of the

$$v \times a_{\text{pos}}$$

values shall be calculated as follows:

The

$$(v \times a)_{i,k}$$

values in each speed bin shall be ranked in ascending order for all datasets with

$$a_{i,k} > 0,1 \text{ m} / \text{s}^2$$

$$a_{i,k} \geq 0,1 \text{ m} / \text{s}^2$$

Status: Point in time view as at 01/06/2017.

Changes to legislation: There are outstanding changes not yet made to Commission Regulation (EU) 2017/1151. Any changes that have already been made to the legislation appear in the content and are referenced with annotations. (See end of Document for details)

and the total number of these samples M_k shall be determined.

Percentile values are then assigned to the

$$(v \times a_{\text{pos}})_{i,k}$$

values with

$$a_{i,k} \geq 0,1 \text{ m} / \text{s}^2$$

as follows:

The lowest

$$v \times a_{\text{pos}}$$

value gets the percentile $1/M_k$, the second lowest $2/M_k$, the third lowest $3/M_k$ and the highest value

$$M_k / M_k = 100 \%$$

$$(v \times a_{\text{pos}})_{k- [95]}$$

is the

$$(v \times a_{\text{pos}})_{j,k}$$

value, with

$$j / M_k = 95 \%$$

If

$$j / M_k = 95 \%$$

cannot be met,

$$(v \times a_{\text{pos}})_{k- [95]}$$

shall be calculated by linear interpolation between consecutive samples j and $j+1$ with

$$j / M_k < 95 \%$$

and

$$(j + 1) / M_k > 95 \%$$

The relative positive acceleration per speed bin shall be calculated as follows:

$$RPA_k = \sum_j (\Delta t \times (v \times a_{\text{pos}})_{j,k}) / \sum_i d_{i,k}, j = 1 \text{ to } M_k, i = 1 \text{ to } N_k, k = u, r, m$$

where:

RPA_k is the relative positive acceleration for urban, rural and motorway shares in $[\text{m}/\text{s}^2 \text{ or } \text{kWs}/(\text{kg} \cdot \text{km})]$

Δt is a time difference equal to 1 second

M_k is the sample number for urban, rural and motorway shares with positive acceleration

N_k is the total sample number for urban, rural and motorway shares

4. VERIFICATION OF TRIP VALIDITY

4.1.1. Verification of

$$v \times a_{\text{pos}} - [95]$$

per speed bin (with v in $[\text{km}/\text{h}]$)

If

$$\bar{v}_k \leq 74,6 \text{ km} / \text{h}$$

and

$$(v \times a_{\text{pos}})_{k- [95]} > (0,136 \times \bar{v}_k + 14,44)$$

Status: Point in time view as at 01/06/2017.

Changes to legislation: There are outstanding changes not yet made to Commission Regulation (EU) 2017/1151. Any changes that have already been made to the legislation appear in the content and are referenced with annotations. (See end of Document for details)

is fulfilled, the trip is invalid.

If

$$\bar{v}_k > 74,6 \text{ km / h}$$

and

$$(v \times a_{\text{pos}})_k - [95] > (0,0742 \times \bar{v}_k + 18,966)$$

is fulfilled, the trip is invalid.

4.1.2. Verification of RPA per speed bin

If

$$\bar{v}_k \leq 94,05 \text{ km / h}$$

and

$$\text{RPA}_k < (-0,0016 \times \bar{v}_k + 0,1755)$$

is fulfilled, the trip is invalid.

If

$$\bar{v}_k > 94,05 \text{ km / h}$$

and

$$\text{RPA}_k < (-0,025)$$

is fulfilled, the trip is invalid.

Appendix 7b

Procedure to determine the cumulative positive elevation gain of a PEMS trip

1. INTRODUCTION

This Appendix describes the procedure to determine the cumulative elevation gain of a PEMS trip.

2. SYMBOLS, PARAMETERS AND UNITS

$d(0)$	— distance at the start of a trip [m]
d	— cumulative distance travelled at the discrete way point under consideration [m]
d_0	— cumulative distance travelled until the measurement directly before the respective way point d [m]
d_1	— cumulative distance travelled until the measurement directly after the respective way point d [m]
d_a	— reference way point at $d(0)$ [m]
d_e	— cumulative distance travelled until the last discrete way point [m]
d_i	— instantaneous distance [m]
d_{tot}	— total test distance [m]
$h(0)$	— vehicle altitude after the screening and principle verification of data quality at the start of a trip [m above sea level]
$h(t)$	— vehicle altitude after the screening and principle verification of data quality at point t [m above sea level]
$h(d)$	— vehicle altitude at the way point d [m above sea level]
$h(t-1)$	— vehicle altitude after the screening and principle verification of data quality at point $t-1$ [m above sea level]
$h_{\text{corr}}(0)$	— corrected altitude directly before the respective way point d [m above sea level]

Status: Point in time view as at 01/06/2017.

Changes to legislation: There are outstanding changes not yet made to Commission Regulation (EU) 2017/1151. Any changes that have already been made to the legislation appear in the content and are referenced with annotations. (See end of Document for details)

$h_{corr}(l)$	— corrected altitude directly after the respective way point d [m above sea level]
$h_{corr}(t)$	— corrected instantaneous vehicle altitude at data point t [m above sea level]
$h_{corr}(t-1)$	— corrected instantaneous vehicle altitude at data point $t-1$ [m above sea level]
$h_{GPS,i}$	— instantaneous vehicle altitude measured with GPS [m above sea level]
$h_{GPS}(t)$	— vehicle altitude measured with GPS at data point t [m above sea level]
$h_{int}(d)$	— interpolated altitude at the discrete way point under consideration d [m above sea level]
$h_{int,sm,1}(d)$	— smoothed and interpolated altitude, after the first smoothing run at the discrete way point under consideration d [m above sea level]
$h_{map}(t)$	— vehicle altitude based on topographic map at data point t [m above sea level]
Hz	— hertz
km/h	— kilometer per hour
m	— meter
$road_{grade,1}(d)$	— smoothed road grade at the discrete way point under consideration d after the first smoothing run [m/m]
$road_{grade,2}(d)$	— smoothed road grade at the discrete way point under consideration d after the second smoothing run [m/m]
\sin	— trigonometric sine function
t	— time passed since test start [s]
t_0	— time passed at the measurement directly located before the respective way point d [s]
v_i	— instantaneous vehicle speed [km/h]
$v(t)$	— vehicle speed at a data point t [km/h]

3. GENERAL REQUIREMENTS

The cumulative positive elevation gain of a RDE trip shall be determined based on three parameters: the instantaneous vehicle altitude $h_{GPS,i}$ [m above sea level] as measured with the GPS, the instantaneous vehicle speed v_i [km/h] recorded at a frequency of 1 Hz and the corresponding time t [s] that has passed since test start.

4. CALCULATION OF CUMULATIVE POSITIVE ELEVATION GAIN

4.1. General

The cumulative positive elevation gain of a RDE trip shall be calculated as a three-step procedure, consisting of (i) the screening and principle verification of data quality, (ii) the correction of instantaneous vehicle altitude data, and (iii) the calculation of the cumulative positive elevation gain.

4.2. Screening and principle verification of data quality

The instantaneous vehicle speed data shall be checked for completeness. Correcting for missing data is permitted if gaps remain within the requirements specified in Point 7 of Appendix 4; else, the test results shall be voided. The instantaneous altitude data shall be checked for completeness. Data gaps shall be completed by data interpolation. The correctness of interpolated data shall be verified by a topographic map. It is recommended to correct interpolated data if the following condition applies:

$$|h_{GPS}(t) - h_{map}(t)| > 40\text{m}$$

The altitude correction shall be applied so that:

Status: Point in time view as at 01/06/2017.

Changes to legislation: There are outstanding changes not yet made to Commission Regulation (EU) 2017/1151. Any changes that have already been made to the legislation appear in the content and are referenced with annotations. (See end of Document for details)

$$h(t) = h_{\text{map}}(t)$$

where:

- $h(t)$ — vehicle altitude after the screening and principle verification of data quality at data point t [m above sea level]
- $h_{\text{GPS}}(t)$ — vehicle altitude measured with GPS at data point t [m above sea level]
- $h_{\text{map}}(t)$ — vehicle altitude based on topographic map at data point t [m above sea level]

4.3. Correction of instantaneous vehicle altitude data

The altitude $h(0)$ at the start of a trip at $d(0)$ shall be obtained by GPS and verified for correctness with information from a topographic map. The deviation shall not be larger than 40 m. Any instantaneous altitude data $h(t)$ shall be corrected if the following condition applies:

$$|h(t) - h(t-1)| > (v(t) / 3,6 \times \sin 45^\circ)$$

The altitude correction shall be applied so that:

$$h_{\text{corr}}(t) = h_{\text{corr}}(t-1)$$

where:

- $h(t)$ — vehicle altitude after the screening and principle verification of data quality at data point t [m above sea level]
- $h(t-1)$ — vehicle altitude after the screening and principle verification of data quality at data point $t-1$ [m above sea level]
- $v(t)$ — vehicle speed of data point t [km/h]
- $h_{\text{corr}}(t)$ — corrected instantaneous vehicle altitude at data point t [m above sea level]
- $h_{\text{corr}}(t-1)$ — corrected instantaneous vehicle altitude at data point $t-1$ [m above sea level]

Upon the completion of the correction procedure, a valid set of altitude data is established. This data set shall be used for the calculation of the cumulative positive elevation gain as described in Point 13.4.

4.4. Final calculation of the cumulative positive elevation gain

4.4.1. Establishment of a uniform spatial resolution

The total distance d_{tot} [m] covered by a trip shall be determined as sum of the instantaneous distances d_i . The instantaneous distance d_i shall be determined as:

$$d_i = \frac{v_i}{3,6}$$

Where:

- d_i — instantaneous distance [m]
- v_i — instantaneous vehicle speed [km/h]

The cumulative elevation gain shall be calculated from data of a constant spatial resolution of 1 m starting with the first measurement at the start of a trip $d(0)$. The discrete data points at a resolution of 1 m are referred to as way points, characterized by a specific distance value d (e.g., 0, 1, 2, 3 m...) and their corresponding altitude $h(d)$ [m above sea level].

The altitude of each discrete way point d shall be calculated through interpolation of the instantaneous altitude $h_{\text{corr}}(t)$ as:

Status: Point in time view as at 01/06/2017.

Changes to legislation: There are outstanding changes not yet made to Commission Regulation (EU) 2017/1151. Any changes that have already been made to the legislation appear in the content and are referenced with annotations. (See end of Document for details)

$$h_{\text{int}}(d) = h_{\text{corr}}(0) + \frac{h_{\text{corr}}(1) - h_{\text{corr}}(0)}{d_1 - d_0} \times (d - d_0)$$

Where:

- $h_{\text{int}}(d)$ — interpolated altitude at the discrete way point under consideration d [m above sea level]
- $h_{\text{corr}}(0)$ — corrected altitude directly before the respective way point d [m above sea level]
- $h_{\text{corr}}(1)$ — corrected altitude directly after the respective way point d [m above sea level]
- d — cumulative distance traveled until the discrete way point under consideration d [m]
- d_0 — cumulative distance travelled until the measurement located directly before the respective way point d [m]
- d_1 — cumulative distance travelled until the measurement located directly after the respective way point d [m]

4.4.2. Additional data smoothing

The altitude data obtained for each discrete way point shall be smoothed by applying a two-step procedure; d_a and d_e denote the first and last data point respectively (Figure 1). The first smoothing run shall be applied as follows:

$$\text{road}_{\text{grade},1}(d) = \frac{h_{\text{int}}(d+200\text{m}) - h_{\text{int}}(d_a)}{(d+200\text{m}) - d_a} \text{ for } d \leq 200\text{m}$$

$$\text{road}_{\text{grade},1}(d) = \frac{h_{\text{int}}(d+200\text{m}) - h_{\text{int}}(d-200\text{m})}{(d+200\text{m}) - (d-200\text{m})} \text{ for } 200\text{m} < d < (d_e - 200\text{m})$$

$$\text{road}_{\text{grade},1}(d) = \frac{h_{\text{int}}(d_e) - h_{\text{int}}(d-200\text{m})}{d_e - (d-200\text{m})} \text{ for } d \geq (d_e - 200\text{m})$$

$$h_{\text{int},\text{sm},1}(d) = h_{\text{int},\text{sm},1}(d - 1\text{m}) + \text{road}_{\text{grade},1}(d), \quad d = d_a + 1 \text{ to } d_e$$

$$h_{\text{int},\text{sm},1}(d_a) = h_{\text{int}}(d_a) + \text{road}_{\text{grade},1}(d_a)$$

Where:

- $\text{road}_{\text{grade},1}(d)$ — smoothed road grade at the discrete way point under consideration after the first smoothing run [m/m]
- $h_{\text{int}}(d)$ — interpolated altitude at the discrete way point under consideration d [m above sea level]
- $h_{\text{int},\text{sm},1}(d)$ — smoothed interpolated altitude, after the first smoothing run at the discrete way point under consideration d [m above sea level]
- d — cumulative distance travelled at the discrete way point under consideration [m]
- d_a — reference way point at a distance of zero meters [m]
- d_e — cumulative distance travelled until the last discrete way point [m]

The second smoothing run shall be applied as follows:

$$\text{road}_{\text{grade},2}(d) = \frac{h_{\text{int},\text{sm},1}(d+200\text{m}) - h_{\text{int},\text{sm},1}(d_a)}{(d+200\text{m}) - d_a} \text{ for } d \leq 200\text{m}$$

$$\text{road}_{\text{grade},2}(d) = \frac{h_{\text{int},\text{sm},1}(d+200\text{m}) - h_{\text{int},\text{sm},1}(d-200\text{m})}{(d+200\text{m}) - (d-200\text{m})} \text{ for } 200\text{m} < d < (d_e - 200\text{m})$$

$$\text{road}_{\text{grade},2}(d) = \frac{h_{\text{int},\text{sm},1}(d_e) - h_{\text{int},\text{sm},1}(d-200\text{m})}{d_e - (d-200\text{m})} \text{ for } d \geq (d_e - 200\text{m})$$

Where:

- $\text{road}_{\text{grade},2}(d)$ — smoothed road grade at the discrete way point under consideration after the second smoothing run [m/m]

Status: Point in time view as at 01/06/2017.

Changes to legislation: There are outstanding changes not yet made to Commission Regulation (EU) 2017/1151. Any changes that have already been made to the legislation appear in the content and are referenced with annotations. (See end of Document for details)

- $h_{\text{int,sm},1}(d)$ — smoothed interpolated altitude, after the first smoothing run at the discrete way point under consideration d [m above sea level]
- d — cumulative distance travelled at the discrete way point under consideration [m]
- d_a — reference way point at a distance of zero meters [m]
- d_e — cumulative distance travelled until the last discrete way point [m]

Figure 1

Illustration of the procedure to smooth the interpolated altitude signals

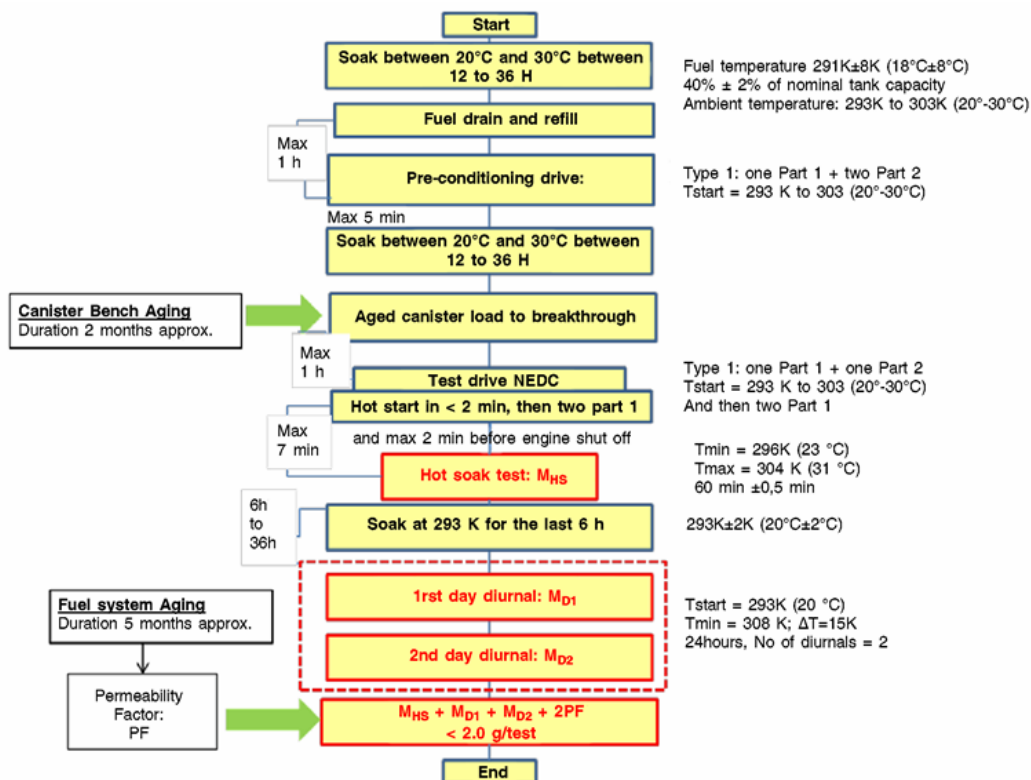

4.4.3. Calculation of the final result

The positive cumulative elevation gain of a trip shall be calculated by integrating all positive interpolated and smoothed road grades, i.e. $road_{\text{grade},2}(d)$. The result should be normalized by the total test distance d_{tot} and expressed in meters of cumulative elevation gain per one hundred kilometers of distance.

5. NUMERICAL EXAMPLE

Tables 1 and 2 show how to calculate the positive elevation gain on the basis of data recorded during an on-road test performed with PEMS. For the sake of brevity an extract of 800m and 160s is presented here.

5.1. Screening and principle verification of data quality

The screening and principle verification of data quality consists of two steps. First, the completeness of vehicle speed data is checked. No data gaps related to vehicle speed are detected in the present data sample (see Table 1). Second, the altitude data are checked for completeness; in the data sample, altitude data related to seconds 2 and 3 are missing. The gaps are filled by

Status: Point in time view as at 01/06/2017.

Changes to legislation: There are outstanding changes not yet made to Commission Regulation (EU) 2017/1151. Any changes that have already been made to the legislation appear in the content and are referenced with annotations. (See end of Document for details)

interpolating the GPS signal. In addition, the GPS altitude is verified by a topographic map; this verification includes the altitude $h(0)$ at the start of the trip. Altitude data related to seconds 112-114 are corrected on the basis of the topographic map to satisfy the following condition:

$$h_{\text{GPS}}(t) - h_{\text{map}}(t) < -40\text{m}$$

As result of the applied data verification, the data in the fifth column $h(t)$ are obtained.

5.2. Correction of instantaneous vehicle altitude data

As a next step, the altitude data $h(t)$ of seconds 1 to 4, 111 to 112 and 159 to 160 are corrected assuming the altitude values of seconds 0, 110 and 158 respectively since for the altitude data in these time periods the following condition applies:

$$|h(t) - h(t-1)| > (v(t)/3,6 \times \sin 45^\circ)$$

As result of the applied data correction, the data in the sixth column $h_{\text{corr}}(t)$ are obtained. The effect of the applied verification and correction steps on the altitude data is depicted in Figure 2.

5.3. Calculation of the cumulative positive elevation gain

5.3.1. Establishment of a uniform spatial resolution

The instantaneous distance d_i is calculated by dividing the instantaneous vehicle speed measured in km/h by 3.6 (Column 7 in Table 1). Recalculating the altitude data to obtain a uniform spatial resolution of 1 m yields the discrete way points d (Column 1 in Table 2) and their corresponding altitude values $h_{\text{int}}(d)$ (Column 7 in Table 2). The altitude of each discrete way point d is calculated through interpolation of the measured instantaneous altitude h_{corr} as:

$$h_{\text{int}}(0) = 120,3 + \frac{120,3 - 120,3}{0,1 - 0,0} \times (0 - 0) = 120,3000$$

$$h_{\text{int}}(520) = 132,5 + \frac{132,5 - 132,5}{523,5 - 519,9} \times (520 - 519,9) = 132,5027$$

5.3.2. Additional data smoothing

In Table 2, the first and last discrete way points are: $d_a=0\text{m}$ and $d_e=799\text{m}$, respectively. The altitude data of each discrete way point is smoothed by applying a two steps procedure. The first smoothing run consists of:

$$\text{road}_{\text{grade},1}(0) = \frac{h_{\text{int}}(200\text{m}) - h_{\text{int}}(0)}{(0+200\text{m})} = \frac{120,9682 - 120,3000}{200} = 0,0033$$

chosen to demonstrate the smoothing for $d \leq 200\text{m}$

$$\text{road}_{\text{grade},1}(320) = \frac{h_{\text{int}}(520) - h_{\text{int}}(120)}{(520) - (120)} = \frac{132,5027 - 121,0}{400} = 0,0288$$

chosen to demonstrate the smoothing for $200\text{m} < d < (599\text{m})$

$$\text{road}_{\text{grade},1}(720) = \frac{h_{\text{int}}(799) - h_{\text{int}}(520)}{799 - (520)} = \frac{121,2000 - 132,5027}{279} = -0,0405$$

chosen to demonstrate the smoothing for $d \geq (599\text{m})$

The smoothed and interpolated altitude is calculated as:

$$h_{\text{int},\text{sm},1}(0) = h_{\text{int}}(0) + \text{road}_{\text{grade},1}(0) = 120,3 + 0,0033 \approx 120,3033\text{m}$$

$$h_{\text{int},\text{sm},1}(799) = h_{\text{int},\text{sm},1}(798) + \text{road}_{\text{grade},1}(799) = 121,2550 - 0,0220 = 121,2330\text{m}$$

Second smoothing run:

$$\text{road}_{\text{grade},2}(0) = \frac{h_{\text{int},\text{sm},1}(200) - h_{\text{int},\text{sm},1}(0)}{(200)} = \frac{119,9618 - 120,3033}{(200)} = -0,0017$$

chosen to demonstrate the smoothing for $d \leq 200\text{m}$

Status: Point in time view as at 01/06/2017.

Changes to legislation: There are outstanding changes not yet made to Commission Regulation (EU) 2017/1151. Any changes that have already been made to the legislation appear in the content and are referenced with annotations. (See end of Document for details)

$$\text{road}_{\text{grade},2}(320) = \frac{h_{\text{int,asm},1}(520) - h_{\text{int,asm},1}(120)}{(520) - (120)} = \frac{123,6809 - 120,1843}{400} = 0,0087$$

chosen to demonstrate the smoothing for $200\text{m} < d < (599)$

$$\text{road}_{\text{grade},2}(720) = \frac{h_{\text{int,asm},1}(799) - h_{\text{int,asm},1}(520)}{799 - (520)} = \frac{121,2330 - 123,6809}{279} = -0,0088$$

chosen to demonstrate the smoothing for $d \geq (599\text{m})$

5.3.3. Calculation of the final result

The positive cumulative elevation gain of a trip is calculated by integrating all positive interpolated and smoothed road grades, i.e. values in the column $\text{road}_{\text{grade},2}(d)$ in Table 2. For the entire data set the total covered distance was

$$d_{\text{tot}} = 139,7 \text{ km}$$

and all positive interpolated and smoothed road grades were of 516m. Therefore the positive cumulative elevation gain reached $516 * 100 / 139,7 = 370\text{m}/100\text{km}$.

TABLE 1

Correction of instantaneous vehicle altitude data

Timet [s]	$v(t)$ [km/h]	$h_{\text{GPS}}(t)$ [m]	$h_{\text{map}}(t)$ [m]	$h(t)$ [m]	$h_{\text{corr}}(t)$ [m]	d_i [m]	Cum. d [m]
0	0,00	122,7	129,0	122,7	122,7	0,0	0,0
1	0,00	122,8	129,0	122,8	122,7	0,0	0,0
2	0,00	—	129,1	123,6	122,7	0,0	0,0
3	0,00	—	129,2	124,3	122,7	0,0	0,0
4	0,00	125,1	129,0	125,1	122,7	0,0	0,0
...
18	0,00	120,2	129,4	120,2	120,2	0,0	0,0
19	0,32	120,2	129,4	120,2	120,2	0,1	0,1
...
37	24,31	120,9	132,7	120,9	120,9	6,8	117,9
38	28,18	121,2	133,0	121,2	121,2	7,8	125,7
...
46	13,52	121,4	131,9	121,4	121,4	3,8	193,4
47	38,48	120,7	131,5	120,7	120,7	10,7	204,1
...
56	42,67	119,8	125,2	119,8	119,8	11,9	308,4
57	41,70	119,7	124,8	119,7	119,7	11,6	320,0
...

— denotes data gaps

Status: Point in time view as at 01/06/2017.

Changes to legislation: There are outstanding changes not yet made to Commission Regulation (EU) 2017/1151. Any changes that have already been made to the legislation appear in the content and are referenced with annotations. (See end of Document for details)

110	10,95	125,2	132,2	125,2	125,2	3,0	509,0
111	11,75	100,8	132,3	100,8	125,2	3,3	512,2
112	13,52	0,0	132,4	132,4	125,2	3,8	516,0
113	14,01	0,0	132,5	132,5	132,5	3,9	519,9
114	13,36	24,30	132,6	132,6	132,6	3,7	523,6
...	
149	39,93	123,6	129,6	123,6	123,6	11,1	719,2
150	39,61	123,4	129,5	123,4	123,4	11,0	730,2
...	
157	14,81	121,3	126,1	121,3	121,3	4,1	792,1
158	14,19	121,2	126,2	121,2	121,2	3,9	796,1
159	10,00	128,5	126,1	128,5	121,2	2,8	798,8
160	4,10	130,6	126,0	130,6	121,2	1,2	800,0

— denotes data gaps

TABLE 2

Calculation of road grade

d[m]	t ₀ [s]	d ₀ [m]	d ₁ [m]	h ₀ [m]	h ₁ [m]	h _{int} (d) [m]	load _{grade,1} (d) [m/m]	h _{int} (d) [m]	load _{grade,2} (d) [m/m]
0	18	0,0	0,1	120,3	120,4	120,3	0,0035	120,3	- 0,0015
...
120	37	117,9	125,7	120,9	121,2	121,0	- 0,0019	120,2	0,0035
...
200	46	193,4	204,1	121,4	120,7	121,0	- 0,0040	120,0	0,0051
...
320	56	308,4	320,0	119,8	119,7	119,7	0,0288	121,4	0,0088
...
520	113	519,9	523,6	132,5	132,6	132,5	0,0097	123,7	0,0037
...
720	149	719,2	730,2	123,6	123,4	123,6	- 0,0405	122,9	- 0,0086
...
798	158	796,1	798,8	121,2	121,2	121,2	- 0,0219	121,3	- 0,0151
799	159	798,8	800,0	121,2	121,2	121,2	- 0,0220	121,3	- 0,0152

Figure 2

Status: Point in time view as at 01/06/2017.

Changes to legislation: There are outstanding changes not yet made to Commission Regulation (EU) 2017/1151. Any changes that have already been made to the legislation appear in the content and are referenced with annotations. (See end of Document for details)

The effect of data verification and correction - The altitude profile measured by GPS $h_{GPS}(t)$, the altitude profile provided by the topographic map $h_{map}(t)$, the altitude profile

Status: Point in time view as at 01/06/2017.

Changes to legislation: There are outstanding changes not yet made to Commission Regulation (EU) 2017/1151. Any changes that have already been made to the legislation appear in the content and are referenced with annotations. (See end of Document for details)

obtained after the screening and principle verification of data quality $h(t)$ and the correction $h_{corr}(t)$ of data listed in Table 1

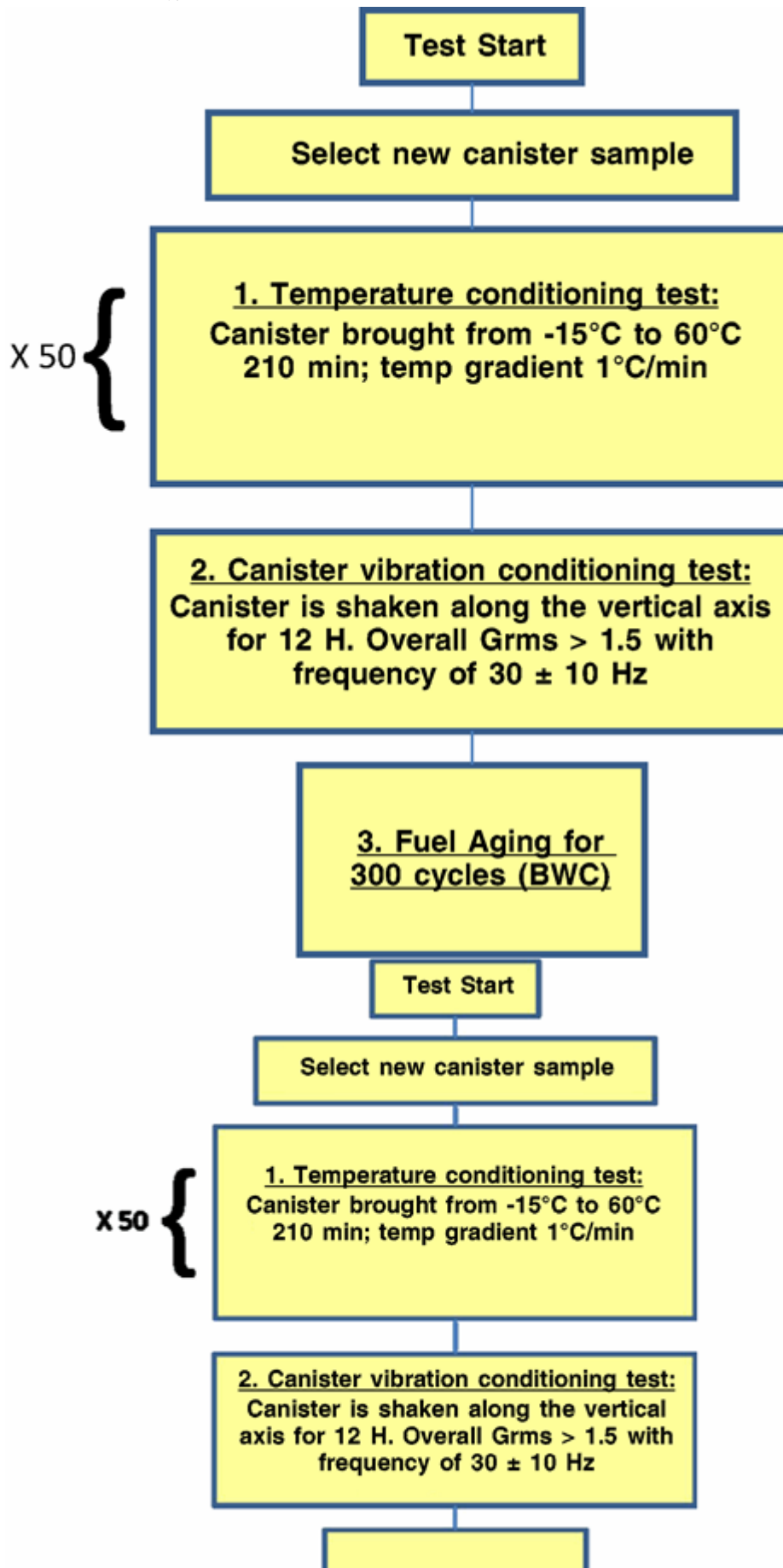

Status: Point in time view as at 01/06/2017.

Changes to legislation: There are outstanding changes not yet made to Commission Regulation (EU) 2017/1151. Any changes that have already been made to the legislation appear in the content and are referenced with annotations. (See end of Document for details)

Figure 3

Comparison between the corrected altitude profile $h_{corr}(t)$ and the smoothed and interpolated altitude $h_{int,sm,1}$

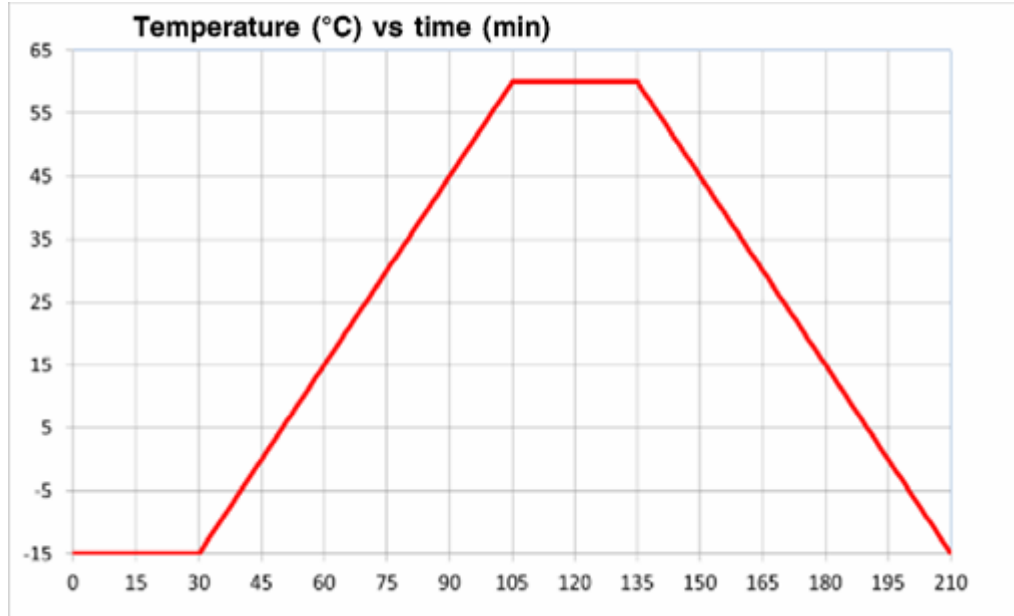

TABLE 3

Calculation of the positive elevation gain

$d[m]$	$t_0 [s]$	$d_0 [m]$	$d_1 [m]$	$h_0 [m]$	$h_1 [m]$	$h_{int}(d) [m]$	$\Delta h_{grade,1}(d) [m]$	$\Delta h_{grade,2}(d) [m]$
0	18	0,0	0,1	120,3	120,4	120,3	0,0035	-0,0015
...
120	37	117,9	125,7	120,9	121,2	121,0	-0,0019	0,0035
...
200	46	193,4	204,1	121,4	120,7	121,0	-0,0040	0,0051
...
320	56	308,4	320,0	119,8	119,7	119,7	0,0288	0,0088
...
520	113	519,9	523,6	132,5	132,6	132,5	0,0097	0,0037
...
720	149	719,2	730,2	123,6	123,4	123,6	-0,0405	-0,0086
...
798	158	796,1	798,8	121,2	121,2	121,2	-0,0219	-0,0151

Status: Point in time view as at 01/06/2017.

Changes to legislation: There are outstanding changes not yet made to Commission Regulation (EU) 2017/1151. Any changes that have already been made to the legislation appear in the content and are referenced with annotations. (See end of Document for details)

799	159	798,8	800,0	121,2	121,2	121,2	- 0,0220	121,3	- 0,0152
-----	-----	-------	-------	-------	-------	-------	----------	-------	----------

Appendix 8

Data exchange and reporting requirements

1. INTRODUCTION

This Appendix describes the requirements for the data exchange between the measurement systems and the data evaluation software and the reporting and exchange of intermediate and final results after the completion of the data evaluation.

The exchange and reporting of mandatory and optional parameters shall follow the requirements of point 3.2 of Appendix 1. The data specified in the exchange and reporting files of point 3 shall be reported to ensure traceability of final results.

2. SYMBOLS, PARAMETERS AND UNITS

a_1	— coefficient of the CO ₂ characteristic curve
b_1	— coefficient of the CO ₂ characteristic curve
a_2	— coefficient of the CO ₂ characteristic curve
b_2	— coefficient of the CO ₂ characteristic curve
k_{11}	— coefficient of the weighing function
k_{12}	— coefficient of the weighing function
k_{21}	— coefficient of the weighing function
k_{22}	— coefficient of the weighing function
tol_1	— primary tolerance
tol_2	— secondary tolerance
$(v \times a_{pos})_{k-95}$	— 95 th percentile of the product of vehicle speed and positive acceleration greater than 0,1 m/s ² for urban, rural and motorway driving [m ² /s ³ or W/kg]
RPA_K	— relative positive acceleration for urban, rural and motorway driving [m/s ² or kW/(kg*km)]

3. DATA EXCHANGE AND REPORTING FORMAT

3.1. General

Emission values as well as any other relevant parameters shall be reported and exchanged as csv-formatted data file. Parameter values shall be separated by a comma, ASCII-Code #h2C. The decimal marker of numerical values shall be a point, ASCII-Code #h2E. Lines shall be terminated by carriage return, ASCII-Code #h0D. No thousands separators shall be used.

3.2. Data exchange

Data shall be exchanged between the measurement systems and the data evaluation software by means of a standardised reporting file that contains a minimum set of mandatory and optional parameters. The data exchange file shall be structured as follows: The first 195 lines shall be reserved for a header that provides specific information about, e.g., the test conditions, the identity and calibration of the PEMS equipment (Table 1). Lines 198-200 shall contain the labels and units of parameters. Lines 201 and all consecutive data lines shall comprise the body of the data exchange file and report parameter values (Table 2). The body of the data exchange

Status: Point in time view as at 01/06/2017.

Changes to legislation: There are outstanding changes not yet made to Commission Regulation (EU) 2017/1151. Any changes that have already been made to the legislation appear in the content and are referenced with annotations. (See end of Document for details)

file shall contain at least as many data lines as the test duration in seconds multiplied by the recording frequency in hertz.

3.3. Intermediate and final results

Summary parameters of intermediate results shall be recorded and structured as indicated in Table 3. The information in Table 3 shall be obtained prior to the application of the data evaluation methods laid down in Appendices 5 and 6.

The vehicle manufacturer shall record the results of the two data evaluation methods in separate files. The results of the data evaluation with the method described in Appendix 5 shall be reported according to Tables 4, 5 and 6. The results of the data evaluation with the method described in Appendix 6 shall be reported according to Tables 7, 8 and 9. The header of the data reporting file shall be composed of three parts. The first 95 lines shall be reserved for specific information about the settings of the data evaluation method. Lines 101-195 shall report the results of the data evaluation method. Lines 201-490 shall be reserved for reporting the final emission results. Line 501 and all consecutive data lines comprise the body of the data reporting file and shall contain the detailed results of the data evaluation.

4. TECHNICAL REPORTING TABLES

4.1. Data exchange

TABLE 1

Header of the data exchange file

Line	Parameter	Description/unit
1	TEST ID	[code]
2	Test date	[day.month.year]
3	Organisation supervising the test	[name of the organization]
4	Test location	[city, country]
5	Person supervising the test	[name of the principal supervisor]
6	Vehicle driver	[name of the driver]
7	Vehicle type	[vehicle name]
8	Vehicle manufacturer	[name]
9	Vehicle model year	[year]
a	Mass of the vehicle as tested on the road, including the mass of the driver and all PEMS components.	
b	Percentage shall indicate the deviation from the gross vehicle weight.	
c	Placeholders for additional information about analyser manufacturer and serial number in case multiple analysers are used. Number of reserved rows is indicative only; no empty rows shall occur in the completed data reporting file.	
d	Mandatory if the exhaust mass flow rate is determined by an EFM.	
e	If required, additional information may be added here.	
f	PEMS validation is optional; distance-specific emissions as measured with the PEMS; Percentage shall indicate the deviation from the laboratory reference	
g	Additional parameters may be added until line 195 to characterise and label the test.	

Status: Point in time view as at 01/06/2017.

Changes to legislation: There are outstanding changes not yet made to Commission Regulation (EU) 2017/1151. Any changes that have already been made to the legislation appear in the content and are referenced with annotations. (See end of Document for details)

10	Vehicle ID	[VIN code]
11	Odometer reading at test start	[km]
12	Odometer reading at test end	[km]
13	Vehicle category	[category]
14	Type approval emissions limit	[Euro X]
15	Engine type	[e.g., spark ignition, compression ignition]
16	Engine rated power	[kW]
17	Peak torque	[Nm]
18	Engine displacement	[ccm]
19	Transmission	[e.g., manual, automatic]
20	Number of forward gears	[#]
21	Fuel	[e.g., gasoline, diesel]
22	Lubricant	[product label]
23	Tire size	[width/height/rim diameter]
24	Front and rear axle tire pressure	[bar; bar]
25W	Road load parameters from WLTP,	[F ₀ , F ₁ , F ₂]
25N	Road load parameters from NEDC	[F ₀ , F ₁ , F ₂],
26	Type-approval test cycle	[NEDC, WLTC]
27	Type-approval CO ₂ emissions	[g/km]
28	CO ₂ emissions in WLTC mode Low	[g/km]
29	CO ₂ emissions in WLTC mode Mid	[g/km]
30	CO ₂ emissions in WLTC mode High	[g/km]

- a** Mass of the vehicle as tested on the road, including the mass of the driver and all PEMS components.
- b** Percentage shall indicate the deviation from the gross vehicle weight.
- c** Placeholders for additional information about analyser manufacturer and serial number in case multiple analysers are used. Number of reserved rows is indicative only; no empty rows shall occur in the completed data reporting file.
- d** Mandatory if the exhaust mass flow rate is determined by an EFM.
- e** If required, additional information may be added here.
- f** PEMS validation is optional; distance-specific emissions as measured with the PEMS; Percentage shall indicate the deviation from the laboratory reference
- g** Additional parameters may be added until line 195 to characterise and label the test.

Status: Point in time view as at 01/06/2017.

Changes to legislation: There are outstanding changes not yet made to Commission Regulation (EU) 2017/1151. Any changes that have already been made to the legislation appear in the content and are referenced with annotations. (See end of Document for details)

31	CO ₂ emissions in WLTC mode Extra High	[g/km]
32	Vehicle test mass ^a	[kg;% ^b]
33	PEMS manufacturer	[name]
34	PEMS type	[PEMS name]
35	PEMS serial number	[number]
36	PEMS power supply	[e.g., battery type]
37	Gas analyser manufacturer	[name]
38	Gas analyser type	[type]
39	Gas analyser serial number	[number]
40-50 ^c
51	EFM manufacturer ^d	[name]
52	EFM sensor type ^d	[functional principle]
53	EFM serial number ^d	[number]
54	Source of exhaust mass flow rate	[EFM/ECU/sensor]
55	Air pressure sensor	[type, manufacturer]
56	Test date	[day.month.year]
57	Start time of pre-test procedure	[h:min]
58	Start time of trip	[h:min]
59	Start time of post-test procedure	[h:min]
60	End time of pre-test procedure	[h:min]
61	End time of trip	[h:min]
62	End time of post-test procedure	[h:min]
63-70 ^e

a Mass of the vehicle as tested on the road, including the mass of the driver and all PEMS components.

b Percentage shall indicate the deviation from the gross vehicle weight.

c Placeholders for additional information about analyser manufacturer and serial number in case multiple analysers are used. Number of reserved rows is indicative only; no empty rows shall occur in the completed data reporting file.

d Mandatory if the exhaust mass flow rate is determined by an EFM.

e If required, additional information may be added here.

f PEMS validation is optional; distance-specific emissions as measured with the PEMS; Percentage shall indicate the deviation from the laboratory reference

g Additional parameters may be added until line 195 to characterise and label the test.

Status: Point in time view as at 01/06/2017.

Changes to legislation: There are outstanding changes not yet made to Commission Regulation (EU) 2017/1151. Any changes that have already been made to the legislation appear in the content and are referenced with annotations. (See end of Document for details)

71	Time correction: Shift THC	[s]
72	Time correction: Shift CH ₄	[s]
73	Time correction: Shift NMHC	[s]
74	Time correction: Shift O ₂	[s]
75	Time correction: Shift PN	[s]
76	Time correction: Shift CO	[s]
77	Time correction: Shift CO ₂	[s]
78	Time correction: Shift NO	[s]
79	Time correction: Shift NO ₂	[s]
80	Time correction: Shift exhaust mass flow rate	[s]
81	Span reference value THC	[ppm]
82	Span reference value CH ₄	[ppm]
83	Span reference value NMHC	[ppm]
84	Span reference value O ₂	[%]
85	Span reference value PN	[#]
86	Span reference value CO	[ppm]
87	Span reference value CO ₂	[%]
88	Span reference value NO	[ppm]
89	Span Reference Value NO ₂	[ppm]
90-95 ^e
96	Pre-test zero response THC	[ppm]
97	Pre-test zero response CH ₄	[ppm]
98	Pre-test zero response NMHC	[ppm]
99	Pre-test zero response O ₂	[%]
100	Pre-test zero response PN	[#]

a Mass of the vehicle as tested on the road, including the mass of the driver and all PEMS components.

b Percentage shall indicate the deviation from the gross vehicle weight.

c Placeholders for additional information about analyser manufacturer and serial number in case multiple analysers are used. Number of reserved rows is indicative only; no empty rows shall occur in the completed data reporting file.

d Mandatory if the exhaust mass flow rate is determined by an EFM.

e If required, additional information may be added here.

f PEMS validation is optional; distance-specific emissions as measured with the PEMS; Percentage shall indicate the deviation from the laboratory reference

g Additional parameters may be added until line 195 to characterise and label the test.

Status: Point in time view as at 01/06/2017.

Changes to legislation: There are outstanding changes not yet made to Commission Regulation (EU) 2017/1151. Any changes that have already been made to the legislation appear in the content and are referenced with annotations. (See end of Document for details)

101	Pre-test zero response CO	[ppm]
102	Pre-test zero response CO ₂	[%]
103	Pre-test zero response NO	[ppm]
104	Pre-test zero response NO ₂	[ppm]
105	Pre-test span response THC	[ppm]
106	Pre-test span response CH ₄	[ppm]
107	Pre-test span response NMHC	[ppm]
108	Pre-test span response O ₂	[%]
109	Pre-test span response PN	[#]
110	Pre-test span response CO	[ppm]
111	Pre-test span response CO ₂	[%]
112	Pre-test span response NO	[ppm]
113	Pre-test span response NO ₂	[ppm]
114	Post-test zero response THC	[ppm]
115	Post-test zero response CH ₄	[ppm]
116	Post-test zero response NMHC	[ppm]
117	Post-test zero response O ₂	[%]
118	Post-test zero response PN	[#]
119	Post-test zero response CO	[ppm]
120	Post-test zero response CO ₂	[%]
121	Post-test zero response NO	[ppm]
122	Post-test zero response NO ₂	[ppm]
123	Post-test span response THC	[ppm]
124	Post-test span response CH ₄	[ppm]
125	Post-test span response NMHC	[ppm]

a Mass of the vehicle as tested on the road, including the mass of the driver and all PEMS components.

b Percentage shall indicate the deviation from the gross vehicle weight.

c Placeholders for additional information about analyser manufacturer and serial number in case multiple analysers are used. Number of reserved rows is indicative only; no empty rows shall occur in the completed data reporting file.

d Mandatory if the exhaust mass flow rate is determined by an EFM.

e If required, additional information may be added here.

f PEMS validation is optional; distance-specific emissions as measured with the PEMS; Percentage shall indicate the deviation from the laboratory reference

g Additional parameters may be added until line 195 to characterise and label the test.

Status: Point in time view as at 01/06/2017.

Changes to legislation: There are outstanding changes not yet made to Commission Regulation (EU) 2017/1151. Any changes that have already been made to the legislation appear in the content and are referenced with annotations. (See end of Document for details)

126	Post-test span response O ₂	[%]
127	Post-test span response PN	[#]
128	Post-test span response CO	[ppm]
129	Post-test span response CO ₂	[%]
130	Post-test span response NO	[ppm]
131	Post-test span response NO ₂	[ppm]
132	PEMS validation – results THC	[mg/km;%] ^f
133	PEMS validation – results CH ₄	[mg/km;%] ^f
134	PEMS validation – results NMHC	[mg/km;%] ^f
135	PEMS validation – results PN	[#/km;%] ^f
136	PEMS validation – results CO	[mg/km;%] ^f
137	PEMS validation – results CO ₂	[g/km;%] ^f
138	PEMS validation – results NO _x	[mg/km;%] ^f
... ^g	... ^g	... ^g

- a** Mass of the vehicle as tested on the road, including the mass of the driver and all PEMS components.
- b** Percentage shall indicate the deviation from the gross vehicle weight.
- c** Placeholders for additional information about analyser manufacturer and serial number in case multiple analysers are used. Number of reserved rows is indicative only; no empty rows shall occur in the completed data reporting file.
- d** Mandatory if the exhaust mass flow rate is determined by an EFM.
- e** If required, additional information may be added here.
- f** PEMS validation is optional; distance-specific emissions as measured with the PEMS; Percentage shall indicate the deviation from the laboratory reference
- g** Additional parameters may be added until line 195 to characterise and label the test.

TABLE 2

Body of the data exchange file; the rows and columns of this table shall be transposed in the body of the data exchange file

Line	198	199 ^a	200	201
	Time	trip	[s]	^b

- a** This column can be omitted if the parameter source is part of the label in column 198.
- b** Actual values to be included from line 201 onward until the end of data
- c** To be determined by at least one method
- d** Additional parameters may be added to characterise vehicle and test conditions.

Status: Point in time view as at 01/06/2017.

Changes to legislation: There are outstanding changes not yet made to Commission Regulation (EU) 2017/1151. Any changes that have already been made to the legislation appear in the content and are referenced with annotations. (See end of Document for details)

	Vehicle speed ^c	Sensor	[km/h]	b
	Vehicle speed ^c	GPS	[km/h]	b
	Vehicle speed ^c	ECU	[km/h]	b
	Latitude	GPS	[deg:min:s]	b
	Longitude	GPS	[deg:min:s]	b
	Altitude ^c	GPS	[m]	b
	Altitude ^c	Sensor	[m]	b
	Ambient pressure	Sensor	[kPa]	b
	Ambient temperature	Sensor	[K]	b
	Ambient humidity	Sensor	[g/kg; %]	b
	THC concentration	Analyser	[ppm]	b
	CH ₄ concentration	Analyser	[ppm]	b
	NMHC concentration	Analyser	[ppm]	b
	CO concentration	Analyser	[ppm]	b
	CO ₂ concentration	Analyser	[ppm]	b
	NO _x concentration	Analyser	[ppm]	b
	NO concentration	Analyser	[ppm]	b
	NO ₂ concentration	Analyser	[ppm]	b
	O ₂ concentration	Analyser	[ppm]	b
	PN concentration	Analyser	[#/m ³]	b
	Exhaust mass flow rate	EFM	[kg/s]	b

a This column can be omitted if the parameter source is part of the label in column 198.

b Actual values to be included from line 201 onward until the end of data

c To be determined by at least one method

d Additional parameters may be added to characterise vehicle and test conditions.

Status: Point in time view as at 01/06/2017.

Changes to legislation: There are outstanding changes not yet made to Commission Regulation (EU) 2017/1151. Any changes that have already been made to the legislation appear in the content and are referenced with annotations. (See end of Document for details)

	Exhaust temperature in the EFM	EFM	[K]	b
	Exhaust mass flow rate	Sensor	[kg/s]	b
	Exhaust mass flow rate	ECU	[kg/s]	b
	THC mass	Analyser	[g/s]	b
	CH ₄ mass	Analyser	[g/s]	b
	NMHC mass	Analyser	[g/s]	b
	CO mass	Analyser	[g/s]	b
	CO ₂ mass	Analyser	[g/s]	b
	NO _x mass	Analyser	[g/s]	b
	NO mass	Analyser	[g/s]	b
	NO ₂ mass	Analyser	[g/s]	b
	O ₂ mass	Analyser	[g/s]	b
	PN	Analyser	[#/s]	b
	Gas measurement active	PEMS	[active (1); inactive (0); error (>1)]	b
	Engine speed	ECU	[rpm]	b
	Engine torque	ECU	[Nm]	b
	Torque at driven axle	Sensor	[Nm]	b
	Wheel rotational speed	Sensor	[rad/s]	b
	Fuel rate	ECU	[g/s]	b
	Engine fuel flow	ECU	[g/s]	b
	Engine intake air flow	ECU	[g/s]	b
	Coolant temperature	ECU	[K]	b
	Oil temperature	ECU	[K]	b

a This column can be omitted if the parameter source is part of the label in column 198.

b Actual values to be included from line 201 onward until the end of data

c To be determined by at least one method

d Additional parameters may be added to characterise vehicle and test conditions.

Status: Point in time view as at 01/06/2017.

Changes to legislation: There are outstanding changes not yet made to Commission Regulation (EU) 2017/1151. Any changes that have already been made to the legislation appear in the content and are referenced with annotations. (See end of Document for details)

	Regeneration status	ECU	—	b
	Pedal position	ECU	[%]	b
	Vehicle status	ECU	[error (1); normal (0)]	b
	Per cent torque	ECU	[%]	b
	Per cent friction torque	ECU	[%]	b
	State of charge	ECU	[%]	b
	... ^d	... ^d	... ^d	b ^d

a This column can be omitted if the parameter source is part of the label in column 198.

b Actual values to be included from line 201 onward until the end of data

c To be determined by at least one method

d Additional parameters may be added to characterise vehicle and test conditions.

4.2. Intermediate and final results

4.2.1. Intermediate results

TABLE 3

Reporting file #1 - Summary parameters of intermediate results

Line	Parameter	Description/unit
1	Total trip distance	[km]
2	Total trip duration	[h:min:s]
3	Total stop time	[min:s]
4	Trip average speed	[km/h]
5	Trip maximum speed	[km/h]
6	Altitude at start point of the trip	[m above sea level]
7	Altitude at end point of the trip	[m above sea level]
8	Cumulative elevation gain during the trip	[m/100 km]
6	Average THC concentration	[ppm]
7	Average CH ₄ concentration	[ppm]
8	Average NMHC concentration	[ppm]
9	Average CO concentration	[ppm]

a Parameters may be added to characterize additional elements of the trip.

Status: Point in time view as at 01/06/2017.

Changes to legislation: There are outstanding changes not yet made to Commission Regulation (EU) 2017/1151. Any changes that have already been made to the legislation appear in the content and are referenced with annotations. (See end of Document for details)

10	Average CO ₂ concentration	[ppm]
11	Average NO _x concentration	[ppm]
12	Average PN concentration	[#/m ³]
13	Average exhaust mass flow rate	[kg/s]
14	Average exhaust temperature	[K]
15	Maximum exhaust temperature	[K]
16	Cumulated THC mass	[g]
17	Cumulated CH ₄ mass	[g]
18	Cumulated NMHC mass	[g]
19	Cumulated CO mass	[g]
20	Cumulated CO ₂ mass	[g]
21	Cumulated NO _x mass	[g]
22	Cumulated PN	[#]
23	Total trip THC emissions	[mg/km]
24	Total trip CH ₄ emissions	[mg/km]
25	Total trip NMHC emissions	[mg/km]
26	Total trip CO emissions	[mg/km]
27	Total trip CO ₂ emissions	[g/km]
28	Total trip NO _x emissions	[mg/km]
29	Total trip PN emissions	[#/km]
30	Distance urban part	[km]
31	Duration urban part	[h:min:s]
32	Stop time urban part	[min:s]
33	Average speed urban part	[km/h]
34	Maximum speed urban part	[km/h]
38	$(v \times a_{p_{0.95}})_k - [95]$, k=urban	[m ² /s ³]
39	RPA_k , k=urban	[m/s ²]
40	Cumulative urban elevation gain	[m/100 km]
41	Average urban THC concentration	[ppm]

a Parameters may be added to characterize additional elements of the trip.

Status: Point in time view as at 01/06/2017.

Changes to legislation: There are outstanding changes not yet made to Commission Regulation (EU) 2017/1151. Any changes that have already been made to the legislation appear in the content and are referenced with annotations. (See end of Document for details)

42	Average urban CH ₄ concentration	[ppm]
43	Average urban NMHC concentration	[ppm]
44	Average urban CO concentration	[ppm]
45	Average urban CO ₂ concentration	[ppm]
46	Average urban NO _x concentration	[ppm]
47	Average urban PN concentration	[#/m ³]
48	Average urban exhaust mass flow rate	[kg/s]
49	Average urban exhaust temperature	[K]
50	Maximum urban exhaust temperature	[K]
51	Cumulated urban THC mass	[g]
52	Cumulated urban CH ₄ mass	[g]
53	Cumulated urban NMHC mass	[g]
54	Cumulated urban CO mass	[g]
55	Cumulated urban CO ₂ mass	[g]
56	Cumulated urban NO _x mass	[g]
57	Cumulated urban PN	[#]
58	Urban THC emissions	[mg/km]
59	Urban CH ₄ emissions	[mg/km]
60	Urban NMHC emissions	[mg/km]
61	Urban CO emissions	[mg/km]
62	Urban CO ₂ emissions	[g/km]
63	Urban NO _x emissions	[mg/km]
64	Urban PN emissions	[#/km]
65	Distance rural part	[km]
66	Duration rural part	[h:min:s]
67	Stop time rural part	[min:s]

a Parameters may be added to characterize additional elements of the trip.

Status: Point in time view as at 01/06/2017.

Changes to legislation: There are outstanding changes not yet made to Commission Regulation (EU) 2017/1151. Any changes that have already been made to the legislation appear in the content and are referenced with annotations. (See end of Document for details)

68	Average speed rural part	[km/h]
69	Maximum speed rural part	[km/h]
70	$(v \times a_{pov})_k - [95]$, k=rural	[m ² /s ³]
71	RPA_k , k=rural	[m/s ²]
72	Average rural THC concentration	[ppm]
73	Average rural CH ₄ concentration	[ppm]
74	Average rural NMHC concentration	[ppm]
75	Average rural CO concentration	[ppm]
76	Average rural CO ₂ concentration	[ppm]
77	Average rural NO _x concentration	[ppm]
78	Average rural PN concentration	[#/m ³]
79	Average rural exhaust mass flow rate	[kg/s]
80	Average rural exhaust temperature	[K]
81	Maximum rural exhaust temperature	[K]
82	Cumulated rural THC mass	[g]
83	Cumulated rural CH ₄ mass	[g]
84	Cumulated rural NMHC mass	[g]
85	Cumulated rural CO mass	[g]
86	Cumulated rural CO ₂ mass	[g]
87	Cumulated rural NO _x mass	[g]
88	Cumulated rural PN	[#]
89	Rural THC emissions	[mg/km]
90	Rural CH ₄ emissions	[mg/km]
91	Rural NMHC emissions	[mg/km]
92	Rural CO emissions	[mg/km]

a Parameters may be added to characterize additional elements of the trip.

Status: Point in time view as at 01/06/2017.

Changes to legislation: There are outstanding changes not yet made to Commission Regulation (EU) 2017/1151. Any changes that have already been made to the legislation appear in the content and are referenced with annotations. (See end of Document for details)

93	Rural CO ₂ emissions	[g/km]
94	Rural NO _x emissions	[mg/km]
95	Rural PN emissions	[/km]
96	Distance motorway part	[km]
97	Duration motorway part	[h:min:s]
98	Stop time motorway part	[min:s]
99	Average speed motorway part	[km/h]
100	Maximum speed motorway part	[km/h]
101	$(v \times a_{pos})_k - [95]$, k=motorway	[m ² /s ³]
102	RPA_k , k=motorway	[m/s ²]
103	Average motorway THC concentration	[ppm]
104	Average motorway CH ₄ concentration	[ppm]
105	Average motorway NMHC concentration	[ppm]
106	Average motorway CO concentration	[ppm]
107	Average motorway CO ₂ concentration	[ppm]
108	Average motorway NO _x concentration	[ppm]
109	Average motorway PN concentration	[/m ³]
110	Average motorway exhaust mass flow rate	[kg/s]
111	Average motorway exhaust temperature	[K]
112	Maximum motorway exhaust temperature	[K]
113	Cumulated motorway THC mass	[g]
114	Cumulated motorway CH ₄ mass	[g]
115	Cumulated motorway NMHC mass	[g]

a Parameters may be added to characterize additional elements of the trip.

Status: Point in time view as at 01/06/2017.

Changes to legislation: There are outstanding changes not yet made to Commission Regulation (EU) 2017/1151. Any changes that have already been made to the legislation appear in the content and are referenced with annotations. (See end of Document for details)

116	Cumulated motorway CO mass	[g]
117	Cumulated motorway CO ₂ mass	[g]
118	Cumulated motorway NO _x mass	[g]
119	Cumulated motorway PN	[#]
120	Motorway THC emissions	[mg/km]
121	Motorway CH ₄ emissions	[mg/km]
122	Motorway NMHC emissions	[mg/km]
123	Motorway CO emissions	[mg/km]
124	Motorway CO ₂ emissions	[g/km]
125	Motorway NO _x emissions	[mg/km]
126	Motorway PN emissions	[#/km]
... ^a	... ^a	... ^a

a Parameters may be added to characterize additional elements of the trip.

4.2.2. Results of the data evaluation

TABLE 4

Header of reporting file #2 - Calculation settings of the data evaluation method according to Appendix 5

Line	Parameter	Unit
1	Reference CO ₂ mass	[g]
2	Coefficient a_1 of the CO ₂ characteristic curve	
3	Coefficient b_1 of the CO ₂ characteristic curve	
4	Coefficient a_2 of the CO ₂ characteristic curve	
5	Coefficient b_2 of the CO ₂ characteristic curve	
6	Coefficient k_{11} of the weighing function	
7	Coefficient k_{21} of the weighing function	

a Parameters may be added until line 95 to characterize additional calculation settings.

Status: Point in time view as at 01/06/2017.

Changes to legislation: There are outstanding changes not yet made to Commission Regulation (EU) 2017/1151. Any changes that have already been made to the legislation appear in the content and are referenced with annotations. (See end of Document for details)

8	Coefficient $k_{22}=k_{12}$ of the weighing function	
9	Primary tolerance tol_1	[%]
10	Secondary tolerance tol_2	[%]
11	Calculation software and version	(e.g. EMROAD 5.8)
... ^a	... ^a	... ^a

a Parameters may be added until line 95 to characterize additional calculation settings.

TABLE 5A

Header of reporting file #2 – Results of the data evaluation method according to Appendix 5

Line	Parameter	Unit
101	Number of windows	
102	Number of urban windows	
103	Number of rural windows	
104	Number of motorway windows	
105	Share of urban windows	[%]
106	Share of rural windows	[%]
107	Share of motorway windows	[%]
108	Share of urban windows in the total number of windows higher than 15 %	(1=Yes, 0=No)
109	Share of rural windows in the total number of windows higher than 15 %	(1=Yes, 0=No)
110	Share of motorway windows in the total number of windows higher than 15 %	(1=Yes, 0=No)
111	Number of windows within $\pm tol_1$	
112	Number of urban windows within $\pm tol_1$	
113	Number of rural windows within $\pm tol_1$	
114	Number of motorway windows within $\pm tol_1$	

a Parameters may be added until line 195.

Status: Point in time view as at 01/06/2017.

Changes to legislation: There are outstanding changes not yet made to Commission Regulation (EU) 2017/1151. Any changes that have already been made to the legislation appear in the content and are referenced with annotations. (See end of Document for details)

115	Number of windows within $\pm tol_2$	
116	Number of urban windows within $\pm tol_2$	
117	Number of rural windows within $\pm tol_2$	
118	Number of motorway windows within $\pm tol_2$	
119	Share of urban windows within $\pm tol_1$	[%]
120	Share of rural windows within $\pm tol_1$	[%]
121	Share of motorway windows within $\pm tol_1$	[%]
122	Share of urban windows within $\pm tol_1$ greater than 50 %	(1=Yes, 0=No)
123	Share of rural windows within $\pm tol_1$ greater than 50 %	(1=Yes, 0=No)
124	Share of motorway windows within $\pm tol_1$ greater than 50 %	(1=Yes, 0=No)
125	Average severity index of all windows	[%]
126	Average severity index of urban windows	[%]
127	Average severity index of rural windows	[%]
128	Average severity index of motorway windows	[%]
129	Weighted THC emissions of urban windows	[mg/km]
130	Weighted THC emissions of rural windows	[mg/km]
131	Weighted THC emissions of motorway windows	[mg/km]
132	Weighted CH ₄ emissions of urban windows	[mg/km]

a Parameters may be added until line 195.

Status: Point in time view as at 01/06/2017.

Changes to legislation: There are outstanding changes not yet made to Commission Regulation (EU) 2017/1151. Any changes that have already been made to the legislation appear in the content and are referenced with annotations. (See end of Document for details)

133	Weighted CH ₄ emissions of rural windows	[mg/km]
134	Weighted CH ₄ emissions of motorway windows	[mg/km]
135	Weighted NMHC emissions of urban windows	[mg/km]
136	Weighted NMHC emissions of rural windows	[mg/km]
137	Weighted NMHC emissions of motorway windows	[mg/km]
138	Weighted CO emissions of urban windows	[mg/km]
139	Weighted CO emissions of rural windows	[mg/km]
140	Weighted CO emissions of motorway windows	[mg/km]
141	Weighted NO _x emissions of urban windows	[mg/km]
142	Weighted NO _x emissions of rural windows	[mg/km]
143	Weighted NO _x emissions of motorway windows	[mg/km]
144	Weighted NO emissions of urban windows	[mg/km]
145	Weighted NO emissions of rural windows	[mg/km]
146	Weighted NO emissions of motorway windows	[mg/km]
147	Weighted NO ₂ emissions of urban windows	[mg/km]
148	Weighted NO ₂ emissions of rural windows	[mg/km]
149	Weighted NO ₂ emissions of motorway windows	[mg/km]
150	Weighted PN emissions of urban windows	[#/km]
151	Weighted PN emissions of rural windows	[#/km]
152	Weighted PN emissions of motorway windows	[#/km]

a Parameters may be added until line 195.

Status: Point in time view as at 01/06/2017.

Changes to legislation: There are outstanding changes not yet made to Commission Regulation (EU) 2017/1151. Any changes that have already been made to the legislation appear in the content and are referenced with annotations. (See end of Document for details)

... ^a	... ^a	... ^a
------------------	------------------	------------------

^a Parameters may be added until line 195.

TABLE 5B

Header of reporting file #2 – Final emission results according to Appendix 5

Line	Parameter	Unit
201	Total trip - THC Emissions	[mg/km]
202	Total trip - CH ₄ Emissions	[mg/km]
203	Total trip - NMHC Emissions	[mg/km]
204	Total trip - CO Emissions	[mg/km]
205	Total trip - NO _x Emissions	[mg/km]
206	Total trip - PN Emissions	[#/km]
... ^a	... ^a	... ^a

^a Additional parameters may be added.

TABLE 6

Body of reporting file #2 - Detailed results of the data evaluation method according to Appendix 5; the rows and columns of this table shall be transposed in the body of the data reporting file

Line	498	499	500	501
	Window Start Time		[s]	^a
	Window End Time		[s]	^a
	Window Duration		[s]	^a
	Window Distance	Source (1=GPS, 2=ECU, 3=Sensor)	[km]	^a
	Window THC emissions		[g]	^a
	Window CH ₄ emissions		[g]	^a
	Window NMHC emissions		[g]	^a
	Window CO emissions		[g]	^a

^a Actual values to be included from line 501 to line onward until the end of data.

^b Additional parameters may be added to characterise window characteristics.

Status: Point in time view as at 01/06/2017.

Changes to legislation: There are outstanding changes not yet made to Commission Regulation (EU) 2017/1151. Any changes that have already been made to the legislation appear in the content and are referenced with annotations. (See end of Document for details)

	Window CO ₂ emissions		[g]	^a
	Window NO _x emissions		[g]	^a
	Window NO emissions		[g]	^a
	Window NO ₂ emissions		[g]	^a
	Window O ₂ emissions		[g]	^a
	Window PN emissions		[#]	^a
	Window THC emissions		[mg/km]	^a
	Window CH ₄ emissions		[mg/km]	^a
	Window NMHC emissions		[mg/km]	^a
	Window CO emissions		[mg/km]	^a
	Window CO ₂ emissions		[g/km]	^a
	Window NO _x emissions		[mg/km]	^a
	Window NO emissions		[mg/km]	^a
	Window NO ₂ emissions		[mg/km]	^a
	Window O ₂ emissions		[mg/km]	^a
	Window PN emissions		[#/km]	^a
	Window distance to CO ₂ characteristic curve h_j		[%]	^a
	Window weighing factor w_j		[—]	^a

^a Actual values to be included from line 501 to line onward until the end of data.

^b Additional parameters may be added to characterise window characteristics.

Status: Point in time view as at 01/06/2017.

Changes to legislation: There are outstanding changes not yet made to Commission Regulation (EU) 2017/1151. Any changes that have already been made to the legislation appear in the content and are referenced with annotations. (See end of Document for details)

	Window Average Vehicle Speed	Source (1=GPS, 2=ECU, 3=Sensor)	[km/h]	^a
	^b ...	^b ...	^b ...	^{a b} ,

^a Actual values to be included from line 501 to line onward until the end of data.

^b Additional parameters may be added to characterise window characteristics.

TABLE 7

Header of reporting file #3 - Calculation settings of the data evaluation method according to Appendix 6

Line	Parameter	Unit
1	Torque source for the power at the wheels	Sensor/ECU/‘Veline’
2	Slope of the Veline	[g/kWh]
3	Intercept of the Veline	[g/h]
4	Moving average duration	[s]
5	Reference speed for de-normalisation of goal pattern	[km/h]
6	Reference acceleration	[m/s ²]
7	Power demand at the wheel hub for a vehicle at reference speed and acceleration	[kW]
8	Number of power classes including the 90 % of P _{rated}	—
9	Goal pattern layout	(stretched/shrank)
10	Calculation software and version	(e.g. CLEAR 1.8)
... ^a	... ^a	... ^a

^a Additional parameters may be added until line 95 to characterize calculation settings

TABLE 8A

Header of reporting file #3 – Results of data evaluation method according to Appendix 6

Line	Parameter	Unit
101	Power class coverage (counts > 5)	(1=Yes, 0=No)
102	Power class normality	(1=Yes, 0=No)
103	Total trip - Weighted average THC emissions	[g/s]

^a Additional parameters may be added until line 195

Status: Point in time view as at 01/06/2017.

Changes to legislation: There are outstanding changes not yet made to Commission Regulation (EU) 2017/1151. Any changes that have already been made to the legislation appear in the content and are referenced with annotations. (See end of Document for details)

104	Total trip - Weighted average CH ₄ emissions	[g/s]
105	Total trip - Weighted average NMHC emissions	[g/s]
106	Total trip - Weighted average CO emissions	[g/s]
107	Total trip - Weighted average CO ₂ emissions	[g/s]
108	Total trip - Weighted average NO _x emissions	[g/s]
109	Total trip - Weighted s average NO emissions	[g/s]
110	Total trip - Weighted average NO ₂ emissions	[g/s]
111	Total trip - Weighted average O ₂ emissions	[g/s]
112	Total trip - Weighted average PN emissions	[#/s]
113	Total trip - Weighted average Vehicle Speed	[km/h]
114	Urban - Weighted average THC emissions	[g/s]
115	Urban - Weighted average CH ₄ emissions	[g/s]
116	Urban - Weighted average NMHC emissions	[g/s]
117	Urban - Weighted average CO emissions	[g/s]
118	Urban - Weighted average CO ₂ emissions	[g/s]
119	Urban - Weighted average NO _x emissions	[g/s]
120	Urban - Weighted s average NO emissions	g/s]
121	Urban - Weighted average NO ₂ emissions	[g/s]
122	Urban - Weighted average O ₂ emissions	[g/s]
123	Urban - Weighted average PN emissions	[#/s]

a Additional parameters may be added until line 195

Status: Point in time view as at 01/06/2017.

Changes to legislation: There are outstanding changes not yet made to Commission Regulation (EU) 2017/1151. Any changes that have already been made to the legislation appear in the content and are referenced with annotations. (See end of Document for details)

124	Urban - Weighted average Vehicle Speed	[km/h]
... ^a	... ^a	... ^a

a Additional parameters may be added until line 195

TABLE 8B

Header of reporting file #3 – Final emissions results according to Appendix 6

Line	Parameter	Unit
201	Total trip - THC Emissions	[mg/km]
202	Total trip - CH ₄ Emissions	[mg/km]
203	Total trip - NMHC Emissions	[mg/km]
204	Total trip - CO Emissions	[mg/km]
205	Total trip - NO _x Emissions	[mg/km]
206	Total trip - PN Emissions	[#/km]
... ^a	... ^a	... ^a

a Additional parameters may be added

TABLE 9

Body of reporting file #3 - Detailed results of the data evaluation method according to Appendix 6; the rows and columns of this table shall be transposed in the body of the data reporting file

Line	498	499	500	501
	Total trip - Power class number ^a		—	
	Total trip - Lower power class limit ^a		[kW]	
	Total trip - Upper power class limit ^a		[kW]	
	Total trip - Goal pattern used (distribution) ^a		[%]	^b

a Results reported for each power class starting from power class #1 up to power class which includes 90 % of P_{rated}

b Actual values to be included from line 501 to line onward until the end of data

c Results reported for each power class starting from power class #1 up to power class #5

d Additional parameters may be added

Status: Point in time view as at 01/06/2017.

Changes to legislation: There are outstanding changes not yet made to Commission Regulation (EU) 2017/1151. Any changes that have already been made to the legislation appear in the content and are referenced with annotations. (See end of Document for details)

	Total trip - Power class occurrence ^a		—	^b
	Total trip - Power class coverage > 5 counts ^a		—	(1=Yes, 0=No) ^b
	Total trip - Power class normality ^a		—	(1=Yes, 0=No) ^b
	Total trip - Power class average THC emissions ^a		[g/s]	^b
	Total trip - Power class average CH ₄ emissions ^a		[g/s]	^b
	Total trip - Power class average NMHC emissions ^a		[g/s]	^b
	Total trip - Power class average CO emissions ^a		[g/s]	^b
	Total trip - Power class average CO ₂ emissions ^a		[g/s]	^b
	Total trip - Power class average NO _x emissions ^a		[g/s]	^b
	Total trip - Power class average NO emissions ^a		[g/s]	^b
	Total trip - Power class		[g/s]	^b

^a Results reported for each power class starting from power class #1 up to power class which includes 90 % of P_{rated}

^b Actual values to be included from line 501 to line onward until the end of data

^c Results reported for each power class starting from power class #1 up to power class #5

^d Additional parameters may be added

Status: Point in time view as at 01/06/2017.

Changes to legislation: There are outstanding changes not yet made to Commission Regulation (EU) 2017/1151. Any changes that have already been made to the legislation appear in the content and are referenced with annotations. (See end of Document for details)

	average NO ₂ emissions ^a			
	Total trip - Power class average O ₂ emissions ^a		[g/s]	^b
	Total trip - Power class average PN emissions ^a		[#/s]	^b
	Total trip - Power class average Vehicle Speed ^a	Source (1=GPS, 2=ECU, 3=Sensor)	[km/h]	^b
	Urban trip - Power class number ^a		—	
	Urban trip - Lower power class limit ^a		[kW]	
	Urban trip - Upper power class limit ^a		[kW]	
	Urban trip - Goal pattern used (distribution) ^a		[%]	^b
	Urban trip - Power class occurrence ^a		—	^b
	Urban trip - Power class coverage > 5 counts ^c		—	(1=Yes, 0=No) ^b
	Urban trip - Power class normality ^a		—	(1=Yes, 0=No) ^b
	Urban trip - Power class average THC emissions ^a		[g/s]	^b

a Results reported for each power class starting from power class #1 up to power class which includes 90 % of P_{rated}

b Actual values to be included from line 501 to line onward until the end of data

c Results reported for each power class starting from power class #1 up to power class #5

d Additional parameters may be added

Status: Point in time view as at 01/06/2017.

Changes to legislation: There are outstanding changes not yet made to Commission Regulation (EU) 2017/1151. Any changes that have already been made to the legislation appear in the content and are referenced with annotations. (See end of Document for details)

	Urban trip - Power class average CH ₄ emissions ^a		[g/s]	b
	Urban trip - Power class average NMHC emissions ^a		[g/s]	b
	Urban trip - Power class average CO emissions ^a		[g/s]	b
	Urban trip - Power class average CO ₂ emissions ^a		[g/s]	b
	Urban trip - Power class average NO _x emissions ^a		[g/s]	b
	Urban trip - Power class average NO emissions ^a		[g/s]	b
	Urban trip - Power class average NO ₂ emissions ^a		[g/s]	b
	Urban trip - Power class average O ₂ emissions ^a		[g/s]	b
	Urban trip - Power class average PN emissions ^a		[#/s]	b
	Urban trip - Power class average Vehicle Speed ^a	Source (1=GPS, 2=ECU, 3=Sensor)	[km/h]	b

a Results reported for each power class starting from power class #1 up to power class which includes 90 % of P_{rated}

b Actual values to be included from line 501 to line onward until the end of data

c Results reported for each power class starting from power class #1 up to power class #5

d Additional parameters may be added

Status: Point in time view as at 01/06/2017.

Changes to legislation: There are outstanding changes not yet made to Commission Regulation (EU) 2017/1151. Any changes that have already been made to the legislation appear in the content and are referenced with annotations. (See end of Document for details)

	d ...	d ...	d ...	b d ,
a	Results reported for each power class starting from power class #1 up to power class which includes 90 % of P _{rated}			
b	Actual values to be included from line 501 to line onward until the end of data			
c	Results reported for each power class starting from power class #1 up to power class #5			
d	Additional parameters may be added			

4.3. Vehicle and engine description

The manufacturer shall provide the vehicle and engine description in accordance with Appendix 4 of Annex I.

Appendix 9

Manufacturer's certificate of compliance

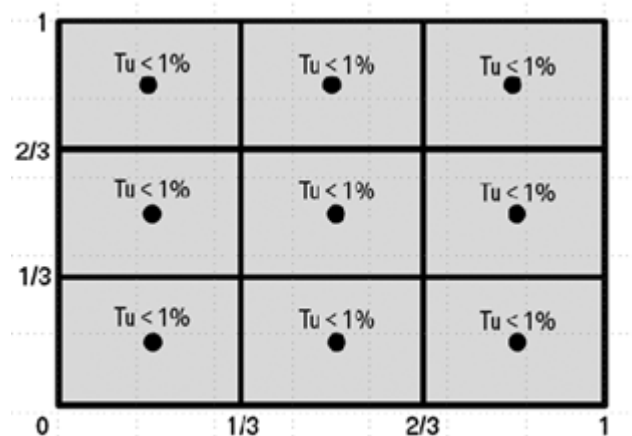

ANNEX IV

EMISSIONS DATA REQUIRED AT TYPE-APPROVAL FOR ROADWORTHINESS PURPOSES

Appendix 1

MEASURING CARBON MONOXIDE EMISSION AT ENGINE IDLING SPEEDS(TYPE 2 TEST)

1. INTRODUCTION

1.1. This appendix describes the procedure for the type 2 test, measuring carbon monoxide emissions at engine idling speeds (normal and high).

Status: Point in time view as at 01/06/2017.

Changes to legislation: There are outstanding changes not yet made to Commission Regulation (EU) 2017/1151. Any changes that have already been made to the legislation appear in the content and are referenced with annotations. (See end of Document for details)

2. GENERAL REQUIREMENTS

- 2.1. The general requirements shall be those specified in section 5.3.2 and paragraphs 5.3.7.1 to 5.3.7.6 of UN/ECE Regulation No 83, with the exception set out in section 2.2.
- 2.2. The table referred to in paragraph 5.3.7.5. of UN/ECE Regulation No 83 shall be understood as the table for the Type 2 test in section 2.1 the Addendum to Appendix 4 to Annex I to this Regulation.

3. TECHNICAL REQUIREMENTS

- 3.1. The technical requirements shall be those set out in Annex 5 to UN/ECE Regulation No 83, with the exceptions set out in sections 3.2. and 3.3.
- 3.2. The reference fuel specifications referred to in paragraph 2.1 of Annex 5 to UN/ECE Regulation No 83 shall be understood as referring to the appropriate reference fuel specifications in Annex IX to this Regulation.
- 3.3. Reference to the Type I test in paragraph 2.2.1. of Annex 5 to UN/ECE Regulation No 83 shall be understood as referring to the Type 1 test in Annex XXI to this Regulation.

Appendix 2

MEASUREMENT OF SMOKE OPACITY

1. INTRODUCTION

- 1.1. This Appendix describes the requirements for measuring the opacity of exhaust emissions.

2. SYMBOL OF THE CORRECTED ABSORPTION COEFFICIENT

- 2.1. A symbol of the corrected absorption coefficient shall be affixed to every vehicle conforming to a vehicle type to which this test applies. The symbol shall be a rectangle surrounding a figure expressing in m^{-1} the corrected absorption coefficient obtained, at the time of approval, from the test under free acceleration. The test method is described in section 4.
- 2.2. The symbol shall be clearly legible and indelible. It shall be fixed in a conspicuous and readily accessible place, the location of which shall be specified in the Addendum to the type-approval certificate shown in Appendix 4 to Annex I.
- 2.3. Figure IV.2.1 gives an example of the symbol.

Status: Point in time view as at 01/06/2017.

Changes to legislation: There are outstanding changes not yet made to Commission Regulation (EU) 2017/1151. Any changes that have already been made to the legislation appear in the content and are referenced with annotations. (See end of Document for details)

Figure

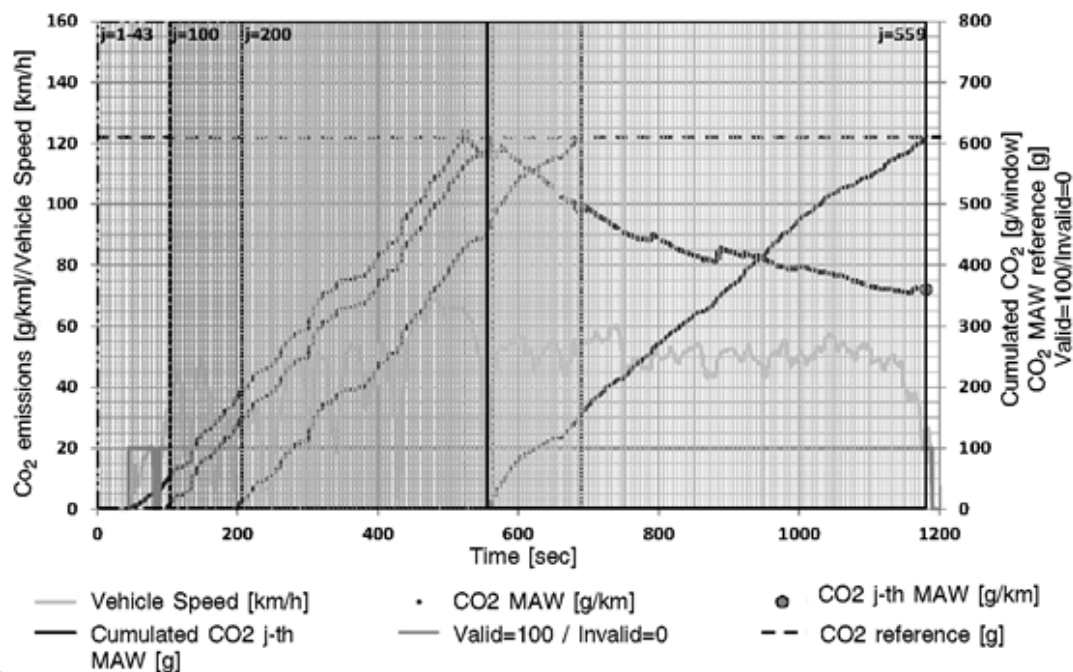

IV.2.1

The above symbol shows that the corrected absorption coefficient is $1,30 \text{ m}^{-1}$.

3. SPECIFICATIONS AND TESTS

- 3.1. The specifications and tests shall be those set out in Part III, section 24, of UN/ECE Regulation No 24⁽²⁶⁾, with the exception to these procedures set out in section 3.2.
- 3.2. The reference to Annex 2 in paragraph 24.1 of UN/ECE Regulation No 24 shall be understood as a reference to Appendix 4 to Annex I to this Regulation.

4. TECHNICAL REQUIREMENTS

- 4.1. The technical requirements shall be those set out in Annexes 4, 5, 7, 8, 9 and 10 to UN/ECE Regulation No 24, with the exceptions set out in sections 4.2., 4.3 and 4.4.
- 4.2. **Test at steady engine speeds over the full load curve**
 - 4.2.1. The references to Annex 1 in paragraph 3.1. of Annex 4 of UN/ECE Regulation No 24 shall be understood as references to Appendix 3 to Annex I to this Regulation.
 - 4.2.2. The reference fuel specified in paragraph 3.2 of Annex 4 of UN/ECE Regulation No 24 shall be understood as reference to the reference fuel in Annex IX to this Regulation appropriate to the emission limits against which the vehicle is being type approved.
- 4.3. **Test under free acceleration**
 - 4.3.1. The references to Table 2, Annex 2 in paragraph 2.2 of Annex 5 to UN/ECE Regulation No 24 shall be understood as references to the table under point 2.4.2.1 of Appendix 4 to Annex I to this Regulation.
 - 4.3.2. The references to paragraph 7.3 of Annex 1 in paragraph 2.3 of Annex 5 to UN/ECE Regulation No 24 shall be understood as references to Appendix 3 to Annex I to this Regulation.

Status: Point in time view as at 01/06/2017.

Changes to legislation: There are outstanding changes not yet made to Commission Regulation (EU) 2017/1151. Any changes that have already been made to the legislation appear in the content and are referenced with annotations. (See end of Document for details)

4.4. **‘ECE’ method of measuring the net power of C.I. engines**

- 4.4.1. The references in paragraph 7 of Annex 10 to UN/ECE Regulation No 24 to the ‘Appendix to this Annex’ and in paragraphs 7 and 8 of Annex 10 to UN/ECE Regulation No 24 to ‘Annex 1’ shall be understood as references to Appendix 3 to Annex I to this Regulation.

ANNEX V

VERIFYING EMISSIONS OF CRANKCASE GASES(TYPE 3 TEST)

1. INTRODUCTION

- 1.1. This Annex describes the procedure for the type 3 test verifying emissions of crankcase gases as described in section 5.3.3. of UN/ECE Regulation No 83.

2. GENERAL REQUIREMENTS

- 2.1. The general requirements for conducting the type 3 test shall be those set out in sections 1 and 2 of Annex 6 to UN/ECE Regulation No 83, with the exceptions set out in points 2.2 and 2.3 below.
- 2.2. Reference to the Type I test in paragraph 2.1. of Annex 6 to UN/ECE Regulation No 83 shall be understood as referring to the Type 1 test in Annex XXI to this Regulation.
- 2.3. The road load coefficients to be used shall be those for VL. If VL low does not exist the VH road load shall be used.

3. TECHNICAL REQUIREMENTS

- 3.1. The technical requirements shall be those set out in section 3 to 6 of Annex 6 to UN/ECE Regulation No 83, with the exception set out in point 3.2 below.
- 3.2. References to the Type I test in paragraph 3.2. of Annex 6 to UN/ECE Regulation No 83 shall be understood as referring to the Type 1 test in Annex XXI to this Regulation.

ANNEX VI

DETERMINATION OF EVAPORATIVE EMISSIONS(TYPE 4 TEST)

1. INTRODUCTION

- 1.1. This Annex describes the procedure for the Type 4 test, which determines the emission of hydrocarbons by evaporation from the fuel systems of vehicles with positive ignition engines.

2. TECHNICAL REQUIREMENTS

2.1. Introduction

The procedure includes the evaporative emissions test and two additional tests, one for the aging of the carbon canister, as described in point 5.1, and one for the permeability of the fuel storage system, as described in point 5.2.

Status: Point in time view as at 01/06/2017.

Changes to legislation: There are outstanding changes not yet made to Commission Regulation (EU) 2017/1151. Any changes that have already been made to the legislation appear in the content and are referenced with annotations. (See end of Document for details)

The evaporative emissions test (Figure VI.1) is designed to determine hydrocarbon evaporative emissions as a consequence of diurnal temperatures fluctuation, hot soaks during parking, and urban driving.

2.2 The evaporative emissions test consists of:

- (a) Test drive including an urban (Part One) and an extra-urban (Part Two) driving cycle, followed by two urban (Part One) driving cycles,
- (b) Hot soak loss determination,
- (c) Diurnal loss determination.

The mass emissions of hydrocarbons from the hot soak and the diurnal loss phases are added up together with the permeability factor to provide an overall result for the test.

3. VEHICLE AND FUEL

3.1. Vehicle

3.1.1. The vehicle shall be in good mechanical condition and have been run in and driven at least 3 000 km before the test. For the purpose of the determination of evaporative emissions, the mileage and the age of the vehicle used for certification shall be recorded. The evaporative emission control system shall be connected and have been functioning correctly over the run in period and the carbon canister(s) shall have been subject to normal use, neither undergoing abnormal purging nor abnormal loading. The carbon canister(s) aged according to the procedure set out in paragraph 5.1 shall be connected as described in Figure VI.1.

3.2. Fuel

3.2.1. The Type 1 E10 reference fuel specified in Annex IX of this Regulation shall be used. For the purposes of this Regulation, E10 reference shall mean the Type 1 reference fuel, except for the canister aging, as set out in point 5.1.

4. TEST EQUIPMENT FOR EVAPORATIVE TEST

4.1. Chassis dynamometer

The chassis dynamometer shall meet the requirements of Appendix 1 of Annex 4a to UN/ECE Regulation No 83.

4.2. Evaporative emission measurement enclosure

The evaporative emission measurement enclosure shall meet the requirements of paragraph 4.2. of Annex 7 to UN/ECE Regulation No 83.

Figure VI.1

Determination of evaporative emissions

3 000 km run-in period (no excessive purge/load)

Use of aged of canister(s)

Steam-clean of vehicle (if necessary)

Reducing or removing non-fuel background emission sources (if agreed)

Status: Point in time view as at 01/06/2017.

Changes to legislation: There are outstanding changes not yet made to Commission Regulation (EU) 2017/1151. Any changes that have already been made to the legislation appear in the content and are referenced with annotations. (See end of Document for details)

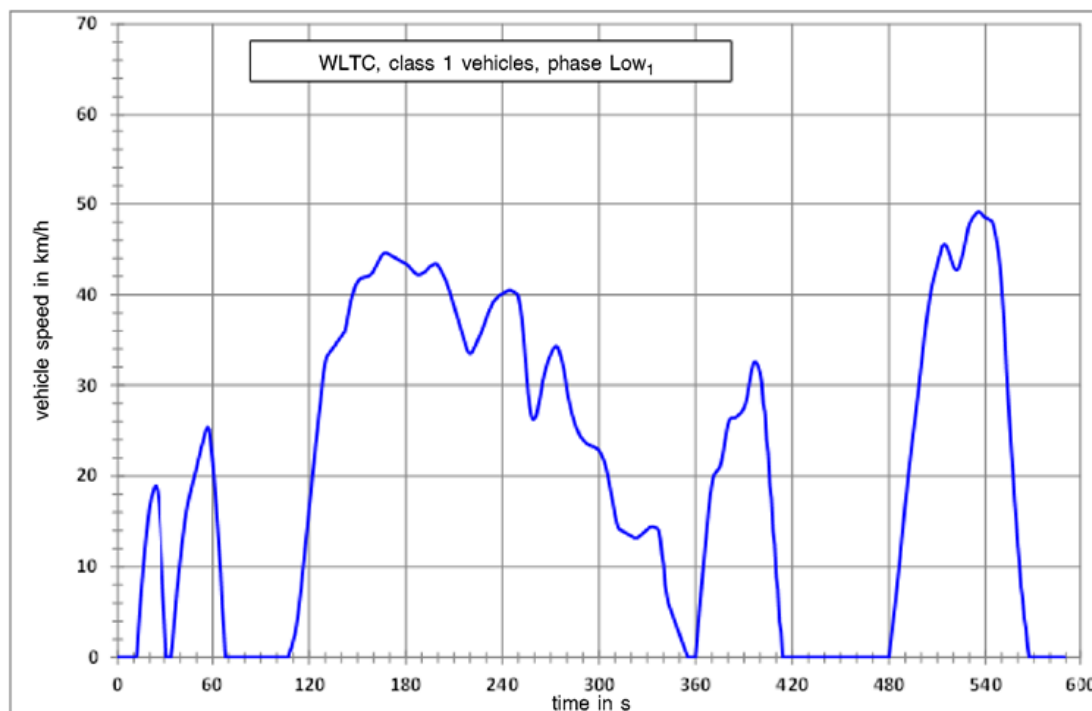

Notes:

1. Evaporative emission control families – as in paragraph 3.2 of Annex I
2. Exhaust emissions may be measured during Type 1 test drive but these are not used for legislative purposes. Exhaust emission legislative test remains separate.

4.3. Analytical systems

The analytical systems shall meet the requirements of paragraph 4.3. of Annex 7 to UN/ECE Regulation No 83.

4.4. Temperature recording

The temperature recording shall meet the requirements of paragraph 4.5. of Annex 7 to UN/ECE Regulation No 83.

4.5. Pressure recording

The pressure recording shall meet the requirements of paragraph 4.6. of Annex 7 to UN/ECE Regulation No 83.

4.6. Fans

The fans shall meet the requirements of paragraph 4.7. of Annex 7 to UN/ECE Regulation No 83.

4.7. Gases

The gases shall meet the requirements of paragraph 4.8. of Annex 7 to UN/ECE Regulation No 83.

4.8. Additional Equipment

Status: Point in time view as at 01/06/2017.

Changes to legislation: There are outstanding changes not yet made to Commission Regulation (EU) 2017/1151. Any changes that have already been made to the legislation appear in the content and are referenced with annotations. (See end of Document for details)

The additional equipment shall meet the requirements of paragraph 4.9. of Annex 7 to UN/ECE Regulation No 83.

5. TEST PROCEDURE

5.1. Canister(s) bench aging

Before performing the hot soak and diurnal losses sequences, the canister(s) must be aged according to the following procedure described in Figure VI.2.

Figure VI.2

Canister bench aging procedure

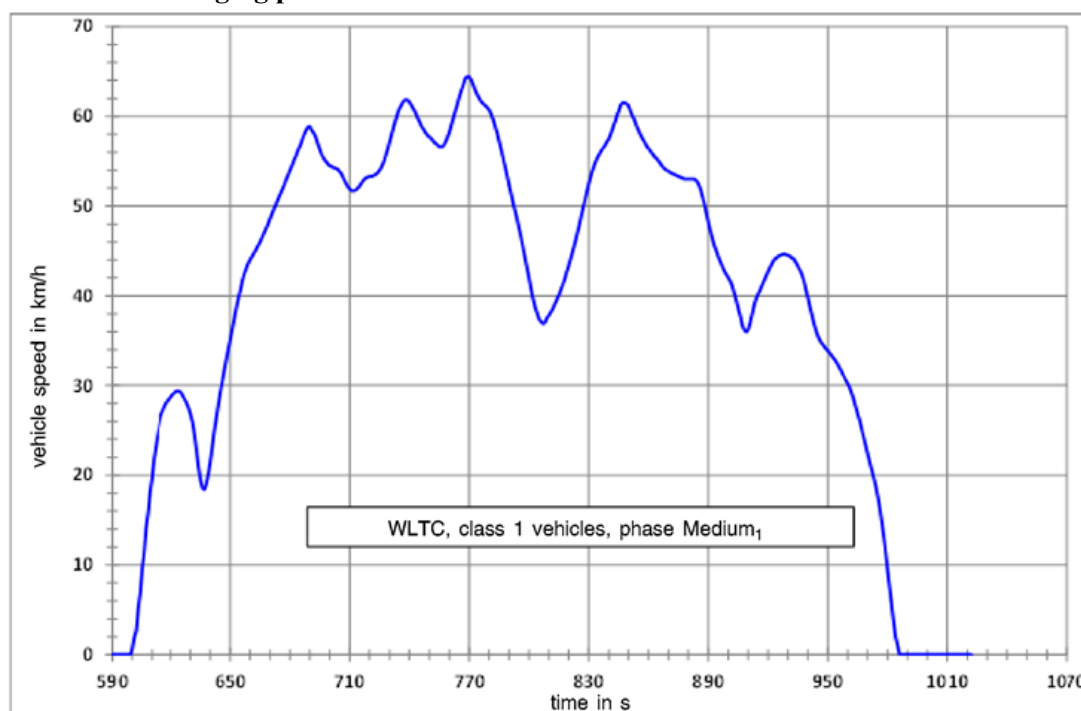

5.1.1. Temperature conditioning test

In a dedicated temperature chamber, the canister(s) is (are) cycled between temperatures from -15°C to 60°C , with 30 min of stabilisation at -15°C and 60°C . Each cycle shall last 210 min as in Figure 3. The temperature gradient shall be as close as possible to $1^{\circ}\text{C}/\text{min}$. No forced air flow should pass through the canister(s).

The cycle is repeated 50 times consecutively. In total, this operation will last 175 hours.

Figure VI.3

Status: Point in time view as at 01/06/2017.

Changes to legislation: There are outstanding changes not yet made to Commission Regulation (EU) 2017/1151. Any changes that have already been made to the legislation appear in the content and are referenced with annotations. (See end of Document for details)

Temperature conditioning cycle

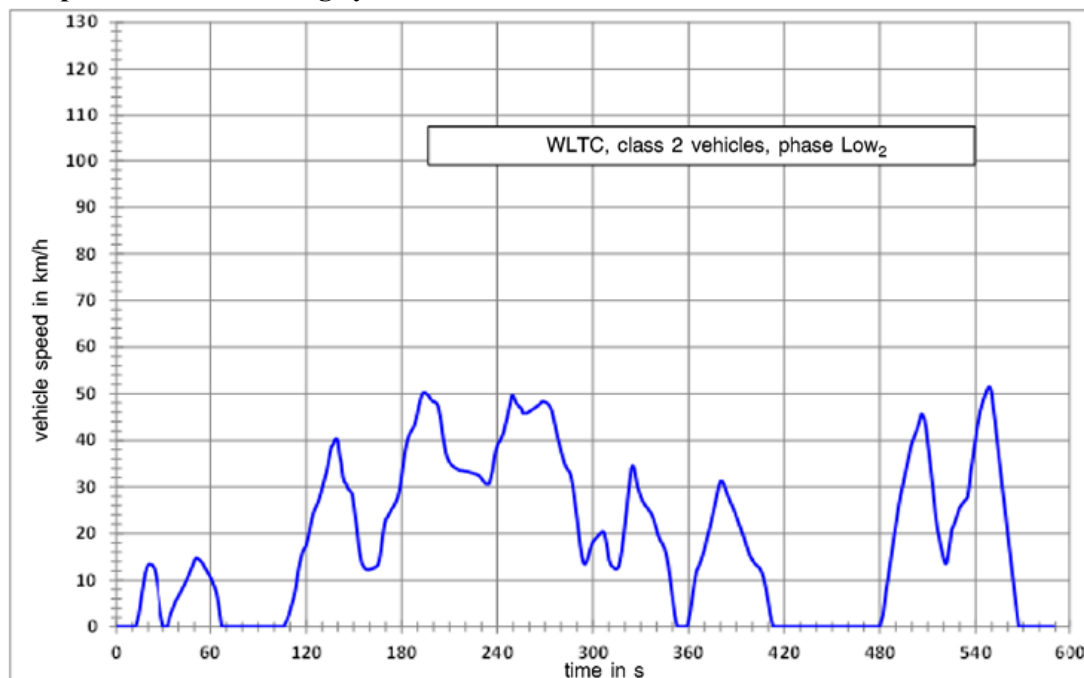

5.1.2. Canister vibration conditioning test

After the temperature aging procedure, the canister(s) is (are) shaken along the vertical axis with the canister(s) mounted as per its orientation in the vehicle with overall Grms⁽²⁷⁾ > 1.5m/sec² with frequency of 30 ± 10 Hz. The test shall last 12 hours.

5.1.3. Canister Fuel aging test

5.1.3.1. Fuel Aging for 300 cycles

5.1.3.1.1. After the temperature conditioning test and vibration test, the canister(s) is aged with a mixture of Type 1 E10 market fuel as specified in point 5.1.3.1.1.1 below and nitrogen or air with a 50 ± 15 percent fuel vapour volume. The fuel vapour fill rate must be kept between 60 ± 20 g/h.

The canister(s) is (are) loaded to the corresponding breakthrough. Breakthrough shall be considered as the point at which the cumulative quantity of hydrocarbons emitted is equal to 2 grams. As an alternative, the loading is deemed completed when the equivalent concentration level at the vent hole reaches 3 000 ppm.

5.1.3.1.1. The E10 market fuel used for this test shall fulfil the same requirements as an E10 reference fuel for the following points:

Density at 15 °C

- Vapour Pressure (DVPE)
- Distillation (evaporates only)
- Hydrocarbon analysis (olefins, aromatics, benzene only)
- Oxygen content
- Ethanol content

Status: Point in time view as at 01/06/2017.

Changes to legislation: There are outstanding changes not yet made to Commission Regulation (EU) 2017/1151. Any changes that have already been made to the legislation appear in the content and are referenced with annotations. (See end of Document for details)

5.1.3.1.2. The canister(s) shall be purged according the procedure of paragraph 5.1.3.8. of Annex 7 to UN/ECE Regulation No 83.

The canister must be purged between 5 minutes to 1 hour maximum after loading.

5.1.3.1.3. The steps of the procedure set out in points 5.1.3.1.1. and 5.1.3.1.2. shall be repeated 50 times, followed by a measurement of the Butane Working Capacity (BWC), meant as the ability of an activated carbon canister to absorb and desorb butane from dry air under specified conditions, in 5 butane cycles, as described in point 5.1.3.1.4 below. The fuel vapour ageing will continue until 300 cycles are reached. A measurement of the BWC in 5 butane cycles, as set out in point 5.1.3.1.4, will be made after the 300 cycles.

5.1.3.1.4. After 50 and 300 Fuel aging cycles, a measurement of BWC is performed. This measurement consists of loading the canister according to paragraph 5.1.6.3., of Annex 7 to UN/ECE Regulation No 83 until breakthrough. The BWC is recorded.

Then, the canister(s) shall be purged according the procedure of paragraph 5.1.3.8. of Annex 7 to UN/ECE Regulation No 83.

The canister must be purged between 5 minutes to 1 hour maximum after loading.

The operation of butane loading is repeated 5 times. The BWC is recorded after each butane loading step. The BWC₅₀ is calculated as the average of the 5 BWC and recorded.

In total, the canister(s) will be aged with 300 fuel aging cycles + 10 butane cycles and considered to be stabilized.

5.1.3.2. If the canister(s) is (are) provided by the Suppliers, the Manufacturers shall inform in advance the Type Approval Authorities to allow them to witness any part of the aging in the Supplier's facilities.

5.1.3.3. The manufacturer shall provide to the Type Approval Authorities a test report including at least the following elements:

- Type of activated carbon,
- Loading rate,
- Fuel specifications,
- BWC measurements

5.2. Determination of the Permeability Factor of the Fuel System (Figure VI.4)

Figure VI.4

Status: Point in time view as at 01/06/2017.

Changes to legislation: There are outstanding changes not yet made to Commission Regulation (EU) 2017/1151. Any changes that have already been made to the legislation appear in the content and are referenced with annotations. (See end of Document for details)

Determination of the Permeability Factor

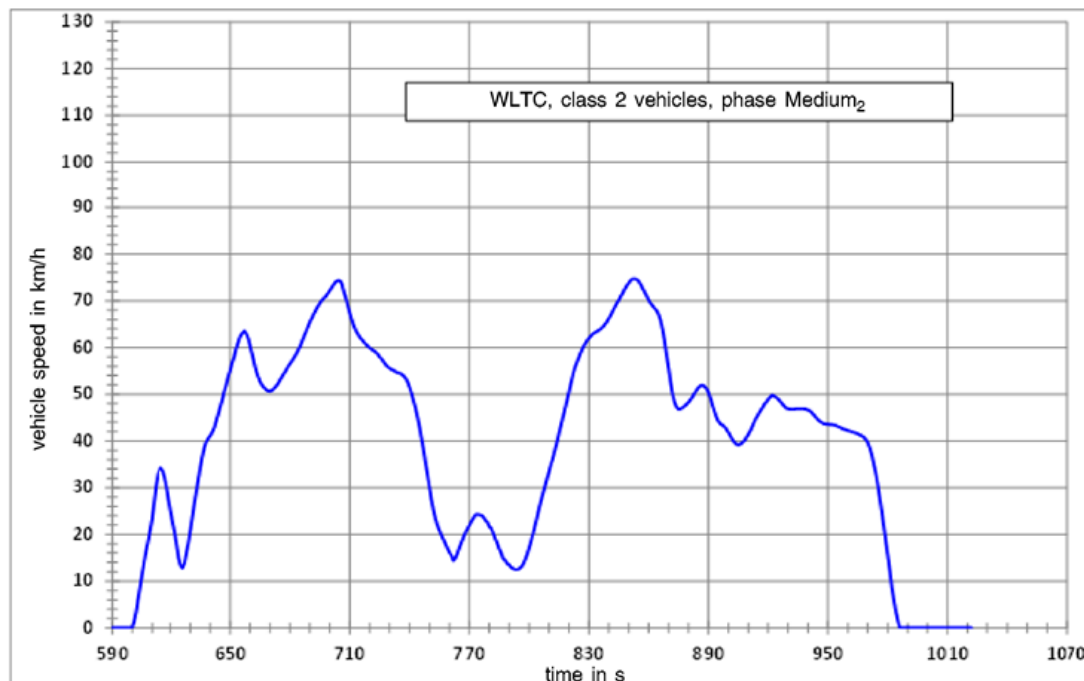

The fuel storage system representative of a family is selected and fixed to a rig, then soaked with E10 reference fuel for 20 weeks at $40\text{ °C} \pm 2\text{ °C}$. The orientation of the fuel storage system on the rig has to be similar to the original orientation on the vehicle.

- 5.2.1. The tank is filled with fresh E10 reference fuel at a temperature of $18\text{ °C} \pm 8\text{ °C}$. The tank is filled at $40 \pm 2\%$ of the nominal tank capacity. Then, the rig with the fuel system is placed in a specific and secure room with a controlled temperature of $40\text{ °C} \pm 2\text{ °C}$ for 3 weeks.
- 5.2.2. At the end of the 3rd week, the tank is drained and refilled with fresh E10 reference fuel at a temperature of $18\text{ °C} \pm 8\text{ °C}$ at $40 \pm 2\%$ of the nominal tank capacity.

Within 6 to 36 hours, the last 6h at $20\text{ °C} \pm 2\text{ °C}$ the rig with the fuel system is placed in a VT-SHED a diurnal procedure is performed over a period of 24 hours, according to the procedure described according to paragraph 5.7. of Annex 7 of UN/ECE Regulation No 83. The fuel system is vented to the outside of the VT-SHED to eliminate the possibility of the tank venting emissions being counted as permeation. The HC emissions are measured and the value is recorded as $\text{HC}_{3\text{W}}$.

- 5.2.3. The rig with the fuel system is placed again in a specific and secure room with a controlled temperature of $40\text{ °C} \pm 2\text{ °C}$ for the remaining 17 weeks.
- 5.2.4. At the end of the remaining 17th week, the tank is drained and refilled with fresh reference fuel at a temperature of $18\text{ °C} \pm 8\text{ °C}$ at $40 \pm 2\%$ of the nominal tank capacity.

Within 6 to 36 hours, the last 6h at $20\text{ °C} \pm 2\text{ °C}$, the rig with the fuel system is placed in a VT-SHED a diurnal procedure is performed over a period of 24 hours, according to the procedure described according to paragraph 5.7. Annex 7 of UN/ECE Regulation No 83. The fuel system is vented to the outside of the VT-SHED to eliminate the possibility of the tank venting emissions

Status: Point in time view as at 01/06/2017.

Changes to legislation: There are outstanding changes not yet made to Commission Regulation (EU) 2017/1151. Any changes that have already been made to the legislation appear in the content and are referenced with annotations. (See end of Document for details)

being counted as permeation. The HC emissions are measured and the value is recorded as HC_{20W}.

- 5.2.5. The Permeability Factor is the difference between HC_{20W} and HC_{3W} in g/24h with 3 digits.
- 5.2.6. If the Permeability Factor is determined by the Suppliers, the Manufacturers shall inform in advance the Type Approval Authorities to allow witness check in Supplier's facilities.
- 5.2.7. The manufacturer shall provide to the Type Approval Authorities a test report containing at least the following elements:
- (a) A full description of the fuel storage system tested, including information on the type of tank tested, whether the tank is monolayer or multilayer and which types of materials are used for the tank and other parts of the fuel storage system,
 - (b) the weekly mean temperatures at which the ageing was performed,
 - (c) the HC measured at week 3 (HC_{3W}),
 - (d) the HC measured at week 20 (HC_{20W})
 - (e) the resulting Permeability Factor (PF)
- 5.2.8. As an exception to points 5.2.1 to 5.2.7 above, the Manufacturers using multilayer tanks may choose to use the following assigned permeability factor (APF) instead of the complete measurement procedure mentioned above:

APF multilayer tank = 120 mg/24h

- 5.2.8.1 Where the manufacturer chooses to use Assigned Permeability Factors, the manufacturer shall provide to the Type Approval Authority, a declaration in which the type of tank is clearly specified, as well as a declaration of the type of materials used.

5.3. Sequence of measurement of hot soak and diurnal losses

The vehicle is prepared in accordance to paragraph 5.1.1. and 5.1.2. of Annex 7 of UN/ECE Regulation No 83. At the request of the manufacturer and with the approval of the approval authority, non-fuel background emission sources may be removed or reduced before testing (e.g. baking tire or vehicle, removing washer fluid).

5.3.1. Soak

The vehicle is parked for a minimum of 12 hours and a maximum of 36 hours in the soak area. The engine oil and coolant temperatures shall have reached the temperature of the area or within ± 3 C of it at the end of the period.

5.3.2. Fuel drain and refill

The fuel drain and refill is performed in accordance to the procedure of paragraph 5.1.7. of Annex 7 of UN/ECE Regulation No 83.

5.3.3. Preconditioning drive

Within one hour from the completing of fuel drain and refill, the vehicle is placed on the chassis dynamometer and driven through one Part One and two Part Two driving cycles of Type I according to Annex 4a to UN/ECE Regulation No 83.

Status: Point in time view as at 01/06/2017.

Changes to legislation: There are outstanding changes not yet made to Commission Regulation (EU) 2017/1151. Any changes that have already been made to the legislation appear in the content and are referenced with annotations. (See end of Document for details)

Exhaust emissions are not sampled during this operation.

5.3.4. Soak

Within five minutes of completing the preconditioning operation the vehicle is parked for a minimum of 12 hours and a maximum of 36 hours in the soak area. The engine oil and coolant temperatures shall have reached the temperature of the area or within ± 3 C of it at the end of the period.

5.3.5. Canister breakthrough

The canister(s) aged according to the sequence described in paragraph 5.1 is loaded to breakthrough according to the procedure paragraph 5.1.4 of Annex 7 to UN/ECE Regulation No 83.

5.3.6. Dynamometer test

5.3.6.1. Within one hour from completing of canister loading, the vehicle is placed on the chassis dynamometer and driven through one Part One and one Part Two driving cycles of Type I according to Annex 4a to UN/ECE Regulation No 83. Then the engine is shut off. Exhaust emissions may be sampled during this operation but the results shall not be used for the purpose of exhaust emission type approval.

5.3.6.2. Within two minutes of completing the Type I Test drive specified in point 5.3.6.1 the vehicle is driven a further conditioning drive consisting of two Part One test cycles (hot start) of Type I. Then the engine is shut off again. Exhaust emissions need not be sampled during this operation.

5.3.7. Hot Soak

After the Dynamometer test, hot soak evaporative emissions test is performed in accordance to paragraph 5.5 of Annex 7 to UN/ECE Regulation No 83. The hot soak losses result is calculated according to paragraph 6 of Annex 7 to UN/ECE Regulation No 83 and recorded as M_{HS} .

5.3.8. Soak

After hot soak evaporative emissions test, a soak is performed according to paragraph 5.6 of Annex 7 to UN/ECE Regulation No 83.

5.3.9. Diurnal test

5.3.9.1. After the soak, a first measurement of Diurnal Losses over 24 hours is performed according to paragraph 5.7 of Annex 7 to UN/ECE Regulation No 83. Emissions are calculated according to paragraph 6 of Annex 7 to UN/ECE Regulation No 83. The obtained value is recorded as M_{D1} .

5.3.9.2. After the first 24 hours diurnal test, a second measurement of Diurnal Losses over 24 hours is performed according to paragraph 5.7 of Annex 7 to UN/ECE Regulation No 83. Emissions are calculated according to paragraph 6 of Annex 7 to UN/ECE Regulation No 83. The obtained value is recorded as M_{D2} .

5.3.10. Calculation

The result of $M_{HS}+M_{D1}+M_{D2}+2PF$ shall be below the limit defined in Table 3 of Annex I to Regulation (EC) No 715/2007.

5.3.11 The manufacturer shall provide to the Type Approval Authorities a test report containing at least the following elements:

Status: Point in time view as at 01/06/2017.

Changes to legislation: There are outstanding changes not yet made to Commission Regulation (EU) 2017/1151. Any changes that have already been made to the legislation appear in the content and are referenced with annotations. (See end of Document for details)

- (a) description of the soak periods, including time and mean temperatures
- (b) description to aged canister used and reference to exact ageing report
- (c) mean temperature during the hot soak test
- (d) measurement during hot soak test, HSL
- (e) measurement of first diurnal, DL_{1st day}
- (f) measurement of second diurnal, DL_{2nd day}
- (g) final evaporative test result, calculated as "M_{HIS}+M_{D1}+M_{D2}+2PF"

ANNEX VII

VERIFYING THE DURABILITY OF POLLUTION CONTROL DEVICES(TYPE 5 TEST)

1. INTRODUCTION

1.1. This Annex describes the tests for verifying the durability of pollution control devices.

2. GENERAL REQUIREMENTS

2.1. The general requirements for conducting the type 5 test shall be those set out in Section 5.3.6. of UN/ECE Regulation No 83 with exceptions provided in sections 2.2. and 2.3 below.

2.2. The table in paragraph 5.3.6.2. and the text in paragraph 5.3.6.4. of UN/ECE Regulation No 83 shall be understood to be as follows:

Engine Category	Assigned deterioration factors						
	CO	THC	NMHC	NO _x	HC + NO _x	PM	P
Positive-ignition	1,5	1,3	1,3	1,6	—	1,0	1,0
Compression ignition	As there are no assigned deterioration factors for compression ignition vehicles, manufacturers shall use the whole vehicle or bench ageing durability test procedures to establish deterioration factors.						

2.3. The reference to the requirements of paragraphs 5.3.1 and 8.2 in paragraph 5.3.6.5 of UN/ECE Regulation No 83 shall be understood as reference to the requirements of Annex XXI and Section 4.2 of Annex I to this Regulation during the useful life of the vehicle.

2.4. Before emission limits set out in Table 2 of Annex I to Regulation (EC) No 715/2007 are used for assessing compliance with the requirements referred to in paragraph 5.3.6.5 of UN/ECE Regulation No 83 the deterioration factors shall be calculated and applied, as described in Table A7/1 of Sub-Annex 7 and Table A8/5 of Sub-Annex 8 to Annex XXI.

3. TECHNICAL REQUIREMENTS

Status: Point in time view as at 01/06/2017.

Changes to legislation: There are outstanding changes not yet made to Commission Regulation (EU) 2017/1151. Any changes that have already been made to the legislation appear in the content and are referenced with annotations. (See end of Document for details)

- 3.1. The technical requirements and specifications shall be those set out in sections 1 to 7 and Appendices 1, 2 and 3 of Annex 9 to UN/ECE Regulation No 83, with the exceptions set out in sections 3.2. to 3.10.
- 3.2. Reference to Annex 2 in paragraph 1.5. of Annex 9 to UN/ECE Regulation No 83 shall be understood as referring to Appendix 4 to Annex I to this Regulation.
- 3.3. Reference to the emissions limits set out in Table 1 in paragraph 1.6. of Annex 9 to UN/ECE Regulation No 83 shall be understood as referring to the emissions limits set out in Table 2 of Annex I to Regulation (EC) No 715/2007.
- 3.4. The references to the Type I test in paragraph 2.3.1.7 of Annex 9 of UN/ECE Regulation No 83 shall be understood as reference to the Type 1 test in Annex XXI to this Regulation.
- 3.5. The references to the Type I test in paragraph 2.3.2.6 of Annex 9 of UN/ECE Regulation No 83 shall be understood as reference to the Type 1 test in Annex XXI to this Regulation.
- 3.6. The references to the Type I test in paragraph 3.1 of Annex 9 of UN/ECE Regulation No 83 shall be understood as reference to the Type 1 test in Annex XXI to this Regulation.
- 3.7. The reference to paragraph 5.3.1.4. in the first section of paragraph 7 of Annex 9 of UN/ECE Regulation No 83 shall be understood as reference to Table 2 of Annex I of the Regulation (EC) No 715/2007.
- 3.8. The reference in paragraph 6.3.1.2 of Annex 9 to UN/ECE Regulation No 83 to the methods in Appendix 7 to Annex 4a shall be understood as being a reference to Sub-Annex 4 to Annex XXI to this Regulation.
- 3.9. The reference in paragraph 6.3.1.4 of Annex 9 to UN/ECE Regulation No 83 to Annex 4a shall be understood as being a reference to Sub-Annex 4 to Annex XXI to this Regulation.
- 3.10. The road load coefficients to be used shall be those for VL. If VL low does not exist the VH road load shall be used.

ANNEX VIII

VERIFYING THE AVERAGE EMISSIONS AT LOW AMBIENT TEMPERATURES (TYPE 6 TEST)

1. INTRODUCTION
 - 1.1. This Annex describes the equipment required and the procedure for the Type 6 test in order to verify the emissions at cold temperatures.
2. GENERAL REQUIREMENTS
 - 2.1. The general requirements for the Type 6 test are those set out in section 5.3.5 of UN/ECE Regulation No 83 with the exception specified in section 2.2 below.
 - 2.2. The limit values referred to in paragraph 5.3.5.2 of UN/ECE Regulation No 83 relate to the limit values set out in Annex 1, Table 4, to Regulation (EC) No 715/2007.

Status: Point in time view as at 01/06/2017.

Changes to legislation: There are outstanding changes not yet made to Commission Regulation (EU) 2017/1151. Any changes that have already been made to the legislation appear in the content and are referenced with annotations. (See end of Document for details)

3. TECHNICAL REQUIREMENTS

- 3.1. The technical requirements and specifications are those set out in section 2 to 6 of Annex 8 to UN/ECE Regulation No 83 with the exception specified in section 3.2 below.
- 3.2. The reference to paragraph 2 of Annex 10 in paragraph 3.4.1 of Annex 8 to UN/ECE Regulation No 83 shall be understood as reference to Section B of Annex IX to this Regulation.
- 3.3. The road load coefficients to be used shall be those for VL. If VL low does not exist the VH road load shall be used.

ANNEX IX

SPECIFICATIONS OF REFERENCE FUELS

A. REFERENCE FUELS

1. Technical data on fuels for testing vehicles with positive-ignition engines

TYPE: PETROL (E10):

Parameter	Unit	Limits ^a		Test method
		Minimum	Maximum	
Research octane number, RON ^b		95,0	98,0	EN ISO 5164
Motor octane number, MON ^c		85,0	89,0	EN ISO 5163
Density at 15 C	kg/m ³	743,0	756,0	EN ISO 12185
Vapour pressure (DVPE)	kPa	56,0	60,0	EN 13016-1
Water content	% v/v		0,05	EN 12937
Appearance at – 7 C		Clear and bright		
Distillation:				
— evaporated at 70 C	% v/v	34,0	46,0	EN ISO 3405
— evaporated at 100 C	% v/v	54,0	62,0	EN ISO 3405
— evaporated at 150 C	% v/v	86,0	94,0	EN ISO 3405

Status: Point in time view as at 01/06/2017.

Changes to legislation: There are outstanding changes not yet made to Commission Regulation (EU) 2017/1151. Any changes that have already been made to the legislation appear in the content and are referenced with annotations. (See end of Document for details)

—	final boiling point	°C	170	195	EN ISO 3405
	Residue	% v/v	—	2,0	EN ISO 3405
	Hydrocarbon analysis:				
—	olefins	% v/v	6,0	13,0	EN 22854
—	aromatics	% v/v	25,0	32,0	EN 22854
—	benzene	% v/v	—	1,00	EN 22854 EN 238
—	saturates	% v/v	report		EN 22854
	Carbon/hydrogen ratio		report		
	Carbon/oxygen ratio		report		
	Induction Period ^d	minutes	480	—	EN ISO 7536
	Oxygen content ^e	% m/m	3,3	3,7	EN 22854
	Solvent washed gum (Existent gum content)	mg/100 ml	—	4	EN ISO 6246
	Sulphur content ^f	mg/kg	—	10	EN ISO 20846 EN ISO 20884
	Copper corrosion 3 hrs, 50 C		—	class 1	EN ISO 2160
	Lead content	mg/l	—	5	EN 237
	Phosphorus content ^g	mg/l	—	1,3	ASTM D 3231
	Ethanol ^h	% v/v	9,0	10,0	EN 22854

a The values quoted in the specifications are 'true values'. In establishment of their limit values the terms of ISO 4259 Petroleum products - Determination and application of precision data in relation to methods of test have been applied and in fixing a minimum value, a minimum difference of 2R above zero has been taken into account; in fixing a maximum and minimum value, the minimum difference is 4R (R = reproducibility). Notwithstanding this measure, which is necessary for technical reasons, the manufacturer of fuels shall nevertheless aim at a zero value where the stipulated maximum value is 2R and at the mean value in the case of quotations of maximum and minimum limits. Should it be necessary to clarify whether a fuel meets the requirements of the specifications, the terms of ISO 4259 shall be applied.

b A correction factor of 0,2 for MON and RON shall be subtracted for the calculation of the final result in accordance with EN 228:2008.

c A correction factor of 0,2 for MON and RON shall be subtracted for the calculation of the final result in accordance with EN 228:2008.

Status: Point in time view as at 01/06/2017.

Changes to legislation: There are outstanding changes not yet made to Commission Regulation (EU) 2017/1151. Any changes that have already been made to the legislation appear in the content and are referenced with annotations. (See end of Document for details)

d	The fuel may contain oxidation inhibitors and metal deactivators normally used to stabilise refinery gasoline streams, but detergent/dispersive additives and solvent oils shall not be added.
e	Ethanol is the only oxygenate that shall be intentionally added to the reference fuel. The Ethanol used shall conform to EN 15376.
f	The actual sulphur content of the fuel used for the Type 1 test shall be reported.
g	There shall be no intentional addition of compounds containing phosphorus, iron, manganese, or lead to this reference fuel.
h	Ethanol is the only oxygenate that shall be intentionally added to the reference fuel. The Ethanol used shall conform to EN 15376.

(²) Equivalent EN/ISO methods will be adopted when issued for properties listed above.

TYPE: ETHANOL (E85)

Parameter	Unit	Limits ^a		Test method ^b
		Minimum	Maximum	
Research octane number, RON		95	—	EN ISO 5164
Motor octane number, MON		85	—	EN ISO 5163
Density at 15 C	kg/m ³	Report		ISO 3675
Vapour pressure	kPa	40	60	EN ISO 13016-1 (DVPE)
Sulphur content ^{cd}	mg/kg	—	10	EN ISO 20846 EN ISO 20884
Oxidation stability	minutes	360		EN ISO 7536
Existent gum content (solvent washed)	mg/100ml	—	5	EN-ISO 6246
Appearance This shall be determined at ambient temperature or 15 C whichever is higher.		Clear and bright, visibly free of suspended or precipitated contaminants		Visual inspection
Ethanol and higher alcohols ^e	% (V/V)	83	85	EN 1601 EN 13132 EN 14517
Higher alcohols (C ₃ -C ₈)	% (V/V)	—	2	
Methanol	% (V/V)		0,5	
Petrol ^f	% (V/V)	Balance		EN 228

Status: Point in time view as at 01/06/2017.

Changes to legislation: There are outstanding changes not yet made to Commission Regulation (EU) 2017/1151. Any changes that have already been made to the legislation appear in the content and are referenced with annotations. (See end of Document for details)

Phosphorus	mg/l	0,3 ^g		ASTM D 3231
Water content	% (V/V)		0,3	ASTM E 1064
Inorganic chloride content	mg/l		1	ISO 6227
pHe		6,5	9	ASTM D 6423
Copper strip corrosion (3h at 50 C)	Rating	Class 1		EN ISO 2160
Acidity, (as acetic acid CH ₃ COOH)	% (m/m)	—	0,005	ASTM D 1613
	(mg/l)	—	40	
Carbon/hydrogen ratio		report		
Carbon/oxygen ration		report		

- a** The values quoted in the specifications are 'true values'. In establishment of their limit values the terms of ISO 4259 Petroleum products — Determination and application of precision data in relation to methods of test have been applied and in fixing a minimum value, a minimum difference of 2R above zero has been taken into account; in fixing a maximum and minimum value, the minimum difference is 4R (R = reproducibility). Notwithstanding this measure, which is necessary for technical reasons, the manufacturer of fuels shall nevertheless aim at a zero value where the stipulated maximum value is 2R and at the mean value in the case of quotations of maximum and minimum limits. Should it be necessary to clarify whether a fuel meets the requirements of the specifications, the terms of ISO 4259 shall be applied.
- b** In cases of dispute, the procedures for resolving the dispute and interpretation of the results based on test method precision, described in EN ISO 4259 shall be used.
- c** In cases of national dispute concerning sulphur content, either EN ISO 20846 or EN ISO 20884 shall be called up similar to the reference in the national annex of EN 228.
- d** The actual sulphur content of the fuel used for the Type 1 test shall be reported.
- e** Ethanol to meet specification of EN 15376 is the only oxygenate that shall be intentionally added to this reference fuel.
- f** The unleaded petrol content can be determined as 100 minus the sum of the percentage content of water and alcohols
- g** There shall be no intentional addition of compounds containing phosphorus, iron, manganese, or lead to this reference fuel.

TYPE: LPG

Parameter	Unit	Fuel A	Fuel B	Test method
Composition:				ISO 7941
C ₃ -content	% vol	30 ± 2	85 ± 2	
C ₄ -content	% vol	Balance	Balance	
< C ₃ , > C ₄	% vol	Maximum 2	Maximum 2	
Olefins	% vol	Maximum 12	Maximum 15	
Evaporation residue	mg/kg	Maximum 50	Maximum 50	prEN 15470

- a** This method may not accurately determine the presence of corrosive materials if the sample contains corrosion inhibitors or other chemicals which diminish the corrosivity of the sample to the copper strip. Therefore, the addition of such compounds for the sole purpose of biasing the test method is prohibited.

Status: Point in time view as at 01/06/2017.

Changes to legislation: There are outstanding changes not yet made to Commission Regulation (EU) 2017/1151. Any changes that have already been made to the legislation appear in the content and are referenced with annotations. (See end of Document for details)

Water at 0 C		Free	Free	prEN 15469
Total sulphur content	mg/kg	Maximum 10	Maximum 10	ASTM 6667
Hydrogen sulphide		None	None	ISO 8819
Copper strip corrosion	Rating	Class 1	Class 1	ISO 6251*
Odour		Characteristic	Characteristic	
Motor octane number		Minimum 89	Minimum 89	EN 589 Annex B

a This method may not accurately determine the presence of corrosive materials if the sample contains corrosion inhibitors or other chemicals which diminish the corrosivity of the sample to the copper strip. Therefore, the addition of such compounds for the sole purpose of biasing the test method is prohibited.

TYPE: NG/BIOMETHANE

Characteristics	Units	Basis	Limits		Test method
			minimum	maximum	
<i>Reference fuel G20</i>					
Composition:					
Methane	% mole	100	99	100	ISO 6974
Balance ^a	% mole	—	—	1	ISO 6974
N ₂	% mole				ISO 6974
Sulphur content	mg/m ^{3b}	—	—	10	ISO 6326-5
Wobbe Index (net)	MJ/m ^{3c}	48,2	47,2	49,2	
<i>Reference fuel G25</i>					
Composition:					
Methane	% mole	86	84	88	ISO 6974
Balance ^d	% mole	—	—	1	ISO 6974
N ₂	% mole	14	12	16	ISO 6974

a Inerts (different from N₂) + C₂ + C₂₊.

b Value to be determined at 293,2 K (20 C) and 101,3 kPa.

c Value to be determined at 273,2 K (0 C) and 101,3 kPa.

d Inerts (different from N₂) + C₂; + C₂₊.

e Value to be determined at 293,2 K (20 C) and 101,3 kPa.

f Value to be determined at 273,2 K (0 C) and 101,3 kPa.

Status: Point in time view as at 01/06/2017.

Changes to legislation: There are outstanding changes not yet made to Commission Regulation (EU) 2017/1151. Any changes that have already been made to the legislation appear in the content and are referenced with annotations. (See end of Document for details)

Sulphur content	mg/m ^{3e}	—	—	10	ISO 6326-5
Wobbe Index (net)	MJ/m ^{3f}	39,4	38,2	40,6	

a Inerts (different from N₂) + C₂ + C₂₊.

b Value to be determined at 293,2 K (20 C) and 101,3 kPa.

c Value to be determined at 273,2 K (0 C) and 101,3 kPa.

d Inerts (different from N₂) + C₂; + C₂₊.

e Value to be determined at 293,2 K (20 C) and 101,3 kPa.

f Value to be determined at 273,2 K (0 C) and 101,3 kPa.

TYPE: HYDROGEN FOR INTERNAL COMBUSTION ENGINES

Characteristics	Units	Limits		Test method
		minimum	maximum	
Hydrogen purity	% mole	98	100	ISO 14687-1
Total hydrocarbon	µmol/mol	0	100	ISO 14687-1
Water ^a	µmol/mol	0	^b	ISO 14687-1
Oxygen	µmol/mol	0	^c	ISO 14687-1
Argon	µmol/mol	0	^d	ISO 14687-1
Nitrogen	µmol/mol	0	^e	ISO 14687-1
CO	µmol/mol	0	1	ISO 14687-1
Sulphur	µmol/mol	0	2	ISO 14687-1
Permanent particulates ^f				ISO 14687-1

a Not to be condensed.

b Combined water, oxygen, nitrogen and argon: 1,900 µmol/mol.

c Combined water, oxygen, nitrogen and argon: 1,900 µmol/mol.

d Combined water, oxygen, nitrogen and argon: 1,900 µmol/mol.

e Combined water, oxygen, nitrogen and argon: 1,900 µmol/mol.

f The hydrogen shall not contain dust, sand, dirt, gums, oils, or other substances in an amount sufficient to damage the fuelling station equipment or the vehicle (engine) being fuelled.

2. Technical data on fuels for testing vehicles with compression ignition engines

TYPE: DIESEL (B7):

Parameter	Unit	Limits ^a		Test method
		Minimum	Maximum	
Cetane Index		46,0		EN ISO 4264

Status: Point in time view as at 01/06/2017.

Changes to legislation: There are outstanding changes not yet made to Commission Regulation (EU) 2017/1151. Any changes that have already been made to the legislation appear in the content and are referenced with annotations. (See end of Document for details)

Cetane number ^b		52,0	56,0	EN ISO 5165
Density at 15 C	kg/m ³	833,0	837,0	EN ISO 12185
Distillation:				
— 50 % point	°C	245,0	—	EN ISO 3405
— 95 % point	°C	345,0	360,0	EN ISO 3405
— final boiling point	°C	—	370,0	EN ISO 3405
Flash point	°C	55	—	EN ISO 2719
Cloud point	°C	—	– 10	EN 23015
Viscosity at 40 C	mm ² /s	2,30	3,30	EN ISO 3104
Polycyclic aromatic hydrocarbons	% m/m	2,0	4,0	EN 12916
Sulphur content	mg/kg	—	10,0	EN ISO 20846 EN ISO 20884
Copper corrosion 3 hrs, 50 C		—	Class 1	EN ISO 2160
Conradson carbon residue (10 % DR)	% m/m	—	0,20	EN ISO 10370
Ash content	% m/m	—	0,010	EN ISO 6245
Total contamination	mg/kg	—	24	EN 12662
Water content	mg/kg	—	200	EN ISO 12937
Acid number	mg KOH/g	—	0,10	EN ISO 6618
Lubricity (HFRR wear scan diameter at 60 C)	µm	—	400	EN ISO 12156
Oxidation stability at 110 C ^c	h	20,0		EN 15751
FAME ^d	% v/v	6,0	7,0	EN 14078

a The values quoted in the specifications are 'true values'. In establishment of their limit values the terms of ISO 4259 Petroleum products – Determination and application of precision data in relation to methods of test have been applied and in fixing a minimum value, a minimum difference of 2R above zero has been taken into account; in fixing a maximum and minimum value, the minimum difference is 4R (R = reproducibility). Notwithstanding this measure, which is necessary for technical reasons, the manufacturer of fuels shall nevertheless aim at a zero value where the stipulated

Status: Point in time view as at 01/06/2017.

Changes to legislation: There are outstanding changes not yet made to Commission Regulation (EU) 2017/1151. Any changes that have already been made to the legislation appear in the content and are referenced with annotations. (See end of Document for details)

maximum value is 2R and at the mean value in the case of quotations of maximum and minimum limits. Should it be necessary to clarify whether a fuel meets the requirements of the specifications, the terms of ISO 4259 shall be applied.

- b** The range for cetane number is not in accordance with the requirements of a minimum range of 4R. However, in the case of a dispute between fuel supplier and fuel user, the terms of ISO 4259 may be used to resolve such disputes provided replicate measurements, of sufficient number to archive the necessary precision, are made in preference to single determinations.
- c** Even though oxidation stability is controlled, it is likely that shelf life will be limited. Advice shall be sought from the supplier as to storage conditions and life.
- d** FAME content to meet the specification of EN 14214.

3. Technical data on fuels for testing fuel cell vehicles

TYPE: HYDROGEN FOR FUEL CELL VEHICLES

Characteristics	Units	Limits		Test method
		minimum	maximum	
Hydrogen fuel ^a	% mole	99,99	100	ISO 14687-2
Total gases ^b	µmol/mol	0	100	
Total hydrocarbon	µmol/mol	0	2	ISO 14687-2
Water	µmol/mol	0	5	ISO 14687-2
Oxygen	µmol/mol	0	5	ISO 14687-2
Helium (He), Nitrogen (N ₂), Argon (Ar)	µmol/mol	0	100	ISO 14687-2
CO ₂	µmol/mol	0	2	ISO 14687-2
CO	µmol/mol	0	0,2	ISO 14687-2
Total sulphur compounds	µmol/mol	0	0,004	ISO 14687-2
Formaldehyde (HCHO)	µmol/mol	0	0,01	ISO 14687-2
Formic acid (HCOOH)	µmol/mol	0	0,2	ISO 14687-2
Ammonia (NH ₃)	µmol/mol	0	0,1	ISO 14687-2
Total halogenated compounds	µmol/mol	0	0,05	ISO 14687-2
Particulates size	µm	0	10	ISO 14687-2

a The hydrogen fuel index is determined by subtracting the total content of non-hydrogen gaseous constituents listed in the table (Total gases), expressed in mole percent, from 100 mole percent. It is less than the sum of the maximum allowable limits of all non-hydrogen constituents shown in the Table.

b The value of total gases is summation of the values of the non-hydrogen constituents listed in the table, except the particulates.

Status: Point in time view as at 01/06/2017.

Changes to legislation: There are outstanding changes not yet made to Commission Regulation (EU) 2017/1151. Any changes that have already been made to the legislation appear in the content and are referenced with annotations. (See end of Document for details)

Particulates concentration	µg/l	0	1	ISO 14687-2
<p>a The hydrogen fuel index is determined by subtracting the total content of non-hydrogen gaseous constituents listed in the table (Total gases), expressed in mole percent, from 100 mole percent. It is less than the sum of the maximum allowable limits of all non-hydrogen constituents shown in the Table.</p> <p>b The value of total gases is summation of the values of the non-hydrogen constituents listed in the table, except the particulates.</p>				

B. REFERENCE FUELS FOR TESTING EMISSIONS AT LOW AMBIENT TEMPERATURES — TYPE 6 TEST

TYPE: PETROL (E10):

Parameter	Unit	Limits ^a		Test method
		Minimum	Maximum	
Research octane number, RON ^b		95,0	98,0	EN ISO 5164
Motor octane number, MON ^c		85,0	89,0	EN ISO 5163
Density at 15 C	kg/m ³	743,0	756,0	EN ISO 12185
Vapour pressure (DVPE)	kPa	56,0	95,0	EN 13016-1
Water content		max 0,05 % v/v Appearance at – 7 C: clear and bright		EN 12937
Distillation:				
— evaporated at 70 C	% v/v	34,0	46,0	EN ISO 3405
— evaporated at 100 C	% v/v	54,0	62,0	EN ISO 3405
— evaporated at 150 C	% v/v	86,0	94,0	EN ISO 3405
— final boiling point	°C	170	195	EN ISO 3405
Residue	% v/v	—	2,0	EN ISO 3405
Hydrocarbon analysis:				
— olefins	% v/v	6,0	13,0	EN 22854

Status: Point in time view as at 01/06/2017.

Changes to legislation: There are outstanding changes not yet made to Commission Regulation (EU) 2017/1151. Any changes that have already been made to the legislation appear in the content and are referenced with annotations. (See end of Document for details)

—	aromatics	% v/v	25,0	32,0	EN 22854
—	benzene	% v/v	—	1,00	EN 22854 EN 238
—	saturates	% v/v	report		EN 22854
	Carbon/ hydrogen ratio		report		
	Carbon/oxygen ratio		report		
	Induction Period ^d	minutes	480	—	EN ISO 7536
	Oxygen content ^e	% m/m	3,3	3,7	EN 22854
	Solvent washed gum (Existent gum content)	mg/100 ml	—	4	EN ISO 6246
	Sulphur content ^f	mg/kg	—	10	EN ISO 20846 EN ISO 20884
	Copper corrosion 3 hrs, 50 C		—	class 1	EN ISO 2160
	Lead content	mg/l	—	5	EN 237
	Phosphorus content ^g	mg/l	—	1,3	ASTM D 3231
	Ethanol ^h	% v/v	9,0	10,0	EN 22854

a The values quoted in the specifications are 'true values'. In establishment of their limit values the terms of ISO 4259 Petroleum products - Determination and application of precision data in relation to methods of test have been applied and in fixing a minimum value, a minimum difference of 2R above zero has been taken into account; in fixing a maximum and minimum value, the minimum difference is 4R (R = reproducibility). Notwithstanding this measure, which is necessary for technical reasons, the manufacturer of fuels shall nevertheless aim at a zero value where the stipulated maximum value is 2R and at the mean value in the case of quotations of maximum and minimum limits. Should it be necessary to clarify whether a fuel meets the requirements of the specifications, the terms of ISO 4259 shall be applied.

b A correction factor of 0,2 for MON and RON shall be subtracted for the calculation of the final result in accordance with EN 228:2008.

c A correction factor of 0,2 for MON and RON shall be subtracted for the calculation of the final result in accordance with EN 228:2008.

d The fuel may contain oxidation inhibitors and metal deactivators normally used to stabilise refinery gasoline streams, but detergent/dispersive additives and solvent oils shall not be added.

e Ethanol is the only oxygenate that shall be intentionally added to the reference fuel. The ethanol used shall conform to EN 15376.

f The actual sulphur content of the fuel used for the Type 6 test shall be reported.

g There shall be no intentional addition of compounds containing phosphorus, iron, manganese, or lead to this reference fuel.

h Ethanol is the only oxygenate that shall be intentionally added to the reference fuel. The ethanol used shall conform to EN 15376.

Status: Point in time view as at 01/06/2017.

Changes to legislation: There are outstanding changes not yet made to Commission Regulation (EU) 2017/1151. Any changes that have already been made to the legislation appear in the content and are referenced with annotations. (See end of Document for details)

(2) Equivalent EN/ISO methods will be adopted when issued for properties listed above.

TYPE: ETHANOL (E75)

Parameter	Unit	Limits ^a		Test method ^b
		Minimum	Maximum	
Research octane number, RON		95	—	EN ISO 5164
Motor octane number, MON		85	—	EN ISO 5163
Density at 15 C	kg/m ³	report		EN ISO 12185
Vapour pressure	kPa	50	60	EN ISO 13016-1 (DVPE)
Sulphur content ^{cd}	mg/kg	—	10	EN ISO 20846 EN ISO 20884
Oxidation stability	minutes	360	—	EN ISO 7536
Existent gum content (solvent washed)	mg/100ml	—	4	EN ISO 6246
Appearance shall be determined at ambient temperature or 15 C whichever is higher		Clear and bright, visibly free of suspended or precipitated contaminants		Visual inspection
Ethanol and higher alcohols ^e	% (V/V)	70	80	EN 1601 EN 13132 EN 14517
Higher alcohols (C ₃ – C ₈)	% (V/V)	—	2	
Methanol		—	0,5	
Petrol ^f	% (V/V)	Balance		EN 228
Phosphorus	mg/l	0,30 ^g		EN 15487 ASTM D 3231
Water content	% (V/V)	—	0,3	ASTM E 1064 EN 15489
Inorganic chloride content	mg/l	—	1	ISO 6227 — EN 15492
pHe		6,50	9	ASTM D 6423 EN 15490

Status: Point in time view as at 01/06/2017.

Changes to legislation: There are outstanding changes not yet made to Commission Regulation (EU) 2017/1151. Any changes that have already been made to the legislation appear in the content and are referenced with annotations. (See end of Document for details)

Copper strip corrosion (3h at 50 C)	Rating	Class 1		EN ISO 2160
Acidity (as acetic acid CH ₃ COOH)	% (m/m)		0,005	ASTM D1613 EN 15491
	mg/l		40	
Carbon/hydrogen ration		report		
Carbon/oxygen ration		report		

- a** The values referred to in the specifications are 'true values'. When establishing the value limits, the terms of ISO 4259 Petroleum products — Determination and application of precision data in relation to methods of test were applied. When fixing a minimum value, a minimum difference of 2R above zero was taken into account. When fixing a maximum and minimum value, the minimum difference used was 4R (R = reproducibility). Notwithstanding this procedure, which is necessary for technical reasons, fuel manufacturers shall aim for a zero value where the stipulated maximum value is 2R and for the mean value for quotations of maximum and minimum limits. Where it is necessary to clarify whether fuel meets the requirements of the specifications, the ISO 4259 terms shall be applied.
- b** In cases of dispute, the procedures for resolving the dispute and interpretation of the results based on test method precision, described in EN ISO 4259 shall be used.
- c** In cases of national dispute concerning sulphur content, either EN ISO 20846 or EN ISO 20884 shall be called up similar to the reference in the national annex of EN 228.
- d** The actual sulphur content of the fuel used for the Type 6 test shall be reported.
- e** Ethanol to meet specification of EN 15376 is the only oxygenate that shall be intentionally added to this reference fuel.
- f** The unleaded petrol content may be determined as 100 minus the sum of the percentage content of water and alcohols.
- g** There shall be no intentional addition of compounds containing phosphorus, iron, manganese, or lead to this reference fuel.

ANNEX X

Reserved

ANNEX XI

ON-BOARD DIAGNOSTICS (OBD) FOR MOTOR VEHICLES

1. INTRODUCTION
 - 1.1. This Annex sets out the functional aspects of on-board diagnostic (OBD) systems for the control of emissions from motor vehicles.
2. DEFINITIONS, REQUIREMENTS AND TESTS
 - 2.1. The definitions, requirements and tests for OBD systems are those specified in Sections 2 and 3 of Annex 11 to UN/ECE Regulation No 83. The exceptions to these requirements are described in the following sections.
 - 2.1.1. The introductory text to paragraph 2. of Annex 11 to UN/ECE Regulation No 83 shall be replaced with the following text:

Status: Point in time view as at 01/06/2017.

Changes to legislation: There are outstanding changes not yet made to Commission Regulation (EU) 2017/1151. Any changes that have already been made to the legislation appear in the content and are referenced with annotations. (See end of Document for details)

For the purposes of this Annex only:

2.1.2. Paragraph 2.10. of Annex 11 to UN/ECE Regulation No 83 shall be replaced with the following text:

A “*driving cycle*” consists of engine key on, a driving mode where a malfunction would be detected if present, and engine key-off.

2.1.3. A new paragraph 3.2.3. of Annex 11 of UN/ECE Regulation No 83 shall be added as follows:

3.2.3. Identification of deterioration or malfunctions may be also be done outside a driving cycle (e.g. after engine shutdown).

2.1.4. Reference to ‘THC and NOx’ in paragraph 3.3.3.1. of Annex 11 to UN/ECE Regulation No 83 shall be understood as being reference to ‘NMHC and NOx’.

2.1.5. Reference to ‘limits’ in paragraphs 3.3.3.1. and 3.3.4.4. of Annex 11 to UN/ECE Regulation No 83 shall be understood as being reference to ‘OBD threshold limits’.

2.1.6. Reference to ‘emission limits’ in paragraph 3.3.5. of Annex 11 to UN/ECE Regulation No 83 shall be understood as being reference to ‘OBD threshold limits’.

2.1.7. Paragraphs 3.3.4.9. and 3.3.4.10. of Annex 11 of UN/ECE Regulation No 83 shall be deleted.

2.1.8. New paragraphs 3.3.5.1. and 3.3.5.2. of Annex 11 of UN/ECE Regulation No 83 shall be added as follows:

3.3.5.1. The following devices should however be monitored for total failure or removal (if removal would cause the applicable emission limits in paragraph 5.3.1.4. of this Regulation to be exceeded):

- (a) A particulate trap fitted to compression ignition engines as a separate unit or integrated into a combined emission control device;
- (b) A NOx after-treatment system fitted to compression ignition engines as a separate unit or integrated into a combined emission control device;
- (c) A diesel oxidation catalyst (DOC) fitted to compression ignition engines as a separate unit or integrated into a combined emission control device.

3.3.5.2. The devices referred to in paragraph 3.3.5.1. shall also be monitored for any failure that would result in exceeding the applicable OBD threshold limits.

2.1.9. Paragraph 3.8.1. of Annex 11 to UN/ECE Regulation No 83 shall be replaced with the following text:

The OBD system may erase a fault code and the distance travelled and freeze-frame information if the same fault is not re-registered in at least 40 engine warm-up cycles or 40 driving cycles with vehicle operation in which the criteria specified in sections 7.5.1.(a)–(c) of Annex 11, Appendix 1 are met.

2.1.10. The reference to ISO DIS 15031 5 in paragraph 3.9.3.1. of Annex 11 to UN/ECE Regulation No 83 shall be replaced with the following text:

... the standard listed in paragraph 6.5.3.2.(a) of Annex 11, Appendix 1 of this Regulation.

Status: Point in time view as at 01/06/2017.

Changes to legislation: There are outstanding changes not yet made to Commission Regulation (EU) 2017/1151. Any changes that have already been made to the legislation appear in the content and are referenced with annotations. (See end of Document for details)

- 2.1.11. A new paragraph 3.10 of Annex 11 of UN/ECE Regulation No 83 shall be added as follows:
- 3.10. Additional provisions for vehicles employing engine shut - off strategies
- 3.10.1. Driving cycle
- 3.10.1.1. Autonomous engine restarts commanded by the engine control system following an engine stall may be considered a new driving cycle or a continuation of the existing driving cycle.
- 2.2. The Type V durability distance and Type V durability test mentioned in section 3.1 and 3.3.1 of Annex 11 to UN/ECE Regulation No 83 respectively shall be understood as reference to the requirements of Annex VII to this Regulation.
- 2.3. The OBD threshold limits specified in section 3.3.2 of Annex 11 to UN/ECE Regulation 83 shall be understood as reference to the requirements specified in points 2.3.1 and 2.3.2 below:
- 2.3.1. The OBD thresholds limits for vehicles that are type approved according to the Euro 6 emission limits set out in Table 2 of Annex I to Regulation (EC) No 715/2007 from three years after the dates given in Article 10(4) and 10(5) of that Regulation are given in the following table:

Final Euro 6 OBD threshold limits

Category	Class	Reference mass (kg)	Mass of carbon monoxide (CO) (mg/km)		Mass of non-methane hydrocarbons (NMHC) (mg/km)		Mass of oxides of nitrogen (NO _x) (mg/km)		Mass of particulate matter ^a (PM) (mg/km)		Number of particles ^{ab} (PN) (#/km)		
			PI	CI	PI	CI	PI	CI	CI	PI	CI	CI	PI
M	—	All	1 900	1 750	170	290	90	140	12	12			
N ₁	I	RM ≤ 1 305	1 900	1 750	170	290	90	140	12	12			
	II	1 305 < RM ≤ 1 760	3 400	2 200	225	320	110	180	12	12			
	III	1 760 < RM	4 300	2 500	270	350	120	220	12	12			
N ₂	—	All	4 300	2 500	270	350	120	220	12	12			

a Positive ignition particulate mass and particle number limits apply only to vehicles with direct injection engines.

b Particle number limits may be introduced at a later date

Key: PI = Positive Ignition, CI = Compression Ignition.

Status: Point in time view as at 01/06/2017.

Changes to legislation: There are outstanding changes not yet made to Commission Regulation (EU) 2017/1151. Any changes that have already been made to the legislation appear in the content and are referenced with annotations. (See end of Document for details)

- 2.3.2. Until three years after the dates specified in Article 10(4) and (5) of Regulation (EC) No 715/2007 for new type approvals and new vehicles respectively, the following OBD threshold limits shall be applied to vehicles that are type approved according to the Euro 6 emission limits set out in Table 2 of Annex I to Regulation (EC) No 715/2007, upon the choice of the manufacturer:

Preliminary Euro 6 OBD threshold limits										
Category	Class	Reference mass (RM) (kg)	Mass of carbon monoxide		Mass of non-methane hydrocarbons		Mass of oxides of nitrogen		Mass of particulate matter ^a	
			(CO)(mg/km)		(NMHC)(mg/km)		(NO _x)(mg/km)		(PM)(mg/km)	
			PI	CI	PI	CI	PI	CI	CI	PI
M	—	All	1 900	1 750	170	290	150	180	25	25
N ₁	I	RM ≤ 1 305	1 900	1 750	170	290	150	180	25	25
	II	1 305 < RM ≤ 1 760	3 400	2 200	225	320	190	220	25	25
	III	1 760 < RM	4 300	2 500	270	350	210	280	30	30
N ₂	—	All	4 300	2 500	270	350	210	280	30	30

a Positive ignition particulate mass limits apply only to vehicles with direct injection engines.

Key: PI = Positive Ignition, CI = Compression Ignition

- 2.4. The reference to the threshold limits in Section 3.3.3.1 of Annex 11 to UNECE Regulation No 83 shall be understood as reference to the threshold limits in Section 2.3 of this Annex.
- 2.5. The Type I test cycle referred to in paragraph 3.3.3.2. of Annex 11 to UN/ECE Regulation No 83 shall be understood as being the same as the Type 1 cycle that was used for at least two consecutive cycles after introduction of the misfire faults according to paragraph 6.3.1.2. of Appendix 1 to Annex 11 to UN/ECE Regulation No 83.
- 2.6. The reference to the particulate threshold limits provided for by paragraph 3.3.2. in section 3.3.3.7 of Annex 11 to UN/ECE Regulation No 83 shall be understood as being reference to the particulate threshold limits provided in Section 2.3 of this Annex.
- 2.7. The reference to the Type I test cycle in section 2.1.3 of Appendix 1 to Annex 11 of UN/ECE Regulation No 83 shall be understood as a reference to the type 1 test according to Regulation (EC) 692/2008 or Annex XXI of this Regulation, upon the choice of the manufacturer for each individual malfunction to be demonstrated.
3. ADMINISTRATIVE PROVISIONS FOR DEFICIENCIES OF OBD SYSTEMS

Status: Point in time view as at 01/06/2017.

Changes to legislation: There are outstanding changes not yet made to Commission Regulation (EU) 2017/1151. Any changes that have already been made to the legislation appear in the content and are referenced with annotations. (See end of Document for details)

- 3.1. The administrative provisions for deficiencies of OBD systems as set out in Article 6(2) shall be those specified in Section 4 of Annex 11 of UN/ECE Regulation No 83 with the following exceptions.
- 3.2. Reference to OBD threshold limits in paragraph 4.2.2. of Annex 11 to UN/ECE Regulation No 83 shall be understood as being reference to the OBD threshold limits in Section 2.3 of this Annex.
- 3.3. Paragraph 4.6 of Annex 11 to UN/ECE Regulation No 83 shall be understood as being as follows:

The approval authority shall notify its decision in granting a deficiency request in accordance with Article 6(2).

4. ACCESS TO OBD INFORMATION
- 4.1. Requirements for access to OBD information are specified in section 5 of Annex 11 to UN/ECE Regulation 83. The exceptions to these requirements are described in the following sections.
- 4.2. References to Appendix 1 of Annex 2 to UN/ECE Regulation No 83 shall be understood as references to Appendix 5 to Annex I to this Regulation.
- 4.3. References to section 3.2.12.2.7.6. of Annex 1 to UN/ECE Regulation No 83 shall be understood as references to 3.2.12.2.7.6 of Appendix 3 to Annex I to this Regulation.
- 4.4. References to ‘contracting parties’ shall be understood as references to ‘member states’.
- 4.5. References to approval granted under Regulation 83 shall be understood as references to type-approval granted under this Regulation and Regulation (EC) No 715/2007.
- 4.6. UN/ECE type-approval shall be understood as EC type-approval.

Appendix 1

FUNCTIONAL ASPECTS OF ON-BOARD DIAGNOSTIC (OBD) SYSTEMS

1. INTRODUCTION
- 1.1. This Appendix describes the procedure of the test according to section 2 of this Annex.
2. TECHNICAL REQUIREMENTS
- 2.1. The technical requirements and specifications shall be those set out in Appendix 1 to Annex 11 to UN/ECE Regulation No 83 with the exceptions and additional requirements as described in the following sections.
- 2.2. The references in Appendix 1 to Annex 11 to UN/ECE Regulation No 83 to the OBD threshold limits set out in paragraph 3.3.2 to Annex 11 of UN/ECE Regulation No 83 shall be understood as references to the OBD threshold limits set out in section 2.3 of this Annex.

Status: Point in time view as at 01/06/2017.

Changes to legislation: There are outstanding changes not yet made to Commission Regulation (EU) 2017/1151. Any changes that have already been made to the legislation appear in the content and are referenced with annotations. (See end of Document for details)

2.3. The reference fuels specified in paragraph 3.2 of Appendix 1 of Annex 11 of UN/ECE Regulation No 83 shall be understood as reference to the appropriate reference fuel specifications in Annex IX to this Regulation.

2.4. The reference to Annex 11 in paragraph 6.5.1.4 of Appendix 1 of Annex 11 of UN/ECE Regulation No 83 shall be understood as reference to Annex XI to this Regulation.

2.5. The following text shall be added as a new final sentence to the second paragraph of Section 1 of Appendix 1 to Annex 11 of UN/ECE Regulation No 83.

For electrical failures (short/open circuit), the emissions may exceed the limits of paragraph 3.3.2. by more than twenty per cent.

2.6. Paragraph 6.5.3. of Appendix 1 to Annex 11 of UN/ECE Regulation No 83 shall be replaced with the following:

6.5.3. The emission control diagnostic system shall provide for standardised and unrestricted access and conform with the following ISO standards and/or SAE specification. Later versions may be used at the manufacturers' discretion.

6.5.3.1. The following standard shall be used as the on board to off-board communications link:

(a) ISO 15765-4:2011 “Road vehicles – Diagnostics on Controller Area Network (CAN) – Part 4: Requirements for emissions-related systems”, dated 1 February 2011;

6.5.3.2. Standards used for the transmission of OBD relevant information:

(a) ISO 15031-5 “Road vehicles - communication between vehicles and external test equipment for emissions-related diagnostics – Part 5: Emissions-related diagnostic services”, dated 1 April 2011 or SAE J1979 dated 23 February 2012;

(b) ISO 15031-4 “Road vehicles – Communication between vehicle and external test equipment for emissions related diagnostics – Part 4: External test equipment”, dated 1 June 2005 or SAE J1978 dated 30 April 2002;

(c) ISO 15031-3 “Road vehicles – Communication between vehicle and external test equipment for emissions related diagnostics Part 3: Diagnostic connector and related electrical circuits: specification and use”, dated 1 July 2004 or SAE J 1962 dated 26 July 2012;

(d) ISO 15031-6 “Road vehicles – Communication between vehicle and external test equipment for emissions related diagnostics – Part 6: Diagnostic trouble code definitions”, dated 13 August 2010 or SAE J2012 dated 07 March 2013;

(e) ISO 27145 “Road vehicles – Implementation of World-Wide Harmonized On-Board Diagnostics (WWH-OBD)” dated 2012-08-15 with the restriction, that only 6.5.3.1.(a) may be used as a data link;

(f) ISO 14229:2013 “Road vehicles – Unified diagnostic services (UDS) with the restriction, that only 6.5.3.1.(a) may be used as a data link”.

The standards (e) and (f) may be used as an option instead of (a) not earlier than 1 January 2019.

6.5.3.3. Test equipment and diagnostic tools needed to communicate with OBD systems shall meet or exceed the functional specification given in the standard listed in paragraph 6.5.3.2.(b) of this Appendix.

Status: Point in time view as at 01/06/2017.

Changes to legislation: There are outstanding changes not yet made to Commission Regulation (EU) 2017/1151. Any changes that have already been made to the legislation appear in the content and are referenced with annotations. (See end of Document for details)

6.5.3.4. Basic diagnostic data, (as specified in paragraph 6.5.1.) and bi-directional control information shall be provided using the format and units described in the standard listed in paragraph 6.5.3.2.(a) of this appendix, and must be available using a diagnostic tool meeting the requirements of the standard listed in paragraph 6.5.3.2.(b) of this appendix.

The vehicle manufacturer shall provide to a national standardisation body the details of any emission-related diagnostic data, e.g. PID's, OBD monitor Id's, Test Id's not specified in the standard listed in paragraph 6.5.3.2.(a) of this Regulation but related to this Regulation.

6.5.3.5. When a fault is registered, the manufacturer shall identify the fault using an appropriate ISO/SAE controlled fault code specified in one of the standards listed in paragraph 6.5.3.2.(d) of this appendix, relating to "emission related system diagnostic trouble codes". If such identification is not possible, the manufacturer may use manufacturer controlled diagnostic trouble codes according to the same standard. The fault codes shall be fully accessible by standardised diagnostic equipment complying with the provisions of paragraph 6.5.3.2. of this Appendix.

The vehicle manufacturer shall provide to a national standardisation body the details of any emission-related diagnostic data, e.g. PID's, OBD monitor Id's, Test Id's not specified in the standards listed in paragraph 6.5.3.2.(a) of this Appendix but related to this Regulation.

6.5.3.6. The connection interface between the vehicle and the diagnostic tester shall be standardised and shall meet all the requirements of the standard listed in paragraph 6.5.3.2.(c) of this appendix. The installation position shall be subject to agreement of the administrative department such that it is readily accessible by service personnel but protected from tampering by non-qualified personnel.

6.5.3.7. The manufacturer shall also make accessible, where appropriate on payment, the technical information required for the repair or maintenance of motor vehicles unless that information is covered by an intellectual property right or constitutes essential, secret know-how which is identified in an appropriate form; in such case, the necessary technical information shall not be withheld improperly.

Entitled to such information is any person engaged in commercially servicing or repairing, road-side rescuing, inspecting or testing of vehicles or in the manufacturing or selling replacement or retro-fit components, diagnostic tools and test equipment.

2.6. A new paragraph 6.1.1. of Appendix 1 to Annex 11 of UN/ECE Regulation No 83 shall be inserted as follows:

6.1.1. The Type I Test need not be performed for the demonstration of electrical failures (short/open circuit). The manufacturer may demonstrate these failure modes using driving conditions in which the component is used and the monitoring conditions are encountered. These conditions shall be documented in the type approval documentation.

2.7. Paragraph 6.2.2. of Appendix 1 of Annex 11 of UN/ECE Regulation No 83 shall be amended to read as follows:

At the request of the manufacturer, alternative and/or additional preconditioning methods may be used.

2.8. A new paragraph 6.2.3. of Appendix 1 to Annex 11 of UN/ECE Regulation No 83 shall be inserted as follows:

Status: Point in time view as at 01/06/2017.

Changes to legislation: There are outstanding changes not yet made to Commission Regulation (EU) 2017/1151. Any changes that have already been made to the legislation appear in the content and are referenced with annotations. (See end of Document for details)

6.2.3. The use of additional preconditioning cycles or alternative preconditioning methods shall be documented in the type approval documentation.

2.9. Paragraph 6.3.1.5. of Appendix 1 to Annex 11 of UN/ECE Regulation No 83 shall be replaced with the following:

Electrical disconnection of the electronic evaporative purge control device (if equipped and if active on the selected fuel type).

2.10. Paragraph 6.4.1.1. of Appendix 1 to Annex 11 of UN/ECE Regulation No 83 shall be replaced with the following:

The MI shall be activated at the latest before the end of this test under any of the conditions given in paragraphs 6.4.1.2. to 6.4.1.5. The MI may also be activated during preconditioning. The Technical Service may substitute those conditions with others in accordance with paragraph 6.4.1.6.

2.11. Paragraph 6.4.2.1. of Appendix 1 to Annex 11 of UN/ECE Regulation No 83 shall be replaced with the following:

The MI shall be activated at the latest before the end of this test under any of the conditions given in paragraphs 6.4.2.2. to 6.4.2.5. The MI may also be activated during preconditioning. The Technical Service may substitute those conditions by others in accordance with paragraph 6.4.2.5.

3. IN-USE PERFORMANCE

3.1. General Requirements

The technical requirements and specifications shall be those set out in Appendix 1 to Annex 11 to UN/ECE Regulation No 83 with the exceptions and additional requirements as described in the following sections.

3.1.1. The requirements of paragraph 7.1.5 of Appendix 1 to Annex 11 to UN/ECE Regulation No 83 shall be understood as being as follows.

For new type approvals and new vehicles the monitor required by point 2.9 of this Annex shall have an IUPR greater or equal to 0,1 until three years after the dates specified in Article 10(4) and (5) of Regulation (EC) No 715/2007 respectively.

3.1.2. The requirements of paragraph 7.1.7 of Appendix 1 to Annex 11 to UN/ECE Regulation No 83 shall be understood as being as follows.

The manufacturer shall demonstrate to the approval authority and, upon request, to the Commission that these statistical conditions are satisfied for all monitors required to be reported by the OBD system according to paragraph 7.6. of Appendix 1 to Annex 11 to Regulation No 83 not later than 18 months after the entry onto the market of the first vehicle type with IUPR in an OBD family and every 18 months thereafter. For this purpose, for OBD families consisting of more than 1000 registrations in the Union, that are subject to sampling within the sampling period, the process described in Annex II shall be used without prejudice to the provisions of paragraph 7.1.9. of Appendix 1 to Annex 11 to Regulation No 83.

In addition to the requirements set out in Annex II and regardless of the result of the audit described in Section 2 of Annex II, the authority granting the approval shall apply the in-service conformity check for IUPR described in Appendix 1 to Annex II in an appropriate number of randomly determined cases. 'In an appropriate number of randomly determined cases' means, that this measure has a dissuasive effect on non-compliance with the requirements of Section

Status: Point in time view as at 01/06/2017.

Changes to legislation: There are outstanding changes not yet made to Commission Regulation (EU) 2017/1151. Any changes that have already been made to the legislation appear in the content and are referenced with annotations. (See end of Document for details)

3 of this Annex or the provision of manipulated, false or non-representative data for the audit. If no special circumstances apply and can be demonstrated by the type-approval authorities, random application of the in-service conformity check to 5 % of the type approved OBD families shall be considered as sufficient for compliance with this requirement. For this purpose, type-approval authorities may find arrangements with the manufacturer for the reduction of double testing of a given OBD family as long as these arrangements do not harm the dissuasive effect of the type-approval authority's own in-service conformity check on non-compliance with the requirements of Section 3 of this Annex. Data collected by Member States during surveillance testing programmes may be used for in-service conformity checks. Upon request, type-approval authorities shall provide data on the audits and random in-service conformity checks performed, including the methodology used for identifying those cases, which are made subject to the random in-service conformity check, to the Commission and other type-approval authorities.

3.1.3. Non-compliance with the requirements of paragraph 7.1.6. of Appendix 1 to Annex 11 to Regulation No 83 established by tests described in point 3.1.2 of this Appendix or paragraph 7.1.9 of Appendix 1 to Annex 11 to Regulation No 83 shall be considered as an infringement subject to the penalties set out in Article 13 of Regulation (EC) No 715/2007. This reference does not limit the application of such penalties to other infringements of other provisions of Regulation (EC) No 715/2007 or this Regulation, which do not explicitly refer to Article 13 of Regulation (EC) No 715/2007.

3.1.4. Paragraph 7.6.1. of Appendix 1 to Annex 11 of UN/ECE Regulation No 83 shall be replaced with the following:

7.6.1. The OBD system shall report, in accordance with the standard listed in paragraph 6.5.3.2.(a) of this Appendix, the ignition cycle counter and general denominator as well as separate numerators and denominators for the following monitors, if their presence on the vehicle is required by this annex:

- (a) Catalysts (each bank to be reported separately);
- (b) Oxygen/exhaust gas sensors, including secondary oxygen sensors (each sensor to be reported separately);
- (c) Evaporative system;
- (d) EGR system;
- (e) VVT system;
- (f) Secondary air system;
- (g) Particulate filter;
- (h) NO_x after-treatment system (e.g. NO_x absorber, NO_x reagent/catalyst system);
- (i) Boost pressure control system.

Paragraph 7.6.2. of Appendix 1 to Annex 11 of UN/ECE Regulation No 83 shall be replaced with the following:

7.6.2. For specific components or systems that have multiple monitors, which are required to be reported by this point (e.g. oxygen sensor bank 1 may have multiple monitors for sensor response or other sensor characteristics), the OBD system shall separately track numerators and denominators for each of the specific monitors and report only the corresponding numerator and denominator for the specific monitor that has the lowest numerical ratio. If two or more specific monitors have identical ratios, the

Status: Point in time view as at 01/06/2017.

Changes to legislation: There are outstanding changes not yet made to Commission Regulation (EU) 2017/1151. Any changes that have already been made to the legislation appear in the content and are referenced with annotations. (See end of Document for details)

corresponding numerator and denominator for the specific monitor that has the highest denominator shall be reported for the specific component.

A new paragraph 7.6.2.1. of Appendix 1 to Annex 11 of UN/ECE Regulation No 83 shall be inserted as follows:

7.6.2.1. Numerators and denominators for specific monitors of components or systems, that are monitoring continuously for short circuit or open circuit failures are exempted from reporting.

“Continuously,” if used in this context means monitoring is always enabled and sampling of the signal used for monitoring occurs at a rate no less than two samples per second and the presence or the absence of the failure relevant to that monitor has to be concluded within 15 seconds.

If for control purposes, a computer input component is sampled less frequently, the signal of the component may instead be evaluated each time sampling occurs.

It is not required to activate an output component/system for the sole purpose of monitoring that output component/system.

Appendix 2

ESSENTIAL CHARACTERISTICS OF THE VEHICLE FAMILY

The essential characteristics of the vehicle family shall be those specified in Appendix 2 to Annex 11 to UN/ECE Regulation No 83.

ANNEX XII

DETERMINATION OF CO₂ EMISSIONS, FUEL CONSUMPTION, ELECTRIC ENERGY CONSUMPTION AND ELECTRIC RANGE

1. TYPE-APPROVAL OF VEHICLES FITTED WITH ECO-INNOVATIONS
 - 1.1. According to Article 11(1) of Regulation (EU) No 725/2011 for M1 vehicles and Article 11(1) of Regulation (EU) No 427/2014 for N1 vehicles, a manufacturer wishing to benefit from a reduction of its average specific CO₂ emissions, as result of the savings achieved by one or more eco-innovations fitted in a vehicle, shall apply to an approval authority for an EC type-approval certificate of the vehicle fitted with the eco-innovation.
 - 1.2. The CO₂ emissions savings from the vehicle fitted with an eco-innovation shall, for the purpose of type approval, be determined using the procedure and testing methodology specified in the Commission Decision approving the eco-innovation, in accordance with Article 10 of Regulation (EU) No 725/2011 for M1 vehicles, or Article 10 of Regulation (EU) No 427/2014 for N1 vehicles.
 - 1.3. The performance of the necessary tests for the determination of the CO₂ emissions savings achieved by the eco-innovations shall be considered without prejudice to the demonstration of compliance of the eco-innovations with the technical prescriptions laid down in Directive 2007/46/EC, if applicable.

Status: Point in time view as at 01/06/2017.

Changes to legislation: There are outstanding changes not yet made to Commission Regulation (EU) 2017/1151. Any changes that have already been made to the legislation appear in the content and are referenced with annotations. (See end of Document for details)

- 1.4. If the innovative technology does not meet the threshold of 1g CO₂/km as specified in Article 9 of Regulation (EU) No 725/2011, the type approval certificate shall be issued without reference to the eco-innovation code or the CO₂ reductions achieved by the innovative technology.
2. DETERMINATION OF CO₂ EMISSIONS AND FUEL CONSUMPTION FROM N₁ VEHICLES SUBMITTED TO MULTI-STAGE TYPE-APPROVAL
 - 2.1. For the purpose of determining the CO₂ emissions and fuel consumption of a vehicle submitted to multi-stage type-approval, as defined in Article 3(7) of Directive 2007/46/EC, the procedures of Annex XXI apply. Specific provisions for multi-stage type approval are set in points 2.2 to 2.7 of this annex.
 - 2.2. The road load shall be determined with the road load matrix family by using the parameters of a representative multi-stage vehicle which are set in paragraph 4.2.1.4 in Sub-Annex 4 of Annex XXI.
 - 2.3. The calculation of road load and running resistance are based on a representative vehicle of a road load matrix family as set in paragraph 5.1 of Sub-Annex 4 of Annex XXI.
 - 2.4. The manufacturer of the base vehicle shall test a representative multi-stage vehicle for CO₂ emission and fuel consumption and make available a calculation tool to establish, on the basis of the parameters of completed vehicles, their fuel consumption and CO₂ values as set in Sub-Annex 7 of Annex XXI.
 - 2.5. The final fuel consumption and CO₂ values shall be calculated by the final-stage manufacturer on the basis of the parameters of the completed vehicle as set in paragraph 3.2.4 of Sub-Annex 7 of Annex XXI.
 - 2.6. The manufacturer of the completed vehicle shall include, in the certificate of conformity, the information of the completed vehicles and add the information of the base vehicles in accordance with Annex IX to Directive 2007/46/EC.
 - 2.7. In the case of vehicles submitted to individual vehicle approval, the individual approval certificate shall include the following information:
 - (a) the CO₂ emissions measured according to the methodology set out in points 2.1 to 2.6 above;
 - (b) the mass of the completed vehicle in running order;
 - (c) the identification code corresponding to the type, variant and version of the base vehicle;
 - (d) the type-approval number of the base vehicle, including the extension number;
 - (e) the name and address of the manufacturer of the base vehicle;
 - (f) the mass of the base vehicle in running order.

ANNEX XIII

EC TYPE-APPROVAL OF REPLACEMENT POLLUTION CONTROL DEVICES AS SEPARATE TECHNICAL UNIT

1. INTRODUCTION

- 1.1. This Annex contains additional requirement for the type-approval as separate technical units of pollution control devices.

2. GENERAL REQUIREMENTS

2.1. **Marking**

Original replacement pollution control devices shall bear at least the following identifications:

- (a) the vehicle manufacturer's name or trade mark;
- (b) the make and identifying part number of the original replacement pollution control device as recorded in the information mentioned in point 2.3.

2.2. **Documentation**

Original replacement pollution control devices shall be accompanied by the following information:

- (a) the vehicle manufacturer's name or trade mark;
- (b) the make and identifying part number of the original replacement pollution control device as recorded in the information mentioned in point 2.3;
- (c) the vehicles for which the original replacement pollution control device is of a type covered by point 2.3 of the Addendum to Appendix 4 to Annex I, including, where applicable, a marking to identify if the original replacement pollution control device is suitable for fitting to a vehicle that is equipped with an on-board diagnostic (OBD) system;
- (d) installation instructions, where necessary.

This information shall be available in the product catalogue distributed to points of sale by the vehicle manufacturer.

- 2.3. The vehicle manufacturer shall provide to the technical service and/or approval authority the necessary information in electronic format which makes the link between the relevant part numbers and the type-approval documentation.

This information shall contain the following:

- (a) make(s) and type(s) of vehicle,
- (b) make(s) and type(s) of original replacement pollution control device,
- (c) part number(s) of original replacement pollution control device,
- (d) type-approval number of the relevant vehicle type(s).

3. EC SEPARATE TECHNICAL UNIT TYPE-APPROVAL MARK

- 3.1. Every replacement pollution control device conforming to the type approved under this Regulation as a separate technical unit shall bear an EC type-approval mark.

Status: Point in time view as at 01/06/2017.

Changes to legislation: There are outstanding changes not yet made to Commission Regulation (EU) 2017/1151. Any changes that have already been made to the legislation appear in the content and are referenced with annotations. (See end of Document for details)

- 3.2. This mark shall consist of a rectangle surrounding the lower-case letter ‘e’ followed by the distinguishing number of the Member State which has granted the EC type-approval in accordance with the numbering system set out in Annex VII to Directive 2007/46/EC.

The EC type-approval mark shall also include in the vicinity of the rectangle the ‘base approval number’ contained in section 4 of the type-approval number referred to in Annex VII to Directive 2007/46/EC, preceded by the two figures indicating the sequence number assigned to the latest major technical amendment to Regulation (EC) No 715/2007 or this Regulation on the date EC type-approval for a separate technical unit was granted. For this Regulation, the sequence number is 00.

- 3.3. The EC type-approval mark shall be affixed to the replacement pollution control device in such a way as to be clearly legible and indelible. It shall, wherever possible, be visible when the replacement pollution control device is installed on the vehicle.

- 3.4. Appendix 3 to this Annex gives example of the EC type-approval mark.

4. TECHNICAL REQUIREMENTS

- 4.1. The requirements for the type-approval of replacement pollution control devices shall be those of Section 5 of UN/ECE Regulation No 103 with the exceptions set out in sections 4.1.1 to 4.1.5.

- 4.1.1. Reference to the ‘test cycle’ in Section 5 of UN/ECE Regulation No 103 shall be understood as being the same Type I / Type 1 test and Type I / Type 1 test cycle as used for the original type approval of the vehicle.

- 4.1.2. The terms ‘catalytic converter’ and ‘converter’ used in section 5 of UN/ECE Regulation No 103 shall be understood to mean ‘pollution control device’

- 4.1.3. The regulated pollutants referred to throughout section 5.2.3 of UN/ECE Regulation No 103 shall be replaced by all the pollutants specified in Annex 1, Table 2 of Regulation (EC) No 715/2007 for replacement pollution control devices intended to be fitted to vehicles type approved to Regulation (EC) No 715/2007.

- 4.1.4. For replacement pollution control devices standards intended to be fitted to vehicles type approved to Regulation (EC) No 715/2007, the durability requirements and associated deterioration factors specified in section 5 of UN/ECE Regulation No 103, shall refer to those specified in Annex VII of this Regulation.

- 4.1.5. Reference to Appendix 1 of the type-approval communication in section 5.5.3 of UN/ECE Regulation No 103 shall be understood as reference to the addendum to the EC type-approval certificate on vehicle OBD information (Appendix 5 to Annex I).

- 4.2. For vehicles with positive-ignition engines, if the NMHC emissions measured during the demonstration test of a new original equipment catalytic converter, under paragraph 5.2.1 of UN/ECE Regulation No 103, are higher than the values measured during the type-approval of the vehicle, the difference shall be added to the OBD threshold limits. The OBD threshold limits are specified in point 2.3 of Annex XI of this Regulation.

- 4.3. The revised OBD threshold limits will apply during the tests of OBD compatibility set out in paragraphs 5.5 to 5.5.5 of UN/ECE Regulation No 103. In particular, when the exceedance allowed in paragraph 1 of Appendix 1 to Annex 11 to UN/ECE Regulation No 83 is applied.

Status: Point in time view as at 01/06/2017.

Changes to legislation: There are outstanding changes not yet made to Commission Regulation (EU) 2017/1151. Any changes that have already been made to the legislation appear in the content and are referenced with annotations. (See end of Document for details)

4.4. Requirements for replacement periodically regenerating systems

4.4.1. Requirements regarding emissions

4.4.1.1. The vehicle(s) indicated in Article 11(3), equipped with a replacement periodically regenerating system of the type for which approval is requested, shall be subject to the tests described in paragraph 3 of Annex 13 of UN/ECE Regulation No 83, in order to compare its performance with the same vehicle equipped with the original periodically regenerating system.

4.4.1.2. Reference to the ‘Type I test’ and ‘Type I test cycle’ in paragraph 3. of Annex 13 of UN/ECE Regulation No 83 and the ‘test cycle’ in Section 5 of UN/ECE Regulation No 103 shall be understood as being the same Type I / Type 1 test and Type I / Type 1 test cycle as used for the original type approval of the vehicle.

4.4.2. Determination of the basis for comparison

4.4.2.1. The vehicle shall be fitted with a new original periodically regenerating system. The emissions performance of this system shall be determined following the test procedure set out in paragraph 3 of Annex 13 of UN/ECE Regulation No 83.

4.4.2.1.1. Reference to the ‘Type I test’ and ‘Type I test cycle’ in paragraph 3. of Annex 13 of UN/ECE Regulation No 83 and the ‘test cycle’ in Section 5 of UN/ECE Regulation No 103 shall be understood as being the same Type I / Type 1 test and Type I / Type 1 test cycle as used for the original type approval of the vehicle.

4.4.2.2. Upon request of the applicant for the approval of the replacement component, the approval authority shall make available on a non-discriminatory basis, the information referred to in points 3.2.12.2.1.11.1 and 3.2.12.2.6.4.1 of the information document contained in Appendix 3 to Annex I to this Regulation for each vehicle tested.

4.4.3. Exhaust gas test with a replacement periodically regeneration system

4.4.3.1. The original equipment periodically regenerating system of the test vehicle(s) shall be replaced by the replacement periodically regenerating system. The emissions performance of this system shall be determined following the test procedure set out in paragraph 3 Annex 13 of UN/ECE Regulation No 83.

4.4.3.1.1. Reference to the ‘Type I test’ and ‘Type I test cycle’ in paragraph 3. of Annex 13 of UN/ECE Regulation No 83 and the ‘test cycle’ in Section 5 of UN/ECE Regulation No 103 shall be understood as being the same Type I / Type 1 test and Type I / Type 1 test cycle as used for the original type approval of the vehicle.

4.4.3.2. To determine the D-factor of the replacement periodically regenerating system, any of the engine test bench methods referred to in paragraph 3 of Annex 13 of UN/ECE Regulation No 83 may be used.

4.4.4. Other requirements

The requirements of paragraphs 5.2.3, 5.3, 5.4 and 5.5 of UN/ECE Regulation No 103 shall apply to replacement periodically regenerating systems. In these paragraphs the words ‘catalytic converter’ shall be understood to mean ‘periodically regenerating system’. In addition the exceptions made to these paragraphs in section 4.1 of this annex shall also apply to periodically regenerating systems.

5. DOCUMENTATION

Status: Point in time view as at 01/06/2017.

Changes to legislation: There are outstanding changes not yet made to Commission Regulation (EU) 2017/1151. Any changes that have already been made to the legislation appear in the content and are referenced with annotations. (See end of Document for details)

- 5.1. Each replacement pollution control device shall be clearly and indelibly marked with the manufacturer's name or trade mark and accompanied by the following information:
- (a) the vehicles (including year of manufacture) for which the replacement pollution control device is approved, including, where applicable, a marking to identify if the replacement pollution control device is suitable for fitting to a vehicle that is equipped with an on-board diagnostic (OBD) system;
 - (b) installation instructions, where necessary.

The information shall be available in the product catalogue distributed to points of sale by the manufacturer of replacement pollution control devices.

6. CONFORMITY OF PRODUCTION

- 6.1. Measures to ensure the conformity of production shall be taken in accordance with the provisions laid down in Article 12 of Directive 2007/46/EC.

6.2. Special provisions

- 6.2.1. The checks referred to in point 2.2 of Annex X to Directive 2007/46/EC shall include compliance with the characteristics as defined under point 8 of Article 2 of this Regulation.
- 6.2.2. For the application of Article 12(2) of Directive 2007/46/EC, the tests described in section 4.4.1 of this Annex and section 5.2 of UN/ECE Regulation No 103 (requirements regarding emissions) may be carried out. In this case, the holder of the approval may request, as an alternative, to use as a basis for comparison not the original equipment pollution control device, but the replacement pollution control device which was used during the type-approval tests (or another sample that has been proven to conform to the approved type). Emissions values measured with the sample under verification shall then on average not exceed by more than 15 % the mean values measured with the sample used for reference.

Appendix 1

MODEL

Information document No ...relating to the EC type-approval of replacement pollution control devices

The following information, if applicable, must be supplied in triplicate and include a list of contents. Any drawings must be supplied in appropriate scale and sufficient detail on size A4 or on a folder of A4 format. Photographs, if any, must show sufficient detail.

If the systems, components or separate technical units have electronic controls, information concerning their performance must be supplied.

- 0. GENERAL
- 0.1. Make (trade name of manufacturer): ...
- 0.2. Type: ...
- 0.2.1. Commercial name(s), if available: ...

Status: Point in time view as at 01/06/2017.

Changes to legislation: There are outstanding changes not yet made to Commission Regulation (EU) 2017/1151. Any changes that have already been made to the legislation appear in the content and are referenced with annotations. (See end of Document for details)

0.5. Name and address of manufacturer: ...

Name and address of authorised representative, if any: ...

0.7. In the case of components and separate technical units, location and method of affixing of the EC approval mark: ...

0.8. Address(es) of assembly plant(s): ...

1. DESCRIPTION OF THE DEVICE

1.1. Make and type of the replacement pollution control device: ...

1.2. Drawings of the replacement pollution control device, identifying in particular all the characteristics referred to under point 8 of Article 2 of this Regulation: ...

1.3. Description of the vehicle type or types for which the replacement pollution control device is intended: ...

1.3.1. Number(s) and/or symbol(s) characterising the engine and vehicle type(s): ...

1.3.2. Is the replacement pollution control device intended to be compatible with OBD requirements (Yes/No)⁽²⁸⁾

1.4. Description and drawings showing the position of the replacement pollution control device relative to the engine exhaust manifold(s): ...

Appendix 2

MODEL EC TYPE-APPROVAL CERTIFICATE(Maximum format: A4 (210 mm × 297 mm))

EC TYPE-APPROVAL CERTIFICATE

Stamp of administration

Communication concerning the:

- EC type-approval⁽²⁹⁾, ...,
- extension of EC type-approval⁽³⁰⁾, ...,
- refusal of EC type-approval⁽³¹⁾, ...,
- withdrawal of EC type-approval⁽³²⁾, ...,

of a type of component/separate technical unit⁽³³⁾

with regard to Regulation (EC) No 715/2007, as implemented by Regulation (EU) 2017/1151.

Regulation (EC) No 715/2007 or Regulation (EU) 2017/1151 as last amended by ...

EC type-approval number: ...

Reason for extension: ...

SECTION 0.1.

I Make (trade name of manufacturer): ...

0.2. Type: ...

Status: Point in time view as at 01/06/2017.

Changes to legislation: There are outstanding changes not yet made to Commission Regulation (EU) 2017/1151. Any changes that have already been made to the legislation appear in the content and are referenced with annotations. (See end of Document for details)

- 0.3. Means of identification of type if marked on the component/separate technical unit⁽³⁴⁾:
...
- 0.3.1. Location of that marking: ...
- 0.5. Name and address of manufacturer: ...
- 0.7. In the case of components and separate technical units, location and method of affixing of the EC approval mark: ...
- 0.8. Name and address(es) of assembly plant(s): ...
- 0.9. Name and address of manufacturer's representative (if any): ...

SECTION.

II

Additional information

- 1.1. Make and type of the replacement pollution control device: ...
- 1.2. Vehicle type(s) for which the pollution control device type qualifies as replacement part: ...
- 1.3. Type(s) of vehicles) on which the replacement pollution control device has been tested:
...
- 1.3.1. Has the replacement pollution control device demonstrated compatibility with OBD requirements (yes/no)⁽³⁵⁾: ...
- 2. Technical service responsible for carrying out the tests: ...
- 3. Date of test report: ...
- 4. Number of test report: ...
- 5. Remarks: ...
- 6. Place: ...
- 7. Date: ...
- 8. Signature: ...

Attachments:

Information package.

Appendix 3

Example of the EC type-approval marks(see point 3.2 of this Annex)

Status: Point in time view as at 01/06/2017.

Changes to legislation: There are outstanding changes not yet made to Commission Regulation (EU) 2017/1151. Any changes that have already been made to the legislation appear in the content and are referenced with annotations. (See end of Document for details)

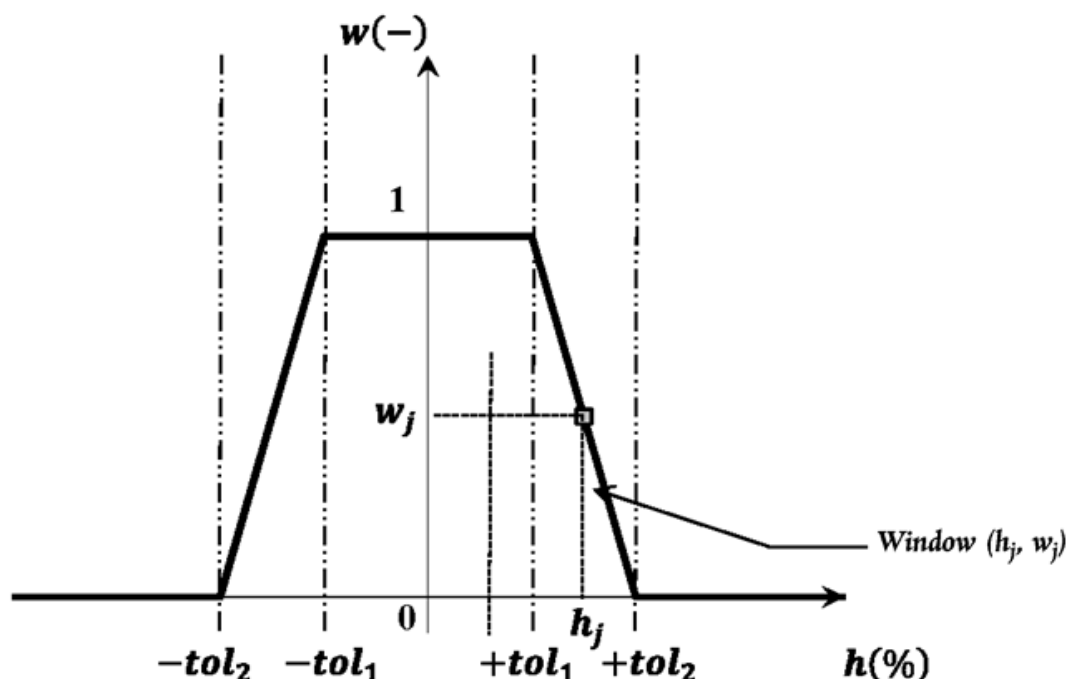

The above approval mark affixed to a component of a replacement pollution control device shows that the type concerned has been approved in France (e 2), pursuant to this Regulation. The first two digits of the approval number (00) indicate that this part was approved according to this Regulation. The following four digits (1234) are those allocated by the approval authority to the replacement pollution control device as the base approval number.

ANNEX XIV

Access to vehicle OBD and vehicle repair and maintenance information

1. INTRODUCTION
 - 1.1. This Annex lays down technical requirements for the accessibility of vehicle OBD and vehicle repair and maintenance information.
2. REQUIREMENTS
 - 2.1. Vehicle OBD and vehicle repair and maintenance information available through websites shall follow the technical specifications of OASIS Document SC2-D5, Format of Automotive Repair Information, version 1.0, 28 May 2003⁽³⁶⁾ and of Sections 3.2, 3.5, (excluding 3.5.2), 3.6, 3.7 and 3.8 of OASIS Document SC1-D2, Autorepair Requirements Specification, version 6.1, dated 10.1.2003⁽³⁷⁾, using only open text and graphic formats or formats which can be viewed and printed using only standard software plug-ins that are freely available, easy to install, and which run under computer operating systems commonly in use. Where possible, keywords in the meta data shall conform to ISO 15031-2. Such information shall be always available, except as required for web-site maintenance purposes. Those requiring the right to duplicate or re-publish the information should negotiate directly with the manufacturer concerned. Information for training material shall also be available, but may be presented through other media than web-sites.

Status: Point in time view as at 01/06/2017.

Changes to legislation: There are outstanding changes not yet made to Commission Regulation (EU) 2017/1151. Any changes that have already been made to the legislation appear in the content and are referenced with annotations. (See end of Document for details)

Information on all parts of the vehicle, with which the vehicle, as identified by the vehicle identification number (VIN) and any additional criteria such as wheelbase, engine output, trim level or options, is equipped by the vehicle manufacturer and which can be replaced by spare parts offered by the vehicle manufacturer to its authorised repairers or dealers or third parties by means of reference to original equipment (OE) parts number, shall be made available in a database easily accessible to independent operators.

This database shall comprise the VIN, OE parts numbers, OE naming of the parts, validity attributes (valid-from and valid-to dates), fitting attributes and where applicable structuring characteristics.

The information on the database shall be regularly updated. The updates shall include in particular all modifications to individual vehicles after their production if this information is available to authorised dealers.

- 2.2. Access to vehicle security features used by authorised dealers and repair shops shall be made available to independent operators under protection of security technology according to the following requirements:
- (i) data shall be exchanged ensuring confidentiality, integrity and protection against replay;
 - (ii) the standard [https//ssl-tls](https://ssl-tls) (RFC4346) shall be used;
 - (iii) security certificates in accordance with ISO 20828 shall be used for mutual authentication of independent operators and manufacturers;
 - (iv) the independent operator's private key shall be protected by secure hardware.

The Forum on Access to Vehicle Information provided for by paragraph 9 of Article 13 will specify the parameters for fulfilling these requirements according to the state-of-the-art.

The independent operator shall be approved and authorised for this purpose on the basis of documents demonstrating that they pursue a legitimate business activity and have not been convicted of relevant criminal activity.

- 2.3. Reprogramming of control units shall be conducted in accordance with either ISO 22900 or SAE J2534, regardless of the date of type approval. For the validation of the compatibility of the manufacturer-specific application and the vehicle communication interfaces (VCI) complying to ISO 22900 or SAE J2534, the manufacturer shall offer either a validation of independently developed VCIs or the information, and loan of any special hardware, required for a VCI manufacturer to conduct such validation himself. The conditions of Article 7(1) of Regulation (EC) No 715/2007 apply to fees for such validation or information and hardware.
- 2.4. All emission-related fault codes shall be consistent with Appendix 1 to Annex XI.
- 2.5. For access to any vehicle OBD and vehicle repair and maintenance information other than that relating to secure areas of the vehicle, registration requirements for use of the manufacturer's web site by an independent operator shall require only such information as is necessary to confirm how payment for the information is to be made. For information concerning access to secure areas of the vehicle, the independent operator shall present a certificate in accordance with ISO 20828 to identify himself and the organisation to which he belongs and the manufacturer shall respond with his own certificate in accordance with ISO 20828 to confirm to the independent operator that he is accessing a legitimate site of the intended manufacturer. Both parties shall

Status: Point in time view as at 01/06/2017.

Changes to legislation: There are outstanding changes not yet made to Commission Regulation (EU) 2017/1151. Any changes that have already been made to the legislation appear in the content and are referenced with annotations. (See end of Document for details)

keep a log of any such transactions indicating the vehicles and changes made to them under this provision.

- 2.6. In the event that vehicle OBD and vehicle repair and maintenance information available on a manufacturer's website does not contain specific relevant information to permit the proper design and manufacture of alternative fuels retrofit systems, then any interested alternative fuels retrofit system manufacturer shall be able to access the information required in paragraphs 0, 2, and 3 of Appendix 3 to Annex I by contacting the manufacturer directly with such a request. Contact details for that purpose shall be clearly indicated on the manufacturer's website and the information shall be provided within 30 days. Such information need only be provided for alternative fuels retrofit systems that are subject to UN/ECE Regulation No 115⁽³⁸⁾ or for alternative fuels retrofit components that form part of systems subject to UN/ECE Regulation No 115, and need only be provided in response to a request that clearly specifies the exact specification of the vehicle model for which the information is required and that specifically confirms that the information is required for the development of alternative fuels retrofit systems or components subject to UN/ECE Regulation No 115.
- 2.7. Manufacturers shall indicate in their repair information websites the type-approval number by model.
- 2.8. Manufacturers shall establish fees for hourly, daily, monthly, annual and per-transaction access to their repair and maintenance information websites, which are reasonable and proportionate.

Appendix 1

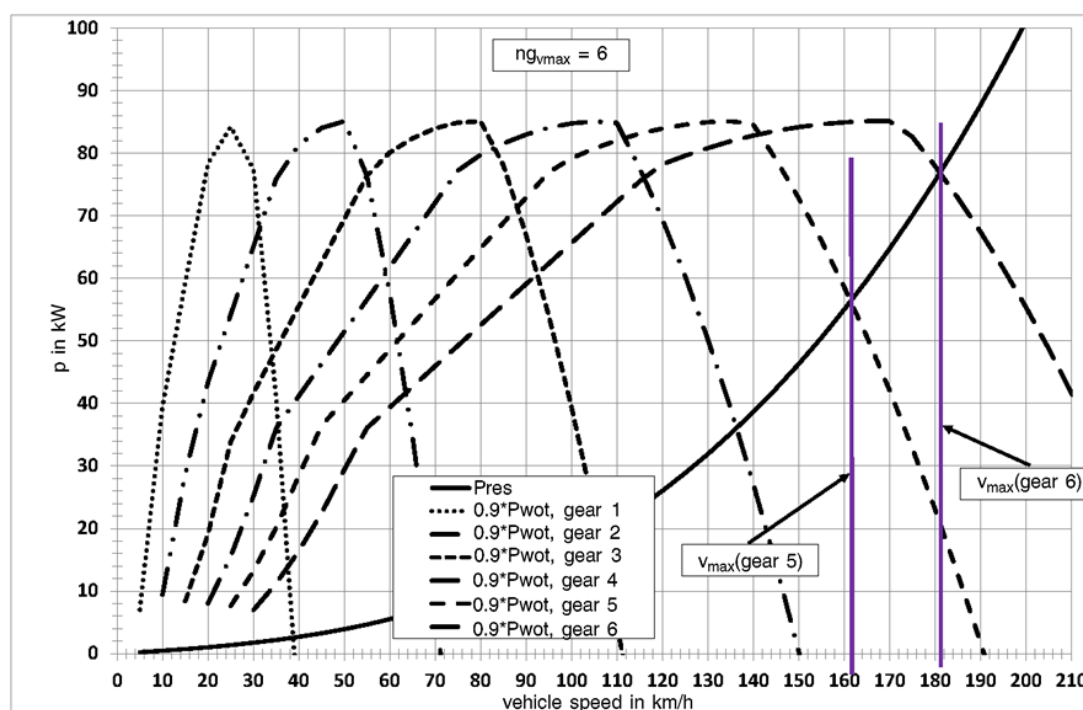

Status: Point in time view as at 01/06/2017.

Changes to legislation: There are outstanding changes not yet made to Commission Regulation (EU) 2017/1151. Any changes that have already been made to the legislation appear in the content and are referenced with annotations. (See end of Document for details)

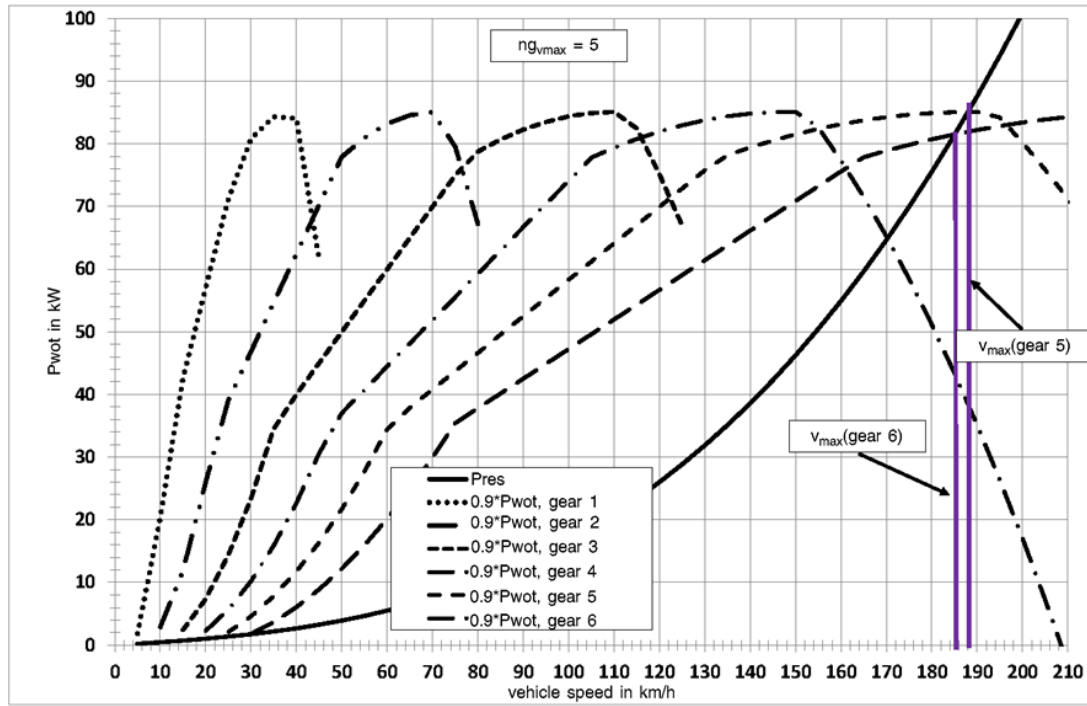

Status: Point in time view as at 01/06/2017.

Changes to legislation: There are outstanding changes not yet made to Commission Regulation (EU) 2017/1151. Any changes that have already been made to the legislation appear in the content and are referenced with annotations. (See end of Document for details)

Manufacturer's certificate of compliance with the OBD in-use performance requirements

(Manufacturer):

(Address of the manufacturer):

Certifies that

- The vehicle types listed in attachment to this Certificate are in compliance with the provisions of section 3 of Appendix 1 to Annex XI of Commission Regulation (EU) 2017/1151 relating to the in-use performance of the OBD system under all reasonably foreseeable driving conditions.
- The plan(s) describing the detailed technical criteria for incrementing the numerator and denominator of each monitor attached to this Certificate are correct and complete for all types of vehicles to which the Certificate applies.

Done at [..... Place]

On [..... Date]

.....
[Signature of the Manufacturer's Representative]

Annexes:

- List of vehicle types to which this Certificate applies
- Plan(s) describing the detailed technical criteria for incrementing the numerator and denominator of each monitor, as well as plan(s) for disabling numerators, denominators and general denominator.

ANNEX XV

Reserved

ANNEX XVI

REQUIREMENTS FOR VEHICLES THAT USE A REAGENT FOR THE EXHAUST AFTER-TREATMENT SYSTEM

1. INTRODUCTION

Status: Point in time view as at 01/06/2017.

Changes to legislation: There are outstanding changes not yet made to Commission Regulation (EU) 2017/1151. Any changes that have already been made to the legislation appear in the content and are referenced with annotations. (See end of Document for details)

This Annex sets out the requirements for vehicles that rely on the use of a reagent for the after-treatment system in order to reduce emissions.

The requirements shall be those specified in Appendix 6 to UN/ECE Regulation No 83, with the following exception.

The reference to Annex 1 in paragraph 4.1. of Appendix 6 to UN/ECE Regulation No 83 shall be understood as reference to Appendix 3 to Annex I to this Regulation.

ANNEX XVII

AMENDMENTS TO REGULATION (EC) No 692/2008

1. Appendix 3 to Annex I of Regulation (EC) No 692/2008 is hereby amended as follows:
 - (a) Points 3. to 3.1.1. shall be amended to read:
 3. PROPULSION ENERGY CONVERTER (k)
 - 3.1. Manufacturer of the propulsion energy converter(s): ...
 - 3.1.1. Manufacturer's code (as marked on the propulsion energy converter or other means of identification): ...
 - (b) Point 3.2.1.8. shall be amended to read:
 - 3.2.1.8. Rated engine power (n): ... kW at ... min⁻¹ (manufacturer's declared value)
 - (c) Point 3.2.2.2. shall be renumbered 3.2.2.1.1. and shall read as follows:
 - 3.2.2.1.1. RON, unleaded: ...
 - (d) Point 3.2.4.2.1. shall be amended to read:
 - 3.2.4.2.1. System description (common rail/unit injectors/distribution pump etc.): ...
 - (e) Point 3.2.4.2.3. shall be amended to read:
 - 3.2.4.2.3. Injection/Delivery pump
 - (f) Point 3.2.4.2.4. shall be amended to read:
 - 3.2.4.2.4. Engine speed limitation control
 - (g) Point 3.2.4.2.9.3. shall be amended to read:
 - 3.2.4.2.9. Description of the system
 - (h) Points 3.2.4.2.9.3.6. to 3.2.4.2.9.3.8. shall be amended to read:
 - 3.2.4.2.9. Make and type or working principle of water temperature sensor: ...
 - 3.2.4.2.9. Make and type or working principle of air temperature sensor: ...
 - 3.2.4.2.9. Make and type or working principle of air pressure sensor: ...
 - (i) Point 3.2.4.3.4.3. shall be amended to read:
 - 3.2.4.3.4. Make and type or working principle of air-flow sensor: ...

Status: Point in time view as at 01/06/2017.

Changes to legislation: There are outstanding changes not yet made to Commission Regulation (EU) 2017/1151. Any changes that have already been made to the legislation appear in the content and are referenced with annotations. (See end of Document for details)

- (j) Points 3.2.4.3.4.9. to 3.2.4.3.4.11. shall be amended to read:
- 3.2.4.3.4.9. ~~Make~~ and type or working principle of water temperature sensor: ...
 - 3.2.4.3.4.10. ~~Make~~ and type or working principle of air temperature sensor: ...
 - 3.2.4.3.4.11. ~~Make~~ and type or working principle of air pressure sensor: ...
- (k) Point 3.2.4.3.5. shall be amended to read:
- 3.2.4.3.5. Injectors
- (l) Points 3.2.12.2. to 3.2.12.2.1. shall be amended to read:
- 3.2.12.2. Pollution control devices (if not covered by another heading)
 - 3.2.12.2.1. Catalytic converter
- (m) Points 3.2.12.2.1.11. to 3.2.12.2.1.11.10 shall be deleted
- (n) Points 3.2.12.2.2. to 3.2.12.2.2.5. shall be deleted and replaced with the following:
- 3.2.12.2.2. ~~Sensors~~
 - 3.2.12.2.2.1. ~~Oxygen sensor: yes/no~~ ⁽¹⁾
 - 3.2.12.2.2.2. ~~Make: ...~~
 - 3.2.12.2.2.3. ~~Location: ...~~
 - 3.2.12.2.2.4. ~~Control range: ...~~
 - 3.2.12.2.2.5. ~~Type or working principle: ...~~
 - 3.2.12.2.2.6. ~~Identifying part number: ...~~
- (o) Points 3.2.12.2.4.1. to 3.2.12.2.4.2. shall be amended to read:
- 3.2.12.2.4.1. ~~Characteristics (make, type, flow, high pressure / low pressure / combined pressure, etc.): ...~~
 - 3.2.12.2.4.2. ~~Water-cooled system (to be specified for each EGR system e.g. low pressure / high pressure / combined pressure: yes/no~~ ⁽¹⁾
- (p) Points 3.2.12.2.5. to 3.2.12.2.5.6. shall be amended to read:
- 3.2.12.2.5. ~~Evaporative emissions control system (petrol and ethanol engines only): yes/ no~~ ⁽¹⁾
 - 3.2.12.2.5.1. ~~Detailed description of the devices: ...~~
 - 3.2.12.2.5.2. ~~Drawing of the evaporative emissions control system: ...~~
 - 3.2.12.2.5.3. ~~Drawing of the carbon canister: ...~~
 - 3.2.12.2.5.4. ~~Mass of dry charcoal: ... g~~
 - 3.2.12.2.5.5. ~~Schematic drawing of the fuel tank with indication of capacity and material (petrol and ethanol engines only): ...~~
 - 3.2.12.2.5.6. ~~Description and schematic of the heat shield between tank and exhaust system: ...~~

Status: Point in time view as at 01/06/2017.

Changes to legislation: There are outstanding changes not yet made to Commission Regulation (EU) 2017/1151. Any changes that have already been made to the legislation appear in the content and are referenced with annotations. (See end of Document for details)

- (q) Points 3.2.12.2.6.4. to 3.2.12.2.6.4.4. shall be deleted
- (r) Points 3.2.12.2.6.5. and 3.2.12.2.6.6. shall be renumbered to read:
- 3.2.12.2.6.4. Make of particulate trap: ...
- 3.2.12.2.6.5. Identifying part number: ...
- (s) Points 3.2.12.2.8. shall be amended to read:
- 3.2.12.2.8. Other system: ...
- (t) New points 3.2.12.2.10. to 3.2.12.2.11.8. shall be added as follows:
- 3.2.12.2.10. Periodically regenerating system: (provide the information below for each separate unit)
- 3.2.12.2.11. Method or system of regeneration, description and/or drawing: ...
- 3.2.12.2.11.1. The number of Type 1 operating cycles, or equivalent engine test bench cycles, between two cycles where regenerative phases occur under the conditions equivalent to Type 1 test (Distance “D” in Figure A6.App1/1 in Appendix 1 to Sub-Annex 6 of Annex XXI to Regulation (EU) 2017/1151 or figure A13/1 in Annex 13 to UN/ECE Regulation 83 (as applicable)): ...
- 3.2.12.2.11.2. Applicable Type 1 cycle: (indicate the applicable procedure: Annex XXI, Sub-Annex 4 or UN/ECE Regulation 83): ...
- 3.2.12.2.11.3. Description of method employed to determine the number of cycles between two cycles where regenerative phases occur: ...
- 3.2.12.2.11.4. Parameters to determine the level of loading required before regeneration occurs (i.e. temperature, pressure etc.): ...
- 3.2.12.2.11.5. Description of method used to load system in the test procedure described in paragraph 3.1., Annex 13 to UN/ECE Regulation 83: ...
- 3.2.12.2.11.6. Catalytic converter systems using consumable reagents (provide the information below for each separate unit) yes/no ⁽¹⁾
- 3.2.12.2.11.6.1. Type and concentration of reagent needed: ...
- 3.2.12.2.11.6.2. Normal operational temperature range of reagent: ...
- 3.2.12.2.11.6.3. International standard: ...
- 3.2.12.2.11.6.4. Frequency of reagent refill: continuous/maintenance (where appropriate):
- 3.2.12.2.11.6.5. Reagent indicator: (description and location)
- 3.2.12.2.11.6.6. Reagent tank
- 3.2.12.2.11.6.7. Capacity: ...
- 3.2.12.2.11.6.8. Heating system: yes/no ⁽¹⁾
- 3.2.12.2.11.6.9. Description or drawing
- 3.2.12.2.11.7. Reagent control unit: yes/no ⁽¹⁾
- 3.2.12.2.11.8. Make: ...

Status: Point in time view as at 01/06/2017.

Changes to legislation: There are outstanding changes not yet made to Commission Regulation (EU) 2017/1151. Any changes that have already been made to the legislation appear in the content and are referenced with annotations. (See end of Document for details)

3.2.12.2. ~~Type~~ ...

3.2.12.2. ~~Reagent injector~~ (make, type and location): ...

- (u) Point 3.2.15.1. shall be amended to read:
3.2.15.1. Type-approval number according to Regulation (EC) No 661/2009 (OJ L 200, 31.7.2009, p. 1)
- (v) Point 3.2.16.1. shall be amended to read:
3.2.16.1. Type-approval number according to Regulation (EC) No 661/2009 (OJ L 200, 31.7.2009, p. 1)
- (w) Point 3.3. shall be amended to read:
3.3. Electric machine
- (x) Point 3.3.2. shall be amended to read:
3.3.2. REESS
- (y) Point 3.4. shall be amended to read:
3.4. Combinations of propulsion energy converters
- (z) Point 3.4.4. shall be amended to read:
3.4.4. Description of the energy storage device: (REESS, capacitor, flywheel/generator)
- (aa) Point 3.4.4.5. shall be amended to read:
3.4.4.5. Energy: ... (for REESS: voltage and capacity Ah in 2 h, for capacitor: J, ...)
- (bb) Point 3.4.5. shall be amended to read:
3.4.5. Electric machine (describe each type of electric machine separately)
- (cc) Point 3.5. shall be amended to read:
3.5. Manufacturer's declared values for determination of CO₂ emissions/fuel consumption/electric consumption/electric range and details of eco-innovations (where applicable)^(o)
- (dd) Point 4.4. shall be amended to read:
4.4. Clutch(es)
- (ee) Point 4.6. shall be amended to read:
4.6. Gear ratios

Gear	Internal gearbox ratios (ratios of engine to gearbox output shaft revolutions)	Final drive ratio(s) (ratio of gearbox output shaft to driven wheel revolutions)	Total gear ratios

Status: Point in time view as at 01/06/2017.

Changes to legislation: There are outstanding changes not yet made to Commission Regulation (EU) 2017/1151. Any changes that have already been made to the legislation appear in the content and are referenced with annotations. (See end of Document for details)

Maximum for CVT			
1			
2			
3			
...			
Minimum for CVT			

(ff) Point 6.6. to 6.6.3. shall be replaced as follows:

6.6. Tyres and wheels

6.6.1. Tyre/wheel combination(s)

6.6.1.1. Axles

6.6.1.1.1. Axle 1: ...

6.6.1.1.1. Tyre size designation

6.6.1.1.2. Axle 2: ...

6.6.1.1.2. Tyre size designation

etc.

6.6.2. Upper and lower limits of rolling radii

6.6.2.1. Axle 1: ...

6.6.2.2. Axle 2: ...

etc.

6.6.3. Tyre pressure(s) as recommended by the vehicle manufacturer: ... kPa

(gg) Point 9.1. shall be amended to read:

9.1. Type of bodywork using the codes defined in Part C of Annex II of Directive 2007/46/EC: ...

2. In table 1 of Appendix 6 to Annex I of Regulation (EC) No 692/2008 the rows ZD to ZL and ZX, ZY are amended as follows:

ZD	Euro 6c	Euro 6-2	M, N1 class I	PI, CI			31.8.2018
ZE	Euro 6c	Euro 6-2	N1 class II	PI, CI			31.8.2019
ZF	Euro 6c	Euro 6-2	N1 class III, N2	PI, CI			31.8.2019
ZG	Euro 6d-TEMP	Euro 6-2	M, N1 class I	PI, CI			31.8.2018
ZH	Euro 6d-TEMP	Euro 6-2	N1 class II	PI, CI			31.8.2019

Status: Point in time view as at 01/06/2017.

Changes to legislation: There are outstanding changes not yet made to Commission Regulation (EU) 2017/1151. Any changes that have already been made to the legislation appear in the content and are referenced with annotations. (See end of Document for details)

ZI	Euro 6d-TEMP	Euro 6-2	N1 class III, N2	PI, CI			31.8.2019
ZJ	Euro 6d	Euro 6-2	M, N1 class I	PI, CI			31.8.2018
ZK	Euro 6d	Euro 6-2	N1 class II	PI, CI			31.8.2019
ZL	Euro 6d	Euro 6-2	N1 class III, N2	PI, CI			31.8.2019
ZX	n.a.	n.a.	All vehicles	Battery full electric	1.9.2009	1.1.2011	31.8.2019
ZY	n.a.	n.a.	All vehicles	Battery full electric	1.9.2009	1.1.2011	31.8.2019
ZZ	n.a.	n.a.	All vehicles using certificates according to point 2.1.1 of Annex I	PI, CI	1.9.2009	1.1.2011	31.8.2019

ANNEX XVIII

SPECIAL PROVISIONS REGARDING ANNEXES I, II, III, VIII AND IX TO DIRECTIVE 2007/46/EC

Amendments to Annex I of Directive 2007/46/EC

- (1) Annex I of Directive 2007/46/EC is hereby amended as follows:
- (a) Point 2.6.1. shall be amended to read:
- 2.6.1. Distribution of this mass among the axles and, in the case of a semi-trailer, a rigid drawbar trailer or a centre-axle trailer, the mass on the coupling:
- (a) minimum and maximum for each variant: ...
- (b) mass of each version (a matrix must be provided): ...
- (b) Points 3. to 3.1.1. shall be amended to read:
3. PROPULSION ENERGY CONVERTER (k)
- 3.1. Manufacturer of the propulsion energy converter(s): ...
- 3.1.1. Manufacturer's code (as marked on the propulsion energy converter or other means of identification): ...
- (c) Point 3.2.1.8. shall be amended to read:

Status: Point in time view as at 01/06/2017.

Changes to legislation: There are outstanding changes not yet made to Commission Regulation (EU) 2017/1151. Any changes that have already been made to the legislation appear in the content and are referenced with annotations. (See end of Document for details)

- 3.2.1.8. Rated engine power (n): ... kW at ... min⁻¹ (manufacturer's declared value)
- (d) A new point 3.2.2.1.1. shall be added as follows:
3.2.2.1.1. RON, unleaded: ...
- (e) Point 3.2.4.2.1. shall be amended to read:
3.2.4.2.1. System description (common rail/unit injectors/distribution pump etc.): ...
- (f) Point 3.2.4.2.3. shall be amended to read:
3.2.4.2.3. Injection/Delivery pump
- (g) Point 3.2.4.2.4. shall be amended to read:
3.2.4.2.4. Engine speed limitation control
- (h) Point 3.2.4.2.9.3. shall be amended to read:
3.2.4.2.9. Description of the system
- (i) A new point 3.2.4.2.9.3.1.1. shall be added as follows:
3.2.4.2.9.3.1.1. Software version of the ECU: ...
- (j) Points 3.2.4.2.9.3.6. to 3.2.4.2.9.3.8. shall be amended to read:
3.2.4.2.9.3.6. Make and type or working principle of water temperature sensor: ...
3.2.4.2.9.3.7. Make and type or working principle of air temperature sensor: ...
3.2.4.2.9.3.8. Make and type or working principle of air pressure sensor: ...
- (k) A new point 3.2.4.3.4.1.1. shall be added as follows:
3.2.4.3.4.1.1. Software version of the ECU: ...
- (l) Point 3.2.4.3.4.3. shall be amended to read:
3.2.4.3.4.3. Make and type or working principle of air-flow sensor: ...
- (m) Points 3.2.4.3.4.9. to 3.2.4.3.4.11. shall be amended to read:
3.2.4.3.4.9. Make and type or working principle of water temperature sensor: ...
3.2.4.3.4.10. Make and type or working principle of air temperature sensor: ...
3.2.4.3.4.11. Make and type or working principle of air pressure sensor: ...
- (n) Point 3.2.4.3.5. shall be amended to read:
3.2.4.3.5. Injectors
- (o) New points 3.2.4.4.2. and 3.2.4.4.3. shall be added as follows:
3.2.4.4.2. Make(s):
3.2.4.4.3. Type(s): ...
- (p) Points 3.2.12.2. to 3.2.12.2.1. shall be amended to read:

Status: Point in time view as at 01/06/2017.

Changes to legislation: There are outstanding changes not yet made to Commission Regulation (EU) 2017/1151. Any changes that have already been made to the legislation appear in the content and are referenced with annotations. (See end of Document for details)

3.2.12.2. Pollution control devices (if not covered by another heading)

3.2.12.2.1 Catalytic converter

- (q) Points 3.2.12.2.1.11. to 3.2.12.2.1.11.10 shall be deleted and replaced with the following new point:

3.2.12.2.1 Normal operating temperature range: ... °C

- (r) Points 3.2.12.2.2. to 3.2.12.2.2.5. shall be deleted and replaced with the following:

3.2.12.2.2 Sensors

3.2.12.2.2.1 Oxygen sensor: yes/no ⁽¹⁾

3.2.12.2.2.2 Make: ...

3.2.12.2.2.3 Location: ...

3.2.12.2.2.4 Control range:

3.2.12.2.2.5 Type or working principle: ...

3.2.12.2.2.6 Identifying part number: ...

3.2.12.2.2.7 NOx sensor: yes/no ⁽¹⁾

3.2.12.2.2.8 Make: ...

3.2.12.2.2.9 Type: ...

3.2.12.2.2.10 Location: ...

3.2.12.2.2.11 Particulate sensor: yes/no ⁽¹⁾

3.2.12.2.2.12 Make: ...

3.2.12.2.2.13 Type: ...

3.2.12.2.2.14 Location: ...

- (s) Points 3.2.12.2.4.1. to 3.2.12.2.4.2. shall be amended to read:

3.2.12.2.4 Characteristics (make, type, flow, high pressure / low pressure / combined pressure, etc.): ...

3.2.12.2.4 Water-cooled system (to be specified for each EGR system e.g. low pressure / high pressure / combined pressure: yes/no ⁽¹⁾)

- (t) Points 3.2.12.2.5. to 3.2.12.2.5.6. shall be amended to read:

3.2.12.2.5 Evaporative emissions control system (petrol and ethanol engines only): yes/no ⁽¹⁾

3.2.12.2.5 Detailed description of the devices:

3.2.12.2.5 Drawing of the evaporative control system: ...

3.2.12.2.5 Drawing of the carbon canister: ...

Status: Point in time view as at 01/06/2017.

Changes to legislation: There are outstanding changes not yet made to Commission Regulation (EU) 2017/1151. Any changes that have already been made to the legislation appear in the content and are referenced with annotations. (See end of Document for details)

- 3.2.12.2.5~~4~~ Mass of dry charcoal: ... g
- 3.2.12.2.5~~5~~ Schematic drawing of the fuel tank with indication of capacity and material (petrol and ethanol engines only): ...
- 3.2.12.2.5~~6~~ Description and schematic of the heat shield between tank and exhaust system: ...
- (u) Points 3.2.12.2.6.4. to 3.2.12.2.6.4.4. shall be deleted
- (v) Points 3.2.12.2.6.5. and 3.2.12.2.6.6. shall be renumbered to read:
- 3.2.12.2.6~~4~~ Make of particulate trap: ...
- 3.2.12.2.6~~5~~ Identifying part number: ...
- (w) Points 3.2.12.2.7. to 3.2.12.2.7.0.6. shall be amended to read:
- 3.2.12.2.7~~0~~ On-board-diagnostic (OBD) system: yes/no ⁽¹⁾: ...
- 3.2.12.2.7~~1~~ (Euro VI only) Number of OBD engine families within the engine family
- 3.2.12.2.7~~2~~ (Euro VI only) List of the OBD engine families (when applicable)
- 3.2.12.2.7~~3~~ (Euro VI only) Number of the OBD engine family the parent engine / the engine member belongs to: ...
- 3.2.12.2.7~~4~~ (Euro VI only) Manufacturer references of the OBD-Documentation required by Article 5(4)(c) and Article 9(4) of Regulation (EU) No 582/2011 and specified in Annex X to that Regulation for the purpose of approving the OBD system
- 3.2.12.2.7~~5~~ (Euro VI only) When appropriate, manufacturer reference of the Documentation for installing in a vehicle an OBD equipped engine system
- 3.2.12.2.7~~6~~ (Euro VI only) When appropriate, manufacturer reference of the documentation package related to the installation on the vehicle of the OBD system of an approved engine
- (x) In point 3.2.12.2.7.6.4.1. the heading ‘Low-duty vehicles’ shall be replaced with ‘Light-duty vehicles’
- (y) Points 3.2.12.2.8. shall be amended to read:
- 3.2.12.2.8~~0~~ Other system: ...
- (z) New points 3.2.12.2.8.2.3. to 3.2.12.2.8.2.5. are added as follows:
- 3.2.12.2.8~~1~~ Type of inducement system: no engine restart after countdown/no start after refuelling/fuel-lockout/performance restriction
- 3.2.12.2.8~~2~~ Description of the inducement system
- 3.2.12.2.8~~3~~ Equivalent to the average driving range of the vehicle with a complete tank of fuel: ... km
- (aa) A new point 3.2.12.2.8.4. shall be added as follows:
- 3.2.12.2.8~~4~~ (Euro VI only) List of the OBD engine families (when applicable): ...

Status: Point in time view as at 01/06/2017.

Changes to legislation: There are outstanding changes not yet made to Commission Regulation (EU) 2017/1151. Any changes that have already been made to the legislation appear in the content and are referenced with annotations. (See end of Document for details)

- (bb) New points 3.2.12.2.10. to 3.2.12.2.11.8. shall be added as follows:
- 3.2.12.2.10. Periodically regenerating system: (provide the information below for each separate unit)
 - 3.2.12.2.11. Method or system of regeneration, description and/or drawing:
 - 3.2.12.2.12. The number of Type 1 operating cycles, or equivalent engine test bench cycles, between two cycles where regenerative phases occur under the conditions equivalent to Type 1 test (Distance “D” in Figure A6.App1/1 in Appendix 1 to Sub-Annex 6 of Annex XXI to Regulation (EU) 2017/1151 or figure A13/1 in Annex 13 to UN/ECE Regulation 83 (as applicable)): ...
 - 3.2.12.2.13. Applicable Type 1 cycle (indicate the applicable procedure: Annex XXI, Sub-Annex 4 or UN/ECE Regulation 83): ...
 - 3.2.12.2.14. Description of method employed to determine the number of cycles between two cycles where regenerative phases occur: ...
 - 3.2.12.2.15. Parameters to determine the level of loading required before regeneration occurs (i.e. temperature, pressure etc.): ...
 - 3.2.12.2.16. Description of method used to load system in the test procedure described in paragraph 3.1., Annex 13 to UN/ECE Regulation 83:
 - 3.2.12.2.17. Catalytic converter systems using consumable reagents (provide the information below for each separate unit) yes/no ⁽¹⁾
 - 3.2.12.2.18. Type and concentration of reagent needed: ...
 - 3.2.12.2.19. Normal operational temperature range of reagent: ...
 - 3.2.12.2.20. International standard: ...
 - 3.2.12.2.21. Frequency of reagent refill: continuous/maintenance (where appropriate):
 - 3.2.12.2.22. Reagent indicator (description and location): ...
 - 3.2.12.2.23. Reagent tank
 - 3.2.12.2.24. Capacity: ...
 - 3.2.12.2.25. Heating system: yes/no
 - 3.2.12.2.26. Description or drawing: ...
 - 3.2.12.2.27. Reagent control unit: yes/no ⁽¹⁾
 - 3.2.12.2.28. Make: ...
 - 3.2.12.2.29. Type: ...
 - 3.2.12.2.30. Reagent injector (make type and location): ...
- (cc) Point 3.2.15.1. shall be amended to read:
- 3.2.15.1. Type-approval number according to Regulation (EC) No 661/2009 (OJ L 200, 31.7.2009, p. 1): ...
- (dd) Point 3.2.16.1. shall be amended to read:

Status: Point in time view as at 01/06/2017.

Changes to legislation: There are outstanding changes not yet made to Commission Regulation (EU) 2017/1151. Any changes that have already been made to the legislation appear in the content and are referenced with annotations. (See end of Document for details)

- 3.2.16.1. Type-approval number according to Regulation (EC) No 661/2009 (OJ L 200, 31.7.2009, p. 1): ...
- (ee) New points 3.2.20. to 3.2.20.2.4. shall be added as follows:
- 3.2.20. Heat storage information
- 3.2.20.1. Active heat storage device: yes/no
- 3.2.20.1.1 ~~E~~Enthalpy: ... (J)
- 3.2.20.2. Insulation materials
- 3.2.20.2.1 ~~I~~nsulation material: ...
- 3.2.20.2.2 ~~I~~nsulation volume: ...
- 3.2.20.2.3 ~~I~~nsulation weight: ...
- 3.2.20.2.4 ~~I~~nsulation location: ...
- (ff) Point 3.3. shall be amended to read:
- 3.3. Electric machine
- (gg) Point 3.3.2. shall be amended to read:
- 3.3.2. REESS
- (hh) Point 3.4. shall be amended to read:
- 3.4. Combinations of propulsion energy converters
- (ii) Point 3.4.4. shall be amended to read:
- 3.4.4. Description of the energy storage device: (REESS, capacitor, flywheel/generator)
- (jj) Point 3.4.4.5. shall be amended to read:
- 3.4.4.5. Energy: ... (for REESS: voltage and capacity Ah in 2 h, for capacitor: J, ...)
- (kk) Point 3.4.5. shall be amended to read:
- 3.4.5. Electric machine (describe each type of electric machine separately)
- (ll) Point 3.5. shall be amended to read:
- 3.5. Manufacturer's declared values for determination of CO₂ emissions/fuel consumption/electric consumption/electric range and details of eco-innovations (where applicable)(°)
- (mm) New points 3.5.7. to 3.5.8.3. are added as follows:
- 3.5.7. Manufacturer's declared values
- 3.5.7.1. Test vehicle parameters
- 3.5.7.1.1 Vehicle high
- 3.5.7.1.1.1 ~~C~~ycle Energy Demand: ... J

Status: Point in time view as at 01/06/2017.

Changes to legislation: There are outstanding changes not yet made to Commission Regulation (EU) 2017/1151. Any changes that have already been made to the legislation appear in the content and are referenced with annotations. (See end of Document for details)

3.5.7.1.1. ~~R~~oad load coefficients

3.5.7.1.1.1. ~~101~~... N

3.5.7.1.1.1. ~~112~~... N/(km/h)

3.5.7.1.1.1. ~~123~~... N/(km/h)²

3.5.7.1.2. Vehicle Low (if applicable)

3.5.7.1.2. ~~C~~ycle Energy Demand: ... J

3.5.7.1.2. ~~R~~oad load coefficients

3.5.7.1.2.1. ~~101~~... N

3.5.7.1.2.1. ~~112~~... N/(km/h)

3.5.7.1.2.1. ~~123~~... N/(km/h)²

3.5.7.1.3. Vehicle M (if applicable)

3.5.7.1.3. ~~C~~ycle Energy Demand: ... J

3.5.7.1.3. ~~R~~oad load coefficients

3.5.7.1.3.1. ~~101~~... N

3.5.7.1.3.1. ~~112~~... N/(km/h)

3.5.7.1.3.1. ~~123~~... N/(km/h)²

3.5.7.2. Combined CO₂ mass emissions

3.5.7.2.1. CO₂ mass emission for ICE

3.5.7.2.1. ~~V~~ehicle High: ... g/km

3.5.7.2.1. ~~V~~ehicle low (if applicable): ... g/km

3.5.7.2.2. Charge Sustaining CO₂ mass emission for OVC-HEVs and NOVC-HEVs

3.5.7.2.2. ~~V~~ehicle high: ... g/km

3.5.7.2.2. ~~V~~ehicle low (if applicable): ... g/km

3.5.7.2.2. ~~V~~ehicle M (if applicable): ... g/km

3.5.7.2.3. Charge Depleting CO₂ mass emission for OVC-HEVs

3.5.7.2.3. ~~V~~ehicle high: ... g/km

3.5.7.2.3. ~~V~~ehicle low (if applicable): ... g/km

3.5.7.2.3. ~~V~~ehicle M (if applicable): ... g/km

3.5.7.3. Electric range for electrified vehicles

3.5.7.3.1. Pure Electric Range (PER) for PEVs

3.5.7.3.1. ~~V~~ehicle high: ... km

Status: Point in time view as at 01/06/2017.

Changes to legislation: There are outstanding changes not yet made to Commission Regulation (EU) 2017/1151. Any changes that have already been made to the legislation appear in the content and are referenced with annotations. (See end of Document for details)

- 3.5.7.3.1. Vehicle low (if applicable): ... km
- 3.5.7.3.2. All Electric Range AER for OVC-HEVs
- 3.5.7.3.2. Vehicle high: ... km
- 3.5.7.3.2. Vehicle low (if applicable): ... km
- 3.5.7.3.2. Vehicle M (if applicable): ... km
- 3.5.7.4. Charge Sustaining fuel consumption (FCCS) for FCHVs
 - 3.5.7.4.1. Vehicle high: ... kg/100 km
 - 3.5.7.4.2. Vehicle low (if applicable): ... kg/100 km
 - 3.5.7.4.3. Vehicle M (if applicable): ... kg/100 km
- 3.5.7.5. Electric energy consumption for electrified vehicles
 - 3.5.7.5.1. Combined electric energy consumption (ECWLTC) for Pure electric vehicles
 - 3.5.7.5.1. Vehicle high: ... Wh/km
 - 3.5.7.5.1. Vehicle low (if applicable): ... Wh/km
 - 3.5.7.5.2. Utility factor weighted charge-depleting electric consumption ECAC,CD (combined)
 - 3.5.7.5.2. Vehicle high: ... Wh/km
 - 3.5.7.5.2. Vehicle low (if applicable): ... Wh/km
 - 3.5.7.5.2. Vehicle M (if applicable): ... Wh/km
- 3.5.8. Vehicle fitted with an eco-innovation within the meaning of Article 12 of Regulation (EC) No 443/2009 for M1 vehicles or Article 12 of Regulation (EU) No 510/2011 for N1 vehicles: yes/no (¹)
 - 3.5.8.1. Type/Variant/Version of the baseline vehicle as referred to in Article 5 of Regulation (EU) No 725/2011 for M1 vehicles or Article 5 of Regulation (EU) No 427/2014 for N1 vehicles (if applicable): ...
 - 3.5.8.2. Existence of interactions between different eco-innovations: yes/no (¹)
 - 3.5.8.3. Emissions data related to the use of eco-innovations (repeat the table for each reference fuel tested) (w1)

Decision approving of the eco-innovation (w ²)	Code of the eco-innovation (w ³)	1. CO ₂ emissions of the baseline vehicle (g/km)	2. CO ₂ emissions of the eco-innovation vehicle (g/km)	3. CO ₂ emissions of the baseline vehicle under type 1 test-	4. CO ₂ emissions of the eco-innovation vehicle under type	5. Usage factor (UF), e. temporal share of technology	CO ₂ emissions savings ((1 - 2) - (3 - 4))*5
--	--	---	---	---	---	---	---

Status: Point in time view as at 01/06/2017.

Changes to legislation: There are outstanding changes not yet made to Commission Regulation (EU) 2017/1151. Any changes that have already been made to the legislation appear in the content and are referenced with annotations. (See end of Document for details)

				cycle (^{w4})	1 test- cycle	usage in normal operation conditions	
xxxx/201x							
Total CO ₂ emissions saving (g/km)(^{w5})							

(nn) Point 4.4. shall be amended to read:

4.4. Clutch(es): ...

(oo) New points 4.5.1.1. to 4.5.1.5. shall be added as follows:

4.5.1.1. Predominant mode: yes/no (¹)

4.5.1.2. Best mode (if no predominant mode): ...

4.5.1.3. Worst mode (if no predominant mode): ...

4.5.1.4. Torque rating: ...

4.5.1.5. Number of clutches: ...

(pp) Point 4.6. shall be amended to read:

4.6. Gear ratios

Gear	Internal gearbox ratios (ratios of engine to gearbox output shaft revolutions)	Final drive ratio(s) (ratio of gearbox output shaft to driven wheel revolutions)	Total gear ratios
Maximum for CVT			
1			
2			
3			
...			
Minimum for CVT Reverse			

(qq) Point 6.6. to 6.6.5. shall be replaced as follows:

6.6. Tyres and wheels

6.6.1. Tyre/wheel combination(s)

6.6.1.1. Axles

Status: Point in time view as at 01/06/2017.

Changes to legislation: There are outstanding changes not yet made to Commission Regulation (EU) 2017/1151. Any changes that have already been made to the legislation appear in the content and are referenced with annotations. (See end of Document for details)

- 6.6.1.1.1. Axle 1: ...
 - 6.6.1.1.1. Tyre size designation: ...
 - 6.6.1.1.1. Load-capacity index: ...
 - 6.6.1.1.1. Speed category symbol (^f)
 - 6.6.1.1.1. Wheel rim size(s): ...
 - 6.6.1.1.1. Wheel off-set(s): ...
 - 6.6.1.1.2. Axle 2: ...
 - 6.6.1.1.2. Tyre size designation: ...
 - 6.6.1.1.2. Load-capacity index: ...
 - 6.6.1.1.2. Speed category symbol: ...
 - 6.6.1.1.2. Wheel rim size(s): ...
 - 6.6.1.1.2. Wheel off-set(s): ...
 - etc.
 - 6.6.1.2. Spare wheel, if any: ...
 - 6.6.2. Upper and lower limits of rolling radii
 - 6.6.2.1. Axle 1: ... mm
 - 6.6.2.2. Axle 2: ... mm
 - 6.6.2.3. Axle 3: ...mm
 - 6.6.2.4. Axle 4: ...mm
 - etc.
 - 6.6.3. Tyre pressure(s) as recommended by the vehicle manufacturer: ... kPa
 - 6.6.4. Chain/tyre/wheel combination on the front and/or rear axle that is suitable for the type of vehicle, as recommended by the manufacturer: ...
 - 6.6.5. Brief description of temporary use spare unit (if any): ...
- (rr) Point 9.1. shall be amended to read:
- 9.1. Type of bodywork using the codes defined in Part C of Annex II of Directive 2007/46/EC: ...
- (ss) Point 9.9.2.1. shall be amended to read:
- 9.9.2.1. Type and description of the device: ...

Amendments to Annex II of Directive 2007/46/EC

- (2) Annex II is hereby amended as follows:
 - (a) At the end of the two points 1.3.1 and 3.3.1 of part B of Annex II defining the criteria for ‘vehicle versions’ for M1 and N1 vehicles each, the following text should be added:

Status: Point in time view as at 01/06/2017.

Changes to legislation: There are outstanding changes not yet made to Commission Regulation (EU) 2017/1151. Any changes that have already been made to the legislation appear in the content and are referenced with annotations. (See end of Document for details)

As an alternative to the criteria (h), (i) and (j), the vehicles grouped into a version shall have all tests performed for the calculation of their CO₂ emissions, electric energy consumption and fuel consumptions according to the provisions of sub-Annex 6 to Annex XXI of Regulation (EU) 2017/1151 in common.

- (b) The following text shall be added at the end of point 3.3.1 of part B of Annex II
- (k) the existence of a unique set of innovative technologies, as specified in Article 12 of Regulation (EU) No 510/2011⁽³⁹⁾.

Amendments to Annex III of Directive 2007/46/EC

- (3) Annex III of Directive 2007/46/EC is hereby amended as follows:
- (a) Points 3. to 3.1.1. shall be amended to read:
3. PROPULSION ENERGY CONVERTER (k)
- 3.1. Manufacturer of the propulsion energy converter(s): ...
- 3.1.1. Manufacturer's code (as marked on the propulsion energy converter or other means of identification): ...
- (b) Point 3.2.1.8. shall be amended to read:
- 3.2.1.8. Rated engine power (n): ... kW at ... min⁻¹ (manufacturer's declared value)
- (c) Points 3.2.12.2. to 3.2.12.2.1. shall be amended to read:
- 3.2.12.2. Pollution control devices (if not covered by another heading)
- 3.2.12.2.1. Catalytic converter
- (d) Point 3.2.12.2.1.11. shall be deleted
- (e) Points 3.2.12.2.1.11.6. and 3.2.12.2.1.11.7. shall be deleted
- (f) Point 3.2.12.2.2. shall be deleted and replaced with the following new point:
- 3.2.12.2.2.1. Oxygen sensor: yes/no ⁽¹⁾
- (g) Point 3.2.12.2.5. shall be amended to read:
- 3.2.12.2.5. Evaporative emissions control system (petrol and ethanol engines only): yes/no ⁽¹⁾
- (h) Point 3.2.12.2.8. shall be amended to read:
- 3.2.12.2.8. Other system
- (i) New points 3.2.12.2.10. to 3.2.12.2.10.1. shall be added as follows:
- 3.2.12.2.10. Periodically regenerating system: (provide the information below for each separate unit)
- 3.2.12.2.10.1. Method or system of regeneration, description and/or drawing:
- (j) A new point 3.2.12.2.11.1. shall be added as follows:
- 3.2.12.2.11.1. Type and concentration of reagent needed: ...

Status: Point in time view as at 01/06/2017.

Changes to legislation: There are outstanding changes not yet made to Commission Regulation (EU) 2017/1151. Any changes that have already been made to the legislation appear in the content and are referenced with annotations. (See end of Document for details)

- (k) Point 3.3. shall be amended to read:
3.3. Electric machine
- (l) Point 3.3.2. shall be amended to read:
3.3.2. REESS
- (m) Point 3.4. shall be amended to read:
3.4. Combinations of propulsion energy converters
- (n) Points 3.5.4 to 3.5.5.6. shall be deleted.
- (o) Point 4.6. shall be amended to read:
4.6. Gear ratios

Gear	Internal gearbox ratios (ratios of engine to gearbox output shaft revolutions)	Final drive ratio(s) (ratio of gearbox output shaft to driven wheel revolutions)	Total gear ratios
Maximum for CVT			
1			
2			
3			
...			
Minimum for CVT Reverse			

- (p) Point 6.6.1. shall be amended to read:
6.6.1. Tyre/wheel combination(s)
- (q) Point 9.1. shall be amended to read:
9.1. Type of bodywork using the codes defined in Part C of Annex II of Directive 2007/46/EC: ...

Amendments to Annex VIII of Directive 2007/46/EC

- (4) Annex VIII of Directive 2007/46/EC is hereby amended as follows:

‘ANNEX VIII

TEST RESULTS

(To be completed by the type-approval authority and attached to the vehicle EC type-approval certificate)

In each case, the information must make clear to which variant and version it is applicable. One version may not have more than one result. However, a combination of several results per

Status: Point in time view as at 01/06/2017.

Changes to legislation: There are outstanding changes not yet made to Commission Regulation (EU) 2017/1151. Any changes that have already been made to the legislation appear in the content and are referenced with annotations. (See end of Document for details)

version indicating the worst case is permissible. In the latter case, a note shall state that for items marked (*) only worst case results are given.

1. Results of the sound level tests

Number of the base regulatory act and latest amending regulatory act applicable to the approval. In case of a regulatory act with two or more implementation stages, indicate also the implementation stage:

Variant/Version:
Moving (dB(A)/E):
Stationary (dB(A)/E):
at (min ⁻¹):

2. Results of the exhaust emission tests

2.1. Emissions from motor vehicles tested under the test procedure for light-duty vehicles

Indicate the latest amending regulatory act applicable to the approval. In case the regulatory act has two or more implementation stages, indicate also the implementation stage: ...

Fuel(s)⁽⁴⁰⁾ ... (diesel, petrol, LPG, NG, Bi-fuel: petrol/NG, LPG, NG/biomethane, Flex-fuel: petrol/ethanol...)

2.1.1. Type 1 test⁽⁴¹⁾, ⁽⁴²⁾ (vehicle emissions in the test cycle after a cold start)

NEDC AVERAGE VALUES, WLTP HIGHEST VALUES

Variant/Version:
CO (mg/km)
THC (mg/km)
NMHC (mg/km)
NO _x (mg/km)
THC + NO _x (mg/km)
Mass of particulate matter (PM) (mg/km)
Number of particles (PN) (#/km) ⁽¹⁾

AMBIENT TEMPERATURE CORRECTION TEST (ATCT)

ATCT Family	Interpolation family	Road Load Matrix family
...
...

Status: Point in time view as at 01/06/2017.

Changes to legislation: There are outstanding changes not yet made to Commission Regulation (EU) 2017/1151. Any changes that have already been made to the legislation appear in the content and are referenced with annotations. (See end of Document for details)

FAMILY CORRECTION FACTORS

ATCT Family	FCF
...	...
...	...

2.1.2. Type 2 test⁽⁴³⁾,⁽⁴⁴⁾ (emissions data required at type-approval for roadworthiness purposes)

Type 2, low idle test:

Variant/Version:
CO (% vol.)
Engine speed (min ⁻¹)
Engine oil temperature (°C)

Type 2, high idle test:

Variant/Version:
CO (% vol.)
Lambda Value
Engine speed (min ⁻¹)
Engine oil temperature (°C)

2.1.3. Type 3 test (emissions of crankcase gases): ...

2.1.4. Type 4 test (evaporative emissions): ... g/test

2.1.5. Type 5 test (durability of anti-pollution control devices):

— Ageing distance covered (km)(e.g. 160 000 km): ...

— Deterioration factor DF: calculated/fixed⁽⁴⁵⁾

— Values:

Variant/Version:
CO
THC
NMHC
NO _x
THC + NO _x

Status: Point in time view as at 01/06/2017.

Changes to legislation: There are outstanding changes not yet made to Commission Regulation (EU) 2017/1151. Any changes that have already been made to the legislation appear in the content and are referenced with annotations. (See end of Document for details)

Mass of particulate matter (PM)
Number of particles (PN) (1)

2.1.6. Type 6 test (average emissions at low ambient temperatures):

Variant/Version:
CO (g/km)
THC (g/km)

2.1.7. OBD: yes/no⁽⁴⁶⁾

2.2. Emissions from engines tested under the test procedure for heavy-duty vehicles.

Indicate the latest amending regulatory act applicable to the approval. In case the regulatory act has two or more implementation stages, indicate also the implementation stage: ...

Fuel(s)⁽⁴⁷⁾ ... (diesel, petrol, LPG, NG, ethanol ...)

2.2.1. Results of the ESC test⁽⁴⁸⁾, ⁽⁴⁹⁾, ⁽⁵⁰⁾

Variant/Version:
CO (mg/kWh)
THC (mg/kWh)
NO _x (mg/kWh)
NH ₃ (ppm) (1)
PM mass (mg/kWh)
PM number (#/kWh) (1)

2.2.2. Result of the ELR test⁽⁵¹⁾

Variant/Version:
Smoke value: ... m ⁻¹

2.2.3. Result of the ETC test⁽⁵²⁾, ⁽⁵³⁾

Variant/Version:
CO (mg/kWh)
THC (mg/kWh)

Status: Point in time view as at 01/06/2017.

Changes to legislation: There are outstanding changes not yet made to Commission Regulation (EU) 2017/1151. Any changes that have already been made to the legislation appear in the content and are referenced with annotations. (See end of Document for details)

NMHC (mg/kWh) ⁽¹⁾
CH ₄ (mg/kWh) ⁽¹⁾
NO _x (mg/kWh)
NH ₃ (ppm) ⁽¹⁾
PM mass (mg/kWh)
PM number (#/kWh) ⁽¹⁾

2.2.4. Idle test⁽⁵⁴⁾

Variant/Version:
CO (% vol.)
Lambda Value ⁽¹⁾
Engine speed (min ⁻¹)
Engine oil temperature (K)

2.3. Diesel smoke

Indicate the latest amending regulatory act applicable to the approval. In case the regulatory act has two or more implementation stages, indicate also the implementation stage: ...

2.3.1. Results of the test under free acceleration

Variant/Version:
Corrected value of the absorption coefficient (m ⁻¹)
Normal engine idling speed
Maximum engine speed
Oil temperature (min./max.)

3. Results of the CO₂ emission, fuel/electric energy consumption, and electric range tests

Number of the base regulatory act and the latest amending regulatory act applicable to the approval: ...

Status: Point in time view as at 01/06/2017.

Changes to legislation: There are outstanding changes not yet made to Commission Regulation (EU) 2017/1151. Any changes that have already been made to the legislation appear in the content and are referenced with annotations. (See end of Document for details)

3.1. Internal combustion engines, including not externally chargeable hybrid electric vehicles (NOVC)⁽⁵⁵⁾⁽⁵⁶⁾

Variant/Version:
CO ₂ mass emission (urban conditions) (g/km)
CO ₂ mass emission (extra-urban conditions) (g/km)
CO ₂ mass emission (combined) (g/km)
Fuel consumption (urban conditions) (l/100 km) ^a
Fuel consumption (extra-urban conditions) (l/100 km) ^b
Fuel consumption (combined) (l/100 km) ^c

a The unit “l/100 km” is replaced by “m³/100 km” for vehicles fuelled with NG and H2NG, and by “kg/100 km” for vehicles fuelled with hydrogen.

b The unit “l/100 km” is replaced by “m³/100 km” for vehicles fuelled with NG and H2NG, and by “kg/100 km” for vehicles fuelled with hydrogen.

c The unit “l/100 km” is replaced by “m³/100 km” for vehicles fuelled with NG and H2NG, and by “kg/100 km” for vehicles fuelled with hydrogen.

Interpolation family identifier ^a	Variant/versions
...	...
...	...
...	...

a The format for the Interpolation Family Identifier is provided in paragraph 5.0 of Annex XXI to Commission Regulation (EU) 2017/1151 of 1 June 2017 supplementing Regulation (EC) No 715/2007 of the European Parliament and of the Council on type-approval of motor vehicles with respect to emissions from light passenger and commercial vehicles (Euro 5 and Euro 6) and on access to vehicle repair and maintenance information, amending Directive 2007/46/EC of the European Parliament and of the Council, Commission Regulation (EC) No 692/2008 and Commission Regulation (EU) No 1230/2012 and repealing Regulation (EC) No 692/2008 (OJ L 175, 7.7.2017, p. 1).

Road Load Matrix family identifier ^a	Variant/versions
...	...
...	...

a The format for the Road Load Matrix Family Identifier is provided in paragraph 5.0 of Annex XXI to Regulation (EU) 2017/1151.

Status: Point in time view as at 01/06/2017.

Changes to legislation: There are outstanding changes not yet made to Commission Regulation (EU) 2017/1151. Any changes that have already been made to the legislation appear in the content and are referenced with annotations. (See end of Document for details)

...	...
a	The format for the Road Load Matrix Family Identifier is provided in paragraph 5.0 of Annex XXI to Regulation (EU) 2017/1151.

Results:	Interpolation family identifier			Road Load Matrix family identifier
	VH	VM (if applicable)	VL (if applicable)	V representative
CO ₂ mass emission LOW phase (g/km)	
CO ₂ mass emission MID phase (g/km)	
CO ₂ mass emission HIGH phase (g/km)	
CO ₂ mass emission EXTRA-HIGH phase (g/km)	
CO ₂ mass emission (combined) (g/km)	
Fuel consumption LOW phase (l/100 km m ³ /100 km kg/100 km)	
Fuel consumption MID phase (l/100 km m ³ /100 km kg/100 km)	
Fuel consumption HIGH phase (l/100 km m ³ /100 km kg/100 km)	
Fuel consumption	

Status: Point in time view as at 01/06/2017.

Changes to legislation: There are outstanding changes not yet made to Commission Regulation (EU) 2017/1151. Any changes that have already been made to the legislation appear in the content and are referenced with annotations. (See end of Document for details)

EXTRA-HIGH phase (l/100 km m ³ /100 km kg/100 km)				
Fuel consumption (combined) (l/100 km m ³ /100 km kg/100 km)	
f0	
f1	
f2	
RR	
Delta Cd*A (for VL if applicable compared to VH)	
Test Mass	

Repeat for each interpolation or road load matrix family.

3.2. Externally chargeable hybrid electric vehicles (OVC)⁽⁵⁷⁾

Variant/Version:
CO ₂ mass emission (Condition A, combined) (g/km)
CO ₂ mass emission (Condition B, combined) (g/km)
CO ₂ mass emission (weighted, combined) (g/km)
Fuel consumption (Condition A, combined) (l/100 km) ^(g)
Fuel consumption (Condition B, combined) (l/100 km) ^(g)

Status: Point in time view as at 01/06/2017.

Changes to legislation: There are outstanding changes not yet made to Commission Regulation (EU) 2017/1151. Any changes that have already been made to the legislation appear in the content and are referenced with annotations. (See end of Document for details)

Fuel consumption (weighted, combined) (l/100 km) (g)
Electric energy consumption (Condition A, combined) (Wh/km)
Electric energy consumption (Condition B, combined) (Wh/km)
Electric energy consumption (weighted and combined) (Wh/km)
Pure electric range (km)

Interpolation family number	Variant/versions
...	...
...	...
...	...

Road Load Matrix family identifier	Variant/versions
...	...
...	...
...	...

Results:	Interpolation family identifier			Road Load Matrix family identifier
	VH	VM (if applicable)	VL (if applicable)	V representative
CS CO ₂ mass emission LOW phase (g/km)	
CS CO ₂ mass emission MID phase (g/km)	
CS CO ₂ mass emission HIGH phase (g/km)	
CS CO ₂ mass emission	

Status: Point in time view as at 01/06/2017.

Changes to legislation: There are outstanding changes not yet made to Commission Regulation (EU) 2017/1151. Any changes that have already been made to the legislation appear in the content and are referenced with annotations. (See end of Document for details)

EXTRA-HIGH phase (g/km)				
CS CO ₂ mass emission (combined) (g/km)	
CD CO ₂ mass emission (combined) (g/km)				
CO ₂ mass emission (weighted, combined) (g/km)				
CS Fuel consumption LOW phase (l/100 km)	
CS Fuel consumption MID phase (l/100 km)	
CS Fuel consumption HIGH phase (l/100 km)	
CS Fuel consumption EXTRA-HIGH phase (l/100 km)	
CS Fuel consumption (combined) (l/100 km)	
CD Fuel consumption (combined) (l/100 km)	
Fuel consumption (weighted, combined) (l/100 km)	
EC _{AC,weighted}	

Status: Point in time view as at 01/06/2017.

Changes to legislation: There are outstanding changes not yet made to Commission Regulation (EU) 2017/1151. Any changes that have already been made to the legislation appear in the content and are referenced with annotations. (See end of Document for details)

EAER (combined)	
EAER _{city}	
f0	
f1	
f2	
RR	
Delta Cd*A (for VL or VM compared to VH)	
Test Mass	
Frontal area of the representative vehicle (m ²)				

Repeat for each interpolation family.

3.3. Pure electric vehicles⁽⁵⁸⁾

Variant/Version:
Electric energy consumption (Wh/km)
Range (km)

Interpolation family number	Variant/versions
...	...
...	...
...	...

Road Load Matrix family identifier	Variant/versions
...	...
...	...
...	...

Results:	Interpolation family identifier		Matrix family identifier
	VH	VL	V representative
Electric Consumption (Combined) (Wh/km)	

Status: Point in time view as at 01/06/2017.

Changes to legislation: There are outstanding changes not yet made to Commission Regulation (EU) 2017/1151. Any changes that have already been made to the legislation appear in the content and are referenced with annotations. (See end of Document for details)

Pure Electric Range (Combined) (km)	
Pure Electric Range (City) (km)	
f0	
f1	
f2	
RR	
Delta Cd*A (for VL compared to VH)	
Test Mass	
Frontal area of the representative vehicle (m ²)			

3.4. Hydrogen fuel cell vehicles⁽⁵⁹⁾

Variant/Version:
Fuel consumption (kg/100 km)

	Variant/Version:	Variant/Version:
Fuel Consumption (Combined) (kg/100 km)
f0
f1
f2
RR
Test Mass	...	

3.5. Output report(s) from the correlation tool in accordance with Implementing Regulation (EU) 2017/1152

Repeat for each interpolation or road load matrix family:

Interpolation family identifier or road load matrix family [Footnote: “Type Approval Number + Interpolation Family Sequence number”]: ...

VH report: ...

VL report (if applicable): ...

V representative: ...

Status: Point in time view as at 01/06/2017.

Changes to legislation: There are outstanding changes not yet made to Commission Regulation (EU) 2017/1151. Any changes that have already been made to the legislation appear in the content and are referenced with annotations. (See end of Document for details)

4. Results of the tests for vehicles fitted with eco-innovation(s)⁽⁶⁰⁾⁽⁶¹⁾⁽⁶²⁾

According to Regulation 83 (if applicable)

Decision approving of the eco-innovation ^a	Variant/Version ...		1. CO ₂ emissions of the baseline vehicle (g/km)	2. CO ₂ emissions of the eco-innovation vehicle (g/km)	3. CO ₂ emissions of the baseline vehicle under Type 1 test-cycle ^c	4. CO ₂ emissions of the eco-innovation vehicle under Type 1 test-cycle (= 3.5.1.3 of Annex I)	5. Usage factor (UF) i.e. temporal share of technology usage in normal operation conditions	CO ₂ emissions savings ((1 – 2) – (3 – 4)) * 5
	Code of the eco-innovation ^b	Type 1/I cycle (NEDC/WLTP)						
xxx/201x
...
...
Total CO ₂ emissions savings on NEDC(g/km) ^d								...

a (h4) Number of the Commission Decision approving the eco-innovation.

b (h5) Assigned in the Commission Decision approving the eco-innovation.

c (h6) If a modelling methodology is applied instead of the type 1 test cycle, this value shall be the one provided by the modelling methodology.

d (h7) Sum of the CO₂ emissions savings of each individual eco-innovation on Type I according UN/ECE Regulation No 83.

According to Annex XXI of Regulation (EU) 2017/1151 (if applicable)

Decision approving of the eco-innovation ^a	Variant/Version ...		1. CO ₂ emissions of the baseline vehicle (g/km)	2. CO ₂ emissions of the eco-innovation vehicle (g/km)	3. CO ₂ emissions of the baseline vehicle under Type 1 test-cycle ^c	4. CO ₂ emissions of the eco-innovation vehicle under Type 1 test-cycle (= 3.5.1.3 of Annex I)	5. Usage factor (UF) i.e. temporal share of technology usage in normal operation conditions	CO ₂ emissions savings ((1 – 2) – (3 – 4)) * 5
	Code of the eco-innovation ^b	Type 1/I cycle (NEDC/WLTP)						
xxx/201x
...
...
Total CO ₂ emissions savings on NEDC(g/km) ^d								...

a (h4) Number of the Commission Decision approving the eco-innovation.

b (h5) Assigned in the Commission Decision approving the eco-innovation.

c (h6) If a modelling methodology is applied instead of the type 1 test cycle, this value shall be the one provided by the modelling methodology.

d (h7) Sum of the CO₂ emissions savings of each individual eco-innovation on Type 1 according to Annex XXI, Sub-Annex 4 of Regulation (EU) 2017/1151.

Status: Point in time view as at 01/06/2017.

Changes to legislation: There are outstanding changes not yet made to Commission Regulation (EU) 2017/1151. Any changes that have already been made to the legislation appear in the content and are referenced with annotations. (See end of Document for details)

					1 test-cycle ^c	1 test-cycle	technology usage in normal operation conditions	
xxx/201x
...
...
Total CO ₂ emissions savings on WLTP(g/km) ^d								

a (h4) Number of the Commission Decision approving the eco-innovation.

b (h5) Assigned in the Commission Decision approving the eco-innovation.

c (h6) If a modelling methodology is applied instead of the type 1 test cycle, this value shall be the one provided by the modelling methodology.

d (h7) Sum of the CO₂ emissions savings of each individual eco-innovation on Type 1 according to Annex XXI, Sub-Annex 4 of Regulation (EU) 2017/1151.

4.1. General code of the eco-innovation(s)⁽⁶³⁾: ...

Explanatory notes

^(h) Eco-innovations.

Amendments to Annex IX of Directive 2007/46/EC

(5) Annex IX of Directive 2007/46/EC is hereby replaced by the following text:

‘ANNEX IX

EC CERTIFICATE OF CONFORMITY

0. OBJECTIVES

The certificate of conformity is a statement delivered by the vehicle manufacturer to the buyer in order to assure him that the vehicle he has acquired complies with the legislation in force in the European Union at the time it was produced.

The certificate of conformity also serves the purpose to enable the competent authorities of the Member States to register vehicles without having to require the applicant to supply additional technical documentation.

For these purposes, the certificate of conformity has to include:

- (a) the Vehicle Identification Number;
- (b) the exact technical characteristics of the vehicle (i.e. it is not permitted to mention any range of value in the various entries).

1. GENERAL DESCRIPTION

1.1. The certificate of conformity shall consist of two parts.

Status: Point in time view as at 01/06/2017.

Changes to legislation: There are outstanding changes not yet made to Commission Regulation (EU) 2017/1151. Any changes that have already been made to the legislation appear in the content and are referenced with annotations. (See end of Document for details)

- (a) SIDE 1, which consists of a statement of compliance by the manufacturer. The same template is common to all vehicle categories.
 - (b) SIDE 2, which is a technical description of the main characteristics of the vehicle. The template of side 2 is adapted to each specific vehicle category.
- 1.2. The certificate of conformity shall be established in a maximum format A4 (210 × 297 mm) or a folder of maximum format A4.
 - 1.3. Without prejudice to the provisions in Section O(b), the values and units indicated in the second part shall be those given in the type-approval documentation of the relevant regulatory acts. In case of conformity of production checks the values shall be verified according to the methods laid down in the relevant regulatory acts. The tolerances allowed in those regulatory acts shall be taken into account.
2. SPECIAL PROVISIONS
- 2.1. Model A of the certificate of conformity (complete vehicle) shall cover vehicles which can be used on the road without requiring any further stage for their approval.
 - 2.2. Model B of the certificate of conformity (completed vehicles) shall cover vehicles which have undergone a further stage for their approval.

This is the normal result of the multi-stage approval process (e.g. a bus built by a second stage manufacturer on a chassis built by a vehicle manufacturer).

The additional features added during the multi-stage process shall be described briefly.

- 2.3. Model C of the certificate of conformity (incomplete vehicles) shall cover vehicles which need a further stage for their approval (e.g. truck chassis).

Except for tractors for semi-trailers, certificates of conformity covering chassis-cab vehicles belonging to category N shall be of Model C.

PART I

COMPLETE AND COMPLETED VEHICLES

MODEL COMPLETE VEHICLES

A1 —

SIDE 1

EC CERTIFICATE OF CONFORMITY

Side 1

The undersigned [... (*Full name and position*)] hereby certifies that the vehicle:

- 0.1. Make (Trade name of manufacturer): ...
- 0.2. Type: ...
 - Variant⁽⁶⁴⁾: ...
 - Version⁽⁶⁴⁾: ...
- 0.2.1. Commercial name: ...
- 0.4. Vehicle category: ...
- 0.5. Company name and address of manufacturer: ...

Status: Point in time view as at 01/06/2017.

Changes to legislation: There are outstanding changes not yet made to Commission Regulation (EU) 2017/1151. Any changes that have already been made to the legislation appear in the content and are referenced with annotations. (See end of Document for details)

0.6. Location and method of attachment of the statutory plates: ...

Location of the vehicle identification number: ...

0.9. Name and address of the manufacturer's representative (if any): ...

0.10. Vehicle identification number: ...

conforms in all respects to the type described in approval (... *type-approval number including extension number*) issued on (... *date of issue*) and

can be permanently registered in Member States having right/left⁽⁶⁵⁾ hand traffic and using metric/imperial⁽⁶⁶⁾ units for the speedometer and metric/imperial⁽⁶⁶⁾ units for the odometer (if applicable)⁽⁶⁷⁾.

(Place) (Date): ...	(Signature): ...
---------------------	------------------

MODEL COMPLETE VEHICLES TYPE-APPROVED IN SMALL SERIES

A2 —

SIDE 1

[Year]	[Sequential number]
--------	---------------------

EC CERTIFICATE OF CONFORMITY

Side 1

The undersigned [... (*Full name and position*)] hereby certifies that the vehicle:

0.1. Make (Trade name of manufacturer): ...

0.2. Type: ...

— Variant⁽⁶⁴⁾: ...

— Version⁽⁶⁴⁾: ...

0.2.1. Commercial name: ...

0.4. Vehicle category: ...

0.5. Company name and address of manufacturer: ...

0.6. Location and method of attachment of the statutory plates: ...

Location of the vehicle identification number: ...

0.9. Name and address of the manufacturer's representative (if any): ...

0.10. Vehicle identification number: ...

conforms in all respects to the type described in approval (... *type-approval number including extension number*) issued on (... *date of issue*) and

can be permanently registered in Member States having right/left (b) hand traffic and using metric/imperial⁽⁶⁶⁾ units for the speedometer and metric/imperial⁽⁶⁶⁾ units for the odometer (if applicable)⁽⁶⁷⁾.

Status: Point in time view as at 01/06/2017.

Changes to legislation: There are outstanding changes not yet made to Commission Regulation (EU) 2017/1151. Any changes that have already been made to the legislation appear in the content and are referenced with annotations. (See end of Document for details)

(Place) (Date): ...	(Signature): ...
---------------------	------------------

MODEL COMPLETED VEHICLES

B —

SIDE 1

EC CERTIFICATE OF CONFORMITY

Side 1

The undersigned [... (*Full name and position*)] hereby certifies that the vehicle:

- 0.1. Make (Trade name of the manufacturer): ...
- 0.2. Type: ...
 - Variant⁽⁶⁴⁾: ...
 - Version⁽⁶⁴⁾: ...
- 0.2.1. Commercial name: ...
- 0.2.2. For multi-stage approved vehicles, type-approval information of the base/previous stages vehicle (list the information for each stage):
 - Type: ...
 - Variant⁽⁶⁴⁾: ...
 - Version⁽⁶⁴⁾: ...

Type-approval number, extension number ...

- 0.4. Vehicle category: ...
- 0.5. Company name and address of manufacturer: ...
 - 0.5.1. For multi-stage approved vehicles, company name and address of the manufacturer of the base/previous stage(s) vehicle...
- 0.6. Location and method of attachment of the statutory plates: ...

Location of the vehicle identification number: ...

- 0.9. Name and address of the manufacturer's representative (if any): ...
- 0.10. Vehicle identification number: ...
 - (a) has been completed and altered⁽⁶⁸⁾ as follows: ... and
 - (b) conforms in all respects to the type described in approval (... *type-approval number including extension number*) issued on (... *date of issue*) and
 - (c) can be permanently registered in Member States having right/left⁽⁶⁵⁾ hand traffic and using metric/imperial⁽⁶⁶⁾ units for the speedometer and metric/imperial⁽⁶⁶⁾ units for the odometer (if applicable)⁽⁶⁷⁾.

(Place) (Date): ...	(Signature): ...
---------------------	------------------

Attachments: Certificate of conformity delivered at each previous stage.

SIDE 2

Status: Point in time view as at 01/06/2017.

Changes to legislation: There are outstanding changes not yet made to Commission Regulation (EU) 2017/1151. Any changes that have already been made to the legislation appear in the content and are referenced with annotations. (See end of Document for details)

VEHICLE (complete and completed vehicles)

CATEGORY

M1

Side 2

General construction characteristics

1. Number of axles: ... and wheels: ...
3. Powered axles (number, position, interconnection):

Main dimensions

4. Wheelbase⁽⁶⁹⁾: ... mm
- 4.1. Axle spacing:
 - 1-2: ... mm
 - 2-3: ... mm
 - 3-4: ... mm
5. Length: ... mm
6. Width: ... mm
7. Height: ... mm

Masses

13. Mass in running order: ... kg
- 13.2. Actual mass of the vehicle: ... kg
16. Technically permissible maximum masses
 - 16.1. Technically permissible maximum laden mass: ... kg
 - 16.2. Technically permissible mass on each axle:
 1. ... kg
 2. ... kg
 3. ... kg etc.
 - 16.4. Technically permissible maximum mass of the combination: ... kg
18. Technically permissible maximum towable mass in case of:
 - 18.1. Drawbar trailer: ... kg
 - 18.3. Centre-axle trailer: ... kg
 - 18.4. Unbraked trailer: ... kg
19. Technically permissible maximum static vertical mass at the coupling point: ... kg

Power plant

20. Manufacturer of the engine: ...
21. Engine code as marked on the engine: ...

Status: Point in time view as at 01/06/2017.

Changes to legislation: There are outstanding changes not yet made to Commission Regulation (EU) 2017/1151. Any changes that have already been made to the legislation appear in the content and are referenced with annotations. (See end of Document for details)

22. Working principle: ...
23. Pure electric: yes/no⁽⁶⁸⁾
- 23.1. Class of Hybrid [electric] vehicle: OVC-HEV/NOVC-HEV/OVC-FCHV/ NOVC-FCHV⁽⁶⁸⁾
24. Number and arrangement of cylinders: ...
25. Engine capacity: ... cm³
26. Fuel: Diesel/petrol/LPG/CNG-Biomethane/LNG/Ethanol/Biodiesel/Hydrogen⁽⁶⁸⁾
- 26.1. Mono fuel/Bi fuel/Flex fuel/Dual-fuel⁽⁶⁸⁾
- 26.2. (Dual-fuel only) Type 1A/Type 1B/Type 2A/Type 2B/Type 3B⁽⁶⁸⁾
27. Maximum power
- 27.1. Maximum net power⁽⁷⁰⁾: ... kW at ... min⁻¹ (internal combustion engine)⁽⁶⁸⁾
- 27.2. Maximum hourly output: ... kW (electric motor)⁽⁶⁸⁾⁽⁷¹⁾
- 27.3. Maximum net power: ... kW (electric motor)⁽⁶⁸⁾⁽⁷¹⁾
- 27.4. Maximum 30 minutes power: ... kW (electric motor)⁽⁶⁸⁾⁽⁷¹⁾
- Maximum speed*
29. Maximum speed: ... km/h
- Axles and suspension*
30. Axle(s) track:
1. ... mm
2. ... mm
3. ... mm
35. Tyre/wheel combination/Rolling Resistance Class (if applicable)⁽⁷²⁾: ...
- Brakes*
36. Trailer brake connections mechanical/electric/pneumatic/hydraulic⁽⁶⁸⁾
- Bodywork*
38. Code for bodywork⁽⁷³⁾: ...
40. Colour of vehicle⁽⁷⁴⁾: ...
41. Number and configuration of doors: ...
42. Number of seating positions (including the driver)⁽⁷⁵⁾: ...
- 42.1. Seat(s) designated for use only when the vehicle is stationary: ...
- 42.3. Number of wheelchair user accessible position: ...
- Environmental performances*

Status: Point in time view as at 01/06/2017.

Changes to legislation: There are outstanding changes not yet made to Commission Regulation (EU) 2017/1151. Any changes that have already been made to the legislation appear in the content and are referenced with annotations. (See end of Document for details)

- 46. Sound level
 - Stationary: ... dB(A) at engine speed: ... min⁻¹
 - Drive-by: ... dB(A)
- 47. Exhaust emission level⁽⁷⁶⁾: Euro ...
 - 47.1. Parameters for emission testing
 - 47.1.1. Test mass, kg: ...
 - 47.1.2. Frontal area, m²: ...
 - 47.1.3. Road load coefficients
 - 47.1.3.0. f0, N:
 - 47.1.3.1. f1, N/(km/h):
 - 47.1.3.2. f2, N/(km/h)²
- 48. Exhaust emissions⁽⁷⁷⁾⁽⁷⁸⁾⁽⁷⁹⁾:
 - Number of the base regulatory act and latest amending regulatory act applicable: ...
 - 1.1. test procedure: Type I or ESC⁽⁶⁸⁾
 - CO: HC: NO_x: HC + NO_x: Particulates:
 - Smoke opacity (ELR): ... (m⁻¹)
 - 1.2. test procedure: Type 1 (NEDC average values, WLTP highest values) or WHSC (EURO VI)⁽⁶⁸⁾
 - CO: ... THC: ... NMHC: ... NO_x: ... THC + NO_x: ... NH₃: ... Particulates (mass): ...
 - Particles (number): ...
 - 2.1. test procedure: ETC (if applicable)
 - CO: ... NO_x: ... NMHC: ... THC: ... CH₄: ... Particulates: ...
 - 2.2. test procedure: WHTC (EURO VI)
 - CO: ... NO_x: ... NMHC: ... THC: ... CH₄: ... NH₃: ... Particulates (mass): ... Particles (number): ...
 - 48.1. Smoke corrected absorption coefficient: ... (m⁻¹)
- 49. CO₂ emissions/fuel consumption/electric energy consumption⁽⁷⁷⁾⁽⁸⁰⁾:
 - 1. all power trains, except pure electric vehicles (if applicable)

NEDC values	CO ₂ emissions	Fuel consumption in case of emission testing according to Regulation (EC) No 692/2008
-------------	---------------------------	---

Status: Point in time view as at 01/06/2017.

Changes to legislation: There are outstanding changes not yet made to Commission Regulation (EU) 2017/1151. Any changes that have already been made to the legislation appear in the content and are referenced with annotations. (See end of Document for details)

Urban conditions ⁽¹⁾ :	... g/km	... l/100 km or m ³ /100 km or kg/100 km ⁽¹⁾
Extra-urban conditions ⁽¹⁾ :	... g/km	l/100 km or m ³ /100 km or kg/100 km ⁽¹⁾
Combined ⁽¹⁾ :	... g/km	... l/100 km or m ³ /100 km or kg/100 km ⁽¹⁾
Weighted ⁽¹⁾ , combined	... g/km	... l/100 km or m ³ /100 km or kg/100 km
Deviation factor (if applicable)		
Verification factor (if applicable)	“1” or “0”	

2. pure electric vehicles and OVC hybrid electric vehicles (if applicable)

Electric energy consumption (weighted, combined ⁽¹⁾)		... Wh/km
Electric range		... km

3. Vehicle fitted with eco-innovation(s): yes/no⁽⁶⁸⁾

3.1. General code of the eco-innovation(s)⁽⁸¹⁾: ...

3.2. Total CO₂ emissions savings due to the eco-innovation(s)⁽⁸²⁾ (repeat for each reference fuel tested):

3.2.1. NEDC savings: ...g/km (if applicable)

3.2.2. WLTP savings: ...g/km (if applicable)

4. all power trains, except pure electric vehicle, under Regulation (EU) 2017/1151 (if applicable)

WLTP values	CO ₂ emissions	Fuel consumption
Low ⁽¹⁾ :	... g/km	... l/100 km or m ³ /100 km or kg/100 km ⁽¹⁾
Medium ⁽¹⁾ :	... g/km	... l/100 km or m ³ /100 km or kg/100 km ⁽¹⁾
High ⁽¹⁾ :	... g/km	... l/100 km or m ³ /100 km or kg/100 km ⁽¹⁾
Extra High ⁽¹⁾ :	... g/km	... l/100 km or m ³ /100 km or kg/100 km ⁽¹⁾

Status: Point in time view as at 01/06/2017.

Changes to legislation: There are outstanding changes not yet made to Commission Regulation (EU) 2017/1151. Any changes that have already been made to the legislation appear in the content and are referenced with annotations. (See end of Document for details)

Combined:	... g/km	... l/100 km or m ³ /100 km or kg/100 km ⁽¹⁾
Weighted, combined ⁽¹⁾	... g/km	... l/100 km or m ³ /100 km or kg/100 km ⁽¹⁾

5. Pure electric vehicles and OVC hybrid electric vehicles, under Regulation (EU) 2017/1151 (if applicable)

5.1. Pure electric vehicles

Electric energy consumption		... Wh/km
Electric range		... km
Electric range city		... km

5.2 OVC hybrid electric vehicles

Electric energy consumption (EC _{AC,weighted})		... Wh/km
Electric range (EAER)		... km
Electric range city (EAER city)		... km

Miscellaneous

51. For special purpose vehicles: designation in accordance with Annex II Section 5: ...

52. Remarks⁽⁸³⁾: ...

Additional tyre/wheel combinations: technical parameters (no reference to RR)

SIDE 2

VEHICLE (complete and completed vehicles)

CATEGORY

M2

Side 2

General construction characteristics

1. Number of axles: ... and wheels: ...
- 1.1. Number and position of axles with twin wheels: ...
2. Steered axles (number, position): ...
3. Powered axles (number, position, interconnection):

Main dimensions

4. Wheelbase⁽⁶⁹⁾: ... mm
- 4.1. Axle spacing:

Status: Point in time view as at 01/06/2017.

Changes to legislation: There are outstanding changes not yet made to Commission Regulation (EU) 2017/1151. Any changes that have already been made to the legislation appear in the content and are referenced with annotations. (See end of Document for details)

- 1-2: ... mm
- 2-3: ... mm
- 3-4: ... mm
- 5. Length: ... mm
- 6. Width: ... mm
- 7. Height: ... mm
- 9. Distance between the front end of the vehicle and the centre of the coupling device: ... mm
- 12. Rear overhang: ... mm
- Masses*
- 13. Mass in running order: ... kg
- 13.1. Distribution of this mass amongst the axles:
 - 1. ... kg
 - 2. ... kg
 - 3. ... kg etc.
- 13.2. Actual mass of the vehicle: ... kg
- 16. Technically permissible maximum masses
- 16.1. Technically permissible maximum laden mass: ... kg
- 16.2. Technically permissible mass on each axle:
 - 1. ... kg
 - 2. ... kg
 - 3. ... kg etc.
- 16.3. Technically permissible mass on each axle group:
 - 1. ... kg
 - 2. ... kg
 - 3. ... kg etc.
- 16.4. Technically permissible maximum mass of the combination: ... kg
- 17. Intended registration/in service maximum permissible masses in national/international traffic⁽⁶⁸⁾⁽⁸⁴⁾
- 17.1. Intended registration/in service maximum permissible laden mass: ... kg
- 17.2. Intended registration/in service maximum permissible laden mass on each axle:
 - 1. ... kg
 - 2. ... kg

Status: Point in time view as at 01/06/2017.

Changes to legislation: There are outstanding changes not yet made to Commission Regulation (EU) 2017/1151. Any changes that have already been made to the legislation appear in the content and are referenced with annotations. (See end of Document for details)

3. ... kg etc.
 - 17.3. Intended registration/in service maximum permissible laden mass on each axle group:
 1. ... kg
 2. ... kg
 3. ... kg etc.
 - 17.4. Intended registration/in service maximum permissible mass of the combination: ... kg
 18. Technically permissible maximum towable mass in case of:
 - 18.1. Drawbar trailer: ... kg
 - 18.3. Centre-axle trailer: ... kg
 - 18.4. Unbraked trailer: ... kg
 19. Technically permissible maximum static mass at the coupling point: ... kg
- Power plant*
20. Manufacturer of the engine: ...
 21. Engine code as marked on the engine: ...
 22. Working principle: ...
 23. Pure electric: yes/no⁽⁶⁸⁾
 - 23.1. Class of Hybrid [electric] vehicle: OVC-HEV/NOVC-HEV/OVC-FCHV/ NOVC-FCHV⁽⁶⁸⁾
 24. Number and arrangement of cylinders: ...
 25. Engine capacity: ... cm³
 26. Fuel: Diesel/petrol/LPG/CNG-Biomethane/LNG/Ethanol/Biodiesel/Hydrogen⁽⁶⁸⁾
 - 26.1. Mono fuel/Bi fuel/Flex fuel/Dual-fuel⁽⁶⁸⁾
 - 26.2. (Dual-fuel only) Type 1A/Type 1B/Type 2A/Type 2B/Type 3B⁽⁶⁸⁾
 27. Maximum power
 - 27.1. Maximum net power⁽⁷⁰⁾: ... kW at ... min⁻¹ (internal combustion engine)⁽⁶⁸⁾
 - 27.2. Maximum hourly output: ... kW (electric motor)⁽⁶⁸⁾⁽⁷¹⁾
 - 27.3. Maximum net power: ... kW (electric motor)⁽⁶⁸⁾⁽⁷¹⁾
 - 27.4. Maximum 30 minutes power: ... kW (electric motor)⁽⁶⁸⁾⁽⁷¹⁾
 28. Gearbox (type): ...
- Maximum speed*
29. Maximum speed: ... km/h
- Axles and suspension*

Status: Point in time view as at 01/06/2017.

Changes to legislation: There are outstanding changes not yet made to Commission Regulation (EU) 2017/1151. Any changes that have already been made to the legislation appear in the content and are referenced with annotations. (See end of Document for details)

30. Axle(s) track:
1. ... mm
 2. ... mm
 3. ... mm etc.
33. Drive axle(s) fitted with air suspension or equivalent: yes/no⁽⁶⁸⁾
35. Tyre/wheel combination/Rolling Resistance Class (if applicable)⁽⁷²⁾: ...
- Brakes*
36. Trailer brake connections mechanical/electric/pneumatic/hydraulic⁽⁶⁸⁾
37. Pressure in feed line for trailer braking system: ... bar
- Bodywork*
38. Code for bodywork⁽⁷³⁾: ...
39. Class of vehicle: class I/Class II/Class III/Class A/Class B⁽⁶⁸⁾
41. Number and configuration of doors: ...
42. Number of seating positions (including the driver)⁽⁷⁵⁾: ...
- 42.1. Seat(s) designated for use only when the vehicle is stationary: ...
 - 42.3. Number of wheelchair user accessible position: ...
43. Number of standing places: ...
- Coupling device*
44. Approval number or approval mark of coupling device (if fitted): ...
- 45.1. Characteristics values⁽⁶⁸⁾: D: .../ V: .../ S: .../ U: ...
- Environmental performances*
46. Sound level
- Stationary: ... dB(A) at engine speed: ... min⁻¹
- Drive-by: ... dB(A)
47. Exhaust emission level⁽⁷⁶⁾: Euro ...
- 47.1. Parameters for emission testing
 - 47.1.1. Test mass, kg: ...
 - 47.1.2. Frontal area, m²: ...
 - 47.1.3. Road load coefficients
 - 47.1.3.0. f₀, N:
 - 47.1.3.1. f₁, N/(km/h):
 - 47.1.3.2. f₂, N/(km/h)²

Status: Point in time view as at 01/06/2017.

Changes to legislation: There are outstanding changes not yet made to Commission Regulation (EU) 2017/1151. Any changes that have already been made to the legislation appear in the content and are referenced with annotations. (See end of Document for details)

48. Exhaust emissions⁽⁷⁷⁾⁽⁷⁸⁾⁽⁷⁹⁾:

Number of the base regulatory act and latest amending regulatory act applicable: ...

1.1. test procedure: Type I or ESC⁽⁶⁸⁾

CO: HC: NO x: HC + NO x: Particulates:

Smoke opacity (ELR): ... (m⁻¹)

1.2. test procedure: Type 1 (NEDC average values, WLTP highest values) or WHSC (EURO VI)⁽⁶⁸⁾

CO: ... THC: ... NMHC: ... NO_x: ... THC + NO_x: ... NH₃: ... Particulates (mass): ...

Particles (number): ...

2.1. test procedure: ETC (if applicable)

CO: ... NO_x: ... NMHC: ... THC: ... CH₄: ... Particulates: ...

2.2. test procedure: WHTC (EURO VI)

CO: ... NO_x: ... NMHC: ... THC: ... CH₄: ... NH₃: ... Particulates (mass): ... Particles (number): ...

48.1. Smoke corrected absorption coefficient: ... (m⁻¹)

49. CO₂ emissions/fuel consumption/electric energy consumption⁽⁷⁷⁾⁽⁸⁰⁾:

1. all power trains, except pure electric vehicles (if applicable)

NEDC values	CO ₂ emissions	Fuel consumption in case of emission testing under NEDC according to Regulation (EC) No 692/2008
Urban conditions ⁽¹⁾ :	... g/km	... l/100 km or m ³ /100 km or kg/100 km ⁽¹⁾
Extra-urban conditions ⁽¹⁾ :	... g/km	l/100 km or m ³ /100 km or kg/100 km ⁽¹⁾
Combined ⁽¹⁾ :	... g/km	... l/100 km or m ³ /100 km or kg/100 km ⁽¹⁾
Weighted ⁽¹⁾ , combined	... g/km	... l/100 km or m ³ /100 km or kg/100 km
Deviation factor (if applicable)		
Verification factor (if applicable)	“1” or “0”	

Status: Point in time view as at 01/06/2017.

Changes to legislation: There are outstanding changes not yet made to Commission Regulation (EU) 2017/1151. Any changes that have already been made to the legislation appear in the content and are referenced with annotations. (See end of Document for details)

2. pure electric vehicles and OVC hybrid electric vehicles (if applicable)

Electric energy consumption (weighted, combined ⁽¹⁾)		... Wh/km
Electric range		... km

3. Vehicle fitted with eco-innovation(s): yes/no⁽⁶⁸⁾

3.1. General code of the eco-innovation(s)⁽⁸¹⁾: ...

3.2. Total CO₂ emissions savings due to the eco-innovation(s)⁽⁸²⁾ (repeat for each reference fuel tested):

3.2.1. NEDC savings: ...g/km (if applicable)

3.2.2. WLTP savings: ...g/km (if applicable)

4. all power trains, except pure electric vehicle, under Regulation (EU) 2017/1151 (if applicable)

WLTP values	CO ₂ emissions	Fuel consumption
Low ⁽¹⁾ :	... g/km	... l/100 km or m ³ /100 km or kg/100 km ⁽¹⁾
Medium ⁽¹⁾ :	... g/km	... l/100 km or m ³ /100 km or kg/100 km ⁽¹⁾
High ⁽¹⁾ :	... g/km	... l/100 km or m ³ /100 km or kg/100 km ⁽¹⁾
Extra High ⁽¹⁾ :	... g/km	... l/100 km or m ³ /100 km or kg/100 km ⁽¹⁾
Combined:	... g/km	... l/100 km or m ³ /100 km or kg/100 km ⁽¹⁾
Weighted, combined ⁽¹⁾	... g/km	... l/100 km or m ³ /100 km or kg/100 km ⁽¹⁾

5. Pure electric vehicles and OVC hybrid electric vehicles, under Regulation (EU) 2017/1151 (if applicable)

5.1. Pure electric vehicles

Electric energy consumption		... Wh/km
Electric range		... km
Electric range city		... km

Status: Point in time view as at 01/06/2017.

Changes to legislation: There are outstanding changes not yet made to Commission Regulation (EU) 2017/1151. Any changes that have already been made to the legislation appear in the content and are referenced with annotations. (See end of Document for details)

5.2 OVC hybrid electric vehicles

Electric energy consumption (EC _{AC,weighted})		... Wh/km
Electric range (EAER)		... km
Electric range city (EAER city)		... km

Miscellaneous

51. For special purpose vehicles: designation in accordance with Annex II Section 5: ...

52. Remarks⁽⁸³⁾: ...

SIDE 2

~~VEHICLE~~(complete and completed vehicles)

CATEGORY

M3

Side 2

General construction characteristics

1. Number of axles: ... and wheels: ...
- 1.1. Number and position of axles with twin wheels: ...
2. Steered axles (number, position): ...
3. Powered axles (number, position, interconnection):

Main dimensions

4. Wheelbase⁽⁶⁹⁾: ... mm
- 4.1. Axle spacing:
 - 1-2: ... mm
 - 2-3: ... mm
 - 3-4: ... mm
5. Length: ... mm
6. Width: ... mm
7. Height: ... mm
9. Distance between the front end of the vehicle and the centre of the coupling device: ... mm
12. Rear overhang: ... mm

Masses

13. Mass in running order: ... kg
- 13.1. Distribution of this mass amongst the axles:
 1. ... kg

Status: Point in time view as at 01/06/2017.

Changes to legislation: There are outstanding changes not yet made to Commission Regulation (EU) 2017/1151. Any changes that have already been made to the legislation appear in the content and are referenced with annotations. (See end of Document for details)

2. ... kg
3. ... kg etc.
- 13.2. Actual mass of the vehicle: ... kg
16. Technically permissible maximum masses
 - 16.1. Technically permissible maximum laden mass: ... kg
 - 16.2. Technically permissible mass on each axle:
 1. ... kg
 2. ... kg
 3. ... kg etc.
 - 16.3. Technically permissible mass on each axle group:
 1. ... kg
 2. ... kg
 3. ... kg etc.
 - 16.4. Technically permissible maximum mass of the combination: ... kg
17. Intended registration/in service maximum permissible masses in national/international traffic⁽⁶⁸⁾⁽⁸⁴⁾
 - 17.1. Intended registration/in service maximum permissible laden mass: ... kg
 - 17.2. Intended registration/in service maximum permissible laden mass on each axle:
 1. ... kg
 2. ... kg
 3. ... kg
 - 17.3. Intended registration/in service maximum permissible laden mass on each axle group:
 1. ... kg
 2. ... kg
 3. ... kg
 - 17.4. Intended registration/in service maximum permissible mass of the combination: ... kg
18. Technically permissible maximum towable mass in case of:
 - 18.1. Drawbar trailer: ... kg
 - 18.3. Centre-axle trailer: ... kg
 - 18.4. Unbraked trailer: ... kg
19. Technically permissible maximum static mass at the coupling point: ... kg
Power plant
20. Manufacturer of the engine: ...

Status: Point in time view as at 01/06/2017.

Changes to legislation: There are outstanding changes not yet made to Commission Regulation (EU) 2017/1151. Any changes that have already been made to the legislation appear in the content and are referenced with annotations. (See end of Document for details)

21. Engine code as marked on the engine: ...
22. Working principle: ...
23. Pure electric: yes/no⁽⁶⁸⁾
- 23.1. Hybrid [electric] vehicle: yes/no⁽⁶⁸⁾
24. Number and arrangement of cylinders: ...
25. Engine capacity: ... cm³
26. Fuel: Diesel/petrol/LPG/CNG-Biomethane/LNG/Ethanol/Biodiesel/Hydrogen⁽⁶⁸⁾
- 26.1. Mono fuel/Bi fuel/Flex fuel/Dual-fuel⁽⁶⁸⁾
- 26.2. (Dual-fuel only) Type 1A/Type 1B/Type 2A/Type 2B/Type 3B⁽⁶⁸⁾
27. Maximum power
- 27.1. Maximum net power⁽⁷⁰⁾: ... kW at ... min⁻¹ (internal combustion engine)⁽⁶⁸⁾
- 27.2. Maximum hourly output: ... kW (electric motor)⁽⁶⁸⁾⁽⁷¹⁾
- 27.3. Maximum net power: ... kW (electric motor)⁽⁶⁸⁾⁽⁷¹⁾
- 27.4. Maximum 30 minutes power: ... kW (electric motor)⁽⁶⁸⁾⁽⁷¹⁾
28. Gearbox (type): ...
Maximum speed
29. Maximum speed: ... km/h
Axles and suspension
- 30.1. Track of each steered axle: ... mm
- 30.2. Track of all other axles: ... mm
32. Position of loadable axle(s): ...
33. Drive axle(s) fitted with air suspension or equivalent: yes/no⁽⁶⁸⁾
35. Tyre/wheel combination⁽⁷²⁾: ...
Brakes
36. Trailer brake connections mechanical/electric/pneumatic/hydraulic⁽⁶⁸⁾
37. Pressure in feed line for trailer braking system: ... bar
Bodywork
38. Code for bodywork⁽⁷³⁾: ...
39. Class of vehicle: class I/Class II/Class III/Class A/Class B⁽⁶⁸⁾
41. Number and configuration of doors: ...
42. Number of seating positions (including the driver)⁽⁷⁵⁾: ...
- 42.1. Seat(s) designated for use only when the vehicle is stationary: ...

Status: Point in time view as at 01/06/2017.

Changes to legislation: There are outstanding changes not yet made to Commission Regulation (EU) 2017/1151. Any changes that have already been made to the legislation appear in the content and are referenced with annotations. (See end of Document for details)

- 42.2. Number of passenger seating positions: ... (lower deck) ... (upper deck) (including the driver)
- 42.3. Number of wheelchair user accessible position: ...
43. Number of standing places: ...
Coupling device
44. Approval number or approval mark of coupling device (if fitted): ...
- 45.1. Characteristics values⁽⁶⁸⁾: D: .../ V: .../ S: .../ U: ...
Environmental performances
46. Sound level
Stationary: ... dB(A) at engine speed: ... min⁻¹
Drive-by: ... dB(A)
47. Exhaust emission level⁽⁷⁶⁾: Euro ...
- 47.1. Parameters for emission testing
- 47.1.1. Test mass, kg: ...
- 47.1.2. Frontal area, m²: ...
- 47.1.3. Road load coefficients
- 47.1.3.0. f_0 , N:
- 47.1.3.1. f_1 , N/(km/h):
- 47.1.3.2. f_2 , N/(km/h)²
48. Exhaust emissions⁽⁷⁷⁾⁽⁷⁸⁾⁽⁷⁹⁾:
- Number of the base regulatory act and latest amending regulatory act applicable: ...
- 1.1. test procedure: ESC
CO: ... HC: ... NO_x: ... HC + NO_x: ... Particulates: ...
Smoke opacity (ELR): ... (m⁻¹)
- 1.2. test procedure: WHSC (EURO VI)
CO: ... THC: ... NMHC: ... NO_x: ... THC + NO_x: ... NH₃: ... Particulates (mass): ... Particles (number): ...
- 2.1. test procedure: ETC (if applicable)
CO: ... NO_x: ... NMHC: ... THC: ... CH₄: ... Particulates: ...
- 2.2. test procedure: WHTC (EURO VI)
CO: ... NO_x: ... NMHC: ... THC: ... CH₄: ... NH₃: ... Particulates (mass): ... Particles (number): ...

Status: Point in time view as at 01/06/2017.

Changes to legislation: There are outstanding changes not yet made to Commission Regulation (EU) 2017/1151. Any changes that have already been made to the legislation appear in the content and are referenced with annotations. (See end of Document for details)

48.1. Smoke corrected absorption coefficient: ... (m⁻¹)

Miscellaneous

51. For special purpose vehicles: designation in accordance with Annex II Section 5: ...

52. Remarks⁽⁸³⁾: ...

SIDE 2

VEHICLE (complete and completed vehicles)

CATEGORY

N1

Side 2

General construction characteristics

1. Number of axles: ... and wheels: ...

1.1. Number and position of axles with twin wheels: ...

3. Powered axles (number, position, interconnection):

Main dimensions

4. Wheelbase⁽⁶⁹⁾: ... mm

4.1. Axle spacing:

1-2: ... mm

2-3: ... mm

3-4: ... mm

5. Length: ... mm

6. Width: ... mm

7. Height: ... mm.

8. Fifth wheel lead for semi-trailer towing vehicle (maximum and minimum): ... mm

9. Distance between the front end of the vehicle and the centre of the coupling device: ... mm

11. Length of the loading area: ... mm

Masses

13. Mass in running order: ... kg

13.1. Distribution of this mass amongst the axles:

1. ... kg

2. ... kg

3. ... kg

13.2. Actual mass of the vehicle: ... kg

14. Mass of the base vehicle in running order: ... kg⁽⁶⁸⁾⁽⁸⁵⁾

16. Technically permissible maximum masses

Status: Point in time view as at 01/06/2017.

Changes to legislation: There are outstanding changes not yet made to Commission Regulation (EU) 2017/1151. Any changes that have already been made to the legislation appear in the content and are referenced with annotations. (See end of Document for details)

- 16.1. Technically permissible maximum laden mass: ... kg
- 16.2. Technically permissible mass on each axle:
 - 1. ... kg
 - 2. ... kg
 - 3. ... kg etc.
- 16.4. Technically permissible maximum mass of the combination: ... kg
- 18. Technically permissible maximum towable mass in case of:
 - 18.1. Drawbar trailer: ... kg
 - 18.2. Semi-trailer: ... kg
 - 18.3. Centre-axle trailer: ... kg
 - 18.4. Unbraked trailer: ... kg
- 19. Technically permissible maximum static mass at the coupling point: ... kg
- Power plant*
 - 20. Manufacturer of the engine: ...
 - 21. Engine code as marked on the engine: ...
 - 22. Working principle: ...
 - 23. Pure electric: yes/no⁽⁶⁸⁾
 - 23.1. Class of Hybrid [electric] vehicle: OVC-HEV/NOVC-HEV/OVC-FCHV/ NOVC-FCHV⁽⁶⁸⁾
 - 24. Number and arrangement of cylinders: ...
 - 25. Engine capacity: ... cm³
 - 26. Fuel: Diesel/petrol/LPG/CNG-Biomethane/LNG/Ethanol/Biodiesel/Hydrogen⁽⁶⁸⁾
 - 26.1. Mono fuel/Bi fuel/Flex fuel/Dual-fuel⁽⁶⁸⁾
 - 26.2. (Dual-fuel only) Type 1A/Type 1B/Type 2A/Type 2B/Type 3B⁽⁶⁸⁾
 - 27. Maximum power
 - 27.1. Maximum net power⁽⁷⁰⁾: ... kW at ... min⁻¹ (internal combustion engine)⁽⁶⁸⁾
 - 27.2. Maximum hourly output: ... kW (electric motor)⁽⁶⁸⁾⁽⁷¹⁾
 - 27.3. Maximum net power: ... kW (electric motor)⁽⁶⁸⁾⁽⁷¹⁾
 - 27.4. Maximum 30 minutes power: ... kW (electric motor)⁽⁶⁸⁾⁽⁷¹⁾
 - 28. Gearbox (type): ...
- Maximum speed*
 - 29. Maximum speed: ... km/h

Status: Point in time view as at 01/06/2017.

Changes to legislation: There are outstanding changes not yet made to Commission Regulation (EU) 2017/1151. Any changes that have already been made to the legislation appear in the content and are referenced with annotations. (See end of Document for details)

Axles and suspension

30. Axle(s) track:

1. ... mm

2. ... mm

3. ... mm

35. Tyre/wheel combination/Rolling Resistance Class (if applicable)⁽⁷²⁾: ...

Brakes

36. Trailer brake connections mechanical/electric/pneumatic/hydraulic⁽⁶⁸⁾

37. Pressure in feed line for trailer braking system: ... bar

Bodywork

38. Code for bodywork⁽⁷³⁾: ...

40. Colour of vehicle⁽⁷⁴⁾: ...

41. Number and configuration of doors: ...

42. Number of seating positions (including the driver)⁽⁷⁵⁾: ...

Coupling device

44. Approval number or approval mark of coupling device (if fitted): ...

45.1. Characteristics values⁽⁶⁸⁾: D: .../ V: .../ S: .../ U: ...

Environmental performances

46. Sound level

Stationary: ... dB(A) at engine speed: ... min⁻¹

Drive-by: ... dB(A)

47. Exhaust emission level⁽⁷⁶⁾: Euro ...

47.1. Parameters for emission testing

47.1.1. Test mass, kg: ...

47.1.2. Frontal area, m²: ...

47.1.3. Road load coefficients

47.1.3.0. f₀, N:

47.1.3.1. f₁, N/(km/h):

47.1.3.2. f₂, N/(km/h)²

48. Exhaust emissions⁽⁷⁷⁾⁽⁷⁸⁾⁽⁷⁹⁾:

Number of the base regulatory act and latest amending regulatory act applicable: ...

1.1. test procedure: Type 1 or ESC⁽⁶⁸⁾

Status: Point in time view as at 01/06/2017.

Changes to legislation: There are outstanding changes not yet made to Commission Regulation (EU) 2017/1151. Any changes that have already been made to the legislation appear in the content and are referenced with annotations. (See end of Document for details)

CO: ... HC: ... NO_x: ... HC + NO_x: ... Particulates: ...

Smoke opacity (ELR): ... (m⁻¹)

1.2. test procedure: Type 1 (NEDC average values, WLTP highest values) or WHSC (EURO VI)⁽⁶⁸⁾

CO: ... THC: ... NMHC: ... NO_x: ... THC + NO_x: ... NH₃: ... Particulates (mass): ... Particles (number): ...

2.1. test procedure: ETC (if applicable)

CO: ... NO_x: ... NMHC: ... THC: ... CH₄: ... Particulates: ...

2.2. test procedure: WHTC (EURO VI)

CO: ... NO_x: ... NMHC: ... THC: ... CH₄: ... NH₃: ... Particulates (mass): ... Particles (number): ...

48.1. Smoke corrected absorption coefficient: ... (m⁻¹)

49. CO₂ emissions/fuel consumption/electric energy consumption⁽⁷⁷⁾⁽⁸⁰⁾:

1. all power trains, except pure electric vehicles (if applicable)

NEDC values	CO₂ emissions	Fuel consumption in case of emission testing according to Regulation (EC) No 692/2008
Urban conditions ⁽¹⁾ :	... g/km	... l/100 km or m ³ /100 km or kg/100 km ⁽¹⁾
Extra-urban conditions ⁽¹⁾ :	... g/km	l/100 km or m ³ /100 km or kg/100 km ⁽¹⁾
Combined ⁽¹⁾ :	... g/km	... l/100 km or m ³ /100 km or kg/100 km ⁽¹⁾
Weighted ⁽¹⁾ , combined	... g/km	... l/100 km or m ³ /100 km or kg/100 km
Deviation factor (if applicable)		

2. pure electric vehicles and OVC hybrid electric vehicles (if applicable)

Electric energy consumption (weighted, combined ⁽¹⁾)		... Wh/km
Electric range		... km

3. Vehicle fitted with eco-innovation(s): yes/no⁽⁶⁸⁾

Status: Point in time view as at 01/06/2017.

Changes to legislation: There are outstanding changes not yet made to Commission Regulation (EU) 2017/1151. Any changes that have already been made to the legislation appear in the content and are referenced with annotations. (See end of Document for details)

- 3.1. General code of the eco-innovation(s)⁽⁸¹⁾: ...
- 3.2. Total CO₂ emissions saving due to the eco-innovation(s)⁽⁸²⁾ (repeat for each reference fuel tested):
 - 3.2.1. NEDC savings: ... g/km (if applicable)
 - 3.2.2. WLTP savings: ... g/km (if applicable)
- 4. all power trains except pure electric vehicles under Regulation (EU) 2017/1151

WLTP values	CO ₂ emissions	Fuel consumption
Low ⁽¹⁾ :	... g/km	... l/100 km or m ³ /100 km or kg/100 km ⁽¹⁾
Medium ⁽¹⁾ :	... g/km	... l/100 km or m ³ /100 km or kg/100 km ⁽¹⁾
High ⁽¹⁾ :	... g/km	... l/100 km or m ³ /100 km or kg/100 km ⁽¹⁾
Extra High ⁽¹⁾ :	... g/km	... l/100 km or m ³ /100 km or kg/100 km ⁽¹⁾
Combined:	... g/km	... l/100 km or m ³ /100 km or kg/100 km ⁽¹⁾
Weighted, combined ⁽¹⁾	... g/km	... l/100 km or m ³ /100 km or kg/100 km ⁽¹⁾

- 5. Pure electric vehicles and OVC hybrid electric vehicles, under Regulation (EU) 2017/1151 (if applicable)
 - 5.1. Pure electric vehicles⁽⁶⁸⁾ or (if applicable)

Electric energy consumption		... Wh/km
Electric range		... km
Electric range city		... km

- 5.2 OVC hybrid electric vehicles⁽⁶⁸⁾ or (if applicable)

Electric energy consumption (EC _{AC,weighted})		... Wh/km
Electric range (EAER)		... km
Electric range city (EAER city)		... km

Status: Point in time view as at 01/06/2017.

Changes to legislation: There are outstanding changes not yet made to Commission Regulation (EU) 2017/1151. Any changes that have already been made to the legislation appear in the content and are referenced with annotations. (See end of Document for details)

Miscellaneous

50. Type-approved according to the design requirements for transporting dangerous goods: yes/class(es): .../no⁽⁷⁶⁾:
51. For special purpose vehicles: designation in accordance with Annex II Section 5: ...
52. Remarks⁽⁸³⁾: ...

List of tyres: technical parameters (no reference to RR)

SIDE 2

VEHICLE (complete and completed vehicles)

CATEGORY

N2

Side 2

General construction characteristics

1. Number of axles: ... and wheels: ...
- 1.1. Number and position of axles with twin wheels: ...
2. Steered axles (number, position): ...
3. Powered axles (number, position, interconnection):

Main dimensions

4. Wheelbase⁽⁶⁹⁾: ... mm
- 4.1. Axle spacing:
 - 1-2: ... mm
 - 2-3: ... mm
 - 3-4: ... mm
5. Length: ... mm
6. Width: ... mm
7. Height: ... mm
8. Fifth wheel lead for semi-trailer towing vehicle (maximum and minimum): ... mm
9. Distance between the front end of the vehicle and the centre of the coupling device: ... mm
11. Length of the loading area: ... mm
12. Rear overhang: ... mm

Masses

13. Mass in running order: ... kg
- 13.1. Distribution of this mass amongst the axles:
 1. ... kg
 2. ... kg

Status: Point in time view as at 01/06/2017.

Changes to legislation: There are outstanding changes not yet made to Commission Regulation (EU) 2017/1151. Any changes that have already been made to the legislation appear in the content and are referenced with annotations. (See end of Document for details)

3. ... kg
 - 13.2. Actual mass of the vehicle: ... kg
 16. Technically permissible maximum masses
 - 16.1. Technically permissible maximum laden mass: ... kg
 - 16.2. Technically permissible mass on each axle:
 1. ... kg
 2. ... kg
 3. ... kg etc.
 - 16.3. Technically permissible mass on each axle group:
 1. ... kg
 2. ... kg
 3. ... kg etc.
 - 16.4. Technically permissible maximum mass of the combination: ... kg
 17. Intended registration/in service maximum permissible masses in national/international traffic⁽⁶⁸⁾⁽⁸⁴⁾
 - 17.1. Intended registration/in service maximum permissible laden mass: ... kg
 - 17.2. Intended registration/in service maximum permissible laden mass on each axle:
 1. ... kg
 2. ... kg
 3. ... kg
 - 17.3. Intended registration/in service maximum permissible laden mass on each axle group:
 1. ... kg
 2. ... kg
 3. ... kg
 - 17.4. Intended registration/in service maximum permissible mass of the combination: ... kg
 18. Technically permissible maximum towable mass in case of:
 - 18.1. Drawbar trailer: ... kg
 - 18.2. Semi-trailer: ... kg
 - 18.3. Centre-axle trailer: ... kg
 - 18.4. Unbraked trailer: ... kg
 19. Technically permissible maximum static mass at the coupling point: ... kg
- Power plant*
20. Manufacturer of the engine: ...

Status: Point in time view as at 01/06/2017.

Changes to legislation: There are outstanding changes not yet made to Commission Regulation (EU) 2017/1151. Any changes that have already been made to the legislation appear in the content and are referenced with annotations. (See end of Document for details)

- 21. Engine code as marked on the engine: ...
- 22. Working principle: ...
- 23. Pure electric: yes/no⁽⁶⁸⁾
- 23.1. Class of Hybrid [electric] vehicle: OVC-HEV/NOVC-HEV/OVC-FCHV/ NOVC-FCHV⁽⁶⁸⁾
- 24. Number and arrangement of cylinders: ...
- 25. Engine capacity: ... cm³
- 26. Fuel: Diesel/petrol/LPG/CNG-Biomethane/LNG/Ethanol/Biodiesel/Hydrogen⁽⁶⁸⁾
- 26.1. Mono fuel/Bi fuel/Flex fuel/Dual-fuel⁽⁶⁸⁾
- 26.2. (Dual-fuel only) Type 1A/Type 1B/Type 2A/Type 2B/Type 3B⁽⁶⁸⁾
- 27. Maximum power
- 27.1. Maximum net power⁽⁷⁰⁾: ... kW at ... min⁻¹ (internal combustion engine)⁽⁶⁸⁾
- 27.2. Maximum hourly output: ... kW (electric motor)⁽⁶⁸⁾⁽⁷¹⁾
- 27.3. Maximum net power: ... kW (electric motor)⁽⁶⁸⁾⁽⁷¹⁾
- 27.4. Maximum 30 minutes power: ... kW (electric motor)⁽⁶⁸⁾⁽⁷¹⁾
- 28. Gearbox (type): ...
- Maximum speed*
- 29. Maximum speed: ... km/h
- Axles and suspension*
- 31. Position of lift axle(s): ...
- 32. Position of loadable axle(s): ...
- 33. Drive axle(s) fitted with air suspension or equivalent: yes/no⁽⁶⁸⁾
- 35. Tyre/wheel combination/Rolling Resistance Class (if applicable)⁽⁷²⁾: ...
- Brakes*
- 36. Trailer brake connections mechanical/electric/pneumatic/hydraulic⁽⁶⁸⁾
- 37. Pressure in feed line for trailer braking system: ... bar
- Bodywork*
- 38. Code for bodywork⁽⁷³⁾: ...
- 41. Number and configuration of doors: ...
- 42. Number of seating positions (including the driver)⁽⁷⁵⁾: ...
- Coupling device*
- 44. Approval number or approval mark of coupling device (if fitted): ...

Status: Point in time view as at 01/06/2017.

Changes to legislation: There are outstanding changes not yet made to Commission Regulation (EU) 2017/1151. Any changes that have already been made to the legislation appear in the content and are referenced with annotations. (See end of Document for details)

45.1. Characteristics values⁽⁶⁸⁾: D: .../ V: .../ S: .../ U: ...
Environmental performances

46. Sound level

Stationary: ... dB(A) at engine speed: ... min⁻¹

Drive-by: ... dB(A)

47. Exhaust emission level⁽⁷⁶⁾: Euro ...

47.1. Parameters for emission testing

47.1.1. Test mass, kg: ...

47.1.2. Frontal area, m²: ...

47.1.3. Road load coefficients

47.1.3.0. f₀, N:

47.1.3.1. f₁, N/(km/h):

47.1.3.2. f₂, N/(km/h)²

48. Exhaust emissions⁽⁷⁷⁾⁽⁷⁸⁾⁽⁷⁹⁾:

Number of the base regulatory act and latest amending regulatory act applicable: ...

1.1. test procedure: Type 1 or ESC⁽⁶⁸⁾

CO: ... HC: ... NO_x: ... HC + NO_x: ... Particulates: ...

Smoke opacity (ELR): ... (m⁻¹)

1.2. test procedure: Type 1 (NEDC average values, WLTP highest values) or WHSC (EURO VI)⁽⁶⁸⁾

CO: ... THC: ... NMHC: ... NO_x: ... THC + NO_x: ... NH₃: ... Particulates (mass): ... Particles (number): ...

2.1. test procedure: ETC (if applicable)

CO: ... NO_x: ... NMHC: ... THC: ... CH₄: ... Particulates: ...

2.2. test procedure: WHTC (EURO VI)

CO: ... NO_x: ... NMHC: ... THC: ... CH₄: ... NH₃: ... Particulates (mass): ... Particles (number): ...

48.1. Smoke corrected absorption coefficient: ... (m⁻¹)

49. CO₂ emissions/fuel consumption/electric energy consumption⁽⁷⁷⁾⁽⁸⁰⁾:

1. all power trains, except pure electric vehicles (if applicable)

NEDC values

CO₂ emissions

**Fuel consumption in
case of emission testing**

Status: Point in time view as at 01/06/2017.

Changes to legislation: There are outstanding changes not yet made to Commission Regulation (EU) 2017/1151. Any changes that have already been made to the legislation appear in the content and are referenced with annotations. (See end of Document for details)

		according to Regulation (EC) No 692/2008
Urban conditions ⁽¹⁾ :	... g/km	... l/100 km or m ³ /100 km or kg/100 km ⁽¹⁾
Extra-urban conditions ⁽¹⁾ :	... g/km	l/100 km or m ³ /100 km or kg/100 km ⁽¹⁾
Combined ⁽¹⁾ :	... g/km	... l/100 km or m ³ /100 km or kg/100 km ⁽¹⁾
Weighted ⁽¹⁾ , combined	... g/km	... l/100 km or m ³ /100 km or kg/100 km
Deviation factor (if applicable)		

2. pure electric vehicles and OVC hybrid electric vehicles (if applicable)

Electric energy consumption (weighted, combined ⁽¹⁾)		... Wh/km
Electric range		... km

3. Vehicle fitted with eco-innovation(s): yes/no⁽⁶⁸⁾

3.1. General code of the eco-innovation(s)⁽⁸¹⁾: ...

3.2. Total CO₂ emissions saving due to the eco-innovation(s)⁽⁸²⁾ (repeat for each reference fuel tested):

3.2.1. NEDC savings: ... g/km (if applicable)

3.2.2. WLTP savings: ... g/km (if applicable)

4. all power trains except pure electric vehicles under Regulation (EU) 2017/1151

WLTP values	CO₂ emissions	Fuel consumption
Low ⁽¹⁾ :	... g/km	... l/100 km or m ³ /100 km or kg/100 km ⁽¹⁾
Medium ⁽¹⁾ :	... g/km	... l/100 km or m ³ /100 km or kg/100 km ⁽¹⁾
High ⁽¹⁾ :	... g/km	... l/100 km or m ³ /100 km or kg/100 km ⁽¹⁾
Extra High ⁽¹⁾ :	... g/km	... l/100 km or m ³ /100 km or kg/100 km ⁽¹⁾

Status: Point in time view as at 01/06/2017.

Changes to legislation: There are outstanding changes not yet made to Commission Regulation (EU) 2017/1151. Any changes that have already been made to the legislation appear in the content and are referenced with annotations. (See end of Document for details)

Combined:	... g/km	... l/100 km or m ³ /100 km or kg/100 km ⁽¹⁾
Weighted, combined ⁽¹⁾	... g/km	... l/100 km or m ³ /100 km or kg/100 km ⁽¹⁾

5. Pure electric vehicles and OVC hybrid electric vehicles, under Regulation (EU) 2017/1151 (if applicable)

5.1. Pure electric vehicles⁽⁶⁸⁾ or (if applicable)

Electric energy consumption		... Wh/km
Electric range		... km
Electric range city		... km

5.2 OVC hybrid electric vehicles⁽⁶⁸⁾ or (if applicable)

Electric energy consumption (EC _{AC,weighted})		... Wh/km
Electric range (EAER)		... km
Electric range city (EAER city)		... km

Miscellaneous

50. Type-approved according to the design requirements for transporting dangerous goods: yes/class(es): .../no⁽⁷⁶⁾:

51. For special purpose vehicles: designation in accordance with Annex II Section 5: ...

52. Remarks⁽⁸³⁾: ...

SIDE 2

VEHICLE (complete and completed vehicles)

CATEGORY

N3

Side 2

General construction characteristics

1. Number of axles: ... and wheels: ...

1.1. Number and position of axles with twin wheels: ...

2. Steered axles (number, position): ...

3. Powered axles (number, position, interconnection):

Main dimensions

4. Wheelbase⁽⁶⁹⁾: ... mm

Status: Point in time view as at 01/06/2017.

Changes to legislation: There are outstanding changes not yet made to Commission Regulation (EU) 2017/1151. Any changes that have already been made to the legislation appear in the content and are referenced with annotations. (See end of Document for details)

- 4.1. Axle spacing:
 - 1-2: ... mm
 - 2-3: ... mm
 - 3-4: ... mm
 - 5. Length: ... mm
 - 6. Width: ... mm
 - 7. Height: ... mm
 - 8. Fifth wheel lead for semi-trailer towing vehicle (maximum and minimum): ... mm
 - 9. Distance between the front end of the vehicle and the centre of the coupling device: ... mm
 - 11. Length of the loading area: ... mm
 - 12. Rear overhang: ... mm
- Masses*
- 13. Mass in running order: ... kg
 - 13.1. Distribution of this mass amongst the axles:
 - 1. ... kg
 - 2. ... kg
 - 3. ... kg
 - 13.2. Actual mass of the vehicle: ... kg
 - 16. Technically permissible maximum masses
 - 16.1. Technically permissible maximum laden mass: ... kg
 - 16.2. Technically permissible mass on each axle:
 - 1. ... kg
 - 2. ... kg
 - 3. ... kg etc.
 - 16.3. Technically permissible mass on each axle group:
 - 1. ... kg
 - 2. ... kg
 - 3. ... kg etc.
 - 16.4. Technically permissible maximum mass of the combination: ... kg
 - 17. Intended registration/in service maximum permissible masses in national/international traffic⁽⁶⁸⁾⁽⁸⁴⁾
 - 17.1. Intended registration/in service maximum permissible laden mass: ... kg

Status: Point in time view as at 01/06/2017.

Changes to legislation: There are outstanding changes not yet made to Commission Regulation (EU) 2017/1151. Any changes that have already been made to the legislation appear in the content and are referenced with annotations. (See end of Document for details)

- 17.2. Intended registration/in service maximum permissible laden mass on each axle:
 - 1. ... kg
 - 2. ... kg
 - 3. ... kg
 - 17.3. Intended registration/in service maximum permissible laden mass on each axle group:
 - 1. ... kg
 - 2. ... kg
 - 3. ... kg
 - 17.4. Intended registration/in service maximum permissible mass of the combination: ... kg
 - 18. Technically permissible maximum towable mass in case of:
 - 18.1. Drawbar trailer: ... kg
 - 18.2. Semi-trailer: ... kg
 - 18.3. Centre-axle trailer: ... kg
 - 18.4. Unbraked trailer: ... kg
 - 19. Technically permissible maximum static mass at the coupling point: ... kg
- Power plant*
- 20. Manufacturer of the engine: ...
 - 21. Engine code as marked on the engine: ...
 - 22. Working principle: ...
 - 23. Pure electric: yes/no⁽⁶⁸⁾
 - 23.1. Hybrid [electric] vehicle: yes/no⁽⁶⁸⁾
 - 24. Number and arrangement of cylinders: ...
 - 25. Engine capacity: ... cm³
 - 26. Fuel: Diesel/petrol/LPG/CNG-Biomethane/LNG/Ethanol/Biodiesel/Hydrogen⁽⁶⁸⁾
 - 26.1. Mono fuel/Bi fuel/Flex fuel/Dual-fuel⁽⁶⁸⁾
 - 26.2. (Dual-fuel only) Type 1A/Type 1B/Type 2A/Type 2B/Type 3B⁽⁶⁸⁾
 - 27. Maximum power
 - 27.1. Maximum net power⁽⁷⁰⁾: ... kW at ... min⁻¹ (internal combustion engine)⁽⁶⁸⁾
 - 27.2. Maximum hourly output: ... kW (electric motor)⁽⁶⁸⁾⁽⁷¹⁾
 - 27.3. Maximum net power: ... kW (electric motor)⁽⁶⁸⁾⁽⁷¹⁾
 - 27.4. Maximum 30 minutes power: ... kW (electric motor)⁽⁶⁸⁾⁽⁷¹⁾

Status: Point in time view as at 01/06/2017.

Changes to legislation: There are outstanding changes not yet made to Commission Regulation (EU) 2017/1151. Any changes that have already been made to the legislation appear in the content and are referenced with annotations. (See end of Document for details)

28. Gearbox (type): ...

Maximum speed

29. Maximum speed: ... km/h

Axles and suspension

31. Position of lift axle(s): ...

32. Position of loadable axle(s): ...

33. Drive axle(s) fitted with air suspension or equivalent: yes/no⁽⁶⁸⁾

35. Tyre/wheel combination⁽⁷²⁾: ...

Brakes

36. Trailer brake connections mechanical/electric/pneumatic/hydraulic⁽⁶⁸⁾

37. Pressure in feed line for trailer braking system: ... bar

Bodywork

38. Code for bodywork⁽⁷³⁾: ...

41. Number and configuration of doors: ...

42. Number of seating positions (including the driver)⁽⁷⁵⁾: ...

Coupling device

44. Approval number or approval mark of coupling device (if fitted): ...

45.1. Characteristics values⁽⁶⁸⁾: D: .../ V: .../ S: .../ U: ...

Environmental performances

46. Sound level

Stationary: ... dB(A) at engine speed: ... min⁻¹

Drive-by: ... dB(A)

47. Exhaust emission level⁽⁷⁶⁾: Euro ...

47.1. Parameters for emission testing

47.1.1. Test mass, kg: ...

47.1.2. Frontal area, m²: ...

47.1.3. Road load coefficients

47.1.3.0. f₀, N:

47.1.3.1. f₁, N/(km/h):

47.1.3.2. f₂, N/(km/h)²

48. Exhaust emissions⁽⁷⁷⁾⁽⁷⁸⁾⁽⁷⁹⁾:

Number of the base regulatory act and latest amending regulatory act applicable: ...

1.1. test procedure: ESC

Status: Point in time view as at 01/06/2017.

Changes to legislation: There are outstanding changes not yet made to Commission Regulation (EU) 2017/1151. Any changes that have already been made to the legislation appear in the content and are referenced with annotations. (See end of Document for details)

CO: ... HC: ... NO_x: ... HC + NO_x: ... Particulates: ...

Smoke opacity (ELR): ... (m⁻¹)

1.2. test procedure: WHSC (EURO VI)

CO: ... THC: ... NMHC: ... NO_x: ... THC + NO_x: ... NH₃: ... Particulates (mass): ... Particles (number): ...

2.1. test procedure: ETC (if applicable)

CO: ... NO_x: ... NMHC: ... THC: ... CH₄: ... Particulates: ...

2.2. test procedure: WHTC (EURO VI)

CO: ... NO_x: ... NMHC: ... THC: ... CH₄: ... NH₃: ... Particulates (mass): ... Particles (number): ...

48.1. Smoke corrected absorption coefficient: ... (m⁻¹)

Miscellaneous

50. Type-approved according to the design requirements for transporting dangerous goods: yes/class(es): .../no⁽⁷⁶⁾:

51. For special purpose vehicles: designation in accordance with Annex II Section 5: ...

52. Remarks⁽⁸³⁾: ...

SIDE 2

VEHICLE (complete and completed vehicles)

CATEGORIES

O1 AND

O2

Side 2

General construction characteristics

1. Number of axles: ... and wheels: ...

1.1. Number and position of axles with twin wheels: ...

Main dimensions

4. Wheelbase⁽⁶⁹⁾: ... mm

4.1. Axle spacing:

1-2: ... mm

2-3: ... mm

3-4: ... mm

5. Length: ... mm

6. Width: ... mm

7. Height: ... mm

10. Distance between the centre of the coupling device and the rear end of the vehicle: ... mm

Status: Point in time view as at 01/06/2017.

Changes to legislation: There are outstanding changes not yet made to Commission Regulation (EU) 2017/1151. Any changes that have already been made to the legislation appear in the content and are referenced with annotations. (See end of Document for details)

11. Length of the loading area: ... mm

12. Rear overhang: ... mm

Masses

13. Mass in running order: ... kg

13.1. Distribution of this mass amongst the axles:

1. ... kg

2. ... kg

3. ... kg

13.2. Actual mass of the vehicle: ... kg

16. Technically permissible maximum masses

16.1. Technically permissible maximum laden mass: ... kg

16.2. Technically permissible mass on each axle:

1. ... kg

2. ... kg

3. ... kg etc.

16.3. Technically permissible mass on each axle group:

1. ... kg

2. ... kg

3. ... kg etc.

19. Technically permissible maximum static mass on the coupling point of a semi-trailer or centre-axle trailer: ... kg

Maximum speed

29. Maximum speed: ... km/h

Axles and suspension

30.1. Track of each steered axle: ... mm

30.2. Track of all other axles: ... mm

31. Position of lift axle(s): ...

32. Position of loadable axle(s): ...

34. Axle(s) fitted with air suspension or equivalent: yes/no⁽⁶⁸⁾

35. Tyre/wheel combination⁽⁷²⁾: ...

Brakes

36. Trailer brake connections mechanical/electric/pneumatic/hydraulic⁽⁶⁸⁾

Bodywork

38. Code for bodywork⁽⁷³⁾: ...

Status: Point in time view as at 01/06/2017.

Changes to legislation: There are outstanding changes not yet made to Commission Regulation (EU) 2017/1151. Any changes that have already been made to the legislation appear in the content and are referenced with annotations. (See end of Document for details)

Coupling device

44. Approval number or approval mark of coupling device (if fitted): ...

45.1. Characteristics values⁽⁶⁸⁾: D: .../ V: .../ S: .../ U: ...

Miscellaneous

50. Type-approved according to the design requirements for transporting dangerous goods: yes/class(es): .../no⁽⁷⁶⁾:

51. For special purpose vehicles: designation in accordance with Annex II Section 5: ...

52. Remarks⁽⁸³⁾: ...

SIDE 2

VEHICLE (complete and completed vehicles)

CATEGORIES

O3 AND

O4

Side 2

General construction characteristics

1. Number of axles: ... and wheels: ...

1.1. Number and position of axles with twin wheels: ...

2. Steered axles (number, position): ...

Main dimensions

4. Wheelbase⁽⁶⁹⁾: ... mm

4.1. Axle spacing:

1-2: ... mm

2-3: ... mm

3-4: ... mm

5. Length: ... mm

6. Width: ... mm

7. Height: ... mm

10. Distance between the centre of the coupling device and the rear end of the vehicle: ... mm

11. Length of the loading area: ... mm

12. Rear overhang: ... mm

Masses

13. Mass in running order: ... kg

13.1. Distribution of this mass amongst the axles:

1. ... kg

2. ... kg

Status: Point in time view as at 01/06/2017.

Changes to legislation: There are outstanding changes not yet made to Commission Regulation (EU) 2017/1151. Any changes that have already been made to the legislation appear in the content and are referenced with annotations. (See end of Document for details)

- 3. ... kg
 - 13.2. Actual mass of the vehicle: ... kg
 - 16. Technically permissible maximum masses
 - 16.1. Technically permissible maximum laden mass: ... kg
 - 16.2. Technically permissible mass on each axle:
 - 1. ... kg
 - 2. ... kg
 - 3. ... kg etc.
 - 16.3. Technically permissible mass on each axle group:
 - 1. ... kg
 - 2. ... kg
 - 3. ... kg etc.
 - 17. Intended registration/in service maximum permissible masses in national/international traffic⁽⁶⁸⁾⁽⁸⁴⁾
 - 17.1. Intended registration/in service maximum permissible laden mass: ... kg
 - 17.2. Intended registration/in service maximum permissible laden mass on each axle:
 - 1. ... kg
 - 2. ... kg
 - 3. ... kg
 - 17.3. Intended registration/in service maximum permissible laden mass on each axle group:
 - 1. ... kg
 - 2. ... kg
 - 3. ... kg
 - 19. Technically permissible maximum static mass on the coupling point of a semi-trailer or centre-axle trailer: ... kg
- Maximum speed*
- 29. Maximum speed: ... km/h
- Axles and suspension*
- 31. Position of lift axle(s): ...
 - 32. Position of loadable axle(s): ...
 - 34. Axle(s) fitted with air suspension or equivalent: yes/no⁽⁶⁸⁾
 - 35. Tyre/wheel combination⁽⁷²⁾: ...
- Brakes*
- 36. Trailer brake connections mechanical/electric/pneumatic/hydraulic⁽⁶⁸⁾

Status: Point in time view as at 01/06/2017.

Changes to legislation: There are outstanding changes not yet made to Commission Regulation (EU) 2017/1151. Any changes that have already been made to the legislation appear in the content and are referenced with annotations. (See end of Document for details)

Bodywork

38. Code for bodywork⁽⁷³⁾: ...

Coupling device

44. Approval number or approval mark of coupling device (if fitted): ...

45.1. Characteristics values⁽⁶⁸⁾: D: .../ V: .../ S: .../ U: ...Å

Miscellaneous

50. Type-approved according to the design requirements for transporting dangerous goods: yes/class(es): .../no⁽⁷⁶⁾:

51. For special purpose vehicles: designation in accordance with Annex II Section 5: ...

52. Remarks⁽⁸³⁾: ...

PART II

INCOMPLETE VEHICLES

MODEL INCOMPLETE VEHICLES

CI —

SIDE 1

EC CERTIFICATE OF CONFORMITY

Side 1

The undersigned [... (*Full name and position*)] hereby certifies that the vehicle:

0.1. Make (Trade name of manufacturer): ...

0.2. Type: ...

Variant⁽⁶⁴⁾: ...

Version⁽⁶⁴⁾: ...

0.2.1. Commercial name: ...

0.2.2. For multi-stage approved vehicles, type-approval information of the base/previous stages vehicle

(list the information for each stage):

Type: ...

Variant⁽⁶⁴⁾: ...

Version⁽⁶⁴⁾: ...

Type-approval number, extension number ...

0.4. Vehicle category: ...

0.5. Company name and address of manufacturer: ...

0.5.1. For multi-stage approved vehicles, company name and address of the manufacturer of the base/previous stage(s) vehicle ...

Status: Point in time view as at 01/06/2017.

Changes to legislation: There are outstanding changes not yet made to Commission Regulation (EU) 2017/1151. Any changes that have already been made to the legislation appear in the content and are referenced with annotations. (See end of Document for details)

0.6. Location and method of attachment of the statutory plates: ...

Location of the vehicle identification number: ...

0.9. Name and address of the manufacturer's representative (if any): ...

0.10. Vehicle identification number: ...

conforms in all respects to the type described in approval (... *type-approval number including extension number*) issued on (... *date of issue*) and

cannot be permanently registered without further approvals.

(Place) (Date): ...

(Signature): ...

MODEL INCOMPLETE VEHICLES TYPE-APPROVED IN SMALL SERIES

*C2 —
SIDE 1*

[Year]

[Sequential number]

EC CERTIFICATE OF CONFORMITY

Side 1

The undersigned [... (*Full name and position*)] hereby certifies that the vehicle:

0.1. Make (Trade name of manufacturer): ...

0.2. Type: ...

Variant⁽⁶⁴⁾: ...

Version⁽⁶⁴⁾: ...

0.2.1. Commercial name: ...

0.4. Vehicle category: ...

0.5. Company name and address of manufacturer: ...

0.6. Location and method of attachment of the statutory plates: ...

Location of the vehicle identification number: ...

0.9. Name and address of the manufacturer's representative (if any): ...

0.10. Vehicle identification number: ...

conforms in all respects to the type described in approval (... *type-approval number including extension number*) issued on (... *date of issue*) and

cannot be permanently registered without further approvals.

(Place) (Date): ...

(Signature): ...

SIDE 2

Status: Point in time view as at 01/06/2017.

Changes to legislation: There are outstanding changes not yet made to Commission Regulation (EU) 2017/1151. Any changes that have already been made to the legislation appear in the content and are referenced with annotations. (See end of Document for details)

VEHICLE (incomplete vehicles)

CATEGORY

M1

Side 2

General construction characteristics

1. Number of axles: ... and wheels: ...
3. Powered axles (number, position, interconnection):

Main dimensions

4. Wheelbase⁽⁶⁹⁾: ... mm
- 4.1. Axle spacing:
 - 1-2: ... mm
 - 2-3: ... mm
 - 3-4: ... mm
- 5.1. Maximum permissible length: ... mm
- 6.1. Maximum permissible width: ... mm
- 7.1. Maximum permissible height: ... mm
- 12.1. Maximum permissible rear overhang: ... mm

Masses

14. Mass in running order of the incomplete vehicle: ... kg
- 14.1. Distribution of this mass amongst the axles:
 1. ... kg
 2. ... kg
 3. ... kg
15. Minimum mass of the vehicle when completed: ... kg
- 15.1. Distribution of this mass amongst the axles:
 1. ... kg
 2. ... kg
 3. ... kg
16. Technically permissible maximum masses
- 16.1. Technically permissible maximum laden mass: ... kg
- 16.2. Technically permissible mass on each axle:
 1. ... kg
 2. ... kg
 3. ... kg etc.

Status: Point in time view as at 01/06/2017.

Changes to legislation: There are outstanding changes not yet made to Commission Regulation (EU) 2017/1151. Any changes that have already been made to the legislation appear in the content and are referenced with annotations. (See end of Document for details)

- 16.4. Technically permissible maximum mass of the combination: ... kg
18. Technically permissible maximum towable mass in case of:
- 18.1. Drawbar trailer: ... kg
- 18.3. Centre-axle trailer: ... kg
- 18.4. Unbraked trailer: ... kg
19. Technically permissible maximum static vertical mass at the coupling point: ... kg
Power plant
20. Manufacturer of the engine: ...
21. Engine code as marked on the engine: ...
22. Working principle: ...
23. Pure electric: yes/no⁽⁶⁸⁾
- 23.1. Hybrid [electric] vehicle: yes/no⁽⁶⁸⁾
24. Number and arrangement of cylinders: ...
25. Engine capacity: ... cm³
26. Fuel: Diesel/petrol/LPG/CNG-Biomethane/LNG/Ethanol/Biodiesel/Hydrogen⁽⁶⁸⁾
- 26.1. Mono fuel/Bi fuel/Flex fuel/Dual-fuel⁽⁶⁸⁾
- 26.2. (Dual-fuel only) Type 1A/Type 1B/Type 2A/Type 2B/Type 3B⁽⁶⁸⁾
27. Maximum power
- 27.1. Maximum net power⁽⁷⁰⁾: ... kW at ... min⁻¹ (internal combustion engine)⁽⁶⁸⁾
- 27.2. Maximum hourly output: ... kW (electric motor)⁽⁶⁸⁾⁽⁷¹⁾
- 27.3. Maximum net power: ... kW (electric motor)⁽⁶⁸⁾⁽⁷¹⁾
- 27.4. Maximum 30 minutes power: ... kW (electric motor)⁽⁶⁸⁾⁽⁷¹⁾
Maximum speed
29. Maximum speed: ... km/h
Axles and suspension
30. Axle(s) track:
1. ... mm
2. ... mm
3. ... mm
35. Tyre/wheel combination⁽⁷²⁾: ...
Brakes
36. Trailer brake connections mechanical/electric/pneumatic/hydraulic⁽⁶⁸⁾

Status: Point in time view as at 01/06/2017.

Changes to legislation: There are outstanding changes not yet made to Commission Regulation (EU) 2017/1151. Any changes that have already been made to the legislation appear in the content and are referenced with annotations. (See end of Document for details)

Bodywork

- 41. Number and configuration of doors: ...
- 42. Number of seating positions (including the driver)⁽⁷⁵⁾: ...

Environmental performances

- 46. Sound level

Stationary: ... dB(A) at engine speed: ... min⁻¹

Drive-by: ... dB(A)

- 47. Exhaust emission level⁽⁷⁶⁾: Euro ...

- 47.1. Parameters for emission testing

- 47.1.1. Test mass, kg: ...

- 47.1.2. Frontal area, m²: ...

- 47.1.3. Road load coefficients

- 47.1.3.0. f₀, N:

- 47.1.3.1. f₁, N/(km/h):

- 47.1.3.2. f₂, N/(km/h)²

- 48. Exhaust emissions⁽⁷⁷⁾⁽⁷⁸⁾⁽⁷⁹⁾:

Number of the base regulatory act and latest amending regulatory act applicable: ...

- 1.1. test procedure: Type 1 or ESC⁽⁶⁸⁾

CO: ... HC: ... NO_x: ... HC + NO_x: ... Particulates: ...

Smoke opacity (ELR): ... (m⁻¹)

- 1.2. test procedure: Type 1 (NEDC average values, WLTP highest values) or WHSC (EURO VI)⁽⁶⁸⁾

CO: ... THC: ... NMHC: ... NO_x: ... THC + NO_x: ... NH₃: ... Particulates (mass): ... Particles (number): ...

- 2.1. test procedure: ETC (if applicable)

CO: ... NO_x: ... NMHC: ... THC: ... CH₄: ... Particulates: ...

- 2.2. test procedure: WHTC (EURO VI)

CO: ... NO_x: ... NMHC: ... THC: ... CH₄: ... NH₃: ... Particulates (mass): ... Particles (number): ...

- 48.1. Smoke corrected absorption coefficient: ... (m⁻¹)

- 49. CO₂ emissions/fuel consumption/electric energy consumption⁽⁷⁷⁾:

- 1. All power trains except pure electric vehicles under Regulation (EU) 2017/1151

Status: Point in time view as at 01/06/2017.

Changes to legislation: There are outstanding changes not yet made to Commission Regulation (EU) 2017/1151. Any changes that have already been made to the legislation appear in the content and are referenced with annotations. (See end of Document for details)

	CO₂ emissions	Fuel consumption
Urban conditions:	... g/km	... l/100 km/m ³ /100 km ⁽¹⁾
Extra-urban conditions:	... g/km	... l/100 km/m ³ /100 km ⁽¹⁾
Combined:	... g/km	... l/100 km/m ³ /100 km ⁽¹⁾
Weighted, combined	... g/km	... l/100 km

2. pure electric vehicles and OVC hybrid electric vehicles

Electric energy consumption (weighted, combined ⁽¹⁾)	... Wh/km
Electric range	... km

Miscellaneous

52. Remarks⁽⁸³⁾: ...

SIDE 2

VEHICLE (incomplete vehicles)

CATEGORY

M2

Side 2

General construction characteristics

1. Number of axles: ... and wheels: ...
- 1.1. Number and position of axles with twin wheels: ...
2. Steered axles (number, position): ...
3. Powered axles (number, position, interconnection):

Main dimensions

4. Wheelbase⁽⁶⁹⁾: ... mm
- 4.1. Axle spacing:
 - 1-2: ... mm
 - 2-3: ... mm
 - 3-4: ... mm
- 5.1. Maximum permissible length: ... mm
- 6.1. Maximum permissible width: ... mm
- 7.1. Maximum permissible height: ... mm
- 12.1. Maximum permissible rear overhang: ... mm

Masses

14. Mass in running order of the incomplete vehicle: ... kg

Status: Point in time view as at 01/06/2017.

Changes to legislation: There are outstanding changes not yet made to Commission Regulation (EU) 2017/1151. Any changes that have already been made to the legislation appear in the content and are referenced with annotations. (See end of Document for details)

- 14.1. Distribution of this mass amongst the axles:
 1. ... kg
 2. ... kg
 3. ... kg etc.
15. Minimum mass of the vehicle when completed: ... kg
- 15.1. Distribution of this mass amongst the axles:
 1. ... kg
 2. ... kg
 3. ... kg
16. Technically permissible maximum masses
- 16.1. Technically permissible maximum laden mass: ... kg
- 16.2. Technically permissible mass on each axle:
 1. ... kg
 2. ... kg
 3. ... kg etc.
- 16.3. Technically permissible mass on each axle group:
 1. ... kg
 2. ... kg
 3. ... kg etc.
- 16.4. Technically permissible maximum mass of the combination: ... kg
17. Intended registration/in service maximum permissible masses in national/international traffic⁽⁶⁸⁾⁽⁸⁴⁾
- 17.1. Intended registration/in service maximum permissible laden mass: ... kg
- 17.2. Intended registration/in service maximum permissible laden mass on each axle:
 1. ... kg
 2. ... kg
 3. ... kg
- 17.3. Intended registration/in service maximum permissible laden mass on each axle group:
 1. ... kg
 2. ... kg
 3. ... kg
- 17.4. Intended registration/in service maximum permissible mass of the combination: ... kg

Status: Point in time view as at 01/06/2017.

Changes to legislation: There are outstanding changes not yet made to Commission Regulation (EU) 2017/1151. Any changes that have already been made to the legislation appear in the content and are referenced with annotations. (See end of Document for details)

18. Technically permissible maximum towable mass in case of:
- 18.1. Drawbar trailer: ... kg
- 18.3. Centre-axle trailer: ... kg
- 18.4. Unbraked trailer: ... kg
19. Technically permissible maximum static mass at the coupling point: ... kg
- Power plant*
20. Manufacturer of the engine: ...
21. Engine code as marked on the engine: ...
22. Working principle: ...
23. Pure electric: yes/no⁽⁶⁸⁾
- 23.1. Hybrid [electric] vehicle: yes/no⁽⁶⁸⁾
24. Number and arrangement of cylinders: ...
25. Engine capacity: ... cm³
26. Fuel: Diesel/petrol/LPG/CNG-Biomethane/LNG/Ethanol/Biodiesel/Hydrogen⁽⁶⁸⁾
- 26.1. Mono fuel/Bi fuel/Flex fuel/Dual-fuel⁽⁶⁸⁾
- 26.2. (Dual-fuel only) Type 1A/Type 1B/Type 2A/Type 2B/Type 3B⁽⁶⁸⁾
27. Maximum power
- 27.1. Maximum net power⁽⁷⁰⁾: ... kW at ... min⁻¹ (internal combustion engine)⁽⁶⁸⁾
- 27.2. Maximum hourly output: ... kW (electric motor)⁽⁶⁸⁾⁽⁷¹⁾
- 27.3. Maximum net power: ... kW (electric motor)⁽⁶⁸⁾⁽⁷¹⁾
- 27.4. Maximum 30 minutes power: ... kW (electric motor)⁽⁶⁸⁾⁽⁷¹⁾
28. Gearbox (type): ...
- Maximum speed*
29. Maximum speed: ... km/h
- Axles and suspension*
30. Axle(s) track:
1. ... mm
2. ... mm
3. ... mm
33. Drive axle(s) fitted with air suspension or equivalent: yes/no⁽⁶⁸⁾
35. Tyre/wheel combination⁽⁷²⁾: ...
- Brakes*

Status: Point in time view as at 01/06/2017.

Changes to legislation: There are outstanding changes not yet made to Commission Regulation (EU) 2017/1151. Any changes that have already been made to the legislation appear in the content and are referenced with annotations. (See end of Document for details)

- 36. Trailer brake connections mechanical/electric/pneumatic/hydraulic⁽⁶⁸⁾
- 37. Pressure in feed line for trailer braking system: ... bar
Coupling device
- 44. Approval number or approval mark of coupling device (if fitted): ...
- 45. Type or classes of coupling devices which can be fitted: ...
- 45.1. Characteristics values⁽⁶⁸⁾: D: .../ V: .../ S: .../ U: ...
Environmental performances
- 46. Sound level
Stationary: ... dB(A) at engine speed: ... min⁻¹
Drive-by: ... dB(A)
- 47. Exhaust emission level⁽⁷⁶⁾: Euro ...
- 47.1. Parameters for emission testing
 - 47.1.1. Test mass, kg: ...
 - 47.1.2. Frontal area, m²: ...
 - 47.1.3. Road load coefficients
 - 47.1.3.0. f₀, N:
 - 47.1.3.1. f₁, N/(km/h):
 - 47.1.3.2. f₂, N/(km/h)²
- 48. Exhaust emissions⁽⁷⁷⁾⁽⁷⁸⁾⁽⁷⁹⁾:
Number of the base regulatory act and latest amending regulatory act applicable: ...
 - 1.1. test procedure: Type 1 or ESC⁽⁶⁸⁾
CO: ... HC: ... NO_x: ... HC + NO_x: ... Particulates: ...
Smoke opacity (ELR): ... (m⁻¹)
 - 1.2. test procedure: Type 1 (NEDC average values, WLTP highest values) or WHSC (EURO VI)⁽⁶⁸⁾
CO: ... THC: ... NMHC: ... NO_x: ... THC + NO_x: ... NH₃: ... Particulates (mass): ... Particles (number): ...
 - 2.1. test procedure: ETC (if applicable)
CO: ... NO_x: ... NMHC: ... THC: ... CH₄: ... Particulates: ...
 - 2.2. test procedure: WHTC (EURO VI)
CO: ... NO_x: ... NMHC: ... THC: ... CH₄: ... NH₃: ... Particulates (mass): ... Particles (number): ...

Status: Point in time view as at 01/06/2017.

Changes to legislation: There are outstanding changes not yet made to Commission Regulation (EU) 2017/1151. Any changes that have already been made to the legislation appear in the content and are referenced with annotations. (See end of Document for details)

48.1. Smoke corrected absorption coefficient: ... (m⁻¹)

Miscellaneous

52. Remarks⁽⁸³⁾: ...

SIDE 2

VEHICLE(incomplete vehicles)

CATEGORY

M3

Side 2

General construction characteristics

1. Number of axles: ... and wheels: ...
- 1.1. Number and position of axles with twin wheels: ...
2. Steered axles (number, position): ...
3. Powered axles (number, position, interconnection):

Main dimensions

4. Wheelbase⁽⁶⁹⁾: ... mm
- 4.1. Axle spacing:
 - 1-2: ... mm
 - 2-3: ... mm
 - 3-4: ... mm
- 5.1. Maximum permissible length: ... mm
- 6.1. Maximum permissible width: ... mm
- 7.1. Maximum permissible height: ... mm
- 12.1. Maximum permissible rear overhang: ... mm

Masses

14. Mass in running order of the incomplete vehicle: ... kg
- 14.1. Distribution of this mass amongst the axles:
 1. ... kg
 2. ... kg
 3. ... kg etc.
15. Minimum mass of the vehicle when completed: ... kg
- 15.1. Distribution of this mass amongst the axles:
 1. ... kg
 2. ... kg
 3. ... kg

Status: Point in time view as at 01/06/2017.

Changes to legislation: There are outstanding changes not yet made to Commission Regulation (EU) 2017/1151. Any changes that have already been made to the legislation appear in the content and are referenced with annotations. (See end of Document for details)

16. Technically permissible maximum masses
 - 16.1. Technically permissible maximum laden mass: ... kg
 - 16.2. Technically permissible mass on each axle:
 1. ... kg
 2. ... kg
 3. ... kg etc.
 - 16.3. Technically permissible mass on each axle group:
 1. ... kg
 2. ... kg
 3. ... kg etc.
 - 16.4. Technically permissible maximum mass of the combination: ... kg
 17. Intended registration/in service maximum permissible masses in national/international traffic⁽⁶⁸⁾⁽⁸⁴⁾
 - 17.1. Intended registration/in service maximum permissible laden mass: ... kg
 - 17.2. Intended registration/in service maximum permissible laden mass on each axle:
 1. ... kg
 2. ... kg
 3. ... kg
 - 17.3. Intended registration/in service maximum permissible laden mass on each axle group:
 1. ... kg
 2. ... kg
 3. ... kg
 - 17.4. Intended registration/in service maximum permissible mass of the combination: ... kg
 18. Technically permissible maximum towable mass in case of:
 - 18.1. Drawbar trailer: ... kg
 - 18.3. Centre-axle trailer: ... kg
 - 18.4. Unbraked trailer: ... kg
 19. Technically permissible maximum static mass at the coupling point: ... kg
- Power plant*
20. Manufacturer of the engine: ...
 21. Engine code as marked on the engine: ...
 22. Working principle: ...

Status: Point in time view as at 01/06/2017.

Changes to legislation: There are outstanding changes not yet made to Commission Regulation (EU) 2017/1151. Any changes that have already been made to the legislation appear in the content and are referenced with annotations. (See end of Document for details)

23. Pure electric: yes/no⁽⁶⁸⁾
- 23.1. Hybrid [electric] vehicle: yes/no⁽⁶⁸⁾
24. Number and arrangement of cylinders: ...
25. Engine capacity: ... cm³
26. Fuel: Diesel/petrol/LPG/CNG-Biomethane/LNG/Ethanol/Biodiesel/Hydrogen⁽⁶⁸⁾
- 26.1. Mono fuel/Bi fuel/Flex fuel/Dual-fuel⁽⁶⁸⁾
- 26.2. (Dual-fuel only) Type 1A/Type 1B/Type 2A/Type 2B/Type 3B⁽⁶⁸⁾
27. Maximum power
- 27.1. Maximum net power⁽⁷⁰⁾: ... kW at ... min⁻¹ (internal combustion engine)⁽⁶⁸⁾
- 27.2. Maximum hourly output: ... kW (electric motor)⁽⁶⁸⁾⁽⁷¹⁾
- 27.3. Maximum net power: ... kW (electric motor)⁽⁶⁸⁾⁽⁷¹⁾
- 27.4. Maximum 30 minutes power: ... kW (electric motor)⁽⁶⁸⁾⁽⁷¹⁾
28. Gearbox (type): ...
Maximum speed
29. Maximum speed: ... km/h
Axles and suspension
- 30.1. Track of each steered axle: ... mm
- 30.2. Track of all other axles: ... mm
32. Position of loadable axle(s): ...
33. Drive axle(s) fitted with air suspension or equivalent: yes/no⁽⁶⁸⁾
35. Tyre/wheel combination⁽⁷²⁾: ...
Brakes
36. Trailer brake connections mechanical/electric/pneumatic/hydraulic⁽⁶⁸⁾
37. Pressure in feed line for trailer braking system: ... bar
Coupling device
44. Approval number or approval mark of coupling device (if fitted): ...
45. Types or classes of coupling devices which can be fitted: ...
- 45.1. Characteristics values⁽⁶⁸⁾: D: .../ V: .../ S: .../ U: ...
Environmental performances
46. Sound level
- Stationary: ... dB(A) at engine speed: ... min⁻¹
- Drive-by: ... dB(A)

Status: Point in time view as at 01/06/2017.

Changes to legislation: There are outstanding changes not yet made to Commission Regulation (EU) 2017/1151. Any changes that have already been made to the legislation appear in the content and are referenced with annotations. (See end of Document for details)

47. Exhaust emission level⁽⁷⁶⁾: Euro ...

47.1. Parameters for emission testing

47.1.1. Test mass, kg: ...

47.1.2. Frontal area, m²: ...

47.1.3. Road load coefficients

47.1.3.0. f₀, N:

47.1.3.1. f₁, N/(km/h):

47.1.3.2. f₂, N/(km/h)²

48. Exhaust emissions⁽⁷⁷⁾⁽⁷⁸⁾⁽⁷⁹⁾:

Number of the base regulatory act and latest amending regulatory act applicable: ...

1.1. test procedure: ESC

CO: ... HC: ... NO_x: ... HC + NO_x: ... Particulates: ...

Smoke opacity (ELR): ... (m⁻¹)

1.2. test procedure: WHSC (EURO VI)

CO: ... THC: ... NMHC: ... NO_x: ... THC + NO_x: ... NH₃: ... Particulates (mass): ... Particles (number): ...

2.1. test procedure: ETC (if applicable)

CO: ... NO_x: ... NMHC: ... THC: ... CH₄: ... Particulates: ...

2.2. test procedure: WHTC (EURO VI)

CO: ... NO_x: ... NMHC: ... THC: ... CH₄: ... NH₃: ... Particulates (mass): ... Particles (number): ...

48.1. Smoke corrected absorption coefficient: ... (m⁻¹)

Miscellaneous

52. Remarks⁽⁸³⁾: ...

SIDE 2

VEHICLE (incomplete vehicles)

CATEGORY

N1

Side 2

General construction characteristics

1. Number of axles: ... and wheels: ...

1.1. Number and position of axles with twin wheels: ...

3. Powered axles (number, position, interconnection):

Main dimensions

Status: Point in time view as at 01/06/2017.

Changes to legislation: There are outstanding changes not yet made to Commission Regulation (EU) 2017/1151. Any changes that have already been made to the legislation appear in the content and are referenced with annotations. (See end of Document for details)

- 4. Wheelbase⁽⁶⁹⁾: ... mm
- 4.1. Axle spacing:
 - 1-2: ... mm
 - 2-3: ... mm
 - 3-4: ... mm
- 5.1. Maximum permissible length: ... mm
- 6.1. Maximum permissible width: ... mm
- 7.1. Maximum permissible height: ... mm
- 8. Fifth wheel lead for semi-trailer towing vehicle (maximum and minimum): ... mm
- 12.1. Maximum permissible rear overhang: ... mm
- Masses*
- 14. Mass in running order of the incomplete vehicle: ... kg
 - 14.1. Distribution of this mass amongst the axles:
 - 1. ... kg
 - 2. ... kg
 - 3. ... kg etc.
- 15. Minimum mass of the vehicle when completed: ... kg
 - 15.1. Distribution of this mass amongst the axles:
 - 1. ... kg
 - 2. ... kg
 - 3. ... kg
- 16. Technically permissible maximum masses
 - 16.1. Technically permissible maximum laden mass: ... kg
 - 16.2. Technically permissible mass on each axle:
 - 1. ... kg
 - 2. ... kg
 - 3. ... kg etc.
 - 16.4. Technically permissible maximum mass of the combination: ... kg
- 18. Technically permissible maximum towable mass in case of:
 - 18.1. Drawbar trailer: ... kg
 - 18.2. Semi-trailer: ... kg
 - 18.3. Centre-axle trailer: ... kg

Status: Point in time view as at 01/06/2017.

Changes to legislation: There are outstanding changes not yet made to Commission Regulation (EU) 2017/1151. Any changes that have already been made to the legislation appear in the content and are referenced with annotations. (See end of Document for details)

- 18.4. Unbraked trailer: ... kg
19. Technically permissible maximum static mass at the coupling point: ... kg
- Power plant*
20. Manufacturer of the engine: ...
21. Engine code as marked on the engine: ...
22. Working principle: ...
23. Pure electric: yes/no⁽⁶⁸⁾
- 23.1. Hybrid [electric] vehicle: yes/no⁽⁶⁸⁾
24. Number and arrangement of cylinders: ...
25. Engine capacity: ... cm³
26. Fuel: Diesel/petrol/LPG/CNG-Biomethane/LNG/Ethanol/Biodiesel/Hydrogen⁽⁶⁸⁾
- 26.1. Mono fuel/Bi fuel/Flex fuel/Dual-fuel⁽⁶⁸⁾
- 26.2. (Dual-fuel only) Type 1A/Type 1B/Type 2A/Type 2B/Type 3B⁽⁶⁸⁾
27. Maximum power
- 27.1. Maximum net power⁽⁷⁰⁾: ... kW at ... min⁻¹ (internal combustion engine)⁽⁶⁸⁾
- 27.2. Maximum hourly output: ... kW (electric motor)⁽⁶⁸⁾⁽⁷¹⁾
- 27.3. Maximum net power: ... kW (electric motor)⁽⁶⁸⁾⁽⁷¹⁾
- 27.4. Maximum 30 minutes power: ... kW (electric motor)⁽⁶⁸⁾⁽⁷¹⁾
28. Gearbox (type): ...
- Maximum speed*
29. Maximum speed: ... km/h
- Axles and suspension*
30. Axle(s) track:
1. ... mm
2. ... mm
3. ... mm
35. Tyre/wheel combination⁽⁷²⁾: ...
- Brakes*
36. Trailer brake connections mechanical/electric/pneumatic/hydraulic⁽⁶⁸⁾
37. Pressure in feed line for trailer braking system: ... bar
- Coupling device*
44. Approval number or approval mark of coupling device (if fitted): ...

Status: Point in time view as at 01/06/2017.

Changes to legislation: There are outstanding changes not yet made to Commission Regulation (EU) 2017/1151. Any changes that have already been made to the legislation appear in the content and are referenced with annotations. (See end of Document for details)

45. Types or classes of coupling devices which can be fitted: ...
- 45.1. Characteristics values⁽⁶⁸⁾: D: .../ V: .../ S: .../ U: ...
Environmental performances
46. Sound level
- Stationary: ... dB(A) at engine speed: ... min⁻¹
- Drive-by: ... dB(A)
47. Exhaust emission level⁽⁷⁶⁾: Euro ...
- 47.1. Parameters for emission testing
- 47.1.1. Test mass, kg: ...
- 47.1.2. Frontal area, m²: ...
- 47.1.3. Road load coefficients
- 47.1.3.0. f_0 , N:
- 47.1.3.1. f_1 , N/(km/h):
- 47.1.3.2. f_2 , N/(km/h)²
48. Exhaust emissions⁽⁷⁷⁾⁽⁷⁸⁾⁽⁷⁹⁾:
- Number of the base regulatory act and latest amending regulatory act applicable: ...
- 1.1. test procedure: Type 1 or ESC⁽⁶⁸⁾
- CO: ... HC: ... NO_x: ... HC + NO_x: ... Particulates: ...
- Smoke opacity (ELR): ... (m⁻¹)
- 1.2. test procedure: Type 1 (NEDC average values, WLTP highest values) or WHSC (EURO VI)⁽⁶⁸⁾
- CO: ... THC: ... NMHC: ... NO_x: ... THC + NO_x: ... NH₃: ... Particulates (mass): ... Particles (number): ...
- 2.1. test procedure: ETC (if applicable)
- CO: ... NO_x: ... NMHC: ... THC: ... CH₄: ... Particulates:
- 2.2. test procedure: WHTC (EURO VI)
- CO: ... NO_x: ... NMHC: ... THC: ... CH₄: ... NH₃: ... Particulates (mass): ... Particles (number):
- 48.1. Smoke corrected absorption coefficient: ... (m⁻¹)
49. CO₂ emissions/fuel consumption/electric energy consumption⁽⁷⁷⁾:
1. all power trains except pure electric vehicles under Regulation (EU) 2017/1151

Status: Point in time view as at 01/06/2017.

Changes to legislation: There are outstanding changes not yet made to Commission Regulation (EU) 2017/1151. Any changes that have already been made to the legislation appear in the content and are referenced with annotations. (See end of Document for details)

	CO₂ emissions	Fuel consumption
Urban conditions:	... g/km	... l/100 km/m ³ /100 km ⁽¹⁾
Extra-urban conditions:	... g/km	... l/100 km/m ³ /100 km ⁽¹⁾
Combined:	... g/km	... l/100 km/m ³ /100 km ⁽¹⁾
Weighted, combined	... g/km	... l/100 km

2. pure electric vehicles and OVC hybrid electric vehicles

Electric energy consumption (weighted, combined ⁽¹⁾)	... Wh/km
Electric range	... km

3. Vehicle fitted with eco-innovation(s): yes/no⁽⁶⁸⁾

3.1. General code of the eco-innovation(s)⁽⁸¹⁾: ...

3.2. Total CO₂ emissions saving due to the eco-innovation(s)⁽⁸²⁾ (repeat for each reference fuel tested): ...

Miscellaneous

52. Remarks⁽⁸³⁾: ...

SIDE 2

VEHICLE (incomplete vehicles)

CATEGORY

N2

Side 2

General construction characteristics

1. Number of axles: ... and wheels: ...

1.1. Number and position of axles with twin wheels: ...

2. Steered axles (number, position): ...

3. Powered axles (number, position, interconnection):

Main dimensions

4. Wheelbase⁽⁶⁹⁾: ... mm

4.1. Axle spacing:

1-2: ... mm

2-3: ... mm

3-4: ... mm

5.1. Maximum permissible length: ... mm

6.1. Maximum permissible width: ... mm

Status: Point in time view as at 01/06/2017.

Changes to legislation: There are outstanding changes not yet made to Commission Regulation (EU) 2017/1151. Any changes that have already been made to the legislation appear in the content and are referenced with annotations. (See end of Document for details)

8. Fifth wheel lead for semi-trailer towing vehicle (maximum and minimum): ... mm
- 12.1. Maximum permissible rear overhang: ... mm
- Masses*
14. Mass in running order of the incomplete vehicle: ... kg
- 14.1. Distribution of this mass amongst the axles:
 1. ... kg
 2. ... kg
 3. ... kg etc.
15. Minimum mass of the vehicle when completed: ... kg
- 15.1. Distribution of this mass amongst the axles:
 1. ... kg
 2. ... kg
 3. ... kg
16. Technically permissible maximum masses
- 16.1. Technically permissible maximum laden mass: ... kg
- 16.2. Technically permissible mass on each axle:
 1. ... kg
 2. ... kg
 3. ... kg etc.
- 16.3. Technically permissible mass on each axle group:
 1. ... kg
 2. ... kg
 3. ... kg etc.
- 16.4. Technically permissible maximum mass of the combination: ... kg
17. Intended registration/in service maximum permissible masses in national/international traffic⁽⁶⁸⁾⁽⁸⁴⁾
- 17.1. Intended registration/in service maximum permissible laden mass: ... kg
- 17.2. Intended registration/in service maximum permissible laden mass on each axle:
 1. ... kg
 2. ... kg
 3. ... kg
- 17.3. Intended registration/in service maximum permissible laden mass on each axle group:

Status: Point in time view as at 01/06/2017.

Changes to legislation: There are outstanding changes not yet made to Commission Regulation (EU) 2017/1151. Any changes that have already been made to the legislation appear in the content and are referenced with annotations. (See end of Document for details)

1. ... kg
2. ... kg
3. ... kg
- 17.4. Intended registration/in service maximum permissible mass of the combination: ... kg
18. Technically permissible maximum towable mass in case of:
 - 18.1. Drawbar trailer: ... kg
 - 18.2. Semi-trailer: ... kg
 - 18.3. Centre-axle trailer: ... kg
 - 18.4. Unbraked trailer: ... kg
19. Technically permissible maximum static mass at the coupling point: ... kg
Power plant
20. Manufacturer of the engine: ...
21. Engine code as marked on the engine: ...
22. Working principle: ...
23. Pure electric: yes/no⁽⁶⁸⁾
- 23.1. Hybrid [electric] vehicle: yes/no⁽⁶⁸⁾
24. Number and arrangement of cylinders: ...
25. Engine capacity: ... cm³
26. Fuel: Diesel/petrol/LPG/CNG-Biomethane/LNG/Ethanol/Biodiesel/Hydrogen⁽⁶⁸⁾
 - 26.1. Mono fuel/Bi fuel/Flex fuel/Dual-fuel⁽⁶⁸⁾
 - 26.2. (Dual-fuel only) Type 1A/Type 1B/Type 2A/Type 2B/Type 3B⁽⁶⁸⁾
27. Maximum power
 - 27.1. Maximum net power⁽⁷⁰⁾: ... kW at ... min⁻¹ (internal combustion engine)⁽⁶⁸⁾
 - 27.2. Maximum hourly output: ... kW (electric motor)⁽⁶⁸⁾⁽⁷¹⁾
 - 27.3. Maximum net power: ... kW (electric motor)⁽⁶⁸⁾⁽⁷¹⁾
 - 27.4. Maximum 30 minutes power: ... kW (electric motor)⁽⁶⁸⁾⁽⁷¹⁾
28. Gearbox (type): ...
Maximum speed
29. Maximum speed: ... km/h
Axles and suspension
31. Position of lift axle(s): ...
32. Position of loadable axle(s): ...

Status: Point in time view as at 01/06/2017.

Changes to legislation: There are outstanding changes not yet made to Commission Regulation (EU) 2017/1151. Any changes that have already been made to the legislation appear in the content and are referenced with annotations. (See end of Document for details)

33. Drive axle(s) fitted with air suspension or equivalent: yes/no⁽⁶⁸⁾
35. Tyre/wheel combination⁽⁷²⁾: ...
Brakes
36. Trailer brake connections mechanical/electric/pneumatic/hydraulic⁽⁶⁸⁾
37. Pressure in feed line for trailer braking system: ... bar
Coupling device
44. Approval number or approval mark of coupling device (if fitted): ...
45. Types or classes of coupling devices which can be fitted: ...
- 45.1. Characteristics values⁽⁶⁸⁾: D: .../ V: .../ S: .../ U: ...
Environmental performances
46. Sound level
 Stationary: ... dB(A) at engine speed: ... min⁻¹
 Drive-by: ... dB(A)
47. Exhaust emission level⁽⁷⁶⁾: Euro ...
- 47.1. Parameters for emission testing
- 47.1.1. Test mass, kg: ...
- 47.1.2. Frontal area, m²: ...
- 47.1.3. Road load coefficients
- 47.1.3.0. f₀, N:
- 47.1.3.1. f₁, N/(km/h):
- 47.1.3.2. f₂, N/(km/h)²
48. Exhaust emissions⁽⁷⁷⁾⁽⁷⁸⁾⁽⁷⁹⁾:
 Number of the base regulatory act and latest amending regulatory act applicable: ...
- 1.1. test procedure: Type 1 or ESC⁽⁶⁸⁾
 CO: ... HC: ... NO_x: ... HC + NO_x: ... Particulates: ...
 Smoke opacity (ELR): ... (m⁻¹)
- 1.2. test procedure: Type 1 (NEDC average values, WLTP highest values) or WHSC (EURO VI)⁽⁶⁸⁾
 CO: ... THC: ... NMHC: ... NO_x: ... THC + NO_x: ... NH₃: ... Particulates (mass): ... Particles (number): ...
- 2.1. test procedure: ETC (if applicable)
 CO: ... NO_x: ... NMHC: ... THC: ... CH₄: ... Particulates:

Status: Point in time view as at 01/06/2017.

Changes to legislation: There are outstanding changes not yet made to Commission Regulation (EU) 2017/1151. Any changes that have already been made to the legislation appear in the content and are referenced with annotations. (See end of Document for details)

2.2. test procedure: WHTC (EURO VI)

CO: ... NO_x: ... NMHC: ... THC: ... CH₄: ... NH₃: ... Particulates (mass): ... Particles (number): ...

48.1. Smoke corrected absorption coefficient: ... (m⁻¹)

Miscellaneous

52. Remarks⁽⁸³⁾: ...

SIDE 2

VEHICLE (incomplete vehicles)

CATEGORY

N3

Side 2

General construction characteristics

1. Number of axles: ... and wheels: ...

1.1. Number and position of axles with twin wheels: ...

2. Steered axles (number, position): ...

3. Powered axles (number, position, interconnection):

Main dimensions

4. Wheelbase⁽⁶⁹⁾: ... mm

4.1. Axle spacing:

1-2: ... mm

2-3: ... mm

3-4: ... mm

5.1. Maximum permissible length: ... mm

6.1. Maximum permissible width: ... mm

8. Fifth wheel lead for semi-trailer towing vehicle (maximum and minimum): ... mm

12.1. Maximum permissible rear overhang: ... mm

Masses

14. Mass in running order of the incomplete vehicle: ... kg

14.1. Distribution of this mass amongst the axles:

1. ... kg

2. ... kg

3. ... kg etc.

15. Minimum mass of the vehicle when completed: ... kg

15.1. Distribution of this mass amongst the axles:

1. ... kg

Status: Point in time view as at 01/06/2017.

Changes to legislation: There are outstanding changes not yet made to Commission Regulation (EU) 2017/1151. Any changes that have already been made to the legislation appear in the content and are referenced with annotations. (See end of Document for details)

2. ... kg
3. ... kg
16. Technically permissible maximum masses
 - 16.1. Technically permissible maximum laden mass: ... kg
 - 16.2. Technically permissible mass on each axle:
 1. ... kg
 2. ... kg
 3. ... kg etc.
 - 16.3. Technically permissible mass on each axle group:
 1. ... kg
 2. ... kg
 3. ... kg etc.
 - 16.4. Technically permissible maximum mass of the combination: ... kg
17. Intended registration/in service maximum permissible masses in national/international traffic⁽⁶⁸⁾⁽⁸⁴⁾
 - 17.1. Intended registration/in service maximum permissible laden mass: ... kg
 - 17.2. Intended registration/in service maximum permissible laden mass on each axle:
 1. ... kg
 2. ... kg
 3. ... kg
 - 17.3. Intended registration/in service maximum permissible laden mass on each axle group:
 1. ... kg
 2. ... kg
 3. ... kg
 - 17.4. Intended registration/in service maximum permissible mass of the combination: ... kg
18. Technically permissible maximum towable mass in case of:
 - 18.1. Drawbar trailer: ... kg
 - 18.2. Semi-trailer: ... kg
 - 18.3. Centre-axle trailer: ... kg
 - 18.4. Unbraked trailer: ... kg
19. Technically permissible maximum static mass at the coupling point: ... kg
Power plant
20. Manufacturer of the engine: ...

Status: Point in time view as at 01/06/2017.

Changes to legislation: There are outstanding changes not yet made to Commission Regulation (EU) 2017/1151. Any changes that have already been made to the legislation appear in the content and are referenced with annotations. (See end of Document for details)

21. Engine code as marked on the engine: ...
22. Working principle: ...
23. Pure electric: yes/no⁽⁶⁸⁾
- 23.1. Hybrid [electric] vehicle: yes/no⁽⁶⁸⁾
24. Number and arrangement of cylinders: ...
25. Engine capacity: ... cm³
26. Fuel: Diesel/petrol/LPG/CNG-Biomethane/LNG/Ethanol/Biodiesel/Hydrogen⁽⁶⁸⁾
- 26.1. Mono fuel/Bi fuel/Flex fuel/Dual-fuel⁽⁶⁸⁾
- 26.2. (Dual-fuel only) Type 1A/Type 1B/Type 2A/Type 2B/Type 3B⁽⁶⁸⁾
27. Maximum power
- 27.1. Maximum net power⁽⁷⁰⁾: ... kW at ... min⁻¹ (internal combustion engine)⁽⁶⁸⁾
- 27.2. Maximum hourly output: ... kW (electric motor)⁽⁶⁸⁾⁽⁷¹⁾
- 27.3. Maximum net power: ... kW (electric motor)⁽⁶⁸⁾⁽⁷¹⁾
- 27.4. Maximum 30 minutes power: ... kW (electric motor)⁽⁶⁸⁾⁽⁷¹⁾
28. Gearbox (type): ...
Maximum speed
29. Maximum speed: ... km/h
Axles and suspension
31. Position of lift axle(s): ...
32. Position of loadable axle(s): ...
33. Drive axle(s) fitted with air suspension or equivalent: yes/no⁽⁶⁸⁾
35. Tyre/wheel combination⁽⁷²⁾: ...
Brakes
36. Trailer brake connections mechanical/electric/pneumatic/hydraulic⁽⁶⁸⁾
37. Pressure in feed line for trailer braking system: ... bar
Coupling device
44. Approval number or approval mark of coupling device (if fitted): ...
45. Types or classes of coupling devices which can be fitted: ...
- 45.1. Characteristics values⁽⁶⁸⁾: D: .../ V: .../ S: .../ U: ...
Environmental performances
46. Sound level
Stationary: ... dB(A) at engine speed: ... min⁻¹

Status: Point in time view as at 01/06/2017.

Changes to legislation: There are outstanding changes not yet made to Commission Regulation (EU) 2017/1151. Any changes that have already been made to the legislation appear in the content and are referenced with annotations. (See end of Document for details)

Drive-by: ... dB(A)

47. Exhaust emission level⁽⁷⁶⁾: Euro ...

47.1. Parameters for emission testing

47.1.1. Test mass, kg: ...

47.1.2. Frontal area, m²: ...

47.1.3. Road load coefficients

47.1.3.0. f₀, N:

47.1.3.1. f₁, N/(km/h):

47.1.3.2. f₂, N/(km/h)²

48. Exhaust emissions⁽⁷⁷⁾⁽⁷⁸⁾⁽⁷⁹⁾:

Number of the base regulatory act and latest amending regulatory act applicable: ...

1.1. test procedure: ESC

CO: ... HC: ... NO_x: ... HC + NO_x: ... Particulates: ...

Smoke opacity (ELR): ... (m⁻¹)

1.2. test procedure: WHSC (EURO VI)

CO: ... THC: ... NMHC: ... NO_x: ... THC + NO_x: ... NH₃: ... Particulates (mass): ... Particles (number): ...

2.1. test procedure: ETC (if applicable)

CO: ... NO_x: ... NMHC: ... THC: ... CH₄: ... Particulates:

2.2. test procedure: WHTC (EURO VI)

CO: ... NO_x: ... NMHC: ... THC: ... CH₄: ... NH₃: ... Particulates (mass): ... Particles (number): ...

48.1. Smoke corrected absorption coefficient: ... (m⁻¹)

Miscellaneous

52. Remarks⁽⁸³⁾: ...

SIDE 2

VEHICLE (incomplete vehicles)

CATEGORIES

O1 AND

O2

Side 2

General construction characteristics

1. Number of axles: ... and wheels: ...

1.1. Number and position of axles with twin wheels: ...

Main dimensions

Status: Point in time view as at 01/06/2017.

Changes to legislation: There are outstanding changes not yet made to Commission Regulation (EU) 2017/1151. Any changes that have already been made to the legislation appear in the content and are referenced with annotations. (See end of Document for details)

4. Wheelbase⁽⁶⁹⁾: ... mm
 - 4.1. Axle spacing:
 - 1-2: ... mm
 - 2-3: ... mm
 - 3-4: ... mm
 - 5.1. Maximum permissible length: ... mm
 - 6.1. Maximum permissible width: ... mm
 - 7.1. Maximum permissible height: ... mm
 10. Distance between the centre of the coupling device and the rear end of the vehicle: ... mm
 - 12.1. Maximum permissible rear overhang: ... mm
- Masses*
14. Mass in running order of the incomplete vehicle: ... kg
 - 14.1. Distribution of this mass amongst the axles:
 1. ... kg
 2. ... kg
 3. ... kg
 15. Minimum mass of the vehicle when completed: ... kg
 - 15.1. Distribution of this mass amongst the axles:
 1. ... kg
 2. ... kg
 3. ... kg
 16. Technically permissible maximum masses
 - 16.1. Technically permissible maximum laden mass: ... kg
 - 16.2. Technically permissible mass on each axle:
 1. ... kg
 2. ... kg
 3. ... kg etc.
 - 16.3. Technically permissible mass on each axle group:
 1. ... kg
 2. ... kg
 3. ... kg etc.

Status: Point in time view as at 01/06/2017.

Changes to legislation: There are outstanding changes not yet made to Commission Regulation (EU) 2017/1151. Any changes that have already been made to the legislation appear in the content and are referenced with annotations. (See end of Document for details)

19.1. Technically permissible maximum static mass on the coupling point of a semi-trailer or centre-axle trailer: ... kg

Maximum speed

29. Maximum speed: ... km/h

Axles and suspension

30.1. Track of each steered axle: ... mm

30.2. Track of all other axles: ... mm

31. Position of lift axle(s): ...

32. Position of loadable axle(s): ...

34. Axle(s) fitted with air suspension or equivalent: yes/no⁽⁶⁸⁾

35. Tyre/wheel combination⁽⁷²⁾: ...

Coupling device

44. Approval number or approval mark of coupling device (if fitted): ...

45. Types or classes of coupling devices which can be fitted: ...

45.1. Characteristics values⁽⁶⁸⁾: D: .../ V: .../ S: .../ U: ...

Miscellaneous

52. Remarks⁽⁸³⁾: ...

SIDE 2

VEHICLE (incomplete vehicles)

CATEGORIES

O3 AND

O4

Side 2

General construction characteristics

1. Number of axles: ... and wheels: ...

1.1. Number and position of axles with twin wheels: ...

2. Steered axle (number, position): ...

Main dimensions

4. Wheelbase⁽⁶⁹⁾: ... mm

4.1. Axle spacing:

1-2: ... mm

2-3: ... mm

3-4: ... mm

5.1. Maximum permissible length: ... mm

6.1. Maximum permissible width: ... mm

7.1. Maximum permissible height: ... mm

Status: Point in time view as at 01/06/2017.

Changes to legislation: There are outstanding changes not yet made to Commission Regulation (EU) 2017/1151. Any changes that have already been made to the legislation appear in the content and are referenced with annotations. (See end of Document for details)

10. Distance between the centre of the coupling device and the rear end of the vehicle:
...mm
- 12.1. Maximum permissible rear overhang: ...mm
- Masses*
14. Mass in running order of the incomplete vehicle: ... kg
- 14.1. Distribution of this mass amongst the axles:
 1. ... kg
 2. ... kg
 3. ... kg etc.
15. Minimum mass of the vehicle when completed: ... kg
- 15.1. Distribution of this mass amongst the axles:
 1. ... kg
 2. ... kg
 3. ... kg
16. Technically permissible maximum masses
- 16.1. Technically permissible maximum laden mass: ... kg
- 16.2. Technically permissible mass on each axle:
 1. ... kg
 2. ... kg
 3. ... kg etc.
- 16.3. Technically permissible mass on each axle group:
 1. ... kg
 2. ... kg
 3. ... kg etc.
17. Intended registration/in service maximum permissible masses in national/international traffic⁽⁶⁸⁾⁽⁸⁴⁾
- 17.1. Intended registration/in service maximum permissible laden mass: ... kg
- 17.2. Intended registration/in service maximum permissible laden mass on each axle:
 1. ... kg
 2. ... kg
 3. ... kg
- 17.3. Intended registration/in service maximum permissible laden mass on each axle group:
 1. ... kg

Status: Point in time view as at 01/06/2017.

Changes to legislation: There are outstanding changes not yet made to Commission Regulation (EU) 2017/1151. Any changes that have already been made to the legislation appear in the content and are referenced with annotations. (See end of Document for details)

2. ... kg
3. ... kg
- 19.1. Technically permissible maximum static mass on the coupling point of a semi-trailer or centre-axle trailer: ... kg
- Maximum speed*
29. Maximum speed: ... km/h
- Axles and suspension*
31. Position of lift axle(s): ...
32. Position of loadable axle(s): ...
34. Axle(s) fitted with air suspension or equivalent: yes/no⁽⁶⁸⁾
35. Tyre/wheel combination⁽⁷²⁾: ...
- Coupling device*
44. Approval number or approval mark of coupling device (if fitted): ...
45. Types or classes of coupling devices which can be fitted: ...
- 45.1. Characteristics values⁽⁶⁸⁾: D: .../ V: .../ S: .../ U: ...
- Miscellaneous*
52. Remarks⁽⁸³⁾: ...
- Explanatory notes relating to Annex IX*
- —
- (P) Eco-innovations.

ANNEX XIX

AMENDMENTS TO REGULATION (EU) No 1230/2012

Regulation (EU) No 1230/2012 is amended as follows:

1. Article 2(5) is replaced by the following:
- “Mass of the optional equipment” means maximum mass of the combinations of optional equipment which may be fitted to the vehicle in addition to the standard equipment in accordance with the manufacturer's specifications;

ANNEX XX

MEASUREMENT OF NET POWER AND THE MAXIMUM 30 MINUTES POWER OF ELECTRIC DRIVE TRAINS

1. INTRODUCTION

Status: Point in time view as at 01/06/2017.

Changes to legislation: There are outstanding changes not yet made to Commission Regulation (EU) 2017/1151. Any changes that have already been made to the legislation appear in the content and are referenced with annotations. (See end of Document for details)

This Annex sets out requirements for measuring net engine power, net power and the maximum 30 minutes power of electric drive trains.

2. GENERAL SPECIFICATIONS

2.1. The general specifications for conducting the tests and interpreting the results are those set out in paragraph 5 of UN/ECE Regulation No 85⁽⁸⁶⁾, with the exceptions specified in this Annex.

2.2. Test fuel

Paragraphs 5.2.3.1., 5.2.3.2.1., 5.2.3.3.1., and 5.2.3.4. of UN/ECE Regulation No 85 shall be understood as follows:

The fuel used shall be the one available on the market. In any case of dispute, the fuel shall be the appropriate reference fuel specified in Annex IX to this Regulation.

2.3. Power correction factors

By way of derogation from paragraph 5.1 of Annex 5 to UN/ECE Regulation No 85, when a turbo-charged engine is fitted with a system which allows compensating the ambient conditions temperature and altitude, at the request of the manufacturer, the correction factors α_a or α_d shall be set to the value of 1.

ANNEX XXI

TYPE 1 EMISSIONS TEST PROCEDURES

1. INTRODUCTION

This Annex describes the procedure for determining the levels of emissions of gaseous compounds, particulate matter, particle number, CO₂ emissions, fuel consumption, electric energy consumption and electric range from light-duty vehicles..

2. RESERVED

3. DEFINITIONS

3.1. Test equipment

3.1.1. ‘*Accuracy*’ means the difference between a measured value and a reference value, traceable to a national standard and describes the correctness of a result. See Figure 1.

3.1.2. ‘*Calibration*’ means the process of setting a measurement system's response so that its output agrees with a range of reference signals.

3.1.3. ‘*Calibration gas*’ means a gas mixture used to calibrate gas analysers.

3.1.4. ‘*Double dilution method*’ means the process of separating a part of the diluted exhaust flow and mixing it with an appropriate amount of dilution air prior to the particulate sampling filter.

3.1.5. ‘*Full flow exhaust dilution system*’ means the continuous dilution of the total vehicle exhaust with ambient air in a controlled manner using a constant volume sampler (CVS).

Status: Point in time view as at 01/06/2017.

Changes to legislation: There are outstanding changes not yet made to Commission Regulation (EU) 2017/1151. Any changes that have already been made to the legislation appear in the content and are referenced with annotations. (See end of Document for details)

- 3.1.6. ‘*Linearisation*’ means the application of a range of concentrations or materials to establish a mathematical relationship between concentration and system response.
- 3.1.7. ‘*Major maintenance*’ means the adjustment, repair or replacement of a component or module that could affect the accuracy of a measurement.
- 3.1.8. ‘*Non-methane hydrocarbons*’ (NMHC) are the total hydrocarbons (THC) minus the methane (CH₄) contribution.
- 3.1.9. ‘*Precision*’ means the degree to which repeated measurements under unchanged conditions show the same results (Figure 1) and, in this Annex, always refers to one standard deviation.
- 3.1.10. ‘*Reference value*’ means a value traceable to a national standard. See Figure 1.
- 3.1.11. ‘*Set point*’ means the target value a control system aims to reach.
- 3.1.12. ‘*Span*’ means to adjust an instrument so that it gives a proper response to a calibration standard that represents between 75 per cent and 100 per cent of the maximum value in the instrument range or expected range of use.
- 3.1.13. ‘*Total hydrocarbons*’ (THC) means all volatile compounds measurable by a flame ionization detector (FID).
- 3.1.14. ‘*Verification*’ means to evaluate whether or not a measurement system's outputs agrees with applied reference signals within one or more predetermined thresholds for acceptance.
- 3.1.15. ‘*Zero gas*’ means a gas containing no analyte, which is used to set a zero response on an analyser.

Figure 1

Status: Point in time view as at 01/06/2017.

Changes to legislation: There are outstanding changes not yet made to Commission Regulation (EU) 2017/1151. Any changes that have already been made to the legislation appear in the content and are referenced with annotations. (See end of Document for details)

Definition of accuracy, precision and reference value

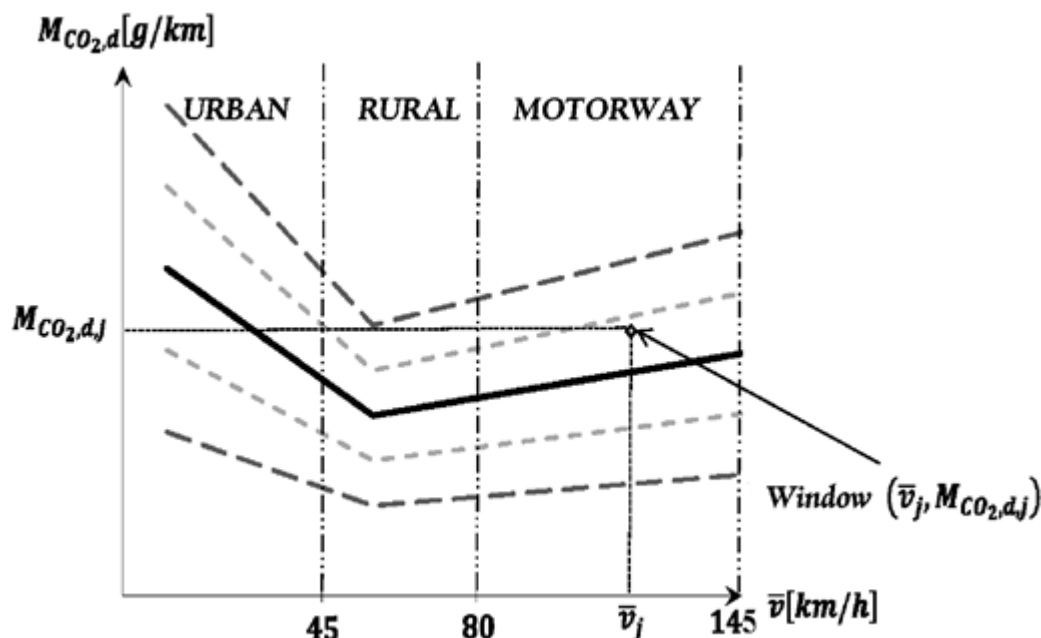

3.2. Road load and dynamometer setting

- 3.2.1. 'Aerodynamic drag' means the force opposing a vehicle's forward motion through air.
- 3.2.2. 'Aerodynamic stagnation point' means the point on the surface of a vehicle where wind velocity is equal to zero.
- 3.2.3. 'Anemometer blockage' means the effect on the anemometer measurement due to the presence of the vehicle where the apparent air speed is different than the vehicle speed combined with wind speed relative to the ground.
- 3.2.4. 'Constrained analysis' means the vehicle's frontal area and aerodynamic drag coefficient have been independently determined and those values shall be used in the equation of motion.
- 3.2.5. 'Mass in running order' means the mass of the vehicle, with its fuel tank(s) filled to at least 90 per cent of its or their capacity/capacities, including the mass of the driver, fuel and liquids, fitted with the standard equipment in accordance with the manufacturer's specifications and, when they are fitted, the mass of the bodywork, the cabin, the coupling and the spare wheel(s) as well as the tools.
- 3.2.6. 'Mass of the driver' means a mass rated at 75 kg located at the driver's seating reference point.
- 3.2.7. 'Maximum vehicle load' means the technically permissible maximum laden mass minus the mass in running order, 25 kg and the mass of the optional equipment as defined in paragraph 3.2.8.
- 3.2.8. 'Mass of the optional equipment' means maximum mass of the combinations of optional equipment which may be fitted to the vehicle in addition to the standard equipment in accordance with the manufacturer's specifications.

Status: Point in time view as at 01/06/2017.

Changes to legislation: There are outstanding changes not yet made to Commission Regulation (EU) 2017/1151. Any changes that have already been made to the legislation appear in the content and are referenced with annotations. (See end of Document for details)

- 3.2.9. ‘*Optional equipment*’ means all the features not included in the standard equipment which are fitted to a vehicle under the responsibility of the manufacturer, and that can be ordered by the customer.
- 3.2.10. ‘*Reference atmospheric conditions (regarding road load measurements)*’ means the atmospheric conditions to which these measurement results are corrected:
- (a) Atmospheric pressure: $p_0 = 100$ kPa;
 - (b) Atmospheric temperature: $T_0 = 20$ °C;
 - (c) Dry air density: $\rho_0 = 1,189$ kg/m³;
 - (d) Wind speed: 0 m/s.
- 3.2.11. ‘*Reference speed*’ means the vehicle speed at which road load is determined or chassis dynamometer load is verified.
- 3.2.12. ‘*Road load*’ means the force resisting the forward motion of a vehicle as measured with the coastdown method or methods that are equivalent regarding the inclusion of frictional losses of the drivetrain.
- 3.2.13. ‘*Rolling resistance*’ means the forces of the tyres opposing the motion of a vehicle.
- 3.2.14. ‘*Running resistance*’ means the torque resisting the forward motion of a vehicle measured by torque meters installed at the driven wheels of a vehicle.
- 3.2.15. ‘*Simulated road load*’ means the road load experienced by the vehicle on the chassis dynamometer which is intended to reproduce the road load measured on the road, and consists of the force applied by the chassis dynamometer and the forces resisting the vehicle while driving on the chassis dynamometer and is approximated by the three coefficients of a second order polynomial.
- 3.2.16. ‘*Simulated running resistance*’ means the running resistance experienced by the vehicle on the chassis dynamometer which is intended to reproduce the running resistance measured on the road, and consists of the torque applied by the chassis dynamometer and the torque resisting the vehicle while driving on the chassis dynamometer and is approximated by the three coefficients of a second order polynomial.
- 3.2.17. ‘*Stationary anemometry*’ means measurement of wind speed and direction with an anemometer at a location and height above road level alongside the test road where the most representative wind conditions will be experienced.
- 3.2.18. ‘*Standard equipment*’ means the basic configuration of a vehicle which is equipped with all the features that are required under the regulatory acts referred to in Annex IV and Annex XI of Directive 2007/46/EC including all features that are fitted without giving rise to any further specifications on configuration or equipment level.
- 3.2.19. ‘*Target road load*’ means the road load to be reproduced.
- 3.2.20. ‘*Target running resistance*’ means the running resistance to be reproduced on the chassis dynamometer.
- 3.2.21. Reserved

Status: Point in time view as at 01/06/2017.

Changes to legislation: There are outstanding changes not yet made to Commission Regulation (EU) 2017/1151. Any changes that have already been made to the legislation appear in the content and are referenced with annotations. (See end of Document for details)

- 3.2.22. ‘*Wind correction*’ means correction of the effect of wind on road load based on input of the stationary or on-board anemometry.
- 3.2.23. ‘*Technically permissible maximum laden mass*’ means the maximum mass allocated to a vehicle on the basis of its construction features and its design performances.
- 3.2.24. ‘*Actual mass of the vehicle*’ means the mass in running order plus the mass of the fitted optional equipment to an individual vehicle.
- 3.2.25. ‘*Test mass of the vehicle*’ means the sum of the actual mass of the vehicle, 25 kg and the mass representative of the vehicle load.
- 3.2.26. ‘*Mass representative of the vehicle load*’ means x per cent of the maximum vehicle load where x is 15 per cent for category M vehicles and 28 per cent for category N vehicles.
- 3.2.27. ‘*Technically permissible maximum laden mass of the combination*’ (MC) means the maximum mass allocated to the combination of a motor vehicle and one or more trailers on the basis of its construction features and its design performances or the maximum mass allocated to the combination of a tractor unit and a semi-trailer.
- 3.3. **Pure electric, hybrid electric and fuel cell vehicles**
- 3.3.1. ‘*All-electric range*’ (AER) means the total distance travelled by an OVC-HEV from the beginning of the charge-depleting test to the point in time during the test when the combustion engine starts to consume fuel.
- 3.3.2. ‘*Pure Electric range*’ (PER) means the total distance travelled by a PEV from the beginning of the charge-depleting test until the break-off criterion is reached.
- 3.3.3. ‘*Charge-depleting actual range*’ (R_{CDA}) means the distance travelled in a series of WLTCs in charge-depleting operating condition until the rechargeable electric energy storage system (REESS) is depleted.
- 3.3.4. ‘*Charge-depleting cycle range*’ (R_{CDC}) means the distance from the beginning of the charge-depleting test to the end of the last cycle prior to the cycle or cycles satisfying the break-off criterion, including the transition cycle where the vehicle may have operated in both depleting and sustaining conditions.
- 3.3.5. ‘*Charge-depleting operating condition*’ means an operating condition in which the energy stored in the REESS may fluctuate but decreases on average while the vehicle is driven until transition to charge-sustaining operation.
- 3.3.6. ‘*Charge-sustaining operating condition*’ means an operating condition in which the energy stored in the REESS may fluctuate but, on average, is maintained at a neutral charging balance level while the vehicle is driven.
- 3.3.7. ‘*Utility Factors*’ are ratios based on driving statistics depending on the range achieved in charge-depleting condition and are used to weigh the charge-depleting and charge-sustaining exhaust emission compounds, CO₂ emissions and fuel consumption for OVC-HEVs.
- 3.3.8. ‘*Electric machine*’ (EM) means an energy converter transforming between electrical and mechanical energy.
- 3.3.9. ‘*Energy converter*’ means a system where the form of energy output is different from the form of energy input.

Status: Point in time view as at 01/06/2017.

Changes to legislation: There are outstanding changes not yet made to Commission Regulation (EU) 2017/1151. Any changes that have already been made to the legislation appear in the content and are referenced with annotations. (See end of Document for details)

- 3.3.9.1. ‘*Propulsion energy converter*’ means an energy converter of the powertrain which is not a peripheral device whose output energy is used directly or indirectly for the purpose of vehicle propulsion
- 3.3.9.2. ‘*Category of propulsion energy converter*’ means (i) an internal combustion engine, or (ii) an electric machine, or (iii) a fuel cell.
- 3.3.10. ‘*Energy storage system*’ means a system which stores energy and releases it in the same form as was input.
- 3.3.10.1. ‘*Propulsion energy storage system*’ means an energy storage system of the powertrain which is not a peripheral device and whose output energy is used directly or indirectly for the purpose of vehicle propulsion.
- 3.3.10.2. ‘*Category of propulsion energy storage system*’ means (i) a fuel storage system, or (ii) a rechargeable electric energy storage system, or (iii) a rechargeable mechanical energy storage system.
- 3.3.10.3. ‘*Form of energy*’ means (i) electrical energy, or (ii) mechanical energy, or (iii) chemical energy (including fuels).
- 3.3.10.4. ‘*Fuel storage system*’ means a propulsion energy storage system that stores chemical energy as liquid or gaseous fuel.
- 3.3.11. ‘*Equivalent all-electric range*’ (EAER) means that portion of the total charge-depleting actual range (R_{CDA}) attributable to the use of electricity from the REESS over the charge-depleting range test.
- 3.3.12. ‘*Hybrid electric vehicle*’ (HEV) means a hybrid vehicle where one of the propulsion energy converters is an electric machine.
- 3.3.13. ‘*Hybrid vehicle*’ (HV) means a vehicle equipped with a powertrain containing at least two different categories of propulsion energy converters and at least two different categories of propulsion energy storage systems.
- 3.3.14. ‘*Net energy change*’ means the ratio of the REESS energy change divided by the cycle energy demand of the test vehicle.
- 3.3.15. ‘*Not off-vehicle charging hybrid electric vehicle*’ (NOVC-HEV) means a hybrid electric vehicle that cannot be charged from an external source
- 3.3.16. ‘*Off-vehicle charging hybrid electric vehicle*’ (OVC-HEV) means a hybrid electric vehicle that can be charged from an external source.
- 3.3.17. ‘*Pure electric vehicle*’ (PEV) means a vehicle equipped with a powertrain containing exclusively electric machines as propulsion energy converters and exclusively rechargeable electric energy storage systems as propulsion energy storage systems.
- 3.3.18. ‘*Fuel cell*’ means an energy converter transforming chemical energy (input) into electrical energy (output) or vice versa.
- 3.3.19. ‘*Fuel cell vehicle*’ (FCV) means a vehicle equipped with a powertrain containing exclusively fuel cell(s) and electric machine(s) as propulsion energy converter(s).
- 3.3.20. ‘*Fuel cell hybrid vehicle*’ (FCHV) means a fuel cell vehicle equipped with a powertrain containing at least one fuel storage system and at least one rechargeable electric energy storage system as propulsion energy storage systems.

Status: Point in time view as at 01/06/2017.

Changes to legislation: There are outstanding changes not yet made to Commission Regulation (EU) 2017/1151. Any changes that have already been made to the legislation appear in the content and are referenced with annotations. (See end of Document for details)

3.4. **Powertrain**

- 3.4.1. ‘*Powertrain*’ means the total combination in a vehicle, of propulsion energy storage system(s), propulsion energy converter(s) and the drivetrain(s) providing the mechanical energy at the wheels for the purpose of vehicle propulsion, plus peripheral devices.
- 3.4.2. ‘*Auxiliary devices*’ means energy consuming, converting, storing or supplying non-peripheral devices or systems which are installed in the vehicle for purposes other than the propulsion of the vehicle and are therefore not considered to be part of the powertrain.
- 3.4.3. ‘*Peripheral devices*’ means energy consuming, converting, storing or supplying devices, where the energy is not primarily used for the purpose of vehicle propulsion, or other parts, systems and control units, which are essential to the operation of the powertrain.
- 3.4.4. ‘*Drivetrain*’ means the connected elements of the powertrain for transmission of the mechanical energy between the propulsion energy converter(s) and the wheels.
- 3.4.5. ‘*Manual transmission*’ means a transmission where gears can only be shifted by action of the driver.

3.5. **General**

- 3.5.1. ‘*Criteria emissions*’ means those emission compounds for which limits are set in this Regulation.
- 3.5.2. Reserved
- 3.5.3. Reserved
- 3.5.4. Reserved
- 3.5.5. Reserved
- 3.5.6. ‘*Cycle energy demand*’ means the calculated positive energy required by the vehicle to drive the prescribed cycle.
- 3.5.7. Reserved
- 3.5.8. ‘*Driver-selectable mode*’ means a distinct driver-selectable condition which could affect emissions, or fuel and/or energy consumption.
- 3.5.9. ‘*Predominant mode*’ for the purposes of this Annex means a single mode that is always selected when the vehicle is switched on regardless of the operating mode selected when the vehicle was previously shut down.
- 3.5.10. ‘*Reference conditions (with regards to calculating mass emissions)*’ means the conditions upon which gas densities are based, namely 101,325 kPa and 273,15 K (0 °C).
- 3.5.11. ‘*Exhaust emissions*’ means the emission of gaseous, solid and liquid compounds.

3.6. **PM/PN**

The term ‘particle’ is conventionally used for the matter being characterised (measured) in the airborne phase (suspended matter), and the term ‘particulate’ for the deposited matter.

Status: Point in time view as at 01/06/2017.

Changes to legislation: There are outstanding changes not yet made to Commission Regulation (EU) 2017/1151. Any changes that have already been made to the legislation appear in the content and are referenced with annotations. (See end of Document for details)

3.6.1. ‘*Particle number emissions*’ (PN) means the total number of solid particles emitted from the vehicle exhaust quantified according to the dilution, sampling and measurement methods as specified in this Annex.

3.6.2. ‘*Particulate matter emissions*’ (PM) means the mass of any particulate material from the vehicle exhaust quantified according to the dilution, sampling and measurement methods as specified in this Annex.

3.7. **WLTC**

3.7.1. ‘*Rated engine power*’ (P_{rated}) means maximum engine power in kW as per the requirements of Annex XX to this Regulation.

3.7.2. ‘*Maximum speed*’ (v_{max}) means the maximum speed of a vehicle as declared by the manufacturer.

3.8. **Procedure**

3.8.1. ‘*Periodically regenerating system*’ means an exhaust emissions control device (e.g. catalytic converter, particulate trap) that requires a periodical regeneration process in less than 4 000 km of normal vehicle operation.

3.9. **Ambient Temperature Correction Test (Sub-Annex 6a)**

3.9.1. ‘*Active heat storage device*’ means a technology that stores heat within any device of a vehicle and releases the heat to a power train component over a defined time period at engine start. It is characterised by the stored enthalpy in the system and the time for heat release to the power train components.

3.9.2. ‘*Insulation materials*’ means any material in the engine compartment attached to the engine and/or the chassis with a thermal insulation effect and characterised by a maximum heat conductivity of 0,1 W/(mK).

4. **ABBREVIATIONS**

4.1. **General abbreviations**

AC	Alternating current
CFV	Critical flow venturi
CFO	Critical flow orifice
CLD	Chemiluminescent detector
CLA	Chemiluminescent analyser
CVS	Constant volume sampler
DC	Direct current
ET	Evaporation tube
Extra High ₂	WLTC extra high speed phase for Class 2 vehicles
Extra High ₃	WLTC extra high speed phase for Class 3 vehicles
FCHV	Fuel cell hybrid vehicle
FID	Flame ionisation detector
FSD	Full scale deflection
GC	Gas chromatograph
HEPA	High efficiency particulate air (filter)
HFID	Heated flame ionisation detector
High ₂	WLTC high speed phase for Class 2 vehicles
High ₃₋₁	WLTC high speed phase for Class 3 vehicles $v_{\text{max}} < 120$ with km/h
High ₃₋₂	WLTC high speed phase for Class 3 vehicles with $v_{\text{max}} \geq 120$ km/h

Status: Point in time view as at 01/06/2017.

Changes to legislation: There are outstanding changes not yet made to Commission Regulation (EU) 2017/1151. Any changes that have already been made to the legislation appear in the content and are referenced with annotations. (See end of Document for details)

ICE	Internal combustion engine
LoD	Limit of detection
LoQ	Limit of quantification
Low ₁	WLTC low speed phase for Class 1 vehicles
Low ₂	WLTC low speed phase for Class 2 vehicles
Low ₃	WLTC low speed phase for Class 3 vehicles
Medium ₁	WLTC medium speed phase for Class 1 vehicles
Medium ₂	WLTC medium speed phase for Class 2 vehicles
Medium ₃₋₁	WLTC medium speed phase for Class 3 vehicles with $v_{\max} < 120$ km/h
Medium ₃₋₂	WLTC medium speed phase for Class 3 vehicles with $v_{\max} \geq 120$ km/h
LC	Liquid chromatography
LPG	Liquefied petroleum gas
NDIR	Non-dispersive infrared (analyser)
NDUV	Non-dispersive ultraviolet
NG/biomethane	Natural gas/biomethane
NMC	Non-methane cutter
NOVC-FCHV	Not off-vehicle charging fuel cell hybrid vehicle
NOVC	Not off-vehicle charging
NOVC-HEV	Not off-vehicle charging hybrid electric vehicle
OVC-HEV	Off-vehicle charging hybrid electric vehicle
P _a	Particulate mass collected on the background filter
P _e	Particulate mass collected on the sample filter
PAO	Poly-alpha-olefin
PCF	Particle pre-classifier
PCRF	Particle concentration reduction factor
PDP	Positive displacement pump
PER	Pure electric range
Per cent FS	Per cent of full scale
PM	Particulate matter emissions
PN	Particle number emissions
PNC	Particle number counter
PND ₁	First particle number dilution device
PND ₂	Second particle number dilution device
PTS	Particle transfer system
PTT	Particle transfer tube
QCL-IR	Infrared quantum cascade laser
R _{CDA}	Charge-depleting actual range
RCB	REESS charge balance
REESS	Rechargeable electric energy storage system
SSV	Subsonic venturi
USFM	Ultrasonic flow meter
VPR	Volatile particle remover
WLTC	Worldwide light-duty test cycle

4.2. Chemical symbols and abbreviations

C ₁	Carbon 1 equivalent hydrocarbon
CH ₄	Methane
C ₂ H ₆	Ethane
C ₂ H ₅ OH	Ethanol
C ₃ H ₈	Propane
CO	Carbon monoxide

Status: Point in time view as at 01/06/2017.

Changes to legislation: There are outstanding changes not yet made to Commission Regulation (EU) 2017/1151. Any changes that have already been made to the legislation appear in the content and are referenced with annotations. (See end of Document for details)

CO ₂	Carbon dioxide
DOP	Di-octylphthalate
H ₂ O	Water
NH ₃	Ammonia
NMHC	Non-methane hydrocarbons
NO _x	Oxides of nitrogen
NO	Nitric oxide
NO ₂	Nitrogen dioxide
N ₂ O	Nitrous oxide
THC	Total hydrocarbons

5. GENERAL REQUIREMENTS

5.0 Each of the vehicle families defined in paragraphs 5.6. to 5.9. shall be attributed an unique identifier of the following format:

FT-TA-WMI-yyyy-nnnn

Where:

- FT is an identifier of the family type:
 - IP = Interpolation family as defined in paragraph 5.6.
 - RL = Road load family as defined in paragraph 5.7.
 - RM = Road load matrix family as defined in paragraph 5.8.
 - PR = Periodically regenerating systems (K_i) family as defined in paragraph 5.9.
 - TA is the distinguishing number of the authority responsible for the family approval as defined in section 1 of point 1 of Annex VII of Directive (EC) 2007/46
 - WMI (world manufacturer identifier) is a code that identifies the manufacturer in a unique manner and is defined in ISO 3780:2009. For a single manufacturers several WMI codes may be used.
 - yyyy is the year when the test for the family were concluded
 - nnnn is a four digit sequence number
- 5.1. The vehicle and its components liable to affect the emissions of gaseous compounds, particulate matter and particle number shall be so designed, constructed and assembled as to enable the vehicle in normal use and under normal conditions of use such as humidity, rain, snow, heat, cold, sand, dirt, vibrations, wear, etc. to comply with the provisions of this Annex during its useful life.
- 5.1.1. This shall include the security of all hoses, joints and connections used within the emission control systems.
- 5.2. The test vehicle shall be representative in terms of its emissions-related components and functionality of the intended production series to be covered by the approval. The manufacturer and the approval authority shall agree which vehicle test model is representative.
- 5.3. **Vehicle testing condition**
- 5.3.1. The types and amounts of lubricants and coolant for emissions testing shall be as specified for normal vehicle operation by the manufacturer.
- 5.3.2. The type of fuel for emissions testing shall be as specified in Annex IX.

Status: Point in time view as at 01/06/2017.

Changes to legislation: There are outstanding changes not yet made to Commission Regulation (EU) 2017/1151. Any changes that have already been made to the legislation appear in the content and are referenced with annotations. (See end of Document for details)

- 5.3.3. All emissions controlling systems shall be in working order.
- 5.3.4. The use of any defeat device is prohibited, according to the provisions of Article 5(2) of Regulation (EC) No 715/2007.
- 5.3.5. The engine shall be designed to avoid crankcase emissions.
- 5.3.6. The tyres used for emissions testing shall be as defined in paragraph 1.2.4.5. of Sub-Annex 6 to this Annex.
- 5.4. **Petrol tank inlet orifices**
- 5.4.1. Subject to paragraph 5.4.2., the inlet orifice of the petrol or ethanol tank shall be so designed as to prevent the tank from being filled from a fuel pump delivery nozzle that has an external diameter of 23.6 mm or greater.
- 5.4.2. Paragraph 5.4.1. shall not apply to a vehicle in respect of which both of the following conditions are satisfied:
- (a) The vehicle is so designed and constructed that no device designed to control the emissions shall be adversely affected by leaded petrol; and
- (b) The vehicle is conspicuously, legibly and indelibly marked with the symbol for unleaded petrol, specified in ISO 2575:2010 ‘Road vehicles – Symbols for controls, indicators and tell-tales’, in a position immediately visible to a person filling the petrol tank. Additional markings are permitted.
- 5.5. **Provisions for electronic system security**
- 5.5.1. Any vehicle with an emission control computer shall include features to deter modification, except as authorised by the manufacturer. The manufacturer shall authorise modifications if these modifications are necessary for the diagnosis, servicing, inspection, retrofitting or repair of the vehicle. Any reprogrammable computer codes or operating parameters shall be resistant to tampering and afford a level of protection at least as good as the provisions in ISO 15031-7 (March 15, 2001). Any removable calibration memory chips shall be potted, encased in a sealed container or protected by electronic algorithms and shall not be changeable without the use of specialized tools and procedures.
- 5.5.2. Computer-coded engine operating parameters shall not be changeable without the use of specialized tools and procedures (e.g. soldered or potted computer components or sealed (or soldered) enclosures).
- 5.5.3. Manufacturers may seek approval from the approval authority for an exemption to one of these requirements for those vehicles that are unlikely to require protection. The criteria that the approval authority shall evaluate in considering an exemption shall include, but are not limited to, the current availability of performance chips, the high-performance capability of the vehicle and the projected sales volume of the vehicle.
- 5.5.4. Manufacturers using programmable computer code systems shall deter unauthorised reprogramming. Manufacturers shall include enhanced tamper protection strategies and write-protect features requiring electronic access to an off-site computer maintained by the manufacturer, to which independent operators shall also have access using the protection afforded in paragraph 5.5.1. and Section 2.2. of Annex XIV. Methods giving an adequate level of tamper protection will be approved by the approval authority.

Status: Point in time view as at 01/06/2017.

Changes to legislation: There are outstanding changes not yet made to Commission Regulation (EU) 2017/1151. Any changes that have already been made to the legislation appear in the content and are referenced with annotations. (See end of Document for details)

5.6. Interpolation family

5.6.1. Interpolation family for ICE vehicles

Only vehicles that are identical with respect to the following vehicle/powertrain/transmission characteristics may be part of the same interpolation family:

- (a) Type of internal combustion engine: fuel type, combustion type, engine displacement, full-load characteristics, engine technology, and charging system, and also other engine subsystems or characteristics that have a non-negligible influence on CO₂ mass emission under WLTP conditions;
- (b) Operation strategy of all CO₂ mass emission influencing components within the powertrain;
- (c) Transmission type (e.g. manual, automatic, CVT) and transmission model (e.g. torque rating, number of gears, number of clutches, etc.);
- (d) n/v ratios (engine rotational speed divided by vehicle speed). This requirement shall be considered fulfilled if, for all transmission ratios concerned, the difference with respect to the transmission ratios of the most commonly installed transmission type is within 8 per cent;
- (e) Number of powered axles;
- (f) ATCT family.

Vehicles may only be part of the same interpolation family if they belong to the same vehicle class as described in paragraph 2 of Sub-Annex 1.

5.6.2. Interpolation family for NOVC-HEVs and OVC-HEVs

In addition to the requirements of paragraph 5.6.1., only OVC-HEVs and NOVC-HEVs that are identical with respect to the following characteristics may be part of the same interpolation family:

- (a) Type and number of electric machines (construction type (asynchronous/ synchronous, etc.), type of coolant (air, liquid,) and any other characteristics having a non-negligible influence on CO₂ mass emission and electric energy consumption under WLTP conditions;
- (b) Type of traction REESS (model, capacity, nominal voltage, nominal power, type of coolant (air, liquid));
- (c) Type of energy converter between the electric machine and traction REESS, between the traction REESS and low voltage power supply and between the recharge-plug-in and traction REESS, and any other characteristics having a non-negligible influence on CO₂ mass emission and electric energy consumption under WLTP conditions.
- (d) The difference between the number of charge-depleting cycles from the beginning of the test up to and including the transition cycle shall not be more than one.

5.6.3. Interpolation family for PEVs

Only PEVs that are identical with respect to the following electric powertrain/transmission characteristics may be part of the same interpolation family:

Status: Point in time view as at 01/06/2017.

Changes to legislation: There are outstanding changes not yet made to Commission Regulation (EU) 2017/1151. Any changes that have already been made to the legislation appear in the content and are referenced with annotations. (See end of Document for details)

- (a) Type and number of electric machines (construction type (asynchronous/ synchronous, etc.), type of coolant (air, liquid) and any other characteristics having a non-negligible influence on electric energy consumption and range under WLTP conditions;
- (b) Type of traction REESS (model, capacity, nominal voltage, nominal power, type of coolant (air, liquid));
- (c) Transmission type (e.g. manual, automatic, CVT) and transmission model (e.g. torque rating, number of gears, numbers of clutches, etc.);
- (d) Number of powered axles;
- (e) Type of electric converter between the electric machine and traction REESS, between the traction REESS and low voltage power supply and between the recharge-plug-in and traction REESS, and any other characteristics having a non-negligible influence on electric energy consumption and range under WLTP conditions;
- (f) Operation strategy of all components influencing the electric energy consumption within the powertrain;
- (g) n/v ratios (engine rotational speed divided by vehicle speed). This requirement shall be considered fulfilled if, for all transmission ratios concerned, the difference with respect to the transmission ratios of the most commonly installed transmission type and model is within 8 per cent.

5.7. Road load family

Only vehicles that are identical with respect to the following characteristics may be part of the same road load family:

- (a) Transmission type (e.g. manual, automatic, CVT) and transmission model (e.g. torque rating, number of gears, number of clutches, etc.). At the request of the manufacturer and with approval of the approval authority, a transmission with lower power losses may be included in the family;
- (b) n/v ratios (engine rotational speed divided by vehicle speed). This requirement shall be considered fulfilled if, for all transmission ratios concerned, the difference with respect to the transmission ratios of the most commonly installed transmission type is within 25 per cent;
- (c) Number of powered axles;
- (d) If at least one electric machine is coupled in the gearbox position neutral and the vehicle is not equipped with a coastdown mode (paragraph 4.2.1.8.5. of Sub-Annex 4) such that the electric machine has no influence on the road load, the criteria from paragraph 5.6.2. (a) and paragraph 5.6.3. (a) shall apply.

If there is a difference, apart from vehicle mass, rolling resistance and aerodynamics, that has a non-negligible influence on road load, that vehicle shall not be considered to be part of the family unless approved by the approval authority.

5.8. Road load matrix family

The road load matrix family may be applied for vehicles designed for a technically permissible maximum laden mass $\geq 3\,000$ kg.

Only vehicles which are identical with respect to the following characteristics may be part of the same road load matrix family:

Status: Point in time view as at 01/06/2017.

Changes to legislation: There are outstanding changes not yet made to Commission Regulation (EU) 2017/1151. Any changes that have already been made to the legislation appear in the content and are referenced with annotations. (See end of Document for details)

(a) Transmission type (e.g. manual, automatic, CVT);

(b) Number of powered axles.

5.9. Periodically regenerating systems (K_i) family

Only vehicles that are identical with respect to the following characteristics may be part of the same periodically regenerating systems family:

5.9.1. Type of internal combustion engine: fuel type, combustion type,

5.9.2. Periodically regenerating system (i.e. catalyst, particulate trap);

(a) Construction (i.e. type of enclosure, type of precious metal, type of substrate, cell density);

(b) Type and working principle;

(c) Volume ± 10 per cent;

(d) Location (temperature ± 100 °C at 2nd highest reference speed);

(e) The test mass of each vehicle in the family must be less than or equal to the test mass of the vehicle used for the K_i demonstration test plus 250 kg.

6. PERFORMANCE REQUIREMENTS

6.1. Limit values

Limit values for emissions shall be those specified in Annex I of Regulation (EC) No 715/2007.

6.2. Testing

Testing shall be performed according to:

(a) The WLTCs as described in Sub-Annex 1;

(b) The gear selection and shift point determination as described in Sub-Annex 2;

(c) The appropriate fuel as described in Annex IX of this Regulation;

(d) The road load and dynamometer settings as described in Sub-Annex 4;

(e) The test equipment as described in Sub-Annex 5;

(f) The test procedures as described in Sub-Annexes 6 and 8;

(g) The methods of calculation as described in Sub-Annexes 7 and 8.

Sub-Annex 1

Worldwide light-duty test cycles (WLTC)

1. General requirements

1.1. The cycle to be driven depends on the ratio of the test vehicle's rated power to mass in running order, W/kg, and its maximum velocity, v_{\max} .

Status: Point in time view as at 01/06/2017.

Changes to legislation: There are outstanding changes not yet made to Commission Regulation (EU) 2017/1151. Any changes that have already been made to the legislation appear in the content and are referenced with annotations. (See end of Document for details)

The cycle resulting from the requirements described in this Sub-Annex shall be referred to in other parts of the Annex as the ‘applicable cycle’.

2. Vehicle classifications

- 2.1. Class 1 vehicles have a power to mass in running order ratio $P_{mr} \leq 22$ W/kg.
- 2.2. Class 2 vehicles have a power to mass in running order ratio > 22 but ≤ 34 W/kg.
- 2.3. Class 3 vehicles have a power to mass in running order ratio > 34 W/kg.
- 2.3.1. All vehicles tested according to Sub-Annex 8 shall be considered to be Class 3 vehicles.

3. Test cycles

3.1. Class 1 vehicles

- 3.1.1. A complete cycle for Class 1 vehicles shall consist of a low phase (Low_1), a medium phase ($Medium_1$) and an additional low phase (Low_1).
- 3.1.2. The Low_1 phase is described in Figure A1/1 and Table A1/1.
- 3.1.3. The $Medium_1$ phase is described in Figure A1/2 and Table A1/2.

3.2. Class 2 vehicles

- 3.2.1. A complete cycle for Class 2 vehicles shall consist of a low phase (Low_2), a medium phase ($Medium_2$), a high phase ($High_2$) and an extra high phase ($Extra\ High_2$).
- 3.2.2. The Low_2 phase is described in Figure A1/3 and Table A1/3.
- 3.2.3. The $Medium_2$ phase is described in Figure A1/4 and Table A1/4.
- 3.2.4. The $High_2$ phase is described in Figure A1/5 and Table A1/5.
- 3.2.5. The $Extra\ High_2$ phase is described in Figure A1/6 and Table A1/6.

3.3. Class 3 vehicles

Class 3 vehicles are divided into 2 subclasses according to their maximum speed, v_{max} .

3.3.1. Class 3a vehicles with $v_{max} < 120$ km/h

- 3.3.1.1. A complete cycle shall consist of a low phase (Low_3), a medium phase ($Medium_{3-1}$), a high phase ($High_{3-1}$) and an extra high phase ($Extra\ High_3$).
- 3.3.1.2. The Low_3 phase is described in Figure A1/7 and Table A1/7.
- 3.3.1.3. The $Medium_{3-1}$ phase is described in Figure A1/8 and Table A1/8.
- 3.3.1.4. The $High_{3-1}$ phase is described in Figure A1/10 and Table A1/10.
- 3.3.1.5. The $Extra\ High_3$ phase is described in Figure A1/12 and Table A1/12.

3.3.2. Class 3b vehicles with $v_{max} \geq 120$ km/h

- 3.3.2.1. A complete cycle shall consist of a low phase (Low_3) phase, a medium phase ($Medium_{3-2}$), a high phase ($High_{3-2}$) and an extra high phase ($Extra\ High_3$).

Status: Point in time view as at 01/06/2017.

Changes to legislation: There are outstanding changes not yet made to Commission Regulation (EU) 2017/1151. Any changes that have already been made to the legislation appear in the content and are referenced with annotations. (See end of Document for details)

- 3.3.2.2. The Low₃ phase is described in Figure A1/7 and Table A1/7.
- 3.3.2.3. The Medium₃₋₂ phase is described in Figure A1/9 and Table A1/9.
- 3.3.2.4. The High₃₋₂ phase is described in Figure A1/11 and Table A1/11.
- 3.3.2.5. The Extra High₃ phase is described in Figure A1/12 and Table A1/12.
- 3.4. Duration of all phases
 - 3.4.1. All low speed phases last 589 seconds.
 - 3.4.2. All medium speed phases last 433 seconds.
 - 3.4.3. All high speed phases last 455 seconds.
 - 3.4.4. All extra high speed phases last 323 seconds.
- 3.5. WLTCcity cycles

OVC-HEVs and PEVs shall be tested using the WLTC and WLTC city cycles (see Sub-Annex 8) for Class 3a and Class 3b vehicles.

The WLTC city cycle consists of the low and medium speed phases only.

- 4. WLTC Class 1 vehicles
- Figure A1/1*

WLTC, Class 1 vehicles, phase Low₁

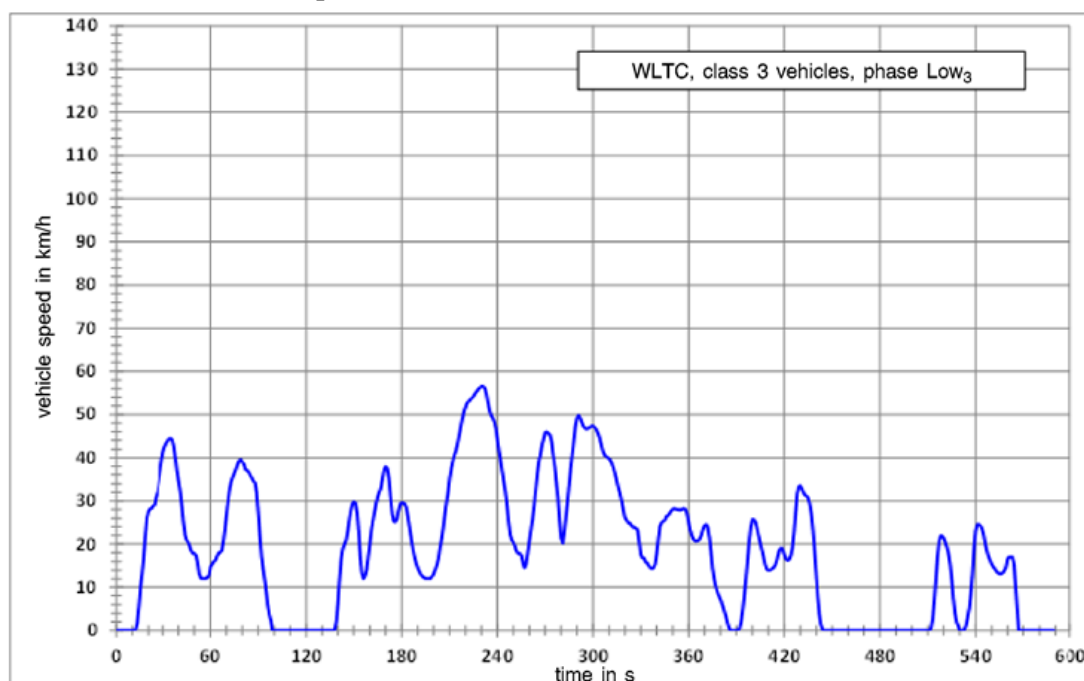

Figure A1/2

Status: Point in time view as at 01/06/2017.

Changes to legislation: There are outstanding changes not yet made to Commission Regulation (EU) 2017/1151. Any changes that have already been made to the legislation appear in the content and are referenced with annotations. (See end of Document for details)

WLTC, Class 1 vehicles, phase Medium₁

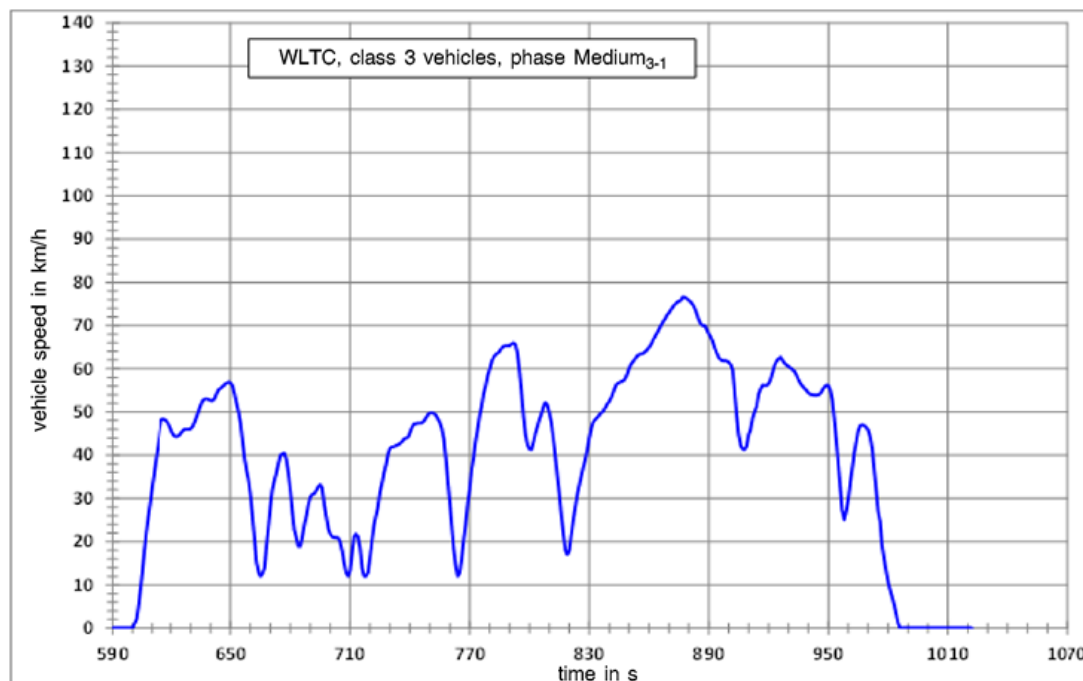

TABLE A1/1

WLTC, Class 1 vehicles, phase Low₁

Time in s	Speed in km/h
0	0,0
1	0,0
2	0,0
3	0,0
4	0,0
5	0,0
6	0,0
7	0,0
8	0,0
9	0,0
10	0,0
11	0,0
12	0,2
13	3,1
14	5,7
15	8,0

Status: Point in time view as at 01/06/2017.

Changes to legislation: There are outstanding changes not yet made to Commission Regulation (EU) 2017/1151. Any changes that have already been made to the legislation appear in the content and are referenced with annotations. (See end of Document for details)

16	10,1
17	12,0
18	13,8
19	15,4
20	16,7
21	17,7
22	18,3
23	18,8
24	18,9
25	18,4
26	16,9
27	14,3
28	10,8
29	7,1
30	4,0
31	0,0
32	0,0
33	0,0
34	0,0
35	1,5
36	3,8
37	5,6
38	7,5
39	9,2
40	10,8
41	12,4
42	13,8
43	15,2
44	16,3
45	17,3
46	18,0
47	18,8
48	19,5
49	20,2

Status: Point in time view as at 01/06/2017.

Changes to legislation: There are outstanding changes not yet made to Commission Regulation (EU) 2017/1151. Any changes that have already been made to the legislation appear in the content and are referenced with annotations. (See end of Document for details)

50	20,9
51	21,7
52	22,4
53	23,1
54	23,7
55	24,4
56	25,1
57	25,4
58	25,2
59	23,4
60	21,8
61	19,7
62	17,3
63	14,7
64	12,0
65	9,4
66	5,6
67	3,1
68	0,0
69	0,0
70	0,0
71	0,0
72	0,0
73	0,0
74	0,0
75	0,0
76	0,0
77	0,0
78	0,0
79	0,0
80	0,0
81	0,0
82	0,0
83	0,0

Status: Point in time view as at 01/06/2017.

Changes to legislation: There are outstanding changes not yet made to Commission Regulation (EU) 2017/1151. Any changes that have already been made to the legislation appear in the content and are referenced with annotations. (See end of Document for details)

84	0,0
85	0,0
86	0,0
87	0,0
88	0,0
89	0,0
90	0,0
91	0,0
92	0,0
93	0,0
94	0,0
95	0,0
96	0,0
97	0,0
98	0,0
99	0,0
100	0,0
101	0,0
102	0,0
103	0,0
104	0,0
105	0,0
106	0,0
107	0,0
108	0,7
109	1,1
110	1,9
111	2,5
112	3,5
113	4,7
114	6,1
115	7,5
116	9,4
117	11,0

Status: Point in time view as at 01/06/2017.

Changes to legislation: There are outstanding changes not yet made to Commission Regulation (EU) 2017/1151. Any changes that have already been made to the legislation appear in the content and are referenced with annotations. (See end of Document for details)

118	12,9
119	14,5
120	16,4
121	18,0
122	20,0
123	21,5
124	23,5
125	25,0
126	26,8
127	28,2
128	30,0
129	31,4
130	32,5
131	33,2
132	33,4
133	33,7
134	33,9
135	34,2
136	34,4
137	34,7
138	34,9
139	35,2
140	35,4
141	35,7
142	35,9
143	36,6
144	37,5
145	38,4
146	39,3
147	40,0
148	40,6
149	41,1
150	41,4
151	41,6

Status: Point in time view as at 01/06/2017.

Changes to legislation: There are outstanding changes not yet made to Commission Regulation (EU) 2017/1151. Any changes that have already been made to the legislation appear in the content and are referenced with annotations. (See end of Document for details)

152	41,8
153	41,8
154	41,9
155	41,9
156	42,0
157	42,0
158	42,2
159	42,3
160	42,6
161	43,0
162	43,3
163	43,7
164	44,0
165	44,3
166	44,5
167	44,6
168	44,6
169	44,5
170	44,4
171	44,3
172	44,2
173	44,1
174	44,0
175	43,9
176	43,8
177	43,7
178	43,6
179	43,5
180	43,4
181	43,3
182	43,1
183	42,9
184	42,7
185	42,5

Status: Point in time view as at 01/06/2017.

Changes to legislation: There are outstanding changes not yet made to Commission Regulation (EU) 2017/1151. Any changes that have already been made to the legislation appear in the content and are referenced with annotations. (See end of Document for details)

186	42,3
187	42,2
188	42,2
189	42,2
190	42,3
191	42,4
192	42,5
193	42,7
194	42,9
195	43,1
196	43,2
197	43,3
198	43,4
199	43,4
200	43,2
201	42,9
202	42,6
203	42,2
204	41,9
205	41,5
206	41,0
207	40,5
208	39,9
209	39,3
210	38,7
211	38,1
212	37,5
213	36,9
214	36,3
215	35,7
216	35,1
217	34,5
218	33,9
219	33,6

Status: Point in time view as at 01/06/2017.

Changes to legislation: There are outstanding changes not yet made to Commission Regulation (EU) 2017/1151. Any changes that have already been made to the legislation appear in the content and are referenced with annotations. (See end of Document for details)

220	33,5
221	33,6
222	33,9
223	34,3
224	34,7
225	35,1
226	35,5
227	35,9
228	36,4
229	36,9
230	37,4
231	37,9
232	38,3
233	38,7
234	39,1
235	39,3
236	39,5
237	39,7
238	39,9
239	40,0
240	40,1
241	40,2
242	40,3
243	40,4
244	40,5
245	40,5
246	40,4
247	40,3
248	40,2
249	40,1
250	39,7
251	38,8
252	37,4
253	35,6

Status: Point in time view as at 01/06/2017.

Changes to legislation: There are outstanding changes not yet made to Commission Regulation (EU) 2017/1151. Any changes that have already been made to the legislation appear in the content and are referenced with annotations. (See end of Document for details)

254	33,4
255	31,2
256	29,1
257	27,6
258	26,6
259	26,2
260	26,3
261	26,7
262	27,5
263	28,4
264	29,4
265	30,4
266	31,2
267	31,9
268	32,5
269	33,0
270	33,4
271	33,8
272	34,1
273	34,3
274	34,3
275	33,9
276	33,3
277	32,6
278	31,8
279	30,7
280	29,6
281	28,6
282	27,8
283	27,0
284	26,4
285	25,8
286	25,3
287	24,9

Status: Point in time view as at 01/06/2017.

Changes to legislation: There are outstanding changes not yet made to Commission Regulation (EU) 2017/1151. Any changes that have already been made to the legislation appear in the content and are referenced with annotations. (See end of Document for details)

288	24,5
289	24,2
290	24,0
291	23,8
292	23,6
293	23,5
294	23,4
295	23,3
296	23,3
297	23,2
298	23,1
299	23,0
300	22,8
301	22,5
302	22,1
303	21,7
304	21,1
305	20,4
306	19,5
307	18,5
308	17,6
309	16,6
310	15,7
311	14,9
312	14,3
313	14,1
314	14,0
315	13,9
316	13,8
317	13,7
318	13,6
319	13,5
320	13,4
321	13,3

Status: Point in time view as at 01/06/2017.

Changes to legislation: There are outstanding changes not yet made to Commission Regulation (EU) 2017/1151. Any changes that have already been made to the legislation appear in the content and are referenced with annotations. (See end of Document for details)

322	13,2
323	13,2
324	13,2
325	13,4
326	13,5
327	13,7
328	13,8
329	14,0
330	14,1
331	14,3
332	14,4
333	14,4
334	14,4
335	14,3
336	14,3
337	14,0
338	13,0
339	11,4
340	10,2
341	8,0
342	7,0
343	6,0
344	5,5
345	5,0
346	4,5
347	4,0
348	3,5
349	3,0
350	2,5
351	2,0
352	1,5
353	1,0
354	0,5
355	0,0

Status: Point in time view as at 01/06/2017.

Changes to legislation: There are outstanding changes not yet made to Commission Regulation (EU) 2017/1151. Any changes that have already been made to the legislation appear in the content and are referenced with annotations. (See end of Document for details)

356	0,0
357	0,0
358	0,0
359	0,0
360	0,0
361	2,2
362	4,5
363	6,6
364	8,6
365	10,6
366	12,5
367	14,4
368	16,3
369	17,9
370	19,1
371	19,9
372	20,3
373	20,5
374	20,7
375	21,0
376	21,6
377	22,6
378	23,7
379	24,8
380	25,7
381	26,2
382	26,4
383	26,4
384	26,4
385	26,5
386	26,6
387	26,8
388	26,9
389	27,2

Status: Point in time view as at 01/06/2017.

Changes to legislation: There are outstanding changes not yet made to Commission Regulation (EU) 2017/1151. Any changes that have already been made to the legislation appear in the content and are referenced with annotations. (See end of Document for details)

390	27,5
391	28,0
392	28,8
393	29,9
394	31,0
395	31,9
396	32,5
397	32,6
398	32,4
399	32,0
400	31,3
401	30,3
402	28,0
403	27,0
404	24,0
405	22,5
406	19,0
407	17,5
408	14,0
409	12,5
410	9,0
411	7,5
412	4,0
413	2,9
414	0,0
415	0,0
416	0,0
417	0,0
418	0,0
419	0,0
420	0,0
421	0,0
422	0,0
423	0,0

Status: Point in time view as at 01/06/2017.

Changes to legislation: There are outstanding changes not yet made to Commission Regulation (EU) 2017/1151. Any changes that have already been made to the legislation appear in the content and are referenced with annotations. (See end of Document for details)

424	0,0
425	0,0
426	0,0
427	0,0
428	0,0
429	0,0
430	0,0
431	0,0
432	0,0
433	0,0
434	0,0
435	0,0
436	0,0
437	0,0
438	0,0
439	0,0
440	0,0
441	0,0
442	0,0
443	0,0
444	0,0
445	0,0
446	0,0
447	0,0
448	0,0
449	0,0
450	0,0
451	0,0
452	0,0
453	0,0
454	0,0
455	0,0
456	0,0
457	0,0

Status: Point in time view as at 01/06/2017.

Changes to legislation: There are outstanding changes not yet made to Commission Regulation (EU) 2017/1151. Any changes that have already been made to the legislation appear in the content and are referenced with annotations. (See end of Document for details)

458	0,0
459	0,0
460	0,0
461	0,0
462	0,0
463	0,0
464	0,0
465	0,0
466	0,0
467	0,0
468	0,0
469	0,0
470	0,0
471	0,0
472	0,0
473	0,0
474	0,0
475	0,0
476	0,0
477	0,0
478	0,0
479	0,0
480	0,0
481	1,6
482	3,1
483	4,6
484	6,1
485	7,8
486	9,5
487	11,3
488	13,2
489	15,0
490	16,8
491	18,4

Status: Point in time view as at 01/06/2017.

Changes to legislation: There are outstanding changes not yet made to Commission Regulation (EU) 2017/1151. Any changes that have already been made to the legislation appear in the content and are referenced with annotations. (See end of Document for details)

492	20,1
493	21,6
494	23,1
495	24,6
496	26,0
497	27,5
498	29,0
499	30,6
500	32,1
501	33,7
502	35,3
503	36,8
504	38,1
505	39,3
506	40,4
507	41,2
508	41,9
509	42,6
510	43,3
511	44,0
512	44,6
513	45,3
514	45,5
515	45,5
516	45,2
517	44,7
518	44,2
519	43,6
520	43,1
521	42,8
522	42,7
523	42,8
524	43,3
525	43,9

Status: Point in time view as at 01/06/2017.

Changes to legislation: There are outstanding changes not yet made to Commission Regulation (EU) 2017/1151. Any changes that have already been made to the legislation appear in the content and are referenced with annotations. (See end of Document for details)

526	44,6
527	45,4
528	46,3
529	47,2
530	47,8
531	48,2
532	48,5
533	48,7
534	48,9
535	49,1
536	49,1
537	49,0
538	48,8
539	48,6
540	48,5
541	48,4
542	48,3
543	48,2
544	48,1
545	47,5
546	46,7
547	45,7
548	44,6
549	42,9
550	40,8
551	38,2
552	35,3
553	31,8
554	28,7
555	25,8
556	22,9
557	20,2
558	17,3
559	15,0

Status: Point in time view as at 01/06/2017.

Changes to legislation: There are outstanding changes not yet made to Commission Regulation (EU) 2017/1151. Any changes that have already been made to the legislation appear in the content and are referenced with annotations. (See end of Document for details)

560	12,3
561	10,3
562	7,8
563	6,5
564	4,4
565	3,2
566	1,2
567	0,0
568	0,0
569	0,0
570	0,0
571	0,0
572	0,0
573	0,0
574	0,0
575	0,0
576	0,0
577	0,0
578	0,0
579	0,0
580	0,0
581	0,0
582	0,0
583	0,0
584	0,0
585	0,0
586	0,0
587	0,0
588	0,0
589	0,0

TABLE A1/2

WLTC, Class 1 vehicles, phase Medium₁

Time in s	Speed in km/h
590	0,0

Status: Point in time view as at 01/06/2017.

Changes to legislation: There are outstanding changes not yet made to Commission Regulation (EU) 2017/1151. Any changes that have already been made to the legislation appear in the content and are referenced with annotations. (See end of Document for details)

591	0,0
592	0,0
593	0,0
594	0,0
595	0,0
596	0,0
597	0,0
598	0,0
599	0,0
600	0,6
601	1,9
602	2,7
603	5,2
604	7,0
605	9,6
606	11,4
607	14,1
608	15,8
609	18,2
610	19,7
611	21,8
612	23,2
613	24,7
614	25,8
615	26,7
616	27,2
617	27,7
618	28,1
619	28,4
620	28,7
621	29,0
622	29,2
623	29,4
624	29,4

Status: Point in time view as at 01/06/2017.

Changes to legislation: There are outstanding changes not yet made to Commission Regulation (EU) 2017/1151. Any changes that have already been made to the legislation appear in the content and are referenced with annotations. (See end of Document for details)

625	29,3
626	28,9
627	28,5
628	28,1
629	27,6
630	26,9
631	26,0
632	24,6
633	22,8
634	21,0
635	19,5
636	18,6
637	18,4
638	19,0
639	20,1
640	21,5
641	23,1
642	24,9
643	26,4
644	27,9
645	29,2
646	30,4
647	31,6
648	32,8
649	34,0
650	35,1
651	36,3
652	37,4
653	38,6
654	39,6
655	40,6
656	41,6
657	42,4
658	43,0

Status: Point in time view as at 01/06/2017.

Changes to legislation: There are outstanding changes not yet made to Commission Regulation (EU) 2017/1151. Any changes that have already been made to the legislation appear in the content and are referenced with annotations. (See end of Document for details)

659	43,6
660	44,0
661	44,4
662	44,8
663	45,2
664	45,6
665	46,0
666	46,5
667	47,0
668	47,5
669	48,0
670	48,6
671	49,1
672	49,7
673	50,2
674	50,8
675	51,3
676	51,8
677	52,3
678	52,9
679	53,4
680	54,0
681	54,5
682	55,1
683	55,6
684	56,2
685	56,7
686	57,3
687	57,9
688	58,4
689	58,8
690	58,9
691	58,4
692	58,1

Status: Point in time view as at 01/06/2017.

Changes to legislation: There are outstanding changes not yet made to Commission Regulation (EU) 2017/1151. Any changes that have already been made to the legislation appear in the content and are referenced with annotations. (See end of Document for details)

693	57,6
694	56,9
695	56,3
696	55,7
697	55,3
698	55,0
699	54,7
700	54,5
701	54,4
702	54,3
703	54,2
704	54,1
705	53,8
706	53,5
707	53,0
708	52,6
709	52,2
710	51,9
711	51,7
712	51,7
713	51,8
714	52,0
715	52,3
716	52,6
717	52,9
718	53,1
719	53,2
720	53,3
721	53,3
722	53,4
723	53,5
724	53,7
725	54,0
726	54,4

Status: Point in time view as at 01/06/2017.

Changes to legislation: There are outstanding changes not yet made to Commission Regulation (EU) 2017/1151. Any changes that have already been made to the legislation appear in the content and are referenced with annotations. (See end of Document for details)

727	54,9
728	55,6
729	56,3
730	57,1
731	57,9
732	58,8
733	59,6
734	60,3
735	60,9
736	61,3
737	61,7
738	61,8
739	61,8
740	61,6
741	61,2
742	60,8
743	60,4
744	59,9
745	59,4
746	58,9
747	58,6
748	58,2
749	57,9
750	57,7
751	57,5
752	57,2
753	57,0
754	56,8
755	56,6
756	56,6
757	56,7
758	57,1
759	57,6
760	58,2

Status: Point in time view as at 01/06/2017.

Changes to legislation: There are outstanding changes not yet made to Commission Regulation (EU) 2017/1151. Any changes that have already been made to the legislation appear in the content and are referenced with annotations. (See end of Document for details)

761	59,0
762	59,8
763	60,6
764	61,4
765	62,2
766	62,9
767	63,5
768	64,2
769	64,4
770	64,4
771	64,0
772	63,5
773	62,9
774	62,4
775	62,0
776	61,6
777	61,4
778	61,2
779	61,0
780	60,7
781	60,2
782	59,6
783	58,9
784	58,1
785	57,2
786	56,3
787	55,3
788	54,4
789	53,4
790	52,4
791	51,4
792	50,4
793	49,4
794	48,5

Status: Point in time view as at 01/06/2017.

Changes to legislation: There are outstanding changes not yet made to Commission Regulation (EU) 2017/1151. Any changes that have already been made to the legislation appear in the content and are referenced with annotations. (See end of Document for details)

795	47,5
796	46,5
797	45,4
798	44,3
799	43,1
800	42,0
801	40,8
802	39,7
803	38,8
804	38,1
805	37,4
806	37,1
807	36,9
808	37,0
809	37,5
810	37,8
811	38,2
812	38,6
813	39,1
814	39,6
815	40,1
816	40,7
817	41,3
818	41,9
819	42,7
820	43,4
821	44,2
822	45,0
823	45,9
824	46,8
825	47,7
826	48,7
827	49,7
828	50,6

Status: Point in time view as at 01/06/2017.

Changes to legislation: There are outstanding changes not yet made to Commission Regulation (EU) 2017/1151. Any changes that have already been made to the legislation appear in the content and are referenced with annotations. (See end of Document for details)

829	51,6
830	52,5
831	53,3
832	54,1
833	54,7
834	55,3
835	55,7
836	56,1
837	56,4
838	56,7
839	57,1
840	57,5
841	58,0
842	58,7
843	59,3
844	60,0
845	60,6
846	61,3
847	61,5
848	61,5
849	61,4
850	61,2
851	60,5
852	60,0
853	59,5
854	58,9
855	58,4
856	57,9
857	57,5
858	57,1
859	56,7
860	56,4
861	56,1
862	55,8

Status: Point in time view as at 01/06/2017.

Changes to legislation: There are outstanding changes not yet made to Commission Regulation (EU) 2017/1151. Any changes that have already been made to the legislation appear in the content and are referenced with annotations. (See end of Document for details)

863	55,5
864	55,3
865	55,0
866	54,7
867	54,4
868	54,2
869	54,0
870	53,9
871	53,7
872	53,6
873	53,5
874	53,4
875	53,3
876	53,2
877	53,1
878	53,0
879	53,0
880	53,0
881	53,0
882	53,0
883	53,0
884	52,8
885	52,5
886	51,9
887	51,1
888	50,2
889	49,2
890	48,2
891	47,3
892	46,4
893	45,6
894	45,0
895	44,3
896	43,8

Status: Point in time view as at 01/06/2017.

Changes to legislation: There are outstanding changes not yet made to Commission Regulation (EU) 2017/1151. Any changes that have already been made to the legislation appear in the content and are referenced with annotations. (See end of Document for details)

897	43,3
898	42,8
899	42,4
900	42,0
901	41,6
902	41,1
903	40,3
904	39,5
905	38,6
906	37,7
907	36,7
908	36,2
909	36,0
910	36,2
911	37,0
912	38,0
913	39,0
914	39,7
915	40,2
916	40,7
917	41,2
918	41,7
919	42,2
920	42,7
921	43,2
922	43,6
923	44,0
924	44,2
925	44,4
926	44,5
927	44,6
928	44,7
929	44,6
930	44,5

Status: Point in time view as at 01/06/2017.

Changes to legislation: There are outstanding changes not yet made to Commission Regulation (EU) 2017/1151. Any changes that have already been made to the legislation appear in the content and are referenced with annotations. (See end of Document for details)

931	44,4
932	44,2
933	44,1
934	43,7
935	43,3
936	42,8
937	42,3
938	41,6
939	40,7
940	39,8
941	38,8
942	37,8
943	36,9
944	36,1
945	35,5
946	35,0
947	34,7
948	34,4
949	34,1
950	33,9
951	33,6
952	33,3
953	33,0
954	32,7
955	32,3
956	31,9
957	31,5
958	31,0
959	30,6
960	30,2
961	29,7
962	29,1
963	28,4
964	27,6

Status: Point in time view as at 01/06/2017.

Changes to legislation: There are outstanding changes not yet made to Commission Regulation (EU) 2017/1151. Any changes that have already been made to the legislation appear in the content and are referenced with annotations. (See end of Document for details)

965	26,8
966	26,0
967	25,1
968	24,2
969	23,3
970	22,4
971	21,5
972	20,6
973	19,7
974	18,8
975	17,7
976	16,4
977	14,9
978	13,2
979	11,3
980	9,4
981	7,5
982	5,6
983	3,7
984	1,9
985	1,0
986	0,0
987	0,0
988	0,0
989	0,0
990	0,0
991	0,0
992	0,0
993	0,0
994	0,0
995	0,0
996	0,0
997	0,0
998	0,0

Status: Point in time view as at 01/06/2017.

Changes to legislation: There are outstanding changes not yet made to Commission Regulation (EU) 2017/1151. Any changes that have already been made to the legislation appear in the content and are referenced with annotations. (See end of Document for details)

999	0,0
1000	0,0
1001	0,0
1002	0,0
1003	0,0
1004	0,0
1005	0,0
1006	0,0
1007	0,0
1008	0,0
1009	0,0
1010	0,0
1011	0,0
1012	0,0
1013	0,0
1014	0,0
1015	0,0
1016	0,0
1017	0,0
1018	0,0
1019	0,0
1020	0,0
1021	0,0
1022	0,0

5. WLTC for Class 2 vehicles

Figure A1/3

Status: Point in time view as at 01/06/2017.

Changes to legislation: There are outstanding changes not yet made to Commission Regulation (EU) 2017/1151. Any changes that have already been made to the legislation appear in the content and are referenced with annotations. (See end of Document for details)

WLTC, Class 2 vehicles, phase Low₂

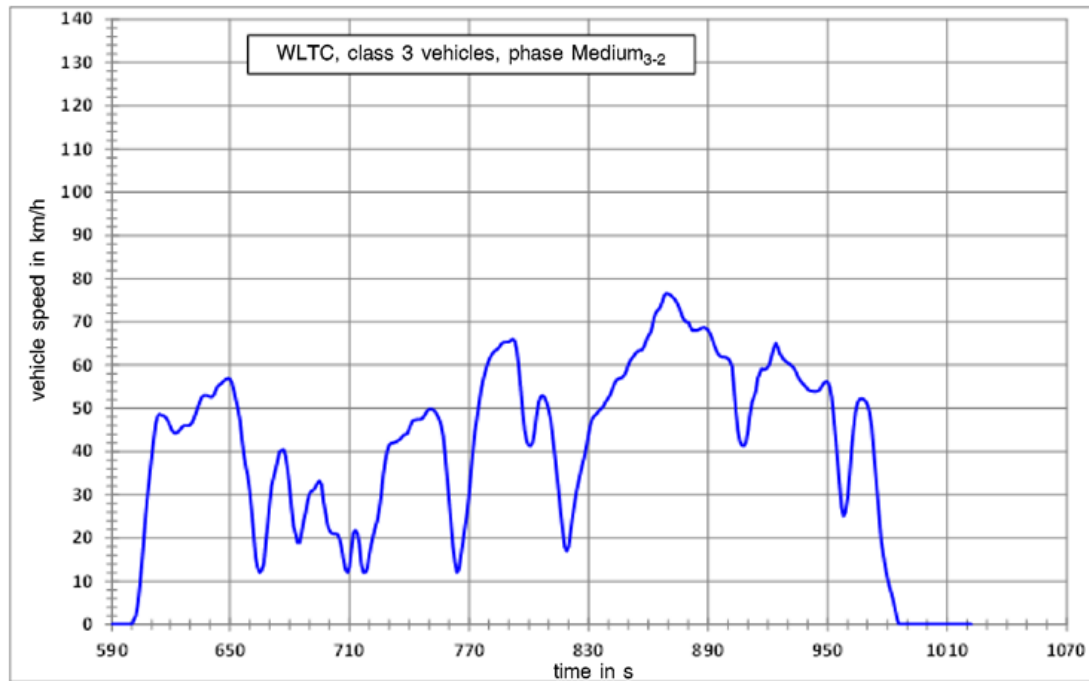

Figure A1/4

WLTC, Class 2 Vehicles, Phase Medium₂

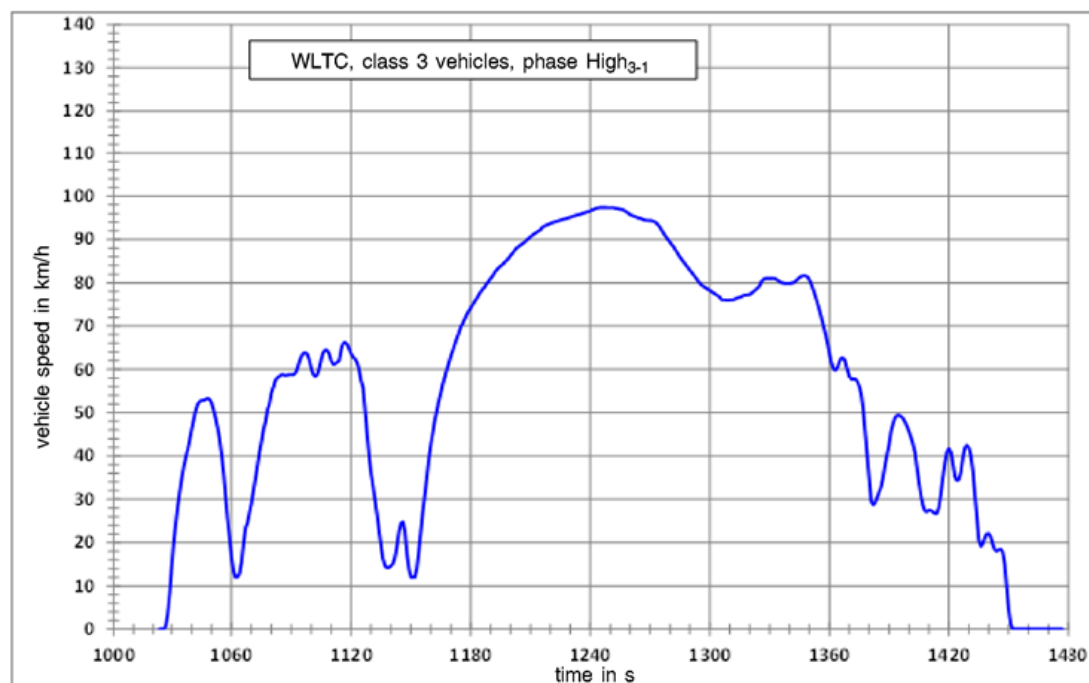

Figure A1/5

Status: Point in time view as at 01/06/2017.

Changes to legislation: There are outstanding changes not yet made to Commission Regulation (EU) 2017/1151. Any changes that have already been made to the legislation appear in the content and are referenced with annotations. (See end of Document for details)

WLTC, Class 2 vehicles, phase High₂

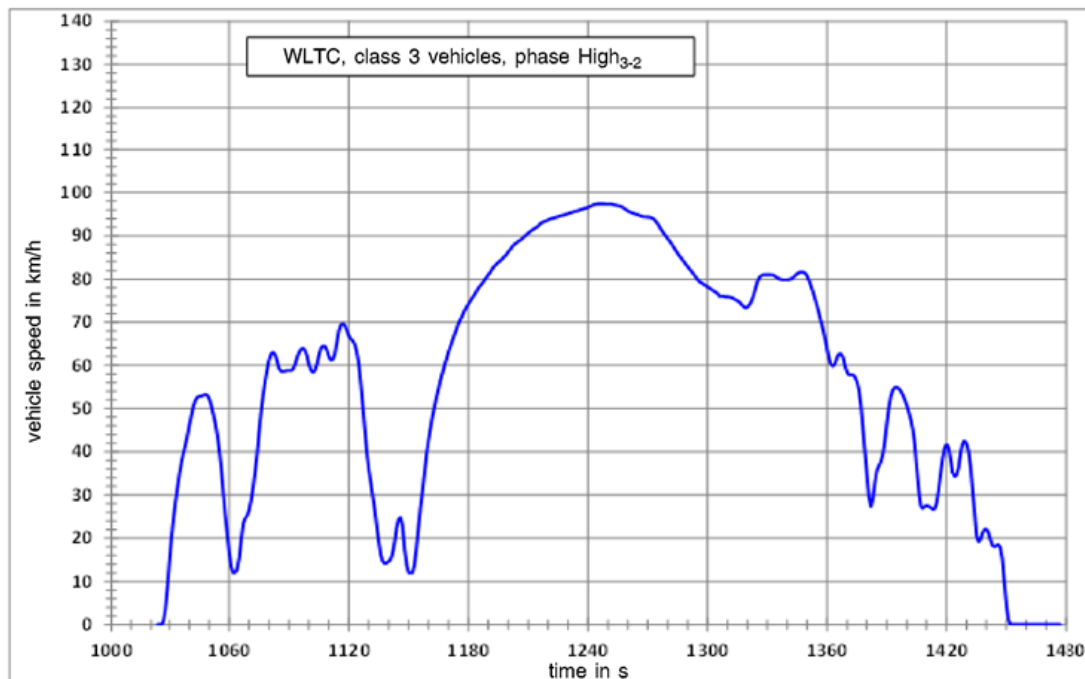

Figure A1/6

WLTC, Class 2 vehicles, phase Extra High₂

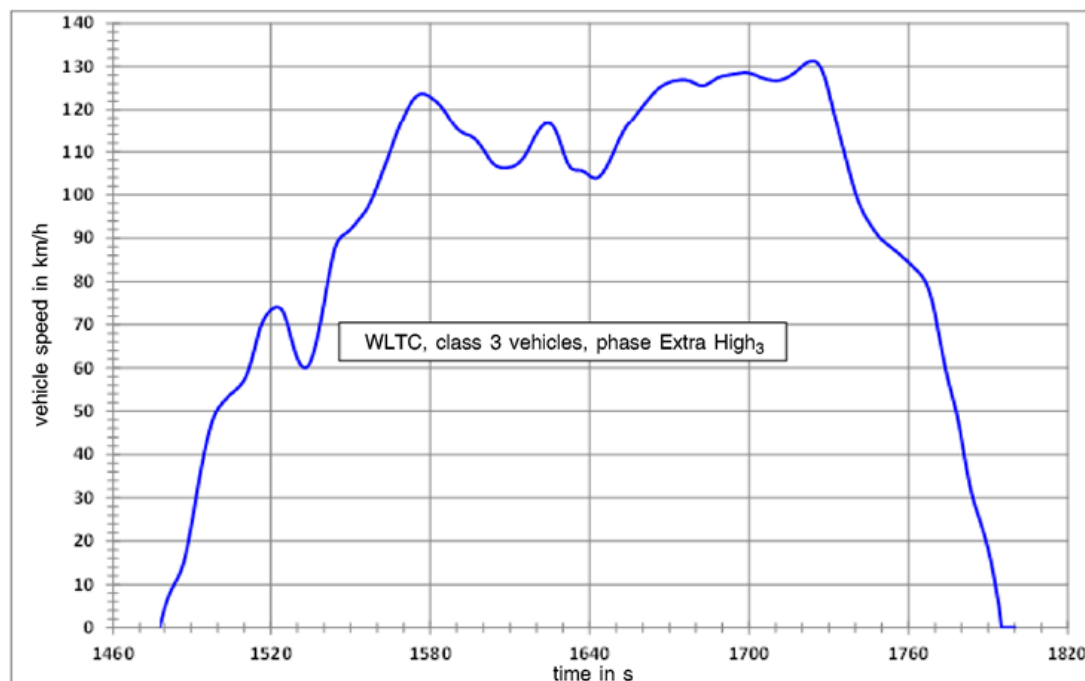

TABLE A1/3

WLTC, Class 2 vehicles, phase Low₂

Status: Point in time view as at 01/06/2017.

Changes to legislation: There are outstanding changes not yet made to Commission Regulation (EU) 2017/1151. Any changes that have already been made to the legislation appear in the content and are referenced with annotations. (See end of Document for details)

Time in s	Speed in km/h
0	0,0
1	0,0
2	0,0
3	0,0
4	0,0
5	0,0
6	0,0
7	0,0
8	0,0
9	0,0
10	0,0
11	0,0
12	0,0
13	1,2
14	2,6
15	4,9
16	7,3
17	9,4
18	11,4
19	12,7
20	13,3
21	13,4
22	13,3
23	13,1
24	12,5
25	11,1
26	8,9
27	6,2
28	3,8
29	1,8
30	0,0
31	0,0
32	0,0

Status: Point in time view as at 01/06/2017.

Changes to legislation: There are outstanding changes not yet made to Commission Regulation (EU) 2017/1151. Any changes that have already been made to the legislation appear in the content and are referenced with annotations. (See end of Document for details)

33	0,0
34	1,5
35	2,8
36	3,6
37	4,5
38	5,3
39	6,0
40	6,6
41	7,3
42	7,9
43	8,6
44	9,3
45	10
46	10,8
47	11,6
48	12,4
49	13,2
50	14,2
51	14,8
52	14,7
53	14,4
54	14,1
55	13,6
56	13,0
57	12,4
58	11,8
59	11,2
60	10,6
61	9,9
62	9,0
63	8,2
64	7,0
65	4,8
66	2,3

Status: Point in time view as at 01/06/2017.

Changes to legislation: There are outstanding changes not yet made to Commission Regulation (EU) 2017/1151. Any changes that have already been made to the legislation appear in the content and are referenced with annotations. (See end of Document for details)

67	0,0
68	0,0
69	0,0
70	0,0
71	0,0
72	0,0
73	0,0
74	0,0
75	0,0
76	0,0
77	0,0
78	0,0
79	0,0
80	0,0
81	0,0
82	0,0
83	0,0
84	0,0
85	0,0
86	0,0
87	0,0
88	0,0
89	0,0
90	0,0
91	0,0
92	0,0
93	0,0
94	0,0
95	0,0
96	0,0
97	0,0
98	0,0
99	0,0
100	0,0

Status: Point in time view as at 01/06/2017.

Changes to legislation: There are outstanding changes not yet made to Commission Regulation (EU) 2017/1151. Any changes that have already been made to the legislation appear in the content and are referenced with annotations. (See end of Document for details)

101	0,0
102	0,0
103	0,0
104	0,0
105	0,0
106	0,0
107	0,8
108	1,4
109	2,3
110	3,5
111	4,7
112	5,9
113	7,4
114	9,2
115	11,7
116	13,5
117	15,0
118	16,2
119	16,8
120	17,5
121	18,8
122	20,3
123	22,0
124	23,6
125	24,8
126	25,6
127	26,3
128	27,2
129	28,3
130	29,6
131	30,9
132	32,2
133	33,4
134	35,1

Status: Point in time view as at 01/06/2017.

Changes to legislation: There are outstanding changes not yet made to Commission Regulation (EU) 2017/1151. Any changes that have already been made to the legislation appear in the content and are referenced with annotations. (See end of Document for details)

135	37,2
136	38,7
137	39,0
138	40,1
139	40,4
140	39,7
141	36,8
142	35,1
143	32,2
144	31,1
145	30,8
146	29,7
147	29,4
148	29,0
149	28,5
150	26,0
151	23,4
152	20,7
153	17,4
154	15,2
155	13,5
156	13,0
157	12,4
158	12,3
159	12,2
160	12,3
161	12,4
162	12,5
163	12,7
164	12,8
165	13,2
166	14,3
167	16,5
168	19,4

Status: Point in time view as at 01/06/2017.

Changes to legislation: There are outstanding changes not yet made to Commission Regulation (EU) 2017/1151. Any changes that have already been made to the legislation appear in the content and are referenced with annotations. (See end of Document for details)

169	21,7
170	23,1
171	23,5
172	24,2
173	24,8
174	25,4
175	25,8
176	26,5
177	27,2
178	28,3
179	29,9
180	32,4
181	35,1
182	37,5
183	39,2
184	40,5
185	41,4
186	42,0
187	42,5
188	43,2
189	44,4
190	45,9
191	47,6
192	49,0
193	50,0
194	50,2
195	50,1
196	49,8
197	49,4
198	48,9
199	48,5
200	48,3
201	48,2
202	47,9

Status: Point in time view as at 01/06/2017.

Changes to legislation: There are outstanding changes not yet made to Commission Regulation (EU) 2017/1151. Any changes that have already been made to the legislation appear in the content and are referenced with annotations. (See end of Document for details)

203	47,1
204	45,5
205	43,2
206	40,6
207	38,5
208	36,9
209	35,9
210	35,3
211	34,8
212	34,5
213	34,2
214	34,0
215	33,8
216	33,6
217	33,5
218	33,5
219	33,4
220	33,3
221	33,3
222	33,2
223	33,1
224	33,0
225	32,9
226	32,8
227	32,7
228	32,5
229	32,3
230	31,8
231	31,4
232	30,9
233	30,6
234	30,6
235	30,7
236	32,0

Status: Point in time view as at 01/06/2017.

Changes to legislation: There are outstanding changes not yet made to Commission Regulation (EU) 2017/1151. Any changes that have already been made to the legislation appear in the content and are referenced with annotations. (See end of Document for details)

237	33,5
238	35,8
239	37,6
240	38,8
241	39,6
242	40,1
243	40,9
244	41,8
245	43,3
246	44,7
247	46,4
248	47,9
249	49,6
250	49,6
251	48,8
252	48,0
253	47,5
254	47,1
255	46,9
256	45,8
257	45,8
258	45,8
259	45,9
260	46,2
261	46,4
262	46,6
263	46,8
264	47,0
265	47,3
266	47,5
267	47,9
268	48,3
269	48,3
270	48,2

Status: Point in time view as at 01/06/2017.

Changes to legislation: There are outstanding changes not yet made to Commission Regulation (EU) 2017/1151. Any changes that have already been made to the legislation appear in the content and are referenced with annotations. (See end of Document for details)

271	48,0
272	47,7
273	47,2
274	46,5
275	45,2
276	43,7
277	42,0
278	40,4
279	39,0
280	37,7
281	36,4
282	35,2
283	34,3
284	33,8
285	33,3
286	32,5
287	30,9
288	28,6
289	25,9
290	23,1
291	20,1
292	17,3
293	15,1
294	13,7
295	13,4
296	13,9
297	15,0
298	16,3
299	17,4
300	18,2
301	18,6
302	19,0
303	19,4
304	19,8

Status: Point in time view as at 01/06/2017.

Changes to legislation: There are outstanding changes not yet made to Commission Regulation (EU) 2017/1151. Any changes that have already been made to the legislation appear in the content and are referenced with annotations. (See end of Document for details)

305	20,1
306	20,5
307	20,2
308	18,6
309	16,5
310	14,4
311	13,4
312	12,9
313	12,7
314	12,4
315	12,4
316	12,8
317	14,1
318	16,2
319	18,8
320	21,9
321	25,0
322	28,4
323	31,3
324	34,0
325	34,6
326	33,9
327	31,9
328	30,0
329	29,0
330	27,9
331	27,1
332	26,4
333	25,9
334	25,5
335	25,0
336	24,6
337	23,9
338	23,0

Status: Point in time view as at 01/06/2017.

Changes to legislation: There are outstanding changes not yet made to Commission Regulation (EU) 2017/1151. Any changes that have already been made to the legislation appear in the content and are referenced with annotations. (See end of Document for details)

339	21,8
340	20,7
341	19,6
342	18,7
343	18,1
344	17,5
345	16,7
346	15,4
347	13,6
348	11,2
349	8,6
350	6,0
351	3,1
352	1,2
353	0,0
354	0,0
355	0,0
356	0,0
357	0,0
358	0,0
359	0,0
360	1,4
361	3,2
362	5,6
363	8,1
364	10,3
365	12,1
366	12,6
367	13,6
368	14,5
369	15,6
370	16,8
371	18,2
372	19,6

Status: Point in time view as at 01/06/2017.

Changes to legislation: There are outstanding changes not yet made to Commission Regulation (EU) 2017/1151. Any changes that have already been made to the legislation appear in the content and are referenced with annotations. (See end of Document for details)

373	20,9
374	22,3
375	23,8
376	25,4
377	27,0
378	28,6
379	30,2
380	31,2
381	31,2
382	30,7
383	29,5
384	28,6
385	27,7
386	26,9
387	26,1
388	25,4
389	24,6
390	23,6
391	22,6
392	21,7
393	20,7
394	19,8
395	18,8
396	17,7
397	16,6
398	15,6
399	14,8
400	14,3
401	13,8
402	13,4
403	13,1
404	12,8
405	12,3
406	11,6

Status: Point in time view as at 01/06/2017.

Changes to legislation: There are outstanding changes not yet made to Commission Regulation (EU) 2017/1151. Any changes that have already been made to the legislation appear in the content and are referenced with annotations. (See end of Document for details)

407	10,5
408	9,0
409	7,2
410	5,2
411	2,9
412	1,2
413	0,0
414	0,0
415	0,0
416	0,0
417	0,0
418	0,0
419	0,0
420	0,0
421	0,0
422	0,0
423	0,0
424	0,0
425	0,0
426	0,0
427	0,0
428	0,0
429	0,0
430	0,0
431	0,0
432	0,0
433	0,0
434	0,0
435	0,0
436	0,0
437	0,0
438	0,0
439	0,0
440	0,0

Status: Point in time view as at 01/06/2017.

Changes to legislation: There are outstanding changes not yet made to Commission Regulation (EU) 2017/1151. Any changes that have already been made to the legislation appear in the content and are referenced with annotations. (See end of Document for details)

441	0,0
442	0,0
443	0,0
444	0,0
445	0,0
446	0,0
447	0,0
448	0,0
449	0,0
450	0,0
451	0,0
452	0,0
453	0,0
454	0,0
455	0,0
456	0,0
457	0,0
458	0,0
459	0,0
460	0,0
461	0,0
462	0,0
463	0,0
464	0,0
465	0,0
466	0,0
467	0,0
468	0,0
469	0,0
470	0,0
471	0,0
472	0,0
473	0,0
474	0,0

Status: Point in time view as at 01/06/2017.

Changes to legislation: There are outstanding changes not yet made to Commission Regulation (EU) 2017/1151. Any changes that have already been made to the legislation appear in the content and are referenced with annotations. (See end of Document for details)

475	0,0
476	0,0
477	0,0
478	0,0
479	0,0
480	0,0
481	1,4
482	2,5
483	5,2
484	7,9
485	10,3
486	12,7
487	15,0
488	17,4
489	19,7
490	21,9
491	24,1
492	26,2
493	28,1
494	29,7
495	31,3
496	33,0
497	34,7
498	36,3
499	38,1
500	39,4
501	40,4
502	41,2
503	42,1
504	43,2
505	44,3
506	45,7
507	45,4
508	44,5

Status: Point in time view as at 01/06/2017.

Changes to legislation: There are outstanding changes not yet made to Commission Regulation (EU) 2017/1151. Any changes that have already been made to the legislation appear in the content and are referenced with annotations. (See end of Document for details)

509	42,5
510	39,5
511	36,5
512	33,5
513	30,4
514	27,0
515	23,6
516	21,0
517	19,5
518	17,6
519	16,1
520	14,5
521	13,5
522	13,7
523	16,0
524	18,1
525	20,8
526	21,5
527	22,5
528	23,4
529	24,5
530	25,6
531	26,0
532	26,5
533	26,9
534	27,3
535	27,9
536	30,3
537	33,2
538	35,4
539	38,0
540	40,1
541	42,7
542	44,5

Status: Point in time view as at 01/06/2017.

Changes to legislation: There are outstanding changes not yet made to Commission Regulation (EU) 2017/1151. Any changes that have already been made to the legislation appear in the content and are referenced with annotations. (See end of Document for details)

543	46,3
544	47,6
545	48,8
546	49,7
547	50,6
548	51,4
549	51,4
550	50,2
551	47,1
552	44,5
553	41,5
554	38,5
555	35,5
556	32,5
557	29,5
558	26,5
559	23,5
560	20,4
561	17,5
562	14,5
563	11,5
564	8,5
565	5,6
566	2,6
567	0,0
568	0,0
569	0,0
570	0,0
571	0,0
572	0,0
573	0,0
574	0,0
575	0,0
576	0,0

Status: Point in time view as at 01/06/2017.

Changes to legislation: There are outstanding changes not yet made to Commission Regulation (EU) 2017/1151. Any changes that have already been made to the legislation appear in the content and are referenced with annotations. (See end of Document for details)

577	0,0
578	0,0
579	0,0
580	0,0
581	0,0
582	0,0
583	0,0
584	0,0
585	0,0
586	0,0
587	0,0
588	0,0
589	0,0

TABLE A1/4

WLTC, Class 2 vehicles, phase Medium₂

Time in s	Speed in km/h
590	0,0
591	0,0
592	0,0
593	0,0
594	0,0
595	0,0
596	0,0
597	0,0
598	0,0
599	0,0
600	0,0
601	1,6
602	3,6
603	6,3
604	9,0
605	11,8
606	14,2
607	16,6

Status: Point in time view as at 01/06/2017.

Changes to legislation: There are outstanding changes not yet made to Commission Regulation (EU) 2017/1151. Any changes that have already been made to the legislation appear in the content and are referenced with annotations. (See end of Document for details)

608	18,5
609	20,8
610	23,4
611	26,9
612	30,3
613	32,8
614	34,1
615	34,2
616	33,6
617	32,1
618	30,0
619	27,5
620	25,1
621	22,8
622	20,5
623	17,9
624	15,1
625	13,4
626	12,8
627	13,7
628	16,0
629	18,1
630	20,8
631	23,7
632	26,5
633	29,3
634	32,0
635	34,5
636	36,8
637	38,6
638	39,8
639	40,6
640	41,1
641	41,9

Status: Point in time view as at 01/06/2017.

Changes to legislation: There are outstanding changes not yet made to Commission Regulation (EU) 2017/1151. Any changes that have already been made to the legislation appear in the content and are referenced with annotations. (See end of Document for details)

642	42,8
643	44,3
644	45,7
645	47,4
646	48,9
647	50,6
648	52,0
649	53,7
650	55,0
651	56,8
652	58,0
653	59,8
654	61,1
655	62,4
656	63,0
657	63,5
658	63,0
659	62,0
660	60,4
661	58,6
662	56,7
663	55,0
664	53,7
665	52,7
666	51,9
667	51,4
668	51,0
669	50,7
670	50,6
671	50,8
672	51,2
673	51,7
674	52,3
675	53,1

Status: Point in time view as at 01/06/2017.

Changes to legislation: There are outstanding changes not yet made to Commission Regulation (EU) 2017/1151. Any changes that have already been made to the legislation appear in the content and are referenced with annotations. (See end of Document for details)

676	53,8
677	54,5
678	55,1
679	55,9
680	56,5
681	57,1
682	57,8
683	58,5
684	59,3
685	60,2
686	61,3
687	62,4
688	63,4
689	64,4
690	65,4
691	66,3
692	67,2
693	68,0
694	68,8
695	69,5
696	70,1
697	70,6
698	71,0
699	71,6
700	72,2
701	72,8
702	73,5
703	74,1
704	74,3
705	74,3
706	73,7
707	71,9
708	70,5
709	68,9

Status: Point in time view as at 01/06/2017.

Changes to legislation: There are outstanding changes not yet made to Commission Regulation (EU) 2017/1151. Any changes that have already been made to the legislation appear in the content and are referenced with annotations. (See end of Document for details)

710	67,4
711	66,0
712	64,7
713	63,7
714	62,9
715	62,2
716	61,7
717	61,2
718	60,7
719	60,3
720	59,9
721	59,6
722	59,3
723	59,0
724	58,6
725	58,0
726	57,5
727	56,9
728	56,3
729	55,9
730	55,6
731	55,3
732	55,1
733	54,8
734	54,6
735	54,5
736	54,3
737	53,9
738	53,4
739	52,6
740	51,5
741	50,2
742	48,7
743	47,0

Status: Point in time view as at 01/06/2017.

Changes to legislation: There are outstanding changes not yet made to Commission Regulation (EU) 2017/1151. Any changes that have already been made to the legislation appear in the content and are referenced with annotations. (See end of Document for details)

744	45,1
745	43,0
746	40,6
747	38,1
748	35,4
749	32,7
750	30,0
751	27,5
752	25,3
753	23,4
754	22,0
755	20,8
756	19,8
757	18,9
758	18,0
759	17,0
760	16,1
761	15,5
762	14,4
763	14,9
764	15,9
765	17,1
766	18,3
767	19,4
768	20,4
769	21,2
770	21,9
771	22,7
772	23,4
773	24,2
774	24,3
775	24,2
776	24,1
777	23,8

Status: Point in time view as at 01/06/2017.

Changes to legislation: There are outstanding changes not yet made to Commission Regulation (EU) 2017/1151. Any changes that have already been made to the legislation appear in the content and are referenced with annotations. (See end of Document for details)

778	23,0
779	22,6
780	21,7
781	21,3
782	20,3
783	19,1
784	18,1
785	16,9
786	16,0
787	14,8
788	14,5
789	13,7
790	13,5
791	12,9
792	12,7
793	12,5
794	12,5
795	12,6
796	13,0
797	13,6
798	14,6
799	15,7
800	17,1
801	18,7
802	20,2
803	21,9
804	23,6
805	25,4
806	27,1
807	28,9
808	30,4
809	32,0
810	33,4
811	35,0

Status: Point in time view as at 01/06/2017.

Changes to legislation: There are outstanding changes not yet made to Commission Regulation (EU) 2017/1151. Any changes that have already been made to the legislation appear in the content and are referenced with annotations. (See end of Document for details)

812	36,4
813	38,1
814	39,7
815	41,6
816	43,3
817	45,1
818	46,9
819	48,7
820	50,5
821	52,4
822	54,1
823	55,7
824	56,8
825	57,9
826	59,0
827	59,9
828	60,7
829	61,4
830	62,0
831	62,5
832	62,9
833	63,2
834	63,4
835	63,7
836	64,0
837	64,4
838	64,9
839	65,5
840	66,2
841	67,0
842	67,8
843	68,6
844	69,4
845	70,1

Status: Point in time view as at 01/06/2017.

Changes to legislation: There are outstanding changes not yet made to Commission Regulation (EU) 2017/1151. Any changes that have already been made to the legislation appear in the content and are referenced with annotations. (See end of Document for details)

846	70,9
847	71,7
848	72,5
849	73,2
850	73,8
851	74,4
852	74,7
853	74,7
854	74,6
855	74,2
856	73,5
857	72,6
858	71,8
859	71,0
860	70,1
861	69,4
862	68,9
863	68,4
864	67,9
865	67,1
866	65,8
867	63,9
868	61,4
869	58,4
870	55,4
871	52,4
872	50,0
873	48,3
874	47,3
875	46,8
876	46,9
877	47,1
878	47,5
879	47,8

Status: Point in time view as at 01/06/2017.

Changes to legislation: There are outstanding changes not yet made to Commission Regulation (EU) 2017/1151. Any changes that have already been made to the legislation appear in the content and are referenced with annotations. (See end of Document for details)

880	48,3
881	48,8
882	49,5
883	50,2
884	50,8
885	51,4
886	51,8
887	51,9
888	51,7
889	51,2
890	50,4
891	49,2
892	47,7
893	46,3
894	45,1
895	44,2
896	43,7
897	43,4
898	43,1
899	42,5
900	41,8
901	41,1
902	40,3
903	39,7
904	39,3
905	39,2
906	39,3
907	39,6
908	40,0
909	40,7
910	41,4
911	42,2
912	43,1
913	44,1

Status: Point in time view as at 01/06/2017.

Changes to legislation: There are outstanding changes not yet made to Commission Regulation (EU) 2017/1151. Any changes that have already been made to the legislation appear in the content and are referenced with annotations. (See end of Document for details)

914	44,9
915	45,6
916	46,4
917	47,0
918	47,8
919	48,3
920	48,9
921	49,4
922	49,8
923	49,6
924	49,3
925	49,0
926	48,5
927	48,0
928	47,5
929	47,0
930	46,9
931	46,8
932	46,8
933	46,8
934	46,9
935	46,9
936	46,9
937	46,9
938	46,9
939	46,8
940	46,6
941	46,4
942	46,0
943	45,5
944	45,0
945	44,5
946	44,2
947	43,9

Status: Point in time view as at 01/06/2017.

Changes to legislation: There are outstanding changes not yet made to Commission Regulation (EU) 2017/1151. Any changes that have already been made to the legislation appear in the content and are referenced with annotations. (See end of Document for details)

948	43,7
949	43,6
950	43,6
951	43,5
952	43,5
953	43,4
954	43,3
955	43,1
956	42,9
957	42,7
958	42,5
959	42,4
960	42,2
961	42,1
962	42,0
963	41,8
964	41,7
965	41,5
966	41,3
967	41,1
968	40,8
969	40,3
970	39,6
971	38,5
972	37,0
973	35,1
974	33,0
975	30,6
976	27,9
977	25,1
978	22,0
979	18,8
980	15,5
981	12,3

Status: Point in time view as at 01/06/2017.

Changes to legislation: There are outstanding changes not yet made to Commission Regulation (EU) 2017/1151. Any changes that have already been made to the legislation appear in the content and are referenced with annotations. (See end of Document for details)

982	8,8
983	6,0
984	3,6
985	1,6
986	0,0
987	0,0
988	0,0
989	0,0
990	0,0
991	0,0
992	0,0
993	0,0
994	0,0
995	0,0
996	0,0
997	0,0
998	0,0
999	0,0
1000	0,0
1001	0,0
1002	0,0
1003	0,0
1004	0,0
1005	0,0
1006	0,0
1007	0,0
1008	0,0
1009	0,0
1010	0,0
1011	0,0
1012	0,0
1013	0,0
1014	0,0
1015	0,0

Status: Point in time view as at 01/06/2017.

Changes to legislation: There are outstanding changes not yet made to Commission Regulation (EU) 2017/1151. Any changes that have already been made to the legislation appear in the content and are referenced with annotations. (See end of Document for details)

1016	0,0
1017	0,0
1018	0,0
1019	0,0
1020	0,0
1021	0,0
1022	0,0

TABLE A1/5

WLTC, Class 2 vehicles, phase High₂

Time in s	Speed in km/h
1023	0,0
1024	0,0
1025	0,0
1026	0,0
1027	1,1
1028	3,0
1029	5,7
1030	8,4
1031	11,1
1032	14,0
1033	17,0
1034	20,1
1035	22,7
1036	23,6
1037	24,5
1038	24,8
1039	25,1
1040	25,3
1041	25,5
1042	25,7
1043	25,8
1044	25,9
1045	26,0
1046	26,1

Status: Point in time view as at 01/06/2017.

Changes to legislation: There are outstanding changes not yet made to Commission Regulation (EU) 2017/1151. Any changes that have already been made to the legislation appear in the content and are referenced with annotations. (See end of Document for details)

1047	26,3
1048	26,5
1049	26,8
1050	27,1
1051	27,5
1052	28,0
1053	28,6
1054	29,3
1055	30,4
1056	31,8
1057	33,7
1058	35,8
1059	37,8
1060	39,5
1061	40,8
1062	41,8
1063	42,4
1064	43,0
1065	43,4
1066	44,0
1067	44,4
1068	45,0
1069	45,4
1070	46,0
1071	46,4
1072	47,0
1073	47,4
1074	48,0
1075	48,4
1076	49,0
1077	49,4
1078	50,0
1079	50,4
1080	50,8

Status: Point in time view as at 01/06/2017.

Changes to legislation: There are outstanding changes not yet made to Commission Regulation (EU) 2017/1151. Any changes that have already been made to the legislation appear in the content and are referenced with annotations. (See end of Document for details)

1081	51,1
1082	51,3
1083	51,3
1084	51,3
1085	51,3
1086	51,3
1087	51,3
1088	51,3
1089	51,4
1090	51,6
1091	51,8
1092	52,1
1093	52,3
1094	52,6
1095	52,8
1096	52,9
1097	53,0
1098	53,0
1099	53,0
1100	53,1
1101	53,2
1102	53,3
1103	53,4
1104	53,5
1105	53,7
1106	55,0
1107	56,8
1108	58,8
1109	60,9
1110	63,0
1111	65,0
1112	66,9
1113	68,6
1114	70,1

Status: Point in time view as at 01/06/2017.

Changes to legislation: There are outstanding changes not yet made to Commission Regulation (EU) 2017/1151. Any changes that have already been made to the legislation appear in the content and are referenced with annotations. (See end of Document for details)

1115	71,5
1116	72,8
1117	73,9
1118	74,9
1119	75,7
1120	76,4
1121	77,1
1122	77,6
1123	78,0
1124	78,2
1125	78,4
1126	78,5
1127	78,5
1128	78,6
1129	78,7
1130	78,9
1131	79,1
1132	79,4
1133	79,8
1134	80,1
1135	80,5
1136	80,8
1137	81,0
1138	81,2
1139	81,3
1140	81,2
1141	81,0
1142	80,6
1143	80,0
1144	79,1
1145	78,0
1146	76,8
1147	75,5
1148	74,1

Status: Point in time view as at 01/06/2017.

Changes to legislation: There are outstanding changes not yet made to Commission Regulation (EU) 2017/1151. Any changes that have already been made to the legislation appear in the content and are referenced with annotations. (See end of Document for details)

1149	72,9
1150	71,9
1151	71,2
1152	70,9
1153	71,0
1154	71,5
1155	72,3
1156	73,2
1157	74,1
1158	74,9
1159	75,4
1160	75,5
1161	75,2
1162	74,5
1163	73,3
1164	71,7
1165	69,9
1166	67,9
1167	65,7
1168	63,5
1169	61,2
1170	59,0
1171	56,8
1172	54,7
1173	52,7
1174	50,9
1175	49,4
1176	48,1
1177	47,1
1178	46,5
1179	46,3
1180	46,5
1181	47,2
1182	48,3

Status: Point in time view as at 01/06/2017.

Changes to legislation: There are outstanding changes not yet made to Commission Regulation (EU) 2017/1151. Any changes that have already been made to the legislation appear in the content and are referenced with annotations. (See end of Document for details)

1183	49,7
1184	51,3
1185	53,0
1186	54,9
1187	56,7
1188	58,6
1189	60,2
1190	61,6
1191	62,2
1192	62,5
1193	62,8
1194	62,9
1195	63,0
1196	63,0
1197	63,1
1198	63,2
1199	63,3
1200	63,5
1201	63,7
1202	63,9
1203	64,1
1204	64,3
1205	66,1
1206	67,9
1207	69,7
1208	71,4
1209	73,1
1210	74,7
1211	76,2
1212	77,5
1213	78,6
1214	79,7
1215	80,6
1216	81,5

Status: Point in time view as at 01/06/2017.

Changes to legislation: There are outstanding changes not yet made to Commission Regulation (EU) 2017/1151. Any changes that have already been made to the legislation appear in the content and are referenced with annotations. (See end of Document for details)

1217	82,2
1218	83,0
1219	83,7
1220	84,4
1221	84,9
1222	85,1
1223	85,2
1224	84,9
1225	84,4
1226	83,6
1227	82,7
1228	81,5
1229	80,1
1230	78,7
1231	77,4
1232	76,2
1233	75,4
1234	74,8
1235	74,3
1236	73,8
1237	73,2
1238	72,4
1239	71,6
1240	70,8
1241	69,9
1242	67,9
1243	65,7
1244	63,5
1245	61,2
1246	59,0
1247	56,8
1248	54,7
1249	52,7
1250	50,9

Status: Point in time view as at 01/06/2017.

Changes to legislation: There are outstanding changes not yet made to Commission Regulation (EU) 2017/1151. Any changes that have already been made to the legislation appear in the content and are referenced with annotations. (See end of Document for details)

1251	49,4
1252	48,1
1253	47,1
1254	46,5
1255	46,3
1256	45,1
1257	43,0
1258	40,6
1259	38,1
1260	35,4
1261	32,7
1262	30,0
1263	29,9
1264	30,0
1265	30,2
1266	30,4
1267	30,6
1268	31,6
1269	33,0
1270	33,9
1271	34,8
1272	35,7
1273	36,6
1274	37,5
1275	38,4
1276	39,3
1277	40,2
1278	40,8
1279	41,7
1280	42,4
1281	43,1
1282	43,6
1283	44,2
1284	44,8

Status: Point in time view as at 01/06/2017.

Changes to legislation: There are outstanding changes not yet made to Commission Regulation (EU) 2017/1151. Any changes that have already been made to the legislation appear in the content and are referenced with annotations. (See end of Document for details)

1285	45,5
1286	46,3
1287	47,2
1288	48,1
1289	49,1
1290	50,0
1291	51,0
1292	51,9
1293	52,7
1294	53,7
1295	55,0
1296	56,8
1297	58,8
1298	60,9
1299	63,0
1300	65,0
1301	66,9
1302	68,6
1303	70,1
1304	71,0
1305	71,8
1306	72,8
1307	72,9
1308	73,0
1309	72,3
1310	71,9
1311	71,3
1312	70,9
1313	70,5
1314	70,0
1315	69,6
1316	69,2
1317	68,8
1318	68,4

Status: Point in time view as at 01/06/2017.

Changes to legislation: There are outstanding changes not yet made to Commission Regulation (EU) 2017/1151. Any changes that have already been made to the legislation appear in the content and are referenced with annotations. (See end of Document for details)

1319	67,9
1320	67,5
1321	67,2
1322	66,8
1323	65,6
1324	63,3
1325	60,2
1326	56,2
1327	52,2
1328	48,4
1329	45,0
1330	41,6
1331	38,6
1332	36,4
1333	34,8
1334	34,2
1335	34,7
1336	36,3
1337	38,5
1338	41,0
1339	43,7
1340	46,5
1341	49,1
1342	51,6
1343	53,9
1344	56,0
1345	57,9
1346	59,7
1347	61,2
1348	62,5
1349	63,5
1350	64,3
1351	65,3
1352	66,3

Status: Point in time view as at 01/06/2017.

Changes to legislation: There are outstanding changes not yet made to Commission Regulation (EU) 2017/1151. Any changes that have already been made to the legislation appear in the content and are referenced with annotations. (See end of Document for details)

1353	67,3
1354	68,3
1355	69,3
1356	70,3
1357	70,8
1358	70,8
1359	70,8
1360	70,9
1361	70,9
1362	70,9
1363	70,9
1364	71,0
1365	71,0
1366	71,1
1367	71,2
1368	71,3
1369	71,4
1370	71,5
1371	71,7
1372	71,8
1373	71,9
1374	71,9
1375	71,9
1376	71,9
1377	71,9
1378	71,9
1379	71,9
1380	72,0
1381	72,1
1382	72,4
1383	72,7
1384	73,1
1385	73,4
1386	73,8

Status: Point in time view as at 01/06/2017.

Changes to legislation: There are outstanding changes not yet made to Commission Regulation (EU) 2017/1151. Any changes that have already been made to the legislation appear in the content and are referenced with annotations. (See end of Document for details)

1387	74,0
1388	74,1
1389	74,0
1390	73,0
1391	72,0
1392	71,0
1393	70,0
1394	69,0
1395	68,0
1396	67,7
1397	66,7
1398	66,6
1399	66,7
1400	66,8
1401	66,9
1402	66,9
1403	66,9
1404	66,9
1405	66,9
1406	66,9
1407	66,9
1408	67,0
1409	67,1
1410	67,3
1411	67,5
1412	67,8
1413	68,2
1414	68,6
1415	69,0
1416	69,3
1417	69,3
1418	69,2
1419	68,8
1420	68,2

Status: Point in time view as at 01/06/2017.

Changes to legislation: There are outstanding changes not yet made to Commission Regulation (EU) 2017/1151. Any changes that have already been made to the legislation appear in the content and are referenced with annotations. (See end of Document for details)

1421	67,6
1422	67,4
1423	67,2
1424	66,9
1425	66,3
1426	65,4
1427	64,0
1428	62,4
1429	60,6
1430	58,6
1431	56,7
1432	54,8
1433	53,0
1434	51,3
1435	49,6
1436	47,8
1437	45,5
1438	42,8
1439	39,8
1440	36,5
1441	33,0
1442	29,5
1443	25,8
1444	22,1
1445	18,6
1446	15,3
1447	12,4
1448	9,6
1449	6,6
1450	3,8
1451	1,6
1452	0,0
1453	0,0
1454	0,0

Status: Point in time view as at 01/06/2017.

Changes to legislation: There are outstanding changes not yet made to Commission Regulation (EU) 2017/1151. Any changes that have already been made to the legislation appear in the content and are referenced with annotations. (See end of Document for details)

1455	0,0
1456	0,0
1457	0,0
1458	0,0
1459	0,0
1460	0,0
1461	0,0
1462	0,0
1463	0,0
1464	0,0
1465	0,0
1466	0,0
1467	0,0
1468	0,0
1469	0,0
1470	0,0
1471	0,0
1472	0,0
1473	0,0
1474	0,0
1475	0,0
1476	0,0
1477	0,0

TABLE A1/6

WLTC, Class 2 vehicles, phase Extra High₂

Time in s	Speed in km/h
1478	0,0
1479	1,1
1480	2,3
1481	4,6
1482	6,5
1483	8,9
1484	10,9
1485	13,5

Status: Point in time view as at 01/06/2017.

Changes to legislation: There are outstanding changes not yet made to Commission Regulation (EU) 2017/1151. Any changes that have already been made to the legislation appear in the content and are referenced with annotations. (See end of Document for details)

1486	15,2
1487	17,6
1488	19,3
1489	21,4
1490	23,0
1491	25,0
1492	26,5
1493	28,4
1494	29,8
1495	31,7
1496	33,7
1497	35,8
1498	38,1
1499	40,5
1500	42,2
1501	43,5
1502	44,5
1503	45,2
1504	45,8
1505	46,6
1506	47,4
1507	48,5
1508	49,7
1509	51,3
1510	52,9
1511	54,3
1512	55,6
1513	56,8
1514	57,9
1515	58,9
1516	59,7
1517	60,3
1518	60,7
1519	60,9

Status: Point in time view as at 01/06/2017.

Changes to legislation: There are outstanding changes not yet made to Commission Regulation (EU) 2017/1151. Any changes that have already been made to the legislation appear in the content and are referenced with annotations. (See end of Document for details)

1520	61,0
1521	61,1
1522	61,4
1523	61,8
1524	62,5
1525	63,4
1526	64,5
1527	65,7
1528	66,9
1529	68,1
1530	69,1
1531	70,0
1532	70,9
1533	71,8
1534	72,6
1535	73,4
1536	74,0
1537	74,7
1538	75,2
1539	75,7
1540	76,4
1541	77,2
1542	78,2
1543	78,9
1544	79,9
1545	81,1
1546	82,4
1547	83,7
1548	85,4
1549	87,0
1550	88,3
1551	89,5
1552	90,5
1553	91,3

Status: Point in time view as at 01/06/2017.

Changes to legislation: There are outstanding changes not yet made to Commission Regulation (EU) 2017/1151. Any changes that have already been made to the legislation appear in the content and are referenced with annotations. (See end of Document for details)

1554	92,2
1555	93,0
1556	93,8
1557	94,6
1558	95,3
1559	95,9
1560	96,6
1561	97,4
1562	98,1
1563	98,7
1564	99,5
1565	100,3
1566	101,1
1567	101,9
1568	102,8
1569	103,8
1570	105,0
1571	106,1
1572	107,4
1573	108,7
1574	109,9
1575	111,2
1576	112,3
1577	113,4
1578	114,4
1579	115,3
1580	116,1
1581	116,8
1582	117,4
1583	117,7
1584	118,2
1585	118,1
1586	117,7
1587	117,0

Status: Point in time view as at 01/06/2017.

Changes to legislation: There are outstanding changes not yet made to Commission Regulation (EU) 2017/1151. Any changes that have already been made to the legislation appear in the content and are referenced with annotations. (See end of Document for details)

1588	116,1
1589	115,2
1590	114,4
1591	113,6
1592	113,0
1593	112,6
1594	112,2
1595	111,9
1596	111,6
1597	111,2
1598	110,7
1599	110,1
1600	109,3
1601	108,4
1602	107,4
1603	106,7
1604	106,3
1605	106,2
1606	106,4
1607	107,0
1608	107,5
1609	107,9
1610	108,4
1611	108,9
1612	109,5
1613	110,2
1614	110,9
1615	111,6
1616	112,2
1617	112,8
1618	113,3
1619	113,7
1620	114,1
1621	114,4

Status: Point in time view as at 01/06/2017.

Changes to legislation: There are outstanding changes not yet made to Commission Regulation (EU) 2017/1151. Any changes that have already been made to the legislation appear in the content and are referenced with annotations. (See end of Document for details)

1622	114,6
1623	114,7
1624	114,7
1625	114,7
1626	114,6
1627	114,5
1628	114,5
1629	114,5
1630	114,7
1631	115,0
1632	115,6
1633	116,4
1634	117,3
1635	118,2
1636	118,8
1637	119,3
1638	119,6
1639	119,7
1640	119,5
1641	119,3
1642	119,2
1643	119,0
1644	118,8
1645	118,8
1646	118,8
1647	118,8
1648	118,8
1649	118,9
1650	119,0
1651	119,0
1652	119,1
1653	119,2
1654	119,4
1655	119,6

Status: Point in time view as at 01/06/2017.

Changes to legislation: There are outstanding changes not yet made to Commission Regulation (EU) 2017/1151. Any changes that have already been made to the legislation appear in the content and are referenced with annotations. (See end of Document for details)

1656	119,9
1657	120,1
1658	120,3
1659	120,4
1660	120,5
1661	120,5
1662	120,5
1663	120,5
1664	120,4
1665	120,3
1666	120,1
1667	119,9
1668	119,6
1669	119,5
1670	119,4
1671	119,3
1672	119,3
1673	119,4
1674	119,5
1675	119,5
1676	119,6
1677	119,6
1678	119,6
1679	119,4
1680	119,3
1681	119,0
1682	118,8
1683	118,7
1684	118,8
1685	119,0
1686	119,2
1687	119,6
1688	120,0
1689	120,3

Status: Point in time view as at 01/06/2017.

Changes to legislation: There are outstanding changes not yet made to Commission Regulation (EU) 2017/1151. Any changes that have already been made to the legislation appear in the content and are referenced with annotations. (See end of Document for details)

1690	120,5
1691	120,7
1692	120,9
1693	121,0
1694	121,1
1695	121,2
1696	121,3
1697	121,4
1698	121,5
1699	121,5
1700	121,5
1701	121,4
1702	121,3
1703	121,1
1704	120,9
1705	120,6
1706	120,4
1707	120,2
1708	120,1
1709	119,9
1710	119,8
1711	119,8
1712	119,9
1713	120,0
1714	120,2
1715	120,4
1716	120,8
1717	121,1
1718	121,6
1719	121,8
1720	122,1
1721	122,4
1722	122,7
1723	122,8

Status: Point in time view as at 01/06/2017.

Changes to legislation: There are outstanding changes not yet made to Commission Regulation (EU) 2017/1151. Any changes that have already been made to the legislation appear in the content and are referenced with annotations. (See end of Document for details)

1724	123,1
1725	123,1
1726	122,8
1727	122,3
1728	121,3
1729	119,9
1730	118,1
1731	115,9
1732	113,5
1733	111,1
1734	108,6
1735	106,2
1736	104,0
1737	101,1
1738	98,3
1739	95,7
1740	93,5
1741	91,5
1742	90,7
1743	90,4
1744	90,2
1745	90,2
1746	90,1
1747	90,0
1748	89,8
1749	89,6
1750	89,4
1751	89,2
1752	88,9
1753	88,5
1754	88,1
1755	87,6
1756	87,1
1757	86,6

Status: Point in time view as at 01/06/2017.

Changes to legislation: There are outstanding changes not yet made to Commission Regulation (EU) 2017/1151. Any changes that have already been made to the legislation appear in the content and are referenced with annotations. (See end of Document for details)

1758	86,1
1759	85,5
1760	85,0
1761	84,4
1762	83,8
1763	83,2
1764	82,6
1765	81,9
1766	81,1
1767	80,0
1768	78,7
1769	76,9
1770	74,6
1771	72,0
1772	69,0
1773	65,6
1774	62,1
1775	58,5
1776	54,7
1777	50,9
1778	47,3
1779	43,8
1780	40,4
1781	37,4
1782	34,3
1783	31,3
1784	28,3
1785	25,2
1786	22,0
1787	18,9
1788	16,1
1789	13,4
1790	11,1
1791	8,9

Status: Point in time view as at 01/06/2017.

Changes to legislation: There are outstanding changes not yet made to Commission Regulation (EU) 2017/1151. Any changes that have already been made to the legislation appear in the content and are referenced with annotations. (See end of Document for details)

1792	6,9
1793	4,9
1794	2,8
1795	0,0
1796	0,0
1797	0,0
1798	0,0
1799	0,0
1800	0,0

6. WLTC for Class 3 vehicles

Figure A1/7

WLTC, Class 3 vehicles, phase Low₃

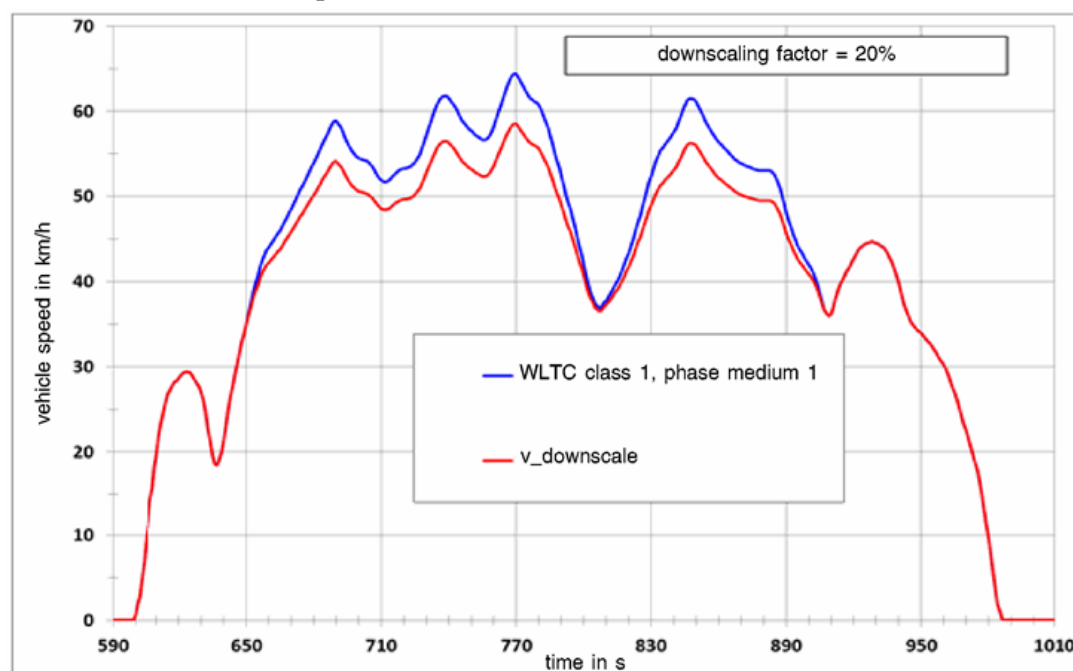

Figure A1/8

Status: Point in time view as at 01/06/2017.

Changes to legislation: There are outstanding changes not yet made to Commission Regulation (EU) 2017/1151. Any changes that have already been made to the legislation appear in the content and are referenced with annotations. (See end of Document for details)

WLTC, Class 3 vehicles, phase Medium_{3,1}

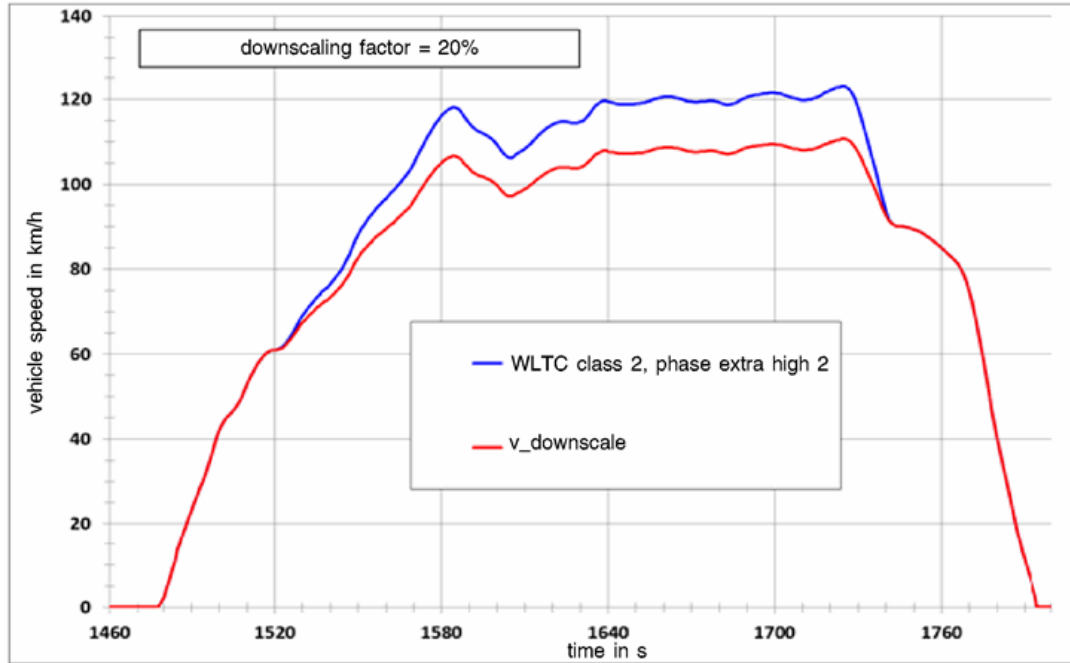

Figure A1/9

WLTC, Class 3 vehicles, phase Medium_{3,2}

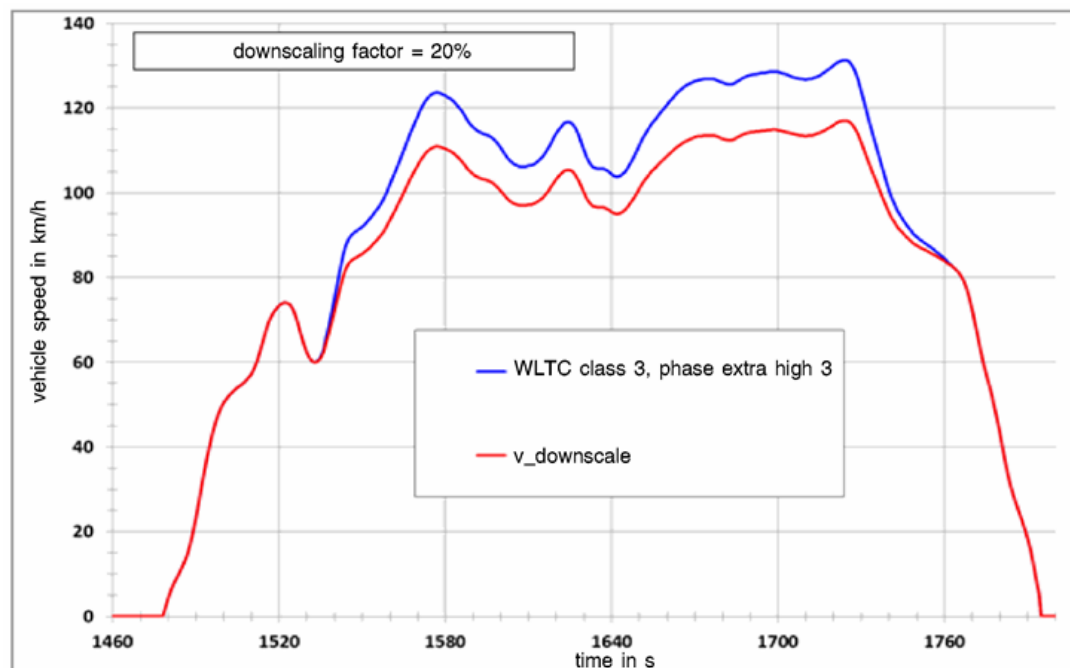

Figure A1/10

Status: Point in time view as at 01/06/2017.

Changes to legislation: There are outstanding changes not yet made to Commission Regulation (EU) 2017/1151. Any changes that have already been made to the legislation appear in the content and are referenced with annotations. (See end of Document for details)

WLTC, Class 3 vehicles, phase High_{3,1}

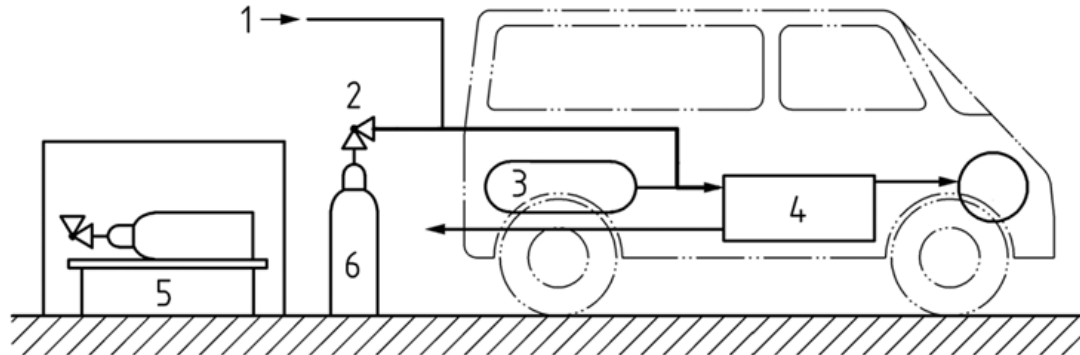

Figure A1/11

Status: Point in time view as at 01/06/2017.

Changes to legislation: There are outstanding changes not yet made to Commission Regulation (EU) 2017/1151. Any changes that have already been made to the legislation appear in the content and are referenced with annotations. (See end of Document for details)

WLTC, Class 3 vehicles, phase High_{3,2}

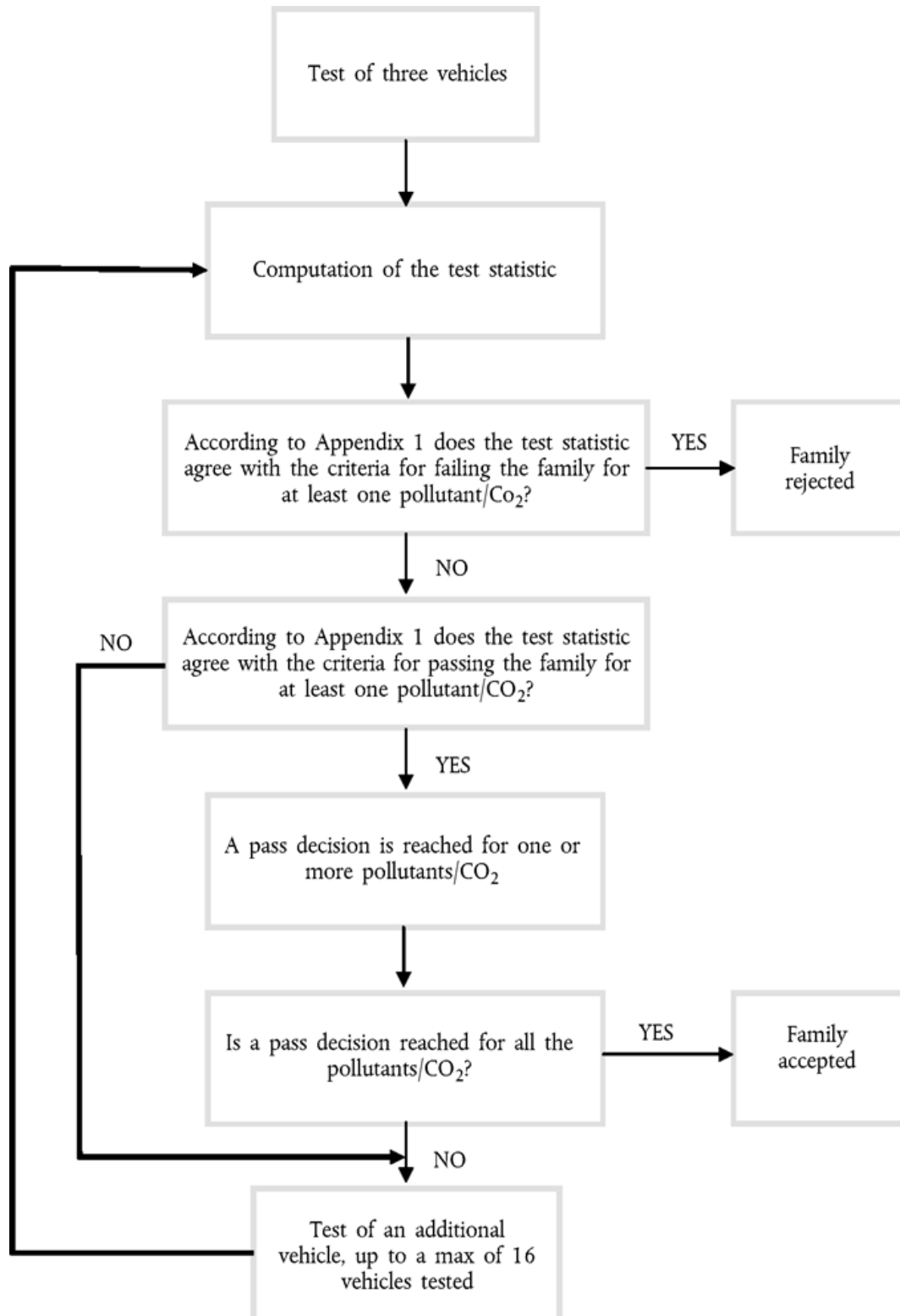

Figure A1/12

Status: Point in time view as at 01/06/2017.

Changes to legislation: There are outstanding changes not yet made to Commission Regulation (EU) 2017/1151. Any changes that have already been made to the legislation appear in the content and are referenced with annotations. (See end of Document for details)

WLTC, Class 3 vehicles, phase Extra High₃

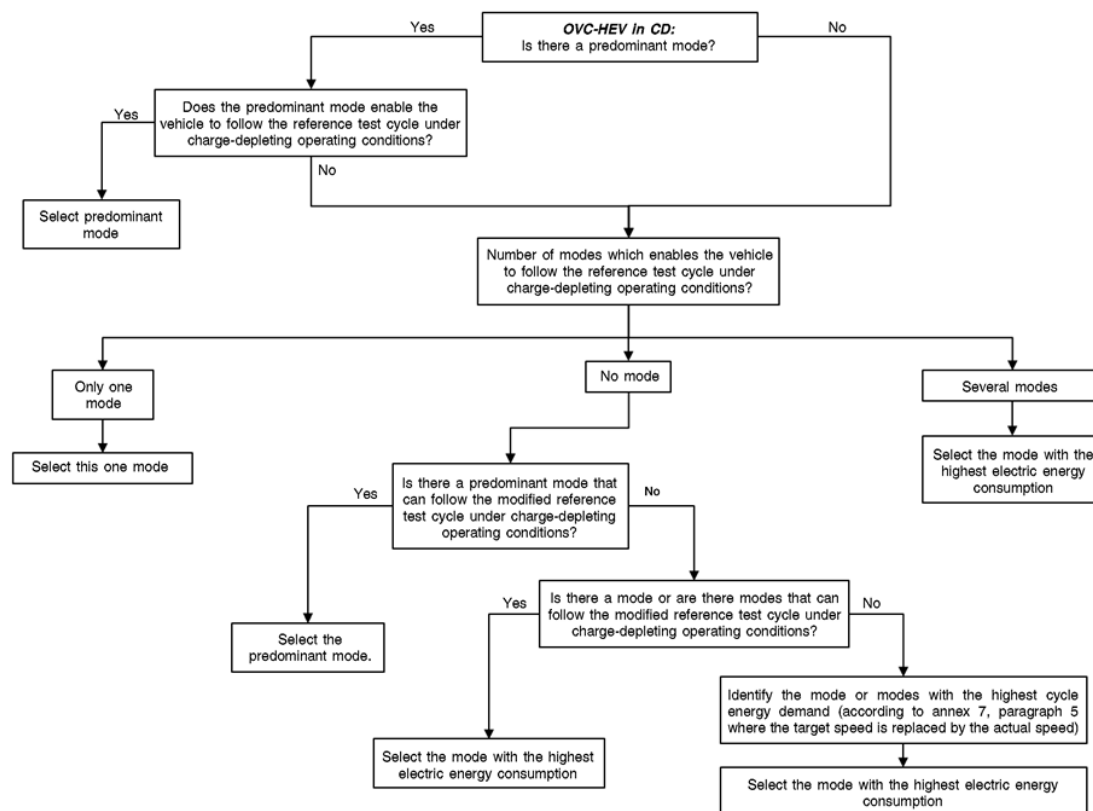

TABLE A1/7

WLTC, Class 3 vehicles, phase Low₃

Time in s	Speed in km/h
0	0,0
1	0,0
2	0,0
3	0,0
4	0,0
5	0,0
6	0,0
7	0,0
8	0,0
9	0,0
10	0,0
11	0,0
12	0,2

Status: Point in time view as at 01/06/2017.

Changes to legislation: There are outstanding changes not yet made to Commission Regulation (EU) 2017/1151. Any changes that have already been made to the legislation appear in the content and are referenced with annotations. (See end of Document for details)

13	1,7
14	5,4
15	9,9
16	13,1
17	16,9
18	21,7
19	26,0
20	27,5
21	28,1
22	28,3
23	28,8
24	29,1
25	30,8
26	31,9
27	34,1
28	36,6
29	39,1
30	41,3
31	42,5
32	43,3
33	43,9
34	44,4
35	44,5
36	44,2
37	42,7
38	39,9
39	37,0
40	34,6
41	32,3
42	29,0
43	25,1
44	22,2
45	20,9
46	20,4

Status: Point in time view as at 01/06/2017.

Changes to legislation: There are outstanding changes not yet made to Commission Regulation (EU) 2017/1151. Any changes that have already been made to the legislation appear in the content and are referenced with annotations. (See end of Document for details)

47	19,5
48	18,4
49	17,8
50	17,8
51	17,4
52	15,7
53	13,1
54	12,1
55	12,0
56	12,0
57	12,0
58	12,3
59	12,6
60	14,7
61	15,3
62	15,9
63	16,2
64	17,1
65	17,8
66	18,1
67	18,4
68	20,3
69	23,2
70	26,5
71	29,8
72	32,6
73	34,4
74	35,5
75	36,4
76	37,4
77	38,5
78	39,3
79	39,5
80	39,0

Status: Point in time view as at 01/06/2017.

Changes to legislation: There are outstanding changes not yet made to Commission Regulation (EU) 2017/1151. Any changes that have already been made to the legislation appear in the content and are referenced with annotations. (See end of Document for details)

81	38,5
82	37,3
83	37,0
84	36,7
85	35,9
86	35,3
87	34,6
88	34,2
89	31,9
90	27,3
91	22,0
92	17,0
93	14,2
94	12,0
95	9,1
96	5,8
97	3,6
98	2,2
99	0,0
100	0,0
101	0,0
102	0,0
103	0,0
104	0,0
105	0,0
106	0,0
107	0,0
108	0,0
109	0,0
110	0,0
111	0,0
112	0,0
113	0,0
114	0,0

Status: Point in time view as at 01/06/2017.

Changes to legislation: There are outstanding changes not yet made to Commission Regulation (EU) 2017/1151. Any changes that have already been made to the legislation appear in the content and are referenced with annotations. (See end of Document for details)

115	0,0
116	0,0
117	0,0
118	0,0
119	0,0
120	0,0
121	0,0
122	0,0
123	0,0
124	0,0
125	0,0
126	0,0
127	0,0
128	0,0
129	0,0
130	0,0
131	0,0
132	0,0
133	0,0
134	0,0
135	0,0
136	0,0
137	0,0
138	0,2
139	1,9
140	6,1
141	11,7
142	16,4
143	18,9
144	19,9
145	20,8
146	22,8
147	25,4
148	27,7

Status: Point in time view as at 01/06/2017.

Changes to legislation: There are outstanding changes not yet made to Commission Regulation (EU) 2017/1151. Any changes that have already been made to the legislation appear in the content and are referenced with annotations. (See end of Document for details)

149	29,2
150	29,8
151	29,4
152	27,2
153	22,6
154	17,3
155	13,3
156	12,0
157	12,6
158	14,1
159	17,2
160	20,1
161	23,4
162	25,5
163	27,6
164	29,5
165	31,1
166	32,1
167	33,2
168	35,2
169	37,2
170	38,0
171	37,4
172	35,1
173	31,0
174	27,1
175	25,3
176	25,1
177	25,9
178	27,8
179	29,2
180	29,6
181	29,5
182	29,2

Status: Point in time view as at 01/06/2017.

Changes to legislation: There are outstanding changes not yet made to Commission Regulation (EU) 2017/1151. Any changes that have already been made to the legislation appear in the content and are referenced with annotations. (See end of Document for details)

183	28,3
184	26,1
185	23,6
186	21,0
187	18,9
188	17,1
189	15,7
190	14,5
191	13,7
192	12,9
193	12,5
194	12,2
195	12,0
196	12,0
197	12,0
198	12,0
199	12,5
200	13,0
201	14,0
202	15,0
203	16,5
204	19,0
205	21,2
206	23,8
207	26,9
208	29,6
209	32,0
210	35,2
211	37,5
212	39,2
213	40,5
214	41,6
215	43,1
216	45,0

Status: Point in time view as at 01/06/2017.

Changes to legislation: There are outstanding changes not yet made to Commission Regulation (EU) 2017/1151. Any changes that have already been made to the legislation appear in the content and are referenced with annotations. (See end of Document for details)

217	47,1
218	49,0
219	50,6
220	51,8
221	52,7
222	53,1
223	53,5
224	53,8
225	54,2
226	54,8
227	55,3
228	55,8
229	56,2
230	56,5
231	56,5
232	56,2
233	54,9
234	52,9
235	51,0
236	49,8
237	49,2
238	48,4
239	46,9
240	44,3
241	41,5
242	39,5
243	37,0
244	34,6
245	32,3
246	29,0
247	25,1
248	22,2
249	20,9
250	20,4

Status: Point in time view as at 01/06/2017.

Changes to legislation: There are outstanding changes not yet made to Commission Regulation (EU) 2017/1151. Any changes that have already been made to the legislation appear in the content and are referenced with annotations. (See end of Document for details)

251	19,5
252	18,4
253	17,8
254	17,8
255	17,4
256	15,7
257	14,5
258	15,4
259	17,9
260	20,6
261	23,2
262	25,7
263	28,7
264	32,5
265	36,1
266	39,0
267	40,8
268	42,9
269	44,4
270	45,9
271	46,0
272	45,6
273	45,3
274	43,7
275	40,8
276	38,0
277	34,4
278	30,9
279	25,5
280	21,4
281	20,2
282	22,9
283	26,6
284	30,2

Status: Point in time view as at 01/06/2017.

Changes to legislation: There are outstanding changes not yet made to Commission Regulation (EU) 2017/1151. Any changes that have already been made to the legislation appear in the content and are referenced with annotations. (See end of Document for details)

285	34,1
286	37,4
287	40,7
288	44,0
289	47,3
290	49,2
291	49,8
292	49,2
293	48,1
294	47,3
295	46,8
296	46,7
297	46,8
298	47,1
299	47,3
300	47,3
301	47,1
302	46,6
303	45,8
304	44,8
305	43,3
306	41,8
307	40,8
308	40,3
309	40,1
310	39,7
311	39,2
312	38,5
313	37,4
314	36,0
315	34,4
316	33,0
317	31,7
318	30,0

Status: Point in time view as at 01/06/2017.

Changes to legislation: There are outstanding changes not yet made to Commission Regulation (EU) 2017/1151. Any changes that have already been made to the legislation appear in the content and are referenced with annotations. (See end of Document for details)

319	28,0
320	26,1
321	25,6
322	24,9
323	24,9
324	24,3
325	23,9
326	23,9
327	23,6
328	23,3
329	20,5
330	17,5
331	16,9
332	16,7
333	15,9
334	15,6
335	15,0
336	14,5
337	14,3
338	14,5
339	15,4
340	17,8
341	21,1
342	24,1
343	25,0
344	25,3
345	25,5
346	26,4
347	26,6
348	27,1
349	27,7
350	28,1
351	28,2
352	28,1

Status: Point in time view as at 01/06/2017.

Changes to legislation: There are outstanding changes not yet made to Commission Regulation (EU) 2017/1151. Any changes that have already been made to the legislation appear in the content and are referenced with annotations. (See end of Document for details)

353	28,0
354	27,9
355	27,9
356	28,1
357	28,2
358	28,0
359	26,9
360	25,0
361	23,2
362	21,9
363	21,1
364	20,7
365	20,7
366	20,8
367	21,2
368	22,1
369	23,5
370	24,3
371	24,5
372	23,8
373	21,3
374	17,7
375	14,4
376	11,9
377	10,2
378	8,9
379	8,0
380	7,2
381	6,1
382	4,9
383	3,7
384	2,3
385	0,9
386	0,0

Status: Point in time view as at 01/06/2017.

Changes to legislation: There are outstanding changes not yet made to Commission Regulation (EU) 2017/1151. Any changes that have already been made to the legislation appear in the content and are referenced with annotations. (See end of Document for details)

387	0,0
388	0,0
389	0,0
390	0,0
391	0,0
392	0,5
393	2,1
394	4,8
395	8,3
396	12,3
397	16,6
398	20,9
399	24,2
400	25,6
401	25,6
402	24,9
403	23,3
404	21,6
405	20,2
406	18,7
407	17,0
408	15,3
409	14,2
410	13,9
411	14,0
412	14,2
413	14,5
414	14,9
415	15,9
416	17,4
417	18,7
418	19,1
419	18,8
420	17,6

Status: Point in time view as at 01/06/2017.

Changes to legislation: There are outstanding changes not yet made to Commission Regulation (EU) 2017/1151. Any changes that have already been made to the legislation appear in the content and are referenced with annotations. (See end of Document for details)

421	16,6
422	16,2
423	16,4
424	17,2
425	19,1
426	22,6
427	27,4
428	31,6
429	33,4
430	33,5
431	32,8
432	31,9
433	31,3
434	31,1
435	30,6
436	29,2
437	26,7
438	23,0
439	18,2
440	12,9
441	7,7
442	3,8
443	1,3
444	0,2
445	0,0
446	0,0
447	0,0
448	0,0
449	0,0
450	0,0
451	0,0
452	0,0
453	0,0
454	0,0

Status: Point in time view as at 01/06/2017.

Changes to legislation: There are outstanding changes not yet made to Commission Regulation (EU) 2017/1151. Any changes that have already been made to the legislation appear in the content and are referenced with annotations. (See end of Document for details)

455	0,0
456	0,0
457	0,0
458	0,0
459	0,0
460	0,0
461	0,0
462	0,0
463	0,0
464	0,0
465	0,0
466	0,0
467	0,0
468	0,0
469	0,0
470	0,0
471	0,0
472	0,0
473	0,0
474	0,0
475	0,0
476	0,0
477	0,0
478	0,0
479	0,0
480	0,0
481	0,0
482	0,0
483	0,0
484	0,0
485	0,0
486	0,0
487	0,0
488	0,0

Status: Point in time view as at 01/06/2017.

Changes to legislation: There are outstanding changes not yet made to Commission Regulation (EU) 2017/1151. Any changes that have already been made to the legislation appear in the content and are referenced with annotations. (See end of Document for details)

489	0,0
490	0,0
491	0,0
492	0,0
493	0,0
494	0,0
495	0,0
496	0,0
497	0,0
498	0,0
499	0,0
500	0,0
501	0,0
502	0,0
503	0,0
504	0,0
505	0,0
506	0,0
507	0,0
508	0,0
509	0,0
510	0,0
511	0,0
512	0,5
513	2,5
514	6,6
515	11,8
516	16,8
517	20,5
518	21,9
519	21,9
520	21,3
521	20,3
522	19,2

Status: Point in time view as at 01/06/2017.

Changes to legislation: There are outstanding changes not yet made to Commission Regulation (EU) 2017/1151. Any changes that have already been made to the legislation appear in the content and are referenced with annotations. (See end of Document for details)

523	17,8
524	15,5
525	11,9
526	7,6
527	4,0
528	2,0
529	1,0
530	0,0
531	0,0
532	0,0
533	0,2
534	1,2
535	3,2
536	5,2
537	8,2
538	13
539	18,8
540	23,1
541	24,5
542	24,5
543	24,3
544	23,6
545	22,3
546	20,1
547	18,5
548	17,2
549	16,3
550	15,4
551	14,7
552	14,3
553	13,7
554	13,3
555	13,1
556	13,1

Status: Point in time view as at 01/06/2017.

Changes to legislation: There are outstanding changes not yet made to Commission Regulation (EU) 2017/1151. Any changes that have already been made to the legislation appear in the content and are referenced with annotations. (See end of Document for details)

557	13,3
558	13,8
559	14,5
560	16,5
561	17,0
562	17,0
563	17,0
564	15,4
565	10,1
566	4,8
567	0,0
568	0,0
569	0,0
570	0,0
571	0,0
572	0,0
573	0,0
574	0,0
575	0,0
576	0,0
577	0,0
578	0,0
579	0,0
580	0,0
581	0,0
582	0,0
583	0,0
584	0,0
585	0,0
586	0,0
587	0,0
588	0,0
589	0,0

Status: Point in time view as at 01/06/2017.

Changes to legislation: There are outstanding changes not yet made to Commission
Regulation (EU) 2017/1151. Any changes that have already been made to the legislation
appear in the content and are referenced with annotations. (See end of Document for details)

TABLE A1/8

WLTC, Class 3 vehicles, phase Medium_{3,1}

Time in s	Speed in km/h
590	0,0
591	0,0
592	0,0
593	0,0
594	0,0
595	0,0
596	0,0
597	0,0
598	0,0
599	0,0
600	0,0
601	1,0
602	2,1
603	5,2
604	9,2
605	13,5
606	18,1
607	22,3
608	26,0
609	29,3
610	32,8
611	36,0
612	39,2
613	42,5
614	45,7
615	48,2
616	48,4
617	48,2
618	47,8
619	47,0
620	45,9

Status: Point in time view as at 01/06/2017.

Changes to legislation: There are outstanding changes not yet made to Commission Regulation (EU) 2017/1151. Any changes that have already been made to the legislation appear in the content and are referenced with annotations. (See end of Document for details)

621	44,9
622	44,4
623	44,3
624	44,5
625	45,1
626	45,7
627	46,0
628	46,0
629	46,0
630	46,1
631	46,7
632	47,7
633	48,9
634	50,3
635	51,6
636	52,6
637	53,0
638	53,0
639	52,9
640	52,7
641	52,6
642	53,1
643	54,3
644	55,2
645	55,5
646	55,9
647	56,3
648	56,7
649	56,9
650	56,8
651	56,0
652	54,2
653	52,1
654	50,1

Status: Point in time view as at 01/06/2017.

Changes to legislation: There are outstanding changes not yet made to Commission Regulation (EU) 2017/1151. Any changes that have already been made to the legislation appear in the content and are referenced with annotations. (See end of Document for details)

655	47,2
656	43,2
657	39,2
658	36,5
659	34,3
660	31,0
661	26,0
662	20,7
663	15,4
664	13,1
665	12,0
666	12,5
667	14,0
668	19,0
669	23,2
670	28,0
671	32,0
672	34,0
673	36,0
674	38,0
675	40,0
676	40,3
677	40,5
678	39,0
679	35,7
680	31,8
681	27,1
682	22,8
683	21,1
684	18,9
685	18,9
686	21,3
687	23,9
688	25,9

Status: Point in time view as at 01/06/2017.

Changes to legislation: There are outstanding changes not yet made to Commission Regulation (EU) 2017/1151. Any changes that have already been made to the legislation appear in the content and are referenced with annotations. (See end of Document for details)

689	28,4
690	30,3
691	30,9
692	31,1
693	31,8
694	32,7
695	33,2
696	32,4
697	28,3
698	25,8
699	23,1
700	21,8
701	21,2
702	21,0
703	21,0
704	20,9
705	19,9
706	17,9
707	15,1
708	12,8
709	12,0
710	13,2
711	17,1
712	21,1
713	21,8
714	21,2
715	18,5
716	13,9
717	12,0
718	12,0
719	13,0
720	16,3
721	20,5
722	23,9

Status: Point in time view as at 01/06/2017.

Changes to legislation: There are outstanding changes not yet made to Commission Regulation (EU) 2017/1151. Any changes that have already been made to the legislation appear in the content and are referenced with annotations. (See end of Document for details)

723	26,0
724	28,0
725	31,5
726	33,4
727	36,0
728	37,8
729	40,2
730	41,6
731	41,9
732	42,0
733	42,2
734	42,4
735	42,7
736	43,1
737	43,7
738	44,0
739	44,1
740	45,3
741	46,4
742	47,2
743	47,3
744	47,4
745	47,4
746	47,5
747	47,9
748	48,6
749	49,4
750	49,8
751	49,8
752	49,7
753	49,3
754	48,5
755	47,6
756	46,3

Status: Point in time view as at 01/06/2017.

Changes to legislation: There are outstanding changes not yet made to Commission Regulation (EU) 2017/1151. Any changes that have already been made to the legislation appear in the content and are referenced with annotations. (See end of Document for details)

757	43,7
758	39,3
759	34,1
760	29,0
761	23,7
762	18,4
763	14,3
764	12,0
765	12,8
766	16,0
767	20,4
768	24,0
769	29,0
770	32,2
771	36,8
772	39,4
773	43,2
774	45,8
775	49,2
776	51,4
777	54,2
778	56,0
779	58,3
780	59,8
781	61,7
782	62,7
783	63,3
784	63,6
785	64,0
786	64,7
787	65,2
788	65,3
789	65,3
790	65,4

Status: Point in time view as at 01/06/2017.

Changes to legislation: There are outstanding changes not yet made to Commission Regulation (EU) 2017/1151. Any changes that have already been made to the legislation appear in the content and are referenced with annotations. (See end of Document for details)

791	65,7
792	66,0
793	65,6
794	63,5
795	59,7
796	54,6
797	49,3
798	44,9
799	42,3
800	41,4
801	41,3
802	43,0
803	45,0
804	46,5
805	48,3
806	49,5
807	51,2
808	52,2
809	51,6
810	49,7
811	47,4
812	43,7
813	39,7
814	35,5
815	31,1
816	26,3
817	21,9
818	18,0
819	17,0
820	18,0
821	21,4
822	24,8
823	27,9
824	30,8

Status: Point in time view as at 01/06/2017.

Changes to legislation: There are outstanding changes not yet made to Commission Regulation (EU) 2017/1151. Any changes that have already been made to the legislation appear in the content and are referenced with annotations. (See end of Document for details)

825	33,0
826	35,1
827	37,1
828	38,9
829	41,4
830	44,0
831	46,3
832	47,7
833	48,2
834	48,7
835	49,3
836	49,8
837	50,2
838	50,9
839	51,8
840	52,5
841	53,3
842	54,5
843	55,7
844	56,5
845	56,8
846	57,0
847	57,2
848	57,7
849	58,7
850	60,1
851	61,1
852	61,7
853	62,3
854	62,9
855	63,3
856	63,4
857	63,5
858	63,9

Status: Point in time view as at 01/06/2017.

Changes to legislation: There are outstanding changes not yet made to Commission Regulation (EU) 2017/1151. Any changes that have already been made to the legislation appear in the content and are referenced with annotations. (See end of Document for details)

859	64,4
860	65,0
861	65,6
862	66,6
863	67,4
864	68,2
865	69,1
866	70,0
867	70,8
868	71,5
869	72,4
870	73,0
871	73,7
872	74,4
873	74,9
874	75,3
875	75,6
876	75,8
877	76,6
878	76,5
879	76,2
880	75,8
881	75,4
882	74,8
883	73,9
884	72,7
885	71,3
886	70,4
887	70,0
888	70,0
889	69,0
890	68,0
891	67,3
892	66,2

Status: Point in time view as at 01/06/2017.

Changes to legislation: There are outstanding changes not yet made to Commission Regulation (EU) 2017/1151. Any changes that have already been made to the legislation appear in the content and are referenced with annotations. (See end of Document for details)

893	64,8
894	63,6
895	62,6
896	62,1
897	61,9
898	61,9
899	61,8
900	61,5
901	60,9
902	59,7
903	54,6
904	49,3
905	44,9
906	42,3
907	41,4
908	41,3
909	42,1
910	44,7
911	46,0
912	48,8
913	50,1
914	51,3
915	54,1
916	55,2
917	56,2
918	56,1
919	56,1
920	56,5
921	57,5
922	59,2
923	60,7
924	61,8
925	62,3
926	62,7

Status: Point in time view as at 01/06/2017.

Changes to legislation: There are outstanding changes not yet made to Commission Regulation (EU) 2017/1151. Any changes that have already been made to the legislation appear in the content and are referenced with annotations. (See end of Document for details)

927	62,0
928	61,3
929	60,9
930	60,5
931	60,2
932	59,8
933	59,4
934	58,6
935	57,5
936	56,6
937	56,0
938	55,5
939	55,0
940	54,4
941	54,1
942	54,0
943	53,9
944	53,9
945	54,0
946	54,2
947	55,0
948	55,8
949	56,2
950	56,1
951	55,1
952	52,7
953	48,4
954	43,1
955	37,8
956	32,5
957	27,2
958	25,1
959	27,0
960	29,8

Status: Point in time view as at 01/06/2017.

Changes to legislation: There are outstanding changes not yet made to Commission Regulation (EU) 2017/1151. Any changes that have already been made to the legislation appear in the content and are referenced with annotations. (See end of Document for details)

961	33,8
962	37,0
963	40,7
964	43,0
965	45,6
966	46,9
967	47,0
968	46,9
969	46,5
970	45,8
971	44,3
972	41,3
973	36,5
974	31,7
975	27,0
976	24,7
977	19,3
978	16,0
979	13,2
980	10,7
981	8,8
982	7,2
983	5,5
984	3,2
985	1,1
986	0,0
987	0,0
988	0,0
989	0,0
990	0,0
991	0,0
992	0,0
993	0,0
994	0,0

Status: Point in time view as at 01/06/2017.

Changes to legislation: There are outstanding changes not yet made to Commission Regulation (EU) 2017/1151. Any changes that have already been made to the legislation appear in the content and are referenced with annotations. (See end of Document for details)

995	0,0
996	0,0
997	0,0
998	0,0
999	0,0
1000	0,0
1001	0,0
1002	0,0
1003	0,0
1004	0,0
1005	0,0
1006	0,0
1007	0,0
1008	0,0
1009	0,0
1010	0,0
1011	0,0
1012	0,0
1013	0,0
1014	0,0
1015	0,0
1016	0,0
1017	0,0
1018	0,0
1019	0,0
1020	0,0
1021	0,0
1022	0,0

TABLE A1/9

WLTC, Class 3 vehicles, phase Medium₃₋₂

Time in s	Speed in km/h
590	0,0
591	0,0
592	0,0

Status: Point in time view as at 01/06/2017.

Changes to legislation: There are outstanding changes not yet made to Commission Regulation (EU) 2017/1151. Any changes that have already been made to the legislation appear in the content and are referenced with annotations. (See end of Document for details)

593	0,0
594	0,0
595	0,0
596	0,0
597	0,0
598	0,0
599	0,0
600	0,0
601	1,0
602	2,1
603	4,8
604	9,1
605	14,2
606	19,8
607	25,5
608	30,5
609	34,8
610	38,8
611	42,9
612	46,4
613	48,3
614	48,7
615	48,5
616	48,4
617	48,2
618	47,8
619	47,0
620	45,9
621	44,9
622	44,4
623	44,3
624	44,5
625	45,1
626	45,7

Status: Point in time view as at 01/06/2017.

Changes to legislation: There are outstanding changes not yet made to Commission Regulation (EU) 2017/1151. Any changes that have already been made to the legislation appear in the content and are referenced with annotations. (See end of Document for details)

627	46,0
628	46,0
629	46,0
630	46,1
631	46,7
632	47,7
633	48,9
634	50,3
635	51,6
636	52,6
637	53,0
638	53,0
639	52,9
640	52,7
641	52,6
642	53,1
643	54,3
644	55,2
645	55,5
646	55,9
647	56,3
648	56,7
649	56,9
650	56,8
651	56,0
652	54,2
653	52,1
654	50,1
655	47,2
656	43,2
657	39,2
658	36,5
659	34,3
660	31,0

Status: Point in time view as at 01/06/2017.

Changes to legislation: There are outstanding changes not yet made to Commission Regulation (EU) 2017/1151. Any changes that have already been made to the legislation appear in the content and are referenced with annotations. (See end of Document for details)

661	26,0
662	20,7
663	15,4
664	13,1
665	12,0
666	12,5
667	14,0
668	19,0
669	23,2
670	28,0
671	32,0
672	34,0
673	36,0
674	38,0
675	40,0
676	40,3
677	40,5
678	39,0
679	35,7
680	31,8
681	27,1
682	22,8
683	21,1
684	18,9
685	18,9
686	21,3
687	23,9
688	25,9
689	28,4
690	30,3
691	30,9
692	31,1
693	31,8
694	32,7

Status: Point in time view as at 01/06/2017.

Changes to legislation: There are outstanding changes not yet made to Commission Regulation (EU) 2017/1151. Any changes that have already been made to the legislation appear in the content and are referenced with annotations. (See end of Document for details)

695	33,2
696	32,4
697	28,3
698	25,8
699	23,1
700	21,8
701	21,2
702	21,0
703	21,0
704	20,9
705	19,9
706	17,9
707	15,1
708	12,8
709	12,0
710	13,2
711	17,1
712	21,1
713	21,8
714	21,2
715	18,5
716	13,9
717	12,0
718	12,0
719	13,0
720	16,0
721	18,5
722	20,6
723	22,5
724	24,0
725	26,6
726	29,9
727	34,8
728	37,8

Status: Point in time view as at 01/06/2017.

Changes to legislation: There are outstanding changes not yet made to Commission Regulation (EU) 2017/1151. Any changes that have already been made to the legislation appear in the content and are referenced with annotations. (See end of Document for details)

729	40,2
730	41,6
731	41,9
732	42,0
733	42,2
734	42,4
735	42,7
736	43,1
737	43,7
738	44,0
739	44,1
740	45,3
741	46,4
742	47,2
743	47,3
744	47,4
745	47,4
746	47,5
747	47,9
748	48,6
749	49,4
750	49,8
751	49,8
752	49,7
753	49,3
754	48,5
755	47,6
756	46,3
757	43,7
758	39,3
759	34,1
760	29,0
761	23,7
762	18,4

Status: Point in time view as at 01/06/2017.

Changes to legislation: There are outstanding changes not yet made to Commission Regulation (EU) 2017/1151. Any changes that have already been made to the legislation appear in the content and are referenced with annotations. (See end of Document for details)

763	14,3
764	12,0
765	12,8
766	16,0
767	19,1
768	22,4
769	25,6
770	30,1
771	35,3
772	39,9
773	44,5
774	47,5
775	50,9
776	54,1
777	56,3
778	58,1
779	59,8
780	61,1
781	62,1
782	62,8
783	63,3
784	63,6
785	64,0
786	64,7
787	65,2
788	65,3
789	65,3
790	65,4
791	65,7
792	66,0
793	65,6
794	63,5
795	59,7
796	54,6

Status: Point in time view as at 01/06/2017.

Changes to legislation: There are outstanding changes not yet made to Commission Regulation (EU) 2017/1151. Any changes that have already been made to the legislation appear in the content and are referenced with annotations. (See end of Document for details)

797	49,3
798	44,9
799	42,3
800	41,4
801	41,3
802	42,1
803	44,7
804	48,4
805	51,4
806	52,7
807	53,0
808	52,5
809	51,3
810	49,7
811	47,4
812	43,7
813	39,7
814	35,5
815	31,1
816	26,3
817	21,9
818	18,0
819	17,0
820	18,0
821	21,4
822	24,8
823	27,9
824	30,8
825	33,0
826	35,1
827	37,1
828	38,9
829	41,4
830	44,0

Status: Point in time view as at 01/06/2017.

Changes to legislation: There are outstanding changes not yet made to Commission Regulation (EU) 2017/1151. Any changes that have already been made to the legislation appear in the content and are referenced with annotations. (See end of Document for details)

831	46,3
832	47,7
833	48,2
834	48,7
835	49,3
836	49,8
837	50,2
838	50,9
839	51,8
840	52,5
841	53,3
842	54,5
843	55,7
844	56,5
845	56,8
846	57,0
847	57,2
848	57,7
849	58,7
850	60,1
851	61,1
852	61,7
853	62,3
854	62,9
855	63,3
856	63,4
857	63,5
858	64,5
859	65,8
860	66,8
861	67,4
862	68,8
863	71,1
864	72,3

Status: Point in time view as at 01/06/2017.

Changes to legislation: There are outstanding changes not yet made to Commission Regulation (EU) 2017/1151. Any changes that have already been made to the legislation appear in the content and are referenced with annotations. (See end of Document for details)

865	72,8
866	73,4
867	74,6
868	76,0
869	76,6
870	76,5
871	76,2
872	75,8
873	75,4
874	74,8
875	73,9
876	72,7
877	71,3
878	70,4
879	70,0
880	70,0
881	69,0
882	68,0
883	68,0
884	68,0
885	68,1
886	68,4
887	68,6
888	68,7
889	68,5
890	68,1
891	67,3
892	66,2
893	64,8
894	63,6
895	62,6
896	62,1
897	61,9
898	61,9

Status: Point in time view as at 01/06/2017.

Changes to legislation: There are outstanding changes not yet made to Commission Regulation (EU) 2017/1151. Any changes that have already been made to the legislation appear in the content and are referenced with annotations. (See end of Document for details)

899	61,8
900	61,5
901	60,9
902	59,7
903	54,6
904	49,3
905	44,9
906	42,3
907	41,4
908	41,3
909	42,1
910	44,7
911	48,4
912	51,4
913	52,7
914	54,0
915	57,0
916	58,1
917	59,2
918	59,0
919	59,1
920	59,5
921	60,5
922	62,3
923	63,9
924	65,1
925	64,1
926	62,7
927	62,0
928	61,3
929	60,9
930	60,5
931	60,2
932	59,8

Status: Point in time view as at 01/06/2017.

Changes to legislation: There are outstanding changes not yet made to Commission Regulation (EU) 2017/1151. Any changes that have already been made to the legislation appear in the content and are referenced with annotations. (See end of Document for details)

933	59,4
934	58,6
935	57,5
936	56,6
937	56,0
938	55,5
939	55,0
940	54,4
941	54,1
942	54,0
943	53,9
944	53,9
945	54,0
946	54,2
947	55,0
948	55,8
949	56,2
950	56,1
951	55,1
952	52,7
953	48,4
954	43,1
955	37,8
956	32,5
957	27,2
958	25,1
959	26,0
960	29,3
961	34,6
962	40,4
963	45,3
964	49,0
965	51,1
966	52,1

Status: Point in time view as at 01/06/2017.

Changes to legislation: There are outstanding changes not yet made to Commission Regulation (EU) 2017/1151. Any changes that have already been made to the legislation appear in the content and are referenced with annotations. (See end of Document for details)

967	52,2
968	52,1
969	51,7
970	50,9
971	49,2
972	45,9
973	40,6
974	35,3
975	30,0
976	24,7
977	19,3
978	16,0
979	13,2
980	10,7
981	8,8
982	7,2
983	5,5
984	3,2
985	1,1
986	0,0
987	0,0
988	0,0
989	0,0
990	0,0
991	0,0
992	0,0
993	0,0
994	0,0
995	0,0
996	0,0
997	0,0
998	0,0
999	0,0
1000	0,0

Status: Point in time view as at 01/06/2017.

Changes to legislation: There are outstanding changes not yet made to Commission Regulation (EU) 2017/1151. Any changes that have already been made to the legislation appear in the content and are referenced with annotations. (See end of Document for details)

1001	0,0
1002	0,0
1003	0,0
1004	0,0
1005	0,0
1006	0,0
1007	0,0
1008	0,0
1009	0,0
1010	0,0
1011	0,0
1012	0,0
1013	0,0
1014	0,0
1015	0,0
1016	0,0
1017	0,0
1018	0,0
1019	0,0
1020	0,0
1021	0,0
1022	0,0

TABLE A1/10

WLTC, Class 3 vehicles, phase High₃₋₁

Time in s	Speed in km/h
1023	0,0
1024	0,0
1025	0,0
1026	0,0
1027	0,8
1028	3,6
1029	8,6
1030	14,6
1031	20,0

Status: Point in time view as at 01/06/2017.

Changes to legislation: There are outstanding changes not yet made to Commission Regulation (EU) 2017/1151. Any changes that have already been made to the legislation appear in the content and are referenced with annotations. (See end of Document for details)

1032	24,4
1033	28,2
1034	31,7
1035	35,0
1036	37,6
1037	39,7
1038	41,5
1039	43,6
1040	46,0
1041	48,4
1042	50,5
1043	51,9
1044	52,6
1045	52,8
1046	52,9
1047	53,1
1048	53,3
1049	53,1
1050	52,3
1051	50,7
1052	48,8
1053	46,5
1054	43,8
1055	40,3
1056	36,0
1057	30,7
1058	25,4
1059	21,0
1060	16,7
1061	13,4
1062	12,0
1063	12,1
1064	12,8
1065	15,6

Status: Point in time view as at 01/06/2017.

Changes to legislation: There are outstanding changes not yet made to Commission Regulation (EU) 2017/1151. Any changes that have already been made to the legislation appear in the content and are referenced with annotations. (See end of Document for details)

1066	19,9
1067	23,4
1068	24,6
1069	27,0
1070	29,0
1071	32,0
1072	34,8
1073	37,7
1074	40,8
1075	43,2
1076	46,0
1077	48,0
1078	50,7
1079	52,0
1080	54,5
1081	55,9
1082	57,4
1083	58,1
1084	58,4
1085	58,8
1086	58,8
1087	58,6
1088	58,7
1089	58,8
1090	58,8
1091	58,8
1092	59,1
1093	60,1
1094	61,7
1095	63,0
1096	63,7
1097	63,9
1098	63,5
1099	62,3

Status: Point in time view as at 01/06/2017.

Changes to legislation: There are outstanding changes not yet made to Commission Regulation (EU) 2017/1151. Any changes that have already been made to the legislation appear in the content and are referenced with annotations. (See end of Document for details)

1100	60,3
1101	58,9
1102	58,4
1103	58,8
1104	60,2
1105	62,3
1106	63,9
1107	64,5
1108	64,4
1109	63,5
1110	62,0
1111	61,2
1112	61,3
1113	61,7
1114	62,0
1115	64,6
1116	66,0
1117	66,2
1118	65,8
1119	64,7
1120	63,6
1121	62,9
1122	62,4
1123	61,7
1124	60,1
1125	57,3
1126	55,8
1127	50,5
1128	45,2
1129	40,1
1130	36,2
1131	32,9
1132	29,8
1133	26,6

Status: Point in time view as at 01/06/2017.

Changes to legislation: There are outstanding changes not yet made to Commission Regulation (EU) 2017/1151. Any changes that have already been made to the legislation appear in the content and are referenced with annotations. (See end of Document for details)

1134	23,0
1135	19,4
1136	16,3
1137	14,6
1138	14,2
1139	14,3
1140	14,6
1141	15,1
1142	16,4
1143	19,1
1144	22,5
1145	24,4
1146	24,8
1147	22,7
1148	17,4
1149	13,8
1150	12,0
1151	12,0
1152	12,0
1153	13,9
1154	17,7
1155	22,8
1156	27,3
1157	31,2
1158	35,2
1159	39,4
1160	42,5
1161	45,4
1162	48,2
1163	50,3
1164	52,6
1165	54,5
1166	56,6
1167	58,3

Status: Point in time view as at 01/06/2017.

Changes to legislation: There are outstanding changes not yet made to Commission Regulation (EU) 2017/1151. Any changes that have already been made to the legislation appear in the content and are referenced with annotations. (See end of Document for details)

1168	60,0
1169	61,5
1170	63,1
1171	64,3
1172	65,7
1173	67,1
1174	68,3
1175	69,7
1176	70,6
1177	71,6
1178	72,6
1179	73,5
1180	74,2
1181	74,9
1182	75,6
1183	76,3
1184	77,1
1185	77,9
1186	78,5
1187	79,0
1188	79,7
1189	80,3
1190	81,0
1191	81,6
1192	82,4
1193	82,9
1194	83,4
1195	83,8
1196	84,2
1197	84,7
1198	85,2
1199	85,6
1200	86,3
1201	86,8

Status: Point in time view as at 01/06/2017.

Changes to legislation: There are outstanding changes not yet made to Commission Regulation (EU) 2017/1151. Any changes that have already been made to the legislation appear in the content and are referenced with annotations. (See end of Document for details)

1202	87,4
1203	88,0
1204	88,3
1205	88,7
1206	89,0
1207	89,3
1208	89,8
1209	90,2
1210	90,6
1211	91,0
1212	91,3
1213	91,6
1214	91,9
1215	92,2
1216	92,8
1217	93,1
1218	93,3
1219	93,5
1220	93,7
1221	93,9
1222	94,0
1223	94,1
1224	94,3
1225	94,4
1226	94,6
1227	94,7
1228	94,8
1229	95,0
1230	95,1
1231	95,3
1232	95,4
1233	95,6
1234	95,7
1235	95,8

Status: Point in time view as at 01/06/2017.

Changes to legislation: There are outstanding changes not yet made to Commission Regulation (EU) 2017/1151. Any changes that have already been made to the legislation appear in the content and are referenced with annotations. (See end of Document for details)

1236	96,0
1237	96,1
1238	96,3
1239	96,4
1240	96,6
1241	96,8
1242	97,0
1243	97,2
1244	97,3
1245	97,4
1246	97,4
1247	97,4
1248	97,4
1249	97,3
1250	97,3
1251	97,3
1252	97,3
1253	97,2
1254	97,1
1255	97,0
1256	96,9
1257	96,7
1258	96,4
1259	96,1
1260	95,7
1261	95,5
1262	95,3
1263	95,2
1264	95,0
1265	94,9
1266	94,7
1267	94,5
1268	94,4
1269	94,4

Status: Point in time view as at 01/06/2017.

Changes to legislation: There are outstanding changes not yet made to Commission Regulation (EU) 2017/1151. Any changes that have already been made to the legislation appear in the content and are referenced with annotations. (See end of Document for details)

1270	94,3
1271	94,3
1272	94,1
1273	93,9
1274	93,4
1275	92,8
1276	92,0
1277	91,3
1278	90,6
1279	90,0
1280	89,3
1281	88,7
1282	88,1
1283	87,4
1284	86,7
1285	86,0
1286	85,3
1287	84,7
1288	84,1
1289	83,5
1290	82,9
1291	82,3
1292	81,7
1293	81,1
1294	80,5
1295	79,9
1296	79,4
1297	79,1
1298	78,8
1299	78,5
1300	78,2
1301	77,9
1302	77,6
1303	77,3

Status: Point in time view as at 01/06/2017.

Changes to legislation: There are outstanding changes not yet made to Commission Regulation (EU) 2017/1151. Any changes that have already been made to the legislation appear in the content and are referenced with annotations. (See end of Document for details)

1304	77,0
1305	76,7
1306	76,0
1307	76,0
1308	76,0
1309	75,9
1310	76,0
1311	76,0
1312	76,1
1313	76,3
1314	76,5
1315	76,6
1316	76,8
1317	77,1
1318	77,1
1319	77,2
1320	77,2
1321	77,6
1322	78,0
1323	78,4
1324	78,8
1325	79,2
1326	80,3
1327	80,8
1328	81,0
1329	81,0
1330	81,0
1331	81,0
1332	81,0
1333	80,9
1334	80,6
1335	80,3
1336	80,0
1337	79,9

Status: Point in time view as at 01/06/2017.

Changes to legislation: There are outstanding changes not yet made to Commission Regulation (EU) 2017/1151. Any changes that have already been made to the legislation appear in the content and are referenced with annotations. (See end of Document for details)

1338	79,8
1339	79,8
1340	79,8
1341	79,9
1342	80,0
1343	80,4
1344	80,8
1345	81,2
1346	81,5
1347	81,6
1348	81,6
1349	81,4
1350	80,7
1351	79,6
1352	78,2
1353	76,8
1354	75,3
1355	73,8
1356	72,1
1357	70,2
1358	68,2
1359	66,1
1360	63,8
1361	61,6
1362	60,2
1363	59,8
1364	60,4
1365	61,8
1366	62,6
1367	62,7
1368	61,9
1369	60,0
1370	58,4
1371	57,8

Status: Point in time view as at 01/06/2017.

Changes to legislation: There are outstanding changes not yet made to Commission Regulation (EU) 2017/1151. Any changes that have already been made to the legislation appear in the content and are referenced with annotations. (See end of Document for details)

1372	57,8
1373	57,8
1374	57,3
1375	56,2
1376	54,3
1377	50,8
1378	45,5
1379	40,2
1380	34,9
1381	29,6
1382	28,7
1383	29,3
1384	30,5
1385	31,7
1386	32,9
1387	35,0
1388	38,0
1389	40,5
1390	42,7
1391	45,8
1392	47,5
1393	48,9
1394	49,4
1395	49,4
1396	49,2
1397	48,7
1398	47,9
1399	46,9
1400	45,6
1401	44,2
1402	42,7
1403	40,7
1404	37,1
1405	33,9

Status: Point in time view as at 01/06/2017.

Changes to legislation: There are outstanding changes not yet made to Commission Regulation (EU) 2017/1151. Any changes that have already been made to the legislation appear in the content and are referenced with annotations. (See end of Document for details)

1406	30,6
1407	28,6
1408	27,3
1409	27,2
1410	27,5
1411	27,4
1412	27,1
1413	26,7
1414	26,8
1415	28,2
1416	31,1
1417	34,8
1418	38,4
1419	40,9
1420	41,7
1421	40,9
1422	38,3
1423	35,3
1424	34,3
1425	34,6
1426	36,3
1427	39,5
1428	41,8
1429	42,5
1430	41,9
1431	40,1
1432	36,6
1433	31,3
1434	26,0
1435	20,6
1436	19,1
1437	19,7
1438	21,1
1439	22,0

Status: Point in time view as at 01/06/2017.

Changes to legislation: There are outstanding changes not yet made to Commission Regulation (EU) 2017/1151. Any changes that have already been made to the legislation appear in the content and are referenced with annotations. (See end of Document for details)

1440	22,1
1441	21,4
1442	19,6
1443	18,3
1444	18,0
1445	18,3
1446	18,5
1447	17,9
1448	15,0
1449	9,9
1450	4,6
1451	1,2
1452	0,0
1453	0,0
1454	0,0
1455	0,0
1456	0,0
1457	0,0
1458	0,0
1459	0,0
1460	0,0
1461	0,0
1462	0,0
1463	0,0
1464	0,0
1465	0,0
1466	0,0
1467	0,0
1468	0,0
1469	0,0
1470	0,0
1471	0,0
1472	0,0
1473	0,0

Status: Point in time view as at 01/06/2017.

Changes to legislation: There are outstanding changes not yet made to Commission Regulation (EU) 2017/1151. Any changes that have already been made to the legislation appear in the content and are referenced with annotations. (See end of Document for details)

1474	0,0
1475	0,0
1476	0,0
1477	0,0

TABLE A1/11

WLTC, Class 3 vehicles, phase High_{3,2}

Time in s	Speed in km/h
1023	0,0
1024	0,0
1025	0,0
1026	0,0
1027	0,8
1028	3,6
1029	8,6
1030	14,6
1031	20,0
1032	24,4
1033	28,2
1034	31,7
1035	35,0
1036	37,6
1037	39,7
1038	41,5
1039	43,6
1040	46,0
1041	48,4
1042	50,5
1043	51,9
1044	52,6
1045	52,8
1046	52,9
1047	53,1
1048	53,3
1049	53,1

Status: Point in time view as at 01/06/2017.

Changes to legislation: There are outstanding changes not yet made to Commission Regulation (EU) 2017/1151. Any changes that have already been made to the legislation appear in the content and are referenced with annotations. (See end of Document for details)

1050	52,3
1051	50,7
1052	48,8
1053	46,5
1054	43,8
1055	40,3
1056	36,0
1057	30,7
1058	25,4
1059	21,0
1060	16,7
1061	13,4
1062	12,0
1063	12,1
1064	12,8
1065	15,6
1066	19,9
1067	23,4
1068	24,6
1069	25,2
1070	26,4
1071	28,8
1072	31,8
1073	35,3
1074	39,5
1075	44,5
1076	49,3
1077	53,3
1078	56,4
1079	58,9
1080	61,2
1081	62,6
1082	63,0
1083	62,5

Status: Point in time view as at 01/06/2017.

Changes to legislation: There are outstanding changes not yet made to Commission Regulation (EU) 2017/1151. Any changes that have already been made to the legislation appear in the content and are referenced with annotations. (See end of Document for details)

1084	60,9
1085	59,3
1086	58,6
1087	58,6
1088	58,7
1089	58,8
1090	58,8
1091	58,8
1092	59,1
1093	60,1
1094	61,7
1095	63,0
1096	63,7
1097	63,9
1098	63,5
1099	62,3
1100	60,3
1101	58,9
1102	58,4
1103	58,8
1104	60,2
1105	62,3
1106	63,9
1107	64,5
1108	64,4
1109	63,5
1110	62,0
1111	61,2
1112	61,3
1113	62,6
1114	65,3
1115	68,0
1116	69,4
1117	69,7

Status: Point in time view as at 01/06/2017.

Changes to legislation: There are outstanding changes not yet made to Commission Regulation (EU) 2017/1151. Any changes that have already been made to the legislation appear in the content and are referenced with annotations. (See end of Document for details)

1118	69,3
1119	68,1
1120	66,9
1121	66,2
1122	65,7
1123	64,9
1124	63,2
1125	60,3
1126	55,8
1127	50,5
1128	45,2
1129	40,1
1130	36,2
1131	32,9
1132	29,8
1133	26,6
1134	23,0
1135	19,4
1136	16,3
1137	14,6
1138	14,2
1139	14,3
1140	14,6
1141	15,1
1142	16,4
1143	19,1
1144	22,5
1145	24,4
1146	24,8
1147	22,7
1148	17,4
1149	13,8
1150	12,0
1151	12,0

Status: Point in time view as at 01/06/2017.

Changes to legislation: There are outstanding changes not yet made to Commission Regulation (EU) 2017/1151. Any changes that have already been made to the legislation appear in the content and are referenced with annotations. (See end of Document for details)

1152	12,0
1153	13,9
1154	17,7
1155	22,8
1156	27,3
1157	31,2
1158	35,2
1159	39,4
1160	42,5
1161	45,4
1162	48,2
1163	50,3
1164	52,6
1165	54,5
1166	56,6
1167	58,3
1168	60,0
1169	61,5
1170	63,1
1171	64,3
1172	65,7
1173	67,1
1174	68,3
1175	69,7
1176	70,6
1177	71,6
1178	72,6
1179	73,5
1180	74,2
1181	74,9
1182	75,6
1183	76,3
1184	77,1
1185	77,9

Status: Point in time view as at 01/06/2017.

Changes to legislation: There are outstanding changes not yet made to Commission Regulation (EU) 2017/1151. Any changes that have already been made to the legislation appear in the content and are referenced with annotations. (See end of Document for details)

1186	78,5
1187	79,0
1188	79,7
1189	80,3
1190	81,0
1191	81,6
1192	82,4
1193	82,9
1194	83,4
1195	83,8
1196	84,2
1197	84,7
1198	85,2
1199	85,6
1200	86,3
1201	86,8
1202	87,4
1203	88,0
1204	88,3
1205	88,7
1206	89,0
1207	89,3
1208	89,8
1209	90,2
1210	90,6
1211	91,0
1212	91,3
1213	91,6
1214	91,9
1215	92,2
1216	92,8
1217	93,1
1218	93,3
1219	93,5

Status: Point in time view as at 01/06/2017.

Changes to legislation: There are outstanding changes not yet made to Commission Regulation (EU) 2017/1151. Any changes that have already been made to the legislation appear in the content and are referenced with annotations. (See end of Document for details)

1220	93,7
1221	93,9
1222	94,0
1223	94,1
1224	94,3
1225	94,4
1226	94,6
1227	94,7
1228	94,8
1229	95,0
1230	95,1
1231	95,3
1232	95,4
1233	95,6
1234	95,7
1235	95,8
1236	96,0
1237	96,1
1238	96,3
1239	96,4
1240	96,6
1241	96,8
1242	97,0
1243	97,2
1244	97,3
1245	97,4
1246	97,4
1247	97,4
1248	97,4
1249	97,3
1250	97,3
1251	97,3
1252	97,3
1253	97,2

Status: Point in time view as at 01/06/2017.

Changes to legislation: There are outstanding changes not yet made to Commission Regulation (EU) 2017/1151. Any changes that have already been made to the legislation appear in the content and are referenced with annotations. (See end of Document for details)

1254	97,1
1255	97,0
1256	96,9
1257	96,7
1258	96,4
1259	96,1
1260	95,7
1261	95,5
1262	95,3
1263	95,2
1264	95,0
1265	94,9
1266	94,7
1267	94,5
1268	94,4
1269	94,4
1270	94,3
1271	94,3
1272	94,1
1273	93,9
1274	93,4
1275	92,8
1276	92,0
1277	91,3
1278	90,6
1279	90,0
1280	89,3
1281	88,7
1282	88,1
1283	87,4
1284	86,7
1285	86,0
1286	85,3
1287	84,7

Status: Point in time view as at 01/06/2017.

Changes to legislation: There are outstanding changes not yet made to Commission Regulation (EU) 2017/1151. Any changes that have already been made to the legislation appear in the content and are referenced with annotations. (See end of Document for details)

1288	84,1
1289	83,5
1290	82,9
1291	82,3
1292	81,7
1293	81,1
1294	80,5
1295	79,9
1296	79,4
1297	79,1
1298	78,8
1299	78,5
1300	78,2
1301	77,9
1302	77,6
1303	77,3
1304	77,0
1305	76,7
1306	76,0
1307	76,0
1308	76,0
1309	75,9
1310	75,9
1311	75,8
1312	75,7
1313	75,5
1314	75,2
1315	75,0
1316	74,7
1317	74,1
1318	73,7
1319	73,3
1320	73,5
1321	74,0

Status: Point in time view as at 01/06/2017.

Changes to legislation: There are outstanding changes not yet made to Commission Regulation (EU) 2017/1151. Any changes that have already been made to the legislation appear in the content and are referenced with annotations. (See end of Document for details)

1322	74,9
1323	76,1
1324	77,7
1325	79,2
1326	80,3
1327	80,8
1328	81,0
1329	81,0
1330	81,0
1331	81,0
1332	81,0
1333	80,9
1334	80,6
1335	80,3
1336	80,0
1337	79,9
1338	79,8
1339	79,8
1340	79,8
1341	79,9
1342	80,0
1343	80,4
1344	80,8
1345	81,2
1346	81,5
1347	81,6
1348	81,6
1349	81,4
1350	80,7
1351	79,6
1352	78,2
1353	76,8
1354	75,3
1355	73,8

Status: Point in time view as at 01/06/2017.

Changes to legislation: There are outstanding changes not yet made to Commission Regulation (EU) 2017/1151. Any changes that have already been made to the legislation appear in the content and are referenced with annotations. (See end of Document for details)

1356	72,1
1357	70,2
1358	68,2
1359	66,1
1360	63,8
1361	61,6
1362	60,2
1363	59,8
1364	60,4
1365	61,8
1366	62,6
1367	62,7
1368	61,9
1369	60,0
1370	58,4
1371	57,8
1372	57,8
1373	57,8
1374	57,3
1375	56,2
1376	54,3
1377	50,8
1378	45,5
1379	40,2
1380	34,9
1381	29,6
1382	27,3
1383	29,3
1384	32,9
1385	35,6
1386	36,7
1387	37,6
1388	39,4
1389	42,5

Status: Point in time view as at 01/06/2017.

Changes to legislation: There are outstanding changes not yet made to Commission Regulation (EU) 2017/1151. Any changes that have already been made to the legislation appear in the content and are referenced with annotations. (See end of Document for details)

1390	46,5
1391	50,2
1392	52,8
1393	54,3
1394	54,9
1395	54,9
1396	54,7
1397	54,1
1398	53,2
1399	52,1
1400	50,7
1401	49,1
1402	47,4
1403	45,2
1404	41,8
1405	36,5
1406	31,2
1407	27,6
1408	26,9
1409	27,3
1410	27,5
1411	27,4
1412	27,1
1413	26,7
1414	26,8
1415	28,2
1416	31,1
1417	34,8
1418	38,4
1419	40,9
1420	41,7
1421	40,9
1422	38,3
1423	35,3

Status: Point in time view as at 01/06/2017.

Changes to legislation: There are outstanding changes not yet made to Commission Regulation (EU) 2017/1151. Any changes that have already been made to the legislation appear in the content and are referenced with annotations. (See end of Document for details)

1424	34,3
1425	34,6
1426	36,3
1427	39,5
1428	41,8
1429	42,5
1430	41,9
1431	40,1
1432	36,6
1433	31,3
1434	26,0
1435	20,6
1436	19,1
1437	19,7
1438	21,1
1439	22,0
1440	22,1
1441	21,4
1442	19,6
1443	18,3
1444	18,0
1445	18,3
1446	18,5
1447	17,9
1448	15,0
1449	9,9
1450	4,6
1451	1,2
1452	0,0
1453	0,0
1454	0,0
1455	0,0
1456	0,0
1457	0,0

Status: Point in time view as at 01/06/2017.

Changes to legislation: There are outstanding changes not yet made to Commission Regulation (EU) 2017/1151. Any changes that have already been made to the legislation appear in the content and are referenced with annotations. (See end of Document for details)

1458	0,0
1459	0,0
1460	0,0
1461	0,0
1462	0,0
1463	0,0
1464	0,0
1465	0,0
1466	0,0
1467	0,0
1468	0,0
1469	0,0
1470	0,0
1471	0,0
1472	0,0
1473	0,0
1474	0,0
1475	0,0
1476	0,0
1477	0,0

TABLE A1/12

WLTC, Class 3 vehicles, phase Extra High₃

Time in s	Speed in km/h
1478	0,0
1479	2,2
1480	4,4
1481	6,3
1482	7,9
1483	9,2
1484	10,4
1485	11,5
1486	12,9
1487	14,7
1488	17,0

Status: Point in time view as at 01/06/2017.

Changes to legislation: There are outstanding changes not yet made to Commission Regulation (EU) 2017/1151. Any changes that have already been made to the legislation appear in the content and are referenced with annotations. (See end of Document for details)

1489	19,8
1490	23,1
1491	26,7
1492	30,5
1493	34,1
1494	37,5
1495	40,6
1496	43,3
1497	45,7
1498	47,7
1499	49,3
1500	50,5
1501	51,3
1502	52,1
1503	52,7
1504	53,4
1505	54,0
1506	54,5
1507	55,0
1508	55,6
1509	56,3
1510	57,2
1511	58,5
1512	60,2
1513	62,3
1514	64,7
1515	67,1
1516	69,2
1517	70,7
1518	71,9
1519	72,7
1520	73,4
1521	73,8
1522	74,1

Status: Point in time view as at 01/06/2017.

Changes to legislation: There are outstanding changes not yet made to Commission Regulation (EU) 2017/1151. Any changes that have already been made to the legislation appear in the content and are referenced with annotations. (See end of Document for details)

1523	74,0
1524	73,6
1525	72,5
1526	70,8
1527	68,6
1528	66,2
1529	64,0
1530	62,2
1531	60,9
1532	60,2
1533	60,0
1534	60,4
1535	61,4
1536	63,2
1537	65,6
1538	68,4
1539	71,6
1540	74,9
1541	78,4
1542	81,8
1543	84,9
1544	87,4
1545	89,0
1546	90,0
1547	90,6
1548	91,0
1549	91,5
1550	92,0
1551	92,7
1552	93,4
1553	94,2
1554	94,9
1555	95,7
1556	96,6

Status: Point in time view as at 01/06/2017.

Changes to legislation: There are outstanding changes not yet made to Commission Regulation (EU) 2017/1151. Any changes that have already been made to the legislation appear in the content and are referenced with annotations. (See end of Document for details)

1557	97,7
1558	98,9
1559	100,4
1560	102,0
1561	103,6
1562	105,2
1563	106,8
1564	108,5
1565	110,2
1566	111,9
1567	113,7
1568	115,3
1569	116,8
1570	118,2
1571	119,5
1572	120,7
1573	121,8
1574	122,6
1575	123,2
1576	123,6
1577	123,7
1578	123,6
1579	123,3
1580	123,0
1581	122,5
1582	122,1
1583	121,5
1584	120,8
1585	120,0
1586	119,1
1587	118,1
1588	117,1
1589	116,2
1590	115,5

Status: Point in time view as at 01/06/2017.

Changes to legislation: There are outstanding changes not yet made to Commission Regulation (EU) 2017/1151. Any changes that have already been made to the legislation appear in the content and are referenced with annotations. (See end of Document for details)

1591	114,9
1592	114,5
1593	114,1
1594	113,9
1595	113,7
1596	113,3
1597	112,9
1598	112,2
1599	111,4
1600	110,5
1601	109,5
1602	108,5
1603	107,7
1604	107,1
1605	106,6
1606	106,4
1607	106,2
1608	106,2
1609	106,2
1610	106,4
1611	106,5
1612	106,8
1613	107,2
1614	107,8
1615	108,5
1616	109,4
1617	110,5
1618	111,7
1619	113,0
1620	114,1
1621	115,1
1622	115,9
1623	116,5
1624	116,7

Status: Point in time view as at 01/06/2017.

Changes to legislation: There are outstanding changes not yet made to Commission Regulation (EU) 2017/1151. Any changes that have already been made to the legislation appear in the content and are referenced with annotations. (See end of Document for details)

1625	116,6
1626	116,2
1627	115,2
1628	113,8
1629	112,0
1630	110,1
1631	108,3
1632	107,0
1633	106,1
1634	105,8
1635	105,7
1636	105,7
1637	105,6
1638	105,3
1639	104,9
1640	104,4
1641	104,0
1642	103,8
1643	103,9
1644	104,4
1645	105,1
1646	106,1
1647	107,2
1648	108,5
1649	109,9
1650	111,3
1651	112,7
1652	113,9
1653	115,0
1654	116,0
1655	116,8
1656	117,6
1657	118,4
1658	119,2

Status: Point in time view as at 01/06/2017.

Changes to legislation: There are outstanding changes not yet made to Commission Regulation (EU) 2017/1151. Any changes that have already been made to the legislation appear in the content and are referenced with annotations. (See end of Document for details)

1659	120,0
1660	120,8
1661	121,6
1662	122,3
1663	123,1
1664	123,8
1665	124,4
1666	125,0
1667	125,4
1668	125,8
1669	126,1
1670	126,4
1671	126,6
1672	126,7
1673	126,8
1674	126,9
1675	126,9
1676	126,9
1677	126,8
1678	126,6
1679	126,3
1680	126,0
1681	125,7
1682	125,6
1683	125,6
1684	125,8
1685	126,2
1686	126,6
1687	127,0
1688	127,4
1689	127,6
1690	127,8
1691	127,9
1692	128,0

Status: Point in time view as at 01/06/2017.

Changes to legislation: There are outstanding changes not yet made to Commission Regulation (EU) 2017/1151. Any changes that have already been made to the legislation appear in the content and are referenced with annotations. (See end of Document for details)

1693	128,1
1694	128,2
1695	128,3
1696	128,4
1697	128,5
1698	128,6
1699	128,6
1700	128,5
1701	128,3
1702	128,1
1703	127,9
1704	127,6
1705	127,4
1706	127,2
1707	127,0
1708	126,9
1709	126,8
1710	126,7
1711	126,8
1712	126,9
1713	127,1
1714	127,4
1715	127,7
1716	128,1
1717	128,5
1718	129,0
1719	129,5
1720	130,1
1721	130,6
1722	131,0
1723	131,2
1724	131,3
1725	131,2
1726	130,7

Status: Point in time view as at 01/06/2017.

Changes to legislation: There are outstanding changes not yet made to Commission Regulation (EU) 2017/1151. Any changes that have already been made to the legislation appear in the content and are referenced with annotations. (See end of Document for details)

1727	129,8
1728	128,4
1729	126,5
1730	124,1
1731	121,6
1732	119,0
1733	116,5
1734	114,1
1735	111,8
1736	109,5
1737	107,1
1738	104,8
1739	102,5
1740	100,4
1741	98,6
1742	97,2
1743	95,9
1744	94,8
1745	93,8
1746	92,8
1747	91,8
1748	91,0
1749	90,2
1750	89,6
1751	89,1
1752	88,6
1753	88,1
1754	87,6
1755	87,1
1756	86,6
1757	86,1
1758	85,5
1759	85,0
1760	84,4

Status: Point in time view as at 01/06/2017.

Changes to legislation: There are outstanding changes not yet made to Commission Regulation (EU) 2017/1151. Any changes that have already been made to the legislation appear in the content and are referenced with annotations. (See end of Document for details)

1761	83,8
1762	83,2
1763	82,6
1764	82,0
1765	81,3
1766	80,4
1767	79,1
1768	77,4
1769	75,1
1770	72,3
1771	69,1
1772	65,9
1773	62,7
1774	59,7
1775	57,0
1776	54,6
1777	52,2
1778	49,7
1779	46,8
1780	43,5
1781	39,9
1782	36,4
1783	33,2
1784	30,5
1785	28,3
1786	26,3
1787	24,4
1788	22,5
1789	20,5
1790	18,2
1791	15,5
1792	12,3
1793	8,7
1794	5,2

Status: Point in time view as at 01/06/2017.

Changes to legislation: There are outstanding changes not yet made to Commission Regulation (EU) 2017/1151. Any changes that have already been made to the legislation appear in the content and are referenced with annotations. (See end of Document for details)

1795	0,0
1796	0,0
1797	0,0
1798	0,0
1799	0,0
1800	0,0

7. Cycle identification

In order to confirm if the correct cycle version was chosen or if the correct cycle was implemented into the test bench operation system, checksums of the vehicle speed values for cycle phases and the whole cycle are listed in Table A1/13.

TABLE A1/13

1Hz checksums

Vehicle class	Cycle phase	Checksum of 1 Hz target vehicle speeds
Class 1	Low	11 988,4
	Medium	17 162,8
	Total	29 151,2
Class 2	Low	11 162,2
	Medium	17 054,3
	High	24 450,6
	Extra High	28 869,8
	Total	81 536,9
Class 3-1	Low	11 140,3
	Medium	16 995,7
	High	25 646,0
	Extra High	29 714,9
	Total	83 496,9
Class 3-2	Low	11 140,3
	Medium	17 121,2
	High	25 782,2
	Extra High	29 714,9
	Total	83 758,6

8. Cycle modification

Status: Point in time view as at 01/06/2017.

Changes to legislation: There are outstanding changes not yet made to Commission Regulation (EU) 2017/1151. Any changes that have already been made to the legislation appear in the content and are referenced with annotations. (See end of Document for details)

Paragraph 8. of this Sub-Annex shall not apply to OVC-HEVs, NOVC-HEVs and NOVC-FCHVs.

8.1. General remarks

The cycle to be driven shall depend on the test vehicle's rated power to mass in running order ratio, W/kg, and its maximum velocity, v_{\max} , km/h.

Driveability problems may occur for vehicles with power to mass ratios close to the borderlines between Class 1 and Class 2, Class 2 and Class 3 vehicles, or very low powered vehicles in Class 1.

Since these problems are related mainly to cycle phases with a combination of high vehicle speed and high accelerations rather than to the maximum speed of the cycle, the downscaling procedure shall be applied to improve driveability.

8.2. This paragraph describes the method to modify the cycle profile using the downscaling procedure.

8.2.1. Downscaling procedure for Class 1 vehicles

Figure A1/14 shows a downscaled medium speed phase of the Class 1 WLTC as an example.
Figure A1/14

Downscaled medium speed phase of the class 1 WLTC

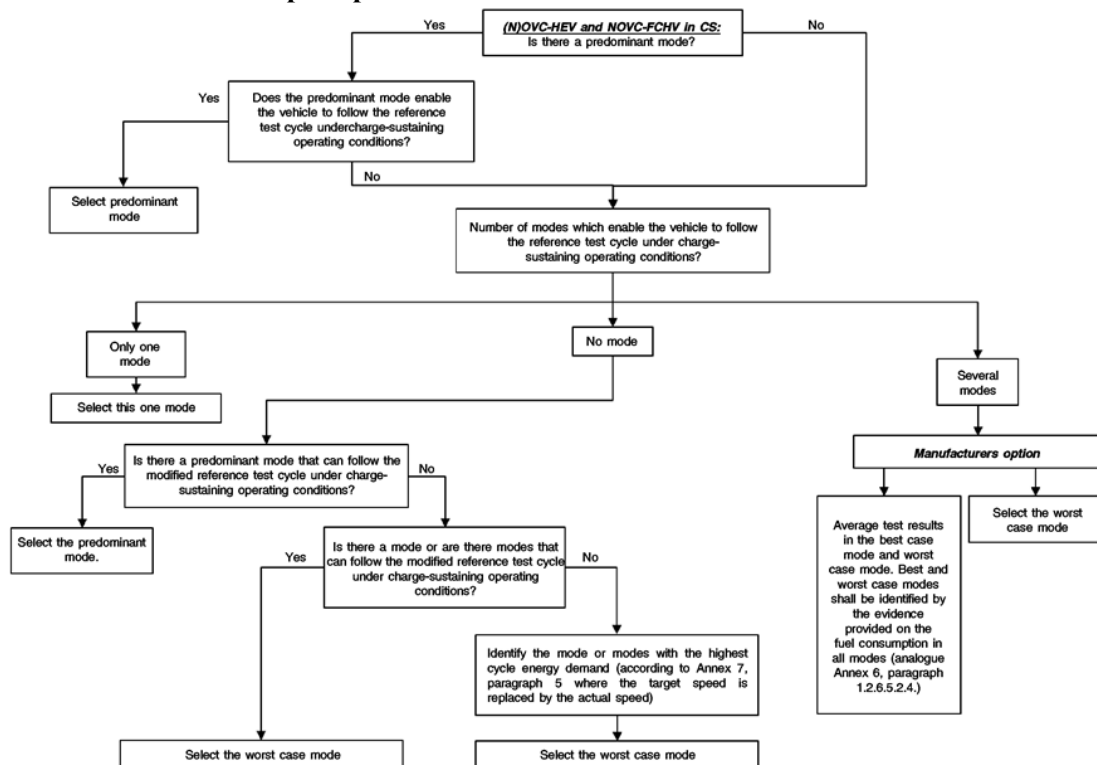

For the Class 1 cycle, the downscaling period is the time period between second 651 and second 906. Within this time period, the acceleration for the original cycle shall be calculated using the following equation:

$$a_{\text{orig}_i} = \frac{v_{i+1} - v_i}{3,6}$$

Status: Point in time view as at 01/06/2017.

Changes to legislation: There are outstanding changes not yet made to Commission Regulation (EU) 2017/1151. Any changes that have already been made to the legislation appear in the content and are referenced with annotations. (See end of Document for details)

where:

v_i is the vehicle speed, km/h;
 i is the time between second 651 and second 906.

The downscaling shall be applied first in the time period between second 651 and second 848. The downscaled speed trace shall be subsequently calculated using the following equation:

$$v_{disc_{i+1}} = v_{disc_i} + a_{orig_i} \times (1 - f_{disc}) \times 3,6$$

with $i = 651$ to 847.

For $i = 651$,

$$v_{disc_i} = v_{orig_i}$$

In order to meet the original vehicle speed at second 907, a correction factor for the deceleration shall be calculated using the following equation:

$$f_{corr_dec} = \frac{v_{disc_848} - 36,7}{v_{orig_848} - 36,7}$$

where 36,7 km/h is the original vehicle speed at second 907.

The downscaled vehicle speed between second 849 and second 906 shall be subsequently calculated using the following equation:

$$v_{disc_i} = v_{disc_{i-1}} + a_{orig_{i-1}} \times f_{corr_dec} \times 3,6$$

for $i = 849$ to 906.

8.2.2. Downscaling procedure for Class 2 vehicles

Since the driveability problems are exclusively related to the extra high speed phases of the Class 2 and Class 3 cycles, the downscaling is related to those paragraphs of the extra high speed phases where the driveability problems occur (see Figure A1/15).

Figure A1/15

Status: Point in time view as at 01/06/2017.

Changes to legislation: There are outstanding changes not yet made to Commission Regulation (EU) 2017/1151. Any changes that have already been made to the legislation appear in the content and are referenced with annotations. (See end of Document for details)

Downscaled extra high speed phase of the class 2 WLTC

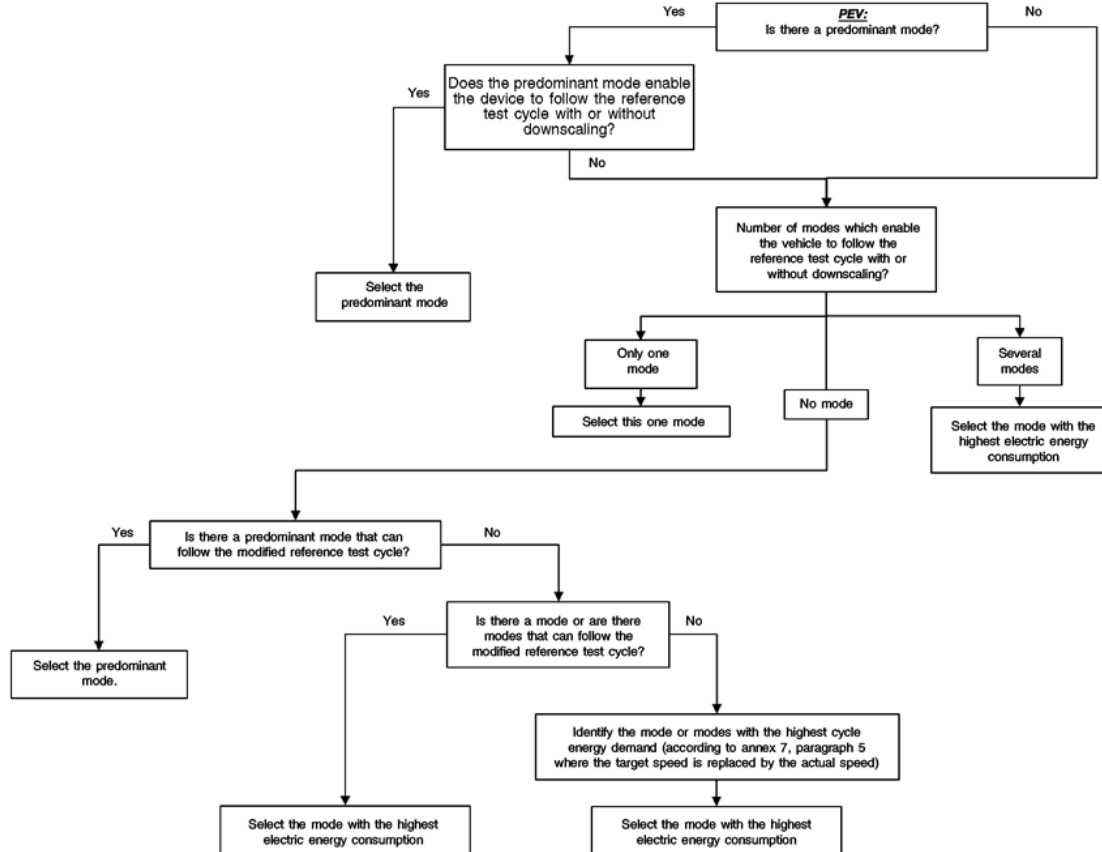

For the Class 2 cycle, the downscaling period is the time period between second 1520 and second 1742. Within this time period, the acceleration for the original cycle shall be calculated using the following equation:

$$a_{orig_i} = \frac{v_{i+1} - v_i}{3,6}$$

where:

v_i is the vehicle speed, km/h;

i is the time between second 1520 and second 1742.

The downscaling shall be applied first to the time period between second 1520 and second 1725. Second 1725 is the time when the maximum speed of the extra high speed phase is reached. The downscaled speed trace shall be subsequently calculated using the following equation:

$$v_{disc_{i+1}} = v_{disc_i} + a_{orig_i} \times (1 - f_{disc}) \times 3,6$$

for $i = 1520$ to 1724.

For $i = 1520$,

$$v_{disc_i} = v_{orig_i}$$

In order to meet the original vehicle speed at second 1743, a correction factor for the deceleration shall be calculated using the following equation:

$$f_{corr_dec} = \frac{v_{disc_1725} - 90,4}{v_{orig_1725} - 90,4}$$

90,4 km/h is the original vehicle speed at second 1743.

Status: Point in time view as at 01/06/2017.

Changes to legislation: There are outstanding changes not yet made to Commission Regulation (EU) 2017/1151. Any changes that have already been made to the legislation appear in the content and are referenced with annotations. (See end of Document for details)

The downscaled vehicle speed between second 1726 and second 1742 shall be calculated using the following equation:

$$v_{disc_i} = v_{disc_{i-1}} + a_{orig_{i-1}} \times f_{corr_dec} \times 3,6$$

for $i = 1726$ to 1742 .

8.2.3. Downscaling procedure for Class 3 vehicles

Figure A1/16 shows a downscaled extra high speed phase of the Class 3 WLTC as an example. *Figure A1/16*

Downscaled extra high speed phase of the class 3 WLTC

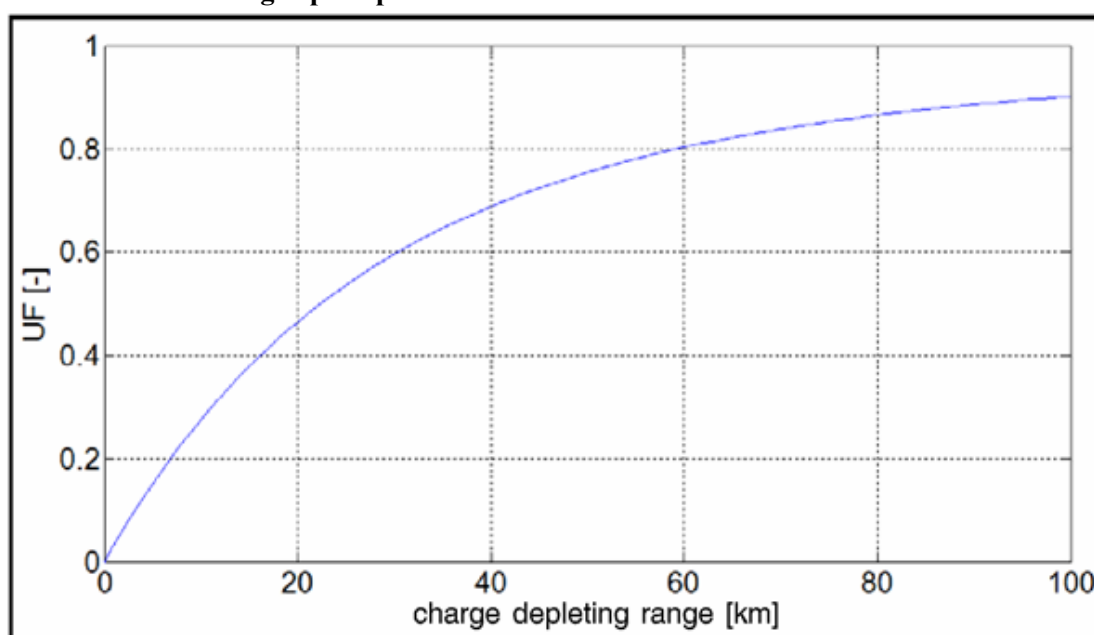

For the Class 3 cycle, the downscaling period is the time period between second 1533 and second 1762. Within this time period, the acceleration for the original cycle shall be calculated using the following equation:

$$a_{orig_i} = \frac{v_{i+1} - v_i}{3,6}$$

where:

- v_i is the vehicle speed, km/h;
- i is the time between second 1533 and second 1762.

The downscaling shall be applied first in the time period between second 1533 and second 1724. Second 1724 is the time when the maximum speed of the extra high speed phase is reached. The downscaled speed trace shall be subsequently calculated using the following equation:

$$v_{disc_{i+1}} = v_{disc_i} + a_{orig_i} \times (1 - f_{disc}) \times 3,6$$

for $i = 1533$ to 1723 .

For $i = 1533$,

$$v_{disc_i} = v_{orig_i}$$

In order to meet the original vehicle speed at second 1763, a correction factor for the deceleration shall be calculated using the following equation:

Status: Point in time view as at 01/06/2017.

Changes to legislation: There are outstanding changes not yet made to Commission Regulation (EU) 2017/1151. Any changes that have already been made to the legislation appear in the content and are referenced with annotations. (See end of Document for details)

$$f_{\text{corr_dec}} = \frac{v_{\text{dec},1724} - 82,6}{v_{\text{orig},1724} - 82,6}$$

82.6 km/h is the original vehicle speed at second 1763.

The downscaled vehicle speed between second 1725 and second 1762 shall be subsequently calculated using the following equation:

$$v_{\text{disc}_i} = v_{\text{disc}_{i-1}} + a_{\text{orig}_{i-1}} \times f_{\text{corr_dec}} \times 3,6$$

for $i = 1725$ to 1762 .

8.3. Determination of the downscaling factor

The downscaling factor f_{dsc} , is a function of the ratio r_{max} between the maximum required power of the cycle phases where the downscaling is to be applied and the rated power of the vehicle, P_{rated} .

The maximum required power $P_{\text{req,max},i}$ (in kW) is related to a specific time i and the corresponding vehicle speed v_i in the cycle trace and is calculated using the following equation:

$$P_{\text{req,max},i} = \frac{((f_0 \times v_i) + (f_1 \times v_i^2) + (f_2 \times v_i^3) + (1,03 \times \text{TM} \times v_i \times a_i))}{3600}$$

where:

f_0, f_1, f_2 are the applicable road load coefficients, N, N/(km/h), and N/(km/h)² respectively;
 TM is the applicable test mass, kg;
 v_i is the speed at time i , km/h.

The cycle time i at which maximum power or power values close to maximum power is required, is: second 764 for Class 1, second 1574 for Class 2 and second 1566 for Class 3 vehicles.

The corresponding vehicle speed values, v_i , and acceleration values, a_i , are as follows:

$$v_i = 61,4 \text{ km/h}, a_i = 0,22 \text{ m/s}^2 \text{ for Class 1,}$$

$$v_i = 109,9 \text{ km/h}, a_i = 0,36 \text{ m/s}^2 \text{ for Class 2,}$$

$$v_i = 111,9 \text{ km/h}, a_i = 0,50 \text{ m/s}^2 \text{ for Class 3.}$$

r_{max} shall be calculated using the following equation:

$$r_{\text{max}} = \frac{P_{\text{req,max},i}}{P_{\text{rated}}}$$

The downscaling factor, f_{dsc} , shall be calculated using the following equations:

if

$$r_{\text{max}} < r_0$$

, then

$$f_{\text{dsc}} = 0$$

and no downscaling shall be applied.

If

$$r_{\text{max}} \geq r_0$$

, then

$$f_{\text{dsc}} = a_1 \times r_{\text{max}} + b_1$$

The calculation parameter/coefficients, r_0 , a_1 and b_1 , are as follows:

Status: Point in time view as at 01/06/2017.

Changes to legislation: There are outstanding changes not yet made to Commission Regulation (EU) 2017/1151. Any changes that have already been made to the legislation appear in the content and are referenced with annotations. (See end of Document for details)

Class 1 $r_0 = 0,978$, $a_1 = 0,680$, $b_1 = -0,665$

Class 2 $r_0 = 0,866$, $a_1 = 0,606$, $b_1 = -0,525$.

Class 3 $r_0 = 0,867$, $a_1 = 0,588$, $b_1 = -0,510$.

The resulting f_{dsc} is mathematically rounded to 3 places of decimal and is applied only if it exceeds 0,010.

The following data shall be included in all relevant test reports:

- (a) f_{dsc} ;
- (b) v_{max} ;
- (c) distance driven, m.

The distance shall be calculated as the sum of v_i in km/h divided by 3,6 over the whole cycle trace.

8.4. Additional requirements

For different vehicle configurations in terms of test mass and driving resistance coefficients, downscaling shall be applied individually.

If, after the application of downscaling the vehicle maximum speed is lower than the maximum speed of the cycle, the process described in paragraph 9. of this Sub-Annex shall be applied with the applicable cycle.

If the vehicle cannot follow the speed trace of the applicable cycle within the tolerance at speeds lower than its maximum speed, it shall be driven with the accelerator control fully activated during these periods. During such periods of operation, speed trace violations shall be permitted.

9. Cycle modifications for vehicles with a maximum speed lower than the maximum speed of the cycle specified in the previous paragraphs of this Sub-Annex

9.1. General remarks

This paragraph applies to vehicles that are technically able to follow the speed trace of the cycle specified in paragraph 1. of this Sub-Annex (base cycle or downscaled base cycle) at speeds lower than their maximum speed, but whose maximum speed is lower than the maximum speed of the cycle. The maximum speed of such a vehicle shall be referred to as its capped speed v_{cap} . The maximum speed of the base cycle shall be referred to as $v_{max,cycle}$.

In such cases the base cycle shall be modified as described in paragraph 9.2. in order to achieve the same cycle distance for the capped speed cycle as for the base cycle.

9.2. Calculation steps

9.2.1. Determination of the distance difference per cycle phase

An interim capped speed cycle shall be derived by replacing all vehicle speed samples v_i where $v_i > v_{cap}$ by v_{cap} .

9.2.1.1. If $v_{cap} < v_{max,medium}$, the distances of the medium speed phases of the base cycle $d_{base,medium}$ and the interim capped speed cycle $d_{cap,medium}$ shall be calculated using the following equation for both cycles:

$$d_{medium} = \sum \left(\frac{(v_i + v_{i-1})}{2 \times 3,6} \times (t_i - t_{i-1}), \text{ for } i = 591 \text{ to } 1022 \right)$$

Status: Point in time view as at 01/06/2017.

Changes to legislation: There are outstanding changes not yet made to Commission Regulation (EU) 2017/1151. Any changes that have already been made to the legislation appear in the content and are referenced with annotations. (See end of Document for details)

where:

$v_{\max, \text{medium}}$ is the maximum vehicle speed of the medium speed phase as listed in Table A1/2 for class 1 vehicles, in Table A1/4 for class 2 vehicles, in Table A1/8 for class 3a vehicles and in Table A1/9 for class 3b vehicles.

9.2.1.2. If $v_{\text{cap}} < v_{\max, \text{high}}$, the distances of the high speed phases of the base cycle $d_{\text{base, high}}$ and the interim capped speed cycle $d_{\text{cap, high}}$ shall be calculated using the following equation for both cycles:

$$d_{\text{high}} = \sum \left(\frac{(v_i + v_{i-1})}{2 \times 3,6} \times (t_i - t_{i-1}), \text{ for } i = 1\ 024 \text{ to } 1\ 477 \right)$$

$v_{\max, \text{high}}$ is the maximum vehicle speed of the high speed phase as listed in Table A1/5 for Class 2 vehicles, in Table A1/10 for Class 3a vehicles and in Table A1/11 for Class 3b vehicles.

9.2.1.3. The distances of the extra high speed phase of the base cycle $d_{\text{base, exhigh}}$ and the interim capped speed cycle $d_{\text{cap, exhigh}}$ shall be calculated applying the following equation to the extra high speed phase of both cycles:

$$d_{\text{exhigh}} = \sum \left(\frac{(v_i + v_{i-1})}{2 \times 3,6} \times (t_i - t_{i-1}), \text{ for } i = 1\ 479 \text{ to } 1\ 800 \right)$$

9.2.2. Determination of the time periods to be added to the interim capped speed cycle in order to compensate for distance differences

In order to compensate for a difference in distance between the base cycle and the interim capped speed cycle, corresponding time periods with $v_i = v_{\text{cap}}$ shall be added to the interim capped speed cycle as described in the following paragraphs.

9.2.2.1. Additional time period for the medium speed phase

If $v_{\text{cap}} < v_{\max, \text{medium}}$, the additional time period to be added to the medium speed phase of the interim capped speed cycle shall be calculated using the following equation:

$$\Delta t_{\text{medium}} = \frac{(d_{\text{base, medium}} - d_{\text{cap, medium}})}{v_{\text{cap}}} \times 3,6$$

The number of time samples $n_{\text{add, medium}}$ with $v_i = v_{\text{cap}}$ to be added to the medium speed phase of the interim capped speed cycle equals Δt_{medium} , mathematically rounded to the nearest integer (e.g. 1.4 shall be rounded to 1, 1.5 shall be rounded to 2).

9.2.2.2. Additional time period for the high speed phase

If $v_{\text{cap}} < v_{\max, \text{high}}$, the additional time period to be added to the high speed phases of the interim capped speed cycle shall be calculated using the following equation:

$$\Delta t_{\text{high}} = \frac{(d_{\text{base, high}} - d_{\text{cap, high}})}{v_{\text{cap}}} \times 3,6$$

The number of time samples $n_{\text{add, high}}$ with $v_i = v_{\text{cap}}$ to be added to the high speed phase of the interim capped speed cycle equals Δt_{high} , mathematically rounded to the nearest integer.

9.2.2.3. The additional time period to be added to the extra high speed phase of the interim capped speed cycle shall be calculated using the following equation:

$$\Delta t_{\text{exhigh}} = \frac{(d_{\text{base, exhigh}} - d_{\text{cap, exhigh}})}{v_{\text{cap}}} \times 3,6$$

The number of time samples $n_{\text{add, exhigh}}$ with $v_i = v_{\text{cap}}$ to be added to the extra high speed phase of the interim capped speed cycle equals Δt_{exhigh} , mathematically rounded to the nearest integer.

9.2.3. Construction of the final capped speed cycle

Status: Point in time view as at 01/06/2017.

Changes to legislation: There are outstanding changes not yet made to Commission Regulation (EU) 2017/1151. Any changes that have already been made to the legislation appear in the content and are referenced with annotations. (See end of Document for details)

9.2.3.1. Class 1 vehicles

The first part of the final capped speed cycle consists of the vehicle speed trace of the interim capped speed cycle up to the last sample in the medium speed phase where $v = v_{\text{cap}}$. The time of this sample is referred to as t_{medium} .

Then $n_{\text{add,medium}}$ samples with $v_i = v_{\text{cap}}$ shall be added, so that the time of the last sample is $(t_{\text{medium}} + n_{\text{add,medium}})$.

The remaining part of the medium speed phase of the interim capped speed cycle, which is identical with the same part of the base cycle, shall then be added, so that the time of the last sample is $(1022 + n_{\text{add,medium}})$.

9.2.3.2. Class 2 and class 3 vehicles

9.2.3.2.1. $v_{\text{cap}} < v_{\text{max,medium}}$

The first part of the final capped speed cycle consists of the vehicle speed trace of the interim capped speed cycle up to the last sample in the medium speed phase where $v = v_{\text{cap}}$. The time of this sample is referred to as t_{medium} .

Then $n_{\text{add,medium}}$ samples with $v_i = v_{\text{cap}}$ shall be added, so that the time of the last sample is $(t_{\text{medium}} + n_{\text{add,medium}})$.

The remaining part of the medium speed phase of the interim capped speed cycle, which is identical with the same part of the base cycle, shall then be added, so that the time of the last sample is $(1022 + n_{\text{add,medium}})$.

In a next step, the first part of the high speed phase of the interim capped speed cycle up to the last sample in the high speed phase where $v = v_{\text{cap}}$ shall be added. The time of this sample in the interim capped speed is referred to as t_{high} , so that the time of this sample in the final capped speed cycle is $(t_{\text{high}} + n_{\text{add,medium}})$.

Then, $n_{\text{add,high}}$ samples with $v_i = v_{\text{cap}}$ shall be added, so that the time of the last sample becomes $(t_{\text{high}} + n_{\text{add,medium}} + n_{\text{add,high}})$.

The remaining part of the high speed phase of the interim capped speed cycle, which is identical with the same part of the base cycle, shall then be added, so that the time of the last sample is $(1477 + n_{\text{add,medium}} + n_{\text{add,high}})$.

In a next step, the first part of the extra high speed phase of the interim capped speed cycle up to the last sample in the extra high speed phase where $v = v_{\text{cap}}$ shall be added. The time of this sample in the interim capped speed is referred to as t_{exhigh} , so that the time of this sample in the final capped speed cycle is $(t_{\text{exhigh}} + n_{\text{add,medium}} + n_{\text{add,high}})$.

Then $n_{\text{add,exhigh}}$ samples with $v_i = v_{\text{cap}}$ shall be added, so that the time of the last sample is $(t_{\text{exhigh}} + n_{\text{add,medium}} + n_{\text{add,high}} + n_{\text{add,exhigh}})$.

The remaining part of the extra high speed phase of the interim capped speed cycle, which is identical with the same part of the base cycle, shall then be added, so that the time of the last sample is $(1800 + n_{\text{add,medium}} + n_{\text{add,high}} + n_{\text{add,exhigh}})$.

The length of the final capped speed cycle is equivalent to the length of the base cycle except for differences caused by the rounding process for $n_{\text{add,medium}}$, $n_{\text{add,high}}$ and $n_{\text{add,exhigh}}$.

Status: Point in time view as at 01/06/2017.

Changes to legislation: There are outstanding changes not yet made to Commission Regulation (EU) 2017/1151. Any changes that have already been made to the legislation appear in the content and are referenced with annotations. (See end of Document for details)

9.2.3.2.2. $v_{\max, \text{medium}} \leq v_{\text{cap}} < v_{\max, \text{high}}$

The first part of the final capped speed cycle consists of the vehicle speed trace of the interim capped speed cycle up to the last sample in the high speed phase where $v = v_{\text{cap}}$. The time of this sample is referred to as t_{high} .

Then, $n_{\text{add,high}}$ samples with $v_i = v_{\text{cap}}$ shall be added, so that the time of the last sample is $(t_{\text{high}} + n_{\text{add,high}})$.

The remaining part of the high speed phase of the interim capped speed cycle, which is identical with the same part of the base cycle, shall then be added, so that the time of the last sample is $(1477 + n_{\text{add,high}})$.

In a next step, the first part of the extra high speed phase of the interim capped speed cycle up to the last sample in the extra high speed phase where $v = v_{\text{cap}}$ shall be added. The time of this sample in the interim capped speed is referred to as t_{exhigh} , so that the time of this sample in the final capped speed cycle is $(t_{\text{exhigh}} + n_{\text{add,high}})$.

Then $n_{\text{add,exhigh}}$ samples with $v_i = v_{\text{cap}}$ shall be added, so that the time of the last sample is $(t_{\text{exhigh}} + n_{\text{add,high}} + n_{\text{add,exhigh}})$.

The remaining part of the extra high speed phase of the interim capped speed cycle, which is identical with the same part of the base cycle, shall then be added, so that the time of the last sample is $(1800 + n_{\text{add,high}} + n_{\text{add,exhigh}})$.

The length of the final capped speed cycle is equivalent to the length of the base cycle except for differences caused by the rounding process for $n_{\text{add,high}}$ and $n_{\text{add,exhigh}}$.

9.2.3.2.3. $v_{\max, \text{high}} \leq v_{\text{cap}} < v_{\max, \text{exhigh}}$

The first part of the final capped speed cycle consists of the vehicle speed trace of the interim capped speed cycle up to the last sample in the extra high speed phase where $v = v_{\text{cap}}$. The time of this sample is referred to as t_{exhigh} .

Then, $n_{\text{add,exhigh}}$ samples with $v_i = v_{\text{cap}}$ shall be added, so that the time of the last sample is $(t_{\text{exhigh}} + n_{\text{add,exhigh}})$.

The remaining part of the extra high speed phase of the interim capped speed cycle, which is identical with the same part of the base cycle, shall then be added, so that the time of the last sample is $(1800 + n_{\text{add,exhigh}})$.

The length of the final capped speed cycle is equivalent to the length of the base cycle except for differences caused by the rounding process for $n_{\text{add,exhigh}}$.

Sub-Annex 2

Gear selection and shift point determination for vehicles equipped with manual transmissions

1. General approach
 - 1.1. The shifting procedures described in this Sub-Annex shall apply to vehicles equipped with manual shift transmissions.

Status: Point in time view as at 01/06/2017.

Changes to legislation: There are outstanding changes not yet made to Commission Regulation (EU) 2017/1151. Any changes that have already been made to the legislation appear in the content and are referenced with annotations. (See end of Document for details)

- 1.2. The prescribed gears and shifting points are based on the balance between the power required to overcome driving resistance and acceleration, and the power provided by the engine in all possible gears at a specific cycle phase.
- 1.3. The calculation to determine the gears to use shall be based on engine speeds and full load power curves versus engine speed.
- 1.4. For vehicles equipped with a dual-range transmission (low and high), only the range designed for normal on-road operation shall be considered for gear use determination.
- 1.5. The prescriptions for the clutch operation shall not be applied if the clutch is operated automatically without the need of an engagement or disengagement of the driver.
- 1.6. This Sub-Annex shall not apply to vehicles tested according to Sub-Annex 8.
2. Required data and precalculations

The following data are required and calculations shall be performed in order to determine the gears to be used when driving the cycle on a chassis dynamometer:

- (a) P_{rated} , the maximum rated engine power as declared by the manufacturer, kW;
- (b) n_{rated} , the rated engine speed at which an engine develops its maximum power. If the maximum power is developed over an engine speed range, n_{rated} shall be the minimum of this range, min^{-1} ;
- (c) n_{idle} , idling speed, min^{-1} ;

n_{idle} shall be measured over a period of at least 1 minute at a sampling rate of at least 1 Hz with the engine running in warm condition, the gear lever placed in neutral, and the clutch engaged. The conditions for temperature, peripheral and auxiliary devices, etc. shall be the same as described in Sub-Annex 6 for the Type 1 test.

The value to be used in this Sub-Annex shall be the arithmetic average over the measuring period, rounded or truncated to the nearest 10 min^{-1} ;

- (d) n_{g} , the number of forward gears;
The forward gears in the transmission range designed for normal on-road operation shall be numbered in descending order of the ratio between engine speed in min^{-1} and vehicle speed in km/h. Gear 1 is the gear with the highest ratio, gear n_{g} is the gear with the lowest ratio. n_{g} determines the number of forward gears.
- (e) ndv_i , the ratio obtained by dividing the engine speed n by the vehicle speed v for each gear i , for i to $n_{\text{g}_{\text{max}}}$, $\text{min}^{-1}/(\text{km/h})$;
- (f) f_0 , f_1 , f_2 , road load coefficients selected for testing, N, N/(km/h), and $\text{N}/(\text{km/h})^2$ respectively;
- (g) n_{max}

$n_{\text{max}_{95}}$, the minimum engine speed where 95 per cent of rated power is reached, min^{-1} ;

If $n_{\text{max}_{95}}$ is less than 65 per cent of n_{rated} , $n_{\text{max}_{95}}$ shall be set to 65 per cent of n_{rated} .

If 65 per cent of

Status: Point in time view as at 01/06/2017.

Changes to legislation: There are outstanding changes not yet made to Commission Regulation (EU) 2017/1151. Any changes that have already been made to the legislation appear in the content and are referenced with annotations. (See end of Document for details)

$$(n_{\text{rated}} \times \text{ndv}_3 / \text{ndv}_2) < 1,1 \times (n_{\text{idle}} + 0,125 \times (n_{\text{rated}} - n_{\text{idle}}))$$

, $n_{\text{max_95}}$ shall be set to:

$$1,1 \times (n_{\text{idle}} + 0,125 \times (n_{\text{rated}} - n_{\text{idle}})) \times \text{ndv}_2 / \text{ndv}_3$$

$$n_{\text{max}}(ng_{\text{vmax}}) = \text{ndv}(ng_{\text{vmax}}) \times v_{\text{max,cycle}}$$

where:

ng_{vmax} is defined in paragraph 2(i) of this Sub-Annex.;

$v_{\text{max,cycle}}$ is the maximum speed of the vehicle speed trace according to Sub-Annex 1, km/h;

n_{max} is the maximum of $n_{\text{max_95}}$ and $n_{\text{max}}(ng_{\text{vmax}})$, min^{-1} .

- (h) $P_{\text{wot}}(n)$, the full load power curve over the engine speed range from n_{idle} to n_{rated} or n_{max} , or $\text{ndv}(ng_{\text{vmax}}) \times v_{\text{max}}$, whichever is higher.

$\text{ndv}(ng_{\text{vmax}})$ is the ratio obtained by dividing the engine speed n by the vehicle speed v for the gear ng_{vmax} , $\text{min}^{-1}/\text{km/h}$;

The power curve shall consist of a sufficient number of data sets (n , P_{wot}) so that the calculation of interim points between consecutive data sets can be performed by linear interpolation. Deviation of the linear interpolation from the full load power curve according to Annex XX shall not exceed 2 per cent. The first data set shall be at n_{idle} or lower. Data sets need not be spaced equally. The full load power at engine speeds not covered by Annex XX (e.g. n_{idle}) shall be determined according to the method described in Annex XX.

- (i) ng_{vmax}

ng_{vmax} , the gear in which the maximum vehicle speed is reached and shall be determined as follows:

If $v_{\text{max}}(ng) \geq v_{\text{max}}(ng-1)$, then,

$$ng_{\text{vmax}} = ng$$

otherwise, $ng_{\text{vmax}} = ng-1$

where:

$v_{\text{max}}(ng)$ is the vehicle speed at which the required road load power equals the available power, P_{wot} , in gear ng (see Figure A2/1a).

$v_{\text{max}}(ng-1)$ is the vehicle speed at which the required road load power equals the available power, P_{wot} , in the next lower gear (see Figure A2/1b).

The required road load power, kW, shall be calculated using the following equation:

$$P_{\text{required}} = \frac{f_0 \times v_{\text{max}} + f_1 \times v_{\text{max}}^2 + f_2 \times v_{\text{max}}^3}{3600}$$

where:

v_{max} is the vehicle speed, km/h.

The available power at vehicle speed v_{max} in gear ng or gear $ng - 1$ may be determined from the full load power curve, $P_{\text{wot}}(n)$, by using the following equation:

Status: Point in time view as at 01/06/2017.

Changes to legislation: There are outstanding changes not yet made to Commission Regulation (EU) 2017/1151. Any changes that have already been made to the legislation appear in the content and are referenced with annotations. (See end of Document for details)

$$n_{ng} = ndv_{ng} \times v_{max}(ng); n_{ng-1} = ndv_{ng-1} \times v_{max}(ng - 1)$$

and by reducing the power values of the full load power curve by 10 per cent.

Figure A2/1a

An example where ng_{max} is the highest gear

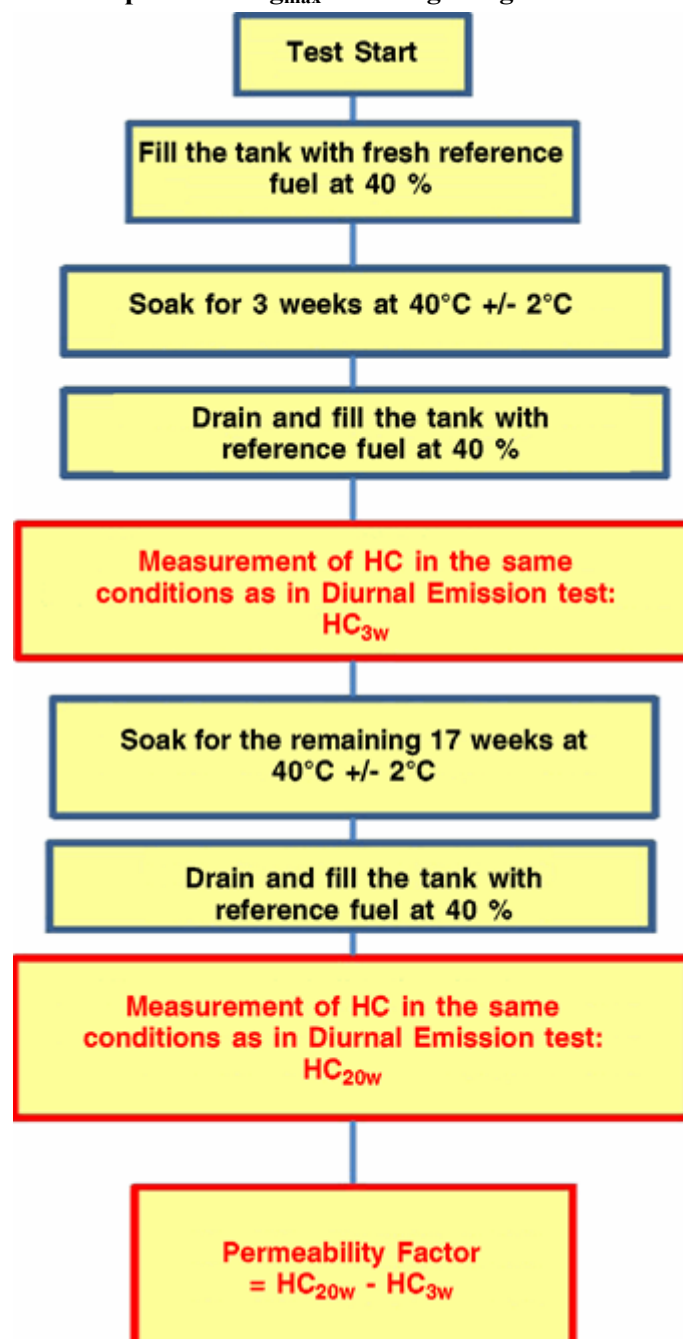
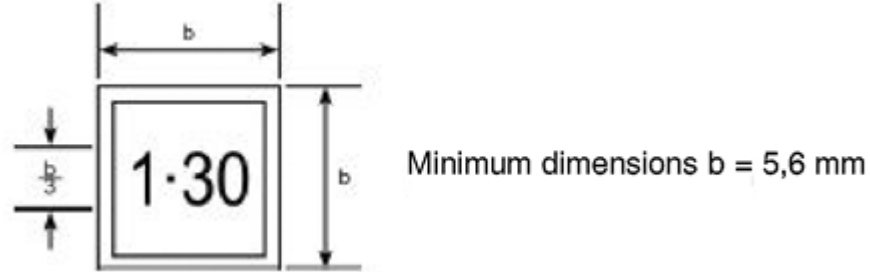

Figure A2/1b

Status: Point in time view as at 01/06/2017.

Changes to legislation: There are outstanding changes not yet made to Commission Regulation (EU) 2017/1151. Any changes that have already been made to the legislation appear in the content and are referenced with annotations. (See end of Document for details)

An example where ng_{\max} is the 2nd highest gear



(j) Exclusion of a crawler gear

Gear 1 may be excluded at the request of the manufacturer if all of the following conditions are fulfilled:

- (1) The vehicle does not have a dual-range transmission;
- (2) The vehicle family is homologated to tow a trailer;
- (3) $(ndv_1 / ndv(ng_{v\max})) \times (v_{\max} \times ndv(ng_{v\max}) / n_{rated}) > 7$;
- (4) $(ndv_2 / ndv(ng_{v\max})) \times (v_{\max} \times ndv(ng_{v\max}) / n_{rated}) > 4$;
- (5) The vehicle, having a mass as defined in the equation below, shall be able to pull away from standstill within 4 seconds, on an uphill gradient of at least 12 per cent, on five separate occasions within a period of 5 minutes.

$$m_r + 25 \text{ kg} + (MC - m_r - 25 \text{ kg}) \times 0,28 \text{ (0,15 in the case of category M vehicles).}$$

where:

$ndv(ng_{v\max})$	is the ratio obtained by dividing the engine speed n by the vehicle speed v for gear $ng_{v\max}$, $\text{min}_{-1}/\text{km/h}$;
m_r	is the mass in running order, kg;
MC	is the gross train mass (gross vehicle mass + max. trailer mass), kg.

In this case, gear 1 is not used when driving the cycle on a chassis dynamometer and the gears shall be renumbered starting with the 2nd gear as gear 1.

(k) Definition of n_{\min_drive}

n_{\min_drive} is the minimum engine speed when the vehicle is in motion, min^{-1} ;

For $n_{\text{gear}} = 1$, $n_{\min_drive} = n_{\text{idle}}$,

For $n_{\text{gear}} = 2$,

- (a) for transitions from 1st to 2nd gear:

$$n_{\min_drive} = 1,15 \times n_{\text{idle}},$$

- (b) for decelerations to standstill:

$$n_{\min_drive} = n_{\text{idle}}.$$

Status: Point in time view as at 01/06/2017.

Changes to legislation: There are outstanding changes not yet made to Commission Regulation (EU) 2017/1151. Any changes that have already been made to the legislation appear in the content and are referenced with annotations. (See end of Document for details)

(c) for all other driving conditions:

$$n_{\min_drive} = 0,9 \times n_{idle}.$$

For $n_{gear} > 2$, n_{\min_drive} shall be determined by:

$$n_{\min_drive} = n_{idle} + 0,125 \times (n_{rated} - n_{idle}).$$

The final result for n_{\min_drive} shall be rounded to the nearest integer. Example: 1 199,5 becomes 1 200, 1 199,4 becomes 1 199.

Higher values may be used if requested by the manufacturer.

(l) TM, test mass of the vehicle, kg.

3. Calculations of required power, engine speeds, available power, and possible gear to be used

3.1. Calculation of required power

For each second j of the cycle trace, the power required to overcome driving resistance and to accelerate shall be calculated using the following equation:

$$P_{required,j} = \left(\frac{f_0 \times v_j + f_1 \times v_j^2 + f_2 \times v_j^3}{3600} \right) + \frac{kr \times a_j \times v_j \times TM}{3600}$$

where:

$P_{required,j}$ is the required power at second j , kW;

a_j is the vehicle acceleration at second j , m/s^2 ,

$$a_j = \frac{(v_{j+1} - v_j)}{3,6 \times (t_{j+1} - t_j)}$$

kr is a factor taking the inertial resistances of the drivetrain during acceleration into account and is set to 1,03.

3.2. Determination of engine speeds

For any $v_j < 1$ km/h, it shall be assumed that the vehicle is standing still and the engine speed shall be set to. The gear lever shall be placed in neutral with the clutch engaged except 1 second before beginning an acceleration from standstill where first gear shall be selected with the clutch disengaged.

For each $v_j \geq 1$ km/h of the cycle trace and each gear i , $i = 1$ to ng_{vmax} , the engine speed, $n_{i,j}$, shall be calculated using the following equation:

$$n_{i,j} = ndv_i \times v_j$$

3.3. Selection of possible gears with respect to engine speed

The following gears may be selected for driving the speed trace at v_j :

(a) all gears $i < ng_{vmax}$ where $n_{\min_drive} \leq n_{i,j} \leq n_{max_95}$,

(b) all gears $i \geq ng_{vmax}$ where $n_{\min_drive} \leq n_{i,j} \leq n_{max}(ng_{vmax})$

(c) gear 1, if $n_{1,j} < n_{\min_drive}$.

If $a_j \leq 0$ and $n_{i,j} \leq n_{idle}$, $n_{i,j}$ shall be set to n_{idle} and the clutch shall be disengaged.

Status: Point in time view as at 01/06/2017.

Changes to legislation: There are outstanding changes not yet made to Commission Regulation (EU) 2017/1151. Any changes that have already been made to the legislation appear in the content and are referenced with annotations. (See end of Document for details)

If $a_j > 0$ and $n_{i,j} \leq (1,15 \times n_{idle})$, $n_{i,j}$ shall be set to $(1,15 \times n_{idle})$ and the clutch shall be disengaged.

3.4. Calculation of available power

The available power for each possible gear i and each vehicle speed value of the cycle trace, shall be calculated using the following equation:

$$P_{available_i,j} = P_{wot}(n_{i,j}) \times (1 - (SM + ASM))$$

where:

P_{rated}	is the rated power, kW;
P_{wot}	is the power available at $n_{i,j}$ at full load condition from the full load power curve;
SM	is a safety margin accounting for the difference between the stationary full load condition power curve and the power available during transition conditions. SM is set to 10 per cent;
ASM	is an additional exponential power safety margin, which may be applied at the request of the manufacturer. ASM is fully effective between n_{idle} and n_{start} , and approaches zero exponentially at n_{end} as described by the following requirements:

If $n_{i,j} \leq n_{start}$, then $ASM = ASM_0$;

If $n_{i,j} > n_{start}$, then:

$$ASM = ASM_0 \times \exp(\ln(0,005 / ASM_0) \times (n_{start} - n) / (n_{start} - n_{end}))$$

ASM_0 , n_{start} and n_{end} shall be defined by the manufacturer but shall fulfil the following conditions:

$$n_{start} \geq n_{idle},$$

$$n_{end} > n_{start}.$$

If $a_j > 0$ and $i = 1$ or $i = 2$ and $P_{available_i,i} < P_{required,j}$, $n_{i,j}$ shall be increased by increments of 1 min^{-1} until $P_{available_i,i} = P_{required,j}$, and the clutch shall be disengaged.

3.5. Determination of possible gears to be used

The possible gears to be used shall be determined by the following conditions:

- The conditions of paragraph 3.3. are fulfilled, and
- $P_{available_i,i} \geq P_{required,j}$

The initial gear to be used for each second of the cycle trace is the highest final possible gear, i_{max} . When starting from standstill, only the first gear shall be used.

The lowest final possible gear is i_{min} .

4. Additional requirements for corrections and/or modifications of gear use

The initial gear selection shall be checked and modified in order to avoid too frequent gearshifts and to ensure driveability and practicality.

An acceleration phase is a time period of more than 3 seconds with a vehicle speed $\geq 1 \text{ km/h}$ and with monotonic increase of vehicle speed. A deceleration phase is a time period of more than 3 seconds with a vehicle speed $\geq 1 \text{ km/h}$ and with monotonic decrease of vehicle speed.

Status: Point in time view as at 01/06/2017.

Changes to legislation: There are outstanding changes not yet made to Commission Regulation (EU) 2017/1151. Any changes that have already been made to the legislation appear in the content and are referenced with annotations. (See end of Document for details)

Corrections and/or modifications shall be made according to the following requirements:

- (a) If a lower gear is required at a higher vehicle speed during an acceleration phase, the higher gears before shall be corrected to the lower gear.

Example: $v_j < v_{j+1} < v_{j+2} < v_{j+3} < v_{j+4} < v_{j+5} < v_{j+6}$. The original calculated gear use is 2, 3, 3, 3, 2, 2, 3. In this case the gear use shall be corrected to 2, 2, 2, 2, 2, 2, 3.

- (b) Gears used during accelerations shall be used for a period of at least 2 seconds (e.g. a gear sequence 1, 2, 3, 3, 3, 3, 3 shall be replaced by 1, 1, 2, 2, 3, 3, 3). Gears shall not be skipped during acceleration phases.

- (c) During a deceleration phase, gears with $n_{\text{gear}} > 2$ shall be used as long as the engine speed does not drop below $n_{\text{min_drive}}$.

If the duration of a gear sequence is only 1 second, it shall be replaced by gear 0 and the clutch shall be disengaged.

If the duration of a gear sequence is 2 seconds, it shall be replaced by gear 0 for the 1st second and for the 2nd second with the gear that follows after the 2 second period. The clutch shall be disengaged for the 1st second.

Example: A gear sequence 5, 4, 4, 2 shall be replaced by 5, 0, 2, 2.

- (d) The 2nd gear shall be used during a deceleration phase within a short trip of the cycle as long as the engine speed does not drop below $(0.9 \times n_{\text{idle}})$.

If the engine speed drops below n_{idle} , the clutch shall be disengaged.

- (e) If the deceleration phase is the last part of a short trip shortly before a stop phase and the 2nd gear would only be used for up to two seconds, the clutch may be either disengaged or the gear lever placed in neutral and the clutch left engaged.

A downshift to first gear is not permitted during those deceleration phases.

- (f) If gear is used for a time sequence of 1 to 5 seconds and the gear prior to this sequence is lower and the gear after this sequence is the same as or lower than the gear before this sequence, the gear for the sequence shall be corrected to the gear before the sequence.

Examples:

- (i) gear sequence $i - 1, i, i - 1$ shall be replaced by $i - 1, i - 1, i - 1$;
- (ii) gear sequence $i - 1, i, i, i - 1$ shall be replaced by $i - 1, i - 1, i - 1, i - 1$;
- (iii) gear sequence $i - 1, i, i, i, i - 1$ shall be replaced by $i - 1, i - 1, i - 1, i - 1, i - 1$;
- (iv) gear sequence $i - 1, i, i, i, i, i - 1$ shall be replaced by $i - 1, i - 1, i - 1, i - 1, i - 1, i - 1$;
- (v) gear sequence $i - 1, i, i, i, i, i, i - 1$ shall be replaced by $i - 1, i - 1, i - 1, i - 1, i - 1, i - 1, i - 1$.

In all cases (i) to (v), shall be fulfilled;

5. Paragraphs 4.(a) to 4.(f) inclusive shall be applied sequentially, scanning the complete cycle trace in each case. Since modifications to paragraphs 4.(a) to 4.(f) of this Sub-

Status: Point in time view as at 01/06/2017.

Changes to legislation: There are outstanding changes not yet made to Commission Regulation (EU) 2017/1151. Any changes that have already been made to the legislation appear in the content and are referenced with annotations. (See end of Document for details)

Annex may create new gear use sequences, these new gear sequences shall be checked three times and modified if necessary.

In order to enable the assessment of the correctness of the calculation, the average gear for $v \geq 1$ km/h, rounded to four places of decimal, shall be calculated and included in all relevant test reports.

Sub-Annex 3

Reserved

Sub-Annex 4

Road load and dynamometer setting

1. Scope

This Sub-Annex describes the determination of the road load of a test vehicle and the transfer of that road load to a chassis dynamometer.

2. Terms and definitions

2.1. Reserved

2.2. Reference speed points shall start at 20 km/h in incremental steps of 10 km/h and with the highest reference speed according to the following provisions:

- (a) The highest reference speed point shall be 130 km/h or the reference speed point immediately above the maximum speed of the applicable test cycle if this value is less than 130 km/h. In the case that the applicable test cycle contains less than the 4 cycle phases (Low, Medium, High and Extra High) and at the request of the manufacturer and with approval of the approval authority, the highest reference speed may be increased to the reference speed point immediately above the maximum speed of the next higher phase, but no higher than 130 km/h; in this case road load determination and chassis dynamometer setting shall be done with the same reference speed points;
- (b) If a reference speed point applicable for the cycle plus 14 km/h is more than or equal to the maximum vehicle speed v_{\max} , this reference speed point shall be excluded from the coastdown test and from chassis dynamometer setting. The next lower reference speed point shall become the highest reference speed point for the vehicle.

2.3. Unless otherwise specified, a cycle energy demand shall be calculated according to paragraph 5. of Sub-Annex 7 over the target speed trace of the applicable drive cycle.

2.4. f_0 , f_1 , f_2 are the road load coefficients of the road load equation $F = f_0 + f_1 \times v + f_2 \times v^2$, determined according to this Sub-Annex.

- f_0 is the constant road load coefficient, N;
- f_1 is the first order road load coefficient, N/(km/h);
- f_2 is the second order road load coefficient, N/(km/h)².

Status: Point in time view as at 01/06/2017.

Changes to legislation: There are outstanding changes not yet made to Commission Regulation (EU) 2017/1151. Any changes that have already been made to the legislation appear in the content and are referenced with annotations. (See end of Document for details)

Unless otherwise stated, the road load coefficients shall be calculated with a least square regression analysis over the range of the reference speed points.

2.5. Rotational mass

2.5.1. Determination of m_r

m_r is the equivalent effective mass of all the wheels and vehicle components rotating with the wheels on the road while the gearbox is placed in neutral, in kilograms (kg). m_r shall be measured or calculated using an appropriate technique agreed upon by the approval authority. Alternatively, m_r may be estimated to be 3 per cent of the sum of the mass in running order and 25 kg.

2.5.2. Application of rotational mass to the road load

Coastdown times shall be transferred to forces and vice versa by taking into account the applicable test mass plus m_r . This shall apply to measurements on the road as well as on a chassis dynamometer.

2.5.3. Application of rotational mass for the inertia setting

If the vehicle is tested on a 4 wheel drive dynamometer and if both axles are rotating and influencing the dynamometer measurement results, the equivalent inertia mass of the chassis dynamometer shall be set to the applicable test mass.

Otherwise, the equivalent inertia mass of the chassis dynamometer shall be set to the test mass plus either the equivalent effective mass of the wheels not influencing the measurement results or 50 per cent of m_r .

3. General requirements

The manufacturer shall be responsible for the accuracy of the road load coefficients and will ensure this for each production vehicle within the road load family. Tolerances within the road load determination, simulation and calculation methods shall not be used to underestimate the road load of production vehicles. At the request of the approval authority, the accuracy of the road load coefficients of an individual vehicle shall be demonstrated.

3.1. Overall measurement accuracy

The required overall measurement accuracy shall be as follows:

- (a) Vehicle speed: $\pm 0,2$ km/h with a measurement frequency of at least 10 Hz;
- (b) Time accuracy, precision and resolution: min. ± 10 ms;
- (c) Wheel torque: ± 6 Nm or $\pm 0,5$ per cent of the maximum measured total torque, whichever is greater, for the whole vehicle, with a measurement frequency of at least 10 Hz;
- (d) Wind speed: $\pm 0,3$ m/s, with a measurement frequency of at least 1 Hz;
- (e) Wind direction: $\pm 3^\circ$, with a measurement frequency of at least 1 Hz;
- (f) Atmospheric temperature: ± 1 °C, with a measurement frequency of at least 0,1 Hz;
- (g) Atmospheric pressure: $\pm 0,3$ kPa, with a measurement frequency of at least 0,1 Hz;
- (h) Vehicle mass measured on the same weigh scale before and after the test: ± 10 kg (± 20 kg for vehicles $> 4\ 000$ kg);

Status: Point in time view as at 01/06/2017.

Changes to legislation: There are outstanding changes not yet made to Commission Regulation (EU) 2017/1151. Any changes that have already been made to the legislation appear in the content and are referenced with annotations. (See end of Document for details)

- (i) Tyre pressure: ± 5 kPa;
- (j) Wheel rotational frequency: $\pm 0,05$ s⁻¹ or 1 per cent, whichever is greater.

3.2. Wind tunnel criteria

3.2.1. Wind velocity

The wind velocity during a measurement shall remain within ± 2 km/h at the centre of the test section. The possible wind velocity shall be at least 140 km/h.

3.2.2. Air temperature

The air temperature during a measurement shall remain within ± 3 °C at the centre of the test section. The air temperature distribution at the nozzle outlet shall remain within ± 3 °C.

3.2.3. Turbulence

For an equally-spaced 3 by 3 grid over the entire nozzle outlet, the turbulence intensity, Tu , shall not exceed 1 per cent. See Figure A4/1.

Figure A4/1

Turbulence intensity

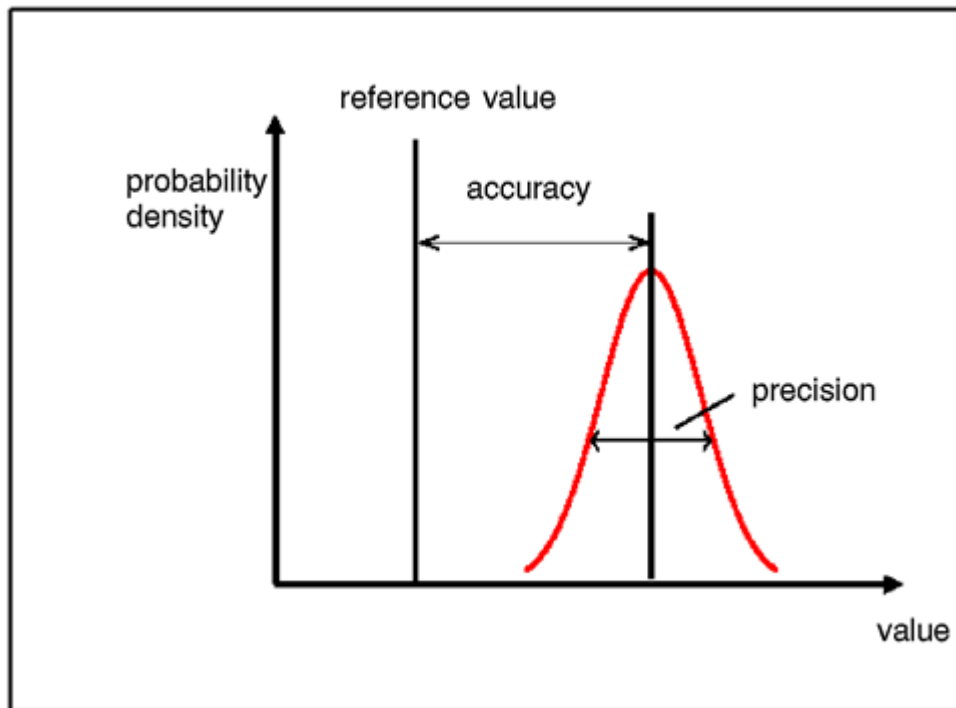

$$Tu = \frac{u'}{U_{\infty}}$$

where:

Tu is the turbulence intensity;
 u' is the turbulent velocity fluctuation, m/s;
 U_{∞} is the free flow velocity, m/s.

3.2.4. Solid blockage ratio

Status: Point in time view as at 01/06/2017.

Changes to legislation: There are outstanding changes not yet made to Commission Regulation (EU) 2017/1151. Any changes that have already been made to the legislation appear in the content and are referenced with annotations. (See end of Document for details)

The vehicle blockage ratio ϵ_{sb} expressed as the quotient of the vehicle frontal area and the area of the nozzle outlet as calculated using the following equation, shall not exceed 0,35.

$$\epsilon_{sb} = \frac{A_f}{A_{nozzle}}$$

where:

ϵ_{sb} is the vehicle blockage ratio;
 A_f is the frontal area of the vehicle, m²;
 A_{nozzle} is the nozzle outlet area, m².

3.2.5. Rotating wheels

To properly determine the aerodynamic influence of the wheels, the wheels of the test vehicle shall rotate at such a speed that the resulting vehicle velocity is within a ± 3 km/h tolerance of the wind velocity.

3.2.6. Moving belt

To simulate the fluid flow at the underbody of the test vehicle, the wind tunnel shall have a moving belt extending from the front to the rear of the vehicle. The linear speed of the moving belt shall be within ± 3 km/h of the wind velocity.

3.2.7. Fluid flow angle

At nine equally distributed points over the nozzle area, the root mean square deviation of both angles (Y-, Z-plane) α and β at the nozzle outlet shall not exceed 1°.

3.2.8. Air pressure

At nine equally distributed points over the nozzle outlet area, the standard deviation of the total pressure at the nozzle outlet shall be equal to or less than 0.02.

$$\sigma\left(\frac{\Delta P_t}{q}\right) \leq 0,02$$

where:

σ is the standard deviation of the pressure ratio $\left(\frac{\Delta P_t}{q}\right)$;
 ΔP_t is the variation of total pressure between the measurement points, N/m²;
 q is the dynamic pressure, N/ m².

The absolute difference of the pressure coefficient c_p over a distance 3 metres ahead and 3 metres behind the centre of the balance in the empty test section and at a height of the centre of the nozzle outlet shall not deviate more than $\pm 0,02$.

$$|c_{p_{x=+3m}} - c_{p_{x=-3m}}| \leq 0,02$$

where:

c_p is the pressure coefficient.

3.2.9. Boundary layer thickness

At $x = 0$ (balance center point), the wind velocity shall have at least 99 per cent of the inflow velocity 30 mm above the wind tunnel floor.

$$\delta_{99}(x = 0 \text{ m}) \leq 30 \text{ mm}$$

Status: Point in time view as at 01/06/2017.

Changes to legislation: There are outstanding changes not yet made to Commission Regulation (EU) 2017/1151. Any changes that have already been made to the legislation appear in the content and are referenced with annotations. (See end of Document for details)

where:

δ_{99} is the distance perpendicular to the road, where 99 per cent of free stream velocity is reached (boundary layer thickness).

3.2.10. Restraint blockage ratio

The restraint system mounting shall not be in front of the vehicle. The relative blockage ratio of the vehicle frontal area due to the restraint system, ϵ_{restr} , shall not exceed 0,10.

$$\epsilon_{\text{restr}} = \frac{A_{\text{restr}}}{A_f}$$

where:

ϵ_{restr} is the relative blockage ratio of the restraint system;
 A_{restr} is the frontal area of the restraint system projected on the nozzle face, m²;
 A_f is the frontal area of the vehicle, m².

3.2.11. Measurement accuracy of the balance in the x-direction

The inaccuracy of the resulting force in the x-direction shall not exceed ± 5 N. The resolution of the measured force shall be within ± 3 N.

3.2.12. Measurement repeatability

The repeatability of the measured force shall be within ± 3 N.

4. Road load measurement on road

4.1. Requirements for road test

4.1.1. Atmospheric conditions for road test

4.1.1.1. Permissible wind conditions

The maximum permissible wind conditions for road load determination are described in paragraphs 4.1.1.1.1. and 4.1.1.1.2.

In order to determine the applicability of the type of anemometry to be used, the arithmetic average of the wind speed shall be determined by continuous wind speed measurement, using a recognized meteorological instrument, at a location and height above the road level alongside the test road where the most representative wind conditions will be experienced.

If tests in opposite directions cannot be performed at the same part of the test track (e.g. on an oval test track with an obligatory driving direction), wind speed and direction at each part of the test track shall be measured. In this case the higher measured value determines the type of anemometry to be used and the lower value the criterion for the allowance of waiving of a wind correction.

4.1.1.1.1. Permissible wind conditions when using stationary anemometry

Stationary anemometry shall be used only when wind speeds over a period of 5 seconds averages less than 5 m/s and peak wind speeds are less than 8 m/s for less than 2 seconds. In addition, the vector component of the wind speed across the test road shall be less than 2 m/s. Any wind correction shall be calculated as given in paragraph 4.5.3. of this Sub-Annex. Wind correction may be waived when the lowest arithmetic average wind speed is 2 m/s or less.

4.1.1.1.2. Wind conditions using on-board anemometry

Status: Point in time view as at 01/06/2017.

Changes to legislation: There are outstanding changes not yet made to Commission Regulation (EU) 2017/1151. Any changes that have already been made to the legislation appear in the content and are referenced with annotations. (See end of Document for details)

For testing with an on-board anemometer, a device shall be used as described in paragraph 4.3.2. of this Sub-Annex. The overall arithmetic average of the wind speed during the test activity over the test road shall be less than 7 m/s with peak wind speeds of less than 10 m/s. In addition, the vector component of the wind speed across the road shall be less than 4 m/s.

4.1.1.2. Atmospheric temperature

The atmospheric temperature should be within the range of 5 °C up to and including 35 °C.

If the difference between the highest and the lowest measured temperature during the coastdown test is more than 5 °C, the temperature correction shall be applied separately for each run with the arithmetic average of the ambient temperature of that run.

In that case the values of the road load coefficients f_0 , f_1 and f_2 shall be determined and corrected for each individual run. The final set of f_0 , f_1 and f_2 values shall be the arithmetic average of the individually corrected coefficients f_0 , f_1 and f_2 respectively.

At its option, a manufacturer may choose to perform coastdowns between 1 °C and 5 °C.

4.1.2. Test road

The road surface shall be flat, even, clean, dry and free of obstacles or wind barriers that might impede the measurement of the road load, and its texture and composition shall be representative of current urban and highway road surfaces. The longitudinal slope of the test road shall not exceed ± 1 per cent. The local slope between any points 3 metres apart shall not deviate more than $\pm 0,5$ per cent from this longitudinal slope. If tests in opposite directions cannot be performed at the same part of the test track (e.g. on an oval test track with an obligatory driving direction), the sum of the longitudinal slopes of the parallel test track segments shall be between 0 and an upward slope of 0,1 per cent. The maximum camber of the test road shall be 1,5 per cent.

4.2. Preparation

4.2.1. Test vehicle

Each test vehicle shall conform in all its components with the production series, or, if the vehicle is different from the production vehicle, a full description shall be included in all relevant test reports.

4.2.1.1. Without using the interpolation method

A test vehicle (vehicle H) with the combination of road load relevant characteristics (i.e. mass, aerodynamic drag and tyre rolling resistance) producing the highest cycle energy demand shall be selected from the interpolation family (see paragraph 5.6. of this Annex).

If the aerodynamic influence of the different wheel rims within one interpolation family is not known, the selection shall be based on the highest expected aerodynamic drag. As a guideline, the highest aerodynamic drag may be expected for a wheel with a) the largest width, b) the largest diameter, and c) the most open structure design (in that order of importance).

The wheel selection shall be executed without prejudice to the requirement of the highest cycle energy demand.

4.2.1.2. Using the interpolation method

At the request of the manufacturer, the interpolation method may be applied for individual vehicles in the interpolation family (see paragraph 1.2.3.1. of Sub-Annex 6 and paragraph 3.2.3.2. of Sub-Annex 7).

Status: Point in time view as at 01/06/2017.

Changes to legislation: There are outstanding changes not yet made to Commission Regulation (EU) 2017/1151. Any changes that have already been made to the legislation appear in the content and are referenced with annotations. (See end of Document for details)

In this case, two test vehicles shall be selected from the interpolation family complying with the requirements of the interpolation method (paragraphs 1.2.3.1. and 1.2.3.2. of Sub-Annex 6).

Test vehicle H shall be the vehicle producing the higher, and preferably highest, cycle energy demand of that selection, test vehicle L the one producing the lower, and preferably lowest, cycle energy demand of that selection.

All items of optional equipment and/or body shapes that are chosen not to be considered in the interpolation method shall be fitted to both test vehicles H and L such that these items of optional equipment produce the highest combination of the cycle energy demand due to their road load relevant characteristics (i.e. mass, aerodynamic drag and tyre rolling resistance).

4.2.1.3. Application of the road load family

4.2.1.3.1. At the request of the manufacturer and upon fulfilling the criteria of paragraph 5.7. of this Annex, the road load values for vehicles H and L of an interpolation family shall be calculated.

4.2.1.3.2. For the purposes of paragraph 4.2.1.3. of this Sub-Annex, vehicle H of a road load family shall be designated vehicle H_R . All references to vehicle H in paragraph 4.2.1. of this Sub-Annex shall be replaced by vehicle H_R and all references to an interpolation family in paragraph 4.2.1. of this Sub-Annex shall be replaced by road load family.

4.2.1.3.3. For the purposes of paragraph 4.2.1.3. of this Sub-Annex, vehicle L of a road load family shall be designated vehicle L_R . All references to vehicle L in paragraph 4.2.1. of this Sub-Annex shall be replaced by vehicle L_R and all references to an interpolation family in paragraph 4.2.1. of this Sub-Annex shall be replaced by road load family.

4.2.1.3.4. Notwithstanding the requirements referring to the range of an interpolation family in paragraphs 1.2.3.1. and 1.2.3.2. of Sub-Annex 6, the difference in cycle energy demand between H_R and L_R of the road load family shall be at least 4 per cent and shall not exceed 35 per cent based on H_R over a complete WLTC Class 3 cycle.

If more than one transmission is included in the road load family, a transmission with the highest power losses shall be used for road load determination.

4.2.1.3.5. Road loads H_R and/or L_R shall be determined according to this Sub-Annex.

The road load of vehicles H (and L) of an interpolation family within the road load family shall be calculated according to paragraphs 3.2.3.2.2. to 3.2.3.2.2.4. inclusive of Sub-Annex 7, by:

- (a) using H_R and L_R of the road load family instead of H and L as inputs for the equations;
- (b) using the road load parameters (i.e. test mass, $\Delta(C_D \times A_f)$ compared to vehicle L_R , and tyre rolling resistance) of vehicle H (or L) of the interpolation family as inputs for the "individual vehicle";
- (c) repeating this calculation for each H and L vehicle of every interpolation family within the road load family.

The road load interpolation shall only be applied on those road load relevant characteristics that were identified to be different between test vehicle L_R and H_R . For other road load relevant characteristic(s), the value of vehicle H_R shall apply.

4.2.1.4. Application of the road load matrix family

A vehicle that fulfils the criteria of paragraph 5.8. of this Annex that is:

Status: Point in time view as at 01/06/2017.

Changes to legislation: There are outstanding changes not yet made to Commission Regulation (EU) 2017/1151. Any changes that have already been made to the legislation appear in the content and are referenced with annotations. (See end of Document for details)

- (a) representative of the intended series of complete vehicles to be covered by the road load matrix family in terms of estimated worst C_D value and body shape, and
- (b) representative of the intended series of vehicles to be covered by the road load matrix family in terms of estimated average of the mass of optional equipment, shall be used to determine the road load.

In the case that no representative body shape for a complete vehicle can be determined, the test vehicle shall be equipped with a square box with rounded corners with radii of maximum of 25 mm and a width equal to the maximum width of the vehicles covered by the road load matrix family, and a total height of the test vehicle of $3,0 \text{ m} \pm 0,1 \text{ m}$, including the box.

The manufacturer and the approval authority shall agree which vehicle test model is representative.

The vehicle parameters test mass, tyre rolling resistance and frontal area of both a vehicle H_M and L_M shall be determined in such a way that vehicle H_M produces the highest cycle energy demand and vehicle L_M the lowest cycle energy from the road load matrix family. The manufacturer and the approval authority shall agree on the vehicle parameters for vehicle H_M and L_M .

The road load of all individual vehicles of the road load matrix family, including H_M and L_M , shall be calculated according to paragraph 5.1. of this Sub-Annex.

4.2.1.5. Movable aerodynamic body parts

Movable aerodynamic body parts on the test vehicles shall operate during road load determination as intended under WLTP Type 1 test conditions (test temperature, vehicle speed and acceleration range, engine load, etc.).

Every vehicle system that dynamically modifies the vehicle's aerodynamic drag (e.g. vehicle height control) shall be considered to be a movable aerodynamic body part. Appropriate requirements shall be added if future vehicles are equipped with movable aerodynamic items of optional equipment whose influence on aerodynamic drag justifies the need for further requirements.

4.2.1.6. Weighing

Before and after the road load determination procedure, the selected vehicle shall be weighed, including the test driver and equipment, to determine the arithmetic average mass, m_{av} . The mass of the vehicle shall be greater than or equal to the test mass of vehicle H or of vehicle L at the start of the road load determination procedure.

4.2.1.7. Test vehicle configuration

The test vehicle configuration shall be included in all relevant test reports and shall be used for any subsequent coastdown testing.

4.2.1.8. Test vehicle condition

4.2.1.8.1. Run-in

The test vehicle shall be suitably run-in for the purpose of the subsequent test for at least 10 000 but no more than 80 000 km.

4.2.1.8.1. At the request of the manufacturer, a vehicle with a minimum of 3 000 km may be used.

4.2.1.8.2. Manufacturer's specifications

Status: Point in time view as at 01/06/2017.

Changes to legislation: There are outstanding changes not yet made to Commission Regulation (EU) 2017/1151. Any changes that have already been made to the legislation appear in the content and are referenced with annotations. (See end of Document for details)

The vehicle shall conform to the manufacturer's intended production vehicle specifications regarding tyre pressures described in paragraph 4.2.2.3. of this Sub-Annex, wheel alignment described in paragraph 4.2.1.8.3. of this Sub-Annex, ground clearance, vehicle height, drivetrain and wheel bearing lubricants, and brake adjustment to avoid unrepresentative parasitic drag.

4.2.1.8.3. Wheel alignment

Toe and camber shall be set to the maximum deviation from the longitudinal axis of the vehicle in the range defined by the manufacturer. If a manufacturer prescribes values for toe and camber for the vehicle, these values shall be used. At the request of the manufacturer, values with higher deviations from the longitudinal axis of the vehicle than the prescribed values may be used. The prescribed values shall be the reference for all maintenance during the lifetime of the vehicle.

Other adjustable wheel alignment parameters (such as caster) shall be set to the values recommended by the manufacturer. In the absence of recommended values, they shall be set to the arithmetic average of the range defined by the manufacturer.

Such adjustable parameters and set values shall be included in all relevant test sheets.

4.2.1.8.4. Closed panels

During the road load determination, the engine compartment cover, luggage compartment cover, manually-operated movable panels and all windows shall be closed.

4.2.1.8.5. Coastdown mode

If the determination of dynamometer settings cannot meet the criteria described in paragraphs 8.1.3. or 8.2.3. of this Sub-Annex due to non-reproducible forces, the vehicle shall be equipped with a vehicle coastdown mode. The coastdown mode shall be approved by the approval authority and the use of a coastdown mode shall be included in all relevant test reports.

4.2.1.8.5. If a vehicle is equipped with a vehicle coastdown mode, it shall be engaged both during road load determination and on the chassis dynamometer.

4.2.2. Tyres

4.2.2.1. Tyre selection

The selection of tyres shall be based on paragraph 4.2.1. of this Sub-Annex with their rolling resistances measured according to Annex 6 of UN/ECE Regulation No. 11702 series of amendments.

The rolling resistance coefficients shall be aligned and categorised according to the rolling resistance classes in Regulation (EC) No 1222/2009.

The actual rolling resistance values for the tyres fitted to the test vehicles shall be used to determine the gradient of the interpolation line of the interpolation method in paragraph 3.2.3.2 of Sub-Annex 7. For individual vehicles in the interpolation family, the interpolation method shall be based on the RRC class value for the tyres fitted to an individual vehicle as provided in Table A4/1.

TABLE A4/1

Energy efficiency classes of rolling resistance coefficients (RRC) for tyre categories C1, C2 and C3, kg/tonne

Energy Efficiency Class	C1 class value	C2 class value	C3 class value
-------------------------	----------------	----------------	----------------

Status: Point in time view as at 01/06/2017.

Changes to legislation: There are outstanding changes not yet made to Commission Regulation (EU) 2017/1151. Any changes that have already been made to the legislation appear in the content and are referenced with annotations. (See end of Document for details)

A	RRC = 5,9	RRC = 4,9	RRC = 3,5
B	RRC = 7,1	RRC = 6,1	RRC = 4,5
C	RRC = 8,4	RRC = 7,4	RRC = 5,5
D	Empty	Empty	RRC = 6,5
E	RRC = 9,8	RRC = 8,6	RRC = 7,5
F	RRC = 11,3	RRC = 9,9	RRC = 8,5
G	RRC = 12,9	RRC = 11,2	Empty

4.2.2.2. Tyre condition

Tyres used for the test shall:

- (a) Not be older than 2 years after the production date;
- (b) Not be specially conditioned or treated (e.g. heated or artificially aged), with the exception of grinding in the original shape of the tread;
- (c) Be run-in on a road for at least 200 km before road load determination;
- (d) Have a constant tread depth before the test between 100 and 80 per cent of the original tread depth at any point over the full tread width of the tyre.

4.2.2.2.1. After measurement of tread depth, driving distance shall be limited to 500 km. If 500 km are exceeded, tread depth shall be measured again.

4.2.2.3. Tyre pressure

The front and rear tyres shall be inflated to the lower limit of the tyre pressure range for the respective axle for the selected tyre at the coastdown test mass, as specified by the vehicle manufacturer.

4.2.2.3.1. Tyre pressure adjustment

If the difference between ambient and soak temperature is more than 5 °C, the tyre pressure shall be adjusted as follows:

- (a) The tyres shall be soaked for more than 1 hour at 10 per cent above the target pressure;
- (b) Prior to testing, the tyre pressure shall be reduced to the inflation pressure as specified in paragraph 4.2.2.3. of this Sub-Annex, adjusted for difference between the soaking environment temperature and the ambient test temperature at a rate of 0,8 kPa per 1 °C using the following equation:

$$\Delta p_t = 0,8 \times (T_{\text{soak}} - T_{\text{amb}})$$

where:

Δp_t	is the tyre pressure adjustment added to the tyre pressure defined in paragraph 4.2.2.3. of this Sub-Annex, kPa;
0,8	is the pressure adjustment factor, kPa/°C;
T_{soak}	is the tyre soaking temperature, °C;
T_{amb}	is the test ambient temperature, °C.

Status: Point in time view as at 01/06/2017.

Changes to legislation: There are outstanding changes not yet made to Commission Regulation (EU) 2017/1151. Any changes that have already been made to the legislation appear in the content and are referenced with annotations. (See end of Document for details)

- (c) Between the pressure adjustment and the vehicle warm-up, the tyres shall be shielded from external heat sources including sun radiation.

4.2.3. Instrumentation

Any instruments shall be installed in such a manner as to minimise their effects on the aerodynamic characteristics of the vehicle.

If the effect of the installed instrument on $(C_D \times A_f)$ is expected to be greater than $0,015 \text{ m}^2$, the vehicle with and without the instrument shall be measured in a wind tunnel fulfilling the criterion in paragraph 3.2. of this Sub-Annex. The corresponding difference shall be subtracted from f_2 . At the request of the manufacturer, and with approval of the approval authority, the determined value may be used for similar vehicles where the influence of the equipment is expected to be the same.

4.2.4. Vehicle warm-up

4.2.4.1. On the road

Warming up shall be performed by driving the vehicle only.

4.2.4.1.1. Before warm-up, the vehicle shall be decelerated with the clutch disengaged or an automatic transmission placed in neutral by moderate braking from 80 to 20 km/h within 5 to 10 seconds. After this braking, there shall be no further actuation or manual adjustment of the braking system.

At the request of the manufacturer and upon approval of the approval authority, the brakes may also be activated after the warm-up with the same deceleration as described in this paragraph and only if necessary.

4.2.4.1.2. Warming up and stabilization

All vehicles shall be driven at 90 per cent of the maximum speed of the applicable WLTC. The vehicle may be driven at 90 per cent of the maximum speed of the next higher phase (see Table A4/2) if this phase is added to the applicable WLTC warm-up procedure as defined in paragraph 7.3.4. of this Sub-Annex. The vehicle shall be warmed up for at least 20 minutes until stable conditions are reached.

TABLE A4/2

Warming-up and stabilization across phases

Vehicle class	Applicable WLTC	90 per cent of maximum speed	Next higher phase
Class1	Low ₁ + Medium ₁	58 km/h	NA
Class2	Low ₂ + Medium ₂ + High ₂ + Extra High ₂	111 km/h	NA
	Low ₂ + Medium ₂ + High ₂	77 km/h	Extra High (111 km/h)
Class3	Low ₃ + Medium ₃ + High ₃ + Extra High ₃	118 km/h	NA
	Low ₃ + Medium ₃ + High ₃	88 km/h	Extra High (118 km/h)

Status: Point in time view as at 01/06/2017.

Changes to legislation: There are outstanding changes not yet made to Commission Regulation (EU) 2017/1151. Any changes that have already been made to the legislation appear in the content and are referenced with annotations. (See end of Document for details)

4.2.4.1.3. Criterion for stable condition

Refer to paragraph 4.3.1.4.2. of this Sub-Annex.

4.3. Measurement and calculation of road load by the coastdown method

The road load shall be determined by using either the stationary anemometry (paragraph 4.3.1. of this Sub-Annex) or the on-board anemometry (paragraph 4.3.2. of this Sub-Annex) method.

4.3.1. Coastdown method with stationary anemometry

4.3.1.1. Selection of reference speeds for road load curve determination

Reference speeds for road load determination shall be selected according to paragraph 2. of this Sub-Annex.

4.3.1.2. Data collection

During the test, elapsed time and vehicle speed shall be measured at a minimum frequency of 5 Hz.

4.3.1.3. Vehicle coastdown procedure

4.3.1.3.1. Following the vehicle warm-up procedure described in paragraph 4.2.4. of this Sub-Annex and immediately prior to each test measurement, the vehicle shall be accelerated to 10 to 15 km/h above the highest reference speed and shall be driven at that speed for a maximum of 1 minute. After that, the coastdown shall be started immediately.

4.3.1.3.2. During coastdown, the transmission shall be in neutral. Any movement of the steering wheel shall be avoided as much as possible, and the vehicle brakes shall not be operated.

4.3.1.3.3. The test shall be repeated until the coastdown data satisfy the statistical precision requirements as specified in paragraph 4.3.1.4.2.

4.3.1.3.4. Although it is recommended that each coastdown run be performed without interruption, split runs may be performed if data cannot be collected in a single run for all the reference speed points. For split runs, care shall be taken so that vehicle conditions remain as stable as possible at each split point.

4.3.1.4. Determination of road load by coastdown time measurement

4.3.1.4.1. The coastdown time corresponding to reference speed as the elapsed time from vehicle speed ($v_j + 5$ km/h) to ($v_j - 5$ km/h) shall be measured.

4.3.1.4.2. These measurements shall be carried out in opposite directions until a minimum of three pairs of measurements have been obtained that satisfy the statistical precision p_j , defined in the following equation.

$$p_j = \frac{h \times \sigma_j}{\sqrt{n \times \Delta t_j}} \leq 0,03$$

where:

P_j is the statistical precision of the measurements made at reference speed v_j ;
 n is the number of pairs of measurements;

Status: Point in time view as at 01/06/2017.

Changes to legislation: There are outstanding changes not yet made to Commission Regulation (EU) 2017/1151. Any changes that have already been made to the legislation appear in the content and are referenced with annotations. (See end of Document for details)

Δt_j is the arithmetic average of the coastdown time at reference speed v_j in seconds, given by the equation:

$$\Delta t_j = \frac{n}{\sum_{i=1}^n \frac{1}{\Delta t_{ji}}}$$

where:

Δt_{ji} is the harmonic arithmetic average coastdown time of the i^{th} pair of measurements at velocity v_j , seconds, s, given by the equation:

$$\Delta t_{ji} = \frac{2}{\left(\frac{1}{\Delta t_{jai}}\right) + \left(\frac{1}{\Delta t_{jbi}}\right)}$$

where:

Δt_{jai} and Δt_{jbi} are the coastdown times of the i^{th} measurement at reference speed v_j , in seconds, s, in the respective directions a and b;

σ_j is the standard deviation, expressed in seconds, s, defined by:

$$\sigma_j = \sqrt{\frac{1}{n-1} \sum_{i=1}^n (\Delta t_{ji} - \Delta t_j)^2}$$

h is a coefficient given in Table A4/3.

Table A4/3

Coefficient h as function of n

n	h	h/ \sqrt{n}	n	h	h/ \sqrt{n}
3	4,3	2,48	10	2,2	0,73
4	3,2	1,60	11	2,2	0,66
5	2,8	1,25	12	2,2	0,64
6	2,6	1,06	13	2,2	0,61
7	2,5	0,94	14	2,2	0,59
8	2,4	0,85	15	2,2	0,57
9	2,3	0,77			

4.3.1.4.3. If during a measurement in one direction any external factor or driver action occurs that influences the road load test, that measurement and the corresponding measurement in the opposite direction shall be rejected.

The maximum number of pairs that still fulfil the statistical accuracy as defined in paragraph 4.3.1.4.2. shall be evaluated and the number of rejected pairs of measurement shall not exceed 1/3 of the total number of measurement pairs.

4.3.1.4.4. The following equation shall be used to compute the arithmetic average of the road load where the harmonic arithmetic average of the alternate coastdown times shall be used.

$$F_j = \frac{1}{3\beta} \times (m_{av} + m_r) \times \frac{2 \times \Delta v}{\Delta v_j}$$

where:

Status: Point in time view as at 01/06/2017.

Changes to legislation: There are outstanding changes not yet made to Commission Regulation (EU) 2017/1151. Any changes that have already been made to the legislation appear in the content and are referenced with annotations. (See end of Document for details)

Δt_j is the harmonic arithmetic average of alternate coastdown time measurements at velocity v_j , seconds, s, given by:

$$\Delta t_j = \frac{2}{\frac{1}{\Delta t_{ja}} + \frac{1}{\Delta t_{jb}}}$$

where:

Δt_{ja} and Δt_{jb} are the arithmetic average coastdown times in directions a and b, respectively, corresponding to reference speed v_j , in seconds, s, given by the following two equations:

$$\Delta t_{ja} = \frac{1}{n} \sum_{i=1}^n \Delta t_{jai}$$

and:

$$\Delta t_{jb} = \frac{1}{n} \sum_{i=1}^n \Delta t_{jbi}$$

where:

m_{av} is the arithmetic average of the test vehicle masses at the beginning and end of road load determination, kg;

m_r is the equivalent effective mass of rotating components according to paragraph 2.5.1. of this Sub-Annex;

The coefficients, f_0 , f_1 and f_2 , and in the road load equation shall be calculated with a least squares regression analysis.

In the case that the tested vehicle is the representative vehicle of a road load matrix family, the coefficient f_1 shall be set to zero and the coefficients f_0 and f_2 shall be recalculated with a least squares regression analysis.

4.3.2. Coastdown method with on-board anemometry

The vehicle shall be warmed up and stabilised according to paragraph 4.2.4. of this Sub-Annex.

4.3.2.1. Additional instrumentation for on-board anemometry

The on-board anemometer and instrumentation shall be calibrated by means of operation on the test vehicle where such calibration occurs during the warm-up for the test.

4.3.2.1.1. Relative wind speed shall be measured at a minimum frequency of 1 Hz and to an accuracy of 0.3 m/s. Vehicle blockage shall be accounted for in the calibration of the anemometer.

4.3.2.1.2. Wind direction shall be relative to the direction of the vehicle. The relative wind direction (yaw) shall be measured with a resolution of 1 degree and an accuracy of 3 degrees; the dead band of the instrument shall not exceed 10 degrees and shall be directed towards the rear of the vehicle.

4.3.2.1.3. Before the coastdown, the anemometer shall be calibrated for wind speed and yaw offset as specified in ISO 10521-1:2006(E) Annex A.

4.3.2.1.4. Anemometer blockage shall be corrected for in the calibration procedure as described in ISO 10521-1:2006(E) Annex A in order to minimise its effect.

4.3.2.2. Selection of vehicle speed range for road load curve determination

The test vehicle speed range shall be selected according to paragraph 2.2. of this Sub-Annex.

4.3.2.3. Data collection

Status: Point in time view as at 01/06/2017.

Changes to legislation: There are outstanding changes not yet made to Commission Regulation (EU) 2017/1151. Any changes that have already been made to the legislation appear in the content and are referenced with annotations. (See end of Document for details)

During the procedure, elapsed time, vehicle speed, and air velocity (wind speed, direction) relative to the vehicle, shall be measured at a frequency of 5 Hz. Ambient temperature shall be synchronised and sampled at a minimum frequency of 1 Hz.

4.3.2.4. Vehicle coastdown procedure

The measurements shall be carried out in opposite directions until a minimum of ten consecutive runs (five in each direction) have been obtained. Should an individual run fail to satisfy the required on-board anemometry test conditions, that run and the corresponding run in the opposite direction shall be rejected. All valid pairs shall be included in the final analysis with a minimum of 5 pairs of coastdown runs. See paragraph 4.3.2.6.10. of this Sub-Annex for statistical validation criteria.

The anemometer shall be installed in a position such that the effect on the operating characteristics of the vehicle is minimised.

The anemometer shall be installed according to one of the options below:

- (a) Using a boom approximately 2 metres in front of the vehicle's forward aerodynamic stagnation point;
- (b) On the roof of the vehicle at its centreline. If possible, the anemometer shall be mounted within 30 cm from the top of the windshield.
- (c) On the engine compartment cover of the vehicle at its centreline, mounted at the midpoint position between the vehicle front and the base of the windshield.

In all cases, the anemometer shall be mounted parallel to the road surface. In the event that positions (b) or (c) are used, the coastdown results shall be analytically adjusted for the additional aerodynamic drag induced by the anemometer. The adjustment shall be made by testing the coastdown vehicle in a wind tunnel both with and without the anemometer installed in the same position as used on the track. The calculated difference shall be the incremental aerodynamic drag coefficient C_D combined with the frontal area, which shall be used to correct the coastdown results.

4.3.2.4.1. Following the vehicle warm-up procedure described in paragraph 4.2.4. of this Sub-Annex and immediately prior to each test measurement, the vehicle shall be accelerated to 10 to 15 km/h above the highest reference speed and shall be driven at that speed for a maximum of 1 minute. After that, the coastdown shall be started immediately.

4.3.2.4.2. During a coastdown, the transmission shall be in neutral. Any steering wheel movement shall be avoided as much as possible, and the vehicle's brakes shall not be operated.

4.3.2.4.3. It is recommended that each coastdown run be performed without interruption. Split runs may however be performed if data cannot be collected in a single run for all the reference speed points. For split runs, care shall be taken so that vehicle conditions remain as stable as possible at each split point.

4.3.2.5. Determination of the equation of motion

Symbols used in the on-board anemometer equations of motion are listed in Table A4/4.

TABLE A4/4

Symbols used in the on-board anemometer equations of motion

Status: Point in time view as at 01/06/2017.

Changes to legislation: There are outstanding changes not yet made to Commission Regulation (EU) 2017/1151. Any changes that have already been made to the legislation appear in the content and are referenced with annotations. (See end of Document for details)

Symbol	Units	Description
A_f	m^2	frontal area of the vehicle
$a_0 \dots a_n$	degrees ⁻¹	Aerodynamic drag coefficients as a function of yaw angle
A_m	N	mechanical drag coefficient
B_m	N/(km/h)	mechanical drag coefficient
C_m	N/(km/h) ²	mechanical drag coefficient
$C_D(Y)$		aerodynamic drag coefficient at yaw angle Y
D	N	drag
D_{aero}	N	aerodynamic drag
D_f	N	front axle drag (including driveline)
D_{grav}	N	gravitational drag
D_{mech}	N	mechanical drag
D_r	N	rear axle drag (including driveline)
D_{tyre}	N	tyre rolling resistance
(dh/ds)	—	sine of the slope of the track in the direction of travel (+ indicates ascending)
(dv/dt)	m/s^2	acceleration
g	m/s^2	gravitational constant
m_{av}	kg	arithmetic average mass of the test vehicle before and after road load determination
ρ	kg/m^3	air density
t	s	time
T	K	Temperature
v	km/h	vehicle speed
v_r	km/h	relative wind speed
Y	degrees	yaw angle of apparent wind relative to direction of vehicle travel

4.3.2.5.1. General form

Status: Point in time view as at 01/06/2017.

Changes to legislation: There are outstanding changes not yet made to Commission Regulation (EU) 2017/1151. Any changes that have already been made to the legislation appear in the content and are referenced with annotations. (See end of Document for details)

The general form of the equation of motion is as follows:

$$-m_e \left(\frac{dv}{dt} \right) = D_{\text{mech}} + D_{\text{aero}} + D_{\text{grav}}$$

where:

$$\begin{aligned} D_{\text{mech}} &= D_{\text{tyre}} + D_f + D_r; \\ D_{\text{aero}} &= \\ &D_{\text{aero}} = \left(\frac{1}{2} \right) \rho C_D(Y) A_f v_r^2 \\ &; \\ D_{\text{grav}} &= D_{\text{grav}} = m \times g \times \left(\frac{dh}{ds} \right) \end{aligned}$$

In the case that the slope of the test track is equal to or less than 0.1 per cent over its length, D_{grav} may be set to zero.

4.3.2.5.2. Mechanical drag modelling

Mechanical drag consisting of separate components representing tyre D_{tyre} and front and rear axle frictional losses, D_f and D_r , including transmission losses) shall be modelled as a three-term polynomial as a function of vehicle speed v as in the equation below:

$$D_{\text{mech}} = A_m + B_m v + C_m v^2$$

where:

A_m , B_m , and C_m are determined in the data analysis using the least squares method. These constants reflect the combined driveline and tyre drag.

In the case that the tested vehicle is the representative vehicle of a road load matrix family, the coefficient B_m shall be set to zero and the coefficients A_m and C_m shall be recalculated with a least squares regression analysis.

4.3.2.5.3. Aerodynamic drag modelling

The aerodynamic drag coefficient $C_D(Y)$ shall be modelled as a four-term polynomial as a function of yaw angle Y as in the equation below:

$$C_D(Y) = a_0 + a_1 Y + a_2 Y^2 + a_3 Y^3 + a_4 Y^4$$

a_0 to a_4 are constant coefficients whose values are determined in the data analysis.

The aerodynamic drag shall be determined by combining the drag coefficient with the vehicle's frontal area A_f and the relative wind velocity v_r :

$$D_{\text{aero}} = \left(\frac{1}{2} \right) \times \rho \times A_f \times v_r^2 \times C_D(Y)$$

$$D_{\text{aero}} = \left(\frac{1}{2} \right) \times \rho \times A_f \times v_r^2 (a_0 + a_1 Y + a_2 Y^2 + a_3 Y^3 + a_4 Y^4)$$

4.3.2.5.4. Final equation of motion

Through substitution, the final form of the equation of motion becomes:

$$m_e \left(\frac{dv}{dt} \right) = A_m + B_m v + C_m v^2 + \left(\frac{1}{2} \right) \times \rho \times A_f \times v_r^2 (a_0 + a_1 Y + a_2 Y^2 + a_3 Y^3 + a_4 Y^4) + \left(m \times g \times \frac{dh}{ds} \right)$$

4.3.2.6. Data reduction

A three-term equation shall be generated to describe the road load force as a function of velocity, $F = A + Bv + Cv^2$, corrected to standard ambient temperature and pressure conditions, and in still air. The method for this analysis process is described in paragraphs 4.3.2.6.1. to 4.3.2.6.10. inclusive in this Sub-Annex.

Status: Point in time view as at 01/06/2017.

Changes to legislation: There are outstanding changes not yet made to Commission Regulation (EU) 2017/1151. Any changes that have already been made to the legislation appear in the content and are referenced with annotations. (See end of Document for details)

4.3.2.6.1. Determining calibration coefficients

If not previously determined, calibration factors to correct for vehicle blockage shall be determined for relative wind speed and yaw angle. Vehicle speed v , relative wind velocity v_r and yaw Y measurements during the warm-up phase of the test procedure shall be recorded. Paired runs in alternate directions on the test track at a constant velocity of 80 km/h shall be performed, and the arithmetic average values of v , v_r and Y for each run shall be determined. Calibration factors that minimise the total errors in head and cross winds over all the run pairs, i.e. the sum of $(\text{head}_i - \text{head}_{i+1})^2$, etc., shall be selected where head_i and head_{i+1} refer to wind speed and wind direction from the paired test runs in opposing directions during the vehicle warm-up/stabilization prior to testing.

4.3.2.6.2. Deriving second by second observations

From the data collected during the coastdown runs, values for v ,

$$\left(\frac{dh}{ds}\right)\left(\frac{dv}{dt}\right)$$

, v_r^2 , and Y shall be determined by applying calibration factors obtained in paragraphs 4.3.2.1.3. and 4.3.2.1.4. of this Sub-Annex. Data filtering shall be used to adjust samples to a frequency of 1 Hz.

4.3.2.6.3. Preliminary analysis

Using a linear least squares regression technique, all data points shall be analysed at once to determine A_m , B_m , C_m , a_0 , a_1 , a_2 , a_3 and given M_e and

$$\left(\frac{dh}{ds}\right)\left(\frac{dv}{dt}\right)$$

, v , v_r , and ρ .

4.3.2.6.4. Data outliers

A predicted force

$$m_e \left(\frac{dv}{dt}\right)$$

shall be calculated and compared to the observed data points. Data points with excessive deviations, e.g., over three standard deviations, shall be flagged.

4.3.2.6.5. Data filtering (optional)

Appropriate data filtering techniques may be applied and the remaining data points shall be smoothed out.

4.3.2.6.6. Data elimination

Data points gathered where yaw angles are greater than ± 20 degrees from the direction of vehicle travel shall be flagged. Data points gathered where relative wind is less than + 5 km/h (to avoid conditions where tailwind speed is higher than vehicle speed) shall also be flagged. Data analysis shall be restricted to vehicle speeds within the speed range selected according to paragraph 4.3.2.2. of this Sub-Annex.

4.3.2.6.7. Final data analysis

All data that has not been flagged shall be analysed using a linear least squares regression technique. Given M_e and

$$\left(\frac{dh}{ds}\right)\left(\frac{dv}{dt}\right)$$

, v , v_r , and ρ , A_m , B_m , C_m , a_0 , a_1 , a_2 , a_3 and a_4 shall be determined.

Status: Point in time view as at 01/06/2017.

Changes to legislation: There are outstanding changes not yet made to Commission Regulation (EU) 2017/1151. Any changes that have already been made to the legislation appear in the content and are referenced with annotations. (See end of Document for details)

4.3.2.6.8. Constrained analysis (optional)

To better separate the vehicle aerodynamic and mechanical drag, a constrained analysis may be applied such that the vehicle's frontal area, A_f , and the drag coefficient, C_D , may be fixed if they have been previously determined.

4.3.2.6.9. Correction to reference conditions

Equations of motion shall be corrected to reference conditions as specified in paragraph 4.5. of this Sub-Annex.

4.3.2.6.10 Statistical criteria for on-board anemometry

The exclusion of each single pair of coastdown runs shall change the calculated road load for each coastdown reference speed v_j less than the convergence requirement, for all i and j :

$$\Delta F_i(v_j)/F(v_j) \leq \frac{0,03}{\sqrt{n-1}}$$

where:

$\Delta F_i(v_j)$ is the difference between the calculated road load with all coastdown runs and the calculated road load with the i^{th} pair of coastdown runs excluded, N;

$F(v_j)$ is the calculated road load with all coastdown runs included, N;

v_j is the reference speed, km/h;

n is the number of pairs of coastdown runs, all valid pairs are included.

In the case that the convergence requirement is not met, pairs shall be removed from the analysis, starting with the pair giving the highest change in calculated road load, until the convergence requirement is met, as long as a minimum of 5 valid pairs are used for the final road load determination.

4.4. Measurement and calculation of running resistance using the torque meter method

As an alternative to the coastdown methods, the torque meter method may also be used in which the running resistance is determined by measuring wheel torque on the driven wheels at the reference speed points for time periods of at least 5 seconds.

4.4.1. Installation of torque meter

Wheel torque meters shall be installed between the wheel hub and the rim of each driven wheel, measuring the required torque to keep the vehicle at a constant speed.

The torque meter shall be calibrated on a regular basis, at least once a year, traceable to national or international standards, in order to meet the required accuracy and precision.

4.4.2. Procedure and data sampling

4.4.2.1. Selection of reference speeds for running resistance curve determination

Reference speed points for running resistance determination shall be selected according to paragraph 2.2. of this Sub-Annex.

The reference speeds shall be measured in descending order. At the request of the manufacturer, there may be stabilization periods between measurements but the stabilization speed shall not exceed the speed of the next reference speed.

4.4.2.2. Data collection

Status: Point in time view as at 01/06/2017.

Changes to legislation: There are outstanding changes not yet made to Commission Regulation (EU) 2017/1151. Any changes that have already been made to the legislation appear in the content and are referenced with annotations. (See end of Document for details)

Data sets consisting of actual speed v_{ji} actual torque C_{ji} and time over a period of at least 5 seconds shall be measured for every v_j at a sampling frequency of at least 10 Hz. The data sets collected over one time period for a reference speed v_j shall be referred to as one measurement.

4.4.2.3. Vehicle torque meter measurement procedure

Prior to the torque meter method test measurement, a vehicle warm-up shall be performed according to paragraph 4.2.4. of this Sub-Annex.

During test measurement, steering wheel movement shall be avoided as much as possible, and the vehicle brakes shall not be operated.

The test shall be repeated until the running resistance data satisfy the measurement precision requirements as specified in paragraph 4.4.3.2. of this Sub-Annex.

Although it is recommended that each test run be performed without interruption, split runs may be performed if data cannot be collected in a single run for all the reference speed points. For split runs, care shall be taken so that vehicle conditions remain as stable as possible at each split point

4.4.2.4. Velocity deviation

During a measurement at a single reference speed point, the velocity deviation from the arithmetic average velocity, $v_{ji}-v_{jm}$, calculated according to paragraph 4.4.3. of this Sub-Annex, shall be within the values in Table A4/5.

Additionally, the arithmetic average velocity v_{jm} at every reference speed point shall not deviate from the reference speed v_j by more than ± 1 km/h or 2 per cent of the reference speed v_j , whichever is greater.

TABLE A4/5

Velocity deviation

Time period, s	Velocity deviation, km/h
5 - 10	$\pm 0,2$
10 - 15	$\pm 0,4$
15 - 20	$\pm 0,6$
20 - 25	$\pm 0,8$
25 - 30	$\pm 1,0$
≥ 30	$\pm 1,2$

4.4.2.5. Atmospheric temperature

Tests shall be performed under the same temperature conditions as defined in paragraph 4.1.1.2. of this Sub-Annex.

4.4.3. Calculation of arithmetic average velocity and arithmetic average torque

4.4.3.1. Calculation process

Status: Point in time view as at 01/06/2017.

Changes to legislation: There are outstanding changes not yet made to Commission Regulation (EU) 2017/1151. Any changes that have already been made to the legislation appear in the content and are referenced with annotations. (See end of Document for details)

Arithmetic average velocity v_{jm} , in km/h, and arithmetic average torque C_{jm} , in Nm, of each measurement shall be calculated from the data sets collected in paragraph 4.4.2.2. of this Sub-Annex using the following equations:

$$v_{jm} = \frac{1}{k} \sum_{i=1}^k v_{ji}$$

and

$$C_{jm} = \frac{1}{k} \sum_{i=1}^k C_{ji} - C_{js}$$

where:

v_{ji} is the actual vehicle speed of the i^{th} data set at reference speed point j , km/h;
 k is the number of data sets in a single measurement;
 C_{ji} is the actual torque of the i^{th} data set, Nm;
 C_{js} is the compensation term for speed drift, Nm, given by the following equation:

$$C_{js} = (m_{st} + m_r) \times \alpha_j r_j.$$

$$\frac{C_{js}}{\frac{1}{k} \sum_{i=1}^k C_{ji}}$$

shall be no greater than 0,05 and may be disregarded if α_j is not greater than $\pm 0,005 \text{ m/s}^2$;

m_{st} is the test vehicle mass at the start of the measurements and shall be measured immediately before the warm-up procedure and no earlier, kg;
 m_r is the equivalent effective mass of rotating components according to paragraph 2.5.1. of this Sub-Annex, kg;
 r_j is the dynamic radius of the tyre determined at a reference point of 80 km/h or at the highest reference speed point of the vehicle if this speed is lower than 80 km/h, calculated according to the following equation:

$$r_j = \frac{1}{3,6} \times \frac{v_{jm}}{2 \times \pi n}$$

where:

n is the rotational frequency of the driven tyre, s^{-1} ;
 α_j is the arithmetic average acceleration, m/s^2 , which calculated using the following equation:

$$\alpha_j = \frac{1}{3,6} \times \frac{k \sum_{i=1}^{k-1} t_i v_j - \sum_{i=1}^{k-1} t_i \sum_{i=1}^{k-1} v_j}{k \times \sum_{i=1}^{k-1} t_i^2 - \left[\sum_{i=1}^{k-1} t_i \right]^2}$$

where:

t_i is the time at which the i^{th} data set was sampled, s.

4.4.3.2. Measurement precision

The measurements shall be carried out in opposite directions until a minimum of three pairs of measurements at each reference speed v_j have been obtained, for which

$$\bar{C}_j$$

satisfies the precision ρ_j according to the following equation:

$$\rho_j = \frac{h \times s}{\sqrt{n} \times \bar{C}_j} \leq 0.03$$

where:

n is the number pairs of measurements for C_{jm} ;

Status: Point in time view as at 01/06/2017.

Changes to legislation: There are outstanding changes not yet made to Commission Regulation (EU) 2017/1151. Any changes that have already been made to the legislation appear in the content and are referenced with annotations. (See end of Document for details)

\bar{C}_j is the running resistance at the speed v_j , Nm, given by the equation:

$$\bar{C}_j = \frac{1}{n} \sum_{i=1}^{i-1} C_{jmi}$$

where:

C_{jmi} is the arithmetic average torque of the i^{th} pair of measurements at speed v_j , Nm, and given by:

$$C_{jmi} = \frac{1}{2} \times (C_{jmai} + C_{jmbi})$$

where:

C_{jmai} and C_{jmbi} are the arithmetic average torques of the i^{th} measurement at speed v_j determined in paragraph 4.4.3.1. of this Sub-Annex for each direction, a and b respectively, Nm;

s is the standard deviation, Nm, calculated using the following equation:

$$s = \sqrt{\frac{1}{k-1} \sum_{k=1}^{i-1} (C_{jmi} - \bar{C}_j)^2};$$

h is a coefficient as a function of n as given in Table A4/3 in paragraph 4.3.1.4.2. of this Sub-Annex.

4.4.4. Running resistance curve determination

The arithmetic average vehicle speed and arithmetic average torque at each reference speed point shall be calculated using the following equations:

$$v_{jm} = \frac{1}{2} \times (v_{jma} + v_{jmb})$$

$$C_{jm} = \frac{1}{2} \times (C_{jma} + C_{jmb})$$

The following least squares regression curve of arithmetic average running resistance shall be fitted to all the data pairs (v_{jm} , C_{jm}) at all reference speeds described in paragraph 4.4.2.1. of this Sub-Annex to determine the coefficients c_0 , c_1 and c_2 .

The coefficients, c_0 , c_1 and c_2 , and as well as the coastdown times measured on the chassis dynamometer (see paragraph 8.2.4. of this Sub-Annex) shall be included in all relevant test sheets.

In the case that the tested vehicle is the representative vehicle of a road load matrix family, the coefficient c_1 shall be set to zero and the coefficients c_0 and c_2 shall be recalculated with a least squares regression analysis.

4.5. Correction to reference conditions and measurement equipment

4.5.1. Air resistance correction factor

The correction factor for air resistance K_2 shall be determined using the following equation:

$$K_2 = \frac{T}{293 \text{ K}} \times \frac{100 \text{ kPa}}{P}$$

where:

T is the arithmetic average atmospheric temperature of all individual runs, Kelvin (K);

P is the arithmetic average atmospheric pressure, kPa.

4.5.2. Rolling resistance correction factor

Status: Point in time view as at 01/06/2017.

Changes to legislation: There are outstanding changes not yet made to Commission Regulation (EU) 2017/1151. Any changes that have already been made to the legislation appear in the content and are referenced with annotations. (See end of Document for details)

The correction factor for rolling resistance, in Kelvin⁻¹ (K⁻¹), may be determined based on empirical data and approved by the approval authority for the particular vehicle and tyre test, or may be assumed to be as follows:

$$K_0 = 8,6 \times 10^{-3} K^{-1}$$

4.5.3. Wind correction

4.5.3.1. Wind correction with stationary anemometry

4.5.3.1.1. A wind correction for the absolute wind speed alongside the test road shall be made by subtracting the difference that cannot be cancelled out by alternate runs from the constant term given in paragraph 4.3.1.4.4. of this Sub-Annex, or from c_0 given in paragraph 4.4.4. of this Sub-Annex.

4.5.3.1.2. The wind correction resistance w_1 for the coastdown method or w_2 for the torque meter method shall be calculated by the equations:

$$w_1 = 3,6^2 \times f_2 \times v_w^2$$

$$\text{or: } w_2 = 3,6^2 \times c_2 \times v_w^2$$

where:

w_1	is the wind correction resistance for the coastdown method, N;
f_2	is the coefficient of the aerodynamic term determined in paragraph 4.3.1.4.4. of this Sub-Annex;
v_w	is the lower arithmetic average wind speed of opposite directions alongside the test road during the test, m/s;
w_2	is the wind correction resistance for the torque meter method, Nm;
c_2	is the coefficient of the aerodynamic term for the torque meter method determined in paragraph 4.4.4. of this Sub-Annex.

4.5.3.2. Wind correction with on-board anemometry

In the case that the coastdown method is based on on-board anemometry, w_1 and w_2 in the equations in paragraph 4.5.3.1.2. shall be set to zero, as the wind correction is already applied according to paragraph 4.3.2. of this Sub-Annex.

4.5.4. Test mass correction factor

The correction factor K_1 for the test mass of the test vehicle shall be determined using the following equation:

$$K_1 = f_0 \times \left(1 - \frac{TM}{m_{av}}\right)$$

where:

f_0	is a constant term, N;
TM	is the test mass of the test vehicle, kg;
m_{av}	is the actual test mass of the test vehicle determined according to paragraph 4.3.1.4.4. of this Sub-Annex, kg.

4.5.5. Road load curve correction

4.5.5.1. The curve determined in paragraph 4.3.1.4.4. of this Sub-Annex shall be corrected to reference conditions as follows:

$$F^* = ((f_0 - w_1 - K_1) + f_1 v) \times (1 + K_0(T - 20)) + K_2 f_2 v^2$$

where:

Status: Point in time view as at 01/06/2017.

Changes to legislation: There are outstanding changes not yet made to Commission Regulation (EU) 2017/1151. Any changes that have already been made to the legislation appear in the content and are referenced with annotations. (See end of Document for details)

F*	is the corrected road load, N;
f ₀	is the constant term, N;
f ₁	is the coefficient of the first order term, N·(h/km);
f ₂	is the coefficient of the second order term, N·(h/km) ² ;
K ₀	is the correction factor for rolling resistance as defined in paragraph 4.5.2. of this Sub-Annex;
K ₁	is the test mass correction as defined in paragraph 4.5.4. of this Sub-Annex;
K ₂	is the correction factor for air resistance as defined in paragraph 4.5.1. of this Sub-Annex;
T	is the arithmetic average ambient atmospheric temperature, °C;
v	is vehicle velocity, km/h;
w ₁	is the wind resistance correction as defined in paragraph 4.5.3. of this Sub-Annex, N.

The result of the calculation $((f_0 - w_1 - K_1) \times (1 + K_0 \times (T-20)))$ shall be used as the target road load coefficient A_t in the calculation of the chassis dynamometer load setting described in paragraph 8.1. of this Sub-Annex.

The result of the calculation $(f_1 \times (1 + K_0 \times (T-20)))$ shall be used as the target road load coefficient B_t in the calculation of the chassis dynamometer load setting described in paragraph 8.1. of this Sub-Annex.

The result of the calculation $(K_2 \times f_2)$ shall be used as the target road load coefficient C_t in the calculation of the chassis dynamometer load setting described in paragraph 8.1. of this Sub-Annex.

4.5.5.2. The curve determined in paragraph 4.4.4. of this Sub-Annex shall be corrected to reference conditions and measurement equipment installed according to the following procedure.

4.5.5.2.1. Correction to reference conditions

$$C^* = ((c_0 - w_2 - K_1) + c_1 v) \times (1 + K_0 (T - 20)) + K_2 c_2 v^2$$

where:

C*	is the corrected running resistance, Nm;
c ₀	is the constant term as determined in paragraph 4.4.4. of this Sub-Annex, Nm;
c ₁	is the coefficient of the first order term as determined in paragraph 4.4.4. of this Sub-Annex, Nm (h/km);
c ₂	is the coefficient of the second order term as determined in paragraph 4.4.4. of this Sub-Annex, Nm (h/km) ² ;
K ₀	is the correction factor for rolling resistance as defined in paragraph 4.5.2. of this Sub-Annex;
K ₁	is the test mass correction as defined in paragraph 4.5.4. of this Sub-Annex;
K ₂	is the correction factor for air resistance as defined in paragraph 4.5.1. of this Sub-Annex;
v	is the vehicle velocity, km/h;
T	is the arithmetic average atmospheric temperature, °C;
w ₂	is the wind correction resistance as defined in paragraph 4.5.3. of this Sub-Annex.

Status: Point in time view as at 01/06/2017.

Changes to legislation: There are outstanding changes not yet made to Commission Regulation (EU) 2017/1151. Any changes that have already been made to the legislation appear in the content and are referenced with annotations. (See end of Document for details)

4.5.5.2.2. Correction for installed torque meters

If the running resistance is determined according to the torque meter method, the running resistance shall be corrected for effects of the torque measurement equipment installed outside the vehicle on its aerodynamic characteristics.

The running resistance coefficient c_2 shall be corrected according to the following equation:

$$c_{2\text{corr}} = K_2 \times c_2 \times (1 + (\Delta(C_D \times A_f)) / (C_{D'} \times A_{f'}))$$

where,

$$\Delta(C_D \times A_f) = (C_D \times A_f) - (C_{D'} \times A_{f'})$$

$C_{D'} \times A_{f'}$ is the product of the aerodynamic drag coefficient multiplied by the frontal area of the vehicle with the torque meter measurement equipment installed measured in a wind tunnel fulfilling the criteria of paragraph 3.2. of this Sub-Annex, m^2 ;

$C_D \times A_f$ is the product of the aerodynamic drag coefficient multiplied by the frontal area of the vehicle with the torque meter measurement equipment not installed measured in a wind tunnel fulfilling the criteria of paragraph 3.2. of this Sub-Annex, m^2 .

4.5.5.2.3. Target running resistance coefficients

The result of the calculation $((c_0 - w_2 - K_1) \times (1 + K_0 \times (T-20)))$ shall be used as the target running resistance coefficient a_t in the calculation of the chassis dynamometer load setting described in paragraph 8.2. of this Sub-Annex.

The result of the calculation $(c_1 \times (1 + K_0 \times (T-20)))$ shall be used as the target running resistance coefficient b_t in the calculation of the chassis dynamometer load setting described in paragraph 8.2. of this Sub-Annex.

The result of the calculation $(c_{2\text{corr}} \times r)$ shall be used as the target running resistance coefficient c_t in the calculation of the chassis dynamometer load setting described in paragraph 8.2. of this Sub-Annex.

5. Method for the calculation of road load or running resistance based on vehicle parameters

5.1. Calculation of road load and running resistance for vehicles based on a representative vehicle of a road load matrix family

If the road load of the representative vehicle is determined according to a method described in paragraph 4.3. of this Sub-Annex, the road load of an individual vehicle shall be calculated according to paragraph 5.1.1. of this Sub-Annex.

If the running resistance of the representative vehicle is determined according to the method described in paragraph 4.4. of this Sub-Annex, the running resistance of an individual vehicle shall be calculated according to paragraph 5.1.2. of this Sub-Annex.

5.1.1. For the calculation of the road load of vehicles of a road load matrix family, the vehicle parameters described in paragraph 4.2.1.4. of this Sub-Annex and the road load coefficients of the representative test vehicle determined in paragraphs 4.3. of this Sub-Annex shall be used.

Status: Point in time view as at 01/06/2017.

Changes to legislation: There are outstanding changes not yet made to Commission Regulation (EU) 2017/1151. Any changes that have already been made to the legislation appear in the content and are referenced with annotations. (See end of Document for details)

5.1.1.1. The road load force for an individual vehicle shall be calculated using the following equation:

$$F_c = f_0 + (f_1 \times v) + (f_2 \times v^2)$$

where:

F_c is the calculated road load force as a function of vehicle velocity, N;

f_0 is the constant road load coefficient, N, defined by the equation:

$$f_0 = \text{Max}((0,05 \times f_{0r} + 0,95 \times (f_{0r} \times \text{TM} / \text{TM}_r + (\text{RR} - \text{RR}_r) \times 9,81 \times \text{TM})); (0,2 \times f_{0r} + 0,8 \times (f_{0r} \times \text{TM} / \text{TM}_r + (\text{RR} - \text{RR}_r) \times 9,81 \times \text{TM})))$$

f_{0r} is the constant road load coefficient of the representative vehicle of the road load matrix family, N;

f_1 is the first order road load coefficient and shall be set to zero;

f_2 is the second order road load coefficient, $\text{N} \cdot (\text{h}/\text{km})^2$, defined by the equation:

$$f_2 = \text{Max}((0,05 \times f_{2r} + 0,95 \times f_{2r} \times A_f / A_{fr}); (0,2 \times f_{2r} + 0,8 \times f_{2r} \times A_f / A_{fr}))$$

f_{2r} is the second order road load coefficient of the representative vehicle of the road load matrix family, $\text{N} \cdot (\text{h}/\text{km})^2$;

v is the vehicle speed, km/h;

TM is the actual test mass of the individual vehicle of the road load matrix family, kg;

TM_r is the test mass of the representative vehicle of the road load matrix family, kg;

A_f is the frontal area of the individual vehicle of the road load matrix family, m^2 ;

A_{fr} is the frontal area of the representative vehicle of the road load matrix family, m^2 ;

RR is the tyre rolling resistance of the individual vehicle of the road load matrix family, kg/tonne;

RR_r is the tyre rolling resistance of the representative vehicle of the road load matrix family, kg/tonne.

5.1.2. For the calculation of the running resistance of vehicles of a road load matrix family, the vehicle parameters described in paragraph 4.2.1.4. of this Sub-Annex and the running resistance coefficients of the representative test vehicle determined in paragraphs 4.4. of this Sub-Annex shall be used.

5.1.2.1. The running resistance for an individual vehicle shall be calculated using the following equation:

$$C_c = c_0 + c_1 \times v + c_2 \times v^2$$

where:

C_c is the calculated running resistance as a function of vehicle velocity, Nm;

c_0 is the constant running resistance coefficient, Nm, defined by the equation:

$$c_0 = r' / 1,02 \times \text{Max}((0,05 - 1,02 - c_{0r} / r' + 0,95 \times (1,02 \times c_{0r} / r' \times \text{TM} / \text{TM}_r + (\text{RR} - \text{RR}_r) \times 9,81 \times \text{TM})); (0,2 \times 1,02 \times c_{0r} / r' + 0,8 \times (1,02 \times c_{0r} / r' \times \text{TM} / \text{TM}_r + (\text{RR} - \text{RR}_r) \times 9,81 \times \text{TM})))$$

c_{0r} is the constant running resistance coefficient of the representative vehicle of the road load matrix family, Nm;

c_1 is the first order running resistance and shall be set to zero;

c_2 is the second order running resistance coefficient, $\text{Nm} \cdot (\text{h}/\text{km})^2$, defined by the equation:

$$c_2 = r' / 1,02 \times \text{Max}((0,05 \times 1,02 \times c_{2r} / r' + 0,95 \times 1,02 \times c_{2r} / r' \times A_f / A_{fr}); (0,2 \times 1,02 \times c_{2r} / r' + 0,8 \times 1,02 \times c_{2r} / r' \times A_f / A_{fr}))$$

Status: Point in time view as at 01/06/2017.

Changes to legislation: There are outstanding changes not yet made to Commission Regulation (EU) 2017/1151. Any changes that have already been made to the legislation appear in the content and are referenced with annotations. (See end of Document for details)

c_{2r}	is the second order running resistance coefficient of the representative vehicle of the road load matrix family, $N \cdot (h/km)^2$;
v	is the vehicle speed, km/h;
TM	is the actual test mass of the individual vehicle of the road load matrix family, kg;
TMr	is the test mass of the representative vehicle of the road load matrix family, kg;
A_f	is the frontal area of the individual vehicle of the road load matrix family, m^2 ,
A_{fr}	is the frontal area of the representative vehicle of the road load matrix family, m^2 ;
RR	is the tyre rolling resistance of the individual vehicle of the road load matrix family, kg/tonne;
RRr	is the tyre rolling resistance of the representative vehicle of the road load matrix family, kg/tonne;
r'	is the dynamic radius of the tyre on the chassis dynamometer obtained at 80 km/h, m;
1.02	is an approximate coefficient compensating for drivetrain losses.

5.2. Calculation of the default road load based on vehicle parameters

5.2.1. As an alternative for determining road load with the coastdown or torque meter method, a calculation method for default road load may be used.

For the calculation of a default road load based on vehicle parameters, several parameters such as test mass, width and height of the vehicle shall be used. The default road load F_c shall be calculated for the reference speed points.

5.2.2. The default road load force shall be calculated using the following equation:

$$F_c = f_0 + f_1 \times v + f_2 \times v^2$$

where:

F_c	is the calculated default road load force as a function of vehicle velocity, N;
f_0	is the constant road load coefficient, N, defined by the following equation: $f_0 = 0,140 \times TM$;
f_1	is the first order road load coefficient and shall be set to zero;
f_2	is the second order road load coefficient, $N \cdot (h/km)^2$, defined by the following equation: $f_2 = (2,8 \times 10^{-6} \times TM) + (0,0170 \times width \times height);(49)$
v	is vehicle velocity, km/h;
TM	test mass, kg;
width	vehicle width as defined in 6.2. of Standard ISO 612:1978, m;
height	vehicle height as defined in 6.3. of Standard ISO 612:1978, m.

6. Wind tunnel method

The wind tunnel method is a road load measurement method using a combination of a wind tunnel and a chassis dynamometer or of a wind tunnel and a flat belt dynamometer. The test benches may be separate facilities or integrated with one another.

6.1. Measurement method

Status: Point in time view as at 01/06/2017.

Changes to legislation: There are outstanding changes not yet made to Commission Regulation (EU) 2017/1151. Any changes that have already been made to the legislation appear in the content and are referenced with annotations. (See end of Document for details)

- 6.1.1. The road load shall be determined by:
- (a) adding the road load forces measured in a wind tunnel and those measured using a flat belt dynamometer; or
 - (b) adding the road load forces measured in a wind tunnel and those measured on a chassis dynamometer.
- 6.1.2. Aerodynamic drag shall be measured in the wind tunnel.
- 6.1.3. Rolling resistance and drivetrain losses shall be measured using a flat belt or a chassis dynamometer, measuring the front and rear axles simultaneously.
- 6.2. Approval of the facilities by the approval authority

The results of the wind tunnel method shall be compared to those obtained using the coastdown method to demonstrate qualification of the facilities and included in all relevant test reports.

- 6.2.1. Three vehicles shall be selected by the approval authority. The vehicles shall cover the range of vehicles (e.g. size, weight) planned to be measured with the facilities concerned.
- 6.2.2. Two separate coastdown tests shall be performed with each of the three vehicles according to paragraph 4.3. of this Sub-Annex, and the resulting road load coefficients, f_0 , f_1 and f_2 , shall be determined according to that paragraph and corrected according to paragraph 4.5.5. of this Sub-Annex. The coastdown test result of a test vehicle shall be the arithmetic average of the road load coefficients of its two separate coastdown tests. If more than two coastdown tests are necessary to fulfil the approval of facilities' criteria, all valid tests shall be averaged.
- 6.2.3. Measurement with the wind tunnel method according to paragraphs 6.3. to 6.7. inclusive of this Sub-Annex shall be performed on the same three vehicles as selected in paragraph 6.2.1. of this Sub-Annex and in the same conditions, and the resulting road load coefficients, f_0 , f_1 and f_2 , shall be determined.

If the manufacturer chooses to use one or more of the available alternative procedures within the wind tunnel method (i.e. paragraph 6.5.2.1. on preconditioning, paragraphs 6.5.2.2. and 6.5.2.3. on the procedure, and paragraph 6.5.2.3.3. on dynamometer setting), these procedures shall also be used also for the approval of the facilities.

6.2.4. Approval criteria

The facility or combination of facilities used shall be approved if both of the following two criteria are fulfilled:

- (a) The difference in cycle energy, expressed as ε_k , between the wind tunnel method and the coastdown method shall be within $\pm 0,05$ for each of the three vehicles k according to the following equation:

$$\varepsilon_k = \frac{E_{k,WTM}}{E_{k,coastdown}} - 1$$

where:

ε_k is the difference in cycle energy over a complete Class 3 WLTC for vehicle k between the wind tunnel method and the coastdown method, per cent;

Status: Point in time view as at 01/06/2017.

Changes to legislation: There are outstanding changes not yet made to Commission Regulation (EU) 2017/1151. Any changes that have already been made to the legislation appear in the content and are referenced with annotations. (See end of Document for details)

$E_{k, \text{WTM}}$ is the cycle energy over a complete Class 3 WLTC for vehicle k, calculated with the road load derived from the wind tunnel method (WTM) calculated according to paragraph 5 of Sub-Annex 7, J;

$E_{k, \text{coastdown}}$ is the cycle energy over a complete Class 3 WLTC for vehicle k, calculated with the road load derived from the coastdown method calculated according to paragraph 5. of Sub-Annex 7, J.; and

(b) The arithmetic average

\bar{x}
of the three differences shall be within 0,02.

$$\bar{x} = \left| \frac{e_1 + e_2 + e_3}{3} \right|$$

The facility may be used for road load determination for a maximum of two years after the approval has been granted.

Each combination of roller chassis dynamometer or moving belt and wind tunnel shall be approved separately.

6.3. Vehicle preparation and temperature

Conditioning and preparation of the vehicle shall be performed according to paragraphs 4.2.1. and 4.2.2. of this Sub-Annex and applies to both the flat belt or roller chassis dynamometers and the wind tunnel measurements.

In the case that the alternative warm-up procedure described in paragraph 6.5.2.1. is applied, the target test mass adjustment, the weighing of the vehicle and the measurement shall all be performed without the driver in the vehicle.

The flat belt or the chassis dynamometer test cells shall have a temperature set point of 20 °C with a tolerance of ± 3 °C. At the request of the manufacturer, the set point may also be 23 °C with a tolerance of ± 3 °C.

6.4. Wind tunnel procedure

6.4.1. Wind tunnel criteria

The wind tunnel design, test methods and the corrections shall provide a value of $(C_D \times A_f)$ representative of the on-road $(C_D \times A_f)$ value and with a repeatability of 0,015 m².

For all $(C_D \times A_f)$ measurements, the wind tunnel criteria listed in paragraph 3.2. of this Sub-Annex shall be met with the following modifications:

- (a) The solid blockage ratio described in paragraph 3.2.4. of this Sub-Annex shall be less than 25 per cent;
- (b) The belt surface contacting any tyre shall exceed the length of that tyre's contact area by at least 20 per cent and shall be at least as wide as that contact patch;
- (c) The standard deviation of total air pressure at the nozzle outlet described in paragraph 3.2.8. of this Sub-Annex shall be less than 1 per cent;
- (d) The restraint system blockage ratio described in paragraph 3.2.10. of this Sub-Annex shall be less than 3 per cent.

6.4.2. Wind tunnel measurement

Status: Point in time view as at 01/06/2017.

Changes to legislation: There are outstanding changes not yet made to Commission Regulation (EU) 2017/1151. Any changes that have already been made to the legislation appear in the content and are referenced with annotations. (See end of Document for details)

The vehicle shall be in the condition described in paragraph 6.3. of this Sub-Annex.

The vehicle shall be placed parallel to the longitudinal centre line of the tunnel with a maximum deviation of 10 mm.

The vehicle shall be placed with a yaw angle of 0° and with a tolerance of $\pm 0,1^\circ$.

Aerodynamic drag shall be measured for at least for 60 seconds and at a minimum frequency of 5 Hz. Alternatively, the drag may be measured at a minimum frequency of 1 Hz and with at least 300 subsequent samples. The result shall be the arithmetic average of the drag.

In the case that the vehicle has movable aerodynamic body parts, paragraph 4.2.1.5. of this Sub-Annex shall apply. Where movable parts are velocity-dependent, every applicable position shall be measured in the wind tunnel and evidence shall be provided to the approval authority indicating the relationship between reference speed, movable part position, and the corresponding ($C_D \times A_f$).

6.5. Flat belt applied for the wind tunnel method

6.5.1. Flat belt criteria

6.5.1.1. Description of the flat belt test bench

The wheels shall rotate on flat belts that do not change the rolling characteristics of the wheels compared to those on the road. The measured forces in the x-direction shall include the frictional forces in the drivetrain.

6.5.1.2. Vehicle restraint system

The dynamometer shall be equipped with a centring device aligning the vehicle within a tolerance of ± 0.5 degrees of rotation around the z-axis. The restraint system shall maintain the centred drive wheel position throughout the coastdown runs of the road load determination within the following limits:

6.5.1.2.1. Lateral position (y-axis)

The vehicle shall remain aligned in the y-direction and lateral movement shall be minimised.

6.5.1.2.2. Front and rear position (x-axis)

Without prejudice to the requirement of paragraph 6.5.1.2.1. of this Sub-Annex, both wheel axes shall be within ± 10 mm of the belt's lateral centre lines.

6.5.1.2.3. Vertical force

The restraint system shall be designed so as to impose no vertical force on the drive wheels.

6.5.1.3. Accuracy of measured forces

Only the reaction force for turning the wheels shall be measured. No external forces shall be included in the result (e.g. force of the cooling fan air, vehicle restraints, aerodynamic reaction forces of the flat belt, dynamometer losses, etc.).

The force in the x-direction shall be measured with an accuracy of ± 5 N.

6.5.1.4. Flat belt speed control

The belt speed shall be controlled with an accuracy of $\pm 0,1$ km/h.

Status: Point in time view as at 01/06/2017.

Changes to legislation: There are outstanding changes not yet made to Commission Regulation (EU) 2017/1151. Any changes that have already been made to the legislation appear in the content and are referenced with annotations. (See end of Document for details)

6.5.1.5. Flat belt surface

The flat belt surface shall be clean, dry and free from foreign material that might cause tyre slippage.

6.5.1.6. Cooling

A current of air of variable speed shall be blown towards the vehicle. The set point of the linear velocity of the air at the blower outlet shall be equal to the corresponding dynamometer speed above measurement speeds of 5 km/h. The deviation of the linear velocity of the air at the blower outlet shall remain within ± 5 km/h or ± 10 per cent of the corresponding measurement speed, whichever is greater.

6.5.2. Flat belt measurement

The measurement procedure may be performed according to either paragraph 6.5.2.2. or paragraph 6.5.2.3. of this Sub-Annex.

6.5.2.1. Preconditioning

The vehicle shall be conditioned on the dynamometer as described in paragraphs 4.2.4.1.1. to 4.2.4.1.3. inclusive of this Sub-Annex.

The dynamometer load setting F_d , for the preconditioning shall be:

$$F_d = a_d + b_d \times v + c_d \times v^2$$

where:

$$\begin{aligned} a_d &= 0 \\ b_d &= 0; \\ c_d &= (C_D \times A_f) \times \frac{\rho_a}{2} \times \frac{1}{3R^2} \end{aligned}$$

The equivalent inertia of the dynamometer shall be the test mass.

The aerodynamic drag used for the load setting shall be taken from paragraph 6.7.2. of this Sub-Annex and may be set directly as input. Otherwise, a_d , b_d , and c_d from this paragraph shall be used.

At the request of the manufacturer, as an alternative to paragraph 4.2.4.1.2. of this Sub-Annex, the warm-up may be conducted by driving the vehicle with the flat belt.

In this case, the warm-up speed shall be 110 per cent of the maximum speed of the applicable WLTC and the duration shall exceed 1 200 seconds until the change of measured force over a period of 200 seconds is less than 5 N.

6.5.2.2. Measurement procedure with stabilised speeds

6.5.2.2.1. The test shall be conducted from the highest to the lowest reference speed point.

6.5.2.2.2. Immediately after the measurement at the previous speed point, the deceleration from the current to the next applicable reference speed point shall be performed in a smooth transition of approximately 1 m/s^2 .

6.5.2.2.3. The reference speed shall be stabilised for at least 4 seconds and for a maximum of 10 seconds. The measurement equipment shall ensure that the signal of the measured force is stabilised after that period.

Status: Point in time view as at 01/06/2017.

Changes to legislation: There are outstanding changes not yet made to Commission Regulation (EU) 2017/1151. Any changes that have already been made to the legislation appear in the content and are referenced with annotations. (See end of Document for details)

6.5.2.2.4. The force at each reference speed shall be measured for at least 6 seconds while the vehicle speed is kept constant. The resulting force for that reference speed point $F_{jD_{\text{Dyno}}}$ shall be the arithmetic average of the force during the measurement.

The steps in paragraphs 6.5.2.2.2. to 6.5.2.2.4. of this Sub-Annex inclusive shall be repeated for each reference speed.

6.5.2.3. Measurement procedure by deceleration

6.5.2.3.1. Preconditioning and dynamometer setting shall be performed according to paragraph 6.5.2.1. of this Sub-Annex. Prior to each coastdown, the vehicle shall be driven at the highest reference speed or, in the case that the alternative warm-up procedure is used at 110 per cent of the highest reference speed, for at least 1 minute. The vehicle shall be subsequently accelerated to at least 10 km/h above the highest reference speed and the coastdown shall be started immediately.

6.5.2.3.2. The measurement shall be performed according to paragraphs 4.3.1.3.1. to 4.3.1.4.4. inclusive of this Sub-Annex. Coasting down in opposite directions is not required and the equation used to calculate Δt_{ji} in paragraph 4.3.1.4.2. of this Sub-Annex shall not apply. The measurement shall be stopped after two decelerations if the force of both coastdowns at each reference speed point is within ± 10 N, otherwise at least three coastdowns shall be performed using the criteria set out in paragraph 4.3.1.4.2. of this Sub-Annex.

6.5.2.3.3. The force $f_{jD_{\text{Dyno}}}$ at each reference speed v_j shall be calculated by removing the simulated aerodynamic force:

$$f_{jD_{\text{Dyno}}} = f_{jD_{\text{Decel}}} - c_d \times v_j^2$$

where:

$f_{jD_{\text{Decel}}}$ is the force determined according to the equation calculating F_j in paragraph 4.3.1.4.4. of this Sub-Annex at reference speed point j , N;
 c_d is the dynamometer set coefficient as defined in paragraph 6.5.2.1. of this Sub-Annex, $\text{N}/(\text{km/h})^2$.

Alternatively, at the request of the manufacturer, c_d may be set to zero during the coastdown and for calculating $f_{jD_{\text{Dyno}}}$.

6.5.2.4. Measurement conditions

The vehicle shall be in the condition described in paragraph 4.3.1.3.2. of this Sub-Annex.

During coastdown, the transmission shall be in neutral. Any movement of the steering wheel shall be avoided as much as possible, and the vehicle brakes shall not be operated.

6.5.3. Measurement result of the flat belt method

The result of the flat belt dynamometer $f_{jD_{\text{Dyno}}}$ shall be referred to as f_j for the further calculations in paragraph 6.7. of this Sub-Annex.

6.6. Chassis dynamometer applied for the wind tunnel method

6.6.1. Criteria

In addition to the descriptions in paragraphs 1. and 2. of Sub-Annex 5, the criteria described in paragraphs 6.6.1.1. to 6.6.1.6. inclusive of this Sub-Annex shall apply.

Status: Point in time view as at 01/06/2017.

Changes to legislation: There are outstanding changes not yet made to Commission Regulation (EU) 2017/1151. Any changes that have already been made to the legislation appear in the content and are referenced with annotations. (See end of Document for details)

6.6.1.1. Description of a chassis dynamometer

The front and rear axles shall be equipped with a single roller with a diameter of no less than 1.2 metres. The measured forces in the x-direction include the frictional forces in the drivetrain.

6.6.1.2. Vehicle restraint system

The dynamometer shall be equipped with a centring device aligning the vehicle. The restraint system shall maintain the centred drive wheel position within the following recommended limits throughout the coastdown runs of the road load determination:

6.6.1.2.1. Vehicle position

The vehicle to be tested shall be installed on the chassis dynamometer roller as defined in paragraph 7.3.3. of this Sub-Annex.

6.6.1.2.2. Vertical force

The restraint system shall fulfil the requirements of paragraph 6.5.1.2.3. of this Sub-Annex.

6.6.1.3. Accuracy of measured forces

The accuracy of measured forces shall be as described in paragraph 6.5.1.3. of this Sub-Annex apart from the force in the x-direction that shall be measured with an accuracy as described in paragraph 2.4.1. of Sub-Annex 5.

6.6.1.4. Dynamometer speed control

The roller speeds shall be controlled with an accuracy of $\pm 0,2$ km/h.

6.6.1.5. Roller surface

The roller surface shall be as described in paragraph 6.5.1.5 of this Sub-Annex.

6.6.1.6. Cooling

The cooling fan shall be as described in paragraph 6.5.1.6. of this Sub-Annex.

6.6.2. Dynamometer measurement

The measurement shall be performed as described in paragraph 6.5.2. of this Sub-Annex.

6.6.3. Correction of the chassis dynamometer roller curve

The measured forces on the chassis dynamometer shall be corrected to a reference equivalent to the road (flat surface) and the result shall be referred to as f_j .

$$f_j = f_{jDyno} \times c1 \times \sqrt{\frac{1}{\frac{R_{Wheel}}{R_{Dyno}} \times c2 + 1}} + f_{jDyno} \times (1 - c1)$$

where:

$c1$	is the tyre rolling resistance fraction of f_{jDyno} ;
$c2$	is a chassis dynamometer specific radius correction factor;
f_{jDyno}	is the force calculated in paragraph 6.5.2.3.3. for each reference speed j , N;
R_{Wheel}	is one-half of the nominal design tyre diameter, m;
R_{Dyno}	is the radius of the chassis dynamometer roller, m.

Status: Point in time view as at 01/06/2017.

Changes to legislation: There are outstanding changes not yet made to Commission Regulation (EU) 2017/1151. Any changes that have already been made to the legislation appear in the content and are referenced with annotations. (See end of Document for details)

The manufacturer and approval authority shall agree on the factors c1 and c2 to be used, based on correlation test evidence provided by the manufacturer for the range of tyre characteristics intended to be tested on the chassis dynamometer.

As an alternative the following conservative equation may be used:

$$f_j = f_{jDyna} \times \sqrt{\frac{1}{\frac{R_{Wheel} \times 0,2 + 1}{R_{Dyna}}}}$$

6.7. Calculations

6.7.1. Correction of the flat belt and chassis dynamometer results

The measured forces determined in paragraphs 6.5. and 6.6. of this Sub-Annex shall be corrected to reference conditions using the following equation:

$$F_{Dj} = (f_j - K_1) \times (1 + K_0(T - 293))$$

where:

F_{Dj}	is the corrected resistance measured at the flat belt or chassis dynamometer at reference speed j, N;
f_j	is the measured force at reference speed j, N;
K_0	is the correction factor for rolling resistance as defined in paragraph 4.5.2. of this Sub-Annex, K^{-1} ;
K_1	is the test mass correction as defined in paragraph 4.5.4. of this Sub-Annex, N;
T	is the arithmetic average temperature in the test cell during the measurement, K.

6.7.2. Calculation of the aerodynamic force

The aerodynamic drag shall be calculated using the equation below. If the vehicle is equipped with velocity-dependent movable aerodynamic body parts, the corresponding $(C_D \times A_f)$ values shall be applied for the concerned reference speed points.

$$F_{Aj} = (C_D \times A_f)_j \times \frac{\rho_0}{2} \times \frac{v_j^2}{3,6^3}$$

where:

F_{Aj}	is the aerodynamic drag measured in the wind tunnel at reference speed j, N;
$(C_D \times A_f)_j$	is the product of the drag coefficient and frontal area at a certain reference speed point j, where applicable, m^2 ;
ρ_0	is the dry air density defined in paragraph 3.2.10. of this Annex, kg/m^3 ;
v_j	is the reference speed j, km/h.

6.7.3. Calculation of road load values

The total road load as a sum of the results of paragraphs 6.7.1 and 6.7.2. of this Sub-Annex shall be calculated using the following equation:

$$F_j^* = F_{Dj} + F_{Aj}$$

for all applicable reference speed points j, N;

For all calculated F_j^* , the coefficients f_0 , f_1 and f_2 in the road load equation shall be calculated with a least squares regression analysis and shall be used as the target coefficients in paragraph 8.1.1. of this Sub-Annex.

Status: Point in time view as at 01/06/2017.

Changes to legislation: There are outstanding changes not yet made to Commission Regulation (EU) 2017/1151. Any changes that have already been made to the legislation appear in the content and are referenced with annotations. (See end of Document for details)

In the case that the vehicle(s) tested according to the wind tunnel method is (are) representative of a road load matrix family vehicle, the coefficient f_1 shall be set to zero and the coefficients f_0 and f_2 shall be recalculated with a least squares regression analysis.

7. Transferring road load to a chassis dynamometer

7.1. Preparation for chassis dynamometer test

7.1.1. Laboratory conditions

7.1.1.1. Roller(s)

The chassis dynamometer roller(s) shall be clean, dry and free from foreign material that might cause tyre slippage. For chassis dynamometers with multiple rollers, the dynamometer shall be run in the same coupled or uncoupled state as the subsequent Type 1 test. Chassis dynamometer speed shall be measured from the roller coupled to the power absorption unit.

7.1.1.1.1. Tyre slippage

Additional weight may be placed on or in the vehicle to eliminate tyre slippage. The manufacturer shall perform the load setting on the chassis dynamometer with the additional weight. The additional weight shall be present for both load setting and the emissions and fuel consumption tests. The use of any additional weight shall be included in all relevant test sheets.

7.1.1.2. Room temperature

The laboratory atmospheric temperature shall be at a set point of 23 °C and shall not deviate by more than ± 5 °C during the test unless otherwise required by any subsequent test.

7.2. Preparation of chassis dynamometer

7.2.1. Inertia mass setting

The equivalent inertia mass of the chassis dynamometer shall be set according to paragraph 2.5.3. of this Sub-Annex. If the chassis dynamometer is not capable to meet the inertia setting exactly, the next higher inertia setting shall be applied with a maximum increase of 10 kg.

7.2.2. Chassis dynamometer warm-up

The chassis dynamometer shall be warmed up in accordance with the dynamometer manufacturer's recommendations, or as appropriate, so that the frictional losses of the dynamometer may be stabilized.

7.3. Vehicle preparation

7.3.1. Tyre pressure adjustment

The tyre pressure at the soak temperature of a Type 1 test shall be set to no more than 50 per cent above the lower limit of the tyre pressure range for the selected tyre, as specified by the vehicle manufacturer (see paragraph 4.2.2.3. of this Sub-Annex), and shall be included in all relevant test reports.

7.3.2. If the determination of dynamometer settings cannot meet the criteria described in paragraph 8.1.3. of this Sub-Annex due to non-reproducible forces, the vehicle shall be equipped with a vehicle coastdown mode. The coastdown mode shall be approved by the approval authority and the use of a coastdown mode shall be included in all relevant test reports.

Status: Point in time view as at 01/06/2017.

Changes to legislation: There are outstanding changes not yet made to Commission Regulation (EU) 2017/1151. Any changes that have already been made to the legislation appear in the content and are referenced with annotations. (See end of Document for details)

7.3.2.1. If a vehicle is equipped with a vehicle coastdown mode, it shall be engaged both during road load determination and on the chassis dynamometer.

7.3.3. Vehicle placement on the dynamometer

The tested vehicle shall be placed on the chassis dynamometer in a straight ahead position and restrained in a safe manner. In the case that a single roller chassis dynamometer is used, the centre of the tyre's contact patch on the roller shall be within ± 25 mm or ± 2 per cent of the roller diameter, whichever is smaller, from the top of the roller.

7.3.3.1. If the torque meter method is used, the tyre pressure shall be adjusted such that the dynamic radius is within 0.5 per cent of the dynamic radius r_j calculated using the equations in paragraph 4.4.3.1. of this Sub-Annex at the 80 km/h reference speed point. The dynamic radius on the chassis dynamometer shall be calculated according to the procedure described in paragraph 4.4.3.1. of this Sub-Annex.

If this adjustment is outside the range defined in paragraph 7.3.1. of this Sub-Annex, the torque meter method shall not apply.

7.3.4. Vehicle warm-up

7.3.4.1. The vehicle shall be warmed up with the applicable WLTC. In the case that the vehicle was warmed up at 90 per cent of the maximum speed of the next higher phase during the procedure defined in paragraph 4.2.4.1.2. of this Sub-Annex, this higher phase shall be added to the applicable WLTC.

TABLE A4/6

Vehicle warm-up

Vehicle class	Applicable WLTC	Adopt next higher phase	Warm-up cycle
Class 1	Low ₁ + Medium ₁	NA	Low ₁ + Medium ₁
Class 2	Low ₂ + Medium ₂ + High ₂ + Extra High ₂	NA	Low ₂ + Medium ₂ + High ₂ + Extra High ₂
	Low ₂ + Medium ₂ + High ₂	Yes (Extra High ₂)	
		No	Low ₂ + Medium ₂ + High ₂
Class 3	Low ₃ + Medium ₃ + High ₃ + Extra High ₃	Low ₃ + Medium ₃ + High ₃ + Extra High ₃	Low ₃ + Medium ₃ + High ₃ + Extra High ₃
	Low ₃ + Medium ₃ + High ₃	Yes (Extra High ₃)	
		No	Low ₃ + Medium ₃ + High ₃

7.3.4.2. If the vehicle is already warmed up, the WLTC phase applied in paragraph 7.3.4.1. of this Sub-Annex, with the highest speed, shall be driven.

7.3.4.3. Alternative warm-up procedure

Status: Point in time view as at 01/06/2017.

Changes to legislation: There are outstanding changes not yet made to Commission Regulation (EU) 2017/1151. Any changes that have already been made to the legislation appear in the content and are referenced with annotations. (See end of Document for details)

7.3.4.3.1. At the request of the vehicle manufacturer and with approval of the approval authority, an alternative warm-up procedure may be used. The approved alternative warm-up procedure may be used for vehicles within the same road load family and shall satisfy the requirements outlined in paragraphs 7.3.4.3.2. to 7.3.4.3.5. of this Sub-Annex inclusive.

7.3.4.3.2. At least one vehicle representing the road load family shall be selected.

7.3.4.3.3. The cycle energy demand calculated according to paragraph 5. of Sub-Annex 7 with corrected road load coefficients f_{0a} , f_{1a} and f_{2a} , for the alternative warm-up procedure shall be equal to or higher than the cycle energy demand calculated with the target road load coefficients f_0 , f_1 , and f_2 , for each applicable phase.

The corrected road load coefficients f_{0a} , f_{1a} and f_{2a} , shall be calculated according to the following equations:

$$f_{0a} = f_0 + A_{d_alt} - A_{d_WLTC}$$

$$f_{1a} = f_1 + B_{d_alt} - B_{d_WLTC}$$

$$f_{2a} = f_2 + C_{d_alt} - C_{d_WLTC}$$

where:

A_{d_alt} , B_{d_alt} and C_{d_alt} are the chassis dynamometer setting coefficients after the alternative warm-up procedure;

A_{d_WLTC} , B_{d_WLTC} and C_{d_WLTC} are the chassis dynamometer setting coefficients after a WLTC warm-up procedure described in paragraph 7.3.4.1. of this Sub-Annex and a valid chassis dynamometer setting according to paragraph 8. of this Sub-Annex.

7.3.4.3.4. The corrected road load coefficients f_{0a} , f_{1a} and f_{2a} , shall be used only for the purpose of paragraph 7.3.4.3.3. of this Sub-Annex. For other purposes, the target road load coefficients f_0 , f_1 and f_2 , shall be used as the target road load coefficients.

7.3.4.3.5. Details of the procedure and of its equivalency shall be provided to the approval authority.

8. Chassis dynamometer load setting

8.1. Chassis dynamometer load setting using the coastdown method

This method is applicable when the road load coefficients f_0 , f_1 and f_2 have been determined.

In the case of a road load matrix family, this method shall be applied when the road load of the representative vehicle is determined using the coastdown method described in paragraph 4.3. of this Sub-Annex. The target road load values are the values calculated using the method described in paragraph 5.1. of this Sub-Annex.

8.1.1. Initial load setting

For a chassis dynamometer with coefficient control, the chassis dynamometer power absorption unit shall be adjusted with the arbitrary initial coefficients, A_d , B_d and C_d , of the following equation:

$$F_d = A_d + B_d v + C_d v^2$$

where:

F_d is the chassis dynamometer setting load, N;

Status: Point in time view as at 01/06/2017.

Changes to legislation: There are outstanding changes not yet made to Commission Regulation (EU) 2017/1151. Any changes that have already been made to the legislation appear in the content and are referenced with annotations. (See end of Document for details)

v is the speed of the chassis dynamometer roller, km/h.

The following are recommended coefficients to be used for the initial load setting:

- (a) $A_d = 0,5 \times A_t$, $B_d = 0,2 \times B_t$, $C_d = C_t$
for single-axis chassis dynamometers, or
 $A_d = 0,1 \times A_t$, $B_d = 0,2 \times B_t$, $C_d = C_t$
for dual-axis chassis dynamometers, where, and are the target road load coefficients;
- (b) empirical values, such as those used for the setting for a similar type of vehicle.

For a chassis dynamometer of polygonal control, adequate load values at each reference speed shall be set to the chassis dynamometer power absorption unit.

8.1.2. Coastdown

The coastdown test on the chassis dynamometer shall be performed with the procedure given in paragraph 8.1.3.4.1. or in paragraph 8.1.3.4.2. of this Sub-Annex and shall start no later than 120 seconds after completion of the warm-up procedure. Consecutive coastdown runs shall be started immediately. At the request of the manufacturer and with approval of the approval authority, the time between the warm-up procedure and coastdowns using the iterative method may be extended to ensure a proper vehicle setting for the coastdown. The manufacturer shall provide the approval authority with evidence for requiring additional time and evidence that the chassis dynamometer load setting parameters (e.g. coolant and/or oil temperature, force on a dynamometer) are not affected.

8.1.3. Verification

8.1.3.1. The target road load value shall be calculated using the target road load coefficient, A_t , B_t and C_t , for each reference speed, v_j :

$$F_{tj} = A_t + B_t v_j + C_t v_j^2$$

where:

A_t , B_t and C_t are the target road load parameters f_0 , f_1 and f_2 respectively;
 F_{tj} is the target road load at reference speed v_j , N;
 v_j is the j^{th} reference speed, km/h.

8.1.3.2. The measured road load shall be calculated using the following equation:

$$F_{mj} = \frac{1}{3,6} \times (TM + m_r) \times \frac{2 \times \Delta v}{\Delta t_j}$$

where:

F_{mj} is the measured road load for each reference speed v_j , N;
TM is the test mass of the vehicle, kg;
 m_r is the equivalent effective mass of rotating components according to paragraph 2.5.1. of this Sub-Annex, kg;
 Δt_j is the coastdown time corresponding to speed v_j , s.

8.1.3.3. The simulated road load on the chassis dynamometer shall be calculated according to the method as specified in paragraph 4.3.1.4. of this Sub-Annex, with the exception of measuring in opposite directions, and with applicable corrections according to paragraph 4.5. of this Sub-Annex, resulting in a simulated road load curve:

$$F_s = A_s + B_s \times v + C_s \times v^2$$

Status: Point in time view as at 01/06/2017.

Changes to legislation: There are outstanding changes not yet made to Commission Regulation (EU) 2017/1151. Any changes that have already been made to the legislation appear in the content and are referenced with annotations. (See end of Document for details)

The simulated road load for each reference speed v_j shall be determined using the following equation, using the calculated A_s , B_s and C_s :

$$F_{0j} = A_s + B_s \times v_j + C_s \times v_j^2$$

8.1.3.4. For dynamometer load setting, two different methods may be used. If the vehicle is accelerated by the dynamometer, the methods described in paragraph 8.1.3.4.1. of this Sub-Annex shall be used. If the vehicle is accelerated under its own power, the methods in paragraphs 8.1.3.4.1. or 8.1.3.4.2. of this Sub-Annex shall be used. The minimum acceleration multiplied by speed shall be $6 \text{ m}^2/\text{sec}^3$. Vehicles which are unable to achieve $6 \text{ m}^2/\text{s}^3$ shall be driven with the acceleration control fully applied.

8.1.3.4.1. Fixed run method

8.1.3.4.1. The dynamometer software shall perform four coastdowns in total: From the first coastdown, the dynamometer setting coefficients for the second run according to paragraph 8.1.4. of this Sub-Annex shall be calculated. Following the first coastdown, the software shall perform three additional coastdowns with either the fixed dynamometer setting coefficients determined after the first coastdown or the adjusted dynamometer setting coefficients according to paragraph 8.1.4. of this Sub-Annex.

8.1.3.4.1. The final dynamometer setting coefficients A, B and C shall be calculated using the following equations:

$$A = A_t - \frac{\sum_{i=1}^{n-2} (A_{sn} - A_{dn})}{3}$$

$$B = B_t - \frac{\sum_{i=1}^{n-2} (B_{sn} - B_{dn})}{3}$$

$$C = C_t - \frac{\sum_{i=1}^{n-2} (C_{sn} - C_{dn})}{3}$$

where:

A_t , B_t and C_t are the target road load parameters f_0 , f_1 and f_2 respectively;
 A_{sn} , B_{sn} and C_{sn} are the simulated road load coefficients of the n^{th} run;
 A_{dn} , B_{dn} and C_{dn} are the dynamometer setting coefficients of the n^{th} run;
 n is the index number of coastdowns including the first stabilisation run.

8.1.3.4.2. Iterative method

The calculated forces in the specified speed ranges shall either be within a tolerance of $\pm 10 \text{ N}$ after a least squares regression of the forces for two consecutive coastdowns, or additional coastdowns shall be performed after adjusting the chassis dynamometer load setting according to paragraph 8.1.4. of this Sub-Annex until the tolerance is satisfied.

8.1.4. Adjustment

The chassis dynamometer setting load shall be adjusted according to the following equations:

$$F_s^{dj} = F_{0j} - F_j = F_{0j} - F_{0j} + F_{0j}$$

$$= (A_d + B_d v_j + C_d v_j^2) - (A_s + B_s v_j + C_s v_j^2) + (A_t + B_t v_j + C_t v_j^2)$$

$$= (A_d + A_t - A_s) + (B_d + B_t - B_s) v_j + (C_d + C_t - C_s) v_j^2$$

Therefore:

$$A_s^d = A_d + A_t - A_s$$

$$B_s^d = B_d + B_t - B_s$$

Status: Point in time view as at 01/06/2017.

Changes to legislation: There are outstanding changes not yet made to Commission Regulation (EU) 2017/1151. Any changes that have already been made to the legislation appear in the content and are referenced with annotations. (See end of Document for details)

$$C_d^* = C_d + C_t - C_s$$

where:

F_{dj} is the initial chassis dynamometer setting load, N;
 F_{dj}^* is the adjusted chassis dynamometer setting load, N;
 F_j is the adjustment road load equal to $(F_{sj} - F_{tj})$, N;
 F_{sj} is the simulated road load at reference speed v_j , N;
 F_{tj} is the target road load at reference speed v_j , N;
 A_d^* , B_d^* and C_d^* are the new chassis dynamometer setting coefficients.

8.2. Chassis dynamometer load setting using the torque meter method

This method is applicable when the running resistance is determined using the torque meter method described in paragraph 4.4. of this Sub-Annex.

In the case of a road load matrix family, this method shall be applied when the running resistance of the representative vehicle is determined using the torque meter method as specified in paragraph 4.4. of this Sub-Annex. The target road load values are the values calculated using the method specified in paragraph 5.1. of this Sub-Annex.

8.2.1. Initial load setting

For a chassis dynamometer of coefficient control, the chassis dynamometer power absorption unit shall be adjusted with the arbitrary initial coefficients, A_d , B_d and C_d , of the following equation:

$$F_d = A_d + B_d v + C_d v^2$$

where:

F_d is the chassis dynamometer setting load, N;
 v is the speed of the chassis dynamometer roller, km/h.

The following coefficients are recommended for the initial load setting:

$$(a) \quad A_d = 0,5 \times \frac{a_t}{r}, B_d = 0,2 \times \frac{b_t}{r}, C_d = \frac{c_t}{r}$$

for single-axis chassis dynamometers, or

$$A_d = 0,1 \times \frac{a_t}{r}, B_d = 0,2 \times \frac{b_t}{r}, C_d = \frac{c_t}{r}$$

for dual-axis chassis dynamometers, where:

a_t , b_t and c_t are the target running resistance coefficients; and

r is the dynamic radius of the tyre on the chassis dynamometer obtained at 80 km/h, m.; or

(b) Empirical values, such as those used for the setting for a similar type of vehicle.

For a chassis dynamometer of polygonal control, adequate load values at each reference speed shall be set for the chassis dynamometer power absorption unit.

8.2.2. Wheel torque measurement

The torque measurement test on the chassis dynamometer shall be performed with the procedure defined in paragraph 4.4.2. of this Sub-Annex. The torque meter(s) shall be identical to the one(s) used in the preceding road test.

Status: Point in time view as at 01/06/2017.

Changes to legislation: There are outstanding changes not yet made to Commission Regulation (EU) 2017/1151. Any changes that have already been made to the legislation appear in the content and are referenced with annotations. (See end of Document for details)

8.2.3. Verification

8.2.3.1. The target running resistance (torque) curve shall be determined using the equation in paragraph 4.5.5.2.1. of this Sub-Annex and may be written as follows:

$$C_r^t = a_t + b_t \times v_j + c_t \times v_j^2$$

8.2.3.2. The simulated running resistance (torque) curve on the chassis dynamometer shall be calculated according to the method described and the measurement precision specified in paragraph 4.4.3. of this Sub-Annex, and the running resistance (torque) curve determination as described in paragraph 4.4.4. of this Sub-Annex with applicable corrections according to paragraph 4.5. of this Sub-Annex, all with the exception of measuring in opposite directions, resulting in a simulated running resistance curve:

$$C_r^s = C_{0s} + C_{1s} \times v_j + C_{2s} \times v_j^2$$

The simulated running resistance (torque) shall be within a tolerance of $\pm 10 \text{ N} \times r'$ from the target running resistance at every speed reference point where r' is the dynamic radius of the tyre in metres on the chassis dynamometer obtained at 80 km/h.

If the tolerance at any reference speed does not satisfy the criterion of the method described in this paragraph, the procedure specified in paragraph 8.2.3.3. of this Sub-Annex shall be used to adjust the chassis dynamometer load setting.

8.2.3.3. Adjustment

The chassis dynamometer load setting shall be adjusted using the following equation:

$$\begin{aligned} F_{ej}^* &= F_{dj} - \frac{F_{dj}}{r'} = F_{dj} - \frac{F_{sj}}{r'} + \frac{F_{tj}}{r'} \\ &= \left(A_d + B_d v_j + C_d v_j^2 \right) - \frac{(a_s + b_s v_j + c_s v_j^2)}{r'} + \frac{(a_t + b_t v_j + c_t v_j^2)}{r'} \\ &= \left\{ A_d + \frac{(a_t - a_s)}{r'} \right\} + \left\{ B_d + \frac{(b_t - b_s)}{r'} \right\} v_j + \left\{ C_d + \frac{(c_t - c_s)}{r'} \right\} v_j^2 \end{aligned}$$

therefore:

$$A_d^* = A_d + \frac{a_t - a_s}{r'}$$

$$B_d^* = B_d + \frac{b_t - b_s}{r'}$$

$$C_d^* = C_d + \frac{c_t - c_s}{r'}$$

where:

F_{dj}^*	is the new chassis dynamometer setting load, N; $(F_{sj} - F_{tj})$, Nm;
F_{ej}	is the adjustment road load equal to $(F_{sj} - F_{tj})$, Nm;
F_{sj}	is the simulated road load at reference speed v_j , Nm;
F_{tj}	is the target road load at reference speed v_j , Nm;
A_d^* , B_d^* and C_d^*	are the new chassis dynamometer setting coefficients;
r'	is the dynamic radius of the tyre on the chassis dynamometer obtained at 80 km/h, m.

Paragraphs 8.2.2. and 8.2.3. of this Sub-Annex shall be repeated.

8.2.3.4. The mass of the driven axle(s), tyre specifications and chassis dynamometer load setting shall be included in all relevant test reports when the requirement of paragraph 8.2.3.2. of this Sub-Annex is fulfilled.

8.2.4. Transformation of running resistance coefficients to road load coefficients f_0 , f_1 , f_2

Status: Point in time view as at 01/06/2017.

Changes to legislation: There are outstanding changes not yet made to Commission Regulation (EU) 2017/1151. Any changes that have already been made to the legislation appear in the content and are referenced with annotations. (See end of Document for details)

8.2.4.1. If the vehicle does not coast down in a repeatable manner and a coastdown mode according to paragraph 4.2.1.8.5. of this Sub-Annex is not feasible, the coefficients f_0 , f_1 and f_2 in the road load equation shall be calculated using the equations in paragraph 8.2.4.1.1. of this Sub-Annex. In any other case, the procedure described in paragraphs 8.2.4.2. to 8.2.4.4. inclusive of this Sub-Annex shall be performed.

8.2.4.1.1.
$$f_0 = \frac{c_0}{r} \times 1,02$$

$$f_1 = \frac{c_1}{r} \times 1,02$$

$$f_2 = \frac{c_2}{r} \times 1,02$$

where:

c_0 , c_1 , c_2 are the running resistance coefficients determined in paragraph 4.4.4. of this Sub-Annex, Nm, Nm/(km/h), Nm/(km/h)²;
 r is the dynamic tyre radius of the vehicle with which the running resistance was determined, m.
1,02 is an approximate coefficient compensating for drivetrain losses.

8.2.4.1.2. The determined f_0 , f_1 , f_2 values shall not be used for a chassis dynamometer setting or any emission or range testing. They shall be used only in the following cases:

- (a) determination of downscaling, paragraph 8. of Sub-Annex 1;
- (b) determination of gearshift points, Sub-Annex 2;
- (c) interpolation of CO₂ and fuel consumption, paragraph 3.2.3 of Sub-Annex 7;
- (d) calculation of results of electrified vehicles, paragraph 4. in Sub-Annex 8.

8.2.4.2. Once the chassis dynamometer has been set within the specified tolerances, a vehicle coastdown procedure shall be performed on the chassis dynamometer as outlined in paragraph 4.3.1.3. of this Sub-Annex. The coastdown times shall be included in all relevant test sheets.

8.2.4.3. The road load F_j at reference speed v_j , N, shall be determined using the following equation:

$$F_j = \frac{1}{3,6} \times (TM + m_r) \times \frac{\Delta v}{\Delta t_j}$$

where:

F_j is the road load at reference speed v_j , N;
 TM is the test mass of the vehicle, kg;
 m_r is the equivalent effective mass of rotating components according to paragraph 2.5.1. of this Sub-Annex, kg;
 Δv = 10 km/h
 Δt_j is the coastdown time corresponding to speed v_j , s.

8.2.4.4. The coefficients f_0 , f_1 and f_2 in the road load equation shall be calculated with a least squares regression analysis over the reference speed range.

Status: Point in time view as at 01/06/2017.

Changes to legislation: There are outstanding changes not yet made to Commission Regulation (EU) 2017/1151. Any changes that have already been made to the legislation appear in the content and are referenced with annotations. (See end of Document for details)

Sub-Annex 5

Test equipment and calibrations

1. Test bench specifications and settings
 - 1.1. Cooling fan specifications
 - 1.1.1. A variable speed current of air shall be blown towards the vehicle. The set point of the linear velocity of the air at the blower outlet shall be equal to the corresponding roller speed above roller speeds of 5 km/h. The deviation of the linear velocity of the air at the blower outlet shall remain within ± 5 km/h or ± 10 per cent of the corresponding roller speed, whichever is greater.
 - 1.1.2. The above-mentioned air velocity shall be determined as an averaged value of a number of measuring points that:
 - (a) For fans with rectangular outlets, are located at the centre of each rectangle dividing the whole of the fan outlet into 9 areas (dividing both horizontal and vertical sides of the fan outlet into 3 equal parts). The centre area shall not be measured (as shown in Figure A5/1);

Figure A5/1

Fan with rectangular outlet

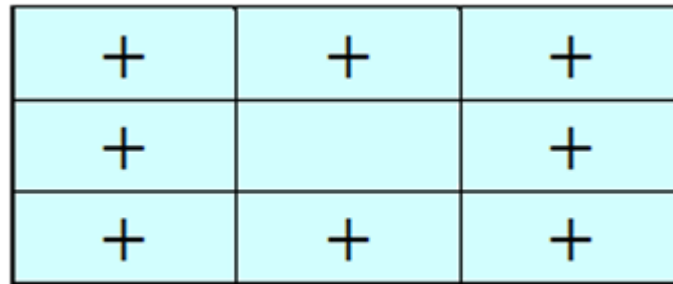

- (b) For fans with circular outlets, the outlet shall be divided into 8 equal sectors by vertical, horizontal and 45° lines. The measurement points shall lie on the radial centre line of each sector ($22,5^\circ$) at two-thirds of the outlet radius (as shown in Figure A5/2).

Figure A5/2

Status: Point in time view as at 01/06/2017.

Changes to legislation: There are outstanding changes not yet made to Commission Regulation (EU) 2017/1151. Any changes that have already been made to the legislation appear in the content and are referenced with annotations. (See end of Document for details)

Fan with circular outlet

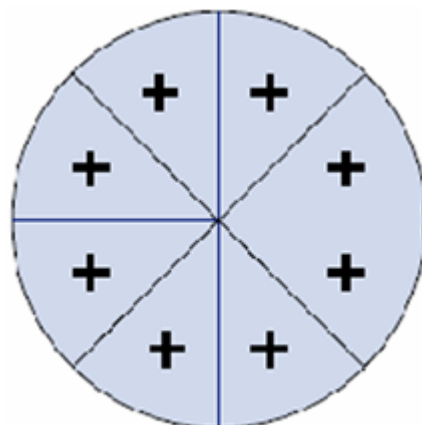

These measurements shall be made with no vehicle or other obstruction in front of the fan. The device used to measure the linear velocity of the air shall be located between 0 and 20 cm from the air outlet.

1.1.3. The outlet of the fan shall have the following characteristics:

- (a) An area of at least 0,3 m²; and
- (b) A width/diameter of at least 0,8 metre.

1.1.4. The position of the fan shall be as follows:

- (a) Height of the lower edge above ground: approximately 20 cm;
- (b) Distance from the front of the vehicle: approximately 30 cm.

1.1.5. The height and lateral position of the cooling fan may be modified at the request of the manufacturer and, if considered appropriate, by the approval authority.

1.1.6. In the cases described in paragraph 1.1.5. of this Sub-Annex, the position of the cooling fan (height and distance) shall be included in all relevant test reports and shall be used for any subsequent testing.

2. Chassis dynamometer

2.1. General requirements

2.1.1. The dynamometer shall be capable of simulating road load with three road load coefficients that can be adjusted to shape the load curve.

2.1.2. The chassis dynamometer may have one or two rollers. In the case that twin-roller chassis dynamometers are used, the rollers shall be permanently coupled or the front roller shall drive, directly or indirectly, any inertial masses and the power absorption device.

2.2. Specific requirements

The following specific requirements relate to the dynamometer manufacturer's specifications.

2.2.1. The roller run-out shall be less than 0,25 mm at all measured locations.

Status: Point in time view as at 01/06/2017.

Changes to legislation: There are outstanding changes not yet made to Commission Regulation (EU) 2017/1151. Any changes that have already been made to the legislation appear in the content and are referenced with annotations. (See end of Document for details)

- 2.2.2. The roller diameter shall be within $\pm 1,0$ mm of the specified nominal value at all measurement locations.
- 2.2.3. The dynamometer shall have a time measurement system for use in determining acceleration rates and for measuring vehicle/dynamometer coastdown times. This time measurement system shall have an accuracy of at least $\pm 0,001$ per cent. This shall be verified upon initial installation.
- 2.2.4. The dynamometer shall have a speed measurement system with an accuracy of at least $\pm 0,080$ km/h. This shall be verified upon initial installation.
- 2.2.5. The dynamometer shall have a response time (90 per cent response to a tractive effort step change) of less than 100 ms with instantaneous accelerations that are at least 3 m/s^2 . This shall be verified upon initial installation and after major maintenance.
- 2.2.6. The base inertia of the dynamometer shall be stated by the dynamometer manufacturer and shall be confirmed to within $\pm 0,5$ per cent for each measured base inertia and $\pm 0,2$ per cent relative to any arithmetic average value by dynamic derivation from trials at constant acceleration, deceleration and force.
- 2.2.7. Roller speed shall be measured at a frequency of not less than 1 Hz.
- 2.3. Additional specific requirements for chassis dynamometers for vehicles to be tested in four wheel drive (4WD) mode
- 2.3.1. The 4WD control system shall be designed such that the following requirements are fulfilled when tested with a vehicle driven over the WLTC.
- 2.3.1.1. Road load simulation shall be applied such that operation in 4WD mode reproduces the same proportioning of forces as would be encountered when driving the vehicle on a smooth, dry, level road surface.
- 2.3.1.2. Upon initial installation and after major maintenance, the requirements of paragraph 2.3.1.2.1. of this Sub-Annex and either paragraph 2.3.1.2.2. or 2.3.1.2.3. of this Sub-Annex shall be satisfied. The speed difference between the front and rear rollers is assessed by applying a 1 second moving average filter to roller speed data acquired at a minimum frequency of 20 Hz.
- 2.3.1.2.1. The difference in distance covered by the front and rear rollers shall be less than 0,2 per cent of the distance driven over the WLTC. The absolute number shall be integrated for the calculation of the total difference in distance over the WLTC.
- 2.3.1.2.2. The difference in distance covered by the front and rear rollers shall be less than 0,1 m in any 200 ms time period.
- 2.3.1.2.3. The speed difference of all roller speeds shall be within $\pm 0,16$ km/h.
- 2.4. Chassis dynamometer calibration
- 2.4.1. Force measurement system
- The accuracy and linearity of the force transducer shall be at least ± 10 N for all measured increments. This shall be verified upon initial installation, after major maintenance and within 370 days before testing.
- 2.4.2. Dynamometer parasitic loss calibration

Status: Point in time view as at 01/06/2017.

Changes to legislation: There are outstanding changes not yet made to Commission Regulation (EU) 2017/1151. Any changes that have already been made to the legislation appear in the content and are referenced with annotations. (See end of Document for details)

The dynamometer's parasitic losses shall be measured and updated if any measured value differs from the current loss curve by more than 9,0 N. This shall be verified upon initial installation, after major maintenance and within 35 days before testing.

2.4.3. Verification of road load simulation without a vehicle

The dynamometer performance shall be verified by performing an unloaded coastdown test upon initial installation, after major maintenance, and within 7 days before testing. The arithmetic average coastdown force error shall be less than 10 N or 2 per cent, whichever is greater, at each reference speed point.

3. Exhaust gas dilution system

3.1. System specification

3.1.1. Overview

3.1.1.1. A full flow exhaust dilution system shall be used. The total vehicle exhaust shall be continuously diluted with ambient air under controlled conditions using a constant volume sampler. A critical flow venturi (CFV) or multiple critical flow venturis arranged in parallel, a positive displacement pump (PDP), a subsonic venturi (SSV), or an ultrasonic flow meter (UFM) may be used. The total volume of the mixture of exhaust and dilution air shall be measured and a continuously proportional sample of the volume shall be collected for analysis. The quantities of exhaust gas compounds shall be determined from the sample concentrations, corrected for their respective content of the dilution air and the totalised flow over the test period.

3.1.1.2. The exhaust dilution system shall consist of a connecting tube, a mixing device and dilution tunnel, dilution air conditioning, a suction device and a flow measurement device. Sampling probes shall be fitted in the dilution tunnel as specified in paragraphs 4.1., 4.2. and 4.3. of this Sub-Annex.

3.1.1.3. The mixing device referred to in paragraph 3.1.1.2. of this Sub-Annex shall be a vessel such as that illustrated in Figure A5/3 in which vehicle exhaust gases and the dilution air are combined so as to produce a homogeneous mixture at the sampling position.

3.2. General requirements

3.2.1. The vehicle exhaust gases shall be diluted with a sufficient amount of ambient air to prevent any water condensation in the sampling and measuring system at all conditions that may occur during a test.

3.2.2. The mixture of air and exhaust gases shall be homogeneous at the point where the sampling probes are located (paragraph 3.3.3. of this Sub-Annex). The sampling probes shall extract representative samples of the diluted exhaust gas.

3.2.3. The system shall enable the total volume of the diluted exhaust gases to be measured.

3.2.4. The sampling system shall be gas-tight. The design of the variable dilution sampling system and the materials used in its construction shall be such that the concentration of any compound in the diluted exhaust gases is not affected. If any component in the system (heat exchanger, cyclone separator, suction device, etc.) changes the concentration of any of the exhaust gas compounds and the systematic error cannot be corrected, sampling for that compound shall be carried out upstream from that component.

Status: Point in time view as at 01/06/2017.

Changes to legislation: There are outstanding changes not yet made to Commission Regulation (EU) 2017/1151. Any changes that have already been made to the legislation appear in the content and are referenced with annotations. (See end of Document for details)

3.2.5. All parts of the dilution system in contact with raw or diluted exhaust gas shall be designed to minimise deposition or alteration of the particulate or particles. All parts shall be made of electrically conductive materials that do not react with exhaust gas components, and shall be electrically grounded to prevent electrostatic effects.

3.2.6. If the vehicle being tested is equipped with an exhaust pipe comprising several branches, the connecting tubes shall be connected as near as possible to the vehicle without adversely affecting their operation.

3.3. Specific requirements

3.3.1. Connection to vehicle exhaust

3.3.1.1. The start of the connecting tube is the exit of the tailpipe. The end of the connecting tube is the sample point, or first point of dilution.

For multiple tailpipe configurations where all the tailpipes are combined, the start of the connecting tube shall be taken at the last joint of where all the tailpipes are combined. In this case, the tube between the exit of the tailpipe and the start of the connecting tube may or may not be insulated or heated.

3.3.1.2. The connecting tube between the vehicle and dilution system shall be designed so as to minimize heat loss.

3.3.1.3. The connecting tube shall satisfy the following requirements:

(a) Be less than 3.6 metres long, or less than 6.1 metres long if heat-insulated. Its internal diameter shall not exceed 105 mm; the insulating materials shall have a thickness of at least 25 mm and thermal conductivity shall not exceed $0,1 \text{ W/m}^{-1}\text{K}^{-1}$ at $400 \text{ }^{\circ}\text{C}$. Optionally, the tube may be heated to a temperature above the dew point. This may be assumed to be achieved if the tube is heated to $70 \text{ }^{\circ}\text{C}$;

(b) Not cause the static pressure at the exhaust outlets on the vehicle being tested to differ by more than $\pm 0,75 \text{ kPa}$ at 50 km/h , or more than $\pm 1,25 \text{ kPa}$ for the duration of the test from the static pressures recorded when nothing is connected to the vehicle exhaust pipes. The pressure shall be measured in the exhaust outlet or in an extension having the same diameter and as near as possible to the end of the tailpipe. Sampling systems capable of maintaining the static pressure to within $\pm 0,25 \text{ kPa}$ may be used if a written request from a manufacturer to the approval authority substantiates the need for the closer tolerance;

(c) No component of the connecting tube shall be of a material that might affect the gaseous or solid composition of the exhaust gas. To avoid generation of any particles from elastomer connectors, elastomers employed shall be as thermally stable as possible and have minimum exposure to the exhaust gas. It is recommended not to use elastomer connectors to bridge the connection between the vehicle exhaust and the connecting tube.

3.3.2. Dilution air conditioning

3.3.2.1. The dilution air used for the primary dilution of the exhaust in the CVS tunnel shall pass through a medium capable of reducing particles of the most penetrating particle size in the filter material by $\leq 99,95$ per cent, or through a filter of at least class H13 of EN 1822:2009. This represents the specification of High Efficiency Particulate Air (HEPA) filters. The dilution air may optionally be charcoal-scrubbed before being

Status: Point in time view as at 01/06/2017.

Changes to legislation: There are outstanding changes not yet made to Commission Regulation (EU) 2017/1151. Any changes that have already been made to the legislation appear in the content and are referenced with annotations. (See end of Document for details)

passed to the HEPA filter. It is recommended that an additional coarse particle filter be situated before the HEPA filter and after the charcoal scrubber, if used.

3.3.2.2. At the vehicle manufacturer's request, the dilution air may be sampled according to good engineering practice to determine the tunnel contribution to background particulate and particle levels, which can be subsequently subtracted from the values measured in the diluted exhaust. See paragraph 1.2.1.3. of Sub-Annex 6.

3.3.3. Dilution tunnel

3.3.3.1. Provision shall be made for the vehicle exhaust gases and the dilution air to be mixed. A mixing device may be used.

3.3.3.2. The homogeneity of the mixture in any cross-section at the location of the sampling probe shall not vary by more than ± 2 per cent from the arithmetic average of the values obtained for at least five points located at equal intervals on the diameter of the gas stream.

3.3.3.3. For PM and PN emissions sampling, a dilution tunnel shall be used that:

- (a) Consists of a straight tube of electrically-conductive material that is grounded;
- (b) Causes turbulent flow (Reynolds number $\geq 4\ 000$) and be of sufficient length to cause complete mixing of the exhaust and dilution air;
- (c) Is at least 200 mm in diameter;
- (d) May be insulated and/or heated.

3.3.4. Suction device

3.3.4.1. This device may have a range of fixed speeds to ensure sufficient flow to prevent any water condensation. This result is obtained if the flow is either:

- (a) Twice as high as the maximum flow of exhaust gas produced by accelerations of the driving cycle; or
- (b) Sufficient to ensure that the CO₂ concentration in the dilute exhaust sample bag is less than 3 per cent by volume for petrol and diesel, less than 2.2 per cent by volume for LPG and less than 1.5 per cent by volume for NG/biomethane.

3.3.4.2. Compliance with the requirements in paragraph 3.3.4.1. of this Sub-Annex may not be necessary if the CVS system is designed to inhibit condensation by such techniques, or combination of techniques, as:

- (a) Reducing water content in the dilution air (dilution air dehumidification);
- (b) Heating of the CVS dilution air and of all components up to the diluted exhaust flow measurement device and, optionally, the bag sampling system including the sample bags and also the system for the measurement of the bag concentrations.

In such cases, the selection of the CVS flow rate for the test shall be justified by showing that condensation of water cannot occur at any point within the CVS, bag sampling or analytical system.

3.3.5. Volume measurement in the primary dilution system

3.3.5.1. The method of measuring total dilute exhaust volume incorporated in the constant volume sampler shall be such that measurement is accurate to ± 2 per cent under all

Status: Point in time view as at 01/06/2017.

Changes to legislation: There are outstanding changes not yet made to Commission Regulation (EU) 2017/1151. Any changes that have already been made to the legislation appear in the content and are referenced with annotations. (See end of Document for details)

operating conditions. If the device cannot compensate for variations in the temperature of the mixture of exhaust gases and dilution air at the measuring point, a heat exchanger shall be used to maintain the temperature to within ± 6 °C of the specified operating temperature for a PDP CVS, ± 11 °C for a CFV CVS, ± 6 °C for a UFM CVS, and ± 11 °C for an SSV CVS.

- 3.3.5.2. If necessary, some form of protection for the volume measuring device may be used e.g. a cyclone separator, bulk stream filter, etc.
- 3.3.5.3. A temperature sensor shall be installed immediately before the volume measuring device. This temperature sensor shall have an accuracy and a precision of ± 1 °C and a response time of 0,1 seconds at 62 per cent of a given temperature variation (value measured in silicone oil).
- 3.3.5.4. Measurement of the pressure difference from atmospheric pressure shall be taken upstream from and, if necessary, downstream from the volume measuring device.
- 3.3.5.5. The pressure measurements shall have a precision and an accuracy of $\pm 0,4$ kPa during the test. See Table A5/5.
- 3.3.6. Recommended system description

Figure A5/3 is a schematic drawing of exhaust dilution systems that meet the requirements of this Sub-Annex.

The following components are recommended:

- (a) A dilution air filter, which may be pre-heated if necessary. This filter shall consist of the following filters in sequence: an optional activated charcoal filter (inlet side), and a HEPA filter (outlet side). It is recommended that an additional coarse particle filter be situated before the HEPA filter and after the charcoal filter, if used. The purpose of the charcoal filter is to reduce and stabilize the hydrocarbon concentrations of ambient emissions in the dilution air;
- (b) A connecting tube by which vehicle exhaust is admitted into a dilution tunnel;
- (c) An optional heat exchanger as described in paragraph 3.3.5.1. of this Sub-Annex;
- (d) A mixing device in which exhaust gas and dilution air are mixed homogeneously, and which may be located close to the vehicle so that the length of the connecting tube is minimized;
- (e) A dilution tunnel from which particulate and particles are sampled;
- (f) Some form of protection for the measurement system may be used e.g. a cyclone separator, bulk stream filter, etc.;
- (g) A suction device of sufficient capacity to handle the total volume of diluted exhaust gas.

Exact conformity with these figures is not essential. Additional components such as instruments, valves, solenoids and switches may be used to provide additional information and co-ordinate the functions of the component system.

Figure A5/3

Status: Point in time view as at 01/06/2017.

Changes to legislation: There are outstanding changes not yet made to Commission Regulation (EU) 2017/1151. Any changes that have already been made to the legislation appear in the content and are referenced with annotations. (See end of Document for details)

Exhaust dilution system

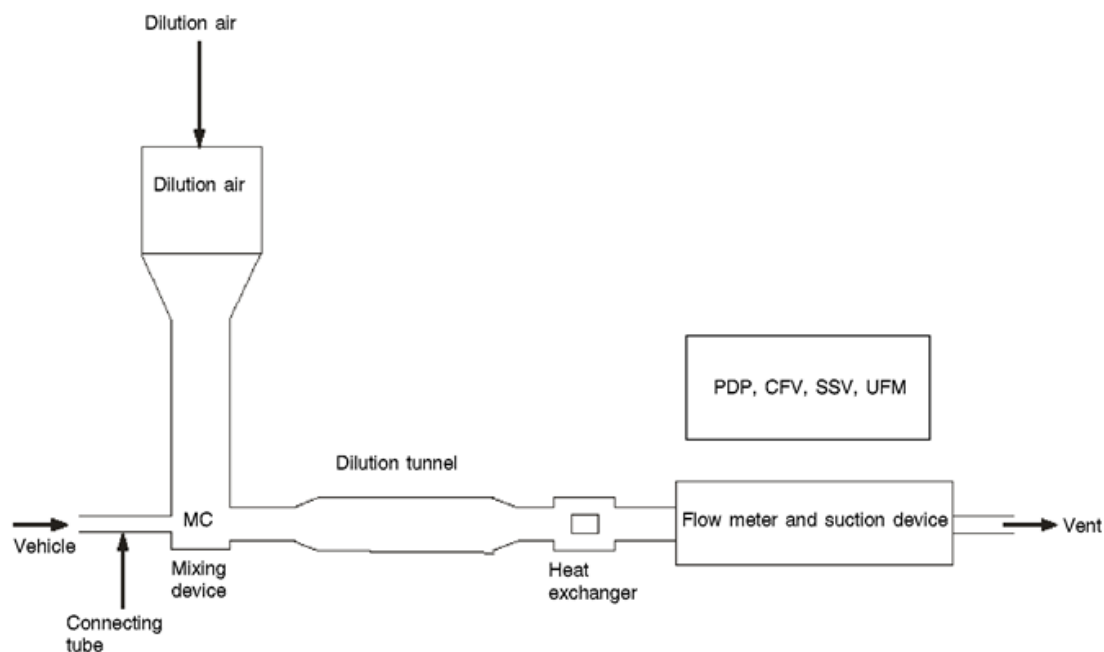

3.3.6.1. Positive displacement pump (PDP)

3.3.6.1.1. A positive displacement pump (PDP) full flow exhaust dilution system satisfies the requirements of this Sub-Annex by metering the flow of gas through the pump at constant temperature and pressure. The total volume is measured by counting the revolutions made by the calibrated positive displacement pump. The proportional sample is achieved by sampling with pump, flow meter and flow control valve at a constant flow rate.

3.3.6.2. Critical flow venturi (CFV)

3.3.6.2.1. The use of a CFV for the full flow exhaust dilution system is based on the principles of flow mechanics for critical flow. The variable mixture flow rate of dilution and exhaust gas is maintained at sonic velocity that is directly proportional to the square root of the gas temperature. Flow is continually monitored, computed and integrated throughout the test.

3.3.6.2.2. The use of an additional critical flow sampling venturi ensures the proportionality of the gas samples taken from the dilution tunnel. As both pressure and temperature are equal at the two venturi inlets, the volume of the gas flow diverted for sampling is proportional to the total volume of diluted exhaust gas mixture produced, and thus the requirements of this Sub-Annex are fulfilled.

3.3.6.2.3. A measuring CFV tube shall measure the flow volume of the diluted exhaust gas.

3.3.6.3. Subsonic flow venturi (SSV)

3.3.6.3.1. The use of an SSV (Figure A5/4) for a full flow exhaust dilution system is based on the principles of flow mechanics. The variable mixture flow rate of dilution and exhaust gas is maintained at a subsonic velocity that is calculated from the physical dimensions of the subsonic venturi and measurement of the absolute temperature (T) and pressure

Status: Point in time view as at 01/06/2017.

Changes to legislation: There are outstanding changes not yet made to Commission Regulation (EU) 2017/1151. Any changes that have already been made to the legislation appear in the content and are referenced with annotations. (See end of Document for details)

(P) at the venturi inlet and the pressure in the throat of the venturi. Flow is continually monitored, computed and integrated throughout the test.

3.3.6.3.2. An SSV shall measure the flow volume of the diluted exhaust gas.

Figure A5/4

Schematic of a subsonic venturi tube (SSV)

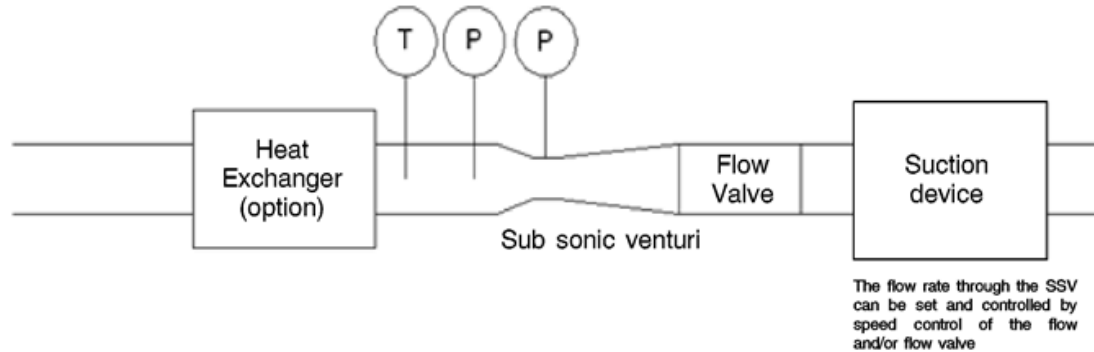

3.3.6.4. Ultrasonic flow meter (UFM)

3.3.6.4.1. A UFM measures the velocity of the diluted exhaust gas in the CVS piping using the principle of ultrasonic flow detection by means of a pair, or multiple pairs, of ultrasonic transmitters/receivers mounted within the pipe as in Figure A5/5. The velocity of the flowing gas is determined by the difference in the time required for the ultrasonic signal to travel from transmitter to receiver in the upstream direction and the downstream direction. The gas velocity is converted to standard volumetric flow using a calibration factor for the tube diameter with real time corrections for the diluted exhaust temperature and absolute pressure.

3.3.6.4.2. Components of the system include:

- (a) A suction device fitted with speed control, flow valve or other method for setting the CVS flow rate and also for maintaining constant volumetric flow at standard conditions;
- (b) A UFM;
- (c) Temperature and pressure measurement devices, T and P, required for flow correction;
- (d) An optional heat exchanger for controlling the temperature of the diluted exhaust to the UFM. If installed, the heat exchanger shall be capable of controlling the temperature of the diluted exhaust to that specified in paragraph 3.3.5.1. of this Sub-Annex. Throughout the test, the temperature of the air/exhaust gas mixture measured at a point immediately upstream of the suction device shall be within ± 6 °C of the arithmetic average operating temperature during the test.

Figure A5/5

Status: Point in time view as at 01/06/2017.

Changes to legislation: There are outstanding changes not yet made to Commission Regulation (EU) 2017/1151. Any changes that have already been made to the legislation appear in the content and are referenced with annotations. (See end of Document for details)

Schematic of an ultrasonic flow meter (UFM)

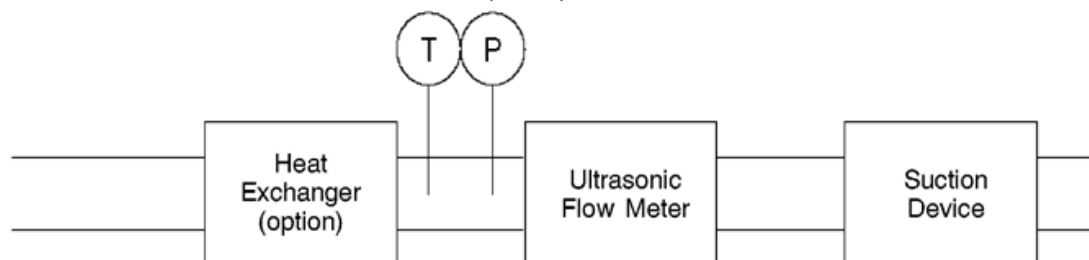

3.3.6.4.3. The following conditions shall apply to the design and use of the UFM type CVS:

- (a) The velocity of the diluted exhaust gas shall provide a Reynolds number higher than 4 000 in order to maintain a consistent turbulent flow before the ultrasonic flow meter;
- (b) An ultrasonic flow meter shall be installed in a pipe of constant diameter with a length of 10 times the internal diameter upstream and 5 times the diameter downstream;
- (c) A temperature sensor (T) for the diluted exhaust shall be installed immediately before the ultrasonic flow meter. This sensor shall have an accuracy and a precision of ± 1 °C and a response time of 0,1 seconds at 62 per cent of a given temperature variation (value measured in silicone oil);
- (d) The absolute pressure (P) of the diluted exhaust shall be measured immediately before the ultrasonic flow meter to within $\pm 0,3$ kPa;
- (e) If a heat exchanger is not installed upstream of the ultrasonic flow meter, the flow rate of the diluted exhaust, corrected to standard conditions, shall be maintained at a constant level during the test. This may be achieved by control of the suction device, flow valve or other method.

3.4. CVS calibration procedure

3.4.1. General requirements

3.4.1.1. The CVS system shall be calibrated by using an accurate flow meter and a restricting device and at the intervals listed in Table A5/4. The flow through the system shall be measured at various pressure readings and the control parameters of the system measured and related to the flows. The flow metering device (e.g. calibrated venturi, laminar flow element (LFE), calibrated turbine meter) shall be dynamic and suitable for the high flow rate encountered in constant volume sampler testing. The device shall be of certified accuracy traceable to an approved national or international standard.

3.4.1.2. The following paragraphs describe methods for calibrating PDP, CFV, SSV and UFM units using a laminar flow meter, which gives the required accuracy, along with a statistical check on the calibration validity.

3.4.2. Calibration of a positive displacement pump (PDP)

3.4.2.1. The following calibration procedure outlines the equipment, the test configuration and the various parameters that are measured to establish the flow rate of the CVS pump. All the parameters related to the pump are simultaneously measured with the parameters related to the flow meter that is connected in series with the pump. The calculated flow rate (given in m^3/min at pump inlet for the measured absolute

Status: Point in time view as at 01/06/2017.

Changes to legislation: There are outstanding changes not yet made to Commission Regulation (EU) 2017/1151. Any changes that have already been made to the legislation appear in the content and are referenced with annotations. (See end of Document for details)

pressure and temperature) shall be subsequently plotted versus a correlation function that includes the relevant pump parameters. The linear equation that relates the pump flow and the correlation function shall be subsequently determined. In the case that a CVS has a multiple speed drive, a calibration for each range used shall be performed.

3.4.2.2. This calibration procedure is based on the measurement of the absolute values of the pump and flow meter parameters relating the flow rate at each point. The following conditions shall be maintained to ensure the accuracy and integrity of the calibration curve:

3.4.2.2.1. The pump pressures shall be measured at tappings on the pump rather than at the external piping on the pump inlet and outlet. Pressure taps that are mounted at the top centre and bottom centre of the pump drive head plate are exposed to the actual pump cavity pressures, and therefore reflect the absolute pressure differentials.

3.4.2.2.2. Temperature stability shall be maintained during the calibration. The laminar flow meter is sensitive to inlet temperature oscillations that cause data points to be scattered. Gradual changes of ± 1 °C in temperature are acceptable as long as they occur over a period of several minutes.

3.4.2.2.3. All connections between the flow meter and the CVS pump shall be free of leakage.

3.4.2.3. During an exhaust emissions test, the measured pump parameters shall be used to calculate the flow rate from the calibration equation.

3.4.2.4. Figure A5/6 of this Sub-Annex shows an example of a calibration set-up. Variations are permissible, provided that the approval authority approves them as being of comparable accuracy. If the set-up shown in Figure A5/6 is used, the following data shall be found within the limits of accuracy given:

Barometric pressure (corrected), $P_b \pm 0,03$ kPa

Ambient temperature, $T \pm 0,2$ K

Air temperature at LFE, $ETI \pm 0,15$ K

Pressure depression upstream of LFE, $EPI \pm 0,01$ kPa

Pressure drop across the LFE matrix, $EDP \pm 0,0015$ kPa

Air temperature at CVS pump inlet, $PTI \pm 0,2$ K

Air temperature at CVS pump outlet, $PTO \pm 0,2$ K

Pressure depression at CVS pump inlet, $PPI \pm 0,22$ kPa

Pressure head at CVS pump outlet, $PPO \pm 0,22$ kPa

Pump revolutions during test period, $n \pm 1$ min⁻¹

Elapsed time for period (minimum 250 s), $t \pm 0,1$ s

Figure A5/6

Status: Point in time view as at 01/06/2017.

Changes to legislation: There are outstanding changes not yet made to Commission Regulation (EU) 2017/1151. Any changes that have already been made to the legislation appear in the content and are referenced with annotations. (See end of Document for details)

PDP calibration configuration

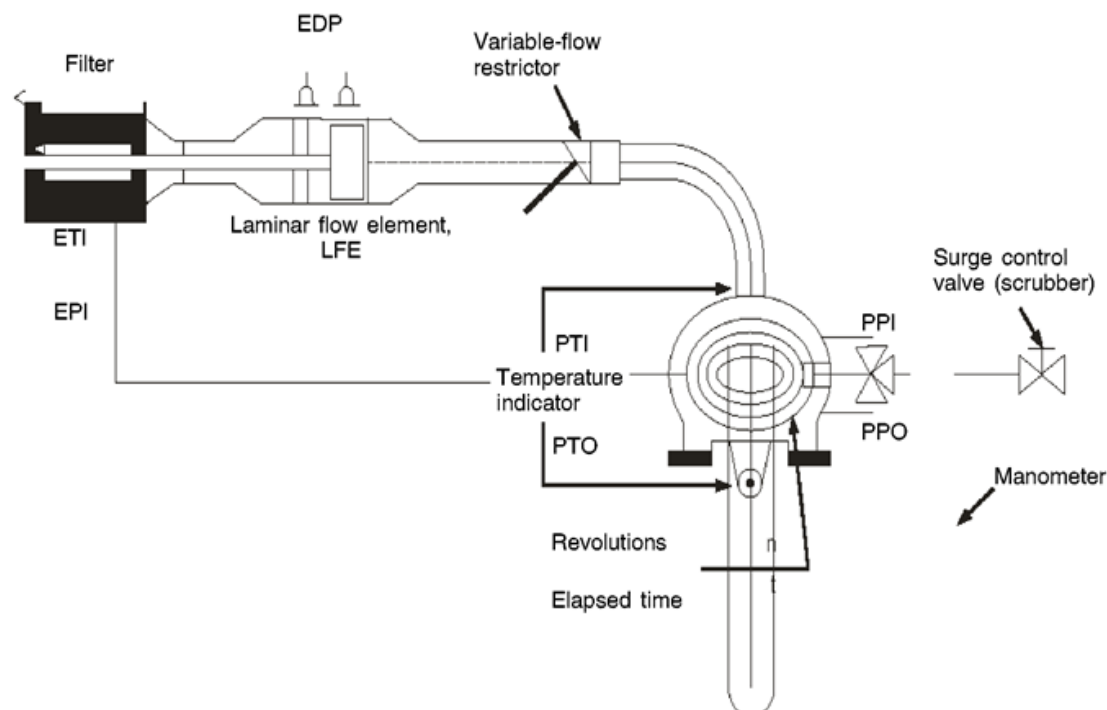

3.4.2.5. After the system has been connected as shown in Figure A5/6., the variable restrictor shall be set in the wide-open position and the CVS pump shall run for 20 minutes before starting the calibration.

3.4.2.5.1. The restrictor valve shall be reset to a more restricted condition in increments of pump inlet depression (about 1 kPa) that will yield a minimum of six data points for the total calibration. The system shall be allowed to stabilize for 3 minutes before the data acquisition is repeated.

3.4.2.5.2. The air flow rate Q_s at each test point shall be calculated in standard m^3/min from the flow meter data using the manufacturer's prescribed method.

3.4.2.5.3. The air flow rate shall be subsequently converted to pump flow V_0 in m^3/rev at absolute pump inlet temperature and pressure.

$$V_0 = \frac{Q_s}{n} \times \frac{T_p}{273,15 \text{ K}} \times \frac{101,325 \text{ kPa}}{P_p}$$

where:

- V_0 is the pump flow rate at T_p and P_p , m^3/rev ;
- Q_s is the air flow at 101,325 kPa and 273,15 K (0 °C), m^3/min ;
- T_p is the pump inlet temperature, Kelvin (K);
- P_p is the absolute pump inlet pressure, kPa;
- n is the pump speed, min^{-1} .

3.4.2.5.4. To compensate for the interaction of pump speed pressure variations at the pump and the pump slip rate, the correlation function x_0 between the pump speed n , the pressure

Status: Point in time view as at 01/06/2017.

Changes to legislation: There are outstanding changes not yet made to Commission Regulation (EU) 2017/1151. Any changes that have already been made to the legislation appear in the content and are referenced with annotations. (See end of Document for details)

differential from pump inlet to pump outlet and the absolute pump outlet pressure shall be calculated using the following equation:

$$x_0 = \frac{1}{n} \sqrt{\frac{\Delta P_p}{P_e}}$$

where:

x_0 is the correlation function;
 ΔP_p is the pressure differential from pump inlet to pump outlet, kPa;
 P_e absolute outlet pressure (PPO + P_b), kPa.

A linear least squares fit shall be performed to generate the calibration equations having the following form:

$$V_0 = D_0 - M \times x_0$$

$$n = A - B \times \Delta P_p$$

where B and M are the slopes, and A and D_0 are the intercepts of the lines.

3.4.2.6. A CVS system having multiple speeds shall be calibrated at each speed used. The calibration curves generated for the ranges shall be approximately parallel and the intercept values, D_0 shall increase as the pump flow range decreases.

3.4.2.7. The calculated values from the equation shall be within 0.5 per cent of the measured value of V_0 . Values of M will vary from one pump to another. A calibration shall be performed at initial installation and after major maintenance.

3.4.3. Calibration of a critical flow venturi (CFV)

3.4.3.1. Calibration of a CFV is based upon the flow equation for a critical venturi:

$$Q_s = \frac{K_v P}{\sqrt{T}}$$

where:

Q_s is the flow, m³/min;
 K_v is the calibration coefficient;
P is the absolute pressure, kPa;
T is the absolute temperature, Kelvin (K).

Gas flow is a function of inlet pressure and temperature.

The calibration procedure described in paragraph 3.4.3.2. to 3.4.3.3.4. inclusive of this Sub-Annex establishes the value of the calibration coefficient at measured values of pressure, temperature and air flow.

3.4.3.2. Measurements for flow calibration of a critical flow venturi are required and the following data shall be within the limits of precision given:

Barometric pressure (corrected), $P_b \pm 0,03$ kPa,

LFE air temperature, flow meter, ETI $\pm 0,15$ K,

Pressure depression upstream of LFE, EPI $\pm 0,01$ kPa,

Pressure drop across LFE matrix, EDP $\pm 0,0015$ kPa,

Air flow, $Q_s \pm 0,5$ per cent,

CFV inlet depression, PPI $\pm 0,02$ kPa,

Temperature at venturi inlet, $T_v \pm 0,2$ K.

Status: Point in time view as at 01/06/2017.

Changes to legislation: There are outstanding changes not yet made to Commission Regulation (EU) 2017/1151. Any changes that have already been made to the legislation appear in the content and are referenced with annotations. (See end of Document for details)

3.4.3.3. The equipment shall be set up as shown in Figure A5/7 and checked for leaks. Any leaks between the flow-measuring device and the critical flow venturi will seriously affect the accuracy of the calibration and shall therefore be prevented.

Figure A5/7

CFV calibration configuration

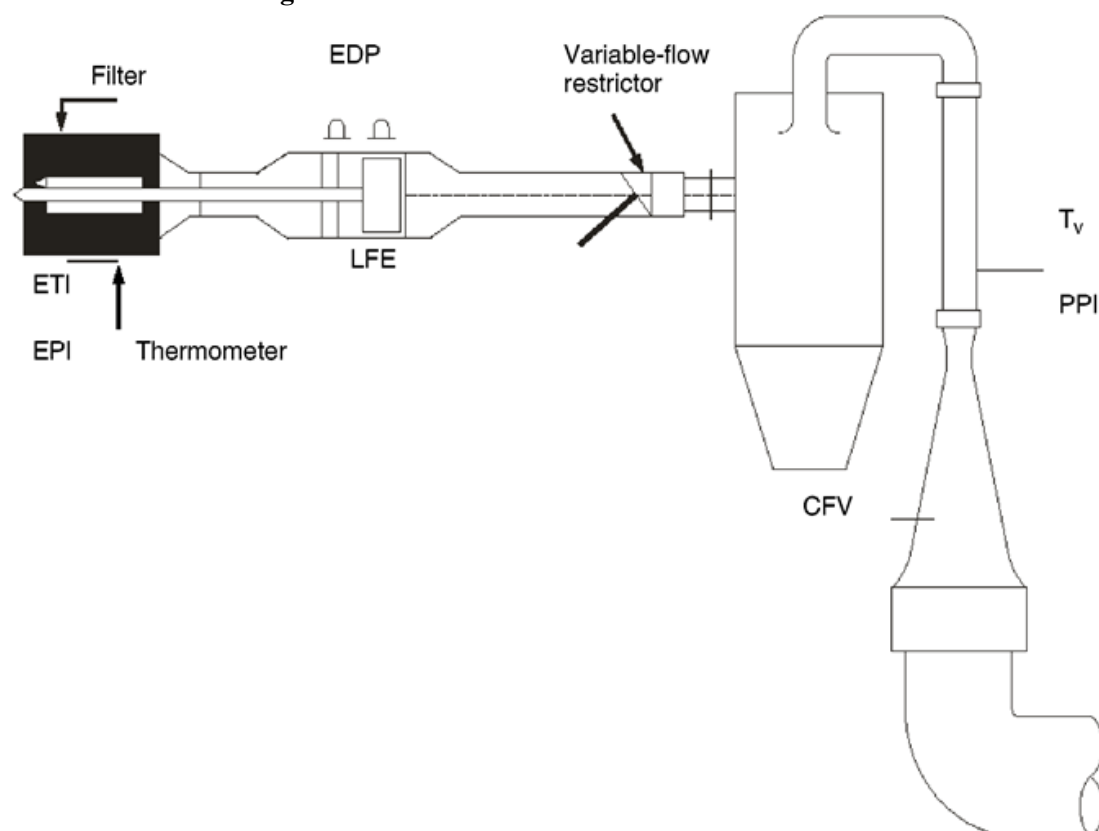

3.4.3.3.1. The variable-flow restrictor shall be set to the open position, the suction device shall be started and the system stabilized. Data from all instruments shall be collected.

3.4.3.3.2. The flow restrictor shall be varied and at least eight readings across the critical flow range of the venturi shall be made.

3.4.3.3.3. The data recorded during the calibration shall be used in the following calculation:

3.4.3.3.3. The air flow rate, Q_s at each test point shall be calculated from the flow meter data using the manufacturer's prescribed method.

Values of the calibration coefficient shall be calculated for each test point:

$$K_v = \frac{Q_s \sqrt{T_v}}{P}$$

where:

Q_s is the flow rate, m^3/min at 273,15 K (0 °C) and 101,325, kPa;

T_v is the temperature at the venturi inlet, Kelvin (K);

Status: Point in time view as at 01/06/2017.

Changes to legislation: There are outstanding changes not yet made to Commission Regulation (EU) 2017/1151. Any changes that have already been made to the legislation appear in the content and are referenced with annotations. (See end of Document for details)

P_v is the absolute pressure at the venturi inlet, kPa.

3.4.3.3.3. K_v shall be plotted as a function of venturi inlet pressure P_v . For sonic flow K_v will have a relatively constant value. As pressure decreases (vacuum increases), the venturi becomes unchoked and K_v decreases. These values of K_v shall not be used for further calculations.

3.4.3.3.3. For a minimum of eight points in the critical region, an arithmetic average K_v and the standard deviation shall be calculated.

3.4.3.3.3. If the standard deviation exceeds 0,3 per cent of the arithmetic average K_v , corrective action shall be taken.

3.4.4. Calibration of a subsonic venturi (SSV)

3.4.4.1. Calibration of the SSV is based upon the flow equation for a subsonic venturi. Gas flow is a function of inlet pressure and temperature, and the pressure drop between the SSV inlet and throat.

3.4.4.2. Data analysis

3.4.4.2.1. The airflow rate, Q_{SSV} , at each restriction setting (minimum 16 settings) shall be calculated in standard m^3/s from the flow meter data using the manufacturer's prescribed method. The discharge coefficient, C_d , shall be calculated from the calibration data for each setting using the following equation:

$$C_d = \frac{Q_{SSV}}{d_v^2 \times p_p \times \sqrt{\left\{ \frac{1}{\gamma} \times (r_{1,428}^{\gamma} - r_{1,715}^{\gamma}) \times \left(\frac{1}{1 - r_{1,428}^{\gamma}} \right) \right\}}}$$

where:

Q_{SSV} is the airflow rate at standard conditions (101,325 kPa, 273,15 K (0 °C)), m^3/s ;

T is the temperature at the venturi inlet, Kelvin (K);

d_v is the diameter of the SSV throat, m;

r_p is the ratio of the SSV throat pressure to inlet absolute static pressure,
 $1 - \frac{\Delta p}{p_p}$

r_D is the ratio of the SSV throat diameter, d_v , to the inlet pipe inner diameter D ;

C_d is the discharge coefficient of the SSV;

P_p is the absolute pressure at venturi inlet, kPa.

To determine the range of subsonic flow, C_d shall be plotted as a function of Reynolds number Re at the SSV throat. The Reynolds number at the SSV throat shall be calculated using the following equation:

$$Re = A_1 \times \frac{Q_{SSV}}{d_v \times \mu}$$

where:

$$\mu = \frac{b \times T^{1.5}}{S + T}$$

A_1 is 25.55152 in SI,

$$\left(\frac{1}{m^3} \right) \left(\frac{min}{s} \right) \left(\frac{mm}{m} \right)$$

;

Status: Point in time view as at 01/06/2017.

Changes to legislation: There are outstanding changes not yet made to Commission Regulation (EU) 2017/1151. Any changes that have already been made to the legislation appear in the content and are referenced with annotations. (See end of Document for details)

Q_{SSV}	is the airflow rate at standard conditions (101,325 kPa, 273,15 K (0 °C)), m^3/s ;
d_v	is the diameter of the SSV throat, m;
μ	is the absolute or dynamic viscosity of the gas, kg/ms;
b	is $1,458 \times 10^6$ (empirical constant), kg/ms $K^{0.5}$;
S	is 110,4 (empirical constant), Kelvin (K).

3.4.4.2.2. Because Q_{SSV} is an input to the Re equation, the calculations shall be started with an initial guess for Q_{SSV} or C_d of the calibration venturi, and repeated until Q_{SSV} converges. The convergence method shall be accurate to at least 0.1 per cent.

3.4.4.2.3. For a minimum of sixteen points in the region of subsonic flow, the calculated values of C_d from the resulting calibration curve fit equation shall be within $\pm 0,5$ per cent of the measured C_d for each calibration point.

3.4.5. Calibration of an ultrasonic flow meter (UFM)

3.4.5.1. The UFM shall be calibrated against a suitable reference flow meter.

3.4.5.2. The UFM shall be calibrated in the CVS configuration that will be used in the test cell (diluted exhaust piping, suction device) and checked for leaks. See Figure A5/8.

3.4.5.3. A heater shall be installed to condition the calibration flow in the event that the UFM system does not include a heat exchanger.

3.4.5.4. For each CVS flow setting that will be used, the calibration shall be performed at temperatures from room temperature to the maximum that will be experienced during vehicle testing.

3.4.5.5. The manufacturer's recommended procedure shall be followed for calibrating the electronic portions (temperature (T) and pressure (P) sensors) of the UFM.

3.4.5.6. Measurements for flow calibration of the ultrasonic flow meter are required and the following data (in the case that a laminar flow element is used) shall be found within the limits of precision given:

Barometric pressure (corrected), $P_b \pm 0,03$ kPa,

LFE air temperature, flow meter, $ETI \pm 0,15$ K,

Pressure depression upstream of LFE, $EPI \pm 0,01$ kPa,

Pressure drop across (EDP) LFE matrix $\pm 0,0015$ kPa,

Air flow, $Q_s \pm 0,5$ per cent,

UFM inlet depression, $P_{act} \pm 0,02$ kPa,

Temperature at UFM inlet, $T_{act} \pm 0,2$ K.

3.4.5.7. Procedure

3.4.5.7.1. The equipment shall be set up as shown in Figure A5/8 and checked for leaks. Any leaks between the flow-measuring device and the UFM will seriously affect the accuracy of the calibration.

Figure A5/8

Status: Point in time view as at 01/06/2017.

Changes to legislation: There are outstanding changes not yet made to Commission Regulation (EU) 2017/1151. Any changes that have already been made to the legislation appear in the content and are referenced with annotations. (See end of Document for details)

UFM calibration configuration

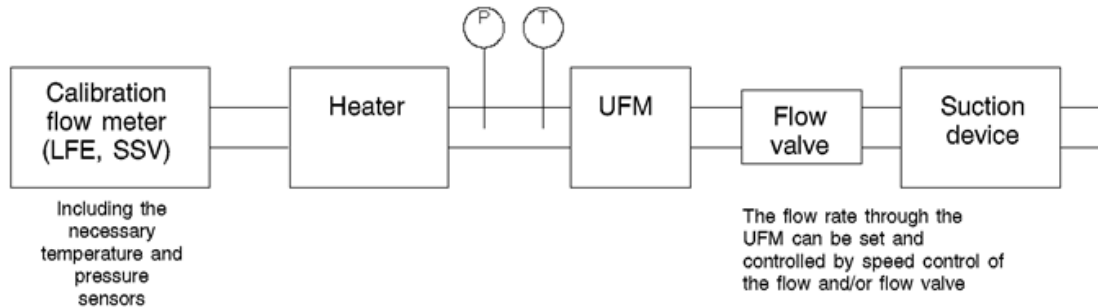

- 3.4.5.7.2. The suction device shall be started. Its speed and/or the position of the flow valve shall be adjusted to provide the set flow for the validation and the system stabilised. Data from all instruments shall be collected.
- 3.4.5.7.3. For UFM systems without a heat exchanger, the heater shall be operated to increase the temperature of the calibration air, allowed to stabilise and data from all the instruments recorded. The temperature shall be increased in reasonable steps until the maximum expected diluted exhaust temperature expected during the emissions test is reached.
- 3.4.5.7.4. The heater shall be subsequently turned off and the suction device speed and/or flow valve shall be adjusted to the next flow setting that will be used for vehicle emissions testing after which the calibration sequence shall be repeated.
- 3.4.5.8. The data recorded during the calibration shall be used in the following calculations. The air flow rate Q_s at each test point shall be calculated from the flow meter data using the manufacturer's prescribed method.

$$K_v = \frac{Q_{\text{reference}}}{Q_s}$$

where:

- Q_s is the air flow rate at standard conditions (101,325 kPa, 273,15 K (0 °C)), m³/s;
- $Q_{\text{reference}}$ is the air flow rate of the calibration flow meter at standard conditions (101,325 kPa, 273,15 K (0 °C)), m³/s;
- K_v is the calibration coefficient.

For UFM systems without a heat exchanger, K_v shall be plotted as a function of T_{act} .

The maximum variation in K_v shall not exceed 0,3 per cent of the arithmetic average K_v value of all the measurements taken at the different temperatures.

3.5. System verification procedure

3.5.1. General requirements

- 3.5.1.1. The total accuracy of the CVS sampling system and analytical system shall be determined by introducing a known mass of an emissions gas compound into the system whilst it is being operated under normal test conditions and subsequently analysing and calculating the emission gas compounds according to the equations of Sub-Annex 7. The CFO method described in paragraph 3.5.1.1.1. of this Sub-Annex

Status: Point in time view as at 01/06/2017.

Changes to legislation: There are outstanding changes not yet made to Commission Regulation (EU) 2017/1151. Any changes that have already been made to the legislation appear in the content and are referenced with annotations. (See end of Document for details)

and the gravimetric method described in paragraph 3.5.1.1.2. of this Sub-Annex are both known to give sufficient accuracy.

The maximum permissible deviation between the quantity of gas introduced and the quantity of gas measured is 2 per cent.

3.5.1.1.1. Critical flow orifice (CFO) method

The CFO method meters a constant flow of pure gas (CO, CO₂, or C₃H₈) using a critical flow orifice device.

3.5.1.1.1.1. A known mass of pure carbon monoxide, carbon dioxide or propane gas shall be introduced into the CVS system through the calibrated critical orifice. If the inlet pressure is high enough, the flow rate q which is restricted by means of the critical flow orifice, is independent of orifice outlet pressure (critical flow). The CVS system shall be operated as in a normal exhaust emissions test and enough time shall be allowed for subsequent analysis. The gas collected in the sample bag shall be analysed by the usual equipment (paragraph 4.1. of this Sub-Annex) and the results compared to the concentration of the known gas samples. If deviations exceed 2 per cent, the cause of the malfunction shall be determined and corrected.

3.5.1.1.2. Gravimetric method

The gravimetric method weighs a quantity of pure gas (CO, CO₂, or C₃H₈).

3.5.1.1.2. The weight of a small cylinder filled with either pure carbon monoxide, carbon dioxide or propane shall be determined with a precision of $\pm 0,01$ g. The CVS system shall operate under normal exhaust emissions test conditions while the pure gas is injected into the system for a time sufficient for subsequent analysis. The quantity of pure gas involved shall be determined by means of differential weighing. The gas accumulated in the bag shall be analysed by means of the equipment normally used for exhaust gas analysis as described in paragraph 4.1. of this Sub-Annex). The results shall be subsequently compared to the concentration figures computed previously. If deviations exceed 2 per cent, the cause of the malfunction shall be determined and corrected.

4. Emissions measurement equipment

4.1. Gaseous emissions measurement equipment

4.1.1. System overview

4.1.1.1. A continuously proportional sample of the diluted exhaust gases and the dilution air shall be collected for analysis.

4.1.1.2. The mass of gaseous emissions shall be determined from the proportional sample concentrations and the total volume measured during the test. Sample concentrations shall be corrected to take into account the respective compound concentrations in dilution air.

4.1.2. Sampling system requirements

4.1.2.1. The sample of diluted exhaust gases shall be taken upstream from the suction device.

4.1.2.1.1. With the exception of paragraph 4.1.3.1. (hydrocarbon sampling system), paragraph 4.2. (PM measurement equipment) and paragraph 4.3. (PN measurement equipment) of this Sub-Annex, the dilute exhaust gas sample may be taken downstream of the conditioning devices (if any).

Status: Point in time view as at 01/06/2017.

Changes to legislation: There are outstanding changes not yet made to Commission Regulation (EU) 2017/1151. Any changes that have already been made to the legislation appear in the content and are referenced with annotations. (See end of Document for details)

- 4.1.2.2. The bag sampling flow rate shall be set to provide sufficient volumes of dilution air and diluted exhaust in the CVS bags to allow concentration measurement and shall not exceed 0,3 per cent of the flow rate of the dilute exhaust gases, unless the diluted exhaust bag fill volume is added to the integrated CVS volume.
- 4.1.2.3. A sample of the dilution air shall be taken near the dilution air inlet (after the filter if one is fitted).
- 4.1.2.4. The dilution air sample shall not be contaminated by exhaust gases from the mixing area.
- 4.1.2.5. The sampling rate for the dilution air shall be comparable to that used for the dilute exhaust gases.
- 4.1.2.6. The materials used for the sampling operations shall be such as not to change the concentration of the emissions compounds.
- 4.1.2.7. Filters may be used in order to extract the solid particles from the sample.
- 4.1.2.8. Any valve used to direct the exhaust gases shall be of a quick-adjustment, quick-acting type.
- 4.1.2.9. Quick-fastening, gas-tight connections may be used between three-way valves and the sample bags, the connections sealing themselves automatically on the bag side. Other systems may be used for conveying the samples to the analyser (e.g. three-way stop valves).
- 4.1.2.10. Sample storage
- 4.1.2.10.1. The gas samples shall be collected in sample bags of sufficient capacity so as not to impede the sample flow.
- 4.1.2.10.2. The bag material shall be such as to affect neither the measurements themselves nor the chemical composition of the gas samples by more than ± 2 per cent after 30 minutes (e.g., laminated polyethylene/polyamide films, or fluorinated polyhydrocarbons).
- 4.1.3. Sampling systems
- 4.1.3.1. Hydrocarbon sampling system (heated flame ionisation detector, HFID)
- 4.1.3.1.1. The hydrocarbon sampling system shall consist of a heated sampling probe, line, filter and pump. The sample shall be taken upstream of the heat exchanger (if fitted). The sampling probe shall be installed at the same distance from the exhaust gas inlet as the particulate sampling probe and in such a way that neither interferes with samples taken by the other. It shall have a minimum internal diameter of 4 mm.
- 4.1.3.1.2. All heated parts shall be maintained at a temperature of $190\text{ °C} \pm 10\text{ °C}$ by the heating system.
- 4.1.3.1.3. The arithmetic average concentration of the measured hydrocarbons shall be determined by integration of the second-by-second data divided by the phase or test duration.
- 4.1.3.1.4. The heated sampling line shall be fitted with a heated filter F_H having a 99 per cent efficiency for particles $\geq 0,3\ \mu\text{m}$ to extract any solid particles from the continuous flow of gas required for analysis.

Status: Point in time view as at 01/06/2017.

Changes to legislation: There are outstanding changes not yet made to Commission Regulation (EU) 2017/1151. Any changes that have already been made to the legislation appear in the content and are referenced with annotations. (See end of Document for details)

- 4.1.3.1.5. The sampling system delay time (from the probe to the analyser inlet) shall be no more than 4 seconds.
- 4.1.3.1.6. The HFID shall be used with a constant mass flow (heat exchanger) system to ensure a representative sample, unless compensation for varying CVS volume flow is made.
- 4.1.3.2. NO or NO₂ sampling system (where applicable)
 - 4.1.3.2.1. A continuous sample flow of diluted exhaust gas shall be supplied to the analyser.
 - 4.1.3.2.2. The arithmetic average concentration of the NO or NO₂ shall be determined by integration of the second-by-second data divided by the phase or test duration.
 - 4.1.3.2.3. The continuous NO or NO₂ measurement shall be used with a constant flow (heat exchanger) system to ensure a representative sample, unless compensation for varying CVS volume flow is made.
- 4.1.4. Analysers
 - 4.1.4.1. General requirements for gas analysis
 - 4.1.4.1.1. The analysers shall have a measuring range compatible with the accuracy required to measure the concentrations of the exhaust gas sample compounds.
 - 4.1.4.1.2. If not defined otherwise, measurement errors shall not exceed ± 2 per cent (intrinsic error of analyser) disregarding the reference value for the calibration gases.
 - 4.1.4.1.3. The ambient air sample shall be measured on the same analyser with the same range.
 - 4.1.4.1.4. No gas drying device shall be used before the analysers unless it is shown to have no effect on the content of the compound in the gas stream.
 - 4.1.4.2. Carbon monoxide (CO) and carbon dioxide (CO₂) analysis
 - 4.1.4.2.1. The analysers shall be of the non-dispersive infrared (NDIR) absorption type.
 - 4.1.4.3. Hydrocarbons (HC) analysis for all fuels other than diesel fuel
 - 4.1.4.3.1. The analyser shall be of the flame ionization (FID) type calibrated with propane gas expressed in equivalent carbon atoms (C₁).
 - 4.1.4.4. Hydrocarbons (HC) analysis for diesel fuel and optionally for other fuels
 - 4.1.4.4.1. The analyser shall be of the heated flame ionization type with detector, valves, pipework, etc., heated to 190 °C \pm 10 °C. It shall be calibrated with propane gas expressed equivalent to carbon atoms (C₁).
 - 4.1.4.5. Methane (CH₄) analysis
 - 4.1.4.5.1. The analyser shall be either a gas chromatograph combined with a flame ionization detector (FID), or a flame ionization detector (FID) combined with a non-methane cutter (NMC-FID), calibrated with methane or propane gas expressed equivalent to carbon atoms (C₁).
 - 4.1.4.6. Nitrogen oxides (NO_x) analysis
 - 4.1.4.6.1. The analysers shall be of chemiluminescent (CLA) or non-dispersive ultra-violet resonance absorption (NDUV) types.

Status: Point in time view as at 01/06/2017.

Changes to legislation: There are outstanding changes not yet made to Commission Regulation (EU) 2017/1151. Any changes that have already been made to the legislation appear in the content and are referenced with annotations. (See end of Document for details)

4.1.5. Recommended system descriptions

4.1.5.1. Figure A5/9 is a schematic drawing of the gaseous emissions sampling system.
Figure A5/9

Full flow exhaust dilution system schematic

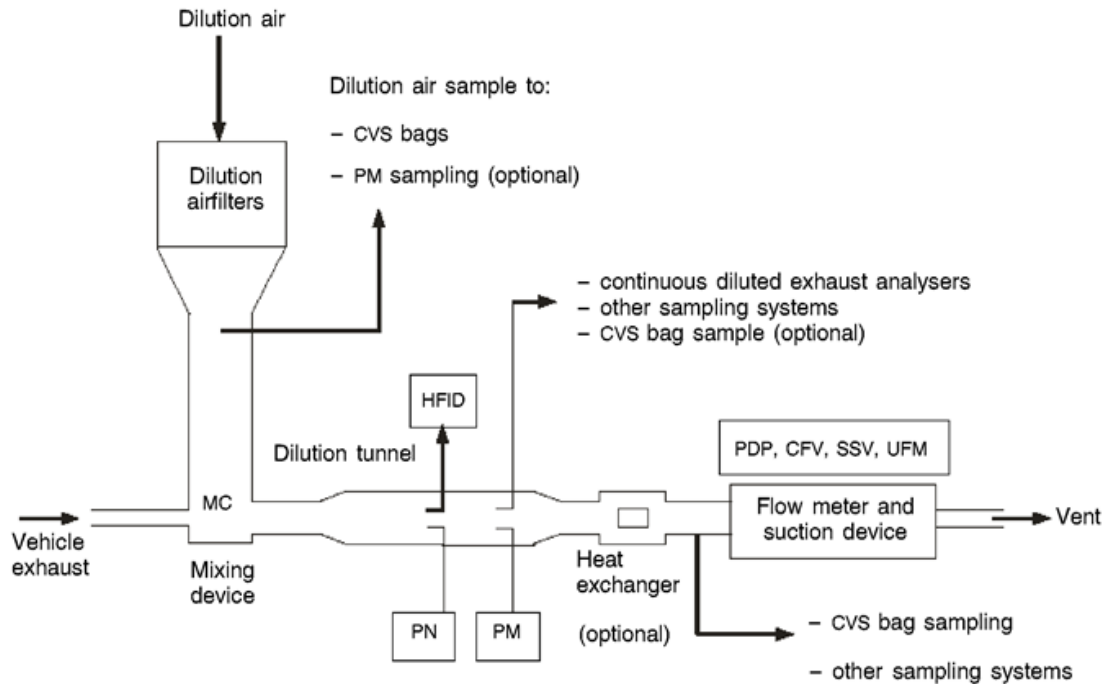

4.1.5.2. Examples of system components are as listed below.

4.1.5.2.1. Two sampling probes for continuous sampling of the dilution air and of the diluted exhaust gas/air mixture.

4.1.5.2.2. A filter to extract solid particles from the flows of gas collected for analysis.

4.1.5.2.3. Pumps and flow controller to ensure constant uniform flow of diluted exhaust gas and dilution air samples taken during the course of the test from sampling probes and flow of the gas samples shall be such that, at the end of each test, the quantity of the samples is sufficient for analysis.

4.1.5.2.4. Quick-acting valves to divert a constant flow of gas samples into the sample bags or to the outside vent.

4.1.5.2.5. Gas-tight, quick-lock coupling elements between the quick-acting valves and the sample bags. The coupling shall close automatically on the sampling bag side. As an alternative, other methods of transporting the samples to the analyser may be used (three-way stopcocks, for instance).

4.1.5.2.6. Bags for collecting samples of the diluted exhaust gas and of the dilution air during the test.

4.1.5.2.7. A sampling critical flow venturi to take proportional samples of the diluted exhaust gas (CFV-CVS only).

Status: Point in time view as at 01/06/2017.

Changes to legislation: There are outstanding changes not yet made to Commission Regulation (EU) 2017/1151. Any changes that have already been made to the legislation appear in the content and are referenced with annotations. (See end of Document for details)

4.1.5.3. Additional components required for hydrocarbon sampling using a heated flame ionization detector (HFID) as shown in Figure A5/10.

4.1.5.3.1. Heated sample probe in the dilution tunnel located in the same vertical plane as the particulate and particle sample probes.

4.1.5.3.2. Heated filter located after the sampling point and before the HFID.

4.1.5.3.3. Heated selection valves between the zero/calibration gas supplies and the HFID.

4.1.5.3.4. Means of integrating and recording instantaneous hydrocarbon concentrations.

4.1.5.3.5. Heated sampling lines and heated components from the heated probe to the HFID.

Figure A5/10

Components required for hydrocarbon sampling using an HFID

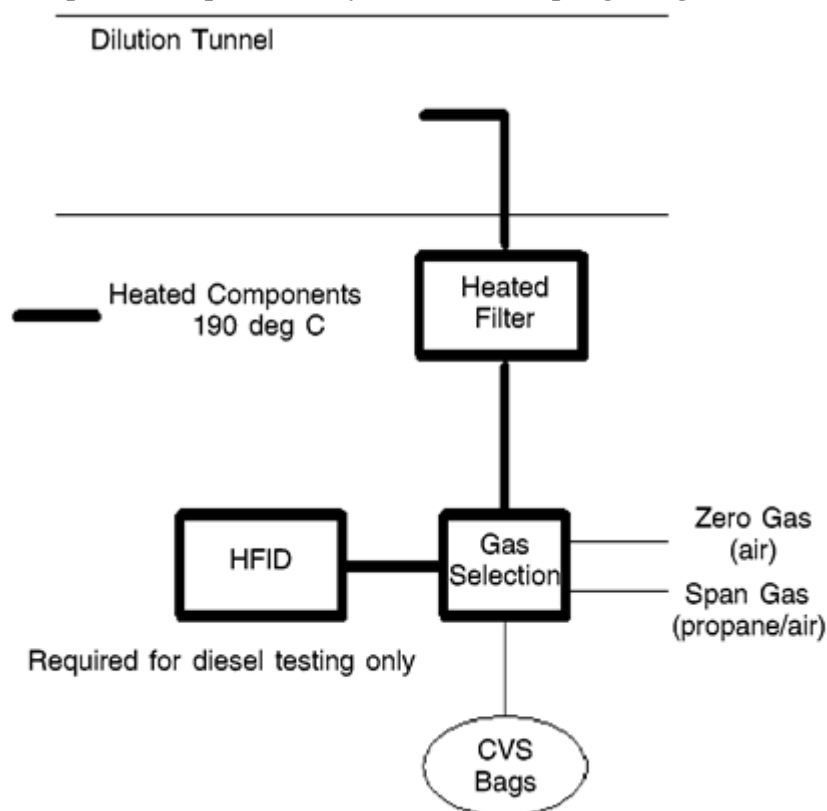

4.2. PM measurement equipment

4.2.1. Specification

4.2.1.1. System overview

4.2.1.1.1. The particulate sampling unit shall consist of a sampling probe (PSP), located in the dilution tunnel, a particle transfer tube (PTT), a filter holder(s) (FH), pump(s), flow rate regulators and measuring units. See Figures A5/11, A5/12 and A5/13.

4.2.1.1.2. A particle size pre-classifier (PCF), (e.g. cyclone or impactor) may be used. In such case, it is recommended that it be employed upstream of the filter holder.

Figure A5/11

Status: Point in time view as at 01/06/2017.

Changes to legislation: There are outstanding changes not yet made to Commission Regulation (EU) 2017/1151. Any changes that have already been made to the legislation appear in the content and are referenced with annotations. (See end of Document for details)

Alternative particulate sampling probe configuration

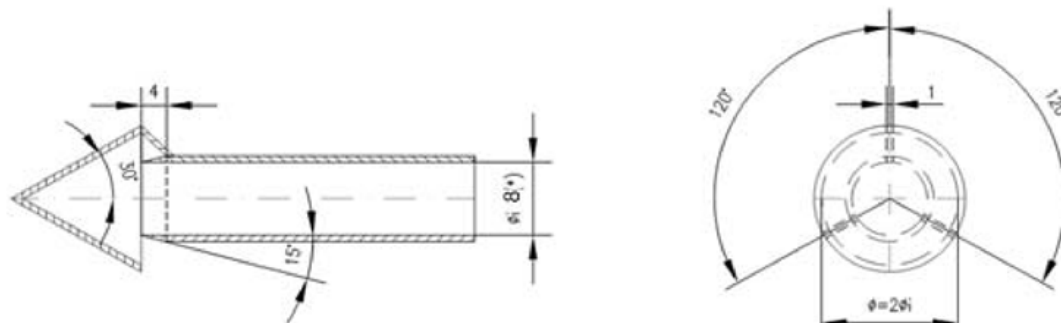

(*) Minimum internal diameter
Wall thickness ~ 1mm – Material: stainless steel

4.2.1.2. General requirements

4.2.1.2.1. The sampling probe for the test gas flow for particulate shall be arranged within the dilution tunnel so that a representative sample gas flow can be taken from the homogeneous air/exhaust mixture and shall be upstream of a heat exchanger (if any).

4.2.1.2.2. The particulate sample flow rate shall be proportional to the total mass flow of diluted exhaust gas in the dilution tunnel to within a tolerance of ± 5 per cent of the particulate sample flow rate. The verification of the proportionality of the particulate sampling shall be made during the commissioning of the system and as required by the approval authority.

4.2.1.2.3. The sampled dilute exhaust gas shall be maintained at a temperature above 20 °C and below 52 °C within 20 cm upstream or downstream of the particulate sampling filter face. Heating or insulation of components of the particulate sampling system to achieve this is permitted.

In the event that the 52 °C limit is exceeded during a test where periodic regeneration event does not occur, the CVS flow rate shall be increased or double dilution shall be applied (assuming that the CVS flow rate is already sufficient so as not to cause condensation within the CVS, sample bags or analytical system).

4.2.1.2.4. The particulate sample shall be collected on a single filter mounted within a holder in the sampled dilute exhaust gas flow.

4.2.1.2.5. All parts of the dilution system and the sampling system from the exhaust pipe up to the filter holder that are in contact with raw and diluted exhaust gas shall be designed to minimise deposition or alteration of the particulate. All parts shall be made of electrically conductive materials that do not react with exhaust gas components, and shall be electrically grounded to prevent electrostatic effects.

4.2.1.2.6. If it is not possible to compensate for variations in the flow rate, provision shall be made for a heat exchanger and a temperature control device as specified in paragraphs 3.3.5.1. or 3.3.6.4.2. of this Sub-Annex, so as to ensure that the flow rate in the system is constant and the sampling rate accordingly proportional.

4.2.1.2.7. Temperatures required for the measurement of PM shall be measured with an accuracy of ± 1 °C and a response time ($t_{10} - t_{90}$) of 15 seconds or less.

Status: Point in time view as at 01/06/2017.

Changes to legislation: There are outstanding changes not yet made to Commission Regulation (EU) 2017/1151. Any changes that have already been made to the legislation appear in the content and are referenced with annotations. (See end of Document for details)

4.2.1.2.8. The sample flow from the dilution tunnel shall be measured with an accuracy of ± 2.5 per cent of reading or ± 1.5 per cent full scale, whichever is the least.

The accuracy specified above of the sample flow from the CVS tunnel is also applicable where double dilution is used. Consequently, the measurement and control of the secondary dilution air flow and diluted exhaust flow rates through the filter shall be of a higher accuracy.

4.2.1.2.9. All data channels required for the measurement of PM shall be logged at a frequency of 1 Hz or faster. Typically these would include:

- (a) Diluted exhaust temperature at the particulate sampling filter;
- (b) Sampling flow rate;
- (c) Secondary dilution air flow rate (if secondary dilution is used);
- (d) Secondary dilution air temperature (if secondary dilution is used).

4.2.1.2.10. For double dilution systems, the accuracy of the diluted exhaust transferred from the dilution tunnel V_{ep} defined in paragraph 3.3.2. of Sub-Annex 7 in the equation is not measured directly but determined by differential flow measurement.

The accuracy of the flow meters used for the measurement and control of the double diluted exhaust passing through the particulate sampling filters and for the measurement/control of secondary dilution air shall be sufficient so that the differential volume V_{ep} shall meet the accuracy and proportional sampling requirements specified for single dilution.

The requirement that no condensation of the exhaust gas occur in the CVS dilution tunnel, diluted exhaust flow rate measurement system, CVS bag collection or analysis systems shall also apply in the case that double dilution systems are used.

4.2.1.2.11. Each flow meter used in a particulate sampling and double dilution system shall be subjected to a linearity verification as required by the instrument manufacturer.

Figure A5/12

Status: Point in time view as at 01/06/2017.

Changes to legislation: There are outstanding changes not yet made to Commission Regulation (EU) 2017/1151. Any changes that have already been made to the legislation appear in the content and are referenced with annotations. (See end of Document for details)

Particulate sampling system

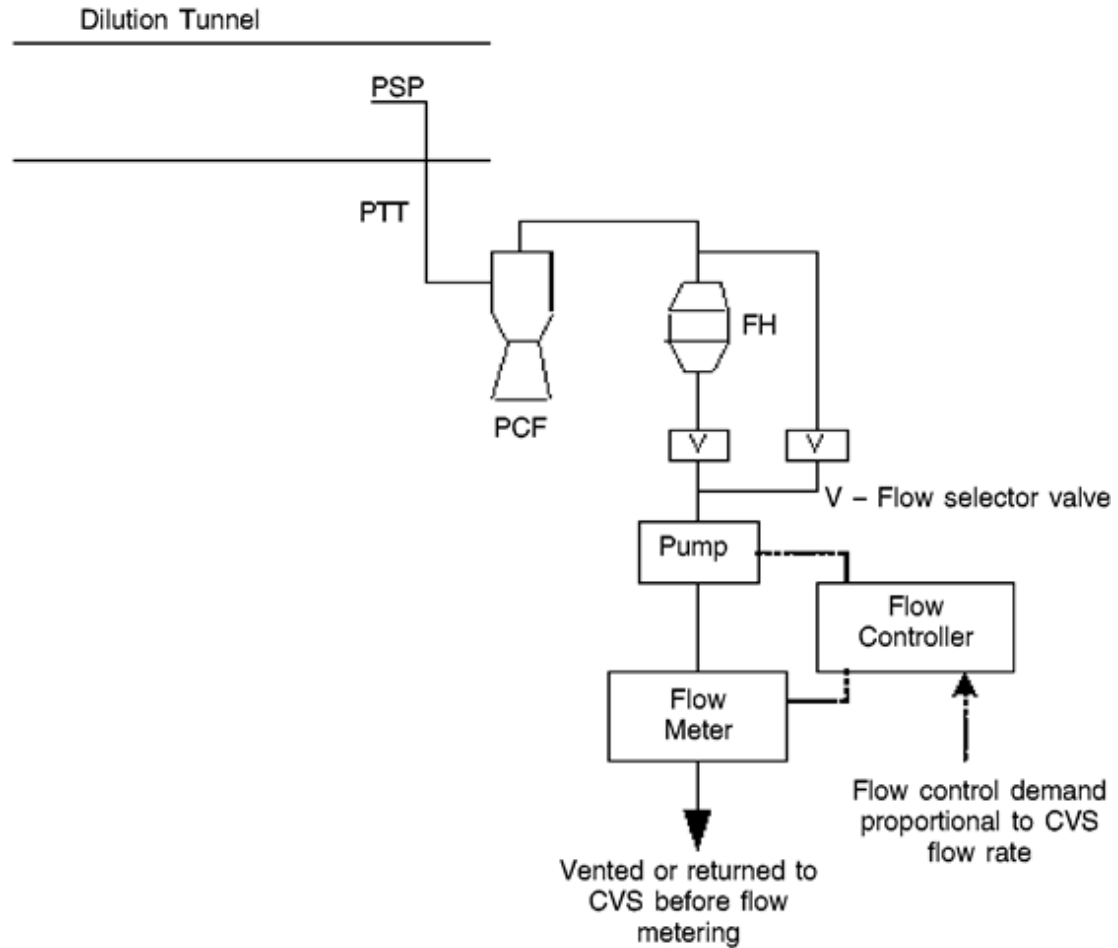
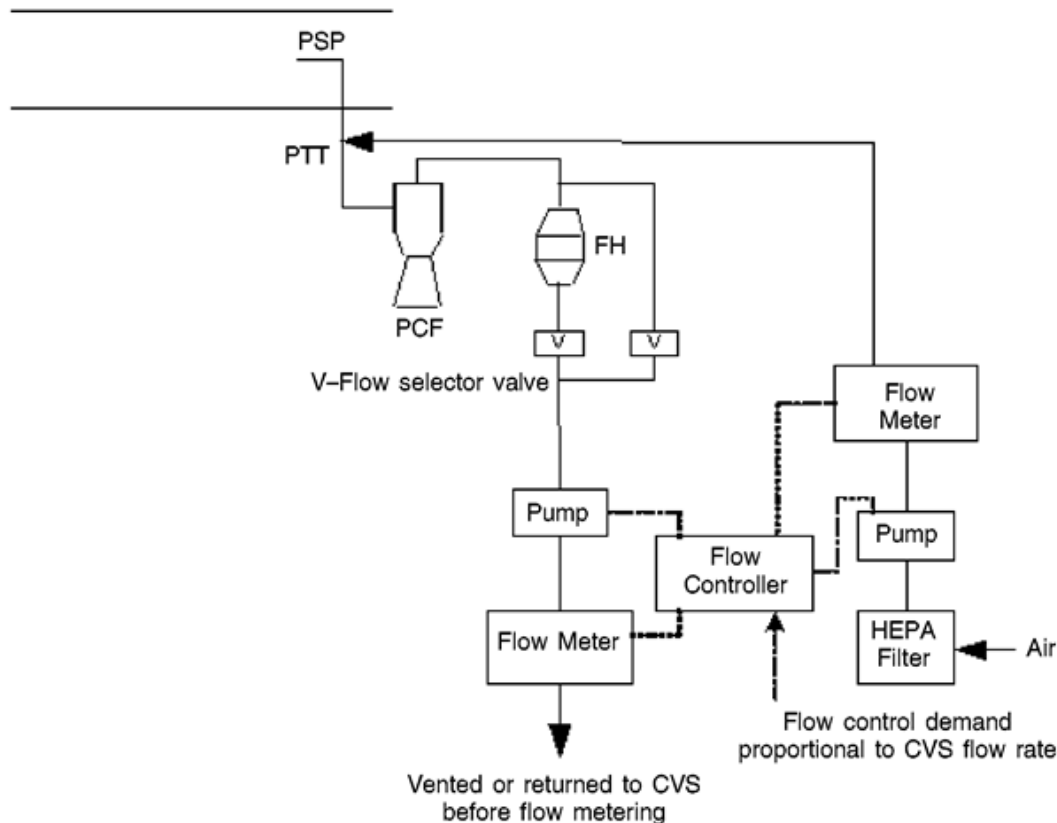

Figure A5/13

Status: Point in time view as at 01/06/2017.

Changes to legislation: There are outstanding changes not yet made to Commission Regulation (EU) 2017/1151. Any changes that have already been made to the legislation appear in the content and are referenced with annotations. (See end of Document for details)

Double dilution particulate sampling system



4.2.1.3. Specific requirements

4.2.1.3.1. Sample probe

4.2.1.3.1.1. The sample probe shall deliver the particle size classification performance specified in paragraph 4.2.1.3.1.4. of this Sub-Annex. It is recommended that this performance be achieved by the use of a sharp-edged, open-ended probe facing directly into the direction of flow plus a pre-classifier (cyclone impactor, etc.). An appropriate sample probe, such as that indicated in Figure A5/11, may alternatively be used provided it achieves the pre-classification performance specified in paragraph 4.2.1.3.1.4. of this Sub-Annex.

4.2.1.3.1.2. The sample probe shall be installed at least 10 tunnel diameters downstream of the exhaust gas inlet to the tunnel and have an internal diameter of at least 8 mm.

If more than one simultaneous sample is drawn from a single sample probe, the flow drawn from that probe shall be split into identical sub-flows to avoid sampling artefacts.

If multiple probes are used, each probe shall be sharp-edged, open-ended and facing directly into the direction of flow. Probes shall be equally spaced around the central longitudinal axis of the dilution tunnel, with a spacing between probes of at least 5 cm.

4.2.1.3.1.3. The distance from the sampling tip to the filter mount shall be at least five probe diameters, but shall not exceed 2 000 mm.

4.2.1.3.1.4. The pre-classifier (e.g. cyclone, impactor, etc.) shall be located upstream of the filter holder assembly. The pre-classifier 50 per cent cut point particle diameter shall be

Status: Point in time view as at 01/06/2017.

Changes to legislation: There are outstanding changes not yet made to Commission Regulation (EU) 2017/1151. Any changes that have already been made to the legislation appear in the content and are referenced with annotations. (See end of Document for details)

between 2,5 µm and 10 µm at the volumetric flow rate selected for sampling PM. The pre-classifier shall allow at least 99 per cent of the mass concentration of 1 µm particles entering the pre-classifier to pass through the exit of the pre-classifier at the volumetric flow rate selected for sampling PM.

4.2.1.3.2. Particle transfer tube (PTT)

4.2.1.3.2. Any bends in the PTT shall be smooth and have the largest possible radii.

4.2.1.3.3. Secondary dilution

4.2.1.3.3. As an option, the sample extracted from the CVS for the purpose of PM measurement may be diluted at a second stage, subject to the following requirements:

4.2.1.3.3. Secondary dilution air shall be filtered through a medium capable of reducing particles in the most penetrating particle size of the filter material by $\geq 99,95$ per cent, or through a HEPA filter of at least class H13 of EN 1822:2009. The dilution air may optionally be charcoal-scrubbed before being passed to the HEPA filter. It is recommended that an additional coarse particle filter be situated before the HEPA filter and after the charcoal scrubber, if used.

4.2.1.3.3. The secondary dilution air should be injected into the PTT as close to the outlet of the diluted exhaust from the dilution tunnel as possible.

4.2.1.3.3. The residence time from the point of secondary diluted air injection to the filter face shall be at least 0.25 seconds, but no longer than 5 seconds.

4.2.1.3.3. If the double diluted sample is returned to the CVS, the location of the sample return shall be selected so that it does not interfere with the extraction of other samples from the CVS.

4.2.1.3.4. Sample pump and flow meter

4.2.1.3.4. The sample gas flow measurement unit shall consist of pumps, gas flow regulators and flow measuring units.

4.2.1.3.4. The temperature of the gas flow in the flow meter may not fluctuate by more than ± 3 °C except:

- (a) When the sampling flow meter has real time monitoring and flow control operating at a frequency of 1 Hz or faster;
- (b) During regeneration tests on vehicles equipped with periodically regenerating after-treatment devices.

Should the volume of flow change unacceptably as a result of excessive filter loading, the test shall be invalidated. When it is repeated, the flow rate shall be decreased.

4.2.1.3.5. Filter and filter holder

4.2.1.3.5. A valve shall be located downstream of the filter in the direction of flow. The valve shall open and close within 1 second of the start and end of test.

4.2.1.3.5. For a given test, the gas filter face velocity shall be set to an initial value within the range 20 cm/s to 105 cm/s and shall be set at the start of the test so that 105 cm/s will not be exceeded when the dilution system is being operated with sampling flow proportional to CVS flow rate.

4.2.1.3.5. Fluorocarbon coated glass fibre filters or fluorocarbon membrane filters shall be used.

Status: Point in time view as at 01/06/2017.

Changes to legislation: There are outstanding changes not yet made to Commission Regulation (EU) 2017/1151. Any changes that have already been made to the legislation appear in the content and are referenced with annotations. (See end of Document for details)

All filter types shall have a 0,3 µm DOP (di-octylphthalate) or PAO (poly-alpha-olefin) CS 68649-12-7 or CS 68037-01-4 collection efficiency of at least 99 per cent at a gas filter face velocity of 5,33 cm/s measured according to one of the following standards:

- (a) U.S.A. Department of Defense Test Method Standard, MIL-STD-282 method 102.8: DOP-Smoke Penetration of Aerosol-Filter Element;
- (b) U.S.A. Department of Defense Test Method Standard, MIL-STD-282 method 502.1.1: DOP-Smoke Penetration of Gas-Mask Canisters;
- (c) Institute of Environmental Sciences and Technology, IEST-RP-CC021: Testing HEPA and ULPA Filter Media.

4.2.1.3.5.4 The filter holder assembly shall be of a design that provides an even flow distribution across the filter stain area. The filter shall be round and have a stain area of at least 1 075 mm².

4.2.2. Weighing chamber (or room) and analytical balance specifications

4.2.2.1. Weighing chamber (or room) conditions

- (a) The temperature of the weighing chamber (or room) in which the particulate sampling filters are conditioned and weighed shall be maintained to within 22 °C ± 2 °C (22 °C ± 1 °C if possible) during all filter conditioning and weighing.
- (b) Humidity shall be maintained at a dew point of less than 10.5 °C and a relative humidity of 45 per cent ± 8 per cent.
- (c) Limited deviations from weighing chamber (or room) temperature and humidity specifications shall be permitted provided their total duration does not exceed 30 minutes in any one filter conditioning period.
- (d) The levels of ambient contaminants in the weighing chamber (or room) environment that would settle on the particulate sampling filters during their stabilisation shall be minimised.
- (e) During the weighing operation no deviations from the specified conditions are permitted.

4.2.2.2. Linear response of an analytical balance

The analytical balance used to determine the filter weight shall meet the linearity verification criteria of Table A5/1 applying a linear regression. This implies a precision of at least 2 µg and a resolution of at least 1 µg (1 digit = 1 µg). At least 4 equally-spaced reference weights shall be tested. The zero value shall be within ± 1 µg.

Table A5/1

Analytical balance verification criteria

Measurement system	Intercept a0	Slope a1	Standard error SEE	Coefficient of determination r ²
Particulate Balance	≤ 1 µg	0,99 – 1,01	≤ 1per cent max	≥ 0,998

Status: Point in time view as at 01/06/2017.

Changes to legislation: There are outstanding changes not yet made to Commission Regulation (EU) 2017/1151. Any changes that have already been made to the legislation appear in the content and are referenced with annotations. (See end of Document for details)

4.2.2.3. Elimination of static electricity effects

The effects of static electricity shall be nullified. This may be achieved by grounding the balance through placement upon an antistatic mat and neutralization of the particulate sampling filters prior to weighing using a polonium neutraliser or a device of similar effect. Alternatively, nullification of static effects may be achieved through equalization of the static charge.

4.2.2.4. Buoyancy correction

The sample and reference filter weights shall be corrected for their buoyancy in air. The buoyancy correction is a function of sampling filter density, air density and the density of the balance calibration weight, and does not account for the buoyancy of the particulate matter itself.

If the density of the filter material is not known, the following densities shall be used:

- (a) PTFE coated glass fibre filter: 2 300 kg/m³;
- (b) PTFE membrane filter: 2 144 kg/m³;
- (c) PTFE membrane filter with polymethylpentene support ring: 920 kg/m³.

For stainless steel calibration weights, a density of 8 000 kg/m³ shall be used. If the material of the calibration weight is different, its density shall be known and be used. International Recommendation OIML R 111-1 Edition 2004(E) (or equivalent) from International Organization of Legal Metrology on calibration weights should be followed.

The following equation shall be used:

$$m_f = m_{\text{uncorr}} \times \left(\frac{1 - \frac{\rho_a}{\rho_f}}{1 - \frac{\rho_a}{\rho_w}} \right)$$

where:

- m_f is the corrected particulate sample mass, mg;
- m_{uncorr} is the uncorrected particulate sample mass, mg;
- ρ_a is the density of the air, kg/m³;
- ρ_w is the density of balance calibration weight, kg/m³;
- ρ_f is the density of the particulate sampling filter, kg/m³.

The density of the air ρ_a shall be calculated using the following equation:

$$\rho_a = \frac{p_b \times M_{\text{mix}}}{R \times T_a}$$

- p_b is the total atmospheric pressure, kPa;
- T_a is the air temperature in the balance environment, Kelvin (K);
- M_{mix} is the molar mass of air in a balanced environment, 28,836 g mol⁻¹;
- R is the molar gas constant, 8,3144 J mol⁻¹ K⁻¹.

4.3. PN measurement equipment

4.3.1. Specification

4.3.1.1. System overview

4.3.1.1.1. The particle sampling system shall consist of a probe or sampling point extracting a sample from a homogeneously mixed flow in a dilution system, a volatile particle

Status: Point in time view as at 01/06/2017.

Changes to legislation: There are outstanding changes not yet made to Commission Regulation (EU) 2017/1151. Any changes that have already been made to the legislation appear in the content and are referenced with annotations. (See end of Document for details)

remover (VPR) upstream of a particle number counter (PNC) and suitable transfer tubing. See Figure A5/14.

4.3.1.1.2. It is recommended that a particle size pre-classifier (PCF) (e.g. cyclone, impactor, etc.) be located prior to the inlet of the VPR. The PCF 50 per cent cut point particle diameter shall be between 2.5 μm and 10 μm at the volumetric flow rate selected for particle sampling. The PCF shall allow at least 99 per cent of the mass concentration of 1 μm particles entering the PCF to pass through the exit of the PCF at the volumetric flow rate selected for particle sampling.

A sample probe acting as an appropriate size-classification device, such as that shown in Figure A5/11, is an acceptable alternative to the use of a PCF.

4.3.1.2. General requirements

4.3.1.2.1. The particle sampling point shall be located within a dilution system. In the case that a double dilution system is used, the particle sampling point shall be located within the primary dilution system.

4.3.1.2.1. The sampling probe tip or PSP, and the PTT, together comprise the particle transfer system (PTS). The PTS conducts the sample from the dilution tunnel to the entrance of the VPR. The PTS shall meet the following conditions:

- (a) The sampling probe shall be installed at least 10 tunnel diameters downstream of the exhaust gas inlet, facing upstream into the tunnel gas flow with its axis at the tip parallel to that of the dilution tunnel;
- (b) The sampling probe shall be upstream of any conditioning device (e.g. heat exchanger);
- (c) The sampling probe shall be positioned within the dilution tunnel so that the sample is taken from a homogeneous diluent/exhaust mixture.

4.3.1.2.1. Sample gas drawn through the PTS shall meet the following conditions:

- (a) In the case that a full flow exhaust dilution system, is used it shall have a flow Reynolds number, Re , lower than 1 700;
- (b) In the case that a double dilution system is used, it shall have a flow Reynolds number Re lower than 1 700 in the PTT i.e. downstream of the sampling probe or point;
- (c) Shall have a residence time ≤ 3 seconds.

4.3.1.2.1. Any other sampling configuration for the PTS for which equivalent particle penetration at 30 nm can be demonstrated shall be considered acceptable.

4.3.1.2.1. The outlet tube (OT), conducting the diluted sample from the VPR to the inlet of the PNC, shall have the following properties:

- (a) An internal diameter ≥ 4 mm;
- (b) A sample gas flow residence time of $\leq 0,8$ seconds.

4.3.1.2.1. Any other sampling configuration for the OT for which equivalent particle penetration at 30 nm can be demonstrated shall be considered acceptable.

4.3.1.2.2. The VPR shall include devices for sample dilution and for volatile particle removal.

Status: Point in time view as at 01/06/2017.

Changes to legislation: There are outstanding changes not yet made to Commission Regulation (EU) 2017/1151. Any changes that have already been made to the legislation appear in the content and are referenced with annotations. (See end of Document for details)

4.3.1.2.3. All parts of the dilution system and the sampling system from the exhaust pipe up to the PNC, which are in contact with raw and diluted exhaust gas, shall be designed to minimize deposition of the particles. All parts shall be made of electrically conductive materials that do not react with exhaust gas components, and shall be electrically grounded to prevent electrostatic effects.

4.3.1.2.4. The particle sampling system shall incorporate good aerosol sampling practice that includes the avoidance of sharp bends and abrupt changes in cross-section, the use of smooth internal surfaces and the minimization of the length of the sampling line. Gradual changes in the cross-section are permitted.

4.3.1.3. Specific requirements

4.3.1.3.1. The particle sample shall not pass through a pump before passing through the PNC.

4.3.1.3.2. A sample pre-classifier is recommended.

4.3.1.3.3. The sample preconditioning unit shall:

- (a) Be capable of diluting the sample in one or more stages to achieve a particle number concentration below the upper threshold of the single particle count mode of the PNC and a gas temperature below 35 °C at the inlet to the PNC;
- (b) Include an initial heated dilution stage that outputs a sample at a temperature of ≥ 150 °C and ≤ 350 °C ± 10 °C, and dilutes by a factor of at least 10;
- (c) Control heated stages to constant nominal operating temperatures, within the range ≥ 150 °C and ≤ 400 °C ± 10 °C;
- (d) Provide an indication of whether or not heated stages are at their correct operating temperatures;
- (e) Be designed to achieve a solid particle penetration efficiency of at least 70 per cent for particles of 100 nm electrical mobility diameter;
- (f) Achieve a particle concentration reduction factor $f_r(d_i)$ for particles of 30 nm and 50 nm electrical mobility diameters that is no more than 30 per cent and 20 per cent respectively higher, and no more than 5 per cent lower than that for particles of 100 nm electrical mobility diameter for the VPR as a whole;

The particle concentration reduction factor at each particle size $f_r(d_i)$ shall be calculated using the following equation:

$$f_r(d_i) = \frac{N_{in}(d_i)}{N_{out}(d_i)}$$

where:

- | | |
|----------------|---|
| $N_{in}(d_i)$ | is the upstream particle number concentration for particles of diameter d_i ; |
| $N_{out}(d_i)$ | is the downstream particle number concentration for particles of diameter d_i ; |
| d_i | is the particle electrical mobility diameter (30, 50 or 100 nm). |

$N_{in}(d_i)$ and $N_{out}(d_i)$ shall be corrected to the same conditions.

The arithmetic average particle concentration reduction factor at a given dilution setting

Status: Point in time view as at 01/06/2017.

Changes to legislation: There are outstanding changes not yet made to Commission Regulation (EU) 2017/1151. Any changes that have already been made to the legislation appear in the content and are referenced with annotations. (See end of Document for details)

\bar{f}_r
 shall be calculated using the following equation:

$$\bar{f}_r = \frac{f_r(30 \text{ nm}) + f_r(50 \text{ nm}) + f_r(100 \text{ nm})}{3}$$

It is recommended that the VPR is calibrated and validated as a complete unit;

- (g) Be designed according to good engineering practice to ensure particle concentration reduction factors are stable across a test;
- (h) Also achieve > 99,0 per cent vaporization of 30 nm tetracontane (CH₃(CH₂)₃₈CH₃) particles, with an inlet concentration of ≥ 10 000 per cm³, by means of heating and reduction of partial pressures of the tetracontane.

4.3.1.3.4. The PNC shall:

- (a) Operate under full flow operating conditions;
- (b) Have a counting accuracy of ± 10 per cent across the range 1 per cm³ to the upper threshold of the single particle count mode of the PNC against a suitable traceable standard. At concentrations below 100 per cm³, measurements averaged over extended sampling periods may be required to demonstrate the accuracy of the PNC with a high degree of statistical confidence;
- (c) Have a resolution of at least 0.1 particles per cm³ at concentrations below 100 per cm³;
- (d) Have a linear response to particle number concentrations over the full measurement range in single particle count mode;
- (e) Have a data reporting frequency equal to or greater than a frequency of 0,5 Hz;
- (f) Have a t₉₀ response time over the measured concentration range of less than 5 seconds;
- (g) Incorporate a coincidence correction function up to a maximum 10 per cent correction, and may make use of an internal calibration factor as determined in paragraph 5.7.1.3. of this Sub-Annex but shall not make use of any other algorithm to correct for or define the counting efficiency;
- (h) Have counting efficiencies at the different particle sizes as specified in Table A5/2.

Table A5/2

PNC counting efficiency	
Particle size electrical mobility diameter (nm)	PNC counting efficiency (per cent)
23 ± 1	50 ± 12
41 ± 1	> 90

4.3.1.3.5. If the PNC makes use of a working liquid, it shall be replaced at the frequency specified by the instrument manufacturer.

4.3.1.3.6. Where not held at a known constant level at the point at which PNC flow rate is controlled, the pressure and/or temperature at the PNC inlet shall be measured for

Status: Point in time view as at 01/06/2017.

Changes to legislation: There are outstanding changes not yet made to Commission Regulation (EU) 2017/1151. Any changes that have already been made to the legislation appear in the content and are referenced with annotations. (See end of Document for details)

the purposes of correcting particle number concentration measurements to standard conditions.

4.3.1.3.7. The sum of the residence time of the PTS, VPR and OT plus the t_{90} response time of the PNC shall be no greater than 20 seconds.

4.3.1.4. Recommended system description

The following paragraph contains the recommended practice for measurement of PN. However, systems meeting the performance specifications in paragraphs 4.3.1.2. and 4.3.1.3. of this Sub-Annex are acceptable.

Figure A5/14

A recommended particle sampling system

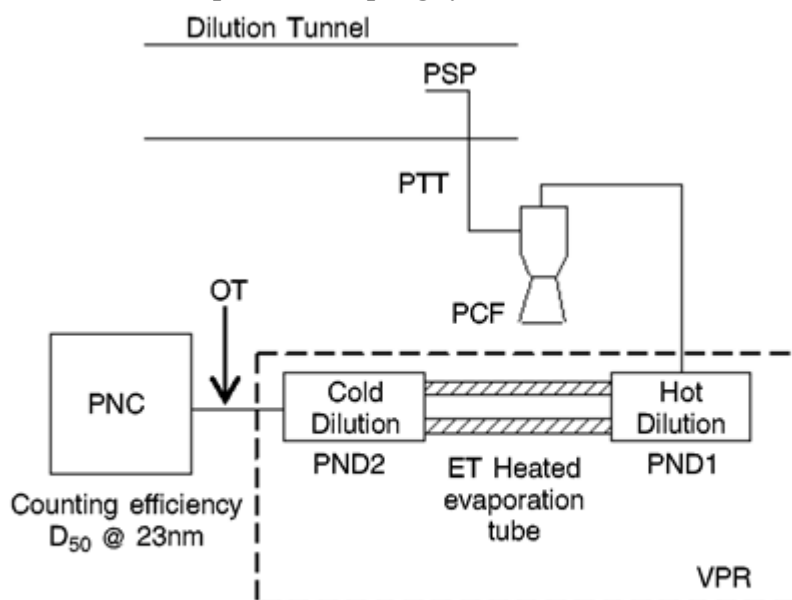

4.3.1.4.1. Sampling system description

4.3.1.4.1.1. The particle sampling system shall consist of a sampling probe tip or particle sampling point in the dilution system, a PTT, a PCF, and a VPR, upstream of the PNC unit.

4.3.1.4.1.2. The VPR shall include devices for sample dilution (particle number diluters: PND₁ and PND₂) and particle evaporation (evaporation tube, ET).

4.3.1.4.1.3. The sampling probe or sampling point for the test gas flow shall be arranged within the dilution tunnel so that a representative sample gas flow is taken from a homogeneous diluent/exhaust mixture.

5. Calibration intervals and procedures

5.1. Calibration intervals

Status: Point in time view as at 01/06/2017.

Changes to legislation: There are outstanding changes not yet made to Commission Regulation (EU) 2017/1151. Any changes that have already been made to the legislation appear in the content and are referenced with annotations. (See end of Document for details)

TABLE A5/3

Instrument calibration intervals

Instrument checks	Interval	Criterion
Gas analyser linearization (calibration)	Every 6 months	± 2 per cent of reading
Mid span	Every 6 months	± 2 per cent
CO NDIR:CO ₂ /H ₂ O interference	Monthly	– 1 to 3 ppm
NO _x converter check	Monthly	> 95 per cent
CH ₄ cutter check	Yearly	98 per cent of ethane
FID CH ₄ response	Yearly	See paragraph 5.4.3. of this Sub-Annex
FID air/fuel flow	At major maintenance	According to instrument manufacturer.
Laser infrared spectrometers (modulated high resolution narrow band infrared analysers): interference check	Yearly or at major maintenance	According to instrument manufacturer.
QCL	Yearly or at major maintenance	According to instrument manufacturer.
GC methods	See paragraph 7.2. of this Sub-Annex	See paragraph 7.2. of this Sub-Annex
LC methods	Yearly or at major maintenance	According to instrument manufacturer.
Photoacoustics	Yearly or at major maintenance	According to instrument manufacturer.
Microgram balance linearity	Yearly or at major maintenance	See paragraph 4.2.2.2. of this Sub-Annex
PNC (particle number counter)	See paragraph 5.7.1.1. of this Sub-Annex	See paragraph 5.7.1.3. of this Sub-Annex
VPR (volatile particle remover)	See paragraph 5.7.2.1. of this Sub-Annex	See paragraph 5.7.2. of this Sub-Annex

TABLE A5/4

Constant volume sampler (CVS) calibration intervals

CVS	Interval	Criterion
CVS flow	After overhaul	± 2 per cent
Dilution flow	Yearly	± 2 per cent
Temperature sensor	Yearly	± 1 °C
Pressure sensor	Yearly	± 0,4 kPa

Status: Point in time view as at 01/06/2017.

Changes to legislation: There are outstanding changes not yet made to Commission Regulation (EU) 2017/1151. Any changes that have already been made to the legislation appear in the content and are referenced with annotations. (See end of Document for details)

Injection check	Weekly	± 2 per cent
-----------------	--------	--------------

TABLE A5/5

Environmental data calibration intervals

Climate	Interval	Criterion
Temperature	Yearly	± 1 °C
Moisture dew	Yearly	± 5 per cent RH
Ambient pressure	Yearly	± 0,4 kPa
Cooling fan	After overhaul	According to paragraph 1.1.1. of this Sub-Annex

5.2. Analyser calibration procedures

5.2.1. Each analyser shall be calibrated as specified by the instrument manufacturer or at least as often as specified in Table A5/3.

5.2.2. Each normally used operating range shall be linearized by the following procedure:

5.2.2.1. The analyser linearization curve shall be established by at least five calibration points spaced as uniformly as possible. The nominal concentration of the calibration gas of the highest concentration shall be not less than 80 per cent of the full scale.

5.2.2.2. The calibration gas concentration required may be obtained by means of a gas divider, diluting with purified N₂ or with purified synthetic air.

5.2.2.3. The linearization curve shall be calculated by the least squares method. If the resulting polynomial degree is greater than 3, the number of calibration points shall be at least equal to this polynomial degree plus 2.

5.2.2.4. The linearization curve shall not differ by more than ± 2 per cent from the nominal value of each calibration gas.

5.2.2.5. From the trace of the linearization curve and the linearization points it is possible to verify that the calibration has been carried out correctly. The different characteristic parameters of the analyser shall be indicated, particularly:

- (a) Analyser and gas component;
- (b) Range;
- (c) Date of linearisation.

5.2.2.6. If the approval authority is satisfied that alternative technologies (e.g. computer, electronically controlled range switch, etc.) give equivalent accuracy, these alternatives may be used.

5.3. Analyser zero and calibration verification procedure

5.3.1. Each normally used operating range shall be checked prior to each analysis in accordance with paragraphs 5.3.1.1. and 5.3.1.2. of this Sub-Annex

5.3.1.1. The calibration shall be checked by use of a zero gas and by use of a calibration gas according to paragraph 1.2.14.2.3. of Sub-Annex 6,

Status: Point in time view as at 01/06/2017.

Changes to legislation: There are outstanding changes not yet made to Commission Regulation (EU) 2017/1151. Any changes that have already been made to the legislation appear in the content and are referenced with annotations. (See end of Document for details)

5.3.1.2. After testing, zero gas and the same calibration gas shall be used for re-checking according to paragraph 1.2.14.2.4. of Sub-Annex 6.

5.4. FID hydrocarbon response check procedure

5.4.1. Detector response optimization

The FID shall be adjusted as specified by the instrument manufacturer. Propane in air shall be used on the most common operating range.

5.4.2. Calibration of the HC analyser

5.4.2.1. The analyser shall be calibrated using propane in air and purified synthetic air.

5.4.2.2. A calibration curve as described in paragraph 5.2.2. of this Sub-Annex shall be established.

5.4.3. Response factors of different hydrocarbons and recommended limits

5.4.3.1. The response factor R_f for a particular hydrocarbon compound is the ratio of the FID C_1 reading to the gas cylinder concentration, expressed as ppm C_1 .

The concentration of the test gas shall be at a level to give a response of approximately 80 per cent of full-scale deflection for the operating range. The concentration shall be known to an accuracy of ± 2 per cent in reference to a gravimetric standard expressed in volume. In addition, the gas cylinder shall be preconditioned for 24 hours at a temperature between 20 and 30 °C.

5.4.3.2. Response factors shall be determined when introducing an analyser into service and at major service intervals thereafter. The test gases to be used and the recommended response factors are:

Propylene and purified air:

$0,90 < R_f < 1,10$

Toluene and purified air:

$0,90 < R_f < 1,10$

These are relative to an R_f of 1,00 for propane and purified air.

5.5. NO_x converter efficiency test procedure

5.5.1. Using the test set up as shown in Figure A5/15 and the procedure described below, the efficiency of converters for the conversion of NO₂ into NO shall be tested by means of an ozonator as follows:

5.5.1.1. The analyser shall be calibrated in the most common operating range following the manufacturer's specifications using zero and calibration gas (the NO content of which shall amount to approximately 80 per cent of the operating range and the NO₂ concentration of the gas mixture shall be less than 5 per cent of the NO concentration). The NO_x analyser shall be in the NO mode so that the calibration gas does not pass through the converter. The indicated concentration shall be included in all relevant test sheets.

5.5.1.2. Via a T-fitting, oxygen or synthetic air shall be added continuously to the calibration gas flow until the concentration indicated is approximately 10 per cent less than the indicated calibration concentration given in paragraph 5.5.1.1. of this Sub-Annex. The

Status: Point in time view as at 01/06/2017.

Changes to legislation: There are outstanding changes not yet made to Commission Regulation (EU) 2017/1151. Any changes that have already been made to the legislation appear in the content and are referenced with annotations. (See end of Document for details)

indicated concentration (c) shall be included in all relevant test sheets. The ozonator shall be kept deactivated throughout this process.

- 5.5.1.3. The ozonator shall now be activated to generate enough ozone to bring the NO concentration down to 20 per cent (minimum 10 per cent) of the calibration concentration given in paragraph 5.5.1.1. of this Sub-Annex. The indicated concentration (d) shall be included all relevant test sheets.
- 5.5.1.4. The NO_x analyser shall be subsequently switched to the NO_x mode, whereby the gas mixture (consisting of NO, NO₂, O₂ and N₂) now passes through the converter. The indicated concentration (a) shall be included in all relevant test sheets.
- 5.5.1.5. The ozonator shall now be deactivated. The mixture of gases described in paragraph 5.5.1.2. of this Sub-Annex shall pass through the converter into the detector. The indicated concentration (b) shall be included in all relevant test sheets.

Figure A5/15

NO_x converter efficiency test configuration

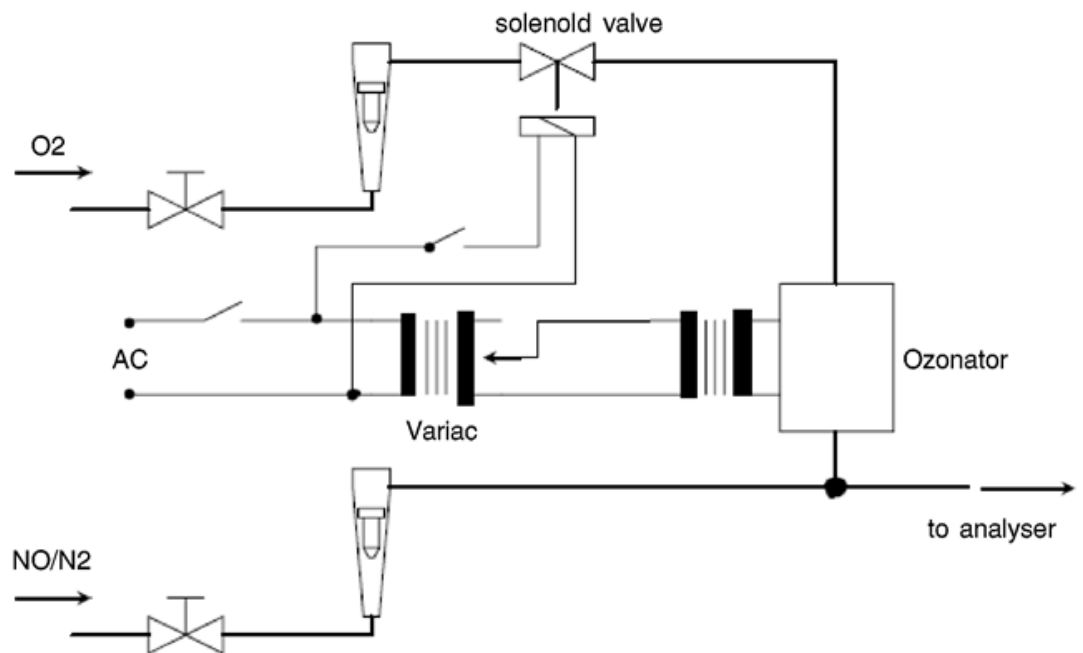

- 5.5.1.6. With the ozonator deactivated, the flow of oxygen or synthetic air shall be shut off. The NO₂ reading of the analyser shall then be no more than 5 per cent above the figure given in paragraph 5.5.1.1. of this Sub-Annex.
- 5.5.1.7. The per cent efficiency of the NO_x converter shall be calculated using the concentrations a, b, c and d determined in paragraphs 5.5.1.2. to 5.5.1.5. of this Sub-Annex inclusive using the following equation:

$$\text{Efficiency} = \left(1 + \frac{a-b}{c-d}\right) \times 100$$

- 5.5.1.7.1. The efficiency of the converter shall not be less than 95 per cent. The efficiency of the converter shall be tested in the frequency defined in Table A5/3.

- 5.6. Calibration of the microgram balance

Status: Point in time view as at 01/06/2017.

Changes to legislation: There are outstanding changes not yet made to Commission Regulation (EU) 2017/1151. Any changes that have already been made to the legislation appear in the content and are referenced with annotations. (See end of Document for details)

5.6.1. The calibration of the microgram balance used for particulate sampling filter weighing shall be traceable to a national or international standard. The balance shall comply with the linearity requirements given in paragraph 4.2.2.2. of this Sub-Annex. The linearity verification shall be performed at least every 12 months or whenever a system repair or change is made that could influence the calibration.

5.7. Calibration and validation of the particle sampling system

Examples of calibration/validation methods are available at:

<http://www.unece.org/trans/main/wp29/wp29wgs/wp29grpe/pmpFCP.html>

5.7.1. Calibration of the PNC

5.7.1.1. The approval authority shall ensure the existence of a calibration certificate for the PNC demonstrating compliance with a traceable standard within a 13-month period prior to the emissions test. Between calibrations either the counting efficiency of the PNC shall be monitored for deterioration or the PNC wick shall be routinely changed every 6 months. See Figures A5/16 and A5/17. PNC counting efficiency may be monitored against a reference PNC or against at least two other measurement PNCs. If the PNC reports particle number concentrations within ± 10 per cent of the arithmetic average of the concentrations from the reference PNC, or a group of two or more PNCs, the PNC shall subsequently be considered stable, otherwise maintenance of the PNC is required. Where the PNC is monitored against two or more other measurement PNCs, it is permitted to use a reference vehicle running sequentially in different test cells each with its own PNC.

Figure A5/16

Nominal PNC annual sequence

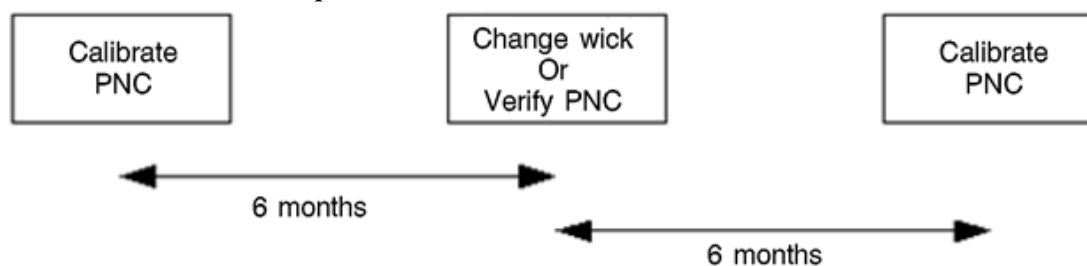
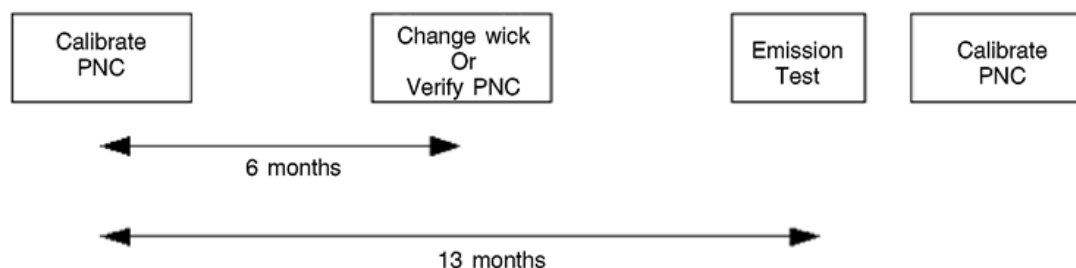

Figure A5/17

Extended PNC annual sequence (in the case that a full PNC calibration is delayed)



5.7.1.2. The PNC shall also be recalibrated and a new calibration certificate issued following any major maintenance.

Status: Point in time view as at 01/06/2017.

Changes to legislation: There are outstanding changes not yet made to Commission Regulation (EU) 2017/1151. Any changes that have already been made to the legislation appear in the content and are referenced with annotations. (See end of Document for details)

- 5.7.1.3. Calibration shall be traceable to a national or international standard calibration method by comparing the response of the PNC under calibration with that of:
- (a) A calibrated aerosol electrometer when simultaneously sampling electrostatically classified calibration particles; or
 - (b) A second PNC that has been directly calibrated by the method described above.
- 5.7.1.3.1. In paragraph 5.7.1.3. (a) of this Sub-Annex, calibration shall be undertaken using at least six standard concentrations spaced as uniformly as possible across the PNC's measurement range.
- 5.7.1.3.2. In paragraph 5.7.1.3. (b) of this Sub-Annex, calibration shall be undertaken using at least six standard concentrations across the PNC's measurement range. At least 3 points shall be at concentrations below 1,000 per cm³, the remaining concentrations shall be linearly spaced between 1,000 per cm³ and the maximum of the PNC's range in single particle count mode.
- 5.7.1.3.3. In paragraphs 5.7.1.3.(a) and 5.7.1.3.(b) of this Sub-Annex, the selected points shall include a nominal zero concentration point produced by attaching HEPA filters of at least class H13 of EN 1822:2008, or equivalent performance, to the inlet of each instrument. With no calibration factor applied to the PNC under calibration, measured concentrations shall be within ± 10 per cent of the standard concentration for each concentration, with the exception of the zero point, otherwise the PNC under calibration shall be rejected. The gradient from a linear least squares regression of the two data sets shall be calculated and recorded. A calibration factor equal to the reciprocal of the gradient shall be applied to the PNC under calibration. Linearity of response is calculated as the square of the Pearson product moment correlation coefficient (r) of the two data sets and shall be equal to or greater than 0.97. In calculating both the gradient and r^2 , the linear regression shall be forced through the origin (zero concentration on both instruments).
- 5.7.1.4. Calibration shall also include a check, according to the requirements of paragraph 4.3.1.3.4.(h) of this Sub-Annex, on the PNC's detection efficiency with particles of 23 nm electrical mobility diameter. A check of the counting efficiency with 41 nm particles is not required.
- 5.7.2. Calibration/validation of the VPR
- 5.7.2.1. Calibration of the VPR's particle concentration reduction factors across its full range of dilution settings, at the instrument's fixed nominal operating temperatures, shall be required when the unit is new and following any major maintenance. The periodic validation requirement for the VPR's particle concentration reduction factor is limited to a check at a single setting, typical of that used for measurement on particulate filter-equipped vehicles. The approval authority shall ensure the existence of a calibration or validation certificate for the VPR within a 6-month period prior to the emissions test. If the VPR incorporates temperature monitoring alarms, a 13 month validation interval is permitted.

It is recommended that the VPR is calibrated and validated as a complete unit.

The VPR shall be characterised for particle concentration reduction factor with solid particles of 30, 50 and 100 nm electrical mobility diameter. Particle concentration reduction factors $f_r(d)$ for particles of 30 nm and 50 nm electrical mobility diameters shall be no more than 30 per cent and 20 per cent higher respectively, and no more than 5 per cent lower than that for particles of

Status: Point in time view as at 01/06/2017.

Changes to legislation: There are outstanding changes not yet made to Commission Regulation (EU) 2017/1151. Any changes that have already been made to the legislation appear in the content and are referenced with annotations. (See end of Document for details)

100 nm electrical mobility diameter. For the purposes of validation, the arithmetic average of the particle concentration reduction factor shall be within ± 10 per cent of the arithmetic average particle concentration reduction factor

\bar{f}_r

determined during the primary calibration of the VPR.

5.7.2.2. The test aerosol for these measurements shall be solid particles of 30, 50 and 100 nm electrical mobility diameter and a minimum concentration of 5 000 particles per cm^3 at the VPR inlet. As an option, a polydisperse aerosol with an electrical mobility median diameter of 50 nm may be used for validation. The test aerosol shall be thermally stable at the VPR operating temperatures. Particle number concentrations shall be measured upstream and downstream of the components.

The particle concentration reduction factor for each monodisperse particle size, $f_r(d_i)$, shall be calculated using the following equation:

$$f_r(d_i) = \frac{N_{in}(d_i)}{N_{out}(d_i)}$$

where:

$N_{in}(d_i)$ is the upstream particle number concentration for particles of diameter d_i ;

$N_{out}(d_i)$ is the downstream particle number concentration for particles of diameter d_i ;

d_i is the particle electrical mobility diameter (30, 50 or 100 nm).

$N_{in}(d_i)$ and $N_{out}(d_i)$ shall be corrected to the same conditions.

The arithmetic average particle concentration reduction factor

\bar{f}_r

at a given dilution setting shall be calculated using the following equation:

$$\bar{f}_r = \frac{f_r(30\text{nm}) + f_r(50\text{nm}) + f_r(100\text{nm})}{3}$$

Where a polydisperse 50 nm aerosol is used for validation, the arithmetic average particle concentration reduction factor

\bar{f}_e

at the dilution setting used for validation shall be calculated using the following equation:

$$\bar{f}_e = \frac{N_{in}}{N_{out}}$$

where:

N_{in} is the upstream particle number concentration;

N_{out} is the downstream particle number concentration.

5.7.2.3. The VPR shall demonstrate greater than 99.0 per cent removal of tetracontane ($\text{CH}_3(\text{CH}_2)_{38}\text{CH}_3$) particles of at least 30 nm electrical mobility diameter with an inlet concentration $\geq 10\,000$ per cm^3 when operated at its minimum dilution setting and manufacturers recommended operating temperature.

5.7.3. PN measurement system check procedures

5.7.3.1. On a monthly basis, the flow into the PNC shall have a measured value within 5 per cent of the PNC nominal flow rate when checked with a calibrated flow meter.

5.8. Accuracy of the mixing device

Status: Point in time view as at 01/06/2017.

Changes to legislation: There are outstanding changes not yet made to Commission Regulation (EU) 2017/1151. Any changes that have already been made to the legislation appear in the content and are referenced with annotations. (See end of Document for details)

In the case that a gas divider is used to perform the calibrations as defined in paragraph 5.2. of this Sub-Annex, the accuracy of the mixing device shall be such that the concentrations of the diluted calibration gases may be determined to within ± 2 per cent. A calibration curve shall be verified by a mid-span check as described in paragraph 5.3. of this Sub-Annex. A calibration gas with a concentration below 50 per cent of the analyser range shall be within 2 per cent of its certified concentration.

6. Reference gases

6.1. Pure gases

6.1.1. All values in ppm mean V-ppm (vpm)

6.1.2. The following pure gases shall be available, if necessary, for calibration and operation:

6.1.2.1. Nitrogen:

Purity: ≤ 1 ppm C1, ≤ 1 ppm CO, ≤ 400 ppm CO₂, $\leq 0,1$ ppm NO, $< 0,1$ ppm NO₂, $< 0,1$ ppm N₂O, $< 0,1$ ppm NH₃;

6.1.2.2. Synthetic air:

Purity: ≤ 1 ppm C1, ≤ 1 ppm CO, ≤ 400 ppm CO₂, $\leq 0,1$ ppm NO; oxygen content between 18 and 21 per cent volume;

6.1.2.3. Oxygen:

Purity: $> 99,5$ per cent vol. O₂;

6.1.2.4. Hydrogen (and mixture containing helium or nitrogen):

Purity: ≤ 1 ppm C1, ≤ 400 ppm CO₂; hydrogen content between 39 and 41 per cent volume;

6.1.2.5. Carbon monoxide:

Minimum purity 99,5 per cent;

6.1.2.6. Propane:

Minimum purity 99,5 per cent.

6.2. Calibration gases

6.2.1. The true concentration of a calibration gas shall be within ± 1 per cent of the stated value or as given below.

Mixtures of gases having the following compositions shall be available with bulk gas specifications according to paragraphs 6.1.2.1. or 6.1.2.2. of this Sub-Annex:

- (a) C₃H₈ in synthetic air (see paragraph 6.1.2.2. of this Sub-Annex);
- (b) CO in nitrogen;
- (c) CO₂ in nitrogen;
- (d) CH₄ in synthetic air;
- (e) NO in nitrogen (the amount of NO₂ contained in this calibration gas shall not exceed 5 per cent of the NO content);

Status: Point in time view as at 01/06/2017.

Changes to legislation: There are outstanding changes not yet made to Commission Regulation (EU) 2017/1151. Any changes that have already been made to the legislation appear in the content and are referenced with annotations. (See end of Document for details)

Sub-Annex 6

Type 1 test procedures and test conditions

1. Test procedures and test conditions
 - 1.1 Description of tests
 - 1.1.1. The Type 1 test is used to verify the emissions of gaseous compounds, particulate matter, particle number, CO₂ mass emission, fuel consumption, electric energy consumption and electric ranges over the applicable WLTP test cycle.
 - 1.1.1.1. The tests shall be carried out according to the method described in paragraph 1.2. of this Sub-Annex or paragraph 3. of Sub-Annex 8 for pure electric, hybrid electric and compressed hydrogen fuel cell hybrid vehicles. Exhaust gases, particulate matter and particles shall be sampled and analysed by the prescribed methods.
 - 1.1.2. The number of tests shall be determined according to the flowchart in Figure A6/1. The limit value is the maximum allowed value for the respective criteria pollutant as specified in Annex I of Regulation (EC) No 715/2007.
 - 1.1.2.1. The flowchart in Figure A6/1 shall be applicable only to the whole applicable WLTP test cycle and not to single phases.
 - 1.1.2.2. The test results shall be the values after the REESS energy change-based, Ki and ATCT corrections are applied.
 - 1.1.2.3. Determination of total cycle values
 - 1.1.2.3.1. If during any of the tests a criteria emissions limit is exceeded, the vehicle shall be rejected.
 - 1.1.2.3.2. Depending on the vehicle type, the manufacturer shall declare as applicable the total cycle value of the CO₂ mass emission, the electric energy consumption, fuel consumption for NOVC-FCHV as well as PER and AER according to Table A6/1.
 - 1.1.2.3.3. The declared value of the electric energy consumption for OVC-HEVs under charge-depleting operating condition shall not be determined according to Figure A6/1. It shall be taken as the type approval value if the declared CO₂ value is accepted as the approval value. If that is not the case, the measured value of electric energy consumption shall be taken as the type approval value.
 - 1.1.2.3.4. If after the first test all criteria in row 1 of the applicable Table A6/2 are fulfilled, all values declared by the manufacturer shall be accepted as the type approval value. If any one of the criteria in row 1 of the applicable Table A6/2 is not fulfilled, a second test shall be performed with the same vehicle.
 - 1.1.2.3.5. After the second test, the arithmetic average results of the two tests shall be calculated. If all criteria in row 2 of the applicable Table A6/2 are fulfilled by these arithmetic average results, all values declared by the manufacturer shall be accepted as the type approval value. If any one of the criteria in row 2 of the applicable Table A6/2 is not fulfilled, a third test shall be performed with the same vehicle.
 - 1.1.2.3.6. After the third test, the arithmetic average results of the three tests shall be calculated. For all parameters which fulfil the corresponding criterion in row 3 of the applicable Table A6/2, the declared value shall be taken as the type approval value. For any

Status: Point in time view as at 01/06/2017.

Changes to legislation: There are outstanding changes not yet made to Commission Regulation (EU) 2017/1151. Any changes that have already been made to the legislation appear in the content and are referenced with annotations. (See end of Document for details)

parameter which does not fulfil the corresponding criterion in row 3 of the applicable Table A6/2, the arithmetic average result shall be taken as the type approval value.

1.1.2.3.7. In the case that any one of the criterion of the applicable Table A6/2 is not fulfilled after the first or second test, at the request of the manufacturer and with the approval of the approval authority, the values may be re-declared as higher values for emissions or consumption, or as lower values for electric ranges, in order to reduce the required number of tests for type approval.

1.1.2.3.8. dCO₂₁, dCO₂₂ and dCO₂₃ determination.

1.1.2.3.8. Without prejudice to the requirement of paragraph 1.1.2.3.8.2., the following values for dCO₂₁, dCO₂₂ and dCO₂₃ shall be used in relation to the criteria for the number of tests in Table A6/2:

$$dCO_{21} = 0,990$$

$$dCO_{22} = 0,995$$

$$dCO_{23} = 1,000$$

1.1.2.3.8. If the charge depleting Type 1 test for OVC-HEVs consists of two or more applicable WLTP test cycles and the dCO_{2x} value is below 1,0, the dCO_{2x} value shall be replaced by 1,0.

1.1.2.3.9. In the case that a test result or an average of test results was taken and confirmed as the type approval value, this result shall be referred to as 'declared value' for further calculations.

Table A6/1

Applicable rules for a manufacturer's declared values (total cycle values)^a

Vehicle type	M _{CO2} ^b (g/km)	FC(kg/100 km)	Electric energy consumption ^c (kWh/km)	All electric range / Pure Electric Range ^c (km)
Vehicles tested according to Sub-Annex 6 (ICE)	M _{CO2} Paragraph 3. of Sub-Annex 7	—	—	—
NOVC-FCHV	—	FC _{CS} Paragraph 4.2.1.2.1. of Annex 8	—	—
NOVC-HEV	M _{CO2,CS} Paragraph	—	—	—

a The declared value shall be the value that the necessary corrections are applied (i.e. Ki correction and the other regional corrections)

b Rounding xxx.xx

c Rounding xxx.x

Status: Point in time view as at 01/06/2017.

Changes to legislation: There are outstanding changes not yet made to Commission Regulation (EU) 2017/1151. Any changes that have already been made to the legislation appear in the content and are referenced with annotations. (See end of Document for details)

Table A6/1

Applicable rules for a manufacturer's declared values (total cycle values)^a

		4.1.1. of Sub-Annex 8			
OVC-HEV	CD	M _{CO2,CD} Paragraph 4.1.2. of Sub-Annex 8	—	EC _{AC,CD} Paragraph 4.3.1. of Sub-Annex 8	AER Paragraph 4.4.1.1. of Sub-Annex 8
	CS	M _{CO2,CS} Paragraph 4.1.1. of Sub-Annex 8	—	—	—
PEV		—	—	EC _{WLTC} Paragraph 4.3.4.2. of Sub-Annex 8	PER _{WLTC} Paragraph 4.4.2. of Sub-Annex 8

a The declared value shall be the value that the necessary corrections are applied (i.e. Ki correction and the other regional corrections)

b Rounding xxx.xx

c Rounding xxx.x

Figure A6/1

Status: Point in time view as at 01/06/2017.

Changes to legislation: There are outstanding changes not yet made to Commission Regulation (EU) 2017/1151. Any changes that have already been made to the legislation appear in the content and are referenced with annotations. (See end of Document for details)

Flowchart for the number of Type 1 tests

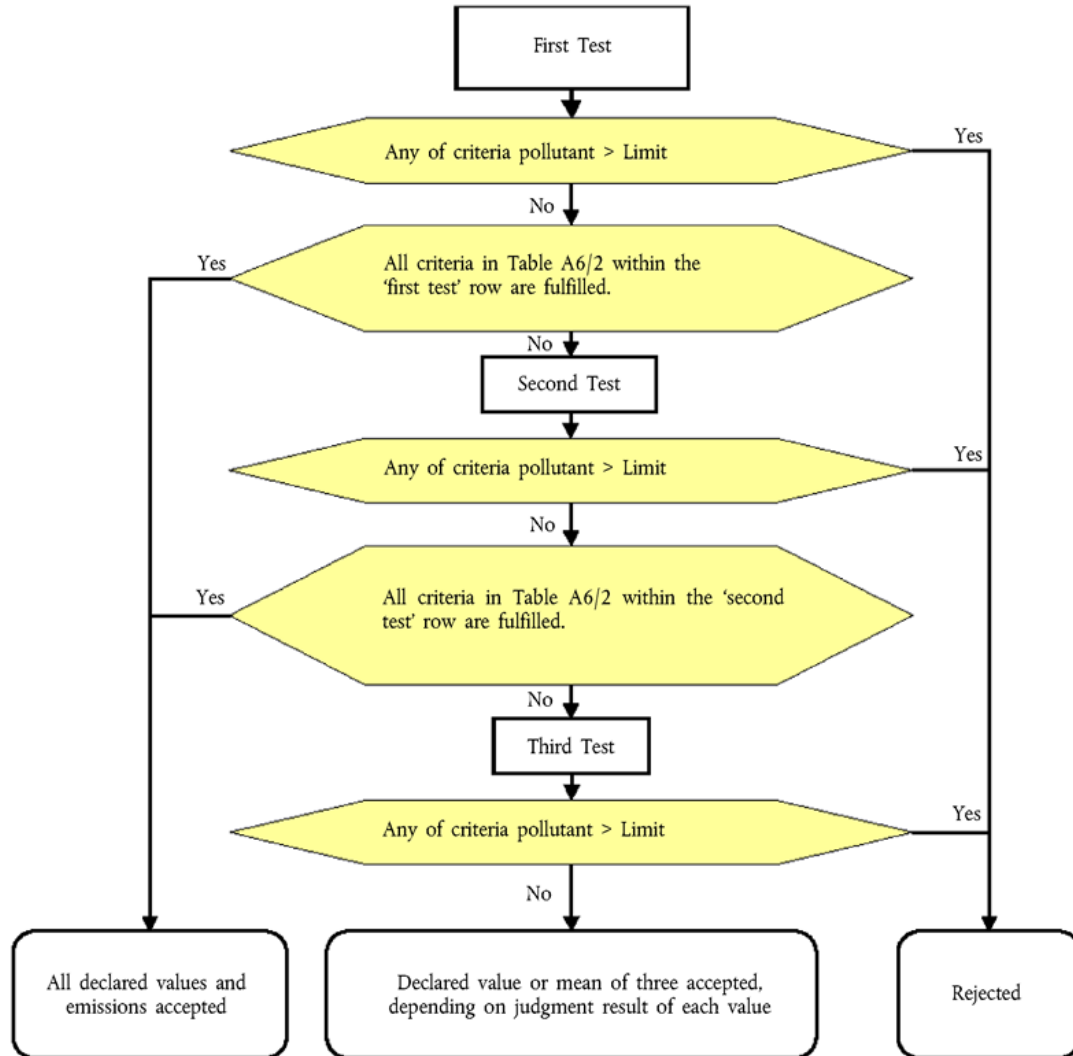

TABLE A6/2

Criteria for number of tests

For ICE vehicles, NOVC-HEVs and OVC-HEVs charge-sustaining Type 1 test.

	Test	Judgement parameter	Criteria emission	M _{CO2}
Row 1	First test	First test results	≤ Regulation limit × 0,9	≤ Declared value × dCO ₂₁
Row 2	Second test	Arithmetic average of the first and second test results	≤ Regulation limit × 1,0 ^a	≤ Declared value × dCO ₂₂

^a Each test result also shall be fulfilled the regulation limit.

Status: Point in time view as at 01/06/2017.

Changes to legislation: There are outstanding changes not yet made to Commission Regulation (EU) 2017/1151. Any changes that have already been made to the legislation appear in the content and are referenced with annotations. (See end of Document for details)

For ICE vehicles, NOVC-HEVs and OVC-HEVs charge-sustaining Type 1 test.

Row 3	Third test	Arithmetic average of three test results	\leq Regulation limit $\times 1,0^a$	\leq Declared value $\times dCO2_3$
-------	------------	--	--	---------------------------------------

a Each test result also shall be fulfilled the regulation limit.

For OVC-HEVs charge-depleting Type 1 test.

	Test	Judgement parameter	Criteria emissions	$M_{CO2,CD}$	AER
Row 1	First test	First test results	\leq Regulation limit $\times 0,9^a$	\leq Declared value $\times dCO2_1$	\geq Declared value $\times 1,0$
Row 2	Second test	Arithmetic average of the first and second test results	\leq Regulation limit $\times 1,0^b$	\leq Declared value $\times dCO2_2$	\geq Declared value $\times 1,0$
Row 3	Third test	Arithmetic average of three test results	\leq Regulation limit $\times 1,0^b$	\leq Declared value $\times dCO2_3$	\geq Declared value $\times 1,0$

a '0,9' shall be replaced by '1,0' for charge depleting Type 1 test for OVC-HEVs, only if the charge depleting test contains two or more applicable WLTC cycles.

b Each test result shall fulfil the regulation limit.

For PEVs

	Test	Judgement parameter	Electric energy consumption	PER
Row 1	First test	First test results	\leq Declared value $\times 1,0$	\geq Declared value $\times 1,0$
Row 2	Second test	Arithmetic average of the first and second test results	\leq Declared value $\times 1,0$	\geq Declared value $\times 1,0$
Row 3	Third test	Arithmetic average of three test results	\leq Declared value $\times 1,0$	\geq Declared value $\times 1,0$

For NOVC-FCHVs

	Test	Judgement parameter	FC_{CS}
Row 1	First test	First test results	\leq Declared value $\times 1,0$

Status: Point in time view as at 01/06/2017.

Changes to legislation: There are outstanding changes not yet made to Commission Regulation (EU) 2017/1151. Any changes that have already been made to the legislation appear in the content and are referenced with annotations. (See end of Document for details)

Row 2	Second test	Arithmetic average of the first and second test results	\leq Declared value \times 1,0
Row 3	Third test	Arithmetic average of three test results	\leq Declared value \times 1,0

1.1.2.4. Determination of phase-specific values

1.1.2.4.1. Phase-specific value for CO₂

1.1.2.4.1. After the total cycle declared value of the CO₂ mass emission is accepted, the arithmetic average of the phase-specific values of the test results in g/km shall be multiplied by the adjustment factor CO₂_AF to compensate for the difference between the declared value and the test results. This corrected value shall be the type approval value for CO₂.

$$\text{CO}_2\text{-AF} = \frac{\text{Declared value}}{\text{Phase combined value}}$$

where:

$$\text{Phase combined value} = \frac{\text{CO}_2^{\text{aveL}} \times D_L + \text{CO}_2^{\text{aveM}} \times D_M + \text{CO}_2^{\text{aveH}} \times D_H + \text{CO}_2^{\text{aveexH}} \times D_{\text{exH}}}{D_L + D_M + D_H + D_{\text{exH}}}$$

where:

CO ₂ ^{aveL}	is the arithmetic average CO ₂ mass emission result for the L phase test result(s), g/km;
CO ₂ ^{aveM}	is the arithmetic average CO ₂ mass emission result for the M phase test result(s), g/km;
CO ₂ ^{aveH}	is the arithmetic average CO ₂ mass emission result for the H phase test result(s), g/km;
CO ₂ ^{aveexH}	is the arithmetic average CO ₂ mass emission result for the exH phase test result(s), g/km;
D _L	is theoretical distance of phase L, km;
D _M	is theoretical distance of phase M, km;
D _H	is theoretical distance of phase H, km;
D _{exH}	is theoretical distance of phase exH, km.

1.1.2.4.1. If the total cycle declared value of the CO₂ mass emission is not accepted, the type approval phase-specific CO₂ mass emission value shall be calculated by taking the arithmetic average of the all test results for the respective phase.

1.1.2.4.2. Phase-specific values for fuel consumption

1.1.2.4.2. The fuel consumption value shall be calculated by the phase-specific CO₂ mass emission using the equations in paragraph 1.1.2.4.1. of this Sub-Annex and the arithmetic average of the emissions.

1.1.2.4.3. Phase-specific value for electric energy consumption, PER and AER.

1.1.2.4.3. The phase-specific electric energy consumption and the phase-specific electric ranges are calculated by taking the arithmetic average of the phase specific values of the test result(s), without an adjustment factor.

1.2. Type 1 test conditions

Status: Point in time view as at 01/06/2017.

Changes to legislation: There are outstanding changes not yet made to Commission Regulation (EU) 2017/1151. Any changes that have already been made to the legislation appear in the content and are referenced with annotations. (See end of Document for details)

1.2.1. Overview

1.2.1.1. The Type 1 test shall consist of prescribed sequences of dynamometer preparation, fuelling, soaking, and operating conditions.

1.2.1.2. The Type 1 test shall consist of vehicle operation on a chassis dynamometer on the applicable WLTC for the interpolation family. A proportional part of the diluted exhaust emissions shall be collected continuously for subsequent analysis using a constant volume sampler.

1.2.1.3. Background concentrations shall be measured for all compounds for which dilute mass emissions measurements are conducted. For exhaust emissions testing, this requires sampling and analysis of the dilution air.

1.2.1.3.1. Background particulate measurement

1.2.1.3.1.1. Where the manufacturer requests subtraction of either dilution air or dilution tunnel background particulate mass from emissions measurements, these background levels shall be determined according to the procedures listed in paragraphs 1.2.1.3.1.1.1. to 1.2.1.3.1.1.3. inclusive of this Sub-Annex.

1.2.1.3.1.1.1. The maximum permissible background correction shall be a mass on the filter equivalent to 1 mg/km at the flow rate of the test.

1.2.1.3.1.1.2. If the background exceeds this level, the default figure of 1 mg/km shall be subtracted.

1.2.1.3.1.1.3. Where subtraction of the background contribution gives a negative result, the background level shall be considered to be zero.

1.2.1.3.1.1.4. Dilution air background particulate mass level shall be determined by passing filtered dilution air through the particulate background filter. This shall be drawn from a point immediately downstream of the dilution air filters. Background levels in g/m³ shall be determined as a rolling arithmetic average of at least 14 measurements with at least one measurement per week.

1.2.1.3.1.1.5. Dilution tunnel background particulate mass level shall be determined by passing filtered dilution air through the particulate background filter. This shall be drawn from the same point as the particulate matter sample. Where secondary dilution is used for the test, the secondary dilution system shall be active for the purposes of background measurement. One measurement may be performed on the day of test, either prior to or after the test.

1.2.1.3.2. Background particle number determination

1.2.1.3.2.1. Where a manufacturer requests a background correction, these background levels shall be determined as follows:

1.2.1.3.2.1.1. The background value may be either calculated or measured. The maximum permissible background correction shall be related to the maximum allowable leak rate of the particle number measurement system (0,5 particles per cm³) scaled from the particle concentration reduction factor, PCRF, and the CVS flow rate used in the actual test;

1.2.1.3.2.1.2. Either the approval authority or the manufacturer may request that actual background measurements are used instead of calculated ones.

Status: Point in time view as at 01/06/2017.

Changes to legislation: There are outstanding changes not yet made to Commission Regulation (EU) 2017/1151. Any changes that have already been made to the legislation appear in the content and are referenced with annotations. (See end of Document for details)

1.2.1.3.2. Where subtraction of the background contribution gives a negative result, the PN result shall be considered to be zero.

1.2.1.3.2. Dilution air background particle number level shall be determined by sampling filtered dilution air. This shall be drawn from a point immediately downstream of the dilution air filters into the PN measurement system. Background levels in particles per cm³ shall be determined as a rolling arithmetic average of least 14 measurements with at least one measurement per week.

1.2.1.3.2. Dilution tunnel background particle number level shall be determined by sampling filtered dilution air. This shall be drawn from the same point as the PN sample. Where secondary dilution is used for the test the secondary dilution system shall be active for the purposes of background measurement. One measurement may be performed on the day of test, either prior to or after the test using the actual PCRF and the CVS flow rate utilised during the test.

1.2.2. General test cell equipment

1.2.2.1. Parameters to be measured

1.2.2.1.1. The following temperatures shall be measured with an accuracy of $\pm 1,5$ °C:

- (a) Test cell ambient air;
- (b) Dilution and sampling system temperatures as required for emissions measurement systems defined in Sub-Annex 5.

1.2.2.1.2. Atmospheric pressure shall be measurable with a resolution of $\pm 0,1$ kPa.

1.2.2.1.3. Specific humidity H shall be measurable with a resolution of ± 1 g H₂O/kg dry air.

1.2.2.2. Test cell and soak area

1.2.2.2.1. Test cell

1.2.2.2.1. The test cell shall have a temperature set point of 23 °C. The tolerance of the actual value shall be within ± 5 °C. The air temperature and humidity shall be measured at the test cell's cooling fan outlet at a minimum frequency of 1 Hz. For the temperature at the start of the test, see paragraph 1.2.8.1. in Sub-Annex 6.

1.2.2.2.1. The specific humidity H of either the air in the test cell or the intake air of the engine shall be such that:

$$5,5 \leq H \leq 12,2 (\text{g H}_2\text{O} / \text{kg dry air})$$

1.2.2.2.1. Humidity shall be measured continuously at a minimum frequency of 1 Hz.

1.2.2.2.2. Soak area

The soak area shall have a temperature set point of 23 °C and the tolerance of the actual value shall be within ± 3 °C on a 5 minute running arithmetic average and shall not show a systematic deviation from the set point. The temperature shall be measured continuously at a minimum frequency of 1 Hz.

1.2.3. Test vehicle

1.2.3.1. General

Status: Point in time view as at 01/06/2017.

Changes to legislation: There are outstanding changes not yet made to Commission Regulation (EU) 2017/1151. Any changes that have already been made to the legislation appear in the content and are referenced with annotations. (See end of Document for details)

The test vehicle shall conform in all its components with the production series, or, if the vehicle is different from the production series, a full description shall be included in all relevant test reports. In selecting the test vehicle, the manufacturer and approval authority shall agree which vehicle model is representative for the interpolation family.

For the measurement of emissions, the road load as determined with test vehicle H shall be applied. In the case of a road load matrix family, for the measurement of emissions, the road load as calculated for vehicle H_M according to paragraph 5.1. of Sub-Annex 4 shall be applied.

If at the request of the manufacturer the interpolation method is used (see paragraph 3.2.3.2. of Sub-Annex 7), an additional measurement of emissions shall be performed with the road load as determined with test vehicle L. Tests on vehicles H and L should be performed with the same test vehicle and shall be tested with the shortest final transmission ratio within the interpolation family. In the case of a road load matrix family, an additional measurement of emissions shall be performed with the road load as calculated for vehicle L_M according to paragraph 5.1. of Sub-Annex 4.

1.2.3.2. CO₂ interpolation range

The interpolation method shall only be used if the difference in CO₂ between test vehicles L and H is between a minimum of 5 and a maximum of 30 g/km or 20 per cent of the CO₂ emissions from vehicle H, whichever value is the lower.

At the request of the manufacturer and with approval of the approval authority, the interpolation line may be extrapolated to a maximum of 3 g/km above the CO₂ emission of vehicle H and/or below the CO₂ emission of vehicle L. This extension is valid only within the absolute boundaries of the interpolation range specified above.

This paragraph is not applicable for the difference in CO₂ between vehicles H_M and L_M of a road load matrix family.

1.2.3.3. Run-in

The vehicle shall be presented in good technical condition. It shall have been run-in and driven between 3 000 and 15 000 km before the test. The engine, transmission and vehicle shall be run-in in accordance with the manufacturer's recommendations.

1.2.4. Settings

1.2.4.1. Dynamometer settings and verification shall be performed according to Sub-Annex 4.

1.2.4.2. Dynamometer operation

1.2.4.2.1. Auxiliary devices shall be switched off or deactivated during dynamometer operation unless their operation is required.

1.2.4.2.2. The vehicle's dynamometer operation mode, if any, shall be activated by using the manufacturer's instruction (e.g. using vehicle steering wheel buttons in a special sequence, using the manufacturer's workshop tester, removing a fuse).

The manufacturer shall provide the approval authority a list of the deactivated devices and justification for the deactivation. The dynamometer operation mode shall be approved by the approval authority and the use of a dynamometer operation mode shall be included in all relevant test reports.

1.2.4.2.3. The dynamometer operation mode shall not activate, modulate, delay or deactivate the operation of any part that affects the emissions and fuel consumption under the test

Status: Point in time view as at 01/06/2017.

Changes to legislation: There are outstanding changes not yet made to Commission Regulation (EU) 2017/1151. Any changes that have already been made to the legislation appear in the content and are referenced with annotations. (See end of Document for details)

conditions. Any device that affects the operation on a chassis dynamometer shall be set to ensure a proper operation.

1.2.4.2.4. If the test vehicle is tested in a two-wheel drive (2WD) mode, the test vehicle shall be tested on a single-axis chassis dynamometer which fulfils the requirements according to paragraph 2. of Sub-Annex 5. At the request of the manufacturer and with the approval of the approval authority, the vehicle may be tested on a dual-axis chassis dynamometer.

1.2.4.2.5. If the test vehicle is tested in a mode which under WLTP conditions would enter into partially or permanent four-wheel drive (4WD) operation over the applicable cycle, the test vehicle shall be tested on a dual-axis chassis dynamometer which fulfils the requirements according to paragraph 2.3. of Sub-Annex 5.

At the request of the manufacturer and with the approval of the approval authority, the vehicle may be tested on a single-axis chassis dynamometer if the following conditions are met:

- (a) the test vehicle is converted to permanent 2WD operation in all test modes;
- (b) the manufacturer provides evidence to the approval authority that the CO₂, fuel consumption and/or electrical energy consumption of the converted vehicle is the same or higher as for the non-converted vehicle being tested on a dual-axis chassis dynamometer.

1.2.4.3. The vehicle's exhaust system shall not exhibit any leak likely to reduce the quantity of gas collected.

1.2.4.4. The settings of the powertrain and vehicle controls shall be those prescribed by the manufacturer for series production.

1.2.4.5. Tyres shall be of a type specified as original equipment by the vehicle manufacturer. Tyre pressure may be increased by up to 50 per cent above the pressure specified in paragraph 4.2.2.3. of Sub-Annex 4. The same tyre pressure shall be used for the setting of the dynamometer and for all subsequent testing. The tyre pressure used shall be included in all relevant test reports.

1.2.4.6. Reference fuel

1.2.4.6.1. The appropriate reference fuel as defined in Annex IX shall be used for testing.

1.2.4.7. Test vehicle preparation

1.2.4.7.1. The vehicle shall be approximately horizontal during the test so as to avoid any abnormal distribution of the fuel.

1.2.4.7.2. If necessary, the manufacturer shall provide additional fittings and adapters, as required to accommodate a fuel drain at the lowest point possible in the tank(s) as installed on the vehicle, and to provide for exhaust sample collection.

1.2.4.7.3. For PM sampling during a test when the regenerating device is in a stabilized loading condition (i.e. the vehicle is not undergoing a regeneration), it is recommended that the vehicle has completed > 1/3 of the mileage between scheduled regenerations or that the periodically regenerating device has undergone equivalent loading off the vehicle.

1.2.5. Preliminary testing cycles

1.2.5.1. Preliminary testing cycles may be carried out if requested by the manufacturer to follow the speed trace within the prescribed limits.

Status: Point in time view as at 01/06/2017.

Changes to legislation: There are outstanding changes not yet made to Commission Regulation (EU) 2017/1151. Any changes that have already been made to the legislation appear in the content and are referenced with annotations. (See end of Document for details)

1.2.6. Test vehicle preconditioning

1.2.6.1. The fuel tank (or fuel tanks) shall be filled with the specified test fuel. If the existing fuel in the fuel tank (or fuel tanks) does not meet the specifications contained in paragraph 1.2.4.6. of this Sub-Annex, the existing fuel shall be drained prior to the fuel fill. The evaporative emission control system shall neither be abnormally purged nor abnormally loaded.

1.2.6.2. REESSs charging

Before the preconditioning test cycle, the REESSs shall be fully charged. At the request of the manufacturer, charging may be omitted before preconditioning. The REESSs shall not be charged again before official testing.

1.2.6.3. The test vehicle shall be moved to the test cell and the operations listed in paragraphs 1.2.6.3.1. to 1.2.6.3.9. inclusive shall be performed.

1.2.6.3.1. The test vehicle shall be placed, either by being driven or pushed, on a dynamometer and operated through the applicable WLTCs. The vehicle need not be cold, and may be used to set the dynamometer load.

1.2.6.3.2. The dynamometer load shall be set according to paragraphs 7. and 8. of Sub-Annex 4.

1.2.6.3.3. During preconditioning, the test cell temperature shall be the same as defined for the Type 1 test (paragraph 1.2.2.2.1. of this Sub-Annex).

1.2.6.3.4. The drive-wheel tyre pressure shall be set in accordance with paragraph 1.2.4.5. of this Sub-Annex.

1.2.6.3.5. Between the tests on the first gaseous reference fuel and the second gaseous reference fuel, for vehicles with positive ignition engines fuelled with LPG or NG/biomethane or so equipped that they can be fuelled with either petrol or LPG or NG/biomethane, the vehicle shall be preconditioned again before the test on the second reference fuel.

1.2.6.3.6. For preconditioning, the applicable WLTC shall be driven. Starting the engine and driving shall be performed according to paragraph 1.2.6.4. of this Sub-Annex.

The dynamometer shall be set according to Sub-Annex 4.

1.2.6.3.7. At the request of the manufacturer or approval authority, additional WLTCs may be performed in order to bring the vehicle and its control systems to a stabilized condition.

1.2.6.3.8. The extent of such additional preconditioning shall be included in all relevant test reports.

1.2.6.3.9. In a test facility in which there may be possible contamination of a low particulate emitting vehicle test with residue from a previous test on a high particulate emitting vehicle, it is recommended, for the purpose of sampling equipment preconditioning, that a 120 km/h steady state drive cycle of 20 minutes duration be driven by a low particulate emitting vehicle. Longer and/or higher speed running is permissible for sampling equipment preconditioning if required. Dilution tunnel background measurements shall be taken after the tunnel preconditioning, and prior to any subsequent vehicle testing.

1.2.6.4. The powertrain start procedure shall be initiated by means of the devices provided for this purpose according to the manufacturer's instructions.

Status: Point in time view as at 01/06/2017.

Changes to legislation: There are outstanding changes not yet made to Commission Regulation (EU) 2017/1151. Any changes that have already been made to the legislation appear in the content and are referenced with annotations. (See end of Document for details)

A non-vehicle initiated switching of mode of operation during the test shall not be permitted unless otherwise specified.

1.2.6.4.1. If the initiation of the powertrain start procedure is not successful, e.g. the engine does not start as anticipated or the vehicle displays a start error, the test is void, preconditioning tests shall be repeated and a new test shall be driven.

1.2.6.4.2. The cycle starts on initiation of the powertrain start procedure.

1.2.6.4.3. In the cases where LPG or NG/biomethane is used as a fuel, it is permissible that the engine is started on petrol and switched automatically to LPG or NG/biomethane after a predetermined period of time that cannot be changed by the driver.

1.2.6.4.4. During stationary/idling vehicle phases, the brakes shall be applied with appropriate force to prevent the drive wheels from turning.

1.2.6.4.5. During the test, speed shall be measured against time or collected by the data acquisition system at a frequency of not less than 1 Hz so that the actual driven speed can be assessed.

1.2.6.4.6. The distance actually driven by the vehicle shall be included in all relevant test sheets for each WLTC phase.

1.2.6.5. Use of the transmission

1.2.6.5.1. Manual shift transmission

The gear shift prescriptions specified in Sub-Annex 2 shall be followed. Vehicles tested according to Sub-Annex 8 shall be driven according to paragraph 1.5. of that Sub-Annex.

Vehicles that cannot attain the acceleration and maximum speed values required in the applicable WLTC shall be operated with the accelerator control fully activated until they once again reach the required speed trace. Speed trace violations under these circumstances shall not void a test. Deviations from the driving cycle shall be included in all relevant test sheets.

1.2.6.5.1. The tolerances given in paragraph 1.2.6.6. of this Sub-Annex shall apply.

1.2.6.5.1. The gear change shall be started and completed within $\pm 1,0$ second of the prescribed gear shift point.

1.2.6.5.1. The clutch shall be depressed within $\pm 1,0$ second of the prescribed clutch operating point.

1.2.6.5.2. Automatic shift transmission

1.2.6.5.2. Vehicles equipped with automatic shift transmissions shall be tested in the predominant mode. The accelerator control shall be used in such a way as to accurately follow the speed trace.

1.2.6.5.2. Vehicles equipped with automatic shift transmissions with driver-selectable modes shall fulfill the limits of criteria emissions in all automatic shift modes used for forward driving. The manufacturer shall give appropriate evidence to the approval authority. On the basis of technical evidence provided by the manufacturer and with the agreement of the approval authority, the dedicated driver-selectable modes for very special limited purposes shall not be considered (e.g. maintenance mode, crawler mode).

Status: Point in time view as at 01/06/2017.

Changes to legislation: There are outstanding changes not yet made to Commission Regulation (EU) 2017/1151. Any changes that have already been made to the legislation appear in the content and are referenced with annotations. (See end of Document for details)

1.2.6.5.2. The manufacturer shall give evidence to the approval authority of the existence of a mode that fulfils the requirements of paragraph 3.5.9. of this Annex. With the agreement of the approval authority, the predominant mode may be used as the only mode for the determination of criteria emissions, CO₂ emissions, and fuel consumption. Notwithstanding the existence of a predominant mode, the criteria emission limits shall be fulfilled in all considered automatic shift modes used for forward driving as described in paragraph 1.2.6.5.2.2. of this Sub-Annex.

1.2.6.5.2. If the vehicle has no predominant mode or the requested predominant mode is not agreed by the approval authority as a predominant mode, the vehicle shall be tested in the best case mode and worst case mode for criteria emissions, CO₂ emissions, and fuel consumption. Best and worst case modes shall be identified by the evidence provided on the CO₂ emissions and fuel consumption in all modes. CO₂ emissions and fuel consumption shall be the arithmetic average of the test results in both modes. Test results for both modes shall be included in all relevant test reports. Notwithstanding the usage of the best and worst case modes for testing, the criteria emission limits shall be fulfilled in all automatic shift modes in consideration used for forward driving as described in paragraph 1.2.6.5.2.2. of this Sub-Annex.

1.2.6.5.2. The tolerances given in paragraph 1.2.6.6. of this Sub-Annex shall apply.

After initial engagement, the selector shall not be operated at any time during the test. Initial engagement shall be done 1 second before beginning the first acceleration.

1.2.6.5.2. Vehicles with an automatic transmission with a manual mode shall be tested according paragraph 1.2.6.5.2. of this Sub-Annex.

1.2.6.6. Speed trace tolerances

The following tolerances shall be permitted between the actual vehicle speed and the prescribed speed of the applicable test cycles. The tolerances shall not be shown to the driver:

- (a) Upper limit: 2,0 km/h higher than the highest point of the trace within $\pm 1,0$ second of the given point in time;
- (b) Lower limit: 2,0 km/h lower than the lowest point of the trace within $\pm 1,0$ second of the given time.

See Figure A6/2.

Speed tolerances greater than those prescribed shall be accepted provided the tolerances are never exceeded for more than 1 second on any one occasion.

There shall be no more than ten such deviations per test.

Figure A6/2

Status: Point in time view as at 01/06/2017.

Changes to legislation: There are outstanding changes not yet made to Commission Regulation (EU) 2017/1151. Any changes that have already been made to the legislation appear in the content and are referenced with annotations. (See end of Document for details)

Speed trace tolerances

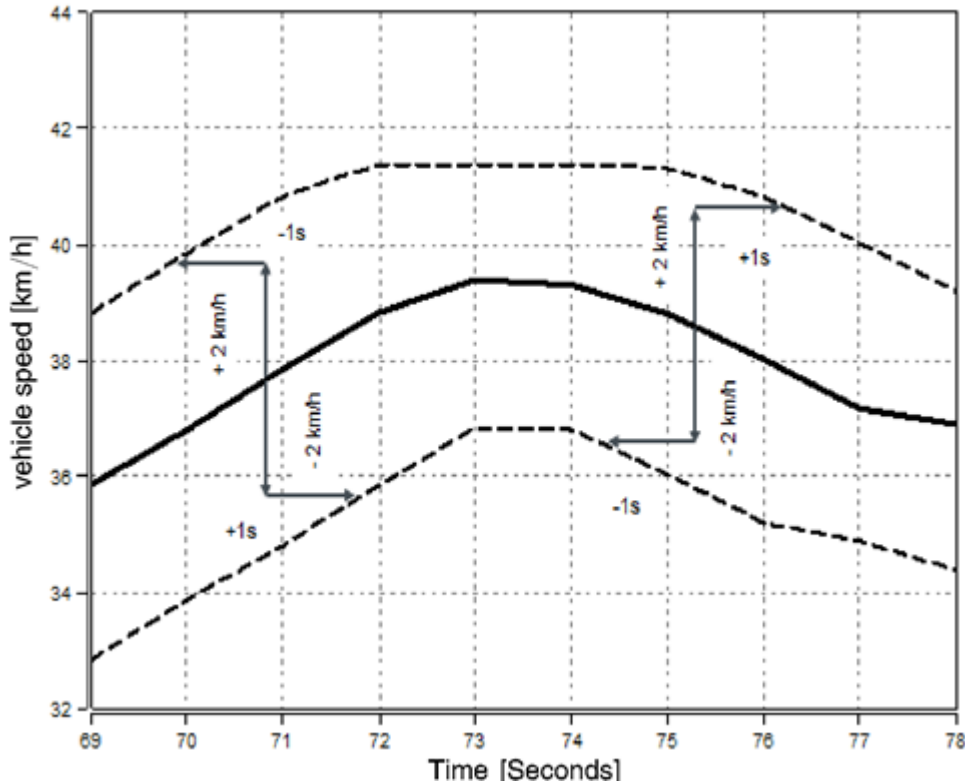

1.2.6.7. Accelerations

1.2.6.7.1. The vehicle shall be operated with the appropriate accelerator control movement necessary to accurately follow the speed trace.

1.2.6.7.2. The vehicle shall be operated smoothly, following representative shift points, speeds and procedures.

1.2.6.7.3. For manual transmissions, the accelerator controller shall be released during each shift and the shift shall be accomplished in minimum time.

1.2.6.7.4. If the vehicle cannot follow the speed trace, it shall be operated at maximum available power until the vehicle speed reaches the respective target speed again.

1.2.6.8. Decelerations

1.2.6.8.1. During decelerations of the cycle, the driver shall deactivate the accelerator control but shall not manually disengage the clutch until the point specified in paragraph 4. (c) of Sub-Annex 2.

1.2.6.8.1. If the vehicle decelerates faster than prescribed by the speed trace, the accelerator control shall be operated such that the vehicle accurately follows the speed trace.

1.2.6.8.1. If the vehicle decelerates too slowly to follow the intended deceleration, the brakes shall be applied such that it is possible to accurately follow the speed trace.

1.2.6.9. Unexpected engine stop

1.2.6.9.1. If the engine stops unexpectedly, the preconditioning or Type 1 test shall be declared void.

Status: Point in time view as at 01/06/2017.

Changes to legislation: There are outstanding changes not yet made to Commission Regulation (EU) 2017/1151. Any changes that have already been made to the legislation appear in the content and are referenced with annotations. (See end of Document for details)

1.2.6.10. After completion of the cycle, the engine shall be switched off. The vehicle shall not be restarted until the beginning of the test for which the vehicle has been preconditioned.

1.2.7. Soaking

1.2.7.1. After preconditioning and before testing, the test vehicle shall be kept in an area with ambient conditions as specified in paragraph 1.2.2.2.2. of this Sub-Annex.

1.2.7.2. The vehicle shall be soaked for a minimum of 6 hours and a maximum of 36 hours with the engine compartment cover opened or closed. If not excluded by specific provisions for a particular vehicle, cooling may be accomplished by forced cooling down to the set point temperature. If cooling is accelerated by fans, the fans shall be placed so that the maximum cooling of the drive train, engine and exhaust after-treatment system is achieved in a homogeneous manner.

1.2.8. Emission and fuel consumption test (Type 1 test)

1.2.8.1. The test cell temperature at the start of the test shall be $23\text{ °C} \pm 3\text{ °C}$ measured at minimum frequency of 1 Hz. The engine oil temperature and coolant temperature, if any, shall be within $\pm 2\text{ °C}$ of the set point of 23 °C .

1.2.8.2. The test vehicle shall be pushed onto a dynamometer.

1.2.8.2.1. The drive wheels of the vehicle shall be placed on the dynamometer without starting the engine.

1.2.8.2.2. The drive-wheel tyre pressures shall be set in accordance with the provisions of paragraph 1.2.4.5. of this Sub-Annex.

1.2.8.2.3. The engine compartment cover shall be closed.

1.2.8.2.4. An exhaust connecting tube shall be attached to the vehicle tailpipe(s) immediately before starting the engine.

1.2.8.3. Starting of the powertrain and driving

1.2.8.3.1. The powertrain start procedure shall be initiated by means of the devices provided for this purpose according to the manufacturer's instructions.

1.2.8.3.2. The vehicle shall be driven as described in paragraphs 1.2.6.4. to 1.2.6.10. inclusive of this Sub-Annex over the applicable WLTC, as described in Sub-Annex 1.

1.2.8.4. RCB data shall be measured for each phase of the WLTC as defined in Appendix 2 to this Sub-Annex.

1.2.8.5. Actual vehicle speed shall be sampled with a measurement frequency of 10 Hz and the drive trace indices described in paragraph 7. of Sub-Annex 7 shall be calculated and documented.

1.2.9. Gaseous sampling

Gaseous samples shall be collected in bags and the compounds analysed at the end of the test or a test phase, or the compounds may be analysed continuously and integrated over the cycle.

1.2.9.1. The following steps shall be taken prior to each test.

1.2.9.1.1. The purged, evacuated sample bags shall be connected to the dilute exhaust and dilution air sample collection systems.

Status: Point in time view as at 01/06/2017.

Changes to legislation: There are outstanding changes not yet made to Commission Regulation (EU) 2017/1151. Any changes that have already been made to the legislation appear in the content and are referenced with annotations. (See end of Document for details)

- 1.2.9.1.2. Measuring instruments shall be started according to the instrument manufacturers' instructions.
- 1.2.9.1.3. The CVS heat exchanger (if installed) shall be pre-heated or pre-cooled to within its operating test temperature tolerance as specified in paragraph 3.3.5.1. of Sub-Annex 5.
- 1.2.9.1.4. Components such as sample lines, filters, chillers and pumps shall be heated or cooled as required until stabilised operating temperatures are reached.
- 1.2.9.1.5. CVS flow rates shall be set according to paragraph 3.3.4. of Sub-Annex 5, and sample flow rates shall be set to the appropriate levels.
- 1.2.9.1.6. Any electronic integrating device shall be zeroed and may be re-zeroed before the start of any cycle phase.
- 1.2.9.1.7. For all continuous gas analysers, the appropriate ranges shall be selected. These may be switched during a test only if switching is performed by changing the calibration over which the digital resolution of the instrument is applied. The gains of an analyser's analogue operational amplifiers may not be switched during a test.
- 1.2.9.1.8. All continuous gas analysers shall be zeroed and calibrated using gases fulfilling the requirements of paragraph 6. of Sub-Annex 5.
- 1.2.10. Sampling for PM determination
- 1.2.10.1. The steps described in paragraphs 1.2.10.1.1. to 1.2.10.1.2.3. inclusive of this Sub-Annex shall be taken prior to each test.
- 1.2.10.1.1. Filter selection
- 1.2.10.1.1.A) A single particulate sample filter without back-up shall be employed for the complete applicable WLTC. In order to accommodate regional cycle variations, a single filter may be employed for the first three phases and a separate filter for the fourth phase.
- 1.2.10.1.2. Filter preparation
- 1.2.10.1.2.A) At least 1 hour before the test, the filter shall be placed in a petri dish protecting against dust contamination and allowing air exchange, and placed in a weighing chamber (or room) for stabilization.

At the end of the stabilization period, the filter shall be weighed and its weight shall be included in all relevant test sheets. The filter shall subsequently be stored in a closed petri dish or sealed filter holder until needed for testing. The filter shall be used within 8 hours of its removal from the weighing chamber (or room).

The filter shall be returned to the stabilization room within 1 hour after the test and shall be conditioned for at least 1 hour before weighing.

- 1.2.10.1.2.B) The particulate sample filter shall be carefully installed into the filter holder. The filter shall be handled only with forceps or tongs. Rough or abrasive filter handling will result in erroneous weight determination. The filter holder assembly shall be placed in a sample line through which there is no flow.
- 1.2.10.1.2.C) It is recommended that the microbalance be checked at the start of each weighing session, within 24 hours of the sample weighing, by weighing one reference item of approximately 100 mg. This item shall be weighed three times and the arithmetic average result included in all relevant test sheets. If the arithmetic average result of

Status: Point in time view as at 01/06/2017.

Changes to legislation: There are outstanding changes not yet made to Commission Regulation (EU) 2017/1151. Any changes that have already been made to the legislation appear in the content and are referenced with annotations. (See end of Document for details)

the weighings is $\pm 5 \mu\text{g}$ of the result from the previous weighing session, the weighing session and balance are considered valid.

1.2.11. PN sampling

1.2.11.1. The steps described in paragraphs 1.2.11.1.1. to 1.2.11.1.2. inclusive of this Sub-Annex shall be taken prior to each test:

1.2.11.1.1. The particle specific dilution system and measurement equipment shall be started and made ready for sampling;

1.2.11.1.2. The correct function of the PNC and VPR elements of the particle sampling system shall be confirmed according to the procedures listed in paragraphs 1.2.11.1.2.1. to 1.2.11.1.2.4. inclusive of this Sub-Annex.

1.2.11.1.2A. A leak check, using a filter of appropriate performance attached to the inlet of the entire PN measurement system, VPR and PNC, shall report a measured concentration of less than 0.5 particles per cm^3 .

1.2.11.1.2B. Each day, a zero check on the PNC, using a filter of appropriate performance at the PNC inlet, shall report a concentration of $\leq 0,2$ particles per cm^3 . Upon removal of the filter, the PNC shall show an increase in measured concentration to at least 100 particles per cm^3 when sampling ambient air and a return to ≤ 0.2 particles per cm^3 on replacement of the filter.

1.2.11.1.2C. It shall be confirmed that the measurement system indicates that the evaporation tube, where featured in the system, has reached its correct operating temperature.

1.2.11.1.2D. It shall be confirmed that the measurement system indicates that the diluter PND₁ has reached its correct operating temperature.

1.2.12. Sampling during the test

1.2.12.1. The dilution system, sample pumps and data collection system shall be started.

1.2.12.2. The PM and PN sampling systems shall be started.

1.2.12.3. Particle number shall be measured continuously. The arithmetic average concentration shall be determined by integrating the analyser signals over each phase.

1.2.12.4. Sampling shall begin before or at the initiation of the powertrain start procedure and end on conclusion of the cycle.

1.2.12.5. Sample switching

1.2.12.5.1. Gaseous emissions

1.2.12.5.1. Sampling from the diluted exhaust and dilution air shall be switched from one pair of sample bags to subsequent bag pairs, if necessary, at the end of each phase of the applicable WLTC to be driven.

1.2.12.5.2. Particulate

1.2.12.5.2. The requirements of paragraph 1.2.10.1.1.1. of this Sub-Annex shall apply.

1.2.12.6. Dynamometer distance shall be included in all relevant test sheets for each phase.

1.2.13. Ending the test

Status: Point in time view as at 01/06/2017.

Changes to legislation: There are outstanding changes not yet made to Commission Regulation (EU) 2017/1151. Any changes that have already been made to the legislation appear in the content and are referenced with annotations. (See end of Document for details)

- 1.2.13.1. The engine shall be turned off immediately after the end of the last part of the test.
- 1.2.13.2. The constant volume sampler, CVS, or other suction device shall be turned off, or the exhaust tube from the tailpipe or tailpipes of the vehicle shall be disconnected.
- 1.2.13.3. The vehicle may be removed from the dynamometer.
- 1.2.14. Post-test procedures
- 1.2.14.1. Gas analyser check
- 1.2.14.1.1. Zero and calibration gas reading of the analysers used for continuous diluted measurement shall be checked. The test shall be considered acceptable if the difference between the pre-test and post-test results is less than 2 per cent of the calibration gas value.
- 1.2.14.2. Bag analysis
- 1.2.14.2.1. Exhaust gases and dilution air contained in the bags shall be analysed as soon as possible. Exhaust gases shall, in any event, be analysed not later than 30 minutes after the end of the cycle phase.
- The gas reactivity time for compounds in the bag shall be taken into consideration.
- 1.2.14.2.2. As soon as practical prior to analysis, the analyser range to be used for each compound shall be set to zero with the appropriate zero gas.
- 1.2.14.2.3. The calibration curves of the analysers shall be set by means of calibration gases of nominal concentrations of 70 to 100 per cent of the range.
- 1.2.14.2.4. The zero settings of the analysers shall be subsequently rechecked: if any reading differs by more than 2 per cent of the range from that set in paragraph 1.2.14.2.2. of this Sub-Annex, the procedure shall be repeated for that analyser.
- 1.2.14.2.5. The samples shall be subsequently analysed.
- 1.2.14.2.6. After the analysis, zero and calibration points shall be rechecked using the same gases. The test shall be considered acceptable if the difference is less than 2 per cent of the calibration gas value.
- 1.2.14.2.7. The flow rates and pressures of the various gases through analysers shall be the same as those used during calibration of the analysers.
- 1.2.14.2.8. The content of each of the compounds measured shall be included in all relevant test sheets after stabilization of the measuring device.
- 1.2.14.2.9. The mass and number of all emissions, where applicable, shall be calculated according to Sub-Annex 7.
- 1.2.14.2.10. Calibrations and checks shall be performed either:
- (a) Before and after each bag pair analysis; or
 - (b) Before and after the complete test.

In case (b), calibrations and checks shall be performed on all analysers for all ranges used during the test.

Status: Point in time view as at 01/06/2017.

Changes to legislation: There are outstanding changes not yet made to Commission Regulation (EU) 2017/1151. Any changes that have already been made to the legislation appear in the content and are referenced with annotations. (See end of Document for details)

In both cases, (a) and (b), the same analyser range shall be used for the corresponding ambient air and exhaust bags.

1.2.14.3. Particulate sample filter weighing

1.2.14.3.1 The particulate sample filter shall be returned to the weighing chamber (or room) no later than 1 hour after completion of the test. It shall be conditioned in a petri dish, which is protected against dust contamination and allows air exchange, for at least 1 hour, and weighed. The gross weight of the filter shall be included in all relevant test sheets.

1.2.14.3.2 At least two unused reference filters shall be weighed within 8 hours of, but preferably at the same time as, the sample filter weighings. Reference filters shall be of the same size and material as the sample filter.

1.2.14.3.3 If the specific weight of any reference filter changes by more than $\pm 5 \mu\text{g}$ between sample filter weighings, the sample filter and reference filters shall be reconditioned in the weighing chamber (or room) and reweighed.

1.2.14.3.4 The comparison of reference filter weighings shall be made between the specific weights and the rolling arithmetic average of that reference filter's specific weights. The rolling arithmetic average shall be calculated from the specific weights collected in the period after the reference filters were placed in the weighing chamber (or room). The averaging period shall be at least one day but not more than 15 days.

1.2.14.3.5 Multiple reconditionings and reweighings of the sample and reference filters are permitted until a period of 80 hours has elapsed following the measurement of gases from the emissions test. If, prior to or at the 80 hour point, more than half the number of reference filters meet the $\pm 5 \mu\text{g}$ criterion, the sample filter weighing may be considered valid. If, at the 80 hour point, two reference filters are employed and one filter fails the $\pm 5 \mu\text{g}$ criterion, the sample filter weighing may be considered valid under the condition that the sum of the absolute differences between specific and rolling means from the two reference filters shall be less than or equal to $10 \mu\text{g}$.

1.2.14.3.6 In the case that less than half of the reference filters meet the $\pm 5 \mu\text{g}$ criterion, the sample filter shall be discarded, and the emissions test repeated. All reference filters shall be discarded and replaced within 48 hours. In all other cases, reference filters shall be replaced at least every 30 days and in such a manner that no sample filter is weighed without comparison to a reference filter that has been present in the weighing chamber (or room) for at least one day.

1.2.14.3.7 If the weighing chamber (or room) stability criteria outlined in paragraph 4.2.2.1. of Sub-Annex 5 are not met, but the reference filter weighings meet the above criteria, the vehicle manufacturer has the option of accepting the sample filter weights or voiding the tests, repairing the weighing chamber (or room) control system and re-running the test.

Sub-Annex 6

Appendix 1

Emissions test procedure for all vehicles equipped with periodically regenerating systems

1. General

Status: Point in time view as at 01/06/2017.

Changes to legislation: There are outstanding changes not yet made to Commission Regulation (EU) 2017/1151. Any changes that have already been made to the legislation appear in the content and are referenced with annotations. (See end of Document for details)

- 1.1. This Appendix defines the specific provisions regarding testing a vehicle equipped with periodically regenerating systems as defined in paragraph 3.8.1. of this Annex.

Upon request of the manufacturer and with approval of the approval authority, a manufacturer may develop an alternative procedure to demonstrate its equivalency, including filter temperature, loading quantity and distance driven. This may be done on an engine bench or on a chassis dynamometer.

Alternatively to carrying out the test procedures defined in this Appendix, a fixed K_i value of 1,05 may be used for CO₂ and fuel consumption.

- 1.2. During cycles where regeneration occurs, emission standards need not apply. If a periodic regeneration occurs at least once per Type 1 test and has already occurred at least once during vehicle preparation, it does not require a special test procedure. In this case, this Appendix does not apply.
- 1.3. The provisions of this Appendix shall apply for the purposes of PM measurements only and not PN measurements.
- 1.4. At the request of the manufacturer, and with approval of the approval authority, the test procedure specific to periodically regenerating systems will not apply to a regenerative device if the manufacturer provides data demonstrating that, during cycles where regeneration occurs, emissions remain below the emissions limits for the relevant vehicle category.
- 1.5. At the request of the manufacturer and with the agreement of the approval authority the Extra High phase may be excluded for determining the regenerative factor K_i for Class 2 and Class 3 vehicles.

2. Test Procedure

The test vehicle shall be capable of inhibiting or permitting the regeneration process provided that this operation has no effect on original engine calibrations. Prevention of regeneration is only permitted during loading of the regeneration system and during the preconditioning cycles. It is not permitted during the measurement of emissions during the regeneration phase. The emission test shall be carried out with the unchanged, original equipment manufacturer's (OEM) control unit. At the request of the manufacturer and with approval of the approval authority, an 'engineering control unit' which has no effect on original engine calibrations may be used during K_i determination.

- 2.1. Exhaust emissions measurement between two WLTCs with regeneration events
- 2.1.1. The arithmetic average emissions between regeneration events and during loading of the regenerative device shall be determined from the arithmetic mean of several approximately equidistant (if more than two) Type 1 tests. As an alternative, the manufacturer may provide data to show that the emissions remain constant (± 15 per cent) on WLTCs between regeneration events. In this case, the emissions measured during the Type 1 test may be used. In any other case, emissions measurements for at least two Type 1 cycles shall be completed: one immediately after regeneration (before new loading) and one as close as possible prior to a regeneration phase. All emissions measurements shall be carried out according to this Sub-Annex and all calculations shall be carried out according to paragraph 3. of this Appendix.
- 2.1.2. The loading process and determination shall be made during the Type 1 driving cycle on a chassis dynamometer or on an engine test bench using an equivalent test cycle. These cycles may be run continuously (i.e. without the need to switch the engine off

Status: Point in time view as at 01/06/2017.

Changes to legislation: There are outstanding changes not yet made to Commission Regulation (EU) 2017/1151. Any changes that have already been made to the legislation appear in the content and are referenced with annotations. (See end of Document for details)

between cycles). After any number of completed cycles, the vehicle may be removed from the chassis dynamometer and the test continued at a later time.

2.1.3. The number of cycles D between two WLTCs where regeneration events occur, the number of cycles over which emission measurements are made n and mass emissions measurement M'_{sij} for each compound i over each cycle j shall be included in all relevant test sheets.

2.2. Measurement of emissions during regeneration events

2.2.1. Preparation of the vehicle, if required, for the emissions test during a regeneration phase, may be completed using the preconditioning cycles in paragraph 1.2.6. of this Sub-Annex or equivalent engine test bench cycles, depending on the loading procedure chosen in paragraph 2.1.2. of this Sub-Annex.

2.2.2. The test and vehicle conditions for the Type 1 test described in this Annex apply before the first valid emission test is carried out.

2.2.3. Regeneration shall not occur during the preparation of the vehicle. This may be ensured by one of the following methods:

2.2.3.1. A 'dummy' regenerating system or partial system may be fitted for the preconditioning cycles.

2.2.3.2. Any other method agreed between the manufacturer and the approval authority.

2.2.4. A cold start exhaust emissions test including a regeneration process shall be performed according to the applicable WLTC.

2.2.5. If the regeneration process requires more than one WLTC, each WLTC shall be completed. Use of a single particulate sample filter for multiple cycles required to complete regeneration is permissible.

2.2.5.1. If more than one WLTC is required, subsequent WLTC(s) shall be driven immediately, without switching the engine off, until complete regeneration has been achieved. In the case that the number of gaseous emission bags required for the multiple cycles would exceed the number of bags available, the time necessary to set up a new test shall be as short as possible. The engine shall not be switched off during this period.

2.2.6. The emission values during regeneration M_{ri} for each compound i shall be calculated according to paragraph 3. in this Appendix. The number of applicable test cycles d measured for complete regeneration shall be included in all relevant test sheets.

3. Calculations

3.1. Calculation of the exhaust and CO₂ emissions, and fuel consumption of a single regenerative system

$$M_{si} = \frac{\sum_n^{j-1} M_{sij}}{n} \text{ for } n \geq 1$$

$$M_{ri} = \frac{\sum_d^{j-1} M_{rij}}{d} \text{ for } d \geq 1$$

$$M_{pi} = \frac{M_{si} \times D + M_{ri} \times d}{D + d}$$

where for each compound i considered:

M'_{sij} are the mass emissions of compound i over test cycle j without regeneration, g/km;

Status: Point in time view as at 01/06/2017.

Changes to legislation: There are outstanding changes not yet made to Commission Regulation (EU) 2017/1151. Any changes that have already been made to the legislation appear in the content and are referenced with annotations. (See end of Document for details)

M'_{rij}	are the mass emissions of compound i over test cycle j during regeneration, g/km (if , the first WLTC test shall be run cold and subsequent cycles hot);
M_{si}	are the mean mass emissions of compound i without regeneration, g/km;
M_{ri}	are the mean mass emissions of compound i during regeneration, g/km;
M_{pi}	are the mean mass emissions of compound i , g/km;
n	is the number of test cycles, between cycles where regenerative events occur, during which emissions measurements on Type 1 WLTCs are made, ≥ 1 ;
d	is the number of complete applicable test cycles required for regeneration;
D	is the number of complete applicable test cycles between two cycles where regeneration events occur.

The calculation of M_{pi} is shown graphically in Figure A6. App1/1.

Figure A6.App1/1

Status: Point in time view as at 01/06/2017.

Changes to legislation: There are outstanding changes not yet made to Commission Regulation (EU) 2017/1151. Any changes that have already been made to the legislation appear in the content and are referenced with annotations. (See end of Document for details)

Parameters measured during emissions test during and between cycles where regeneration occurs (schematic example, the emissions during D may increase or decrease)

<p align="center">Manufacturer's Certificate on Access to Vehicle OBD and Vehicle Repair and Maintenance Information</p> <p>(Manufacturer) :</p> <p>(Address of the manufacturer) :</p> <p align="center">Certifies that</p> <p>it provides access to vehicle OBD and vehicle repair and maintenance information in compliance with the provisions of:</p> <ul style="list-style-type: none">- Article 6 of Regulation (EC) No 715/2007;- Articles 4(6) and 13 of Implementing Regulation (EU) 2017/1151;- Annex I, section 2.3.1 and 2.3.5 of Implementing Regulation (EU) 2017/1151;- Annex I, Appendix 3, section 16 of Implementing Regulation (EU) 2017/1151;- Annex I, Appendix 5 of Implementing Regulation (EU) 2017/1151;- Annex XI, section 4 of Implementing Regulation (EU) 2017/1151; and- Annex XIV of Implementing Regulation (EU) 2017/1151 <p>with respect to the vehicle types listed in attachment to this Certificate.</p> <p>The principal website address through which the relevant information may be accessed and which are hereby certified to be in compliance with the above provisions are listed in an attachment to this Certificate along with the contact details of the responsible manufacturer's representative whose signature is below.</p> <p>Where applicable: The manufacturer hereby also certifies that it has complied with the obligation in Article 13(5) of this Regulation to provide the relevant information for previous approvals of these vehicle types no later than 6 months after the date of type-approval.</p> <p align="center">Done at [..... Place]</p> <p align="center">On [..... Date]</p> <p align="center">[Signature of the Manufacturer's Representative]</p> <p align="center">Annexes: Website Addresses</p> <p align="center">Contact Details</p>

3.1.1. Calculation of the regeneration factor K_i for each compound i considered.

Status: Point in time view as at 01/06/2017.

Changes to legislation: There are outstanding changes not yet made to Commission Regulation (EU) 2017/1151. Any changes that have already been made to the legislation appear in the content and are referenced with annotations. (See end of Document for details)

The manufacturer may elect to determine for each compound independently either additive offsets or multiplicative factors.

K_i factor:

$$K_i = \frac{M_{pi}}{M_{si}}$$

K_i offset:

$$K_i = M_{pi} - M_{si}$$

M_{si} , M_{pi} and K_i results, and the manufacturer's choice of type of factor shall be recorded. The K_i result shall be included in all relevant test reports. M_{si} , M_{pi} and K_i results shall be included in all relevant test sheets.

K_i may be determined following the completion of a single regeneration sequence comprising measurements before, during and after regeneration events as shown in Figure A6. App1/1.

3.2. Calculation of exhaust and CO₂ emissions, and fuel consumption of multiple periodic regenerating systems

The following shall be calculated for (a) one Type 1 operation cycle for criteria emissions and (b) for each individual phase for CO₂ emissions and fuel consumption.

$$M_{sik} = \frac{\sum_{j=1}^{n_k} M'_{sikj}}{n_k} \text{ for } n_j \geq 1$$

$$M_{rik} = \frac{\sum_{d=1}^{d_k} M'_{rikd}}{d_k} \text{ for } d \geq 1$$

$$M_{si} = \frac{\sum_{k=1}^{k-1} M_{sik} \times D_k}{\sum_{k=1}^{k-1} D_k}$$

$$M_{ri} = \frac{\sum_{k=1}^{k-1} M_{rik} \times d_k}{\sum_{k=1}^{k-1} d_k}$$

$$M_{pi} = \frac{M_{si} \times \sum_{k=1}^{k-1} D_k + M_{ri} \times \sum_{k=1}^{k-1} d_k}{\sum_{k=1}^{k-1} (D_k + d_k)}$$

$$M_{pi} = \frac{\sum_{k=1}^{k-1} (M_{sik} \times D_k + M_{rik} \times d_k)}{\sum_{k=1}^{k-1} (D_k + d_k)}$$

K_i factor:

$$K_i = \frac{M_{pi}}{M_{si}}$$

K_i offset:

$$K_i = M_{pi} - M_{si}$$

where:

M_{si} are the mean mass emissions of all events k of compound i without regeneration, g/km;

M_{ri} are the mean mass emissions of all events k of compound i during regeneration, g/km;

M_{pi} are the mean mass emission of all events k of compound i , g/km;

M_{sik} are the mean mass emissions of event k of compound i without regeneration, g/km;

M_{rik} are the mean mass emissions of event k of compound i during regeneration, g/km;

M'_{sikj} are the mass emissions of event k of compound i in g/km without regeneration measured at point j where $1 \leq j \leq n_k$, g/km;

Status: Point in time view as at 01/06/2017.

Changes to legislation: There are outstanding changes not yet made to Commission Regulation (EU) 2017/1151. Any changes that have already been made to the legislation appear in the content and are referenced with annotations. (See end of Document for details)

$M'_{rik,j}$	are the mass emissions of event k of compound i during regeneration (when $j > 1$, the first Type 1 test is run cold, and subsequent cycles are hot) measured at test cycle j where $1 \leq j \leq d_k$, g/km;
n_k	are the number of complete test cycles of event k , between two cycles where regenerative phases occur, during which emissions measurements (Type 1 WLTCs or equivalent engine test bench cycles) are made, ≥ 2 ;
d_k	is the number of complete applicable test cycles of event k required for complete regeneration;
D_k	is the number of complete applicable test cycles of event k between two cycles where regenerative phases occur;
x	is the number of complete regeneration events.

The calculation of M_{pi} is shown graphically in Figure A6.App1/2.

Figure A6.App1/2

Parameters measured during emissions test during and between cycles where regeneration occurs (schematic example)

<p>Annex I</p> <p>to</p> <p>Manufacturer's Certificate on Access to Vehicle OBD and Vehicle Repair and Maintenance Information</p> <p>Website addresses referred to by this Certificate:</p> <p>.....</p> <p>.....</p> <p>.....</p> <p>.....</p>
--

The calculation of K_i for multiple periodic regenerating systems is only possible after a certain number of regeneration events for each system.

After performing the complete procedure (A to B, see Figure A6.App1/2), the original starting condition A should be reached again.

Status: Point in time view as at 01/06/2017.

Changes to legislation: There are outstanding changes not yet made to Commission Regulation (EU) 2017/1151. Any changes that have already been made to the legislation appear in the content and are referenced with annotations. (See end of Document for details)

Sub-Annex 6

Appendix 2

Test procedure for electric power supply system monitoring

1. General

In the case that NOVC-HEVs and OVC-HEVs are tested, Appendices 2 and 3 of Sub-Annex 8 shall apply.

This Appendix defines the specific provisions regarding the correction of test results for CO₂ mass emission as a function of the energy balance ΔE_{REESS} for all REESSs.

The corrected values for CO₂ mass emission shall correspond to a zero energy balance ($\Delta E_{\text{REESS}} = 0$), and shall be calculated using a correction coefficient determined as defined below.

2. Measurement equipment and instrumentation

2.1. Current measurement

REESS depletion shall be defined as negative current.

2.1.1. The REESS current(s) shall be measured during the tests using a clamp-on or closed type current transducer. The current measurement system shall fulfil the requirements specified in Table A8/1. The current transducer(s) shall be capable of handling the peak currents at engine starts and temperature conditions at the point of measurement.

2.1.2. Current transducers shall be fitted to any of the REESS on one of the cables connected directly to the REESS and shall include the total REESS current.

In case of shielded wires, appropriate methods shall be applied in accordance with the approval authority.

In order to easily measure REESS current using external measuring equipment, manufacturers should preferably integrate appropriate, safe and accessible connection points in the vehicle. If this is not feasible, the manufacturer shall support the approval authority by providing the means to connect a current transducer to the REESS cables in the manner described above.

2.1.3. The measured current shall be integrated over time at a minimum frequency of 20 Hz, yielding the measured value of Q, expressed in ampere-hours Ah. The measured current shall be integrated over time, yielding the measured value of Q, expressed in ampere-hours Ah. The integration may be done in the current measurement system.

2.2. Vehicle on-board data

2.2.1. Alternatively, the REESS current shall be determined using vehicle-based data. In order to use this measurement method, the following information shall be accessible from the test vehicle:

- (a) Integrated charging balance value since last ignition run in Ah;
- (b) Integrated on-board data charging balance value calculated at a minimum sample frequency of 5 Hz;
- (c) The charging balance value via an OBD connector as described in SAE J1962.

2.2.2. The accuracy of the vehicle on-board REESS charging and discharging data shall be demonstrated by the manufacturer to the approval authority.

Status: Point in time view as at 01/06/2017.

Changes to legislation: There are outstanding changes not yet made to Commission Regulation (EU) 2017/1151. Any changes that have already been made to the legislation appear in the content and are referenced with annotations. (See end of Document for details)

The manufacturer may create a REESS monitoring vehicle family to prove that the vehicle on-board REESS charging and discharging data are correct. The accuracy of the data shall be demonstrated on a representative vehicle.

The following family criteria shall be valid:

- (a) Identical combustion processes (i.e. positive ignition, compression→ignition, two-stroke, four-stroke);
 - (b) Identical charge and/or recuperation strategy (software REESS data module);
 - (c) On-board data availability;
 - (d) Identical charging balance measured by REESS data module;
 - (e) Identical on-board charging balance simulation.
3. REESS energy change-based correction procedure
 - 3.1. Measurement of the REESS current shall start at the same time as the test starts and shall end immediately after the vehicle has driven the complete driving cycle.
 - 3.2. The electricity balance Q measured in the electric power supply system, shall be used as a measure of the difference in the REESS energy content at the end of the cycle compared to the beginning of the cycle. The electricity balance shall be determined for the total WLTC for the applicable vehicle class.
 - 3.3. Separate values of Q_{phase} shall be logged over the cycle phases required to be driven for the applicable vehicle class.
 - 3.4. Correction of CO₂ mass emission over the whole cycle as a function of the correction criterion c.
 - 3.4.1. Calculation of the correction criterion c

The correction criterion c is the ratio between the absolute value of the electric energy change $\Delta E_{\text{REESS},j}$ and the fuel energy and shall be calculated using the following equations:

$$c = \left| \frac{\Delta E_{\text{REESS},j}}{E_{\text{fuel}}} \right|$$

where:

c is the correction criterion;
 $\Delta E_{\text{REESS},j}$ is the electric energy change of all REESSs over period j determined according to paragraph 4.1. of this Appendix, Wh;
j is, in this paragraph, the whole applicable WLTP test cycle;
 E_{fuel} is the fuel energy according to the following equation:
$$E_{\text{fuel}} = 10 \times \text{HV} \times \text{FC}_{\text{nb}} \times d$$

where:

E_{fuel} is the energy content of the consumed fuel over the applicable WLTP test cycle, Wh;
HV is the heating value according to Table A6.App2/1, kWh/l;
 FC_{nb} is the non-balanced fuel consumption of the Type 1 test, not corrected for the energy balance, determined according to paragraph 6. of Sub-Annex 7, l/100 km;
d is the distance driven over the corresponding applicable WLTP test cycle, km;

Status: Point in time view as at 01/06/2017.

Changes to legislation: There are outstanding changes not yet made to Commission Regulation (EU) 2017/1151. Any changes that have already been made to the legislation appear in the content and are referenced with annotations. (See end of Document for details)

- 10 conversion factor to Wh.
- 3.4.2. The correction shall be applied if ΔE_{REESS} is negative (corresponding to REESS discharging) and the correction criterion c calculated according to paragraph 3.4.1. of this Sub-Annex is greater than the applicable tolerance according to Table A6.App2/2.
- 3.4.3. The correction shall be omitted and uncorrected values shall be used if the correction criterion c calculated according to paragraph 3.4.1. of this Sub-Annex is less than the applicable tolerance according to Table A6.App2/2.
- 3.4.4. The correction may be omitted and uncorrected values may be used if:
- (a) ΔE_{REESS} is positive (corresponding to REESS charging) and the correction criterion c calculated according to paragraph 3.4.1. of this Sub-Annex is greater than the applicable tolerance according to Table A6.App2/2;
- (b) the manufacturer can prove to the approval authority by measurement that there is no relation between ΔE_{REESS} and CO_2 mass emission and ΔE_{REESS} and fuel consumption respectively.

TABLE A6.APP2/1

Energy content of fuel

Fuel	Petrol		Diesel
Content Ethanol/ Biodiesel, per cent	E10	E85	B7
Heat value(kWh/l)	8,64	6,41	9,79

TABLE A6.APP2/2

RCB correction criteria

Cycle	low + medium	low + medium + high	low + medium + high + extra high
Correction criterion c	0,015	0,01	0,005

4. Applying the correction function
- 4.1. To apply the correction function, the electric energy change $\Delta E_{\text{REESS},j}$ of a period j of all REESSs shall be calculated from the measured current and the nominal voltage:

$$\Delta E_{\text{REESS},j} = \sum_{i=1}^n \Delta E_{\text{REESS},j,i}$$

where:

$\Delta E_{\text{REESS},j,i}$ is the electric energy change of REESS i during the considered period j , Wh;

and:

$$\Delta E_{\text{REESS},j,i} = \frac{1}{3600} \times U_{\text{REESS}} \times \int_{t_0}^{t_{\text{end}}} I(t)_{j,i} dt$$

where:

Status: Point in time view as at 01/06/2017.

Changes to legislation: There are outstanding changes not yet made to Commission Regulation (EU) 2017/1151. Any changes that have already been made to the legislation appear in the content and are referenced with annotations. (See end of Document for details)

U_{REESS}	is the nominal REESS voltage determined according to DIN EN 60050-482, V;
$I(t)_{j,i}$	is the electric current of REESS i during the considered period j determined according to paragraph 2. of this Appendix, A;
t_0	is the time at the beginning of the considered period j , s;
t_{end}	is the time at the end of the considered period j , s.
i	is the index number of the considered REESS;
n	is the total amount of REESS;
j	is the index number for the considered period, where a period shall be any applicable cycle phase, combination of cycle phases and the applicable total cycle;
$\frac{1}{3600}$	is the conversion factor from Wh to MJ.

4.2. For correction of CO₂ mass emission, g/km, combustion process-specific Willans factors from Table A6.App2/3 shall be used.

4.3. The correction shall be performed and applied for the total cycle and for each of its cycle phases separately, and shall be included in all relevant test reports.

4.4. For this specific calculation, a fixed electric power supply system alternator efficiency shall be used:

$\eta_{\text{alternator}} = 0,67$ for electric power supply system REESS alternators

4.5. The resulting CO₂ mass emission difference for the considered period j due to load behaviour of the alternator for charging a REESS shall be calculated using the following equation:

$$\Delta M_{\text{CO}_2,j} = 0,0036 \times \Delta E_{\text{REESS},j} \times \frac{1}{\eta_{\text{alternator}}} \times \text{Willans}_{\text{factor}} \times \frac{1}{d_j}$$

where:

$\Delta M_{\text{CO}_2,j}$	is the resulting CO ₂ mass emission difference of period j , g/km;
$\Delta E_{\text{REESS},j}$	is the REESS energy change of the considered period j calculated according to paragraph 4.1. of this Appendix, Wh;
d_j	is the driven distance of the considered period j , km;
j	is the index number for the considered period, where a period shall be any applicable cycle phase, combination of cycle phases and the applicable total cycle;
0,0036	is the conversion factor from Wh to MJ;
$\eta_{\text{alternator}}$	is the efficiency of the alternator according to paragraph 4.4. of this Appendix;
$\text{Willans}_{\text{factor}}$	is the combustion process specific Willans factor as defined in Table A6.App2/3, gCO ₂ /MJ;

4.5.1. The CO₂ values of each phase and the total cycle shall be corrected as follows:

$$M_{\text{CO}_2,p,3} = M_{\text{CO}_2,p,1} - \Delta M_{\text{CO}_2,j}$$

$$M_{\text{CO}_2,c,3} = M_{\text{CO}_2,c,2} - \Delta M_{\text{CO}_2,j}$$

where:

$\Delta M_{\text{CO}_2,j}$ is the result from paragraph 4.5. of this Sub-Annex for a period j , g/km.

4.6. For the correction of CO₂ emission, g/km, the Willans factors in Table A6.App2/2 shall be used.

Status: Point in time view as at 01/06/2017.

Changes to legislation: There are outstanding changes not yet made to Commission Regulation (EU) 2017/1151. Any changes that have already been made to the legislation appear in the content and are referenced with annotations. (See end of Document for details)

Table A6.App2/3

Willans factors

			Naturally aspirated	Pressure-charged
Positive ignition	Petrol (E10)	l/MJ	0,0756	0,0803
		gCO ₂ /MJ	174	184
	CNG (G20)	m ³ /MJ	0,0719	0,0764
		gCO ₂ /MJ	129	137
	LPG	l/MJ	0,0950	0,101
		gCO ₂ /MJ	155	164
	E85	l/MJ	0,102	0,108
		gCO ₂ /MJ	169	179
Compression ignition	Diesel (B7)	l/MJ	0,0611	0,0611
		gCO ₂ /MJ	161	161

Sub-Annex 6a

Ambient Temperature Correction Test for the determination of CO₂ emissions under representative regional temperature conditions

1. Introduction

This Sub-Annex describes the supplemental Ambient Temperature Correction Test (ATCT) procedure to determine the CO₂ emissions under representative regional temperature conditions.

- 1.1. The CO₂ emissions of ICE vehicles, NOVC-HEVs and the charge sustaining value of OVC-HEVs shall be corrected according to the requirements of this Sub14-Annex. No correction is required for the CO₂ value of the charge depleting test. No correction is required for an Electric Range.
2. Ambient Temperature Correction Test (ATCT) Family
 - 2.1. Only vehicles which are identical with respect to all the following characteristics are permitted to be part of the same ATCT Family:
 - (a) Powertrain architecture (i.e. internal combustion, hybrid, fuel cell, or electric);
 - (b) Combustion process (i.e. two stroke or four stroke);
 - (c) Number and arrangement of cylinders;
 - (d) Method of engine combustion (i.e. indirect or direct injection);
 - (e) Type of cooling system (i.e. air, water, or oil);
 - (f) Method of aspiration (i.e. naturally aspirated, or charged);

Status: Point in time view as at 01/06/2017.

Changes to legislation: There are outstanding changes not yet made to Commission Regulation (EU) 2017/1151. Any changes that have already been made to the legislation appear in the content and are referenced with annotations. (See end of Document for details)

- (g) Fuel for which the engine is designed (i.e. petrol, diesel, NG, LPG, etc.);
- (h) Catalytic converter (i.e. three-way catalyst, lean NO_x trap, SCR, lean NO_x catalyst or other(s));
- (i) Whether or not a particulate trap is installed; and
- (j) Exhaust gas recirculation (with or without, cooled or non-cooled).

In addition the vehicles shall be similar with respect to the following characteristics:

- (k) The vehicles shall have a variation in engine cylinder capacity of no more than 30 % of the vehicle with the lowest capacity; and
 - (l) Engine compartment insulation shall be of a similar type regarding material, amount and location of the insulation. Manufacturers shall provide evidence (e.g. by CAD drawings) to the approval authority that the volume and weight of the installed insulation material is within a tolerance of 10 % to the ATCT measured reference vehicle.
- 2.1.1. If active heat storage devices are installed, only vehicles that meet the following requirements shall be considered to be part of the same ATCT Family:
- (i) the heat capacity, defined by the enthalpy stored in the system, is within a range of 0 to 10 % above the enthalpy of the test vehicle; and
 - (ii) the OEM can provide evidence to the technical service that the time for heat release at engine start within a family is within a range of 0 to 10 % below the time for the heat release of the test vehicle.

2.1.2. Only vehicles that meet the criteria according to paragraph 3.9.4. of this Sub-Annex shall be considered to be part of the same ATCT Family.

3. ATCT Procedure

The Type 1 test specified in Sub-Annex 6 shall be carried out with the exception of the requirements specified in paragraphs 3.1. to 3.9. inclusive of this ATCT Sub-Annex 6a.

3.1. Ambient conditions for ATCT

3.1.1. The temperature (T_{reg}) at which the vehicle should be soaked and tested for the ATCT shall be 14 °C.

3.1.2. The minimum soaking time (t_{soak_ATCT}) for the ATCT shall be 9 hours.

3.2. Test cell and soak area

3.2.1. Test cell

3.2.1.1. The test cell shall have a temperature set point equal to T_{reg} . The actual temperature value shall be within ± 3 °C at the start of the test and within ± 5 °C during the test. The air temperature and humidity shall be measured at the cooling fan outlet at a minimum frequency of 1 Hz.

3.2.1.2. The specific humidity (H) of either the air in the test cell or the intake air of the engine shall be such that:

$$3,0 \leq H \leq 8,1(\text{g H}_2\text{O} / \text{kg dry air})$$

Status: Point in time view as at 01/06/2017.

Changes to legislation: There are outstanding changes not yet made to Commission Regulation (EU) 2017/1151. Any changes that have already been made to the legislation appear in the content and are referenced with annotations. (See end of Document for details)

3.2.1.3. The air temperature and humidity shall be measured at the outlet of the vehicle cooling fan at a rate of 1 Hz.

3.2.2. Soak area

3.2.2.1. The soak area shall have a temperature set point equal to T_{reg} and the actual temperature value shall be within ± 3 °C on a 5 minute running arithmetic average and shall not show a systematic deviation from the set point. The temperature shall be measured continuously at a minimum frequency of 1 Hz.

3.2.2.2. The location of the temperature sensor for the soak area shall be representative to measure the ambient temperature around the vehicle and shall be checked by the technical service.

The sensor shall be at least 10 cm away from the wall of the soak area and shall be shielded against direct air flow.

The air-flow conditions within the soak room in the vicinity of the vehicle shall represent a natural convection flow representative for the dimension of the room (no forced convection).

3.3. Test vehicle

3.3.1. The vehicle to be tested shall be representative for the family for which the ATCT data are determined (as described in paragraph 2.3. of this Sub-Annex).

3.3.2. From the ATCT Family, the Interpolation Family with the lowest engine capacity shall be selected (see paragraph 2 of this Sub-Annex), and the test vehicle shall be in the 'vehicle H' configuration of this family.

3.3.3. Where applicable, the vehicle with the lowest enthalpy of the active heat storage device and the slowest heat release for the active heat storage device from the ATCT Family shall be selected.

3.3.4. The test vehicle shall meet the requirements detailed in paragraph 1.2.3. of Sub-Annex 6.

3.4. Settings

3.4.1. Road load and dynamometer settings shall be as specified in Sub-Annex 4.

To take account of the difference in air density at 14 °C when compared to the air density at 20 °C, the chassis dynamometer shall be set as specified in paragraphs 7. and 8. of Sub-Annex 4 with the exception that f_{2_TReg} from the following equation shall be used as the target coefficient C_t .

$$f_{2_TReg} = f_2 \times (T_{ref} + 273) / (T_{reg} + 273)$$

where:

f_2 is the second order road load coefficient, at reference conditions, N/(km/h)²;

T_{ref} is the road load reference temperature as specified in paragraph 3.2.10. of this Annex, C;

T_{reg} is the regional temperature, as defined in paragraph 3.1.1., C.

In the case that a valid chassis dynamometer setting of the 23 °C test is available, the second order chassis dynamometer coefficient of, C_d , shall be adapted according to the following equation:

Status: Point in time view as at 01/06/2017.

Changes to legislation: There are outstanding changes not yet made to Commission Regulation (EU) 2017/1151. Any changes that have already been made to the legislation appear in the content and are referenced with annotations. (See end of Document for details)

$$C_{d,Trag} = C_d + (f_{2,Trag} - f_2)$$

3.5. Preconditioning

3.5.1. The vehicle shall be preconditioned as described in paragraph 1.2.6. of Sub-Annex 6. At the request of the manufacturer preconditioning may be undertaken at T_{reg} .

3.6. Soak procedure

3.6.1. After preconditioning and before testing, vehicles shall be kept in a soak area with the ambient conditions described in paragraph 3.2.2. of this Sub-Annex.

3.6.2. The transfer from the preconditioning to the soak area shall be undertaken as quickly as possible, within a maximum of 10 minutes.

3.6.3. The vehicle shall then be kept in the soak area such that the time from the end of the preconditioning test to the beginning of the ATCT test is equal to t_{soak_ATCT} with a tolerance of an additional 15 minutes. At the request of the manufacturer, and upon approval of the approval authority, t_{soak_ATCT} can be extended by up to 120 minutes. In this case, the extended time shall be used for the cool down specified in paragraph 3.9. of this Sub-Annex.

3.6.4. The soak shall be performed without using a cooling fan and with all body parts positioned as intended under normal parking operation. The time between the end of the preconditioning and the start of the ATCT test shall be recorded.

3.6.5. The transfer from the soak area to the test cell shall be undertaken as quickly as possible. The vehicle shall not be exposed to a temperature different from T_{reg} for longer than 10 minutes.

3.6.6. In the case that this test vehicle serves as the reference vehicle for an ATCT Family, an additional soak at 23 °C, as specified in paragraph 3.9., shall be undertaken.

3.7. ATCT Test

3.7.1. The test cycle shall be the applicable WLTC specified in Sub-Annex 1 for that class of vehicle.

3.7.2. The procedures for undertaking the emissions test as specified in Sub-Annex 6 shall be followed, with the exception that the ambient conditions for the test cell shall be those as described in paragraph 3.2.1. of this Sub-Annex.

3.8. Calculation and Documentation

3.8.1. The family correction factor, FCF , shall be calculated as follows:

$$FCF = M_{CO_2,Trag} / M_{CO_2,23^\circ}$$

where

$M_{CO_2,23^\circ}$ are the CO₂ mass emission over the complete WLTC cycle of the Type 1 test at 23 °C of vehicle H, after Step 3 of Table A7/1 of Sub-Annex 7, but without any further corrections, g/km;

$M_{CO_2,Trag}$ are the CO₂ mass emission over the complete WLTC cycle of the test at regional temperature after Step 3 of Table A7/1 of Sub-Annex 7, but without any further corrections, g/km.

The FCF shall be included in all relevant test reports.

Status: Point in time view as at 01/06/2017.

Changes to legislation: There are outstanding changes not yet made to Commission Regulation (EU) 2017/1151. Any changes that have already been made to the legislation appear in the content and are referenced with annotations. (See end of Document for details)

3.8.2. The CO₂ values for each vehicle within the ATCT Family (as defined in paragraph 3 of this Sub-Annex) shall be calculated using the following equations:

$$M_{CO_2,c,5} = M_{CO_2,c,4} \times FCF$$

$$M_{CO_2,p,5} = M_{CO_2,p,4} \times FCF$$

where:

$M_{CO_2,c,4}$ and $M_{CO_2,p,4}$ are the CO₂ mass emissions over the complete WLTC, c, and the cycle phases, p, resulting from the previous calculation step, g/km;

$M_{CO_2,c,5}$ and $M_{CO_2,p,5}$ are the CO₂ mass emissions over the complete WLTC, c, and the cycle phases, p, including the ATCT correction, and shall be used for any further corrections or any further calculations, g/km;

3.9. Provision for cool down

3.9.1. For the test vehicle serving as a reference vehicle for the ATCT Family and all vehicles H of the interpolation families within the ATCT Family, the end temperature of the engine coolant shall be measured after driving the respective Type 1 test at 23 °C and after soaking at 23 °C for the duration of t_{soak_ATCT} , with a tolerance of an additional 15 minutes.

3.9.1.1. In the case that t_{soak_ATCT} was extended in the respective ATCT test, the same soaking time shall be used, with a tolerance of an additional 15 minutes.

3.9.2. The cool down procedure shall be undertaken as soon as possible after the end of the Type 1 test, with a maximum delay of 10 minutes. The measured soaking time is the time between the measurement of the end temperature and the end of the Type 1 test at 23 °C, and shall be included in all relevant test sheets.

3.9.3. The average soak area temperature of the last 3 hours of the soak process has to be subtracted from the measured end temperature of the engine coolant at the end of the soaking time specified in paragraph 3.9.1. This is referred to as Δ_T_ATCT .

3.9.4. Unless the resulting Δ_T_ATCT is within the range of – 2 °C to + 4 °C from the reference vehicle, this Interpolation Family shall not be considered to be a member of the same ATCT Family.

3.9.5. For all vehicles within an ATCT Family the coolant shall be measured at the same location in the cooling system. That location shall be as close as possible to the engine so that the coolant temperature is as representative as possible to the engine temperature.

3.9.6. The measurement of the temperature of the soak areas shall be as specified in paragraph 3.2.2.2. of this Sub-Annex.

Sub-Annex 7

Calculations

1. General requirements

1.1. Calculations related specifically to hybrid, pure electric and compressed hydrogen fuel cell vehicles are described in Sub-Annex 8.

Status: Point in time view as at 01/06/2017.

Changes to legislation: There are outstanding changes not yet made to Commission Regulation (EU) 2017/1151. Any changes that have already been made to the legislation appear in the content and are referenced with annotations. (See end of Document for details)

A stepwise prescription of result calculations is described in paragraph 4. of Sub-Annex 8.

- 1.2. The calculations described in this Sub-Annex shall be used for vehicles using combustion engines.
- 1.3. Rounding of test results
 - 1.3.1. Intermediate steps in the calculations shall not be rounded.
 - 1.3.2. The final criteria emission results shall be rounded in one step to the number of places to the right of the decimal point indicated by the applicable emission standard plus one additional significant figure.
 - 1.3.3. The NO_x correction factor, KH, shall be rounded to two decimal places.
 - 1.3.4. The dilution factor, DF, shall be rounded to two decimal places.
 - 1.3.5. For information not related to standards, good engineering judgement shall be used.
 - 1.3.6. Rounding of CO₂ and fuel consumption results is described in paragraph 1.4. of this Sub-Annex.
- 1.4. Stepwise prescription for calculating the final test results for vehicles using combustion engines

The results shall be calculated in the order described in Table A7/1. All applicable results in the column 'Output' shall be recorded. The column 'Process' describes the paragraphs to be used for calculation or contains additional calculations.

For the purpose of this table, the following nomenclature within the equations and results is used:

- c complete applicable cycle;
- p every applicable cycle phase;
- i every applicable criteria emission component, without CO₂;
- CO₂ CO₂ emission.

TABLE A7/1

Procedure for calculating final test results

Source	Input	Process	Output	Step no.
Annex 6	Raw test results	Mass emissions Sub-Annex 7, paragraphs 3. to 3.2.2. inclusive	M _{i,p,1} , g/km; M _{CO₂,p,1} , g/km.	1
Output step 1	M _{i,p,1} , g/km; M _{CO₂,p,1} , g/km.	Calculation of combined cycle values: $M_{i,c,2} = \frac{\sum_p M_{i,p,1} \times d_p}{\sum_p d_p}$ $M_{CO_2,c,2} = \frac{\sum_p M_{CO_2,p,1} \times d_p}{\sum_p d_p}$ where: M _{i/} CO _{2,c,2} are the	M _{i,c,2} , g/km; M _{CO₂,c,2} , g/km.	2

Status: Point in time view as at 01/06/2017.

Changes to legislation: There are outstanding changes not yet made to Commission Regulation (EU) 2017/1151. Any changes that have already been made to the legislation appear in the content and are referenced with annotations. (See end of Document for details)

		emission results over the total cycle; d_p are the driven distances of the cycle phases, p .		
Output step 1 and 2	$M_{CO_2,p,1}$, g/km; $M_{CO_2,c,2}$, g/km.	RCB correction Sub-Annex 6, Appendix 2	$M_{CO_2,p,3}$, g/km; $M_{CO_2,c,3}$, g/km.	3
Output step 2 and 3	$M_{i,c,2}$, g/km; $M_{CO_2,c,3}$, g/km.	Emissions test procedure for all vehicles equipped with periodically regenerating systems, K_i . Sub-Annex 6, Appendix 1. $M_{i,c,4} = K_i \times M_{i,c,2}$ or $M_{i,c,4} = K_i \times M_{i,c,2}$ and $M_{CO_2,c,4} = K_{CO_2} \times M_{CO_2,c,3}$ or $M_{CO_2,c,4} = K_{CO_2} \times M_{CO_2,c,3}$ Additive offset or multiplicative factor to be used according to K_i determination. If K_i is not applicable: $M_{i,c,4} = M_{i,c,2}$ $M_{CO_2,c,4} = M_{CO_2,c,3}$	$M_{i,c,4}$, g/km; $M_{CO_2,c,4}$, g/km.	4a
Output step 3 and 4a	$M_{CO_2,p,3}$, g/km; $M_{CO_2,c,3}$, g/km; $M_{CO_2,c,4}$, g/km.	If K_i is applicable, align CO_2 phase values to the combined cycle value: $M_{CO_2,p,4} = M_{CO_2,p,3} \times AF_{K_i}$	$M_{CO_2,p,4}$, g/km.	4b

Status: Point in time view as at 01/06/2017.

Changes to legislation: There are outstanding changes not yet made to Commission Regulation (EU) 2017/1151. Any changes that have already been made to the legislation appear in the content and are referenced with annotations. (See end of Document for details)

		for every cycle phase p; where: $AF_{K_i} = \frac{M_{CO_2,c,4}}{M_{CO_2,c,3}}$ If K_i is not applicable: $M_{CO_2,p,4} = M_{CO_2,p,3}$		
Output step 4	$M_{i,c,4}$, g/km; $M_{CO_2,c,4}$, g/km; $M_{CO_2,p,4}$, g/km.	ATCT correction according to paragraph 3.8.2. of Sub-Annex 6a. Deterioration factors calculated according to Annex VII and applied to the criteria emissions values.	$M_{i,c,5}$, g/km; $M_{CO_2,c,5}$, g/km; $M_{CO_2,p,5}$, g/km.	5 'result of a single test'
Output step 5	For every test: $M_{i,c,5}$, g/km; $M_{CO_2,c,5}$, g/km; $M_{CO_2,p,5}$, g/km.	Averaging of tests and declared value. Sub-Annex 6, paragraphs 1.1.2. to 1.1.2.3. inclusive	$M_{i,c,6}$, g/km; $M_{CO_2,c,6}$, g/km; $M_{CO_2,p,6}$, g/km. $M_{CO_2,c,declared}$, g/km.	6
Output step 6	$M_{CO_2,c,6}$, g/km; $M_{CO_2,p,6}$, g/km. $M_{CO_2,c,declared}$, g/km.	Alignment of phase values. Sub-Annex 6, paragraph 1.1.2.4. and: $M_{CO_2,c,7} = M_{CO_2,c,declared}$	$M_{CO_2,c,7}$, g/km; $M_{CO_2,p,7}$, g/km.	7
Output steps 6 and 7	$M_{i,c,6}$, g/km; $M_{CO_2,c,7}$, g/km; $M_{CO_2,p,7}$, g/km.	Calculation of fuel consumption. Sub-Annex 7, paragraph 6. The calculation of fuel consumption shall be performed for the applicable cycle and its phases separately. For that purpose:	$FC_{c,8}$, l/100 km; $FC_{p,8}$, l/100 km; $M_{i,c,8}$, g/km; $M_{CO_2,c,8}$, g/km; $M_{CO_2,p,8}$, g/km.	8 'result of a Type 1 test for a test vehicle'

Status: Point in time view as at 01/06/2017.

Changes to legislation: There are outstanding changes not yet made to Commission Regulation (EU) 2017/1151. Any changes that have already been made to the legislation appear in the content and are referenced with annotations. (See end of Document for details)

		<p>(a) the applicable phase or cycle CO₂ values shall be used;</p> <p>(b) the criteria emission over the complete cycle shall be used.</p> <p>and: $M_{i,c,8} = M_{i,c,6}$ $M_{CO_2,c,8} = M_{CO_2,c,7}$ $M_{CO_2,p,8} = M_{CO_2,p,7}$</p>		
Step 8	<p>For each of the test vehicles H and L: $M_{i,c,8}$, g/km; $M_{CO_2,c,8}$, g/km; $M_{CO_2,p,8}$, g/km; $FC_{c,8}$, l/100 km; $FC_{p,8}$, l/100 km.</p>	<p>If a test vehicle L was tested in addition to a test vehicle H, the resulting criteria emission value shall be the highest of the two values and referred to as $M_{i,c}$.</p> <p>In the case of the combined THC+NO_x emissions, the highest value of the sum referring to either the VH or VL is to be used.</p> <p>Otherwise, if no vehicle L was tested, $M_{i,c} = M_{i,c,8}$</p> <p>For CO₂ and FC, the values derived in step 8 shall be used, and CO₂ values</p>	$M_{i,c}$, g/km; $M_{CO_2,c,H}$, g/km; $M_{CO_2,p,H}$, g/km; $FC_{c,H}$, l/100 km; $FC_{p,H}$, l/100 km; and if a vehicle L was tested: $M_{CO_2,c,L}$, g/km; $M_{CO_2,p,L}$, g/km; $FC_{c,L}$, l/100 km; $FC_{p,L}$, l/100 km.	9 ‘interpolation family result’ Final criteria emission result

Status: Point in time view as at 01/06/2017.

Changes to legislation: There are outstanding changes not yet made to Commission Regulation (EU) 2017/1151. Any changes that have already been made to the legislation appear in the content and are referenced with annotations. (See end of Document for details)

		shall be rounded to two decimal places, and FC values shall be rounded to three decimal places.		
Step 9	$M_{CO_2,c,H}$, g/km; $M_{CO_2,p,H}$, g/km; $FC_{c,H}$, 1/100 km; $FC_{p,H}$, 1/100 km; and if a vehicle L was tested: $M_{CO_2,c,L}$, g/km; $M_{CO_2,p,L}$, g/km; $FC_{c,L}$, 1/100 km; $FC_{p,L}$, 1/100 km.	Fuel consumption and CO ₂ calculations for individual vehicles in an CO ₂ interpolation family. Sub-Annex 7, paragraph 3.2.3. CO ₂ emissions must be expressed in grams per kilometre (g/km) rounded to the nearest whole number; FC values shall be rounded to one decimal place, expressed in (1/100 km).	$M_{CO_2,c,ind}$ g/km; $M_{CO_2,p,ind}$, g/km; $FC_{c,ind}$ 1/100 km; $FC_{p,ind}$, 1/100 km.	10 'result of an individual vehicle' Final CO ₂ and FC result

2. Determination of diluted exhaust gas volume
 - 2.1. Volume calculation for a variable dilution device capable of operating at a constant or variable flow rate
 - 2.1.1. The volumetric flow shall be measured continuously. The total volume shall be measured for the duration of the test.
 - 2.2. Volume calculation for a variable dilution device using a positive displacement pump
 - 2.2.1. The volume shall be calculated using the following equation:

$$V = V_0 \times N$$
 where:
 - V is the volume of the diluted gas, in litres per test (prior to correction);
 - V_0 is the volume of gas delivered by the positive displacement pump in testing conditions, litres per pump revolution;
 - N is the number of revolutions per test.
 - 2.2.1.1. Correcting the volume to standard conditions

The diluted exhaust gas volume, V, shall be corrected to standard conditions according to the following equation:

Status: Point in time view as at 01/06/2017.

Changes to legislation: There are outstanding changes not yet made to Commission Regulation (EU) 2017/1151. Any changes that have already been made to the legislation appear in the content and are referenced with annotations. (See end of Document for details)

$$V_{\text{mix}} = V \times K_1 \times \left(\frac{P_B - P_1}{T_p} \right)$$

where:

$$K_1 = \frac{273,15(\text{K})}{101,325(\text{kPa})} = 2,6961$$

- P_B is the test room barometric pressure, kPa;
 P_1 is the vacuum at the inlet of the positive displacement pump relative to the ambient barometric pressure, kPa;
 T_p is the arithmetic average temperature of the diluted exhaust gas entering the positive displacement pump during the test, Kelvin (K).

3. Mass emissions

3.1. General requirements

3.1.1. Assuming no compressibility effects, all gases involved in the engine's intake, combustion and exhaust processes may be considered to be ideal according to Avogadro's hypothesis.

3.1.2. The mass, M of gaseous compounds emitted by the vehicle during the test shall be determined by the product of the volumetric concentration of the gas in question and the volume of the diluted exhaust gas with due regard for the following densities under the reference conditions of 273,15 K (0 °C) and 101,325 kPa:

Carbon monoxide (CO)	$\rho = 1,25 \text{ g/l}$
Carbon dioxide (CO ₂)	$\rho = 1,964 \text{ g/l}$

Hydrocarbons:

for petrol (E10) (C ₁ H _{1,93} O _{0,033})	$\rho = 0,646 \text{ g/l}$
for diesel (B7) (C ₁ H _{1,86} O _{0,007})	$\rho = 0,625 \text{ g/l}$
for LPG (C ₁ H _{2,525})	$\rho = 0,649 \text{ g/l}$
for NG/ biomethane (CH ₄)	$\rho = 0,716 \text{ g/l}$
for ethanol (E85) (C ₁ H _{2,74} O _{0,385})	$\rho = 0,934 \text{ g/l}$
Nitrogen oxides (NO _x)	$\rho = 2,05 \text{ g/l}$

The density for NMHC mass calculations shall be equal to that of total hydrocarbons at 273,15 K (0 °C) and 101,325 kPa, and is fuel-dependent. The density for propane mass calculations (see paragraph 3.5. in Sub-Annex 5) is 1,967 g/l at standard conditions.

If a fuel type is not listed in this paragraph, the density of that fuel shall be calculated using the equation given in paragraph 3.1.3. of this Sub-Annex.

3.1.3. The general equation for the calculation of total hydrocarbon density for each reference fuel with an mean composition of C_xH_yO_z is as follows:

$$\rho_{\text{THC}} = \frac{MW_C + \frac{H}{C} \times MW_H + \frac{O}{C} \times MW_O}{V_M}$$

where:

Status: Point in time view as at 01/06/2017.

Changes to legislation: There are outstanding changes not yet made to Commission Regulation (EU) 2017/1151. Any changes that have already been made to the legislation appear in the content and are referenced with annotations. (See end of Document for details)

ρ_{THC}	is the density of total hydrocarbons and non-methane hydrocarbons, g/l;
MW_{C}	is the molar mass of carbon (12,011 g/mol);
MW_{H}	is the molar mass of hydrogen (1,008 g/mol);
MW_{O}	is the molar mass of oxygen (15,999 g/mol);
V_{M}	is the molar volume of an ideal gas at 273,15 K (0°C) and 101,325 kPa (22,413 l/mol);
H/C	is the hydrogen to carbon ratio for a specific fuel $C_XH_YO_Z$;
O/C	is the oxygen to carbon ratio for a specific fuel $C_XH_YO_Z$.

3.2. Mass emissions calculation

3.2.1. Mass emissions of gaseous compounds per cycle phase shall be calculated using the following equations:

$$M_{i,\text{phase}} = \frac{V_{\text{mix,phase}} \times \rho_i \times KH_{\text{phase}} \times C_{i,\text{phase}} \times 10^{-6}}{d_{\text{phase}}}$$

where:

M_i	is the mass emission of compound i per test or phase, g/km;
V_{mix}	is the volume of the diluted exhaust gas per test or phase expressed in litres per test/phase and corrected to standard conditions (273,15 K (0 °C) and 101,325 kPa);
ρ_i	is the density of compound i in grams per litre at standard temperature and pressure (273,15 K (0 °C) and 101,325 kPa);
KH	is a humidity correction factor applicable only to the mass emissions of oxides of nitrogen, NO_2 and NO_x , per test or phase;
C_i	is the concentration of compound i per test or phase in the diluted exhaust gas expressed in ppm and corrected by the amount of compound i contained in the dilution air;
d	is the distance driven over the applicable WLTC, km;
n	is the number of phases of the applicable WLTC.

3.2.1.1. The concentration of a gaseous compound in the diluted exhaust gas shall be corrected by the amount of the gaseous compound in the dilution air using the following equation:

$$C_i = C_e - C_d \times \left(1 - \frac{1}{DF}\right)$$

where:

C_i	is the concentration of gaseous compound i in the diluted exhaust gas corrected by the amount of gaseous compound i contained in the dilution air, ppm;
C_e	is the measured concentration of gaseous compound i in the diluted exhaust gas, ppm;
C_d	is the concentration of gaseous compound i in the dilution air, ppm;
DF	is the dilution factor.

3.2.1.1.1. The dilution factor DF shall be calculated using the equation for the concerned fuel:

$DF = \frac{13.4}{C_{\text{CO}_2} + (C_{\text{HC}} + C_{\text{CO}}) \times 10^{-4}}$	for petrol (E10)
$DF = \frac{13.5}{C_{\text{CO}_2} + (C_{\text{HC}} + C_{\text{CO}}) \times 10^{-4}}$	for diesel (B7)
$DF = \frac{11.9}{C_{\text{CO}_2} + (C_{\text{HC}} + C_{\text{CO}}) \times 10^{-4}}$	for LPG
$DF = \frac{9.5}{C_{\text{CO}_2} + (C_{\text{HC}} + C_{\text{CO}}) \times 10^{-4}}$	for NG/biomethane

Status: Point in time view as at 01/06/2017.

Changes to legislation: There are outstanding changes not yet made to Commission Regulation (EU) 2017/1151. Any changes that have already been made to the legislation appear in the content and are referenced with annotations. (See end of Document for details)

$$DF = \frac{12.5}{C_{CO_2} + (C_{HC} + C_{CO}) \times 10^{-4}} \quad \text{for ethanol (E85)}$$

$$DF = \frac{35.03}{C_{H_2O} - C_{H_2O-DA} + C_{H_2} \times 10^{-4}} \quad \text{for hydrogen}$$

With respect to the equation for hydrogen:

C_{H_2O} is the concentration of H_2O in the diluted exhaust gas contained in the sample bag, per cent volume;

C_{H_2O-DA} is the concentration of H_2O in the dilution air, per cent volume;

C_{H_2} is the concentration of H_2 in the diluted exhaust gas contained in the sample bag, ppm.

If a fuel type is not listed in this paragraph, the DF for that fuel shall be calculated using the equations in paragraph 3.2.1.1.2. of this Sub-Annex.

If the manufacturer uses a DF that covers several phases, it shall calculate a DF using the mean concentration of gaseous compounds for the phases concerned.

The mean concentration of a gaseous compound shall be calculated using the following equation:

$$\bar{C}_i = \frac{\sum_{n=1}^{\text{phase}} (C_{i,\text{phase}} \times V_{\text{mix,phase}})}{\sum_{n=1}^{\text{phase}} V_{\text{mix,phase}}}$$

where:

C_i is mean concentration of a gaseous compound;

$C_{i,\text{phase}}$ is the concentration of each phase;

$V_{\text{mix,phase}}$ is the V_{mix} of the corresponding phase;

3.2.1.1.2. The general equation for calculating the dilution factor DF for each reference fuel with an arithmetic average composition of $C_xH_yO_z$ is as follows:

$$DF = \frac{X}{C_{CO_2} + (C_{HC} + C_{CO}) \times 10^{-4}}$$

where:

$$X = 100 \times \frac{z}{z + \frac{y}{2} + 3,76 \left(z + \frac{y}{4} - \frac{z}{2} \right)}$$

C_{CO_2} is the concentration of CO_2 in the diluted exhaust gas contained in the sample bag, per cent volume;

C_{HC} is the concentration of HC in the diluted exhaust gas contained in the sample bag, ppm carbon equivalent;

C_{CO} is the concentration of CO in the diluted exhaust gas contained in the sample bag, ppm.

3.2.1.1.3. Methane measurement

3.2.1.1.3. For methane measurement using a GC-FID, NMHC shall be calculated using the following equation:

$$C_{NMHC} = C_{THC} - (Rf_{CH_4} \times C_{CH_4})$$

where:

C_{NMHC} is the corrected concentration of NMHC in the diluted exhaust gas, ppm carbon equivalent;

C_{THC} is the concentration of THC in the diluted exhaust gas, ppm carbon equivalent and corrected by the amount of THC contained in the dilution air;

Status: Point in time view as at 01/06/2017.

Changes to legislation: There are outstanding changes not yet made to Commission Regulation (EU) 2017/1151. Any changes that have already been made to the legislation appear in the content and are referenced with annotations. (See end of Document for details)

C_{CH_4}	is the concentration of C_{CH_4} in the diluted exhaust gas, ppm carbon equivalent and corrected by the amount of CH_4 contained in the dilution air;
Rf_{CH_4}	is the FID response factor to methane as defined in paragraph 5.4.3.2. of Sub-Annex 5.

3.2.1.1.3. For methane measurement using an NMC-FID, the calculation of NMHC depends on the calibration gas/method used for the zero/calibration adjustment.

The FID used for the THC measurement (without NMC) shall be calibrated with propane/air in the normal manner.

For the calibration of the FID in series with an NMC, the following methods are permitted:

- The calibration gas consisting of propane/air bypasses the NMC;
- The calibration gas consisting of methane/air passes through the NMC.

It is highly recommended to calibrate the methane FID with methane/air through the NMC.

In case (a), the concentration of CH_4 and NMHC shall be calculated using the following equations:

$$C_{CH_4} = \frac{C_{HC(w/NMC)} - C_{HC(w/oNMC)} \times (1 - E_E)}{r_h \times (E_E - E_M)}$$

$$C_{NMHC} = \frac{C_{HC(w/oNMC)} \times (1 - E_M) - C_{HC(w/NMC)}}{E_E - E_M}$$

If $r_h < 1,05$, it may be omitted from the equation above for C_{CH_4} .

In case (b), the concentration of CH_4 and NMHC shall be calculated using the following equations:

$$C_{CH_4} = \frac{C_{HC(w/NMC)} \times r_h \times (1 - E_M) - C_{HC(w/oNMC)} \times (1 - E_E)}{r_h \times (E_E - E_M)}$$

$$C_{NMHC} = \frac{C_{HC(w/oNMC)} \times (1 - E_M) - C_{HC(w/NMC)} \times r_h \times (1 - E_M)}{E_E - E_M}$$

where:

$C_{HC(w/NMC)}$	is the HC concentration with sample gas flowing through the NMC, ppm C;
$C_{HC(w/oNMC)}$	is the HC concentration with sample gas bypassing the NMC, ppm C;
r_h	is the methane response factor as determined per paragraph 5.4.3.2. of Sub-Annex 5;
E_M	is the methane efficiency as determined per paragraph 3.2.1.1.3.3.1. of this Sub-Annex;
E_E	is the ethane efficiency as determined per paragraph 3.2.1.1.3.3.2. of this Sub-Annex.

If $r_h < 1,05$, it may be omitted in the equations for case (b) above for C_{CH_4} and C_{NMHC} .

3.2.1.1.3. Conversion efficiencies of the non-methane cutter, NMC

The NMC is used for the removal of the non-methane hydrocarbons from the sample gas by oxidizing all hydrocarbons except methane. Ideally, the conversion for methane is 0 per cent, and for the other hydrocarbons represented by ethane is 100 per cent. For the accurate measurement of NMHC, the two efficiencies shall be determined and used for the calculation of the NMHC emission.

Status: Point in time view as at 01/06/2017.

Changes to legislation: There are outstanding changes not yet made to Commission Regulation (EU) 2017/1151. Any changes that have already been made to the legislation appear in the content and are referenced with annotations. (See end of Document for details)

3.2.1.1.3. Methane conversion efficiency, E_M

The methane/air calibration gas shall be flowed to the FID through the NMC and bypassing the NMC and the two concentrations recorded. The efficiency shall be determined using the following equation:

$$E_M = 1 - \frac{C_{HC(w/NMC)}}{C_{HC(w/oNMC)}}$$

where:

$C_{HC(w/NMC)}$ is the HC concentration with CH₄ flowing through the NMC, ppm C;
 $C_{HC(w/oNMC)}$ is the HC concentration with CH₄ bypassing the NMC, ppm C.

3.2.1.1.3. Ethane conversion efficiency, E_E

The ethane/air calibration gas shall be flowed to the FID through the NMC and bypassing the NMC and the two concentrations recorded. The efficiency shall be determined using the following equation:

$$E_E = 1 - \frac{C_{HC(w/NMC)}}{C_{HC(w/oNMC)}}$$

where:

$C_{HC(w/NMC)}$ is the HC concentration with C₂H₆ flowing through the NMC, ppm C;
 $C_{HC(w/oNMC)}$ is the HC concentration with C₂H₆ bypassing the NMC, ppm C.

If the ethane conversion efficiency of the NMC is 0,98 or above, E_E shall be set to 1 for any subsequent calculation.

3.2.1.1.3. If the methane FID is calibrated through the cutter, E_M shall be 0.

The equation to calculate C_{CH_4} in paragraph 3.2.1.1.3.2. (case (b)) in this Sub-Annex becomes:

$$C_{CH_4} = C_{HC(w/NMC)}$$

The equation to calculate C_{NMHC} in paragraph 3.2.1.1.3.2. (case (b)) in this Sub-Annex becomes:

$$C_{NMHC} = C_{HC(w/oNMC)} - C_{HC(w/NMC)} \times r_h$$

The density used for NMHC mass calculations shall be equal to that of total hydrocarbons at 273,15 K (0 °C) and 101,325 kPa and is fuel-dependent.

3.2.1.1.4. Flow-weighted arithmetic average concentration calculation

The following calculation method shall only be applied for CVS systems that are not equipped with a heat exchanger or for CVS systems with a heat exchanger that do not comply with paragraph 3.3.5.1. of Sub-Annex 5.

When the CVS flow rate, q_{cv} , over the test varies by more than ± 3 per cent of the arithmetic average flow rate, a flow-weighted arithmetic average shall be used for all continuous diluted measurements including PN:

$$C_e = \frac{\sum_{i=1}^{n-1} q_{cv}(i) \times \Delta t \times C(i)}{V}$$

where:

C_e is the flow-weighted arithmetic average concentration;
 $q_{cv}(i)$ is the CVS flow rate at time
 $t = i \times \Delta t$
 , m³/min;

Status: Point in time view as at 01/06/2017.

Changes to legislation: There are outstanding changes not yet made to Commission Regulation (EU) 2017/1151. Any changes that have already been made to the legislation appear in the content and are referenced with annotations. (See end of Document for details)

C(i) is the concentration at time
 $t = i \times \Delta t$
, ppm;
 Δt sampling interval, s;
V total CVS volume, m³.

3.2.1.2. Calculation of the NO_x humidity correction factor

In order to correct the influence of humidity on the results of oxides of nitrogen, the following calculations apply:

$$KH = \frac{1}{1 - 0,0329 \times (H - 10,71)}$$

where:

$$H = \frac{0,211 \times R_a \times P_d}{P_B - P_d \times R_a \times 10^{-2}}$$

and:

H is the specific humidity, grams of water vapour per kilogram dry air;
R_a is the relative humidity of the ambient air, per cent;
P_d is the saturation vapour pressure at ambient temperature, kPa;
P_B is the atmospheric pressure in the room, kPa.

The KH factor shall be calculated for each phase of the test cycle.

The ambient temperature and relative humidity shall be defined as the arithmetic average of the continuously measured values during each phase.

3.2.2. Determination of the HC mass emissions from compression-ignition engines

3.2.2.1. To calculate HC mass emission for compression-ignition engines, the arithmetic average HC concentration shall be calculated using the following equation:

$$C_e = \frac{\int_{t_1}^{t_2} C_{HC} dt}{t_2 - t_1}$$

where:

$\int_{t_1}^{t_2} C_{HC} dt$ is the integral of the recording of the heated FID over the test (t₁ to t₂);

C_e is the concentration of HC measured in the diluted exhaust in ppm of C_i and is substituted for C_{HC} in all relevant equations.

3.2.2.1.1. Dilution air concentration of HC shall be determined from the dilution air bags. Correction shall be carried out according to paragraph 3.2.1.1. of this Sub-Annex.

3.2.3. Fuel consumption and CO₂ calculations for individual vehicles in an interpolation family

3.2.3.1. Fuel consumption and CO₂ emissions without using the interpolation method

The CO₂ value, as calculated in paragraph 3.2.1. of this Sub-Annex and fuel consumption, as calculated according to paragraph 6. of this Sub-Annex, shall be attributed to all individual vehicles in the interpolation family and the interpolation method shall not be applicable.

3.2.3.2. Fuel consumption and CO₂ emissions using the interpolation method

Status: Point in time view as at 01/06/2017.

Changes to legislation: There are outstanding changes not yet made to Commission Regulation (EU) 2017/1151. Any changes that have already been made to the legislation appear in the content and are referenced with annotations. (See end of Document for details)

The CO₂ emissions and the fuel consumption for each individual vehicle in the interpolation family may be calculated according to the interpolation method outlined in paragraphs 3.2.3.2.1. to 3.2.3.2.5. inclusive of this Sub-Annex.

3.2.3.2.1. Fuel consumption and CO₂ emissions of test vehicles L and H

The mass of CO₂ emissions,

M_{CO_2-L}

, and

M_{CO_2-H}

and its phases p,

$M_{CO_2-L,p}$

and

$M_{CO_2-H,p}$

, of test vehicles L and H, used for the following calculations, shall be taken from step 9 of Table A7/1.

Fuel consumption values are also taken from step 9 of Table A7/1 and are referred to as $FC_{L,p}$ and $FC_{H,p}$.

3.2.3.2.2. Road load calculation for an individual vehicle

3.2.3.2.2.1. Mass of an individual vehicle

The test masses of vehicles H and L shall be used as input for the interpolation method.

TM_{ind} , in kg, shall be the individual test mass of the vehicle according to paragraph 3.2.25. of this Annex.

If the same test mass is used for test vehicles L and H, the value of TM_{ind} shall be set to the mass of test vehicle H for the interpolation method.

3.2.3.2.2.2. Rolling resistance of an individual vehicle

The actual rolling resistance values for the selected tyres on test vehicle L, RR_L , and test vehicle H, RR_H , shall be used as input for the interpolation method. See paragraph 4.2.2.1. of Sub-Annex 4.

If the tyres on the front and rear axles of vehicle L or H have different rolling resistance values, the weighted mean of the rolling resistances shall be calculated using the following equation:

$$RR_x = RR_{x,FA} \times mp_{x,FA} + RR_{x,RA} \times (1 - mp_{x,FA})$$

where:

$RR_{x,FA}$	is the rolling resistance of the front axle tyres, kg/tonne;
$RR_{x,RA}$	is the rolling resistance of the rear axle tyres, kg/tonne;
$mp_{x,FA}$	is the proportion of the vehicle mass on the front axle of vehicle H;
x	represents vehicle L, H or an individual vehicle.

For the tyres fitted to an individual vehicle, the value of the rolling resistance RR_{ind} shall be set to the class value of the applicable tyre rolling resistance class, according to Table A4/1 of Sub-Annex 4.

If the tyres have different rolling resistance class values on the front and the rear axle, the weighted mean shall be used, calculated with the equation in this paragraph.

Status: Point in time view as at 01/06/2017.

Changes to legislation: There are outstanding changes not yet made to Commission Regulation (EU) 2017/1151. Any changes that have already been made to the legislation appear in the content and are referenced with annotations. (See end of Document for details)

If the same tyres were fitted to test vehicles L and H, the value of RR_{ind} for the interpolation method shall be set to RR_H .

3.2.3.2.2. Aerodynamic drag of an individual vehicle

The aerodynamic drag shall be measured for each of the drag-influencing items of optional equipment and body shapes in a wind tunnel fulfilling the requirements of paragraph 3.2. of Sub-Annex 4 verified by the approval authority.

At the request of the manufacturer and with approval of the approval authority, an alternative method (e.g. simulation, wind tunnel not fulfilling the criterion in Sub-Annex 4) may be used to determine $\Delta(C_D \times A_f)$ if the following criteria are fulfilled:

- (a) The alternative determination method shall fulfil an accuracy for $\Delta(C_D \times A_f)$ of $\pm 0,015 \text{ m}^2$ and additionally, in the case that simulation is used, the Computational Fluid Dynamics method should be validated in detail, so that the actual air flow patterns around the body, including magnitudes of flow velocities, forces, or pressures, are shown to match the validation test results;
- (b) The alternative method shall be used only for those aerodynamic-influencing parts (e.g. wheels, body shapes, cooling system) for which equivalency was demonstrated;
- (c) Evidence of equivalency shall be shown in advance to the approval authority for each road load family in the case that a mathematical method is used or every four years in the case that a measurement method is used, and in any case shall be based on wind tunnel measurements fulfilling the criteria of this Annex;
- (d) If the $\Delta(C_D \times A_f)$ of an option is more than double than that with the option for which the evidence was given, aerodynamic drag shall not be determined with the alternative method; and
- (e) In the case that a simulation model is changed, a revalidation shall be necessary. $\Delta(C_D \times A_f)_{LH}$ is the difference in the product of the aerodynamic drag coefficient times frontal area of test vehicle H compared to test vehicle L and shall be included in all relevant test reports, m^2 .

$\Delta(C_D \times A_f)_{ind}$ is the difference in the product of the aerodynamic drag coefficient times frontal area between an individual vehicle and test vehicle L due to options and body shapes on the vehicle that differ from those of test vehicle L, m^2 ;

These differences in aerodynamic drag, $\Delta(C_D \times A_f)$, shall be determined with an accuracy of $0,015 \text{ m}^2$.

$\Delta(C_D \times A_f)_{ind}$ may be calculated according to the following equation maintaining the accuracy of $0,015 \text{ m}^2$ also for the sum of items of optional equipment and body shapes:

$$\Delta(C_D \times A_f)_{ind} = \sum_{i=1}^n \Delta(C_D \times A_f)_i$$

where:

- C_D is the aerodynamic drag coefficient;
- A_f is the frontal area of the vehicle, m^2 ;
- n is the number of items of optional equipment on the vehicle that are different between an individual vehicle and test vehicle L.
- $\Delta(C_D \times A_f)_i$ is the difference in the product of the aerodynamic drag coefficient times frontal area due to an individual feature, i , on the vehicle and is positive

Status: Point in time view as at 01/06/2017.

Changes to legislation: There are outstanding changes not yet made to Commission Regulation (EU) 2017/1151. Any changes that have already been made to the legislation appear in the content and are referenced with annotations. (See end of Document for details)

for an item of optional equipment that adds aerodynamic drag with respect to test vehicle L and vice versa, m²;

The sum of all

$$\Delta(C_D \times A_f)_i$$

differences between test vehicles L and H shall correspond to the total difference between test vehicles L and H, and shall be referred to as $\Delta(C_D \times A_f)_{LH}$.

The increase or decrease of the product of the aerodynamic drag coefficient times frontal area expressed as $\Delta(C_D \times A_f)$ for all of the items of optional equipment and body shapes in the interpolation family that:

- (a) has an influence on the aerodynamic drag of the vehicle; and
- (b) is to be included in the interpolation,

shall be included in all relevant test reports.

The aerodynamic drag of vehicle H shall be applied to the whole interpolation family and $\Delta(C_D \times A_f)_{LH}$ shall be set to zero, if:

- (a) the wind tunnel facility is not able to accurately determine $\Delta(C_D \times A_f)$; or
- (b) there are no drag influencing items of optional equipment between the test vehicles H and L that are to be included in the interpolation method.

3.2.3.2.2. Calculation of road load for individual vehicles in the interpolation family

The road load coefficients f_0 , f_1 and f_2 (as defined in Sub-Annex 4) for test vehicles H and L are referred to as $f_{0,H}$, $f_{1,H}$ and $f_{2,H}$, and $f_{0,L}$, $f_{1,L}$ and $f_{2,L}$ respectively. An adjusted road load curve for the test vehicle L is defined as follows:

$$F_L(v) = f_{*}^{0,L} + f_{1,L} \times v + f_{*}^{2,L} \times v^2$$

Applying the least squares regression method in the range of the reference speed points, adjusted road load coefficients

$$f_{*}^{0,L}$$

and

$$f_{*}^{2,L}$$

shall be determined for

$$F_L(v)$$

with the linear coefficient

$$f_{*}^{1,L}$$

set to $f_{1,H}$. The road load coefficients $f_{0,ind}$, $f_{1,ind}$ and $f_{2,ind}$ for an individual vehicle in the interpolation family shall be calculated using the following equations:

$$f_{0,ind} = f_{0,H} - \Delta f_0 \times \frac{(TM_H \times RR_H - TM_{ind} \times RR_{ind})}{(TM_H \times RR_H - TM_L \times RR_L)}$$

or, if

$$(TM_H \times RR_H - TM_L \times RR_L) = 0$$

, the equation for

$$f_{0,ind}$$

below shall apply:

$$f_{0,ind} = f_{0,H} - \Delta f_0$$

$$f_{1,ind} = f_{1,H}$$

Status: Point in time view as at 01/06/2017.

Changes to legislation: There are outstanding changes not yet made to Commission Regulation (EU) 2017/1151. Any changes that have already been made to the legislation appear in the content and are referenced with annotations. (See end of Document for details)

$$f_{2,ind} = f_{2,H} - \Delta f_2 \frac{(\Delta[C_d \times A_f]_{LH} - \Delta[C_d \times A_f]_{ind})}{(\Delta[C_d \times A_f]_{LH})}$$

or, if

$$\Delta(C_d \times A_f)_{LH} = 0$$

, the equation for

$$F_{2,ind}$$

below shall apply:

$$f_{2,ind} = f_{2,H} - \Delta f_2$$

where:

$$\Delta f_0 = f_{0,H} - f_{0,L}^{0,L}$$

$$\Delta f_2 = f_{2,H} - f_{2,L}^{2,L}$$

In the case of a road load matrix family, the road load coefficients f_0 , f_1 and f_2 for an individual vehicle shall be calculated according to the equations in paragraph 5.1.1. of Sub-Annex 4.

3.2.3.2.3. Calculation of cycle energy demand

The cycle energy demand of the applicable WLTC, E_k , and the energy demand for all applicable cycle phases $E_{k,p}$, shall be calculated according to the procedure in paragraph 5. of this Sub-Annex, for the following sets, k , of road load coefficients and masses:

$$k=1 \quad : \quad f_0 = f_{0,L}^{0,L}, f_1 = f_{1,H}, f_2 = f_{2,L}^{2,L}, m = TM_L$$

(test vehicle L)

$$k=2 \quad : \quad f_0 = f_{0,H}, f_1 = f_{1,H}, f_2 = f_{2,H}, m = TM_H$$

(test vehicle H)

$$k=3 \quad : \quad f_0 = f_{0,ind}, f_1 = f_{1,H}, f_2 = f_{2,ind}, m = TM_{ind}$$

(an individual vehicle in the interpolation family)

3.2.3.2.4. Calculation of the CO₂ value for an individual vehicle within an interpolation family using the interpolation method

For each cycle phase p of the applicable cycle the mass of CO₂ emissions g/km, for an individual vehicle shall be calculated using the following equation:

$$M_{CO_2-ind,p} = M_{CO_2-L,p} + \left(\frac{E_{2,p} - E_{1,p}}{E_{2,p} - E_{1,p}} \right) \times (M_{CO_2-H,p} - M_{CO_2-L,p})$$

The mass of CO₂ emissions, g/km, over the complete cycle for an individual vehicle shall be calculated using the following equation:

$$M_{CO_2-ind} = M_{CO_2-L} + \left(\frac{E_3 - E_1}{E_2 - E_1} \right) \times (M_{CO_2-H} - M_{CO_2-L})$$

The terms $E_{1,p}$, $E_{2,p}$ and $E_{3,p}$ and E_1 , E_2 and E_3 respectively are defined in paragraph 3.2.3.2.3. of this Sub-Annex.

3.2.3.2.5. Calculation of the fuel consumption FC value for an individual vehicle within an interpolation family using the interpolation method

For each cycle phase p of the applicable cycle, the fuel consumption, l/100 km, for an individual vehicle shall be calculated using the following equation:

$$FC_{ind,p} = FC_{L,p} + \left(\frac{E_{3,p} - E_{1,p}}{E_{2,p} - E_{1,p}} \right) \times (FC_{H,p} - FC_{L,p})$$

Status: Point in time view as at 01/06/2017.

Changes to legislation: There are outstanding changes not yet made to Commission Regulation (EU) 2017/1151. Any changes that have already been made to the legislation appear in the content and are referenced with annotations. (See end of Document for details)

The fuel consumption, l/100 km, of the complete cycle for an individual vehicle shall be calculated using the following equation:

$$FC_{ind} = FC_L + \left(\frac{E_3 - E_1}{E_2 - E_1} \right) \times (FC_H - FC_L)$$

The terms $E_{1,p}$, $E_{2,p}$ and $E_{3,p}$, and E_1 , E_2 and E_3 respectively are defined in paragraph 3.2.3.2.3. of this Sub-Annex.

3.2.4. Fuel consumption and CO₂ calculations for individual vehicles in a road load matrix family

The CO₂ emissions and the fuel consumption for each individual vehicle in the road load matrix family shall be calculated according to the interpolation method outlined in paragraphs 3.2.3.2.3. to 3.2.3.2.5. inclusive of this Sub-Annex. Where applicable, references to vehicle L and/or H shall be replaced by references to vehicle L_M and/or H_M respectively.

3.2.4.1. Determination of fuel consumption and CO₂ emissions of vehicles L_M and H_M

The mass of CO₂ emissions M_{CO_2} of vehicles L_M and H_M shall be determined according to the calculations in paragraph 3.2.1. of this Sub-Annex for the individual cycle phases p of the applicable WLTC and are referred to as

$$M_{CO_2-LM,p}$$

and

$$M_{CO_2-HM,p}$$

respectively. Fuel consumption for individual cycle phases of the applicable WLTC shall be determined according to paragraph 6. of this Sub-Annex and are referred to as $FC_{LM,p}$ and $FC_{HM,p}$ respectively.

3.2.4.1.1. Road load calculation for an individual vehicle

The road load force shall be calculated according to the procedure described in paragraph 5.1. of Sub-Annex 4.

3.2.4.1.1.1. Mass of an individual vehicle

The test masses of vehicles H_M and L_M selected according to paragraph 4.2.1.4. of Sub-Annex 4 shall be used as input.

TM_{ind} , in kg, shall be the test mass of the individual vehicle according to the definition of test mass in paragraph 3.2.25. of this Annex.

If the same test mass is used for vehicles L_M and H_M, the value of TM_{ind} shall be set to the mass of vehicle H_M for the road load matrix family method.

3.2.4.1.1.1. Rolling resistance of an individual vehicle

The rolling resistance values for vehicle L_M, RR_{LM} , and vehicle H_M, RR_{HM} , selected under paragraph 4.2.1.4. of Sub-Annex 4 shall be used as input.

If the tyres on the front and rear axles of vehicle L_M or H_M have different rolling resistance values, the weighted mean of the rolling resistances shall be calculated using the following equation:

$$RR_x = RR_{x,FA} \times mp_{x,FA} + RR_{x,RA} \times (1 - mp_{x,FA})$$

where:

$RR_{x,FA}$ is the rolling resistance of the front axle tyres, kg/tonne;

Status: Point in time view as at 01/06/2017.

Changes to legislation: There are outstanding changes not yet made to Commission Regulation (EU) 2017/1151. Any changes that have already been made to the legislation appear in the content and are referenced with annotations. (See end of Document for details)

$RR_{x,RA}$ is the rolling resistance of the rear axle tyres, kg/tonne;
 $mp_{x,FA}$ is the proportion of the vehicle mass on the front axle;
 x represents vehicle L, H or an individual vehicle.

For the tyres fitted to an individual vehicle, the value of the rolling resistance RR_{ind} shall be set to the class value of the applicable tyre rolling resistance class according to Table A4/1 of Sub-Annex 4.

If the tyres on the front and the rear axles have different rolling resistance class values, the weighted mean shall be used, calculated with the equation in this paragraph.

If the same rolling resistance is used for vehicles L_M and H_M , the value of RR_{ind} shall be set to RR_{HM} for the road load matrix family method.

3.2.4.1.1. Frontal area of an individual vehicle

The frontal area for vehicle L_M , A_{fLM} , and vehicle H_M , A_{fHM} , selected under paragraph 4.2.1.4. of Sub-Annex 4 shall be used as input.

$A_{f,ind}$, m^2 , shall be the frontal area of the individual vehicle.

If the same frontal area is used for vehicles L_M and H_M , the value of $A_{f,ind}$ shall be set to the frontal area of vehicle H_M for the road load matrix family method.

3.3. PM

3.3.1. Calculation

PM shall be calculated using the following two equations:

$$PM = \frac{(V_{mix} + V_{ep}) \times P_e}{V_{ep} \times d}$$

where exhaust gases are vented outside tunnel;

and:

$$PM = \frac{V_{mix} \times P_e}{V_{ep} \times d}$$

where exhaust gases are returned to the tunnel;

where:

V_{mix} is the volume of diluted exhaust gases (see paragraph 2. of this Sub-Annex), under standard conditions;
 V_{ep} is the volume of diluted exhaust gas flowing through the particulate sampling filter under standard conditions;
 P_e is the mass of particulate matter collected by one or more sample filters, mg;
 d is the distance driven corresponding to the test cycle, km.

3.3.1.1. Where correction for the background particulate mass from the dilution system has been used, this shall be determined in accordance with paragraph 1.2.1.3.1. of Sub-Annex 6. In this case, particulate mass (mg/km) shall be calculated using the following equations:

$$PM = \left\{ \frac{P_e}{V_{ep}} - \left[\frac{P_b}{V_{ep}} \times \left(1 - \frac{1}{DF} \right) \right] \right\} \times \frac{(V_{mix} + V_{ep})}{d}$$

in the case that the exhaust gases are vented outside the tunnel;

Status: Point in time view as at 01/06/2017.

Changes to legislation: There are outstanding changes not yet made to Commission Regulation (EU) 2017/1151. Any changes that have already been made to the legislation appear in the content and are referenced with annotations. (See end of Document for details)

and:

$$PM = \left\{ \frac{P_e}{V_{ep}} - \left[\frac{P_a}{V_{ap}} \times \left(1 - \frac{1}{DF} \right) \right] \right\} \times \frac{(V_{mix})}{d}$$

in the case that the exhaust gases are returned to the tunnel;

where:

- V_{ap} is the volume of tunnel air flowing through the background particulate filter under standard conditions;
- P_a is the particulate mass from the dilution air, or the dilution tunnel background air, as determined by the one of the methods described in paragraph 1.2.1.3.1. of Sub-Annex 6;
- DF is the dilution factor determined in paragraph 3.2.1.1.1. of this Sub-Annex.

Where application of a background correction results in a negative result, it shall be considered to be zero mg/km.

3.3.2. Calculation of PM using the double dilution method

$$V_{ep} = V_{set} - V_{ssd}$$

where:

- V_{ep} is the volume of diluted exhaust gas flowing through the particulate sample filter under standard conditions;
- V_{set} is the volume of the double diluted exhaust gas passing through the particulate sampling filters under standard conditions;
- V_{ssd} is the volume of the secondary dilution air under standard conditions.

Where the secondary diluted sample gas for PM measurement is not returned to the tunnel, the CVS volume shall be calculated as in single dilution, i.e.:

$$V_{mix} = V_{mix \text{ indicated}} + V_{ep}$$

where:

- $V_{mix \text{ indicated}}$ is the measured volume of diluted exhaust gas in the dilution system following extraction of the particulate sample under standard conditions.

4. Determination of PN

4.1. PN shall be calculated using the following equation:

$$PN = \frac{V \times k \times (\bar{c}_s \times \bar{f}_s - C_b \times \bar{f}_{is}) \times 10^8}{d}$$

where:

- PN is the particle number emission, particles per kilometre;
- V is the volume of the diluted exhaust gas in litres per test (after primary dilution only in the case of double dilution) and corrected to standard conditions (273,15 K (0 °C) and 101,325 kPa);
- k is a calibration factor to correct the PNC measurements to the level of the reference instrument where this is not applied internally within the PNC. Where the calibration factor is applied internally within the PNC, the calibration factor shall be 1;
- \bar{c}_s is the corrected particle number concentration from the diluted exhaust gas expressed as the arithmetic average number of particles per cubic

Status: Point in time view as at 01/06/2017.

Changes to legislation: There are outstanding changes not yet made to Commission Regulation (EU) 2017/1151. Any changes that have already been made to the legislation appear in the content and are referenced with annotations. (See end of Document for details)

centimetre from the emissions test including the full duration of the drive cycle. If the volumetric mean concentration results

\bar{C}

from the PNC are not measured at standard conditions (273,15 K (0 °C) and 101,325 kPa), the concentrations shall be corrected to those conditions

\bar{C}_s

;

C_b is either the dilution air or the dilution tunnel background particle number concentration, as permitted by the approval authority, in particles per cubic centimetre, corrected for coincidence and to standard conditions (273,15 K (0 °C) and 101,325 kPa);

\bar{f}_r is the mean particle concentration reduction factor of the VPR at the dilution setting used for the test;

\bar{f}_{rb} is the mean particle concentration reduction factor of the VPR at the dilution setting used for the background measurement;

d is the distance driven corresponding to the applicable test cycle, km.

\bar{C}

shall be calculated from the following equation:

$$\bar{C} = \frac{\sum_{i=1}^n C_i}{n}$$

where:

C_i is a discrete measurement of particle number concentration in the diluted gas exhaust from the PNC; particles per cm³ and corrected for coincidence;

n is the total number of discrete particle number concentration measurements made during the applicable test cycle and shall be calculated using the following equation:

$$n = t \times f$$

where:

t is the time duration of the applicable test cycle, s;

f is the data logging frequency of the particle counter, Hz.

5. Calculation of cycle energy demand

Unless otherwise specified, the calculation shall be based on the target speed trace given in discrete time sample points.

For the calculation, each time sample point shall be interpreted as a time period. Unless otherwise specified, the duration Δt of these periods shall be 1 second.

The total energy demand E for the whole cycle or a specific cycle phase shall be calculated by summing E_i over the corresponding cycle time between t_{start} and t_{end} according to the following equation:

$$E = \sum_{t_{start}}^{t_{end}} E_i$$

where:

$$E_i = F_i \times d_i \text{ if } F_i > 0$$

$$E_i = 0 \text{ if } F_i \leq 0$$

and:

Status: Point in time view as at 01/06/2017.

Changes to legislation: There are outstanding changes not yet made to Commission Regulation (EU) 2017/1151. Any changes that have already been made to the legislation appear in the content and are referenced with annotations. (See end of Document for details)

t_{start} is the time at which the applicable test cycle or phase starts, s;
 t_{end} is the time at which the applicable test cycle or phase ends, s;
 E_i is the energy demand during time period (i-1) to (i), Ws;
 F_i is the driving force during time period (i-1) to (i), N;
 d_i is the distance travelled during time period (i-1) to (i), m.

$$F_i = f_0 + f_1 \times \left(\frac{v_i + v_{i-1}}{2} \right) + f_2 \times \frac{(v_i + v_{i-1})^2}{4} + (1.03 \times \text{TM}) \times a_i$$

where:

F_i is the driving force during time period (i-1) to (i), N;
 v_i is the target speed at time t_i , km/h;
 TM is the test mass, kg;
 a_i is the acceleration during time period (i-1) to (i), m/s^2 ;

f_0 , f_1 , f_2 are the road load coefficients for the test vehicle under consideration (TM_L , TM_H or TM_{ind}) in N, N/km/h and in $\text{N}/(\text{km/h})^2$ respectively.

$$d_i = \frac{(v_i + v_{i-1})}{2 \times 3.6} \times (t_i - t_{i-1})$$

where:

d_i is the distance travelled in time period (i-1) to (i), m;
 v_i is the target speed at time t_i , km/h;
 t_i is time, s.

$$a_i = \frac{v_i - v_{i-1}}{3.6 \times (t_i - t_{i-1})}$$

where:

a_i is the acceleration during time period (i-1) to (i), m/s^2 ;
 v_i is the target speed at time t_i , km/h;
 t_i is time, s.

6. Calculation of fuel consumption

6.1. The fuel characteristics required for the calculation of fuel consumption values shall be taken from Annex IX.

6.2. The fuel consumption values shall be calculated from the emissions of hydrocarbons, carbon monoxide, and carbon dioxide using the results of step 6 for criteria emissions and step 7 for CO_2 of Table A7/1.

6.2.1. The general equation in paragraph 6.12. using H/C and O/C ratios shall be used for the calculation of fuel consumption.

6.2.2. For all equations in paragraph 6. of this Sub-Annex:

FC is the fuel consumption of a specific fuel, 1/100 km (or m_3 per 100 km in the case of natural gas or kg/100 km in the case of hydrogen);
 H/C is the hydrogen to carbon ratio of a specific fuel $\text{C}_x\text{H}_y\text{O}_z$;
 O/C is the oxygen to carbon ratio of a specific fuel $\text{C}_x\text{H}_y\text{O}_z$;
 MW_C is the molar mass of carbon (12,011 g/mol);
 MW_H is the molar mass of hydrogen (1,008 g/mol);
 MW_O is the molar mass of oxygen (15,999 g/mol);
 ρ_{fuel} is the test fuel density, kg/l. For gaseous fuels, fuel density at 15 °C;

Status: Point in time view as at 01/06/2017.

Changes to legislation: There are outstanding changes not yet made to Commission Regulation (EU) 2017/1151. Any changes that have already been made to the legislation appear in the content and are referenced with annotations. (See end of Document for details)

HC	are the emissions of hydrocarbon, g/km;
CO	are the emissions of carbon monoxide, g/km;
CO ₂	are the emissions of carbon dioxide, g/km;
H ₂ O	are the emissions of water, g/km;
H ₂	are the emissions of hydrogen, g/km;
p ₁	is the gas pressure in the fuel tank before the applicable test cycle, Pa;
p ₂	is the gas pressure in the fuel tank after the applicable test cycle, Pa;
T ₁	is the gas temperature in the fuel tank before the applicable test cycle, K;
T ₂	is the gas temperature in the fuel tank after the applicable test cycle, K;
Z ₁	is the compressibility factor of the gaseous fuel at p ₁ and T ₁ ;
Z ₂	is the compressibility factor of the gaseous fuel at p ₂ and T ₂ ;
V	is the interior volume of the gaseous fuel tank, m ³ ;
d	is the theoretical length of the applicable phase or cycle, km.

6.3. Reserved

6.4. Reserved

6.5. For a vehicle with a positive ignition engine fuelled with petrol (E10)

$$FC = \left(\frac{0,1206}{\rho_{fuel}} \right) \times [(0,829 \times HC) + (0,429 \times CO) + (0,273 \times CO_2)]$$

6.6. For a vehicle with a positive ignition engine fuelled with LPG

$$FC_{norm} = \left(\frac{0,1212}{0,538} \right) \times [(0,825 \times HC) + (0,429 \times CO) + (0,273 \times CO_2)]$$

6.6.1. If the composition of the fuel used for the test differs from the composition that is assumed for the calculation of the normalised consumption, on the manufacturer's request a correction factor cf may be applied, using the following equation:

$$FC_{norm} = \left(\frac{0,1212}{0,538} \right) \times cf \times [(0,825 \times HC) + (0,429 \times CO) + (0,273 \times CO_2)]$$

The correction factor, cf, which may be applied, is determined using the following equation:

$$cf = 0,825 + 0,0693 \times n_{actual}$$

where:

n_{actual} is the actual H/C ratio of the fuel used.

6.7. For a vehicle with a positive ignition engine fuelled with NG/biomethane

$$FC_{norm} = \left(\frac{0,1336}{0,654} \right) \times [(0,749 \times HC) + (0,429 \times CO) + (0,273 \times CO_2)]$$

6.8. Reserved

6.9. Reserved

6.10. For a vehicle with a compression engine fuelled with diesel (B7)

$$FC = \left(\frac{0,1165}{\rho_{fuel}} \right) \times [(0,858 \times HC) + (0,429 \times CO) + (0,273 \times CO_2)]$$

6.11. For a vehicle with a positive ignition engine fuelled with ethanol (E85)

$$FC = \left(\frac{0,1743}{\rho_{fuel}} \right) \times [(0,574 \times HC) + (0,429 \times CO) + (0,273 \times CO_2)]$$

6.12. Fuel consumption for any test fuel may be calculated using the following equation:

$$FC = \frac{MW_C + \frac{H}{C} \times MW_H + \frac{O}{C} \times MW_O}{MW_C \times \rho_{fuel} \times 10} \times \left(\frac{MW_C}{MW_C + \frac{H}{C} \times MW_H + \frac{O}{C} \times MW_O} \times HC + \frac{MW_C}{MW_{CO}} \times CO + \frac{MW_C}{MW_{CO_2}} \times CO_2 \right)$$

*Status: Point in time view as at 01/06/2017.**Changes to legislation: There are outstanding changes not yet made to Commission Regulation (EU) 2017/1151. Any changes that have already been made to the legislation appear in the content and are referenced with annotations. (See end of Document for details)*

6.13. Fuel consumption for a vehicle with a positive ignition engine fuelled by hydrogen:

$$FC = 0,024 \times \frac{V}{d} \times \left(\frac{1}{z_1} \times \frac{p_1}{n_1} - \frac{1}{z_2} \times \frac{p_2}{n_2} \right)$$

With approval of the approval authority and for vehicles fuelled either with gaseous or liquid hydrogen, the manufacturer may choose to calculate fuel consumption using either the equation for FC below or a method using a standard protocol such as SAE J2572.

$$FC = 0,1 \times (0,1119 \times H_2O + H_2)$$

The compressibility factor, Z, shall be obtained from the following table:

TABLE A7/2

Compressibility factor Z

		T (K)									
		5	100	200	300	400	500	600	700	800	900
p (bar)	33	0,859	1,051	1,885	2,648	3,365	4,051	4,712	5,352	5,973	6,576
	53	0,965	0,922	1,416	1,891	2,338	2,765	3,174	3,57	3,954	4,329
	73	0,989	0,991	1,278	1,604	1,923	2,229	2,525	2,810	3,088	3,358
	93	0,997	1,042	1,233	1,470	1,711	1,947	2,177	2,400	2,617	2,829
	113	1,000	1,066	1,213	1,395	1,586	1,776	1,963	2,146	2,324	2,498
	133	1,002	1,076	1,199	1,347	1,504	1,662	1,819	1,973	2,124	2,271
	153	1,003	1,079	1,187	1,312	1,445	1,580	1,715	1,848	1,979	2,107
	173	1,003	1,079	1,176	1,285	1,401	1,518	1,636	1,753	1,868	1,981
	193	1,003	1,077	1,165	1,263	1,365	1,469	1,574	1,678	1,781	1,882
	213	1,003	1,071	1,147	1,228	1,311	1,396	1,482	1,567	1,652	1,735
	233	1,004	1,071	1,148	1,228	1,312	1,397	1,482	1,568	1,652	1,736
	248	1,003	1,069	1,141	1,217	1,296	1,375	1,455	1,535	1,614	1,693
	263	1,003	1,066	1,136	1,207	1,281	1,356	1,431	1,506	1,581	1,655
	278	1,003	1,064	1,130	1,198	1,268	1,339	1,409	1,480	1,551	1,621
	293	1,003	1,062	1,125	1,190	1,256	1,323	1,390	1,457	1,524	1,590
	308	1,003	1,060	1,120	1,182	1,245	1,308	1,372	1,436	1,499	1,562
323	1,003	1,057	1,116	1,175	1,235	1,295	1,356	1,417	1,477	1,537	
338	1,003	1,055	1,111	1,168	1,225	1,283	1,341	1,399	1,457	1,514	
353	1,003	1,054	1,107	1,162	1,217	1,272	1,327	1,383	1,438	1,493	

In the case that the required input values for p and T are not indicated in the table, the compressibility factor shall be obtained by linear interpolation between the compressibility factors indicated in the table, choosing the ones that are the closest to the sought value.

7. Calculation of drive trace indices

Status: Point in time view as at 01/06/2017.

Changes to legislation: There are outstanding changes not yet made to Commission Regulation (EU) 2017/1151. Any changes that have already been made to the legislation appear in the content and are referenced with annotations. (See end of Document for details)

7.1. General requirement

The prescribed speed between time points in Tables A1/1 to A1/12 shall be determined by a linear interpolation method at a frequency of 10 Hz.

In the case that the accelerator control is fully activated, the prescribed speed shall be used instead of the actual vehicle speed for drive trace index calculations during such periods of operation.

7.2. Calculation of drive trace indices

The following indices shall be calculated according to SAE J2951(Revised JAN2014):

- (a) ER : Energy Rating
- (b) DR : Distance Rating
- (c) EER : Energy Economy Rating
- (d) ASCR : Absolute Speed Change Rating
- (e) IWR : Inertial Work Rating
- (f) RMSSE : Root Mean Squared Speed Error

Sub-Annex 8

Pure electric, hybrid electric and compressed hydrogen fuel cell hybrid vehicles

1. General requirements

In the case of testing NOVC-HEVs, OVC-HEVs and NOVC-FCHVs, Appendix 2 and Appendix 3 to this Sub-Annex shall replace Appendix 2 to Sub-Annex 6.

Unless stated otherwise, all requirements in this Sub-Annex shall apply to vehicles with and without driver-selectable modes. Unless explicitly stated otherwise in this Sub-Annex, all of the requirements and procedures specified in Sub-Annex 6 shall continue to apply for NOVC-HEVs, OVC-HEVs, NOVC-FCHVs and PEVs.

1.1. Units, accuracy and resolution of electric parameters

Parameters, units and accuracy of measurements shall be as shown in Table A8/1.

TABLE A8/1

Parameters, units and accuracy of measurements

Parameter	Units	Accuracy	Resolution
Electrical energy ^a	Wh	± 1 per cent	0,001 kWh ^b
Electrical current	A	± 0,3 per cent FSD or ± 1 per cent of reading ^{cd}	0,1 A
Electric voltage	V	± 0,3 per cent FSD or	0,1 V

^a Equipment: static meter for active energy.

^b AC watt-hour meter, Class 1 according to IEC 62053-21 or equivalent.

^c Whichever is greater.

^d Current integration frequency 20 Hz or more.

Status: Point in time view as at 01/06/2017.

Changes to legislation: There are outstanding changes not yet made to Commission Regulation (EU) 2017/1151. Any changes that have already been made to the legislation appear in the content and are referenced with annotations. (See end of Document for details)

	± 1 per cent of reading ^c	
a	Equipment: static meter for active energy.	
b	AC watt-hour meter, Class 1 according to IEC 62053-21 or equivalent.	
c	Whichever is greater.	
d	Current integration frequency 20 Hz or more.	

1.2. Emission and fuel consumption testing

Parameters, units and accuracy of measurements shall be the same as those required for conventional combustion engine-powered vehicles.

1.3. Units and precision of final test results

Units and their precision for the communication of the final results shall follow the indications given in Table A8/2. For the purpose of calculation in paragraph 4. of this Sub-Annex, the unrounded values shall apply.

TABLE A8/2

Units and precision of final test results

Parameter	Units	Communication of final test result
$PER_{(p)}^b$, PER_{city} , $AER_{(p)}^b$, AER_{city} , $EAER_{(p)}^b$, $EAER_{city}$, R_{CDA}^a , R_{CDC}	km	Rounded to nearest whole number
$FC_{CS(p)}^b$, FC_{CD} , $FC_{weighted}$ for HEVs	l/100 km	Rounded to the first place of decimal
$FC_{CS(p)}^b$ for FCHVs	kg/100 km	Rounded to the second place of decimal
$M_{CO2,CS(p)}^b$, $M_{CO2,CD}$, $M_{CO2,weighted}$	g/km	Rounded to the nearest whole number
$EC_{(p)}^b$, EC_{city} , $EC_{AC,CD}$, $EC_{AC,weighted}$	Wh/km	Rounded to the nearest whole number
E_{AC}	kWh	Rounded to the first place of decimal
a	no vehicle individual parameter	
b	(p) means the considered period which can be a phase, a combination of phases or the whole cycle	

1.4. Vehicle classification

All OVC-HEVs, NOVC-HEVs, PEVs and NOVC-FCHVs shall be classified as Class 3 vehicles. The applicable test cycle for the Type 1 test procedure shall be determined according to paragraph 1.4.2. of this Sub-Annex based on the corresponding reference test cycle as described in paragraph 1.4.1. of this Sub-Annex.

Status: Point in time view as at 01/06/2017.

Changes to legislation: There are outstanding changes not yet made to Commission Regulation (EU) 2017/1151. Any changes that have already been made to the legislation appear in the content and are referenced with annotations. (See end of Document for details)

1.4.1. Reference test cycle

1.4.1.1. The reference test cycle for Class 3 vehicles is specified in paragraph 3.3. of Sub-Annex 1.

1.4.1.2. For PEVs, the downscaling procedure, according to paragraphs 8.2.3. and 8.3. of Sub-Annex 1, may be applied on the test cycles according to paragraph 3.3. of Sub-Annex 1 by replacing the rated power with peak power. In such a case, the downscaled cycle is the reference test cycle.

1.4.2. Applicable test cycle

1.4.2.1. Applicable WLTP test cycle

The reference test cycle according to paragraph 1.4.1. of this Sub-Annex shall be the applicable WLTP test cycle (WLTC) for the Type 1 test procedure.

In the case that paragraph 9. of Sub-Annex 1 is applied based on the reference test cycle as described in paragraph 1.4.1. of this Sub-Annex, this modified test cycle shall be the applicable WLTP test cycle (WLTC) for the Type 1 test procedure.

1.4.2.2. Applicable WLTP city test cycle

The WLTP city test cycle (WLTC_{city}) for Class 3 vehicles is specified in paragraph 3.5. of Sub-Annex 1.

1.5. OVC-HEVs, NOVC-HEVs and PEVs with manual transmissions

The vehicles shall be driven according to the manufacturer's instructions, as incorporated in the manufacturer's handbook of production vehicles, and as indicated by a technical gear shift instrument.

2. REESS and fuel cell system preparation

2.1. For all OVC-HEVs, NOVC-HEVs, NOVC-FCHVs and PEVs, the following shall apply:

(a) Without prejudice to the requirements of paragraph 1.2.3.3. of Sub-Annex 6, the vehicles tested according to this Sub-Annex shall have been run-in at least 300 km with those REESSs installed;

(b) In the case that the REESSs are operated above the normal operating temperature range, the operator shall follow the procedure recommended by the vehicle manufacturer in order to keep the temperature of the REESS in its normal operating range. The manufacturer shall provide evidence that the thermal management system of the REESS is neither disabled nor reduced.

2.2. For NOVC-FCHVs without prejudice to the requirements of paragraph 1.2.3.3. of Sub-Annex 6, the vehicles tested to this Sub-Annex shall have been run-in at least 300 km with their fuel cell system installed.

3. Test procedure

3.1. General requirements

3.1.1. For all OVC-HEVs, NOVC-HEVs, PEVs and NOVC-FCHVs, the following shall apply where applicable:

Status: Point in time view as at 01/06/2017.

Changes to legislation: There are outstanding changes not yet made to Commission Regulation (EU) 2017/1151. Any changes that have already been made to the legislation appear in the content and are referenced with annotations. (See end of Document for details)

- 3.1.1.1. Vehicles shall be tested according to the applicable test cycles described in paragraph 1.4.2. of this Sub-Annex.
- 3.1.1.2. If the vehicle cannot follow the applicable test cycle within the speed trace tolerances according to paragraph 1.2.6.6. of Sub-Annex 6, the accelerator control shall, unless stated otherwise, be fully activated until the required speed trace is reached again.
- 3.1.1.3. The powertrain start procedure shall be initiated by means of the devices provided for this purpose according to the manufacturer's instructions.
- 3.1.1.4. For OVC-HEVs, NOVC-HEVs and PEVs, exhaust emissions sampling and measurement of electric energy consumption shall begin for each applicable test cycle before or at the initiation of the vehicle start procedure and end at the conclusion of each applicable test cycle.
- 3.1.1.5. For OVC-HEVs and NOVC-HEVs, gaseous emission compounds, shall be analysed for each individual test phase. It is permitted to omit the phase analysis for phases where no combustion engine operates.
- 3.1.1.6. Particle number shall be analysed for each individual phase and particulate matter emission shall be analysed for each applicable test cycle.
- 3.1.2. Forced cooling as described in paragraph 1.2.7.2. of Sub-Annex 6 shall apply only for the charge-sustaining Type 1 test for OVC-HEVs according to paragraph 3.2. of this Sub-Annex and for testing NOVC-HEVs according to paragraph 3.3. of this Sub-Annex.
- 3.2. OVC-HEVs
 - 3.2.1. Vehicles shall be tested under charge-depleting operating condition (CD condition), and charge-sustaining operating condition (CS condition).
 - 3.2.2. Vehicles may be tested according to four possible test sequences:
 - 3.2.2.1. Option 1: charge-depleting Type 1 test with no subsequent charge-sustaining Type 1 test.
 - 3.2.2.2. Option 2: charge-sustaining Type 1 test with no subsequent charge-depleting Type 1 test.
 - 3.2.2.3. Option 3: charge-depleting Type 1 test with a subsequent charge-sustaining Type 1 test.
 - 3.2.2.4. Option 4: charge-sustaining Type 1 test with a subsequent charge-depleting Type 1 test.

Figure A8/1

Status: Point in time view as at 01/06/2017.

Changes to legislation: There are outstanding changes not yet made to Commission Regulation (EU) 2017/1151. Any changes that have already been made to the legislation appear in the content and are referenced with annotations. (See end of Document for details)

Possible test sequences in the case of OVC-HEV testing

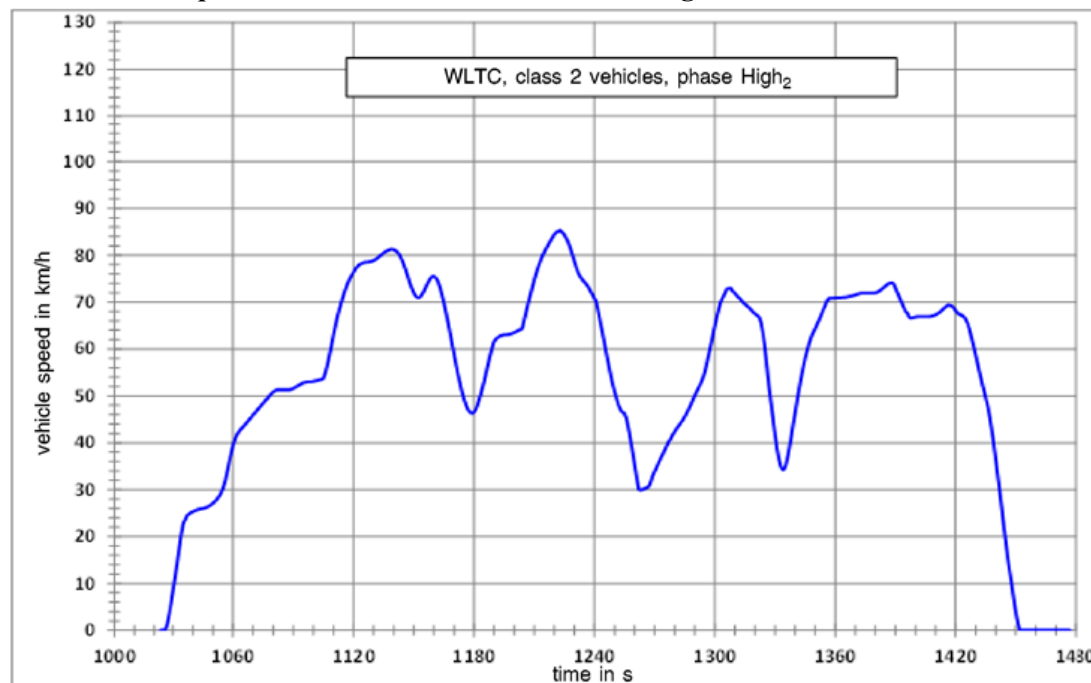

3.2.3. The driver-selectable mode shall be set as described in the following test sequences (Option 1 to Option 4).

3.2.4. Charge-depleting Type 1 test with no subsequent charge-sustaining Type 1 test (Option 1)

The test sequence according to Option 1, described in paragraphs 3.2.4.1. to 3.2.4.7. inclusive of this Sub-Annex, as well as the corresponding REESS state of charge profile, are shown in Figure A8.App1/1 in Appendix 1 to this Sub-Annex.

3.2.4.1. Preconditioning

The vehicle shall be prepared according to the procedures in paragraph 2.2. of Appendix 4 to this Sub-Annex.

3.2.4.2. Test conditions

3.2.4.2.1. The test shall be carried out with a fully charged REESS according to the charging requirements as described in paragraph 2.2.3. of Appendix 4 to this Sub-Annex and with the vehicle operated in charge-depleting operating condition as defined in paragraph 3.3.5. of this Annex.

3.2.4.2.2. Selection of a driver-selectable mode

For vehicles equipped with a driver-selectable mode, the mode for the charge-depleting Type 1 test shall be selected according to paragraph 2. of Appendix 6 to this Sub-Annex.

3.2.4.3. Charge-depleting Type 1 test procedure

3.2.4.3.1. The charge-depleting Type 1 test procedure shall consist of a number of consecutive cycles, each followed by a soak period of no more than 30 minutes until charge-sustaining operating condition is achieved.

Status: Point in time view as at 01/06/2017.

Changes to legislation: There are outstanding changes not yet made to Commission Regulation (EU) 2017/1151. Any changes that have already been made to the legislation appear in the content and are referenced with annotations. (See end of Document for details)

3.2.4.3.2. During soaking between individual applicable test cycles, the powertrain shall be deactivated and the REESS shall not be recharged from an external electric energy source. The instrumentation for measuring the electric current of all REESSs and for determining the electric voltage of all REESSs according to Appendix 3 of this Sub-Annex shall not be turned off between test cycle phases. In the case of ampere-hour meter measurement, the integration shall remain active throughout the entire test until the test is concluded.

Restarting after soak, the vehicle shall be operated in the driver-selectable mode according to paragraph 3.2.4.2.2. of this Sub-Annex.

3.2.4.3.3. In deviation from paragraph 5.3.1. of Sub-Annex 5 and without prejudice to paragraph 5.3.1.2. of Sub-Annex 5, analysers may be calibrated and zero- checked before and after the charge-depleting Type 1 test.

3.2.4.4. End of the charge-depleting Type 1 test

The end of the charge-depleting Type 1 test is considered to have been reached when the break-off criterion according to paragraph 3.2.4.5. of this Sub-Annex is reached for the first time. The number of applicable WLTP test cycles up to and including the one where the break-off criterion was reached for the first time is set to n+1.

The applicable WLTP test cycle n is defined as the transition cycle.

The applicable WLTP test cycle n+1 is defined to be the confirmation cycle.

For vehicles without a charge-sustaining capability over the complete applicable WLTP test cycle, the end of the charge-depleting Type 1 test is reached by an indication on a standard on-board instrument panel to stop the vehicle, or when the vehicle deviates from the prescribed driving tolerance for 4 consecutive seconds or more. The accelerator control shall be deactivated and the vehicle shall be braked to standstill within 60 seconds.

3.2.4.5. Break-off criterion

3.2.4.5.1. Whether the break-off criterion has been reached for each driven applicable WLTP test cycle shall be evaluated.

3.2.4.5.2. The break-off criterion for the charge-depleting Type 1 test is reached when the relative electric energy change $REEC_i$ as calculated using the following equation, is less than 0.04.

$$REEC_i = \frac{|\Delta E_{REESS,i}|}{E_{cycle} \times \frac{1}{3600}}$$

where:

$REEC_i$ is the relative electric energy change of the applicable test cycle considered i of the charge-depleting Type 1 test;

$\Delta E_{REESS,i}$ is the change of electric energy of all REESSs for the considered charge-depleting Type 1 test cycle i calculated according to paragraph 4.3. of this Sub-Annex, Wh;

E_{cycle} is the cycle energy demand of the considered applicable WLTP test cycle calculated according to paragraph 5. of Sub-Annex 7, Ws;

i is the index number for the considered applicable WLTP test cycle;

$\frac{1}{3600}$ is a conversion factor to Wh for the cycle energy demand.

3.2.4.6. REESS charging and measuring the recharged electric energy

Status: Point in time view as at 01/06/2017.

Changes to legislation: There are outstanding changes not yet made to Commission Regulation (EU) 2017/1151. Any changes that have already been made to the legislation appear in the content and are referenced with annotations. (See end of Document for details)

3.2.4.6.1. The vehicle shall be connected to the mains within 120 minutes after the applicable WLTP test cycle n+1 in which the break-off criterion for the charge-depleting Type 1 test is reached for the first time.

The REESS is fully charged when the end-of-charge criterion, as defined in paragraph 2.2.3.2. of Appendix 4 to this Sub-Annex, is reached.

3.2.4.6.2. The electric energy measurement equipment, placed between the vehicle charger and the mains, shall measure the recharged electric energy E_{AC} delivered from the mains, as well as its duration. Electric energy measurement may be stopped when the end-of-charge criterion, as defined in paragraph 2.2.3.2. of Appendix 4 to this Sub-Annex, is reached.

3.2.4.7. Each individual applicable WLTP test cycle within the charge-depleting Type 1 test shall fulfil the applicable criteria emission limits according to paragraph 1.1.2. of Sub-Annex 6.

3.2.5. Charge-sustaining Type 1 test with no subsequent charge-depleting Type 1 test (Option 2)

The test sequence according to Option 2, as described in paragraphs 3.2.5.1. to 3.2.5.3.3. inclusive of this Sub-Annex, as well as the corresponding REESS state of charge profile, are shown in Figure A8.App1/2 in Appendix 1 to this Sub-Annex.

3.2.5.1. Preconditioning and soaking

The vehicle shall be prepared according to the procedures in paragraph 2.1. of Appendix 4 to this Sub-Annex.

3.2.5.2. Test conditions

3.2.5.2.1. Tests shall be carried out with the vehicle operated in charge-sustaining operating condition as defined in paragraph 3.3.6. of this Annex.

3.2.5.2.2. Selection of a driver-selectable mode

For vehicles equipped with a driver-selectable mode, the mode for the charge-sustaining Type 1 test shall be selected according to paragraph 3. of Appendix 6 to this Sub-Annex.

3.2.5.3. Type 1 test procedure

3.2.5.3.1. Vehicles shall be tested according to the Type 1 test procedures described in Sub-Annex 6.

3.2.5.3.2. If required, CO₂ mass emission shall be corrected according to Appendix 2 to this Sub-Annex.

3.2.5.3.3. The test according to paragraph 3.2.5.3.1. of this Sub-Annex shall fulfil the applicable criteria emission limits according to paragraph 1.1.2. of Sub-Annex 6.

3.2.6. Charge-depleting Type 1 test with a subsequent charge-sustaining Type 1 test (Option 3)

The test sequence according to Option 3, as described in paragraphs 3.2.6.1. to 3.2.6.3. inclusive of this Sub-Annex, as well as the corresponding REESS state of charge profile, are shown in Figure A8.App1/3 in Appendix 1 to this Sub-Annex.

Status: Point in time view as at 01/06/2017.

Changes to legislation: There are outstanding changes not yet made to Commission Regulation (EU) 2017/1151. Any changes that have already been made to the legislation appear in the content and are referenced with annotations. (See end of Document for details)

3.2.6.1. For the charge-depleting Type 1 test, the procedure described in paragraphs 3.2.4.1. to 3.2.4.5. inclusive as well as paragraph 3.2.4.7. of this Sub-Annex shall be followed.

3.2.6.2. Subsequently, the procedure for the charge-sustaining Type 1 test described in paragraphs 3.2.5.1. to 3.2.5.3. inclusive of this Sub-Annex shall be followed. Paragraphs 2.1.1. to 2.1.2. inclusive of Appendix 4 to this Sub-Annex shall not apply.

3.2.6.3. REESS charging and measuring the recharged electric energy

3.2.6.3.1. The vehicle shall be connected to the mains within 120 minutes after the conclusion of the charge-sustaining Type 1 test.

The REESS is fully charged when the end-of-charge criterion as defined in paragraph 2.2.3.2. of Appendix 4 to this Sub-Annex is reached.

3.2.6.3.2. The energy measurement equipment, placed between the vehicle charger and the mains, shall measure the recharged electric energy E_{AC} delivered from the mains, as well as its duration. Electric energy measurement may be stopped when the end-of-charge criterion as defined in paragraph 2.2.3.2. of Appendix 4 to this Sub-Annex is reached.

3.2.7. Charge-sustaining Type 1 test with a subsequent charge-depleting Type 1 test (Option 4)

The test sequence according to Option 4, described in paragraphs 3.2.7.1. to 3.2.7.2. inclusive of this Sub-Annex, as well as the corresponding REESS state of charge profile, are shown in Figure A8.App1/4 of Appendix 1 to this Sub-Annex.

3.2.7.1. For the charge-sustaining Type 1 test, the procedure described in paragraphs 3.2.5.1. to 3.2.5.3. inclusive of this Sub-Annex, as well as paragraph 3.2.6.3.1. of this Sub-Annex shall be followed.

3.2.7.2. Subsequently, the procedure for the charge-depleting Type 1 test described in paragraphs 3.2.4.2. to 3.2.4.7. inclusive of this Sub-Annex shall be followed.

3.3. NOVC-HEVs

The test sequence described in paragraphs 3.3.1. to 3.3.3. inclusive of this Sub-Annex, as well as the corresponding REESS state of charge profile, are shown in Figure A8.App1/5 of Appendix 1 to this Sub-Annex.

3.3.1. Preconditioning and soaking

3.3.1.1. Vehicles shall be preconditioned according to paragraph 1.2.6. of Sub-Annex 6.

In addition to the requirements of paragraph 1.2.6., the level of the state of charge of the traction REESS for the charge-sustaining test may be set according to the manufacturer's recommendation before preconditioning in order to achieve a test under charge-sustaining operating condition.

3.3.1.2. Vehicles shall be soaked according to paragraph 1.2.7. of Sub-Annex 6.

3.3.2. Test conditions

3.3.2.1. Vehicles shall be tested under charge-sustaining operating condition as defined in paragraph 3.3.6. of this Annex.

3.3.2.2. Selection of a driver-selectable mode

Status: Point in time view as at 01/06/2017.

Changes to legislation: There are outstanding changes not yet made to Commission Regulation (EU) 2017/1151. Any changes that have already been made to the legislation appear in the content and are referenced with annotations. (See end of Document for details)

For vehicles equipped with a driver-selectable mode, the mode for the charge-sustaining Type 1 test shall be selected according to paragraph 3. of Appendix 6 to this Sub-Annex.

3.3.3. Type 1 test procedure

3.3.3.1. Vehicles shall be tested according to the Type 1 test procedure described in Sub-Annex 6.

3.3.3.2. If required, the CO₂ mass emission shall be corrected according to Appendix 2 to this Sub-Annex.

3.3.3.3. The charge-sustaining Type 1 test shall fulfil the applicable exhaust emission limits according to paragraph 1.1.2. of Sub-Annex 6.

3.4. PEVs

3.4.1. General requirements

The test procedure to determine the pure electric range and electric energy consumption shall be selected according to the estimated pure electric range (PER) of the test vehicle from Table A8/3. In the case that the interpolation approach is applied, the applicable test procedure shall be selected according to the PER of vehicle H within the specific interpolation family.

TABLE A8/3

Procedures to determine pure electric range and electric energy consumption

Applicable test cycle	The estimated PER is...	Applicable test procedure
Test cycle according to paragraph 1.4.2.1. including the Extra High phase	...less than the length of 3 applicable WLTP test cycles.	Consecutive cycle Type 1 test procedure (according to paragraph 3.4.4.1. of this Sub-Annex)
	...is equal to or greater than the length of 3 applicable WLTP test cycles.	Shortened Type 1 test procedure (according to paragraph 3.4.4.2. of this Sub-Annex)
Test cycle according to paragraph 1.4.2.1. excluding the Extra High phase	...is less than the length of 4 applicable WLTP test cycles.	Consecutive cycle Type 1 test procedure (according to paragraph 3.4.4.1. of this Sub-Annex)
	...is equal to or greater than the length of 4 applicable WLTP test cycles.	Shortened Type 1 test procedure (according to paragraph 3.4.4.2. of this Sub-Annex)
City cycle according to paragraph 1.4.2.2.	...not available over the applicable WLTP test cycle.	Consecutive cycle Type 1 test procedure (according to paragraph 3.4.4.1. of this Sub-Annex)

The manufacturer shall give evidence to the approval authority concerning the estimated pure electric range (PER) prior to the test. In the case that the interpolation approach is applied, the applicable test procedure shall be determined based on the estimated PER of vehicle H of the

Status: Point in time view as at 01/06/2017.

Changes to legislation: There are outstanding changes not yet made to Commission Regulation (EU) 2017/1151. Any changes that have already been made to the legislation appear in the content and are referenced with annotations. (See end of Document for details)

interpolation family. The PER determined by the applied test procedure shall confirm that the correct test procedure was applied.

The test sequence for the consecutive cycle Type 1 test procedure, as described in paragraphs 3.4.2., 3.4.3. and 3.4.4.1. of this Sub-Annex, as well as the corresponding REESS state of charge profile, are shown in Figure A8.App1/6 of Appendix 1 to this Sub-Annex.

The test sequence for the shortened Type 1 test procedure, as described in paragraphs 3.4.2., 3.4.3. and 3.4.4.2., as well as the corresponding REESS state of charge profile are shown in Figure A8.App1/7 in Appendix 1 to this Sub-Annex.

3.4.2. Preconditioning

The vehicle shall be prepared according to the procedures in paragraph 3. of Appendix 4 to this Sub-Annex.

3.4.3. Selection of a driver-selectable mode

For vehicles equipped with a driver-selectable mode, the mode for the test shall be selected according to paragraph 3. of Appendix 6 to this Sub-Annex.

3.4.4. PEV Type 1 test procedures

3.4.4.1. Consecutive cycle Type 1 test procedure

3.4.4.1.1. Speed trace and breaks

The test shall be performed by driving consecutive applicable test cycles until the break-off criterion according to paragraph 3.4.4.1.3. of this Sub-Annex is reached.

Breaks for the driver and/or operator are permitted only between test cycles and with a maximum total break time defined in Table A8/4. During the break, the powertrain shall be switched off.

3.4.4.1.2. REESS current and voltage measurement

From the beginning of the test until the break-off criterion is reached, the electric current of all REESSs shall be measured according to Appendix 3 to this Sub-Annex and the electric voltage shall be determined according to Appendix 3 to this Sub-Annex.

3.4.4.1.3. Break-off criterion

The break-off criterion is reached when the vehicle exceeds the prescribed speed trace tolerance as specified in paragraph 1.2.6.6. of Sub-Annex 6 for 4 consecutive seconds or more. The accelerator control shall be deactivated. The vehicle shall be braked to standstill within 60 seconds.

3.4.4.2. Shortened Type 1 test procedure

3.4.4.2.1. Speed trace

The shortened Type 1 test procedure consists of two dynamic segments (DS₁ and DS₂) combined with two constant speed segments (CSS_M and CSS_E) as shown in Figure A8/2.

Figure A8/2

Status: Point in time view as at 01/06/2017.

Changes to legislation: There are outstanding changes not yet made to Commission Regulation (EU) 2017/1151. Any changes that have already been made to the legislation appear in the content and are referenced with annotations. (See end of Document for details)

Shortened Type 1 test procedure speed trace

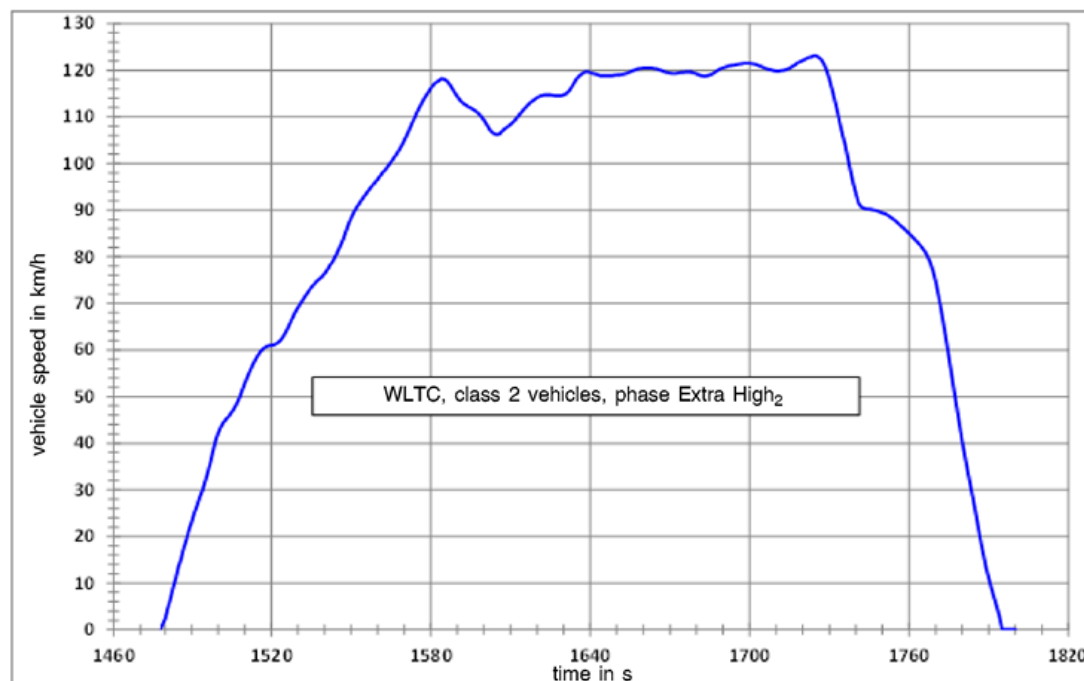

The dynamic segments DS₁ and DS₂ are used to determine the energy consumption for the applicable WLTP test cycle.

The constant speed segments CSS_M and CSS_E are intended to reduce test duration by depleting the REESS more rapidly than the consecutive cycle Type 1 test procedure.

3.4.4.2.1. Dynamic segments

Each dynamic segment DS₁ and DS₂ consists of an applicable WLTP test cycle according to paragraph 1.4.2.1. followed by an applicable WLTP city test cycle according to paragraph 1.4.2.2.

3.4.4.2.1. Constant speed segment

The constant speeds during segments CSS_M and CSS_E shall be identical. If the interpolation approach is applied, the same constant speed shall be applied within the interpolation family.

(a) Speed specification

The minimum speed of the constant speed segments shall be 100 km/h. At the request of manufacturer and with approval of the approval authority, a higher constant speed in the constant speed segments may be selected.

The acceleration to the constant speed level shall be smooth and accomplished within 1 minute after completion of the dynamic segments and, in the case of a break according to Table A8/4, after initiating the powertrain start procedure.

If the maximum speed of the vehicle is lower than the required minimum speed for the constant speed segments according to the speed specification of this paragraph, the required speed in the constant speed segments shall be equal to the maximum speed of the vehicle.

(b) Distance determination of CSS_E and CSS_M

Status: Point in time view as at 01/06/2017.

Changes to legislation: There are outstanding changes not yet made to Commission Regulation (EU) 2017/1151. Any changes that have already been made to the legislation appear in the content and are referenced with annotations. (See end of Document for details)

The length of the constant speed segment CSS_E shall be determined based on the percentage of the usable REESS energy UBE_{STP} according to paragraph 4.4.2.1. of this Sub-Annex. The remaining energy in the traction REESS after dynamic speed segment DS_2 shall be equal to or less than 10 per cent of UBE_{STP} . The manufacturer shall provide evidence to the approval authority after the test that this requirement is fulfilled.

The length of the constant speed segment CSS_M may be calculated using the following equation:

$$d_{CSSM} = PER_{est} - d_{DS1} - d_{DS2} - d_{CSS_E}$$

where:

PER_{est} is the estimated pure electric range of the considered PEV, km;
 d_{DS1} is the length of dynamic speed segment 1, km;
 d_{DS2} is the length of dynamic speed segment 2, km;
 d_{CSS_E} is the length of constant speed segment CSS_E , km.

3.4.4.2.1. Breaks

Breaks for the driver and/or operator are permitted only in the constant speed segments as prescribed in Table A8/4.

TABLE A8/4

Breaks for the driver and/or test operator

Distance driven (km)	Maximum total break (min)
Up to 100	10
Up to 150	20
Up to 200	30
Up to 300	60
More than 300	Shall be based on the manufacturer's recommendation

Note: During a break, the powertrain shall be switched off.

3.4.4.2.2. REESS current and voltage measurement

From the beginning of the test until the break-off criterion is reached, the electric current of all REESSs and the electric voltage of all REESSs shall be determined according to Appendix 3 to this Sub-Annex.

3.4.4.2.3. Break-off criterion

The break-off criterion is reached when the vehicle exceeds the prescribed driving tolerance as specified in paragraph 1.2.6.6. of Sub-Annex 6 for 4 consecutive seconds or more in the second constant speed segment CSS_E . The accelerator control shall be deactivated. The vehicle shall be braked to a standstill within 60 seconds.

3.4.4.3. REESS charging and measuring the recharged electric energy

3.4.4.3.1. After coming to a standstill according to paragraph 3.4.4.1.3. of this Sub-Annex for the consecutive cycle Type 1 test procedure and in paragraph 3.4.4.2.3. of this Sub-Annex for the shortened Type 1 test procedure, the vehicle shall be connected to the mains within 120 minutes.

Status: Point in time view as at 01/06/2017.

Changes to legislation: There are outstanding changes not yet made to Commission Regulation (EU) 2017/1151. Any changes that have already been made to the legislation appear in the content and are referenced with annotations. (See end of Document for details)

The REESS is fully charged when the end-of-charge criterion, as defined in paragraph 2.2.3.2. of Appendix 4 to this Sub-Annex, is reached.

3.4.4.3.2. The energy measurement equipment, placed between the vehicle charger and the mains, shall measure the recharged electric energy E_{AC} delivered from the mains as well as its duration. Electric energy measurement may be stopped when the end-of-charge criterion, as defined in paragraph 2.2.3.2. of Appendix 4 to this Sub-Annex, is reached.

3.5. NOVC-FCHVs

The test sequence, described in paragraphs 3.5.1. to 3.5.3. inclusive of this Sub-Annex, as well as the corresponding REESS state of charge profile, is shown in Figure A8.App1/5 in Appendix 1 to this Sub-Annex.

3.5.1. Preconditioning and soaking

Vehicles shall be conditioned and soaked according to paragraph 3.3.1. of this Sub-Annex.

3.5.2. Test conditions

3.5.2.1. Vehicles shall be tested under charge-sustaining operating conditions as defined in paragraph 3.3.6. of this Annex.

3.5.2.2. Selection of a driver-selectable mode

For vehicles equipped with a driver-selectable mode, the mode for the charge-sustaining Type 1 test shall be selected according to paragraph 3. of Appendix 6 to this Sub-Annex.

3.5.3. Type 1 test procedure

3.5.3.1. Vehicles shall be tested according to the Type 1 test procedure described in Sub-Annex 6 and fuel consumption calculated according to Appendix 7 to this Sub-Annex.

3.5.3.2. If required, fuel consumption shall be corrected according to Appendix 2 to this Sub-Annex.

4. Calculations for hybrid electric, pure electric and compressed hydrogen fuel cell vehicles

4.1. Calculations of gaseous emission compounds, particulate matter emission and particle number emission

4.1.1. Charge-sustaining mass emission of gaseous emission compounds, particulate matter emission and particle number emission for OVC-HEVs and NOVC-HEVs

The charge-sustaining particulate matter emission PM_{CS} shall be calculated according to paragraph 3.3. of Sub-Annex 7.

The charge-sustaining particle number emission PN_{CS} shall be calculated according to paragraph 4. of Sub-Annex 7.

4.1.1.1. Stepwise prescription for calculating the final test results of the charge-sustaining Type 1 test for NOVC-HEVs and OVC-HEVs

The results shall be calculated in the order described in Table A8/5. All applicable results in the column 'Output' shall be recorded. The column 'Process' describes the paragraphs to be used for calculation or contains additional calculations.

Status: Point in time view as at 01/06/2017.

Changes to legislation: There are outstanding changes not yet made to Commission Regulation (EU) 2017/1151. Any changes that have already been made to the legislation appear in the content and are referenced with annotations. (See end of Document for details)

For the purpose of this table, the following nomenclature within the equations and results is used:

c	complete applicable test cycle;
p	every applicable cycle phase;
i	applicable criteria emission component (except CO ₂);
CS	charge-sustaining
CO ₂	CO ₂ mass emission.

Table A8/5

Calculation of final charge-sustaining gaseous emission values

Source	Input	Process	Output	Step no.
Sub-Annex 6	Raw test results	Charge-sustaining mass emissions Sub-Annex 7, paragraphs 3. to 3.2.2. inclusive	M _{i,CS,p,1} , g/km; M _{CO₂,CS,p,1} , g/km.	1
Output from step no. 1 of this Table.	M _{i,CS,p,1} , g/km; M _{CO₂,CS,p,1} , g/km.	Calculation of combined charge-sustaining cycle values: $M_{i,CS,c,2} = \frac{\sum_p M_{i,CS,p,1} \times d_p}{\sum_p d_p}$ $M_{CO_2,CS,c,2} = \frac{\sum_p M_{CO_2,CS,p,1}}{\sum_p d_p}$ where: M _{i,CS,c,2} is the charge-sustaining mass emission result over the total cycle; M _{CO₂,CS,c,2} is the charge-sustaining CO ₂ mass emission result over the total cycle; d _p are the driven distances of the cycle phases p.	M _{i,CS,c,2} , g/km; M _{CO₂,CS,c,2} , g/km.	2
Output from step no. 1 and 2 of this Table.	M _{CO₂,CS,p,1} , g/km; M _{CO₂,CS,c,2} , g/km.	REESS electric energy change correction Sub-Annex 8, paragraph 4.1.1.2. to 4.1.1.5. inclusive	M _{CO₂,CS,p,3} , g/km; M _{CO₂,CS,c,3} , g/km.	3

Status: Point in time view as at 01/06/2017.

Changes to legislation: There are outstanding changes not yet made to Commission Regulation (EU) 2017/1151. Any changes that have already been made to the legislation appear in the content and are referenced with annotations. (See end of Document for details)

Table A8/5

Calculation of final charge-sustaining gaseous emission values

<p>Output from step no. 2 and 3 of this Table.</p>	<p>$M_{i,CS,c,2}$, g/km $M_{CO_2,CS,c,3}$, g/km.</p>	<p>Charge-sustaining mass emission correction for all vehicles equipped with periodically regenerating systems K_i according to Sub-Annex 6, Appendix 1. $M_{i,CS,c,4} = K_i \times M_{i,CS,c,2}$ or $M_{i,CS,c,4} = K_i + M_{i,CS,c,2}$ and $M_{CO_2,CS,c,4} = K_{CO_2,K_i} \times M_{CO_2,CS,c,3}$ or $M_{CO_2,CS,c,4} = K_{CO_2,K_i} + M_{CO_2,CS,c,3}$ Additive offset or multiplicative factor to be used according to K_i determination. If K_i is not applicable: $M_{i,CS,c,4} = M_{i,CS,c,2}$ $M_{CO_2,CS,c,4} = M_{CO_2,CS,c,3}$</p>	<p>$M_{i,CS,c,4}$, g/km. $M_{CO_2,CS,c,4}$, g/km.</p>	<p>4a</p>
<p>Output from step no. 3 and 4a of this Table.</p>	<p>$M_{CO_2,CS,p,3}$, g/km; $M_{CO_2,CS,c,3}$, g/km; $M_{CO_2,CS,c,4}$, g/km.</p>	<p>If K_i is applicable, align CO₂ phase values to combined cycle value: $M_{CO_2,CS,p,4} = M_{CO_2,CS,p,3} \times AF_{K_i}$ for every cycle phase p; where: $AF_{K_i} = \frac{M_{CO_2,c,4}}{M_{CO_2,c,3}}$ If K_i is not applicable: $M_{CO_2,CS,p,4} = M_{CO_2,CS,p,3}$</p>	<p>$M_{CO_2,CS,p,4}$, g/km.</p>	<p>4b</p>
<p>Output from step no. 4 of this Table.</p>	<p>$M_{i,CS,c,4}$, g/km; $M_{CO_2,CS,p,4}$, g/km;</p>	<p>ATCT correction according to paragraph 3.8.2.</p>	<p>$M_{i,CS,c,5}$, g/km; $M_{CO_2,CS,c,5}$, g/km;</p>	<p>5 'result of a single test'</p>

Status: Point in time view as at 01/06/2017.

Changes to legislation: There are outstanding changes not yet made to Commission Regulation (EU) 2017/1151. Any changes that have already been made to the legislation appear in the content and are referenced with annotations. (See end of Document for details)

Table A8/5

Calculation of final charge-sustaining gaseous emission values

	$M_{CO_2,CS,c,4}$, g/km;	of Sub-Annex 6a. Deterioration factors calculated and applied according to Annex VII	$M_{CO_2,CS,p,5}$, g/km.	
Output from step no. 5 of this Table.	For every test: $M_{i,CS,c,5}$, g/km; $M_{CO_2,CS,c,5}$, g/km; $M_{CO_2,CS,p,5}$, g/km	Averaging of tests and declared value according to paragraph 1.1.2. to 1.1.2.3. inclusive of Sub-Annex 6.	$M_{i,CS,c,6}$, g/km; $M_{CO_2,CS,c,6}$, g/km; $M_{CO_2,CS,p,6}$, g/km; $M_{CO_2,CS,c,declared}$, g/km.	6 ' $M_{i,CS}$ results of a Type 1 test for a test vehicle'
Output from step no. 6 of this Table.	$M_{CO_2,CS,c,6}$, g/km; $M_{CO_2,CS,p,6}$, g/km; $M_{CO_2,CS,c,declared}$, g/km.	Alignment of phase values. Sub-Annex 6, paragraph 1.1.2.4. And: $M_{CO_2,CS,c,7} = M_{CO_2,CS,c,declared}$	$M_{CO_2,CS,c,7}$, g/km; $M_{CO_2,CS,p,7}$, g/km;	7 ' $M_{CO_2,CS}$ results of a Type 1 test for a test vehicle'
Output from step no. 6 and 7 of this Table.	For each of the test vehicles H and L: $M_{i,CS,c,6}$, g/km; $M_{CO_2,CS,c,7}$, g/km; $M_{CO_2,CS,p,7}$, g/km;	If in addition to a test vehicle H a test vehicle L was also tested, the resulting criteria emission value shall be the highest of the two values and referred to as $M_{i,CS,c}$ In the case of the combined THC+NO _x emissions, the highest value of the sum referring to either the VH or VL is to be used. Otherwise, if no vehicle L was tested, $M_{i,CS,c} = M_{i,CS,c,6}$	$M_{i,CS,c}$, g/km; $M_{CO_2,CS,c,H}$, g/km; $M_{CO_2,CS,p,H}$, g/km; and if a vehicle L was tested: $M_{CO_2,CS,c,L}$, g/km; $M_{CO_2,CS,p,L}$, g/km;	8 'inter-polation family result' final criteria emission result

Status: Point in time view as at 01/06/2017.

Changes to legislation: There are outstanding changes not yet made to Commission Regulation (EU) 2017/1151. Any changes that have already been made to the legislation appear in the content and are referenced with annotations. (See end of Document for details)

Table A8/5

Calculation of final charge-sustaining gaseous emission values

		For CO ₂ the values derived in step 7 of this Table shall be used. CO ₂ values shall be rounded to two decimal places.		
Output from step no. 8 of this Table.	M _{CO₂,CS,c,H} , g/km; M _{CO₂,CS,p,H} , g/km; and if a vehicle L was tested: M _{CO₂,CS,c,L} , g/km; M _{CO₂,CS,p,L} , g/km;	CO ₂ mass emission calculation according to paragraph 4.5.4.1. of this Sub-Annex for individual vehicles in an interpolation family. CO ₂ values shall be rounded according to Table A8/2.	M _{CO₂,CS,c,ind} , g/km; M _{CO₂,CS,p,ind} , g/km;	9 'result of an individual vehicle' final CO ₂ result

4.1.1.2. In the case that the correction according to paragraph 1.1.4. of Appendix 2 to this Sub-Annex was not applied, the following charge-sustaining CO₂ mass emission shall be used:

$$M_{CO_2,CS} = M_{CO_2,CS,nb}$$

where:

M_{CO₂,CS} is the charge-sustaining CO₂ mass emission of the charge-sustaining Type 1 test according to Table A8/5, step no. 3, g/km;
 M_{CO₂,CS,nb} is the non-balanced charge-sustaining CO₂ mass emission of the charge-sustaining Type 1 test, not corrected for the energy balance, determined according to Table A8/5, step no. 2, g/km.

4.1.1.3. If the correction of the charge-sustaining CO₂ mass emission is required according to paragraph 1.1.3. of Appendix 2 to this Sub-Annex or in the case that the correction according to paragraph 1.1.4. of Appendix 2 to this Sub-Annex was applied, the CO₂ mass emission correction coefficient shall be determined according to paragraph 2. of Appendix 2 to this Sub-Annex. The corrected charge-sustaining CO₂ mass emission shall be determined using the following equation:

$$M_{CO_2,CS} = M_{CO_2,CS,nb} - K_{CO_2} \times EC_{DC,CS}$$

where:

Status: Point in time view as at 01/06/2017.

Changes to legislation: There are outstanding changes not yet made to Commission Regulation (EU) 2017/1151. Any changes that have already been made to the legislation appear in the content and are referenced with annotations. (See end of Document for details)

$M_{CO_2,CS}$	is the charge-sustaining CO ₂ mass emission of the charge-sustaining Type 1 test according to Table A8/5, step no. 2, g/km;
$M_{CO_2,CS,nb}$	is the non-balanced CO ₂ mass emission of the charge-sustaining Type 1 test, not corrected for the energy balance, determined according to Table A8/5, step no. 2, g/km;
$EC_{DC,CS}$	is the electric energy consumption of the charge-sustaining Type 1 test according to paragraph 4.3. of this Sub-Annex, Wh/km;
K_{CO_2}	is the CO ₂ mass emission correction coefficient according to paragraph 2.3.2. of Appendix 2 to this Sub-Annex, (g/km)/(Wh/km).

4.1.1.4. In the case that phase-specific CO₂ mass emission correction coefficients have not been determined, the phase-specific CO₂ mass emission shall be calculated using the following equation:

$$M_{CO_2,CS,p} = M_{CO_2,CS,nb,p} - K_{CO_2} \times EC_{DC,CS,p}$$

where:

$M_{CO_2,CS,p}$	is the charge-sustaining CO ₂ mass emission of phase p of the charge-sustaining Type 1 test according to Table A8/5, step no. 2, g/km;
$M_{CO_2,CS,nb,p}$	is the non-balanced CO ₂ mass emission of phase p of the charge-sustaining Type 1 test, not corrected for the energy balance, determined according to Table A8/5, step no. 2, g/km;
$EC_{DC,CS,p}$	is the electric energy consumption of phase p of the charge-sustaining Type 1 test according to paragraph 4.3. of this Sub-Annex, Wh/km;
K_{CO_2}	is the CO ₂ mass emission correction coefficient according to paragraph 2.3.2. of Appendix 2 to this Sub-Annex, (g/km)/(Wh/km).

4.1.1.5. In the case that phase-specific CO₂ mass emission correction coefficients have been determined, the phase-specific CO₂ mass emission shall be calculated using the following equation:

$$M_{CO_2,CS,p} = M_{CO_2,CS,nb,p} - K_{CO_2,p} \times EC_{DC,CS,p}$$

where:

$M_{CO_2,CS,p}$	is the charge-sustaining CO ₂ mass emission of phase p of the charge-sustaining Type 1 test according to Table A8/5, step no. 3, g/km;
$M_{CO_2,CS,nb,p}$	is the non-balanced CO ₂ mass emission of phase p of the charge-sustaining Type 1 test, not corrected for the energy balance, determined according to Table A8/5, step no. 2, g/km;
$EC_{DC,CS,p}$	is the electric energy consumption of phase p of the charge-sustaining Type 1 test, determined according to paragraph 4.3. of this Sub-Annex, Wh/km;
$K_{CO_2,p}$	is the CO ₂ mass emission correction coefficient according to paragraph 2.3.2.2. of Appendix 2 to this Sub-Annex, (g/km)/(Wh/km);
p	is the index of the individual phase within the applicable WLTP test cycle.

4.1.2. Utility factor-weighted charge-depleting CO₂ mass emission for OVC-HEVs

The utility factor-weighted charge-depleting CO₂ mass emission $M_{CO_2,CD}$ shall be calculated using the following equation:

$$M_{CO_2,CD} = \frac{\sum_{j=1}^{j-1} (UF_j \times M_{CO_2,CD,j})}{\sum_{j=1}^{j-1} UF_j}$$

where:

Status: Point in time view as at 01/06/2017.

Changes to legislation: There are outstanding changes not yet made to Commission Regulation (EU) 2017/1151. Any changes that have already been made to the legislation appear in the content and are referenced with annotations. (See end of Document for details)

$M_{CO_2,CD}$	is the utility factor-weighted charge-depleting CO ₂ mass emission, g/km;
$M_{CO_2,CD,j}$	is the CO ₂ mass emission determined according to paragraph 3.2.1. of Sub-Annex 7 of phase j of the charge-depleting Type 1 test, g/km;
UF_j	is the utility factor of phase j according to Appendix 5 of this Sub-Annex;
j	is the index number of the phase considered;
k	is the number of phases driven up to the end of the transition cycle according to paragraph 3.2.4.4. of this Sub-Annex.

In the case that the interpolation approach is applied, k shall be the number of phases driven up to the end of the transition cycle of vehicle L n_{veh_L} .

If the transition cycle number driven by vehicle H,

n_{veh_H}

, and, if applicable, an individual vehicle within the vehicle interpolation family,

$n_{veh_{int}}$

, is lower than the transition cycle number driven by vehicle L,

n_{veh_L}

, the confirmation cycle of vehicle H and, if applicable, an individual vehicle shall be included in the calculation. The CO₂ mass emission of each phase of the confirmation cycle shall then be corrected to an electric energy consumption of zero $EC_{DC,CD,j} = 0$ by using the CO₂ correction coefficient according to Appendix 2 of this Sub-Annex.

4.1.3. Utility factor-weighted mass emissions of gaseous compounds, particulate matter emission and particle number emission for OVC-HEVs.

4.1.3.1. The utility factor-weighted mass emission of gaseous compounds shall be calculated using the following equation:

$$M_{i,weighted} = \sum_{j=1}^k (UF_j \times M_{i,CD,j}) + \left(1 - \sum_{j=1}^k UF_j\right) \times M_{i,CS}$$

where:

$M_{i,weighted}$	is the utility factor-weighted mass emission compound i, g/km;
i	is the index of the considered gaseous emission compound;
UF_j	is the utility factor of phase j according to Appendix 5 of this Sub-Annex;
$M_{i,CD,j}$	is the mass emission of the gaseous emission compound i determined according to paragraph 3.2.1. of Sub-Annex 7 of phase j of the charge-depleting Type 1 test, g/km;
$M_{i,CS}$	is the charge-sustaining mass emission of gaseous emission compound i for the charge-sustaining Type 1 test according to Table A8/5, step no. 7, g/km;
j	is the index number of the phase considered;
k	is the number of phases driven until the end of the transition cycle according to paragraph 3.2.4.4. of this Sub-Annex.

In the case that the interpolation approach is applied, k shall be the number of phases driven up to the end of the transition cycle of vehicle L n_{veh_L} .

If the transition cycle number driven by vehicle H,

n_{veh_H}

, and, if applicable, an individual vehicle within the vehicle interpolation family,

$n_{veh_{int}}$

Status: Point in time view as at 01/06/2017.

Changes to legislation: There are outstanding changes not yet made to Commission Regulation (EU) 2017/1151. Any changes that have already been made to the legislation appear in the content and are referenced with annotations. (See end of Document for details)

, is lower than the transition cycle number driven by vehicle L, n_{veh_L} , the confirmation cycle of vehicle H and, if applicable, an individual vehicle shall be included in the calculation. The CO₂ mass emission of each phase of the confirmation cycle shall then be corrected to an electric energy consumption of zero

$$EC_{DC,CDj} = 0$$

by using the CO₂ correction coefficient according to Appendix 2 of this Sub-Annex.

4.1.3.2. The utility factor-weighted particle number emission shall be calculated using the following equation:

$$PN_{weighted} = \sum_{j=1}^k (UF_j \times PN_{CDj}) + (1 - \sum_{j=1}^k UF_j) \times PN_{CS}$$

where:

$PN_{weighted}$	is the utility factor-weighted particle number emission, particles per kilometre;
UF_j	is the utility factor of phase j according to Appendix 5 of this Sub-Annex;
PN_{CDj}	is the particle number emission during phase j determined according to paragraph 4. of Sub-Annex 7 for the charge-depleting Type 1 test, particles per kilometre;
PN_{CS}	is the particle number emission determined according to paragraph 4.1.1. of this Sub-Annex for the charge-sustaining Type 1 test, particles per kilometre;
j	is the index number of the phase considered;
k	is the number of phases driven until the end of transition cycle n according to paragraph 3.2.4.4. of this Sub-Annex.

4.1.3.3. The utility factor-weighted particulate matter emission shall be calculated using the following equation:

$$PM_{weighted} = \sum_{c=1}^{n_c} (UF_c \times PM_{CD,c}) + (1 - \sum_{c=1}^{n_c} UF_c) \times PM_{CS}$$

where:

$PM_{weighted}$	is the utility factor-weighted particulate matter emission, mg/km;
UF_c	is the utility factor of cycle c according to Appendix 5 of this Sub-Annex;
$PM_{CD,c}$	is the charge-depleting particulate matter emission during cycle c determined according to paragraph 3.3. of Sub-Annex 7 for the charge-depleting Type 1 test, mg/km;
PM_{CS}	is the particulate matter emission of the charge-sustaining Type 1 test according to paragraph 4.1.1. of this Sub-Annex, mg/km;
c	is the index number of the cycle considered;
n_c	is the number of applicable WLTP test cycles driven until the end of the transition cycle n according to paragraph 3.2.4.4. of this Sub-Annex.

4.2. Calculation of fuel consumption

4.2.1. Charge-sustaining fuel consumption for OVC-HEVs, NOVC-HEVs and NOVC-FCHVs

4.2.1.1. The charge-sustaining fuel consumption for OVC-HEVs and NOVC-HEVs shall be calculated stepwise according to Table A8/6.

Status: Point in time view as at 01/06/2017.

Changes to legislation: There are outstanding changes not yet made to Commission Regulation (EU) 2017/1151. Any changes that have already been made to the legislation appear in the content and are referenced with annotations. (See end of Document for details)

TABLE A8/6

Calculation of final charge-sustaining fuel consumption for OVC-HEVs, NOVC-HEVs

Source	Input	Process	Output	Step no.
Output from step no. 6 and 7 of Table A8/5 of this Sub-Annex.	$M_{i,CS,c,6}$, g/km; $M_{CO_2,CS,c,7}$, g/km; $M_{CO_2,CS,p,7}$, g/km;	Calculation of fuel consumption according to paragraph 6. of Sub-Annex 7. The calculation of fuel consumption shall be performed separately for the applicable cycle and its phases. For that purpose: (a) the applicable phase or cycle CO_2 values shall be used; (b) the criteria emission over the complete cycle shall be used.	$FC_{CS,c,1}$, l/100 km; $FC_{CS,p,1}$, l/100 km;	1 ' FC_{CS} results of a Type 1 test for a test vehicle'
Step no. 1 of this Table.	For each of the test vehicles H and L: $FC_{CS,c,1}$, l/100 km; $FC_{CS,p,1}$, l/100 km;	For FC the values derived in step no. 1 of this Table shall be used. FC values shall be rounded to three decimal places.	$FC_{CS,c,H}$, l/100 km; $FC_{CS,p,H}$, l/100 km; and if a vehicle L was tested: $FC_{CS,c,L}$, l/100 km; $FC_{CS,p,L}$, l/100 km;	2 'interpolation family result' final criteria emission result
Step no. 2 of this Table.	$FC_{CS,c,H}$, l/100 km; $FC_{CS,p,H}$, l/100 km;	Fuel consumption calculation according to	$FC_{CS,c,ind}$, l/100 km; $FC_{CS,p,ind}$, l/100 km;	3 'result of an individual vehicle'

Status: Point in time view as at 01/06/2017.

Changes to legislation: There are outstanding changes not yet made to Commission Regulation (EU) 2017/1151. Any changes that have already been made to the legislation appear in the content and are referenced with annotations. (See end of Document for details)

	and if a vehicle L was tested: FC _{CS,c,L} , l/100 km; FC _{CS,p,L} , l/100 km;	paragraph 4.5.5.1. of this Sub-Annex for individual vehicles in an interpolation family. FC values shall be rounded according to Table A8/2.		final FC result
--	--	--	--	-----------------

4.2.1.2. Charge-sustaining fuel consumption for NOVC-FCHVs

4.2.1.2.1. Stepwise prescription for calculating the final test fuel consumption results of the charge-sustaining Type 1 test for NOVC-FCHVs

The results shall be calculated in the order described in the Tables A8/7. All applicable results in the column ‘Output’ shall be recorded. The column ‘Process’ describes the paragraphs to be used for calculation or contains additional calculations.

For the purpose of this table, the following nomenclature within the equations and results is used:

- c : complete applicable test cycle;
- p : every applicable cycle phase;
- CS : charge-sustaining

TABLE A8/7

Calculation of final charge-sustaining fuel consumption for NOVC-FCHVs

Source	Input	Process	Output	Step no.
Appendix 7 of this Sub-Annex.	Non-balanced charge-sustaining fuel consumption FC _{CS,nb} , kg/100 km	Charge-sustaining fuel consumption according to paragraph 2.2.6. of Appendix 7. to this Sub-Annex	FC _{CS,c,1} , kg/100 km;	1
Output from step no. 1 of this Table.	FC _{CS,c,1} , kg/100 km;	REESS electric energy change correction Sub-Annex 8, paragraphs 4.2.1.2.2. to 4.2.1.2.3. inclusive of this Sub-Annex	FC _{CS,c,2} , kg/100 km;	2
Output from step no. 2 of this Table.	FC _{CS,c,2} , kg/100 km;	ATCT correction according to paragraph 3.8.2.	FC _{CS,c,3} , kg/100 km;	3 ‘result of a single test’

Status: Point in time view as at 01/06/2017.

Changes to legislation: There are outstanding changes not yet made to Commission Regulation (EU) 2017/1151. Any changes that have already been made to the legislation appear in the content and are referenced with annotations. (See end of Document for details)

		of Sub-Annex 6a. Deterioration factors calculated according to Annex VII.		
Output from step no. 3 of this Table.	For every test: $FC_{CS,c,3}$, kg/100 km;	Averaging of tests and declared value according to paragraphs 1.1.2. to 1.1.2.3. inclusive of Sub-Annex 6.	$FC_{CS,c,4}$, kg/100 km;	4
Output from step no. 4 of this Table.	$FC_{CS,c,4}$, kg/100 km; $FC_{CS,c,declared}$, kg/100 km	Alignment of phase values. Sub-Annex 6, paragraph 1.1.2.4. And: $FC_{CS,c,5} = FC_{CS,c,declared}$	$FC_{CS,c,5}$, kg/100 km;	5 ' FC_{CS} results of a Type 1 test for a test vehicle'

4.2.1.2.2. In the case that the correction according to paragraph 1.1.4. of Appendix 2 to this Sub-Annex was not applied, the following charge-sustaining fuel consumption shall be used:

$$FC_{CS} = FC_{CS,nb}$$

where:

FC_{CS} is the charge-sustaining fuel consumption of the charge-sustaining Type 1 test according to Table A8/7, step no. 2, kg/100 km;
 $FC_{CS,nb}$ is the non-balanced charge-sustaining fuel consumption of the charge-sustaining Type 1 test, not corrected for the energy balance, according to Table A8/7, step no. 1, kg/100 km.

4.2.1.2.3. If the correction of the fuel consumption is required according to paragraph 1.1.3. of Appendix 2 to this Sub-Annex or in the case that the correction according to paragraph 1.1.4. of Appendix 2 to this Sub-Annex was applied, the fuel consumption correction coefficient shall be determined according to paragraph 2. of Appendix 2 to this Sub-Annex. The corrected charge-sustaining fuel consumption shall be determined using the following equation:

$$FC_{CS} = FC_{CS,nb} - K_{fuel,FCHV} \times EC_{DC,CS}$$

where:

FC_{CS} is the charge-sustaining fuel consumption of the charge-sustaining Type 1 test according to Table A8/7, step no. 2, kg/100 km;
 $FC_{CS,nb}$ is the non-balanced fuel consumption of the charge-sustaining Type 1 test, not corrected for the energy balance, according to Table A8/7, step no. 1, kg/100 km;

Status: Point in time view as at 01/06/2017.

Changes to legislation: There are outstanding changes not yet made to Commission Regulation (EU) 2017/1151. Any changes that have already been made to the legislation appear in the content and are referenced with annotations. (See end of Document for details)

$EC_{DC,CS}$ is the electric energy consumption of the charge-sustaining Type 1 test according to paragraph 4.3. of this Sub-Annex, Wh/km;
 $K_{fuel,FCHV}$ is the fuel consumption correction coefficient according to paragraph 2.3.1. of Appendix 2 to this Sub-Annex, (kg/100 km)/(Wh/km).

4.2.2. Utility factor-weighted charge-depleting fuel consumption for OVC-HEVs

The utility factor-weighted charge-depleting fuel consumption FC_{CD} shall be calculated using the following equation:

$$FC_{CD} = \frac{\sum_{k=1}^{j-1} (UF_j \times FC_{CDj})}{\sum_{k=1}^{j-1} UF_j}$$

where:

FC_{CD} is the utility factor weighted charge-depleting fuel consumption, l/100 km;
 $FC_{CD,j}$ is the fuel consumption for phase j of the charge-depleting Type 1 test, determined according to paragraph 6. of Sub-Annex 7, l/100 km;
 UF_j is the utility factor of phase j according to Appendix 5 of this Sub-Annex;
j is the index number of the phase considered;
k is the number of phases driven up to the end of the transition cycle according to paragraph 3.2.4.4 of this Sub-Annex.

In the case that the interpolation approach is applied, k shall be the number of phases driven up to the end of the transition cycle of vehicle L n_{veh_L} .

If the transition cycle number driven by vehicle H,

n_{veh_H}

, and, if applicable, an individual vehicle within the vehicle interpolation family,

$n_{veh_{ind}}$

, is lower than the transition cycle number driven by vehicle L n_{veh_L} the confirmation cycle of vehicle H and, if applicable, an individual vehicle shall be included in the calculation. The fuel consumption of each phase of the confirmation cycle shall then be corrected to an electric energy consumption of zero,

$EC_{DC,CDj} = 0$

, by using the fuel consumption correction coefficient according to Appendix 2 of this Sub-Annex.

4.2.3. Utility factor-weighted fuel consumption for OVC-HEVs

The utility factor-weighted fuel consumption from the charge-depleting and charge-sustaining Type 1 test shall be calculated using the following equation:

$$FC_{weighted} = \sum_{j=1}^k (UF_j \times FC_{CDj}) + \left(1 - \sum_{j=1}^k UF_j\right) \times FC_{CS}$$

where:

$FC_{weighted}$ is the utility factor-weighted fuel consumption, l/100 km;
 UF_j is the utility factor of phase j according to Appendix 5 of this Sub-Annex;
 $FC_{CD,j}$ is the fuel consumption of phase j of the charge-depleting Type 1 test, determined according to paragraph 6. of Sub-Annex 7, l/100 km;
 FC_{CS} is the fuel consumption determined according to Table A8/6, step no. 1, l/100 km;
j is the index number of the phase considered;

Status: Point in time view as at 01/06/2017.

Changes to legislation: There are outstanding changes not yet made to Commission Regulation (EU) 2017/1151. Any changes that have already been made to the legislation appear in the content and are referenced with annotations. (See end of Document for details)

k is the number of phases driven up to the end of the transition cycle according to paragraph 3.2.4.4. of this Sub-Annex.

In the case that the interpolation approach is applied, k shall be the number of phases driven up to the end of the transition cycle of vehicle L n_{veh_L} .

If the transition cycle number driven by vehicle H,

n_{veh_H}

, and, if applicable, an individual vehicle within the vehicle interpolation family,

$n_{veh_{ind}}$

, is lower than the transition cycle number driven by vehicle L, n_{veh_L} , the confirmation cycle of vehicle H and, if applicable, an individual vehicle shall be included in the calculation. The fuel consumption of each phase of the confirmation cycle shall then be corrected to an electric energy consumption of zero

$EC_{DC,CDj} = 0$

by using the fuel consumption correction coefficient according to Appendix 2 of this Sub-Annex.

4.3. Calculation of electric energy consumption

For the determination of the electric energy consumption based on the current and voltage determined according to Appendix 3 of this Sub-Annex, the following equations shall be used:

$$EC_{DC,j} = \frac{\Delta E_{REESS,j}}{d_j}$$

where:

$EC_{DC,j}$ is the electric energy consumption over the considered period j based on the REESS depletion, Wh/km;

$\Delta E_{REESS,j}$ is the electric energy change of all REESSs during the considered period j, Wh;

d_j is the distance driven in the considered period j, km;

and

$$\Delta E_{REESS,j} = \sum_{i=1}^n \Delta E_{REESS,j,i}$$

where:

$\Delta E_{REESS,j,i}$: is the electric energy change of REESS i during the considered period j, Wh;

and

$$\Delta E_{REESS,j,i} = \frac{1}{3600} \times \int_{t_0}^{t_{end}} U(t)_{REESS,j,i} \times I(t)_{j,i} dt$$

where:

$U(t)_{REESS,j,i}$ is the voltage of REESS i during the considered period j determined according to Appendix 3 to this Sub-Annex, V;

t_0 is the time at the beginning of the considered period j, s;

t_{end} is the time at the end of the considered period j, s;

$I(t)_{j,i}$ is the electric current of REESS i during the considered period j determined according to Appendix 3 to this Sub-Annex, A;

i is the index number of the considered REESS;

n is the total number of REESS;

j is the index for the considered period, where a period can be any combination of phases or cycles;

Status: Point in time view as at 01/06/2017.

Changes to legislation: There are outstanding changes not yet made to Commission Regulation (EU) 2017/1151. Any changes that have already been made to the legislation appear in the content and are referenced with annotations. (See end of Document for details)

$\frac{1}{3600}$

is the conversion factor from Ws to Wh.

4.3.1. Utility factor-weighted charge-depleting electric energy consumption based on the recharged electric energy from the mains for OVC-HEVs

The utility factor-weighted charge-depleting electric energy consumption based on the recharged electric energy from the mains shall be calculated using the following equation:

$$EC_{AC,CD} = \frac{\sum_{j=1}^{j-1} (UF_j \times EC_{AC,CD,j})}{\sum_{j=1}^{j-1} UF_j}$$

where:

$EC_{AC,CD}$ is the utility factor-weighted charge-depleting electric energy consumption based on the recharged electric energy from the mains, Wh/km;

UF_j is the utility factor of phase j according to Appendix 5 to this Sub-Annex;

$EC_{AC,CD,j}$ is the electric energy consumption based on the recharged electric energy from the mains of phase j, Wh/km;

and

$$EC_{AC,CD,j} = EC_{DC,CD,j} \times \frac{E_{AC}}{\sum_{k=1}^{k-1} \Delta E_{REESS,j}}$$

where:

$EC_{DC,CD,j}$ is the electric energy consumption based on the REESS depletion of phase j of the charge-depleting Test 1 according to paragraph 4.3. of this Sub-Annex, Wh/km;

E_{AC} is the recharged electric energy from the mains determined according to paragraph 3.2.4.6. of this Sub-Annex, Wh;

$\Delta E_{REESS,j}$ is the electric energy change of all REESSs of phase j according to paragraph 4.3. of this Sub-Annex, Wh;

j is the index number of the phase considered;

k is the number of phases driven up to the end of the transition cycle of vehicle L, n_{veh_L} , according to paragraph 3.2.4.4. of this Sub-Annex.

4.3.2. Utility factor-weighted electric energy consumption based on the recharged electric energy from the mains for OVC-HEVs

The utility factor-weighted electric energy consumption based on the recharged electric energy from the mains shall be calculated using the following equation:

$$EC_{AC,weighted} = \sum_{j=1}^k (UF_j \times EC_{AC,CD,j})$$

where:

$EC_{AC,weighted}$ is the utility factor-weighted electric energy consumption based on the recharged electric energy from the mains, Wh/km;

UF_j is the utility factor of phase j according to Appendix 5 of this Sub-Annex;

$EC_{AC,CD,j}$ is the electric energy consumption based on the recharged electric energy from the mains of phase j according to paragraph 4.3.1. of this Sub-Annex, Wh/km;

j is the index number of the phase considered;

k is the number of phases driven up to the end of the transition cycle of vehicle L, n_{veh_L} according to paragraph 3.2.4.4. of this Sub-Annex.

Status: Point in time view as at 01/06/2017.

Changes to legislation: There are outstanding changes not yet made to Commission Regulation (EU) 2017/1151. Any changes that have already been made to the legislation appear in the content and are referenced with annotations. (See end of Document for details)

4.3.3. Electric energy consumption for OVC-HEVs

4.3.3.1. Determination of cycle-specific electric energy consumption

The electric energy consumption based on the recharged electric energy from the mains and the equivalent all-electric range shall be calculated using the following equation:

$$EC = \frac{E_{AC}}{EAER}$$

where:

- EC is the electric energy consumption of the applicable WLTP test cycle based on the recharged electric energy from the mains and the equivalent all-electric range, Wh/km;
- E_{AC} is the recharged electric energy from the mains according to paragraph 3.2.4.6. of this Sub-Annex, Wh;
- EAER is the equivalent all-electric range according to paragraph 4.4.4.1. of this Sub-Annex, km.

4.3.3.2. Determination of phase-specific electric energy consumption

The phase-specific electric energy consumption based on the recharged electric energy from the mains and the phase-specific equivalent all-electric range shall be calculated using the following equation:

$$EC_p = \frac{E_{AC}}{EAER_p}$$

where:

- EC_p : is the phase-specific electric energy consumption based on the recharged electric energy from the mains and the equivalent all-electric range, Wh/km;
- E_{AC} : is the recharged electric energy from the mains according to paragraph 3.2.4.6. of this Sub-Annex, Wh;
- $EAER_p$: is the phase-specific equivalent all-electric range according to paragraph 4.4.4.2. of this Sub-Annex, km.

4.3.4. Electric energy consumption of PEVs

4.3.4.1. The electric energy consumption determined in this paragraph shall be calculated only if the vehicle was able to follow the applicable test cycle within the speed trace tolerances according to paragraph 1.2.6.6. of Sub-Annex 6 during the entire considered period.

4.3.4.2. Electric energy consumption determination of the applicable WLTP test cycle

The electric energy consumption of the applicable WLTP test cycle based on the recharged electric energy from the mains and the pure electric range shall be calculated using the following equation:

$$EC_{WLTC} = \frac{E_{AC}}{PER_{WLTC}}$$

where:

- EC_{WLTC} is the electric energy consumption of the applicable WLTP test cycle based on the recharged electric energy from the mains and the pure electric range for the applicable WLTP test cycle, Wh/km;
- E_{AC} is the recharged electric energy from the mains according to paragraph 3.4.4.3. of this Sub-Annex, Wh;

Status: Point in time view as at 01/06/2017.

Changes to legislation: There are outstanding changes not yet made to Commission Regulation (EU) 2017/1151. Any changes that have already been made to the legislation appear in the content and are referenced with annotations. (See end of Document for details)

PER_{WLTC} is the pure electric range for the applicable WLTP test cycle as calculated according to paragraph 4.4.2.1.1. or paragraph 4.4.2.2.1. of this Sub-Annex, depending on the PEV test procedure that must be used, km.

4.3.4.3. Electric energy consumption determination of the applicable WLTP city test cycle

The electric energy consumption of the applicable WLTP city test cycle based on the recharged electric energy from the mains and the pure electric range for the applicable WLTP city test cycle shall be calculated using the following equation:

$$EC_{city} = \frac{E_{AC}}{PER_{city}}$$

where:

EC_{city} is the electric energy consumption of the applicable WLTP city test cycle based on the recharged electric energy from the mains and the pure electric range for the applicable WLTP city test cycle, Wh/km;

E_{AC} is the recharged electric energy from the mains according to paragraph 3.4.4.3. of this Sub-Annex, Wh;

PER_{city} is the pure electric range for the applicable WLTP city test cycle as calculated according to paragraph 4.4.2.1.2. or paragraph 4.4.2.2.2. of this Sub-Annex, depending on the PEV test procedure that must be used, km.

4.3.4.4. Electric energy consumption determination of the phase-specific values

The electric energy consumption of each individual phase based on the recharged electric energy from the mains and the phase-specific pure electric range shall be calculated using the following equation:

$$EC_p = \frac{E_{AC}}{PER_p}$$

where:

EC_p is the electric energy consumption of each individual phase p based on the recharged electric energy from the mains and the phase-specific pure electric range, Wh/km

E_{AC} is the recharged electric energy from the mains according to paragraph 3.4.4.3. of this Sub-Annex, Wh;

PER_p is the phase-specific pure electric range as calculated according to paragraph 4.4.2.1.3. or paragraph 4.4.2.2.3. of this Sub-Annex, depending on the PEV test procedure used, km.

4.4. Calculation of electric ranges

4.4.1. All-electric ranges AER and AER_{city} for OVC-HEVs

4.4.1.1. All-electric range AER

The all-electric range AER for OVC-HEVs shall be determined from the charge-depleting Type 1 test described in paragraph 3.2.4.3. of this Sub-Annex as part of the Option 1 test sequence and is referenced in paragraph 3.2.6.1. of this Sub-Annex as part of the Option 3 test sequence by driving the applicable WLTP test cycle according to paragraph 1.4.2.1. of this Sub-Annex. The AER is defined as the distance driven from the beginning of the charge-depleting Type 1 test to the point in time where the combustion engine starts consuming fuel.

4.4.1.2. All-electric range city AER_{city}

Status: Point in time view as at 01/06/2017.

Changes to legislation: There are outstanding changes not yet made to Commission Regulation (EU) 2017/1151. Any changes that have already been made to the legislation appear in the content and are referenced with annotations. (See end of Document for details)

4.4.1.2.1. The all-electric range city AER_{city} for OVC-HEVs shall be determined from the charge-depleting Type 1 test described in paragraph 3.2.4.3. of this Sub-Annex as part of the Option 1 test sequence and is referenced in paragraph 3.2.6.1. of this Sub-Annex as part of the Option 3 test sequence by driving the applicable WLTP city test cycle according to paragraph 1.4.2.2. of this Sub-Annex. The AER_{city} is defined as the distance driven from the beginning of the charge-depleting Type 1 test to the point in time where the combustion engine starts consuming fuel.

4.4.1.2.2. As an alternative to paragraph 4.4.1.2.1. of this Sub-Annex, the all-electric range city AER_{city} may be determined from the charge-depleting Type 1 test described in paragraph 3.2.4.3. of this Sub-Annex by driving the applicable WLTP test cycles according to paragraph 1.4.2.1. of this Sub-Annex. In that case, the charge-depleting Type 1 test by driving the applicable WLTP city test cycle shall be omitted and the all-electric range city AER_{city} shall be calculated using the following equation:

$$AER_{city} = \frac{UBE_{city}}{EC_{DC,city}}$$

where:

UBE_{city} is the usable REESS energy determined from the beginning of the charge-depleting Type 1 test described in paragraph 3.2.4.3. of this Sub-Annex by driving applicable WLTP test cycles until the point in time where the combustion engine starts consuming fuel, Wh;

$EC_{DC,city}$ is the weighted electric energy consumption of the pure electrically driven applicable WLTP city test cycles of the charge-depleting Type 1 test described in paragraph 3.2.4.3. of this Sub-Annex by driving applicable WLTP test cycle(s), Wh/km;

and

$$UBE_{city} = \sum_{j=1}^K \Delta E_{REESS,j}$$

where:

$\Delta E_{REESS,j}$ is the electric energy change of all REESSs during phase j, Wh;

j is the index number of the phase considered;

K is the number of the phases driven from the beginning of the test up to and excluding the phase where the combustion engine starts consuming fuel;

and

$$EC_{DC,city} = \sum_{j=1}^{n_{city,DC}} EC_{DC,city,j} \times K_{city,j}$$

where:

$EC_{DC,city,j}$ is the electric energy consumption for the jth pure electrically driven WLTP city test cycle of the charge-depleting Type 1 test according to paragraph 3.2.4.3. of this Sub-Annex by driving applicable WLTP test cycles, Wh/km;

$K_{city,j}$ is the weighting factor for the jth pure electrically driven applicable WLTP city test cycle of the charge-depleting Type 1 test according to paragraph 3.2.4.3. of this Sub-Annex by driving applicable WLTP test cycles;

j is the index number of the pure electrically driven applicable WLTP city test cycle considered;

Status: Point in time view as at 01/06/2017.

Changes to legislation: There are outstanding changes not yet made to Commission Regulation (EU) 2017/1151. Any changes that have already been made to the legislation appear in the content and are referenced with annotations. (See end of Document for details)

$n_{\text{city,pe}}$ is the number of pure electrically driven applicable WLTP city test cycles;

and

$$K_{\text{city},1} = \frac{\Delta E_{\text{REESS,city},1}}{UBE_{\text{city}}}$$

where:

$\Delta E_{\text{REESS,city},1}$ is the electric energy change of all REESSs during the first applicable WLTP city test cycle of the charge-depleting Type 1 test, Wh;

and

$$K_{\text{city},j} = \frac{1 - K_{\text{city},1}}{n_{\text{city,pe}} - 1} \text{ for } j = 2 \text{ to } n_{\text{city,pe}}$$

4.4.2. Pure electric range for PEVs

The ranges determined in this paragraph shall only be calculated if the vehicle was able to follow the applicable WLTP test cycle within the speed trace tolerances according to paragraph 1.2.6.6. of Sub-Annex 6 during the entire considered period.

4.4.2.1. Determination of the pure electric ranges when the shortened Type 1 test procedure is applied

4.4.2.1.1. The pure -electric range for the applicable WLTP test cycle PER_{WLTC} for PEVs shall be calculated from the shortened Type 1 test as described in paragraph 3.4.4.2. of this Sub-Annex using the following equations:

$$PER_{\text{WLTC}} = \frac{UBE_{\text{STP}}}{EC_{\text{DC,WLTC}}}$$

where:

UBE_{STP} is the usable REESS energy determined from the beginning of the shortened Type 1 test procedure until the break-off criterion as defined in paragraph 3.4.4.2.3. of this Sub-Annex is reached, Wh;

$EC_{\text{DC,WLTC}}$ is the weighted electric energy consumption for the applicable WLTP test cycle of DS_1 and DS_2 of the shortened Type 1 test procedure Type 1 test, Wh/km;

and

$$UBE_{\text{STP}} = \Delta E_{\text{REESS,DS}_1} + \Delta E_{\text{REESS,DS}_2} + \Delta E_{\text{REESS,CSS}_M} + \Delta E_{\text{REESS,CSS}_E}$$

where:

$\Delta E_{\text{REESS,DS}_1}$ is the electric energy change of all REESSs during DS_1 of the shortened Type 1 test procedure, Wh;

$\Delta E_{\text{REESS,DS}_2}$ is the electric energy change of all REESSs during DS_2 of the shortened Type 1 test procedure, Wh;

$\Delta E_{\text{REESS,CSS}_M}$ is the electric energy change of all REESSs during CSS_M of the shortened Type 1 test procedure, Wh;

$\Delta E_{\text{REESS,CSS}_E}$ is the electric energy change of all REESSs during CSS_E of the shortened Type 1 test procedure, Wh;

and

$$EC_{\text{DC,WLTC}} = \sum_{j=1}^2 EC_{\text{DC,WLTC},j} \times K_{\text{WLTC},j}$$

where:

Status: Point in time view as at 01/06/2017.

Changes to legislation: There are outstanding changes not yet made to Commission Regulation (EU) 2017/1151. Any changes that have already been made to the legislation appear in the content and are referenced with annotations. (See end of Document for details)

$EC_{DC,WLTC,j}$ is the electric energy consumption for the applicable WLTP test cycle DS_j of the shortened Type 1 test procedure according to paragraph 4.3. of this Sub-Annex, Wh/km;
 $K_{WLTC,j}$ is the weighting factor for the applicable WLTP test cycle of DS_j of the shortened Type 1 test procedure;

and

$$K_{WLTC,1} = \frac{\Delta E_{REESS,WLTC,1}}{UBE_{STP}} \text{ and } K_{WLTC,2} = 1 - K_{WLTC,1}$$

where:

$K_{WLTC,j}$ is the weighting factor for the applicable WLTP test cycle of DS_j of the shortened Type 1 test procedure;
 $\Delta E_{REESS,WLTC,1}$ is the electric energy change of all REESSs during the applicable WLTP test cycle from DS_1 of the shortened Type 1 test procedure, Wh;

4.4.2.1.2. The pure electric range for the applicable WLTP city test cycle PER_{city} for PEVs shall be calculated from the shortened Type 1 test procedure as described in paragraph 3.4.4.2. of this Sub-Annex using the following equations:

$$PER_{city} = \frac{UBE_{STP}}{EC_{DC,city}}$$

where:

UBE_{STP} is the usable REESS energy according to paragraph 4.4.2.1.1. of this Sub-Annex, Wh;
 $EC_{DC,city}$ is the weighted electric energy consumption for the applicable WLTP city test cycle of DS_1 and DS_2 of the shortened Type 1 test procedure, Wh/km;

and

$$EC_{DC,city} = \sum_{j=1}^4 EC_{DC,city,j} \times K_{city,j}$$

where:

$EC_{DC,city,j}$ is the electric energy consumption for the applicable WLTP city test cycle where the first applicable WLTP city test cycle of DS_1 is indicated as $j = 1$, the second applicable WLTP city test cycle of DS_1 is indicated as $j = 2$, the first applicable WLTP city test cycle of DS_2 is indicated as $j = 3$ and the second applicable WLTP city test cycle of DS_2 is indicated as $j = 4$ of the shortened Type 1 test procedure according to paragraph 4.3. of this Sub-Annex, Wh/km;

$K_{city,j}$ is the weighting factor for the applicable WLTP city test cycle where the first applicable WLTP city test cycle of DS_1 is indicated as $j = 1$, the second applicable WLTP city test cycle of DS_1 is indicated as $j = 2$, the first applicable WLTP city test cycle of DS_2 is indicated as $j = 3$ and the second applicable WLTP city test cycle of DS_2 is indicated as $j = 4$,

and

$$K_{city,1} = \frac{\Delta E_{REESS,city,1}}{UBE_{STP}} \text{ and } K_{city,j} = \frac{1 - K_{city,1}}{3} \text{ for } j = 2 \dots 4$$

where:

$\Delta E_{REESS,city,1}$ is the energy change of all REESSs during the first applicable WLTP city test cycle of DS_1 of the shortened Type 1 test procedure, Wh;

Status: Point in time view as at 01/06/2017.

Changes to legislation: There are outstanding changes not yet made to Commission Regulation (EU) 2017/1151. Any changes that have already been made to the legislation appear in the content and are referenced with annotations. (See end of Document for details)

4.4.2.1.3. The phase-specific pure electric-range PER_p for PEVs shall be calculated from the Type 1 test as described in paragraph 3.4.4.2. of this Sub-Annex by using the following equations:

$$PER_p = \frac{UBE_{STP}}{EC_{DC,p}}$$

where:

UBE_{UBE} is the usable REESS energy according to paragraph 4.4.2.1.1. of this Sub-Annex, Wh;

$EC_{DC,p}$ is the weighted electric energy consumption for each individual phase of DS_1 and DS_2 of the shortened Type 1 test procedure, Wh/km;

In the case that phase p = low and phase p = medium, the following equations shall be used:

$$EC_{DC,p} = \sum_{j=1}^4 EC_{DC,p,j} \times K_{p,j}$$

where:

$EC_{DC,p,j}$ is the electric energy consumption for phase p where the first phase p of DS_1 is indicated as $j = 1$, the second phase p of DS_1 is indicated as $j = 2$, the first phase p of DS_2 is indicated as $j = 3$ and the second phase p of DS_2 is indicated as $j = 4$ of the shortened Type 1 test procedure according to paragraph 4.3. of this Sub-Annex, Wh/km;

$K_{p,j}$ is the weighting factor for phase p where the first phase p of DS_1 is indicated as $j = 1$, the second phase p of DS_1 is indicated as $j = 2$, the first phase p of DS_2 is indicated as $j = 3$, and the second phase p of DS_2 is indicated as $j = 4$ of the shortened Type 1 test procedure;

and

$$K_{p,1} = \frac{\Delta E_{REESS,p,1}}{UBE_{STP}} \text{ and } K_{p,j} = \frac{1-K_{p,1}}{3} \text{ for } j = 2 \dots 4$$

where:

$\Delta E_{REESS,p,1}$: is the energy change of all REESSs during the first phase p of DS_1 of the shortened Type 1 test procedure, Wh.

In the case that phase p = high and phase p = extraHigh, the following equations shall be used:

$$EC_{DC,p} = \sum_{j=1}^2 EC_{DC,p,j} \times K_{p,j}$$

where:

$EC_{DC,p,j}$ is the electric energy consumption for phase p of DS_j of the shortened Type 1 test procedure according to paragraph 4.3. of this Sub-Annex, Wh/km;

$k_{p,j}$ is the weighting factor for phase p of DS_j of the shortened Type 1 test procedure

and

$$K_{p,1} = \frac{\Delta E_{REESS,p,1}}{UBE_{STP}} \text{ and } K_{p,2} = 1 - K_{p,1}$$

where:

$\Delta E_{REESS,p,1}$ is the electric energy change of all REESSs during the first phase p of DS_1 of the shortened Type 1 test procedure, Wh.

Status: Point in time view as at 01/06/2017.

Changes to legislation: There are outstanding changes not yet made to Commission Regulation (EU) 2017/1151. Any changes that have already been made to the legislation appear in the content and are referenced with annotations. (See end of Document for details)

4.4.2.2. Determination of the pure electric ranges when the consecutive cycle Type 1 test procedure is applied

4.4.2.2.1. The pure electric range for the applicable WLTP test cycle PER_{WLTP} for PEVs shall be calculated from the Type 1 test as described in paragraph 3.4.4.1. of this Sub-Annex using the following equations:

$$PER_{WLTP} = \frac{UBE_{CCP}}{EC_{DC,WLTC}}$$

where:

UBE_{CCP} is the usable REESS energy determined from the beginning of the consecutive cycle Type 1 test procedure until the break-off criterion according to paragraph 3.4.4.1.3. of this Sub-Annex is reached, Wh;
 $EC_{DC,WLTC}$ is the electric energy consumption for the applicable WLTP test cycle determined from completely driven applicable WLTP test cycles of the consecutive cycle Type 1 test procedure, Wh/km;

and

$$UBE_{CCP} = \sum_k^{j-1} \Delta E_{REESS,j}$$

where:

$\Delta E_{REESS,j}$ is the electric energy change of all REESSs during phase j of the consecutive cycle Type 1 test procedure, Wh;
 j is the index number of the phase considered;
 k is the number of phases driven from the beginning up to and including the phase where the break-off criterion is reached;

and

$$EC_{DC,WLTC} = \sum_{j=1}^{n_{WLTP}} EC_{DC,WLTC,j} \times K_{WLTC,j}$$

where:

$EC_{DC,WLTC,j}$ is the electric energy consumption for the applicable WLTP test cycle j of the consecutive cycle Type 1 test procedure according to paragraph 4.3. of this Sub-Annex, Wh/km;
 $K_{WLTC,j}$ is the weighting factor for the applicable WLTP test cycle j of the consecutive cycle Type 1 test procedure;
 j is the index number of the applicable WLTP test cycle;
 n_{WLTC} is the whole number of complete applicable WLTP test cycles driven;

and

$$K_{WLTC,1} = \frac{\Delta E_{REESS,WLTC,1}}{UBE_{CCP}} \text{ and } K_{WLTC,j} = \frac{1 - K_{WLTC,1}}{n_{WLTC} - 1} \text{ for } j = 2 \dots n_{WLTC}$$

where:

$\Delta E_{REESS,WLTC,1}$ is the electric energy change of all REESSs during the first applicable WLTP test cycle of the consecutive Type 1 test cycle procedure, Wh.

4.4.2.2.2. The pure electric range for the WLTP city test cycle PER_{city} for PEVs shall be calculated from the Type 1 test as described in paragraph 3.4.4.1. of this Sub-Annex using the following equations:

$$PER_{city} = \frac{UBE_{CCP}}{EC_{DC,city}}$$

where:

Status: Point in time view as at 01/06/2017.

Changes to legislation: There are outstanding changes not yet made to Commission Regulation (EU) 2017/1151. Any changes that have already been made to the legislation appear in the content and are referenced with annotations. (See end of Document for details)

UBE_{CCP} is the usable REESS energy according to paragraph 4.4.2.2.1. of this Sub-Annex, Wh;

$EC_{DC,city}$ is the electric energy consumption for the applicable WLTP city test cycle determined from completely driven applicable WLTP city test cycles of the consecutive cycle Type 1 test procedure, Wh/km;

and

$$EC_{DC,city} = \sum_{n_{city}}^{j=1} EC_{DC,city,j} \times K_{city,j}$$

where:

$EC_{DC,city,j}$ is the electric energy consumption for the applicable WLTP city test cycle j of the consecutive cycle Type 1 test procedure according to paragraph 4.3. of this Sub-Annex, Wh/km;

$K_{city,j}$ is the weighting factor for the applicable WLTP city test cycle j of the consecutive cycle Type 1 test procedure;

j is the index number of the applicable WLTP city test cycle;

n_{city} is the whole number of complete applicable WLTP city test cycles driven;

and

$$K_{city,1} = \frac{\Delta E_{REESS,city,1}}{UBE_{CCP}} \text{ and } K_{city,j} = \frac{1 - K_{city,1}}{n_{city} - 1} \text{ for } j = 2 \dots n_{city}$$

where:

$\Delta E_{REESS,city,1}$ is the electric energy change of all REESSs during the first applicable WLTP city test cycle of the consecutive cycle Type 1 test procedure, Wh.

4.4.2.2.3. The phase-specific pure electric-range PER_p for PEVs shall be calculated from the Type 1 test as described in paragraph 3.4.4.1. of this Sub-Annex using the following equations:

$$PER_p = \frac{UBE_{CCP}}{EC_{DC,p}}$$

where:

UBE_{CCP} is the usable REESS energy according to paragraph 4.4.2.2.1. of this Sub-Annex, Wh;

$EC_{DC,p}$ is the electric energy consumption for the considered phase p determined from completely driven phases p of the consecutive cycle Type 1 test procedure, Wh/km;

and

$$EC_{DC,p} = \sum_{j=1}^{n_p} EC_{DC,p,j} \times K_{p,j}$$

where:

$EC_{DC,p,j}$ is the j th electric energy consumption for the considered phase p of the consecutive cycle Type 1 test procedure according to paragraph 4.3. of this Sub-Annex, Wh/km;

$k_{p,j}$ is the j th weighting factor for the considered phase p of the consecutive cycle Type 1 test procedure;

j is the index number of the considered phase p ;

n_p is the whole number of complete WLTC phases p driven;

and

Status: Point in time view as at 01/06/2017.

Changes to legislation: There are outstanding changes not yet made to Commission Regulation (EU) 2017/1151. Any changes that have already been made to the legislation appear in the content and are referenced with annotations. (See end of Document for details)

$$K_{p,1} = \frac{\Delta E_{\text{REESS},p,1}}{UBE_{\text{CCF}}} \text{ and } K_{p,j} = \frac{1-K_{p,1}}{n_p-1} \text{ for } j = 2 \dots n_p$$

where:

$\Delta E_{\text{REESS},p,1}$ is the electric energy change of all REESSs during the first driven phase p during the consecutive cycle Type 1 test procedure, Wh.

4.4.3. Charge-depleting cycle range for OVC-HEVs

The charge-depleting cycle range R_{CDC} shall be determined from the charge-depleting Type 1 test described in paragraph 3.2.4.3. of this Sub-Annex as part of the Option 1 test sequence and is referenced in paragraph 3.2.6.1. of this Sub-Annex as part of the Option 3 test sequence. The R_{CDC} is the distance driven from the beginning of the charge-depleting Type 1 test to the end of the transition cycle according to paragraph 3.2.4.4 of this Sub-Annex.

4.4.4. Equivalent all-electric range for OVC-HEVs

4.4.4.1. Determination of cycle-specific equivalent all-electric range

The cycle-specific equivalent all-electric range shall be calculated using the following equation:

$$EAER = \left(\frac{M_{\text{CO}_2,\text{CS}} - M_{\text{CO}_2,\text{CD,avg}}}{M_{\text{CO}_2,\text{CS}}} \right) \times R_{\text{CDC}}$$

where:

EAER is the cycle-specific equivalent all-electric range, km;
 $M_{\text{CO}_2,\text{CS}}$ is the charge-sustaining CO_2 mass emission according to Table A8/5, step no. 7, g/km;
 $M_{\text{CO}_2,\text{CD,avg}}$ is the arithmetic average charge-depleting CO_2 mass emission according to the equation below, g/km;
 R_{CDC} is the charge-depleting cycle range according to paragraph 4.4.2. of this Sub-Annex, km;

and

$$M_{\text{CO}_2,\text{CD,avg}} = \frac{\sum_k^{j-1} (M_{\text{CO}_2,\text{CD},j} \times d_j)}{\sum_k^{j-1} d_j}$$

where:

$M_{\text{CO}_2,\text{CD,avg}}$ is the arithmetic average charge-depleting CO_2 mass emission, g/km;
 $M_{\text{CO}_2,\text{CD},j}$ is the CO_2 mass emission determined according to paragraph 3.2.1. of Sub-Annex 7 of phase j of the charge-depleting Type 1 test, g/km;
 d_j is the distance driven in phase j of the charge-depleting Type 1 test, km;
 j is the index number of the considered phase;
 k is the number of phases driven up to the end of the transition cycle n according to paragraph 3.2.4.4 of this Sub-Annex.

4.4.4.2. Determination of the phase-specific equivalent all-electric range

The phase-specific equivalent all-electric range shall be calculated using the following equation:

$$EAER_p = \left(\frac{M_{\text{CO}_2,\text{CS},p} - M_{\text{CO}_2,\text{CD,avg},p}}{M_{\text{CO}_2,\text{CS},p}} \right) \times \frac{\sum_k^{j-1} \Delta E_{\text{REESS},j}}{EC_{\text{DC,CD},p}}$$

where:

$EAER_p$ is the phase-specific equivalent all-electric range for the considered phase p, km;

Status: Point in time view as at 01/06/2017.

Changes to legislation: There are outstanding changes not yet made to Commission Regulation (EU) 2017/1151. Any changes that have already been made to the legislation appear in the content and are referenced with annotations. (See end of Document for details)

$M_{CO_2,CS,p}$	is the phase-specific CO ₂ mass emission from the charge-sustaining Type 1 test for the considered phase p according to Table A8/5, step no. 7, g/km;
$\Delta E_{REESS,j}$	are the electric energy changes of all REESSs during the considered phase j, Wh;
$EC_{DC,CD,p}$	is the electric energy consumption over the considered phase p based on the REESS depletion, Wh/km;
j	is the index number of the considered phase;
k	is the number of phases driven up to the end of the transition cycle n according to paragraph 3.2.4.4 of this Sub-Annex;

and

$$M_{CO_2,CD,AVG,P} = \frac{\sum_{c=1}^{n_c} (M_{CO_2,CD,p,c} \times d_{p,c})}{\sum_{c=1}^{n_c} d_{p,c}}$$

where:

$M_{CO_2,CD,AVG,P}$	is the arithmetic average charge-depleting CO ₂ mass emission for the considered phase p, g/km;
$M_{CO_2,CD,p,c}$	is the CO ₂ mass emission determined according to paragraph 3.2.1. of Sub-Annex 7 of phase p in cycle c of the charge-depleting Type 1 test, g/km;
$d_{p,c}$	is the distance driven in the considered phase p of cycle c of the charge-depleting Type 1 test, km;
c	is the index number of the considered applicable WLTP test cycle;
p	is the index of the individual phase within the applicable WLTP test cycle;
n_c	is the number of applicable WLTP test cycles driven up to the end of the transition cycle n according to paragraph 3.2.4.4. of this Sub-Annex;

and

$$EC_{DC,CD,P} = \frac{\sum_{c=1}^{n_c} EC_{DC,CD,P,C} \times d_{p,c}}{\sum_{c=1}^{n_c} d_{p,c}}$$

where:

$EC_{DC,CD,P}$	is the electric energy consumption of the considered phase p based on the REESS depletion of the charge-depleting Type 1 test, Wh/km;
$EC_{DC,CD,P,C}$	is the electric energy consumption of the considered phase p of cycle c based on the REESS depletion of the charge-depleting Type 1 test according to paragraph 4.3. of this Sub-Annex, Wh/km;
$d_{p,c}$	is the distance driven in the considered phase p of cycle c of the charge-depleting Type 1 test, km;
c	is the index number of the considered applicable WLTP test cycle;
p	is the index of the individual phase within the applicable WLTP test cycle;
n_c	is the number of applicable WLTP test cycles driven up to the end of the transition cycle n according to paragraph 3.2.4.4. of this Sub-Annex.

The considered phase values shall be the low-phase, mid-phase, high-phase, extra high-phase, and the city driving cycle.

4.4.5. Actual charge-depleting range for OVC-HEVs

The actual charge-depleting range shall be calculated using the following equation:

Status: Point in time view as at 01/06/2017.

Changes to legislation: There are outstanding changes not yet made to Commission Regulation (EU) 2017/1151. Any changes that have already been made to the legislation appear in the content and are referenced with annotations. (See end of Document for details)

$$R_{CDA} = \sum_{c=1}^{n-1} d_c + \left(\frac{M_{CO_2,CS} - M_{CO_2,n,cycle}}{M_{CO_2,CS} - M_{CO_2,CD,avg,n-1}} \right) \times d_n$$

where:

R_{CDA}	is the actual charge-depleting range, km;
$M_{CO_2,CS}$	is the charge-sustaining CO ₂ mass emission according to Table A8/5, step no. 7, g/km;
$M_{CO_2,n,cycle}$	is the CO ₂ mass emission of the applicable WLTP test cycle n of the charge-depleting Type 1 test, g/km;
$M_{CO_2,CD,avg,n-1}$	is the arithmetic average CO ₂ mass emission of the charge-depleting Type 1 test from the beginning up to and including the applicable WLTP test cycle (n-1), g/km;
d_c	is the distance driven in the applicable WLTP test cycle c of the charge-depleting Type 1 test, km;
d_n	is the distance driven in the applicable WLTP test cycle n of the charge-depleting Type 1 test, km;
c	is the index number of the considered applicable WLTP test cycle;
n	is the number of applicable WLTP test cycles driven including the transition cycle according to paragraph 3.2.4.4. of this Sub-Annex;

and

$$M_{CO_2,CD,avg,n-1} = \frac{\sum_{c=1}^{n-1} (M_{CO_2,CD,c} \times d_c)}{\sum_{c=1}^{n-1} d_c}$$

where:

$M_{CO_2,CD,avg,n-1}$	is the arithmetic average CO ₂ mass emission of the charge-depleting Type 1 test from the beginning up to and including the applicable WLTP test cycle (n-1), g/km;
$M_{CO_2,CD,c}$	is the CO ₂ mass emission determined according to paragraph 3.2.1. of Sub-Annex 7 of the applicable WLTP test cycle c of the charge-depleting Type 1 test, g/km;
d_c	is the distance driven in the applicable WLTP test cycle c of the charge-depleting Type 1 test, km;
c	is the index number of the considered applicable WLTP test cycle;
n	is the number of applicable WLTP test cycles driven including the transition cycle according to paragraph 3.2.4.4 of this Sub-Annex;

4.5. Interpolation of individual vehicle values

4.5.1. Interpolation range for NOVC-HEVs and OVC-HEVs

The interpolation method shall only be used if the difference in charge-sustaining CO₂ mass emission, $M_{CO_2,CS}$, according to Table A8/5, step no. 8 between test vehicles L and H is between a minimum of 5 g/km and a maximum of 20 g/km or 20 per cent of the charge-sustaining CO₂ mass emission, $M_{CO_2,CS}$, according to Table A8/5, step no. 8 for vehicle H, whichever value is smaller.

At the request of the manufacturer and with approval of the approval authority, the interpolation of individual vehicle values within a family may be extended if the maximum extrapolation is not more than 3 g/km above the charge-sustaining CO₂ mass emission of vehicle H and/or is not more than 3 g/km below the charge-sustaining CO₂ mass emission of vehicle L. This extension is valid only within the absolute boundaries of the interpolation range specified in this paragraph.

Status: Point in time view as at 01/06/2017.

Changes to legislation: There are outstanding changes not yet made to Commission Regulation (EU) 2017/1151. Any changes that have already been made to the legislation appear in the content and are referenced with annotations. (See end of Document for details)

The maximum absolute boundary of 20 g/km charge-sustaining CO₂ mass emission difference between vehicle L and vehicle H or 20 per cent of the charge-sustaining CO₂ mass emission for vehicle H, whichever is smaller, may be extended by 10 g/km if a vehicle M is tested. Vehicle M is a vehicle within the interpolation family with a cycle energy demand within ± 10 per cent of the arithmetic average of vehicles L and H.

The linearity of charge-sustaining CO₂ mass emission for vehicle M shall be verified against the linear interpolated charge-sustaining CO₂ mass emission between vehicle L and H.

The linearity criterion for vehicle M shall be considered fulfilled if the difference between the charge-sustaining CO₂ mass emission of vehicle M derived from the measurement and the interpolated charge-sustaining CO₂ mass emission between vehicle L and H is below 1 g/km. If this difference is greater, the linearity criterion shall be considered to be fulfilled if this difference is 3 g/km or 3 per cent of the interpolated charge-sustaining CO₂ mass emission for vehicle M, whichever is smaller.

If the linearity criterion is fulfilled, the interpolation between vehicle L and H shall be applicable for all individual vehicles within the interpolation family.

If the linearity criterion is not fulfilled, the interpolation family shall be split into two sub-families for vehicles with a cycle energy demand between vehicles L and M, and vehicles with a cycle energy demand between vehicles M and H.

For vehicles with a cycle energy demand between that of vehicles L and M, each parameter of vehicle H that is necessary for the interpolation of individual OVC-HEV and NOVC-HEV values, shall be substituted by the corresponding parameter of vehicle M.

For vehicles with a cycle energy demand between that of vehicles M and H, each parameter of vehicle L that is necessary for the interpolation of individual cycle values shall be substituted by the corresponding parameter of vehicle M.

4.5.2. Calculation of energy demand per period

The energy demand $E_{k,p}$ and distance driven $d_{c,p}$ per period p applicable for individual vehicles in the interpolation family shall be calculated according to the procedure in paragraph 5. of Sub-Annex 7, for the sets k of road load coefficients and masses according to paragraph 3.2.3.2.3. of Sub-Annex 7.

4.5.3. Calculation of the interpolation coefficient for individual vehicles $K_{ind,p}$

The interpolation coefficient $K_{ind,p}$ per period shall be calculated for each considered period p using the following equation:

$$K_{ind,p} = \frac{E_{2,p} - E_{1,p}}{E_{2,p} - E_{3,p}}$$

where:

$K_{ind,p}$	is the interpolation coefficient for the considered individual vehicle for period p ;
$E_{1,p}$	is the energy demand for the considered period for vehicle L according to paragraph 5. of Sub-Annex 7, W_s ;
$E_{2,p}$	is the energy demand for the considered period for vehicle H according to paragraph 5. of Sub-Annex 7, W_s ;
$E_{3,p}$	is the energy demand for the considered period for the individual vehicle according to paragraph 5. of Sub-Annex 7, W_s ;
p	is the index of the individual period within the applicable test cycle.

Status: Point in time view as at 01/06/2017.

Changes to legislation: There are outstanding changes not yet made to Commission Regulation (EU) 2017/1151. Any changes that have already been made to the legislation appear in the content and are referenced with annotations. (See end of Document for details)

In the case that the considered period p is the applicable WLTP test cycle, $K_{ind,p}$ is named K_{ind} .

4.5.4. Interpolation of the CO₂ mass emission for individual vehicles

4.5.4.1. Individual charge-sustaining CO₂ mass emission for OVC-HEVs and NOVC-HEVs

The charge-sustaining CO₂ mass emission for an individual vehicle shall be calculated using the following equation:

$$M_{CO_2-ind,CS,p} = M_{CO_2-L,CS,p} + K_{ind,d} \times (M_{CO_2-H,CS,p} - M_{CO_2-L,CS,p})$$

where:

$M_{CO_2-ind,CS,p}$	is the charge-sustaining CO ₂ mass emission for an individual vehicle of the considered period p according to Table A8/5, step no. 9, g/km;
$M_{CO_2-L,CS,p}$	is the charge-sustaining CO ₂ mass emission for vehicle L of the considered period p according to Table A8/5, step no. 8, g/km;
$M_{CO_2-H,CS,p}$	is the charge-sustaining CO ₂ mass emission for vehicle H of the considered period p according to Table A8/5, step no. 8, g/km;
$K_{ind,d}$	is the interpolation coefficient for the considered individual vehicle for period p ;
p	is the index of the individual period within the applicable WLTP test cycle.

The considered periods shall be the low-phase, mid-phase, high-phase, extra high-phase and the applicable WLTP test cycle.

4.5.4.2. Individual utility factor-weighted charge-depleting CO₂ mass emission for OVC-HEVs

The utility factor-weighted charge-depleting CO₂ mass emission for an individual vehicle shall be calculated using the following equation:

$$M_{CO_2-ind,CD} = M_{CO_2-L,CD} + K_{ind} \times (M_{CO_2-H,CD} - M_{CO_2-L,CD})$$

where:

$M_{CO_2-ind,CD}$	is the utility factor-weighted charge-depleting CO ₂ mass emission for an individual vehicle, g/km;
$M_{CO_2-L,CD}$	is the utility factor-weighted charge-depleting CO ₂ mass emission for vehicle L, g/km;
$M_{CO_2-H,CD}$	is the utility factor-weighted charge-depleting CO ₂ mass emission for vehicle H, g/km;
K_{ind}	is the interpolation coefficient for the considered individual vehicle for the applicable WLTP test cycle.

4.5.4.3. Individual utility factor-weighted CO₂ mass emission for OVC-HEVs

The utility factor-weighted CO₂ mass emission for an individual vehicle shall be calculated using the following equation:

$$M_{CO_2-ind,weighted} = M_{CO_2-L,weighted} + K_{ind} \times (M_{CO_2-H,weighted} - M_{CO_2-L,weighted})$$

where:

$M_{CO_2-ind,weighted}$	is the utility factor-weighted CO ₂ mass emission for an individual vehicle, g/km;
$M_{CO_2-L,weighted}$	is the utility factor-weighted CO ₂ mass emission for vehicle L, g/km;
$M_{CO_2-H,weighted}$	is the utility factor-weighted CO ₂ mass emission for vehicle H, g/km;

Status: Point in time view as at 01/06/2017.

Changes to legislation: There are outstanding changes not yet made to Commission Regulation (EU) 2017/1151. Any changes that have already been made to the legislation appear in the content and are referenced with annotations. (See end of Document for details)

K_{ind} is the interpolation coefficient for the considered individual vehicle for the applicable WLTP test cycle.

4.5.5. Interpolation of the fuel consumption for individual vehicles

4.5.5.1. Individual charge-sustaining fuel consumption for OVC-HEVs and NOVC-HEVs

The charge-sustaining fuel consumption for an individual vehicle shall be calculated using the following equation:

$$FC_{ind,CS,p} = FC_{L,CS,p} + K_{ind,p} \times (FC_{H,CS,p} - FC_{L,CS,p})$$

where:

$FC_{ind,CS,p}$ is the charge-sustaining fuel consumption for an individual vehicle of the considered period p according to Table A8/6, step no. 3, l/100 km;
 $FC_{L,CS,p}$ is the charge-sustaining fuel consumption for vehicle L of the considered period p according to Table A8/6, step no. 2, l/100 km;
 $FC_{H,CS,p}$ is the charge-sustaining fuel consumption for vehicle H of the considered period p according to Table A8/6, step no. 2, l/100 km;
 $K_{ind,p}$ is the interpolation coefficient for the considered individual vehicle for period p;
p is the index of the individual period within the applicable WLTP test cycle.

The considered periods shall be the low-phase, mid-phase, high-phase, extra high-phase, and the applicable WLTP test cycle.

4.5.5.2. Individual utility factor-weighted charge depleting fuel consumption for OVC-HEVs

The utility factor-weighted charge-depleting fuel consumption for an individual vehicle shall be calculated using the following equation:

$$FC_{ind,CD} = FC_{L,CD} + K_{ind} \times (FC_{H,CD} - FC_{L,CD})$$

where:

$FC_{ind,CD}$ is the utility factor-weighted charge-depleting fuel consumption for an individual vehicle, l/100 km;
 $FC_{L,CD}$ is the utility factor-weighted charge-depleting fuel consumption for vehicle L, l/100 km;
 $FC_{H,CD}$ is the utility factor-weighted charge-depleting fuel consumption for vehicle H, l/100 km;
 K_{ind} is the interpolation coefficient for the considered individual vehicle for the applicable WLTP test cycle.

4.5.5.3. Individual utility factor-weighted fuel consumption for OVC-HEVs

The utility factor-weighted fuel consumption for an individual vehicle shall be calculated using the following equation:

$$FC_{ind,weighted} = FC_{L,weighted} + K_{ind} \times (FC_{H,weighted} - FC_{L,weighted})$$

where:

$FC_{ind,weighted}$ is the utility factor-weighted fuel consumption for an individual vehicle, l/100 km;
 $FC_{L,weighted}$ is the utility factor-weighted fuel consumption for vehicle L, l/100 km;
 $FC_{H,weighted}$ is the utility factor-weighted fuel consumption for vehicle H, l/100 km;

Status: Point in time view as at 01/06/2017.

Changes to legislation: There are outstanding changes not yet made to Commission Regulation (EU) 2017/1151. Any changes that have already been made to the legislation appear in the content and are referenced with annotations. (See end of Document for details)

K_{ind} is the interpolation coefficient for the considered individual vehicle for the applicable WLTP test cycle.

4.5.6 Interpolation of electric energy consumption for individual vehicles

4.5.6.1. Individual utility factor-weighted charge-depleting electric energy consumption based on the recharged electric energy from the mains for OVC-HEVs

The utility factor-weighted charge-depleting electric energy consumption based on the recharged electric energy from for an individual vehicle shall be calculated using the following equation:

$$EC_{AC-ind,CD} = EC_{AC-L,CD} + K_{ind} \times (EC_{AC-H,CD} - EC_{AC-L,CD})$$

where:

$EC_{AC-ind,CD}$ is the utility factor-weighted charge-depleting electric energy consumption based on the recharged electric energy from the mains for an individual vehicle, Wh/km;

$EC_{AC-L,CD}$ is the utility factor-weighted charge-depleting electric energy consumption based on the recharged electric energy from the mains for vehicle L, Wh/km;

$EC_{AC-H,CD}$ is the utility factor-weighted charge-depleting electric energy consumption based on the recharged electric energy from the mains for vehicle H, Wh/km;

K_{ind} is the interpolation coefficient for the considered individual vehicle for the applicable WLTP test cycle

4.5.6.2. Individual utility factor-weighted electric energy consumption based on the recharged electric energy from the mains for OVC-HEVs

The utility factor-weighted electric energy consumption based on the recharged electric energy from the mains for an individual vehicle shall be calculated using the following equation:

$$EC_{AC-ind,weighted} = EC_{AC-L,weighted} + K_{ind} \times (EC_{AC-H,weighted} - EC_{AC-L,weighted})$$

where:

$EC_{AC-ind,weighted}$ is the utility factor weighted electric energy consumption based on the recharged electric energy from the mains for an individual vehicle, Wh/km;

$EC_{AC-L,weighted}$ is the utility factor weighted electric energy consumption based on the recharged electric energy from the mains for vehicle L, Wh/km;

$EC_{AC-H,weighted}$ is the utility factor weighted electric energy consumption based on the recharged electric energy from the mains for vehicle H, Wh/km;

K_{ind} is the interpolation coefficient for the considered individual vehicle for the applicable WLTP test cycle.

4.5.6.3. Individual electric energy consumption for OVC-HEVs and PEVs

The electric energy consumption for an individual vehicle according to paragraph 4.3.3. of this Sub-Annex in the case of OVC-HEVs and according to paragraph 4.3.4. of this Sub-Annex in the case of PEVs shall be calculated using the following equation:

$$EC_{ind,p} = EC_{L,p} + K_{ind,p} \times (EC_{H,p} - EC_{L,p})$$

where:

$EC_{ind,p}$ is the electric energy consumption for an individual vehicle for the considered period p, Wh/km;

Status: Point in time view as at 01/06/2017.

Changes to legislation: There are outstanding changes not yet made to Commission Regulation (EU) 2017/1151. Any changes that have already been made to the legislation appear in the content and are referenced with annotations. (See end of Document for details)

$EC_{L,p}$	is the electric energy consumption for vehicle L for the considered period p, Wh/km;
$EC_{H,p}$	is the electric energy consumption for vehicle H for the considered period p, Wh/km;
$K_{ind,p}$	is the interpolation coefficient for the considered individual vehicle for period p;
p	is the index of the individual period within the applicable test cycle.

The considered periods shall be the low-phase, mid-phase, high-phase, extra high-phase, the applicable WLTP city test cycle and the applicable WLTP test cycle.

4.5.7 Interpolation of electric ranges for individual vehicles

4.5.7.1. Individual all-electric range for OVC-HEVs

If the following criterion

$$\left| \frac{AER_L}{R_{CDA,L}} - \frac{AER_H}{R_{CDA,H}} \right| \leq 0,1$$

where:

AER_L	: is the all-electric range of vehicle L for the applicable WLTP test cycle, km;
AER_H	: is the all-electric range of vehicle H for the applicable WLTP test cycle, km;
$R_{CDA,L}$: is the actual charge-depleting range of vehicle L, km;
$R_{CDA,H}$: is the actual charge-depleting range of vehicle H, km;

is fulfilled, the all-electric range for an individual vehicle shall be calculated using the following equation:

$$AER_{ind,p} = AER_{L,p} + K_{ind,p} \times (AER_{H,p} - AER_{L,p})$$

where:

$AER_{ind,p}$	is the all-electric range for an individual vehicle for the considered period p, km;
$AER_{L,p}$	is the all-electric range for vehicle L for the considered period p, km;
$AER_{H,p}$	is the all-electric range for vehicle H for the considered period p, km;
$K_{ind,p}$	is the interpolation coefficient for the considered individual vehicle for period p;
p	is the index of the individual period within the applicable test cycle.

The considered periods shall be the applicable WLTP city test cycle and the applicable WLTP test cycle.

If the criterion defined in this paragraph is not fulfilled, the AER determined for vehicle H is applicable to all vehicles within the interpolation family.

4.5.7.2. Individual pure electric range for PEVs

The pure electric range for an individual vehicle shall be calculated using the following equation:

$$PER_{ind,p} = PER_{L,p} + K_{ind,p} \times (PER_{H,p} - PER_{L,p})$$

where:

$PER_{ind,p}$	is the pure electric range for an individual vehicle for the considered period p, km;
$PER_{L,p}$	is the pure electric range for vehicle L for the considered period p, km;

Status: Point in time view as at 01/06/2017.

Changes to legislation: There are outstanding changes not yet made to Commission Regulation (EU) 2017/1151. Any changes that have already been made to the legislation appear in the content and are referenced with annotations. (See end of Document for details)

$PER_{H,p}$ is the pure electric range for vehicle H for the considered period p, km;
 $K_{ind,p}$ is the interpolation coefficient for the considered individual vehicle for period p;
p is the index of the individual period within the applicable test cycle.

The considered periods shall be the low-phase, mid-phase, high-phase, extra high-phase, applicable WLTP city test cycle and the applicable WLTP test cycle.

4.5.7.3. Individual equivalent all-electric range for OVC-HEVs

The equivalent all-electric range for an individual vehicle shall be calculated using the following equation:

$$EAER_{ind,p} = EAER_{L,p} + K_{ind,p} \times (EAER_{H,p} - EAER_{L,p})$$

where:

$EAER_{ind,p}$ is the equivalent all-electric range for an individual vehicle for the considered period p, km;
 $EAER_{L,p}$ is the equivalent all-electric range for vehicle L for the considered period p, km;
 $EAER_{H,p}$ is the equivalent all-electric range for vehicle H for the considered period p, km;
 $K_{ind,p}$ is the interpolation coefficient for the considered individual vehicle for period p;
p is the index of the individual period within the applicable test cycle.

The considered periods shall be the low-phase, mid-phase, high-phase, extra high-phase, applicable WLTP city test cycle and the applicable WLTP test cycle.

Sub-Annex 8

Appendix 1

REESS state of charge profile

1. Test sequences and REESS profiles: OVC-HEVs, charge-depleting and charge-sustaining test

1.1. Test sequence OVC-HEVs according to option 1:

Charge-depleting type 1 test with no subsequent charge-sustaining Type 1 test (A8.App1/1)
Figure A8.App1/1

Status: Point in time view as at 01/06/2017.

Changes to legislation: There are outstanding changes not yet made to Commission Regulation (EU) 2017/1151. Any changes that have already been made to the legislation appear in the content and are referenced with annotations. (See end of Document for details)

OVC-HEVs, charge-depleting Type 1 test

Manufacturer's certificate of compliance with the Real Driving Emissions requirements

(Manufacturer):

(Address of the Manufacturer):

Certifies that

The vehicle types listed in the attachment to this Certificate comply with the requirements laid down in point 2.1 of Annex IIIA to Regulation (EC) No 692/2008 relating to real driving emissions for all possible RDE tests, which are in accordance to the requirements of this Annex.

Done at [.....] (Place)]

On [.....] (Date)]

.....
(Stamp and signature of the manufacturer's representative)

Annex:

- List of vehicle types to which this certificate applies.

1.2. Test sequence OVC-HEVs according to option 2:

Charge-sustaining Type 1 test with no subsequent charge-depleting Type 1 test (A8.App1/2)
Figure A8.App1/2

Status: Point in time view as at 01/06/2017.

Changes to legislation: There are outstanding changes not yet made to Commission Regulation (EU) 2017/1151. Any changes that have already been made to the legislation appear in the content and are referenced with annotations. (See end of Document for details)

OVC-HEVs, charge-sustaining Type 1 test

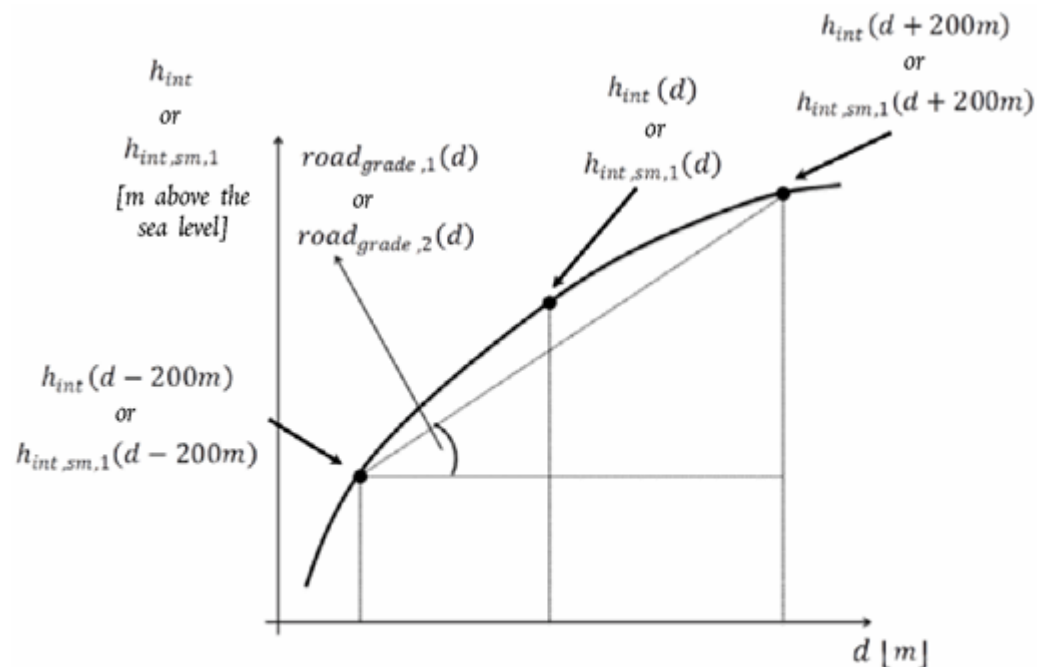

1.3. Test sequence OVC-HEVs according to option 3:

Charge-depleting Type 1 test with subsequent charge-sustaining Type 1 test (A8.App1/3)
Figure A8.App1/3

Status: Point in time view as at 01/06/2017.

Changes to legislation: There are outstanding changes not yet made to Commission Regulation (EU) 2017/1151. Any changes that have already been made to the legislation appear in the content and are referenced with annotations. (See end of Document for details)

OVC-HEVs, charge-depleting type 1 test with subsequent charge-sustaining Type 1 test

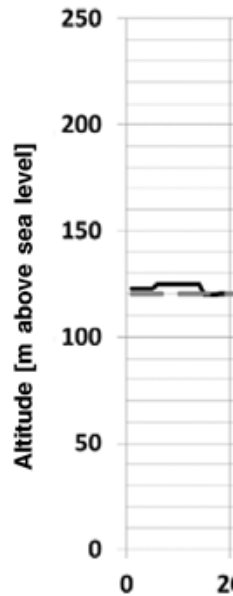
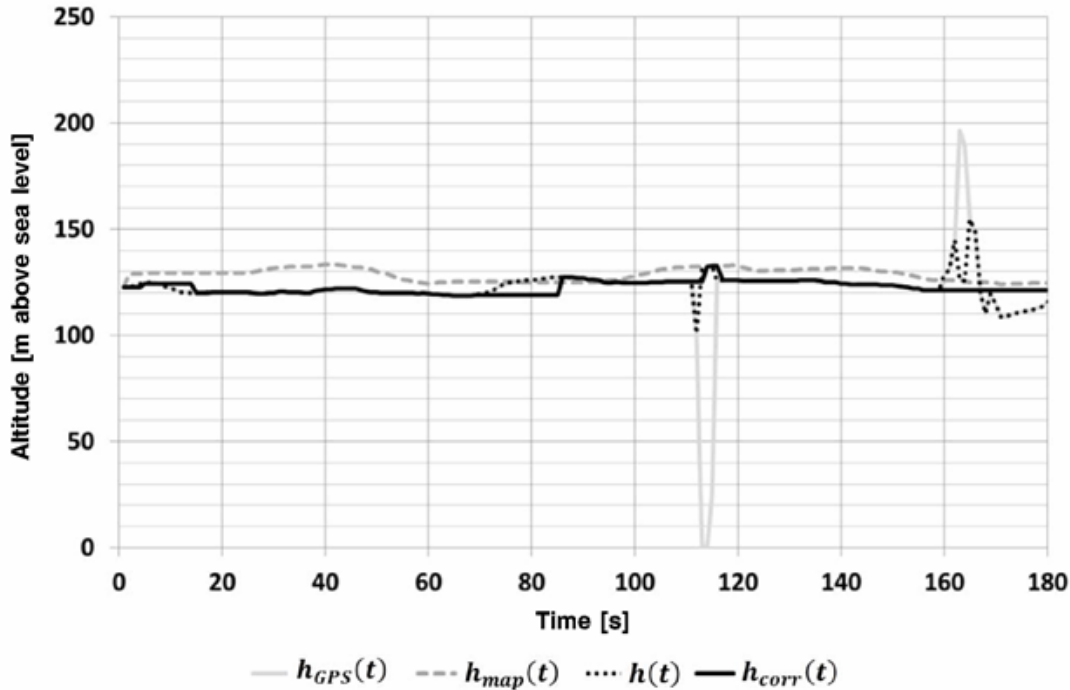

1.4. Test sequence OVC-HEVs according to option 4:

Charge-sustaining Type 1 test with subsequent charge-depleting Type 1 test
 Figure A8.App1/4

OVC-HEVs, charge-depleting Type 1 test with subsequent charge-sustaining Type 1 test

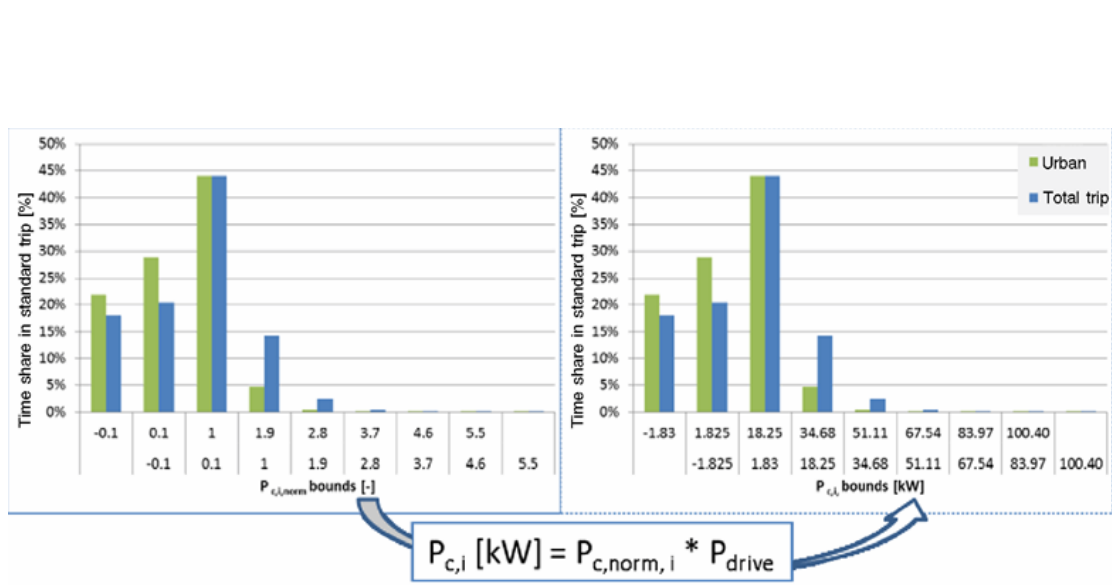

2. Test sequence NOVC-HEVs and NOVC-FCHVs

Charge-sustaining Type 1 test

Status: Point in time view as at 01/06/2017.

Changes to legislation: There are outstanding changes not yet made to Commission Regulation (EU) 2017/1151. Any changes that have already been made to the legislation appear in the content and are referenced with annotations. (See end of Document for details)

Figure A8.App1/5

NOVC-HEVs and NOVC-FCHVs, charge-sustaining Type 1 test

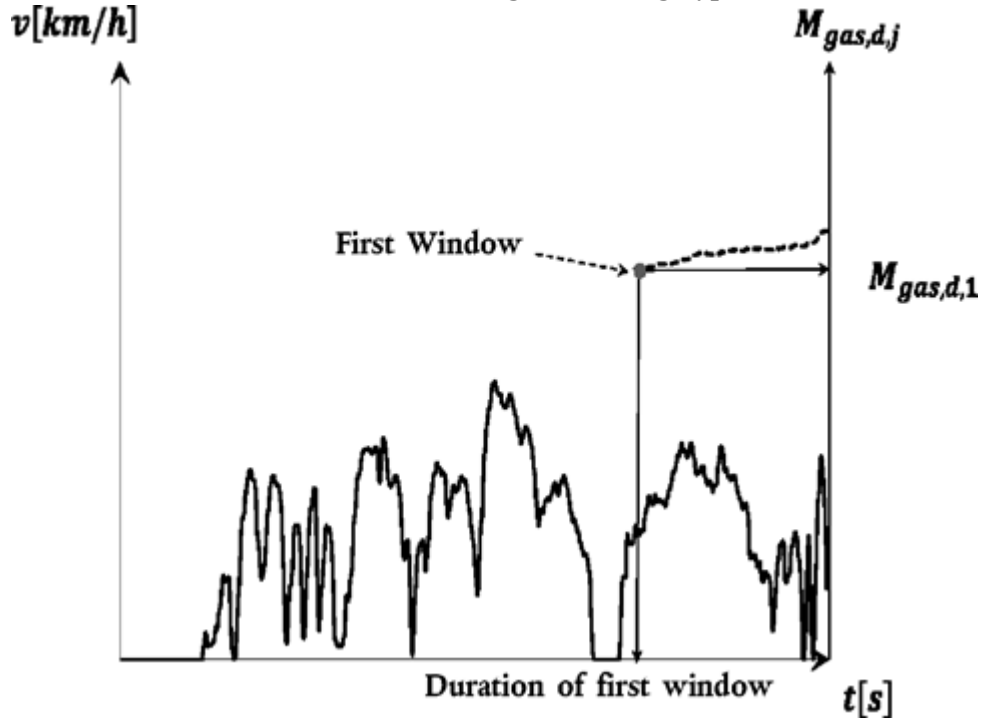

3. Test sequences PEV

3.1. Consecutive cycles procedure

Figure A8.App1/6

Consecutive cycles test sequence PEV

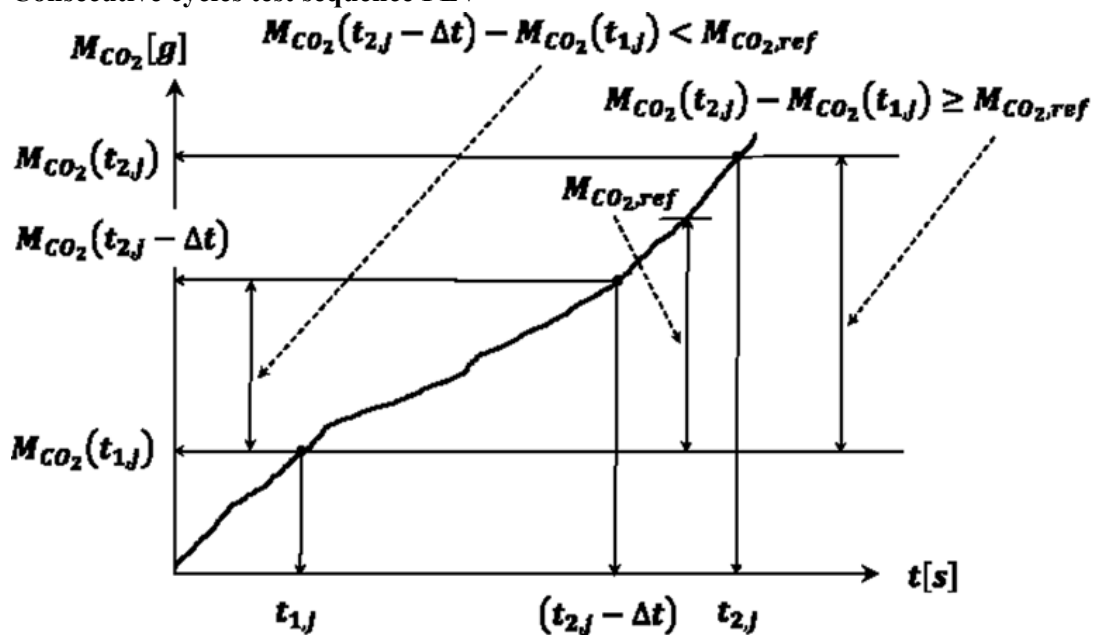

Status: Point in time view as at 01/06/2017.

Changes to legislation: There are outstanding changes not yet made to Commission Regulation (EU) 2017/1151. Any changes that have already been made to the legislation appear in the content and are referenced with annotations. (See end of Document for details)

3.2. Shortened Test Procedure

Figure A8.App1/7

Shortened test procedure test sequence for PEVs

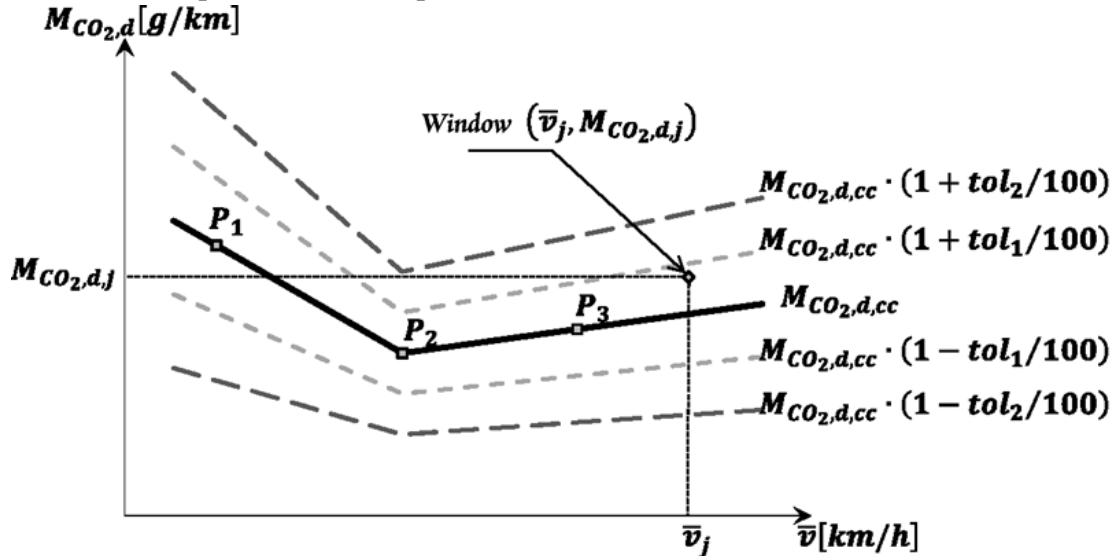

Sub-Annex 8

Appendix 2

REESS energy change-based correction procedure

This Appendix describes the procedure to correct the charge-sustaining Type 1 test CO₂ mass emission for NOVC-HEVs and OVC-HEVs, and the fuel consumption for NOVC-FCHVs as a function of the electric energy change of all REESSs.

1. General requirements
 - 1.1. Applicability of this Appendix
 - 1.1.1. The phase-specific fuel consumption for NOVC-FCHVs, and the CO₂ mass emission for NOVC-HEVs and OVC-HEVs shall be corrected.
 - 1.1.2. In the case that a correction of fuel consumption for NOVC-FCHVs or a correction of CO₂ mass emission for NOVC-HEVs and OVC-HEVs measured over the whole cycle according to paragraph 1.1.3. or paragraph 1.1.4. of this Appendix is applied, paragraph 4.3. of this Sub-Annex shall be used to calculate the charge-sustaining REESS energy change $\Delta E_{REESS,CS}$ of the charge-sustaining Type 1 test. The considered period j used in paragraph 4.3. of this Sub-Annex is defined by the charge-sustaining Type 1 test.
 - 1.1.3. The correction shall be applied if $\Delta E_{REESS,CS}$ is negative which corresponds to REESS discharging and the correction criterion c calculated in paragraph 1.2. is greater than the applicable tolerance according to Table A8.App2/1.
 - 1.1.4. The correction may be omitted and uncorrected values may be used if:

Status: Point in time view as at 01/06/2017.

Changes to legislation: There are outstanding changes not yet made to Commission Regulation (EU) 2017/1151. Any changes that have already been made to the legislation appear in the content and are referenced with annotations. (See end of Document for details)

- (a) $\Delta E_{\text{REESS,CS}}$ is positive which corresponds to REESS charging and the correction criterion c calculated in paragraph 1.2. is greater than the applicable tolerance according to Table A8.App2/1;
- (b) the correction criterion c calculated in paragraph 1.2. is smaller than the applicable tolerance according to Table A8.App2/1;
- (c) the manufacturer can prove to the approval authority by measurement that there is no relation between $\Delta E_{\text{REESS,CS}}$ and charge-sustaining CO_2 mass emission and $\Delta E_{\text{REESS,CS}}$ and fuel consumption respectively.

1.2. The correction criterion c is the ratio between the absolute value of the REESS electric energy change $\Delta E_{\text{REESS,CS}}$ and the fuel energy and shall be calculated as follows:

$$c = \frac{|\Delta E_{\text{REESS,CS}}|}{E_{\text{fuel,CS}}}$$

where:

$\Delta E_{\text{REESS,CS}}$ is the charge-sustaining REESS energy change according to paragraph 1.1.2. of this Appendix, Wh;
 $E_{\text{fuel,CS}}$ is the charge-sustaining energy content of the consumed fuel according to paragraph 1.2.1. in the case of NOVC-HEVs and OVC-HEVs, according to paragraph 1.2.2. in the case of NOVC-FCHVs, Wh.

1.2.1. Charge-sustaining fuel energy for NOVC-HEVs and OVC-HEVs

The charge-sustaining energy content of the consumed fuel for NOVC-HEVs and OVC-HEVs shall be calculated using the following equation:

$$E_{\text{fuel,CS}} = 10 \times \text{HV} \times \text{FC}_{\text{CS,nb}} \times d_{\text{CS}}$$

where:

$E_{\text{fuel,CS}}$ is the charge-sustaining energy content of the consumed fuel of the applicable WLTP test cycle of the charge-sustaining Type 1 test, Wh;
HV is the heating value according to Table A6.App2/1, kWh/l;
 $\text{FC}_{\text{CS,nb}}$ is the non-balanced charge-sustaining fuel consumption of the charge-sustaining Type 1 test, not corrected for the energy balance, determined according to paragraph 6. of Sub-Annex 7, using the gaseous emission compound values according to Table A8/5, step no. 2, l/100 km;
 d_{CS} is the distance driven over the corresponding applicable WLTP test cycle, km;
10 conversion factor to Wh.

1.2.2. Charge-sustaining fuel energy for NOVC-FCHVs

The charge-sustaining energy content of the consumed fuel for NOVC-FCHVs shall be calculated using the following equation:

$$E_{\text{fuel,CS}} = \frac{1}{0,36} \times 121 \times \text{FC}_{\text{CS,nb}} \times d_{\text{CS}}$$

$E_{\text{fuel,CS}}$ is the charge-sustaining energy content of the consumed fuel of the applicable WLTP test cycle of the charge-sustaining Type 1 test, Wh;
121 is the lower heating value of hydrogen, MJ/kg;
 $\text{FC}_{\text{CS,nb}}$ is the non-balanced charge-sustaining fuel consumption of the charge-sustaining Type 1 test, not corrected for the energy balance, determined according to Table A8/7, step no.1, kg/100 km;
 d_{CS} is the distance driven over the corresponding applicable WLTP test cycle, km;

Status: Point in time view as at 01/06/2017.

Changes to legislation: There are outstanding changes not yet made to Commission Regulation (EU) 2017/1151. Any changes that have already been made to the legislation appear in the content and are referenced with annotations. (See end of Document for details)

$\frac{1}{0,36}$

conversion factor to Wh.

TABLE A8.APP2/1

Correction criteria

Applicable Type 1 test cycle	Low + Medium	Low + Medium + High	Low + Medium + High + Extra High
Correction criterion ratio c	0,015	0,01	0,005

2. Calculation of correction coefficients

- 2.1. The CO₂ mass emission correction coefficient K_{CO_2} , the fuel consumption correction coefficients $K_{fuel,FCHV}$, as well as, if required by the manufacturer, the phase-specific correction coefficients $K_{CO_2,p}$ and $K_{fuel,FCHV,p}$ shall be developed based on the applicable charge-sustaining Type 1 test cycles.

In the case that vehicle H was tested for the development of the correction coefficient for CO₂ mass emission for NOVC-HEVs and OVC-HEVs, the coefficient may be applied within the interpolation family.

- 2.2. The correction coefficients shall be determined from a set of charge-sustaining Type 1 tests according to paragraph 3. of this Appendix. The number of tests performed by the manufacturer shall be equal to or greater than five.

The manufacturer may request to set the state of charge of the REESS prior to the test according to the manufacturer's recommendation and as described in paragraph 3. of this Appendix. This practice shall only be used for the purpose of achieving a charge-sustaining Type 1 test with opposite sign of the $\Delta E_{REESS,CS}$ and with approval of the approval authority.

The set of measurements shall fulfil the following criteria:

- (a) The set shall contain at least one test with $\Delta E_{REESS,CS} \leq 0$ and at least one test with $\Delta E_{REESS,CS} > 0$. $\Delta E_{REESS,CS,n}$ is the sum of electric energy changes of all REESSs of test n calculated according to paragraph 4.3. of this Sub-Annex.
- (b) The difference in $M_{CO_2,CS}$ between the test with the highest negative electric energy change and the test with the highest positive electric energy change shall be greater than or equal to 5 g/km. This criterion shall not be applied for the determination of $K_{fuel,FCHV}$.

In the case of the determination of K_{CO_2} , the required number of tests may be reduced to three tests if all of the following criteria are fulfilled in addition to (a) and (b):

- (c) the difference in $M_{CO_2,CS}$ between any two adjacent measurements, related to the electric energy change during the test, shall be less than or equal to 10 g/km.
- (d) in addition to (b), the test with the highest negative electric energy change and the test with the highest positive electric energy change shall not be within the region that is defined by:

$$-0,01 \leq \frac{\Delta E_{REESS}}{E_{fuel}} \leq +0,01$$

Status: Point in time view as at 01/06/2017.

Changes to legislation: There are outstanding changes not yet made to Commission Regulation (EU) 2017/1151. Any changes that have already been made to the legislation appear in the content and are referenced with annotations. (See end of Document for details)

where:

E_{fuel} is the energy content of the consumed fuel calculated according to paragraph 1.2. of this Appendix, Wh.

- (e) the difference in $M_{\text{CO}_2,\text{CS}}$ between the test with the highest negative electric energy change and the mid-point, and the difference in $M_{\text{CO}_2,\text{CS}}$ between mid-point and the test with the highest positive electric energy change shall be similar and preferably be within the range defined by (d).

The correction coefficients determined by the manufacturer shall be reviewed and approved by the approval authority prior to its application.

If the set of at least five tests does not fulfil criterion (a) or criterion (b) or both, the manufacturer shall provide evidence to the approval authority as to why the vehicle is not capable of meeting either or both criteria. If the approval authority is not satisfied with the evidence, it may require additional tests to be performed. If the criteria after additional tests are still not fulfilled, the approval authority will determine a conservative correction coefficient, based on the measurements.

2.3. Calculation of correction coefficients $K_{\text{fuel,FCHV}}$ and K_{CO_2}

2.3.1. Determination of the fuel consumption correction coefficient $K_{\text{fuel,FCHV}}$

For NOVC-FCHVs, the fuel consumption correction coefficient $K_{\text{fuel,FCHV}}$, determined by driving a set of charge-sustaining Type 1 tests, is defined using the following equation:

$$K_{\text{fuel,FCHV}} = \frac{\sum_{n=1}^{n_{\text{CS}}} ((EC_{\text{DC,CS},n} - EC_{\text{DC,CS,avg}}) \times (FC_{\text{CS},nb,n} - FC_{\text{CS},nb,avg}))}{\sum_{n=1}^{n_{\text{CS}}} (EC_{\text{DC,CS},n} - EC_{\text{DC,CS,avg}})^2}$$

where:

$K_{\text{fuel,FCHV}}$ is the fuel consumption correction coefficient, (kg/100 km)/(Wh/km);
 $EC_{\text{DC,CS},n}$ is the charge-sustaining electric energy consumption of test n based on the REESS depletion according to the equation below, Wh/km
 $EC_{\text{DC,CS,avg}}$ is the mean charge-sustaining electric energy consumption of n_{CS} tests based on the REESS depletion according to the equation below, Wh/km;
 $FC_{\text{CS},nb,n}$ is the charge-sustaining fuel consumption of test n, not corrected for the energy balance, according to Table A8/7, step no. 1, kg/100 km;
 $FC_{\text{CS},nb,avg}$ is the arithmetic average of the charge-sustaining fuel consumption of n_{CS} tests based on the fuel consumption, not corrected for the energy balance, according to the equation below, kg/100 km;
 n is the index number of the considered test;
 n_{CS} is the total number of tests;

and:

$$EC_{\text{DC,CS,avg}} = \frac{1}{n_{\text{CS}}} \times \sum_{n=1}^{n_{\text{CS}}} EC_{\text{DC,CS},n}$$

and:

$$FC_{\text{CS},nb,avg} = \frac{1}{n_{\text{CS}}} \times \sum_{n=1}^{n_{\text{CS}}} FC_{\text{CS},nb,n}$$

and:

$$EC_{\text{DC,CS},n} = \frac{\Delta E_{\text{REESS,CS},n}}{d_{\text{CS},n}}$$

Status: Point in time view as at 01/06/2017.

Changes to legislation: There are outstanding changes not yet made to Commission Regulation (EU) 2017/1151. Any changes that have already been made to the legislation appear in the content and are referenced with annotations. (See end of Document for details)

where:

$\Delta E_{\text{REESS,CS,n}}$ is the charge-sustaining REESS electric energy change of test n according to paragraph 1.1.2. of this Appendix, Wh;
 $d_{\text{CS,n}}$ is the distance driven over the corresponding charge-sustaining Type 1 test n, km.

The fuel consumption correction coefficient shall be rounded to four significant figures. The statistical significance of the fuel consumption correction coefficient shall be evaluated by the approval authority.

2.3.1.1. It is permitted to apply the fuel consumption correction coefficient that was developed from tests over the whole applicable WLTP test cycle for the correction of each individual phase.

2.3.1.2. Without prejudice to the requirements of paragraph 2.2. of this Appendix, at the manufacturer's request and upon approval of the approval authority, separate fuel consumption correction coefficients $K_{\text{fuel,FCHV,p}}$ for each individual phase may be developed. In this case, the same criteria as described in paragraph 2.2. of this Appendix shall be fulfilled in each individual phase and the procedure described in paragraph 2.3.1. of this Appendix shall be applied for each individual phase to determine each phase specific correction coefficient.

2.3.2. Determination of CO₂ mass emission correction coefficient K_{CO_2}

For OVC-HEVs and NOVC-HEVs, the CO₂ mass emission correction coefficient K_{CO_2} , determined by driving a set of charge-sustaining Type 1 tests, is defined by the following equation:

$$K_{\text{CO}_2} = \frac{\sum_{n=1}^{n_{\text{CS}}} ((EC_{\text{DC,CS,n}} - EC_{\text{DC,CS,avg}}) \times (M_{\text{CO}_2,\text{CS,nb,n}} - M_{\text{CO}_2,\text{CS,nb,avg}}))}{\sum_{n=1}^{n_{\text{CS}}} (EC_{\text{DC,CS,n}} - EC_{\text{DC,CS,avg}})^2}$$

where:

K_{CO_2} is the CO₂ mass emission correction coefficient, (g/km)/(Wh/km);
 $EC_{\text{DC,CS,n}}$ is the charge-sustaining electric energy consumption of test n based on the REESS depletion according to paragraph 2.3.1. of this Appendix, Wh/km;
 $EC_{\text{DC,CS,avg}}$ is the arithmetic average of the charge-sustaining electric energy consumption of n_{CS} tests based on the REESS depletion according to paragraph 2.3.1. of this Appendix, Wh/km;
 $M_{\text{CO}_2,\text{CS,nb,n}}$ is the charge-sustaining CO₂ mass emission of test n, not corrected for the energy balance, calculated according Table A8/5, step no. 2, g/km;
 $M_{\text{CO}_2,\text{CS,nb,avg}}$ is the arithmetic average of the charge-sustaining CO₂ mass emission of n_{CS} tests based on the CO₂ mass emission, not corrected for the energy balance, according to the equation below, g/km;
n is the index number of the considered test;
 n_{CS} is the total number of tests;

and:

$$M_{\text{CO}_2,\text{CS,nb,avg}} = \frac{1}{n_{\text{CS}}} \times \sum_{n=1}^{n_{\text{CS}}} M_{\text{CO}_2,\text{CS,nb,n}}$$

The CO₂ mass emission correction coefficient shall be rounded to four significant figures. The statistical significance of the CO₂ mass emission correction coefficient shall be evaluated by the approval authority.

Status: Point in time view as at 01/06/2017.

Changes to legislation: There are outstanding changes not yet made to Commission Regulation (EU) 2017/1151. Any changes that have already been made to the legislation appear in the content and are referenced with annotations. (See end of Document for details)

- 2.3.2.1. It is permitted to apply the CO₂ mass emission correction coefficient developed from tests over the whole applicable WLTP test cycle for the correction of each individual phase.
- 2.3.2.2. Without prejudice to the requirements of paragraph 2.2. of this Appendix, at the request of the manufacturer upon approval of the approval authority, separate CO₂ mass emission correction coefficients $K_{CO_2,p}$ for each individual phase may be developed. In this case, the same criteria as described in paragraph 2.2. of this Appendix shall be fulfilled in each individual phase and the procedure described in paragraph 2.3.2. of this Appendix shall be applied for each individual phase to determine phase-specific correction coefficients.
3. Test procedure for the determination of the correction coefficients
- 3.1. OVC-HEVs

For OVC-HEVs, one of the following test sequences according to Figure A8.App2/1 shall be used to measure all values that are necessary for the determination of the correction coefficients according to paragraph 2. of this Appendix.

Figure A8.App2/1

OVC-HEV test sequences

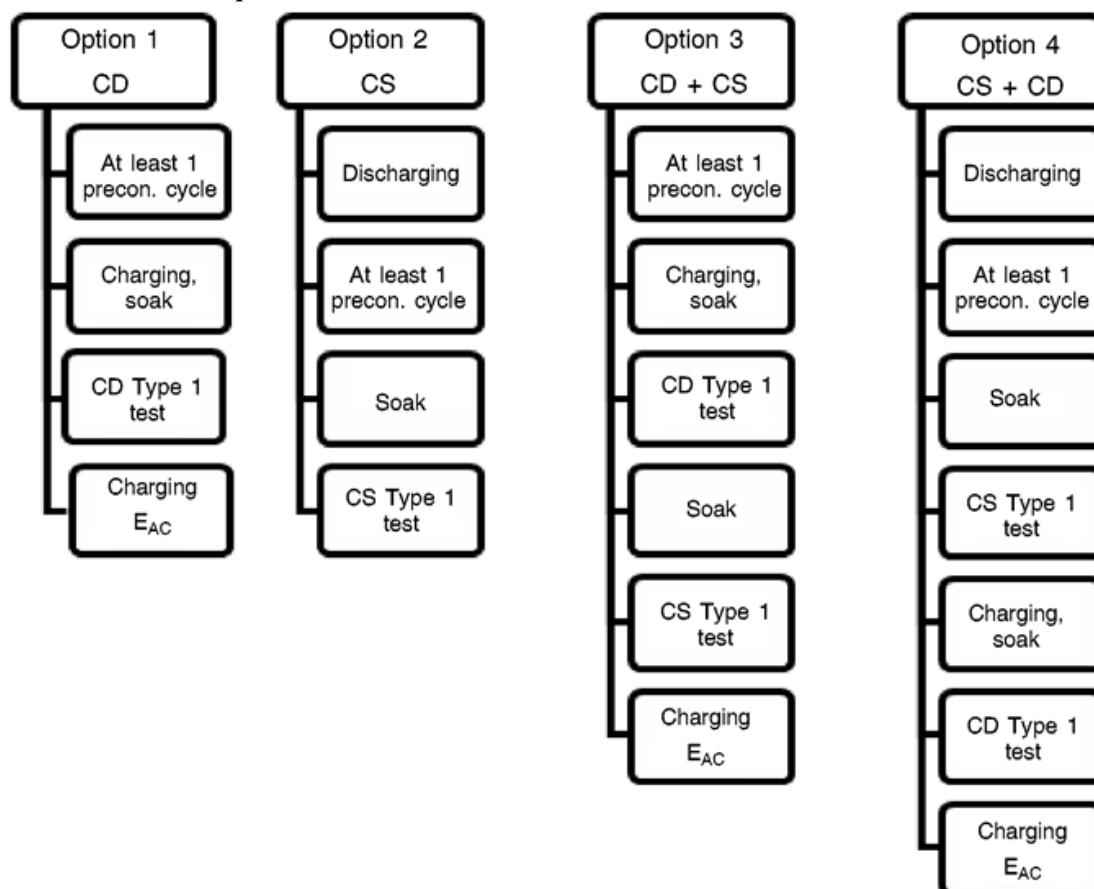

- 3.1.1. Option 1 test sequence

Status: Point in time view as at 01/06/2017.

Changes to legislation: There are outstanding changes not yet made to Commission Regulation (EU) 2017/1151. Any changes that have already been made to the legislation appear in the content and are referenced with annotations. (See end of Document for details)

3.1.1.1. Preconditioning and soaking

Preconditioning and soaking shall be conducted according to paragraph 2.1. of Appendix 4. to this Sub-Annex.

3.1.1.2. REESS adjustment

Prior to the test procedure according to paragraph 3.1.1.3. the manufacturer may adjust the REESS. The manufacturer shall provide evidence that the requirements for the beginning of the test according to paragraph 3.1.1.3. are fulfilled.

3.1.1.3. Test procedure

3.1.1.3.1. The driver-selectable mode for the applicable WLTP test cycle shall be selected according to paragraph 3. of Appendix 6 to this Sub-Annex.

3.1.1.3.2. For testing, the applicable WLTP test cycle according to paragraph 1.4.2. of this Sub-Annex shall be driven.

3.1.1.3.3. Unless stated otherwise in this Appendix, the vehicle shall be tested according to the Type 1 test procedure described in Sub-Annex 6.

3.1.1.3.4. To obtain a set of applicable WLTP test cycles required for the determination of the correction coefficients, the test may be followed by a number of consecutive sequences required according to paragraph 2.2 of this Appendix consisting of paragraph 3.1.1.1. to paragraph 3.1.1.3. inclusive of this Appendix.

3.1.2. Option 2 test sequence

3.1.2.1. Preconditioning

The test vehicle shall be preconditioned according to paragraph 2.1.1. or paragraph 2.1.2. of Appendix 4 to this Sub-Annex.

3.1.2.2. REESS adjustment

After preconditioning, soaking according to paragraph 2.1.3. of Appendix 4 to this Sub-Annex shall be omitted and a break, during which the REESS is permitted to be adjusted, shall be set to a maximum duration of 60 minutes. A similar break shall be applied in advance of each test. Immediately after the end of this break, the requirements of paragraph 3.1.2.3. of this Appendix shall be applied.

Upon request of the manufacturer, an additional warm-up procedure may be conducted in advance of the REESS adjustment to ensure similar starting conditions for the correction coefficient determination. If the manufacturer requests this additional warm-up procedure, the identical warm-up procedure shall be applied repeatedly within the test sequence.

3.1.2.3. Test procedure

3.1.2.3.1. The driver-selectable mode for the applicable WLTP test cycle shall be selected according to paragraph 3. of Appendix 6 to this Sub-Annex.

3.1.2.3.2. For testing, the applicable WLTP test cycle according to paragraph 1.4.2. of this Sub-Annex shall be driven.

3.1.2.3.3. Unless stated otherwise in this Appendix, the vehicle shall be tested according to the Type 1 test procedure described in Sub-Annex 6.

Status: Point in time view as at 01/06/2017.

Changes to legislation: There are outstanding changes not yet made to Commission Regulation (EU) 2017/1151. Any changes that have already been made to the legislation appear in the content and are referenced with annotations. (See end of Document for details)

3.1.2.3.4. To obtain a set of applicable WLTP test cycles that are required for the determination of the correction coefficients, the test may be followed by a number of consecutive sequences required according to paragraph 2.2. of this Appendix consisting of paragraphs 3.1.2.2. and 3.1.2.3. of this Appendix.

3.2. NOVC-HEVs and NOVC-FCHVs

For NOVC-HEVs and NOVC-FCHVs, one of the following test sequences according to Figure A8.App2/2 shall be used to measure all values that are necessary for the determination of the correction coefficients according to paragraph 2. of this Appendix.

Figure A8.App2/2

NOVC-HEV and NOVC-FCHV test sequences

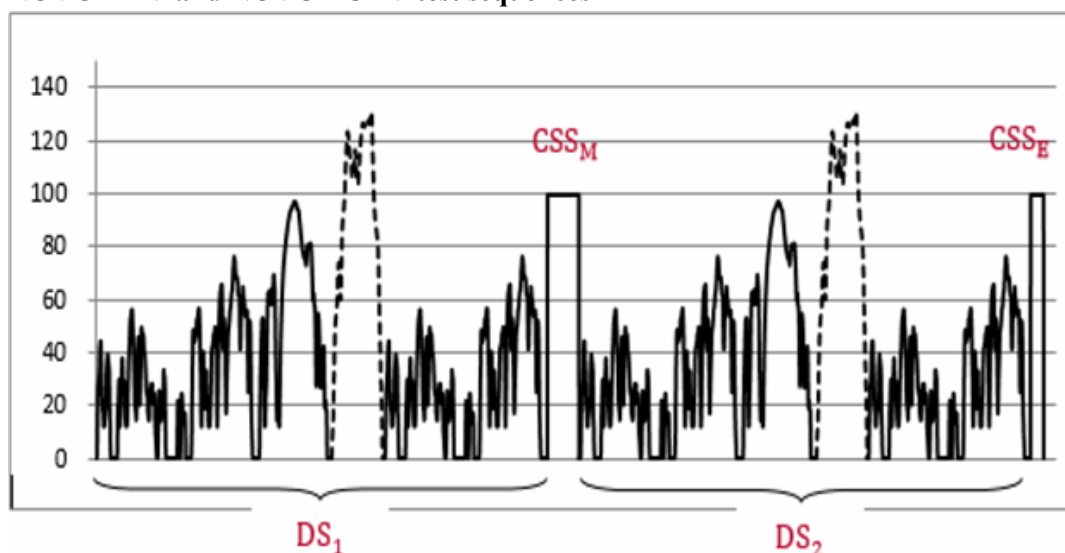

3.2.1. Option 1 test sequence

3.2.1.1. Preconditioning and soaking

The test vehicle shall be preconditioned and soaked according to paragraph 3.3.1. of this Sub-Annex.

3.2.1.2. REESS adjustment

Prior to the test procedure, according to paragraph 3.2.1.3., the manufacturer may adjust the REESS. The manufacturer shall provide evidence that the requirements for the beginning of the test according to paragraph 3.2.1.3. are fulfilled.

3.2.1.3. Test procedure

3.2.1.3.1. The driver-selectable mode shall be selected according to paragraph 3. of Appendix 6 to this Sub-Annex.

3.2.1.3.2. For testing, the applicable WLTP test cycle according to paragraph 1.4.2. of this Sub-Annex shall be driven.

3.2.1.3.3. Unless stated otherwise in this Appendix, the vehicle shall be tested according to the charge-sustaining Type 1 test procedure described in Sub-Annex 6.

Status: Point in time view as at 01/06/2017.

Changes to legislation: There are outstanding changes not yet made to Commission Regulation (EU) 2017/1151. Any changes that have already been made to the legislation appear in the content and are referenced with annotations. (See end of Document for details)

3.2.1.3.4. To obtain a set of applicable WLTP test cycles that are required for the determination of the correction coefficients, the test can be followed by a number of consecutive sequences required according to paragraph 2.2. of this Appendix consisting of paragraph 3.2.1.1. to paragraph 3.2.1.3. inclusive of this Appendix.

3.2.2. Option 2 test sequence

3.2.2.1. Preconditioning

The test vehicle shall be preconditioned according to paragraph 3.3.1.1. of this Sub-Annex.

3.2.2.2. REESS adjustment

After preconditioning, the soaking according to paragraph 3.3.1.2. of this Sub-Annex shall be omitted and a break, during which the REESS is permitted to be adjusted, shall be set to a maximum duration of 60 minutes. A similar break shall be applied in advance of each test. Immediately after the end of this break, the requirements of paragraph 3.2.2.3. of this Appendix shall be applied.

Upon request of the manufacturer, an additional warm-up procedure may be conducted in advance of the REESS adjustment to ensure similar starting conditions for the correction coefficient determination. If the manufacturer requests this additional warm-up procedure, the identical warm-up procedure shall be applied repeatedly within the test sequence.

3.2.2.3. Test procedure

3.2.2.3.1. The driver-selectable mode for the applicable WLTP test cycle shall be selected according to paragraph 3. of Appendix 6 to this Sub-Annex.

3.2.2.3.2. For testing, the applicable WLTP test cycle according to paragraph 1.4.2. of this Sub-Annex shall be driven.

3.2.2.3.3. Unless stated otherwise in this Appendix, the vehicle shall be tested according to the Type 1 test procedure described in Sub-Annex 6.

3.2.2.3.4. To get a set of applicable WLTP test cycles that are required for the determination of the correction coefficients, the test can be followed by a number of consecutive sequences required according to paragraph 2.2. of this Appendix consisting of paragraphs 3.2.2.2. and 3.2.2.3. of this Appendix.

Sub-Annex 8

Appendix 3

Determination of REESS current and REESS voltage for NOVC-HEVs, OVC-HEVs, PEVs and NOVC-FCHVs

1. Introduction

1.1. This Appendix defines the method and required instrumentation to determine the REESS current and the REESS voltage of NOVC-HEVs, OVC-HEVs, PEVs and NOVC-FCHVs.

1.2. Measurement of REESS current and REESS voltage shall start at the same time as the test starts and shall end immediately after the vehicle has finished the test.

Status: Point in time view as at 01/06/2017.

Changes to legislation: There are outstanding changes not yet made to Commission Regulation (EU) 2017/1151. Any changes that have already been made to the legislation appear in the content and are referenced with annotations. (See end of Document for details)

- 1.3. The REESS current and the REESS voltage of each phase shall be determined.
- 1.4. A list of the instrumentation used by the manufacturer to measure REESS voltage and current (including instrument manufacturer, model number, serial number, last calibration dates (where applicable)) during:
- (a) the Type 1 test according to paragraph 3 of this Sub-Annex,
 - (b) the procedure to determine the correction coefficients according to Appendix 2 of this Sub-Annex (where applicable),
 - (c) the ATCT as specified in Sub-Annex 6a
- shall be provided to the approval authority.

2. REESS current

REESS depletion is considered as a negative current.

2.1. External REESS current measurement

- 2.1.1. The REESS current(s) shall be measured during the tests using a clamp-on or closed type current transducer. The current measurement system shall fulfil the requirements specified in Table A8/1 of this Sub-Annex. The current transducer(s) shall be capable of handling the peak currents at engine starts and temperature conditions at the point of measurement.
- 2.1.2. Current transducers shall be fitted to any of the REESS on one of the cables connected directly to the REESS and shall include the total REESS current.

In case of shielded wires, appropriate methods shall be applied in accordance with the approval authority.

In order to easily measure the REESS current using external measuring equipment, the manufacturer should provide appropriate, safe and accessible connection points in the vehicle. If that is not feasible, the manufacturer is obliged to support the approval authority in connecting a current transducer to one of the cables directly connected to the REESS in the manner described above in this paragraph.

- 2.1.3. The current transducer output shall be sampled with a minimum frequency of 20 Hz. The measured current shall be integrated over time, yielding the measured value of Q, expressed in ampere-hours Ah. The integration may be done in the current measurement system.

2.2. Vehicle on-board REESS current data

As an alternative to paragraph 2.1. of this Appendix, the manufacturer may use the on-board current measurement data. The accuracy of these data shall be demonstrated to the approval authority.

3. REESS voltage

3.1. External REESS voltage measurement

During the tests described in paragraph 3. of this Sub-Annex, the REESS voltage shall be measured with the equipment and accuracy requirements specified in paragraph 1.1. of this Sub-Annex. To measure the REESS voltage using external measuring equipment, the manufacturers shall support the approval authority by providing REESS voltage measurement points.

Status: Point in time view as at 01/06/2017.

Changes to legislation: There are outstanding changes not yet made to Commission Regulation (EU) 2017/1151. Any changes that have already been made to the legislation appear in the content and are referenced with annotations. (See end of Document for details)

3.2. Nominal REESS voltage

For NOVC-HEVs, NOVC-FCHVs and OVC-HEVs, instead of using the measured REESS voltage according to paragraph 3.1. of this Appendix, the nominal voltage of the REESS determined according to DIN EN 60050-482 may be used.

3.3. Vehicle on-board REESS voltage data

As an alternative to paragraph 3.1. and 3.2. of this Appendix, the manufacturer may use the on-board voltage measurement data. The accuracy of these data shall be demonstrated to the approval authority.

Sub-Annex 8

Appendix 4

Preconditioning, soaking and REESS charging conditions of PEVs and OVC-HEVs

1. This Appendix describes the test procedure for REESS and combustion engine preconditioning in preparation for:
 - (a) Electric range, charge-depleting and charge-sustaining measurements when testing OVC-HEVs; and
 - (b) Electric range measurements as well as electric energy consumption measurements when testing PEVs.
2. OVC-HEV preconditioning and soaking
 - 2.1. Preconditioning and soaking when the test procedure starts with a charge-sustaining test
 - 2.1.1. For preconditioning the combustion engine, the vehicle shall be driven over at least one applicable WLTP test cycle. During each driven preconditioning cycle, the charging balance of the REESS shall be determined. The preconditioning shall be stopped at the end of the applicable WLTP test cycle during which the break-off criterion is fulfilled according to paragraph 3.2.4.5. of this Sub-Annex.
 - 2.1.2. As an alternative to paragraph 2.1.1. of this Appendix, at the request of the manufacturer and upon approval of the approval authority, the state of charge of the REESS for the charge-sustaining Type 1 test may be set according to the manufacturer's recommendation in order to achieve a test under charge-sustaining operating condition.

In such a case, a preconditioning procedure, such as that applicable to conventional vehicles as described in paragraph 1.2.6. of Sub-Annex 6, shall be applied.

- 2.1.3. Soaking of the vehicle shall be performed according to paragraph 1.2.7. of Sub-Annex 6.
- 2.2. Preconditioning and soaking when the test procedure starts with a charge-depleting test
 - 2.2.1. OVC-HEVs shall be driven over at least one applicable WLTP test cycle. During each driven preconditioning cycle, the charging balance of the REESS shall be determined. The preconditioning shall be stopped at the end of the applicable WLTP test cycle

Status: Point in time view as at 01/06/2017.

Changes to legislation: There are outstanding changes not yet made to Commission Regulation (EU) 2017/1151. Any changes that have already been made to the legislation appear in the content and are referenced with annotations. (See end of Document for details)

during which the break-off criterion is fulfilled according to paragraph 3.2.4.5. of this Sub-Annex.

2.2.2. Soaking of the vehicle shall be performed according to paragraph 1.2.7. of Sub-Annex 6. Forced cooling down shall not be applied to vehicles preconditioned for the Type 1 test. During soak, the REESS shall be charged using the normal charging procedure as defined in paragraph 2.2.3. of this Appendix.

2.2.3. Application of a normal charge

2.2.3.1. The REESS shall be charged at an ambient temperature as specified in paragraph 1.2.2.2.2. of Sub-Annex 6 either with:

- (a) The on-board charger if fitted; or
- (b) An external charger recommended by the manufacturer using the charging pattern prescribed for normal charging.

The procedures in this paragraph exclude all types of special charges that could be automatically or manually initiated, e.g. equalization charges or servicing charges. The manufacturer shall declare that, during the test, a special charge procedure has not occurred.

2.2.3.2. End-of-charge criterion

The end-of-charge criterion is reached when the on-board or external instruments indicate that the REESS is fully charged.

3. PEV preconditioning

3.1. Initial charging of the REESS

Initial charging of the REESS consists of discharging the REESS and applying a normal charge.

3.1.1. Discharging the REESS

The discharge procedure shall be performed according to the manufacturer's recommendation. The manufacturer shall guarantee that the REESS is as fully depleted as is possible by the discharge procedure.

3.1.2. Application of a normal charge

The REESS shall be charged according to paragraph 2.2.3.1. of this Appendix.

Sub-Annex 8

Appendix 5

Utility factors (UF) for OVC-HEVs

1. Utility Factors (UFs) are ratios based on driving statistics and the ranges achieved in charge-depleting mode and charge-sustaining modes for OVC-HEVs and are used for weighting emissions, CO₂ emissions and fuel consumptions.

The database used to calculate the Utility Factors in paragraph 2. was predominantly based on the use characteristics (e.g. utilization, daily driven distance, shares of different vehicle classes) of conventional vehicles. It will be necessary to re-evaluate UF and charging frequencies by

Status: Point in time view as at 01/06/2017.

Changes to legislation: There are outstanding changes not yet made to Commission Regulation (EU) 2017/1151. Any changes that have already been made to the legislation appear in the content and are referenced with annotations. (See end of Document for details)

a customer study once a significant number of OVC-HEV vehicles are in use in the European market.

2. For the calculation of each phase specific utility factor (UF), the following equation shall be applied:

$$UF_i(d_i) = 1 - \exp\left(-\left(\sum_{j=1}^k C_j \times \left(\frac{d_i}{d_n}\right)^j\right)\right) - \sum_{i=1}^{i-1} UF_i$$

Where:

UF_i	Utility factor for phase i.
d_i	Distance driven to the end of phase i in km.
C_j	j^{th} coefficient (see Table A8.App5/1).
d_n	Normalized distance (see Table A8.App5/1).
k	Amount of terms and coefficients in the exponent (see Table A8.App5/1).
i	Number of considered phase.
j	Number of considered term/coefficient.
$\sum_{i=1}^{i-1} UF_i$	Sum of calculated utility factors up to phase (i-1).

The curve that is based on the following parameters in Table A8.App5/1 is valid from 0 km to the normalized distance d_n where the UF converges to 1.0 (as can be seen in Figure A8/App5/1).

Table A8.App5/1

Parameter to be used in Equation y	
C_1	26,25
C_2	-38,94
C_3	-631,05
C_4	5 964,83
C_5	-25 094,6
C_6	60 380,21
C_7	-87 517,16
C_8	75 513,77
C_9	-35 748,77
C_{10}	7 154,94
$d_n[\text{km}]$	800
k	10

The curve shown below in Figure A8/App5/1 is provided for illustrative purposes only. It does not form part of the regulatory text.

Figure A8.App5/1

Status: Point in time view as at 01/06/2017.

Changes to legislation: There are outstanding changes not yet made to Commission Regulation (EU) 2017/1151. Any changes that have already been made to the legislation appear in the content and are referenced with annotations. (See end of Document for details)

Utility Factor curve based on equation parameter of Table A8.App5/1

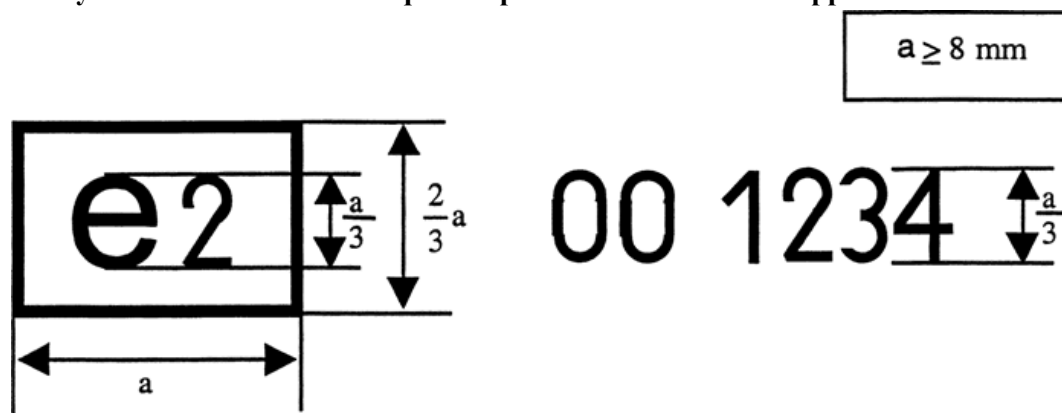

Sub-Annex 8

Appendix 6

Selection of driver-selectable modes

1. General requirement
 - 1.1. The manufacturer shall select the driver-selectable mode for the Type 1 test procedure according to paragraph 2. to paragraph 4. inclusive of this Appendix which enables the vehicle to follow the considered test cycle within the speed trace tolerances according to paragraph 1.2.6.6. of Sub-Annex 6.
 - 1.2. The manufacturer shall provide evidence to the approval authority concerning:
 - (a) the availability of a predominant mode under the considered conditions;
 - (b) the maximum speed of the considered vehicle;and if required:
 - (c) the best and worst case mode identified by the evidence on the fuel consumption and, if applicable, on the CO₂ mass emission in all modes (see Sub-Annex 6, paragraph 1.2.6.5.2.4.);
 - (d) the highest electric energy consuming mode;
 - (e) the cycle energy demand (according to paragraph 5. of Sub-Annex 7, where the target speed is replaced by the actual speed).
 - 1.3. Dedicated driver-selectable modes, such as 'mountain mode' or 'maintenance mode' which are not intended for normal daily operation but only for special limited purposes, shall not be considered.
2. OVC-HEV equipped with a driver-selectable mode under charge-depleting operating condition

For vehicles equipped with a driver-selectable mode, the mode for the charge-depleting Type 1 test shall be selected according to the following conditions.

Status: Point in time view as at 01/06/2017.

Changes to legislation: There are outstanding changes not yet made to Commission Regulation (EU) 2017/1151. Any changes that have already been made to the legislation appear in the content and are referenced with annotations. (See end of Document for details)

The flow chart in Figure A8.App6/1 illustrates the mode selection according to paragraph 2. of this Appendix.

- 2.1. If there is a predominant mode that enables the vehicle to follow the reference test cycle under charge-depleting operating condition, this mode shall be selected.
- 2.2. If there is no predominant mode or if there is a predominant mode but this mode does not enable the vehicle to follow the reference test cycle under charge-depleting operating condition, the mode for the test shall be selected according to the following conditions:
 - (a) If there is only one mode which allows the vehicle to follow the reference test cycle under charge-depleting operating conditions, this mode shall be selected;
 - (b) If several modes are capable of following the reference test cycle under charge-depleting operating conditions, the most electric energy consuming mode of those shall be selected.
- 2.3. If there is no mode according to paragraph 2.1. and paragraph 2.2. of this Appendix that enables the vehicle to follow the reference test cycle, the reference test cycle shall be modified according to paragraph 9 of Sub-Annex 1:
 - (a) If there is a predominant mode which allows the vehicle to follow the modified reference test cycle under charge-depleting operating conditions, this mode shall be selected.
 - (b) If there is no predominant mode but other modes which allow the vehicle to follow the modified reference test cycle under charge-depleting operating condition, the mode with the highest electric energy consumption shall be selected.
 - (c) If there is no mode which allows the vehicle to follow the modified reference test cycle under charge-depleting operating condition, the mode or modes with the highest cycle energy demand shall be identified and the mode with the highest electric energy consumption shall be selected.

Figure A8.App6/1

Status: Point in time view as at 01/06/2017.

Changes to legislation: There are outstanding changes not yet made to Commission Regulation (EU) 2017/1151. Any changes that have already been made to the legislation appear in the content and are referenced with annotations. (See end of Document for details)

Selection of driver-selectable mode for OVC-HEVs under charge-depleting operating condition

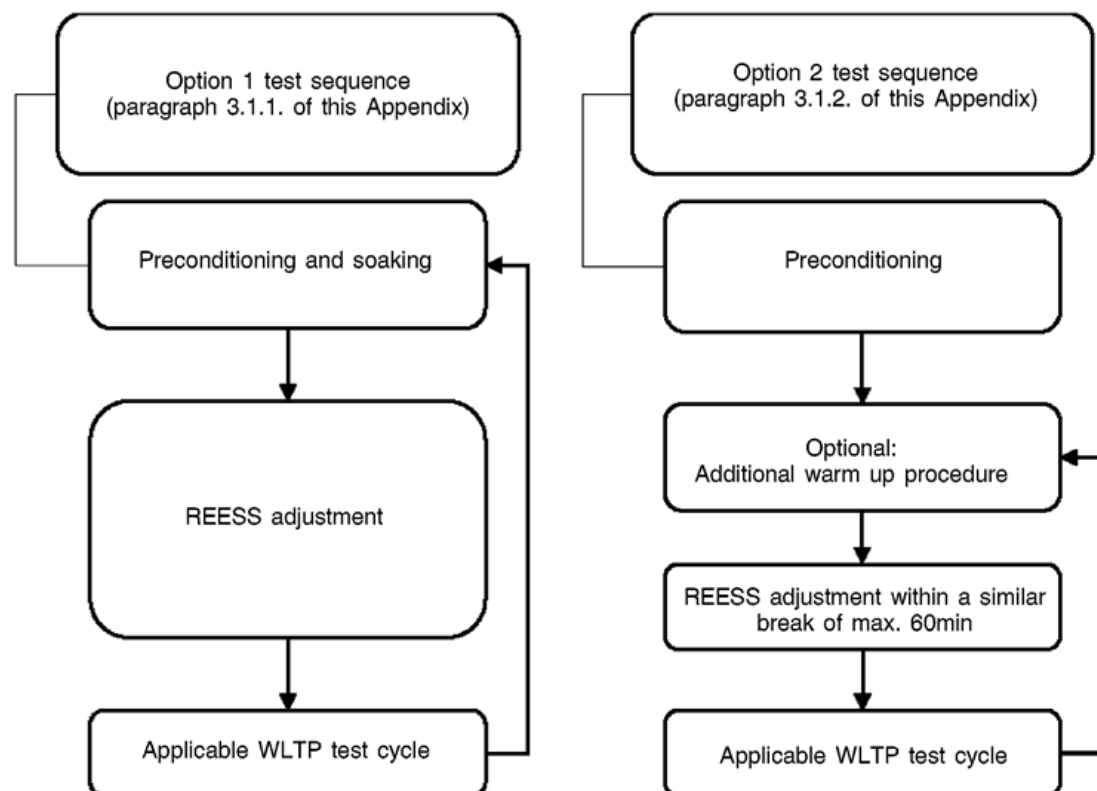

3. OVC-HEVs, NOVC-HEVs and NOVC-FCHVs equipped with a driver-selectable mode under charge-sustaining operating condition

For vehicles equipped with a driver-selectable mode, the mode for the charge-sustaining Type 1 test shall be selected according to the following conditions.

The flow chart in Figure A8.App6/2 illustrates the mode selection according to paragraph 3. of this Appendix.

- 3.1. If there is a predominant mode that enables the vehicle to follow the reference test cycle under charge-sustaining operating condition, this mode shall be selected.
- 3.2. If there is no predominant mode or if there is a predominant mode but this mode does not enable the vehicle to follow the reference test cycle under charge-sustaining operating condition, the mode for the test shall be selected according to the following conditions:
 - (a) If there is only one mode which allows the vehicle to follow the reference test cycle under charge-sustaining operating conditions, this mode shall be selected;
 - (b) If several modes are capable of following the reference test cycle under charge-sustaining operating conditions, it shall be at the option of the manufacturer either to select the worst case mode or to select both best case mode and worst case mode and average the test results arithmetically.

Status: Point in time view as at 01/06/2017.

Changes to legislation: There are outstanding changes not yet made to Commission Regulation (EU) 2017/1151. Any changes that have already been made to the legislation appear in the content and are referenced with annotations. (See end of Document for details)

- 3.3. If there is no mode according to paragraph 3.1. and paragraph 3.2. of this Appendix that enables the vehicle to follow the reference test cycle, the reference test cycle shall be modified according to paragraph 9. of Sub-Annex 1:
- (a) If there is a predominant mode which allows the vehicle to follow the modified reference test cycle under charge-sustaining operating condition, this mode shall be selected.
 - (b) If there is no predominant mode but other modes which allow the vehicle to follow the modified reference test cycle under charge-sustaining operating condition, the worst case mode of these modes shall be selected.
 - (c) If there is no mode which allows the vehicle to follow the modified reference test cycle under charge-sustaining operating condition, the mode or modes with the highest cycle energy demand shall be identified and the worst case mode shall be selected.

Figure A8.App6/2

Selection of a driver-selectable mode for OVC-HEVs, NOVC-HEVs and NOVC- FCHVs under charge-sustaining operating condition

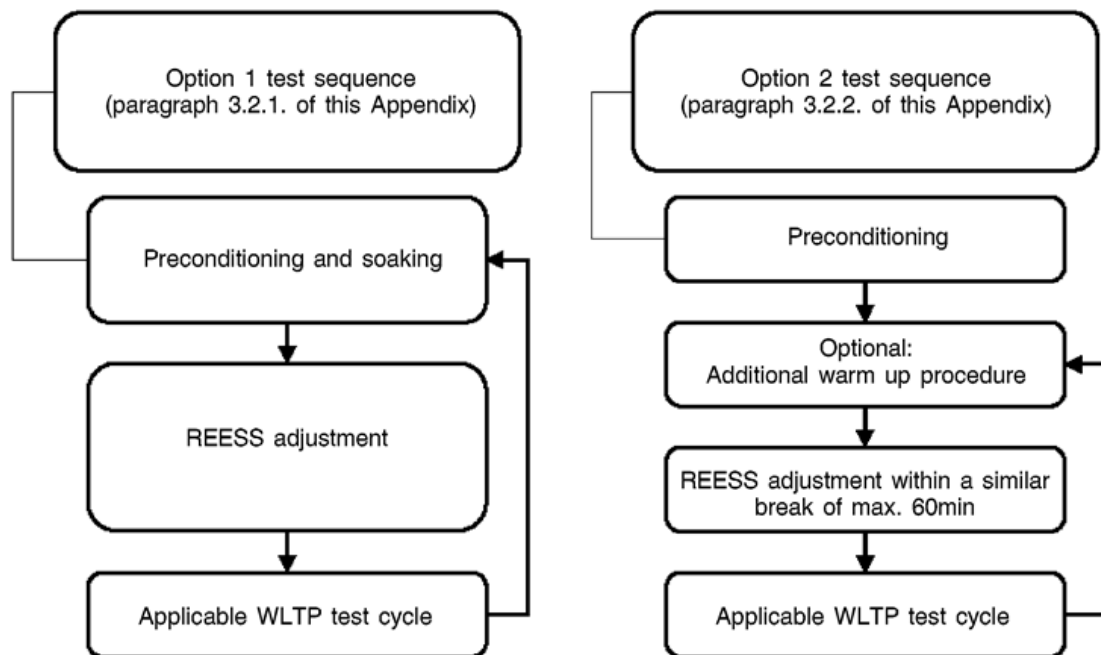

4. PEVs equipped with a driver-selectable mode

For vehicles equipped with a driver-selectable mode, the mode for the test shall be selected according to the following conditions.

The flow chart in Figure A8.App 6/3 illustrates the mode selection according to paragraph 3. of this Appendix.

- 4.1. If there is a predominant mode that enables the vehicle to follow the reference test cycle, this mode shall be selected.
- 4.2. If there is no predominant mode or if there is a predominant mode but this mode does not enable the vehicle to follow the reference test cycle, the mode for the test shall be selected according to the following conditions.

Status: Point in time view as at 01/06/2017.

Changes to legislation: There are outstanding changes not yet made to Commission Regulation (EU) 2017/1151. Any changes that have already been made to the legislation appear in the content and are referenced with annotations. (See end of Document for details)

- (a) If there is only one mode which allows the vehicle to follow the reference test cycle, this mode shall be selected.
 - (b) If several modes are capable of following the reference test cycle, the most electric energy consuming mode of those shall be selected.
- 4.3. If there is no mode according to paragraph 4.1. and paragraph 4.2. of this Appendix that enables the vehicle to follow the reference test cycle, the reference test cycle shall be modified according to paragraph 9. of Sub-Annex 1. The resulting test cycle shall be named as the applicable WLTP test cycle:
- (a) If there is a predominant mode which allows the vehicle to follow the modified reference test cycle, this mode shall be selected;
 - (b) If there is no predominant mode but other modes which allow the vehicle to follow the modified reference test cycle, the mode with the highest electric energy consumption shall be selected;
 - (c) If there is no mode which allows the vehicle to follow the modified reference test cycle, the mode or modes with the highest cycle energy demand shall be identified and the mode with the highest electric energy consumption shall be selected.

Figure A8.App6/3

Selection of the driver-selectable mode for PEVs

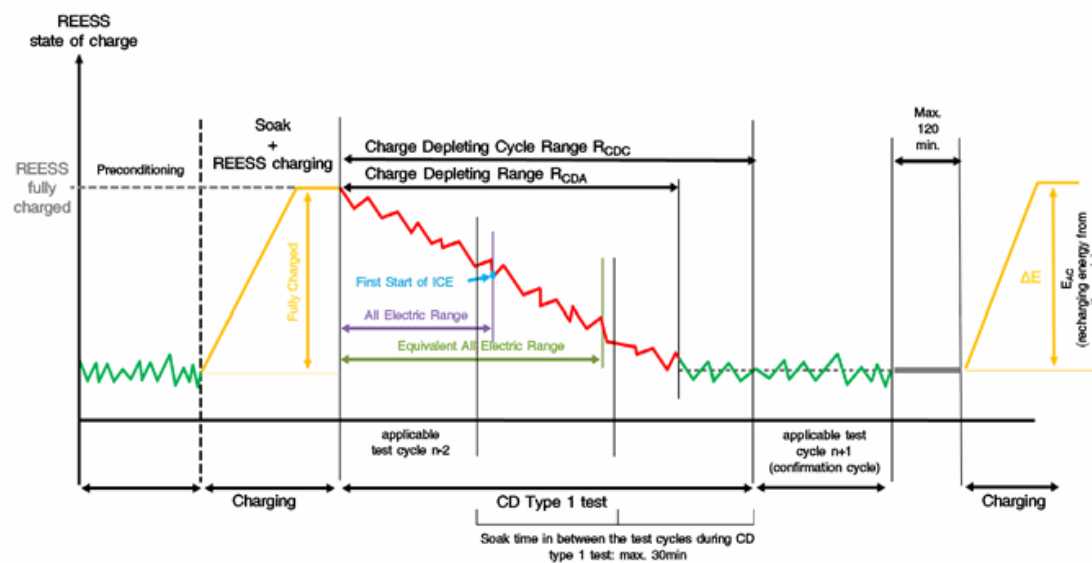

Sub-Annex 8

Appendix 7

Fuel consumption measurement of compressed hydrogen fuel cell hybrid vehicles

- 1. General requirements
 - 1.1. Fuel consumption shall be measured using the gravimetric method in accordance with paragraph 2. of this Appendix.

Status: Point in time view as at 01/06/2017.

Changes to legislation: There are outstanding changes not yet made to Commission Regulation (EU) 2017/1151. Any changes that have already been made to the legislation appear in the content and are referenced with annotations. (See end of Document for details)

At the request of the manufacturer and with approval of the approval authority, fuel consumption may be measured using either the pressure method or the flow method. In this case, the manufacturer shall provide technical evidence that the method yields equivalent results. The pressure and flow methods are described in ISO23828.

2. Gravimetric method

Fuel consumption shall be calculated by measuring the mass of the fuel tank before and after the test.

2.1. Equipment and setting

2.1.1. An example of the instrumentation is shown in Figure A8.App7/1. One or more off-vehicle tanks shall be used to measure the fuel consumption. The off-vehicle tank(s) shall be connected to the vehicle fuel line between the original fuel tank and the fuel cell system.

2.1.2. For preconditioning, the originally installed tank or an external source of hydrogen may be used.

2.1.3. The refuelling pressure shall be adjusted to the manufacturer's recommended value.

2.1.4. Difference of the gas supply pressures in lines shall be minimized when the lines are switched.

In the case that influence of pressure difference is expected, the manufacturer and approval authority shall agree whether correction is necessary or not.

2.1.5. Precision balance

2.1.5.1. The precision balance used for fuel consumption measurement shall meet the specification of Table A8.App7/1.

Table A8.App7/1

Analytical balance verification criteria

Measurement	Resolution (readability)	Precision (repeatability)
Precision balance	0,1 g maximum	0,02 maximum ^a

^a Fuel consumption (REESS charge balance = 0) during the test, in mass, standard deviation.

2.1.5.2. The precision balance shall be calibrated in accordance with the specifications provided by the balance manufacturer or at least as often as specified in Table A8.App7/2.

Table A8.App7/2

Instrument calibration intervals

Instrument checks	Interval
Precision (Repeatability)	Yearly and at major maintenance

2.1.5.3. Appropriate means for reducing the effects of vibration and convection, such as a damping table or a wind barrier, shall be provided.

Figure A8.App7/1

Status: Point in time view as at 01/06/2017.

Changes to legislation: There are outstanding changes not yet made to Commission Regulation (EU) 2017/1151. Any changes that have already been made to the legislation appear in the content and are referenced with annotations. (See end of Document for details)

Example of instrumentation

<p>Annex II</p> <p>to</p> <p>Manufacturer's Certificate on Access to Vehicle OBD and Vehicle Repair and Maintenance Information</p> <p>Contact details of the manufacturer's representative referred to by this Certificate:</p> <p>.....</p> <p>.....</p> <p>.....</p> <p>.....</p>
--

where:

- 1 is the external fuel supply for preconditioning
 - 2 is the pressure regulator
 - 3 is the original tank
 - 4 is the fuel cell system
 - 5 is the precision balance
 - 6 is/are off-vehicle tank(s) for fuel consumption measurement
- 2.2. Test procedure
 - 2.2.1. The mass of the off-vehicle tank shall be measured before the test.
 - 2.2.2. The off-vehicle tank shall be connected to the vehicle fuel line as shown in Figure A8.App7/1.
 - 2.2.3. The test shall be conducted by fuelling from the off-vehicle tank.
 - 2.2.4. The off-vehicle tank shall be removed from the line.
 - 2.2.5. The mass of the tank after the test shall be measured.
 - 2.2.6. The non-balanced charge-sustaining fuel consumption $FC_{CS,nb}$ from the measured mass before and after the test shall be calculated using the following equation:

$$FC_{CS,nb} = \frac{g_1 - g_2}{d} \times 100$$

where:

Status: Point in time view as at 01/06/2017.

Changes to legislation: There are outstanding changes not yet made to Commission Regulation (EU) 2017/1151. Any changes that have already been made to the legislation appear in the content and are referenced with annotations. (See end of Document for details)

FC _{CS,nb}	is the non-balanced charge-sustaining fuel consumption measured during the test, kg/100km;
g ₁	is the mass of the tank at the start of the test, kg;
g ₂	is the mass of the tank at the end of the test, kg;
d	is the distance driven during the test, km.
FC _{CS,nb,p}	

Sub-Annex 9

Determination of method equivalency

1. General Requirement

Upon request of the manufacturer, other measurement methods may be approved by the approval authority if they yield equivalent results in accordance with paragraph 1.1. of this Sub-Annex. The equivalence of the candidate method shall be demonstrated to the approval authority.

1.1. Decision on Equivalency

A candidate method shall be considered equivalent if the accuracy and the precision is equal to or better than the reference method.

1.2. Determination of Equivalency

The determination of method equivalency shall be based on a correlation study between the candidate and the reference methods. The methods to be used for correlation testing shall be subject to approval by the approval authority.

The basic principle for the determination of accuracy and precision of candidate and reference methods shall follow the guidelines in ISO 5725 Part 6 Annex 8 'Comparison of alternative Measurement Methods'.

1.3. Implementation requirements

Reserved

Status: Point in time view as at 01/06/2017.

Changes to legislation: There are outstanding changes not yet made to Commission Regulation (EU) 2017/1151. Any changes that have already been made to the legislation appear in the content and are referenced with annotations. (See end of Document for details)

- (1) [OJ L 171, 29.6.2007, p. 1.](#)
- (2) [OJ L 263, 9.10.2007, p. 1.](#)
- (3) Commission Regulation (EC) No 692/2008 of 18 July 2008 implementing and amending Regulation (EC) No 715/2007 of the European Parliament and of the Council on type-approval of motor vehicles with respect to emissions from light passenger and commercial vehicles (Euro 5 and Euro 6) and on access to vehicle repair and maintenance information ([OJ L 199, 28.7.2008, p. 1.](#))
- (4) Commission Regulation (EU) 2016/427 of 10 March 2016 amending Regulation (EC) No 692/2008 as regards emissions from light passenger and commercial vehicles (Euro 6) ([OJ L 82, 31.3.2016, p. 1.](#))
- (5) Commission Regulation (EU) 2016/646 of 20 April 2016 amending Regulation (EC) No 692/2008 as regards emissions from light passenger and commercial vehicles (Euro 6) ([OJ L 109, 26.4.2016, p. 1.](#))
- (6) Regulation No 83 of the Economic Commission for Europe of the United Nations (UNECE) — Uniform provisions concerning the approval of vehicles with regard to the emission of pollutants according to engine fuel requirements [2015/1038] ([OJ L 172, 3.7.2015, p. 1.](#))
- (7) Regulation No 85 of the Economic Commission for Europe of the United Nations (UN/ECE) — Uniform provisions concerning the approval of internal combustion engines or electric drive trains intended for the propulsion of motor vehicles of categories M and N with regard to the measurement of net power and the maximum 30 minutes power of electric drive trains ([OJ L 323, 7.11.2014, p. 52.](#))
- (8) Regulation No 103 of the Economic Commission for Europe of the United Nations (UN/ECE) — Uniform provisions concerning the approval of replacement catalytic converters for power-driven vehicles ([OJ L 158, 19.6.2007, p. 106.](#))
- (9) Commission Implementing Regulation (EU) 2017/1152 of 2 June 2017 setting out a methodology for determining the correlation parameters necessary for reflecting the change in the regulatory test procedure with regard to light commercial vehicles and amending Implementing Regulation (EU) No 293/2012 (See page 644 of this Official Journal).
- (10) Commission Implementing Regulation (EU) 2017/1153 of 2 June 2017 setting out a methodology for determining the correlation parameters necessary for reflecting the change in the regulatory test procedure and amending Regulation (EU) No 1014/2010 (See page 679 of this Official Journal).’
- (11) Commission Regulation (EU) No 1230/2012 of 12 December 2012 implementing Regulation (EC) No 661/2009 of the European Parliament and of the Council with regard to type-approval requirements for masses and dimensions of motor vehicles and their trailers and amending Directive 2007/46/EC of the European Parliament and of the Council ([OJ L 353, 21.12.2012, p. 31.](#))
- (12) Delete where not applicable (there are cases where nothing needs to be deleted when more than one entry is applicable)
- (13) Type of tyre according UN/ECE Regulation 117
- (14) Indicate the applicable procedure.
- (15) For vehicles equipped with positive-ignition engines.
- (16) For compression-ignition engine vehicles
- (17) Measured over the combined cycle
- (18) Repeat the table for each reference fuel tested.
- (19) Expand the table if necessary, using one extra row per eco-innovation.
- (20) The general code of the eco-innovation(s) shall consist of the following elements, each separated by a blank space:
 - Code of the type-approval authority as set out in Annex VII to Directive 2007/46/EC;
 - Individual code of each eco-innovation fitted in the vehicle, indicated in chronological order of the Commission approval decisions.(E.g. the general code of three eco-innovations approved chronologically as 10, 15 and 16 and fitted to a vehicle certified by the German type approval authority should be: ‘e1 10 15 16’)
- (21) [OJ L 140, 5.6.2009, p. 88.](#)

Status: Point in time view as at 01/06/2017.

Changes to legislation: There are outstanding changes not yet made to Commission Regulation (EU) 2017/1151. Any changes that have already been made to the legislation appear in the content and are referenced with annotations. (See end of Document for details)

- (22) Commission Regulation (EU) No 1230/2012 of 12 December 2012 implementing Regulation (EC) No 661/2009 of the European Parliament and of the Council with regard to type-approval requirements for masses and dimensions of motor vehicles and their trailers and amending Directive 2007/46/EC of the European Parliament and of the Council (OJ L 353, 21.12.2012, p. 31).
- (23) Regulation (EEC, Euratom) No 1182/71 of the Council of 3 June 1971 determining the rules applicable to periods, dates and time limits (OJ L 124, 8.6.1971, p. 1).
- (24) For hybrids, the total energy consumption shall be converted to CO₂. The rules for this conversion will be introduced in a second step.
- (25) 1 for Germany; 2 for France; 3 for Italy; 4 for the Netherlands; 5 for Sweden; 6 for Belgium; 7 for Hungary; 8 for the Czech Republic; 9 for Spain; 11 for the United Kingdom; 12 for Austria; 13 for Luxembourg; 17 for Finland; 18 for Denmark; 19 for Romania; 20 for Poland; 21 for Portugal; 23 for Greece; 24 for Ireland; 25 for Croatia; 26 for Slovenia; 27 for Slovakia; 29 for Estonia; 32 for Latvia; 34 for Bulgaria; 36 for Lithuania; 49 for Cyprus; 50 for Malta
- (26) OJ L 326, 24.11.2006
- (27) Grms: The root mean square (rms) value of the vibration signal is calculated by squaring the magnitude of the signal at every point, finding the average (mean) value of the squared magnitude, then taking the square root of the average value. The resulting number is the Grms metric.
- (28) Delete where not applicable.
- (29) Delete where not applicable
- (30) Delete where not applicable
- (31) Delete where not applicable
- (32) Delete where not applicable
- (33) Delete where not applicable
- (34) If the means of identification of type contains characters not relevant to describe the vehicle, component or separate technical unit types covered by this type-approval certificate such characters shall be represented in the document by the symbol: ‘?’ (e.g. ABC??123??).
- (35) Delete where not applicable
- (36) Available at: <http://www.oasis-open.org/committees/download.php/2412/Draft%20Committee%20Specification.pdf>
- (37) Available at: <http://lists.oasis-open.org/archives/autorepair/200302/pdf00005.pdf>
- (38) OJ L 323, 7.11.2014, p. 91.
- (39) OJ L 145 31.5.2011, p. 1.’
- (40) When restrictions for the fuel are applicable, indicate these restrictions (e.g. for natural gas the L range or the H range).
- (41) For bi fuel vehicles, the table shall be repeated for both fuels.
- (42) For flex fuel vehicles, when the test is to be performed on both fuels, according to Figure I.2.4 of Annex I to Regulation (EU) 2017/1151, and for vehicles running on LPG or NG/Biomethane, either bi-fuel or mono-fuel, the table shall be repeated for the different reference gases used in the test, and an additional table shall display the worst results obtained. When applicable, in accordance with paragraph 3.1.4. of Annex 12 to UN/ECE Regulation No 83, it shall be shown if the results are measured or calculated.
- (43) For bi fuel vehicles, the table shall be repeated for both fuels.
- (44) For flex fuel vehicles, when the test is to be performed on both fuels, according to Figure I.2.4 of Annex I to Regulation (EU) 2017/1151, and for vehicles running on LPG or NG/Biomethane, either bi-fuel or mono-fuel, the table shall be repeated for the different reference gases used in the test, and an additional table shall display the worst results obtained. When applicable, in accordance with paragraph 3.1.4. of Annex 12 to UN/ECE Regulation No 83, it shall be shown if the results are measured or calculated.

Status: Point in time view as at 01/06/2017.

Changes to legislation: There are outstanding changes not yet made to Commission Regulation (EU) 2017/1151. Any changes that have already been made to the legislation appear in the content and are referenced with annotations. (See end of Document for details)

- (45) Delete where not applicable.
- (46) Delete where not applicable.
- (47) When restrictions for the fuel are applicable, indicate these restrictions (e.g. for natural gas the L range or the H range).
- (48) If applicable.
- (49) For Euro VI, ESC shall be understood as WHSC and ETC as WHTC.
- (50) For Euro VI, if CNG and LPG fuelled engines are tested on different reference fuels, the table shall be reproduced for each reference fuel tested.
- (51) If applicable.
- (52) For Euro VI, ESC shall be understood as WHSC and ETC as WHTC.
- (53) For Euro VI, if CNG and LPG fuelled engines are tested on different reference fuels, the table shall be reproduced for each reference fuel tested.
- (54) If applicable.
- (55) If applicable.
- (56) Repeat the table for each reference fuel tested.
- (57) If applicable.
- (58) If applicable.
- (59) If applicable.
- (60) (h¹) Repeat the table for each variant/version.
- (61) (h²) Repeat the table for each reference fuel tested
- (62) (h³) Expand the table if necessary, using one extra row per eco-innovation.
- (63) (h⁸) The general code of the eco-innovation(s) shall consist of the following elements each separated by a blank space:
 - Code of the approval authority as set out in Annex VII;
 - Individual code of each eco-innovation fitted in the vehicle, indicated in chronological order of the Commission approval decisions.
(E.g. the general code of three eco-innovations approved chronologically as 10, 15 and 16 and fitted to a vehicle certified by the German type-approval authority should be: “e1 10 15 16”).
- (64) Indicate the identification code —
- (65) Indicate whether the vehicle is suitable for use in either right or left-hand traffic or both right and left-hand traffic.
- (66) Indicate whether the speedometer and/or odometer fitted has metric or both metric and imperial units.
- (67) This statement shall not restrict the right of the Member States to require technical adaptations in order to allow the registration of a vehicle in a Member State other than the one for which it was intended when the direction of the traffic is on the opposite side of the road.
- (68) Delete where not applicable
- (69) Entries 4 and 4.1 shall be completed in accordance with definitions 25 (Wheelbase) and 26 (Axle spacing) of Regulation (EU) No 1230/2012 respectively
- (70) For hybrid electric vehicles, indicate both power outputs.
- (71) In the case of more than one electric motor indicate the consolidated effect of all the engines.’
- (72) Optional equipment under this letter can be added under entry “Remarks”.

Status: Point in time view as at 01/06/2017.

Changes to legislation: There are outstanding changes not yet made to Commission Regulation (EU) 2017/1151. Any changes that have already been made to the legislation appear in the content and are referenced with annotations. (See end of Document for details)

- (73) The codes described in Annex II Letter C shall be used.
- (74) Indicate only the basic colour(s) as follows: white, yellow, orange, red, violet, blue, green, grey, brown or black.
- (75) Excluding seats designated for use only when the vehicle is stationary and the number of wheelchair positions.
For coaches belonging to the vehicle category M₃ the number of crew members shall be included in the passenger number.
- (76) Add the number of the Euro level and the character corresponding to the provisions used for type-approval.
- (77) Repeat for the various fuels that can be used. Vehicles that can be fuelled with both petrol and gaseous fuel but in which the petrol system is fitted for emergency purposes or for starting only and the petrol tank of which cannot contain more than 15 litres of petrol will be regarded as vehicles that can only run on a gaseous fuel.
- (78) In case of EURO VI dual-fuel engines and vehicles, repeat as appropriate.
- (79) Solely emissions assessed in accordance with the applicable regulatory act or acts shall be stated.
- (80) Only applicable if the vehicle is approved to Regulation (EC) 715/2007
- (81) The general code of the eco-innovation(s) shall consist of the following elements, each separated by a blank space:
— Code of the approval authority as set out in Annex VII;
— Individual code of each eco-innovation fitted in the vehicle, indicated in chronological order of the Commission approval decisions.
(E.g. the general code of three eco-innovations approved chronologically as 10, 15 and 16 and fitted to a vehicle certified by the German type-approval authority should be: “e1 10 15 16”.)
- (82) Sum of the CO₂ emissions savings of each individual eco-innovation.
- (83) If the vehicle is equipped with 24 GHz short-range radar equipment in accordance with Commission Decision 2005/50/EC ([OJ L 21, 25.1.2005, p. 15](#)), the manufacturer shall indicate here: “Vehicle equipped with 24 GHz short-range radar equipment”.
- (84) The manufacturer may complete these entries either for international traffic or national traffic or both.
For national traffic, the code of the country where the vehicle is intended to be registered shall be mentioned. The code shall be in accordance with standard ISO 3166-1:2006.
For international traffic, the directive number shall be referred to (e.g. “96/53/EC” for Council Directive 96/53/EC).
- (85) In the case of completed vehicles of category N₁ within the scope of Regulation (EC) No 715/2007.
- (86) [OJ L 326, 24.11.2006, p. 55](#).

Status:

Point in time view as at 01/06/2017.

Changes to legislation:

There are outstanding changes not yet made to Commission Regulation (EU) 2017/1151. Any changes that have already been made to the legislation appear in the content and are referenced with annotations.