

This text is meant purely as a documentation tool and has no legal effect. The Union's institutions do not assume any liability for its contents. The authentic versions of the relevant acts, including their preambles, are those published in the Official Journal of the European Union and available in EUR-Lex. Those official texts are directly accessible through the links embedded in this document

► **B****COMMISSION REGULATION (EU) 2017/1151**

of 1 June 2017

supplementing Regulation (EC) No 715/2007 of the European Parliament and of the Council on type-approval of motor vehicles with respect to emissions from light passenger and commercial vehicles (Euro 5 and Euro 6) and on access to vehicle repair and maintenance information, amending Directive 2007/46/EC of the European Parliament and of the Council, Commission Regulation (EC) No 692/2008 and Commission Regulation (EU) No 1230/2012 and repealing Commission Regulation (EC) No 692/2008

(Text with EEA relevance)

(OJ L 175, 7.7.2017, p. 1)

Amended by:

		Official Journal		
		No	page	date
► <u>M1</u>	Commission Regulation (EU) 2017/1154 of 7 June 2017	L 175	708	7.7.2017
► <u>M2</u>	Commission Regulation (EU) 2017/1347 of 13 July 2017	L 192	1	24.7.2017
► <u>M3</u>	Commission Regulation (EU) 2018/1832 of 5 November 2018	L 301	1	27.11.2018

Corrected by:

- **C1** Corrigendum, OJ L 256, 4.10.2017, p. 11 (2017/1154)
- **C2** Corrigendum, OJ L 56, 28.2.2018, p. 66 (2017/1151)
- **C3** Corrigendum, OJ L 263, 16.10.2019, p. 41 (2018/1832)

▼B**COMMISSION REGULATION (EU) 2017/1151****of 1 June 2017**

supplementing Regulation (EC) No 715/2007 of the European Parliament and of the Council on type-approval of motor vehicles with respect to emissions from light passenger and commercial vehicles (Euro 5 and Euro 6) and on access to vehicle repair and maintenance information, amending Directive 2007/46/EC of the European Parliament and of the Council, Commission Regulation (EC) No 692/2008 and Commission Regulation (EU) No 1230/2012 and repealing Commission Regulation (EC) No 692/2008

(Text with EEA relevance)

*Article 1***Subject matter**

This Regulation lays down measures for the implementation of Regulation (EC) No 715/2007.

*Article 2***Definitions**

For the purposes of this Regulation, the following definitions shall apply:

(1) ‘vehicle type with regard to emissions and vehicle repair and maintenance information’ means a group of vehicles which:

(a) do not differ with respect to the criteria constituting an "interpolation family" as defined in point 5.6 of Annex XXI;

▼M3

(b) fall in a single "CO₂ interpolation range" within the meaning of point 2.3.2 of Sub-Annex 6 to Annex XXI;

▼B

(c) do not differ with respect to any characteristics that have a non-negligible influence on tailpipe emissions, such as, but not limited to, the following:

— types and sequence of pollution control devices (e.g. three-way catalyst, oxidation catalyst, lean NO_x trap, SCR, lean NO_x catalyst, particulate trap or combinations thereof in a single unit);

— exhaust gas recirculation (with or without, internal/external, cooled/non-cooled, low/high pressure).

(2) ‘EC type-approval of a vehicle with regard to emissions and vehicle repair and maintenance information’ means an EC type-approval of the vehicles contained in a ‘vehicle type with regard

▼ B

to emissions and vehicle repair and maintenance information' with regard to their tailpipe emissions, crankcase emissions, evaporative emissions, fuel consumption and access to vehicle OBD and vehicle repair and maintenance information;

▼ M2

- (3) 'odometer' means an instrument indicating to the driver the total distance driven by the vehicle since its production;

▼ B

- (4) 'starting aid' means glow plugs, modifications to the injection timing and other devices which assist the engine to start without enrichment of the air/fuel mixture of the engine;

- (5) 'engine capacity' means either of the following:

- (a) for reciprocating piston engines, the nominal engine swept volume;
- (b) for rotary piston (Wankel) engines, double the nominal engine swept volume;

▼ M3

- (6) 'periodically regenerating system' means an exhaust emissions control device (e.g. catalytic converter, particulate trap) that requires a periodic regeneration process;

▼ B

- (7) 'original replacement pollution control device' means a pollution control device or an assembly of pollution control devices whose types are indicated in Appendix 4 to Annex I to this Regulation but are offered on the market as separate technical units by the holder of the vehicle type-approval;

- (8) 'type of pollution control device' means catalytic converters and particulate filters which do not differ in any of the following essential aspects:

- (a) number of substrates, structure and material;
- (b) type of activity of each substrate;
- (c) volume, ratio of frontal area and substrate length;
- (d) catalyst material content;
- (e) catalyst material ratio;
- (f) cell density;
- (g) dimensions and shape;
- (h) thermal protection;

- (9) 'mono fuel vehicle' means a vehicle that is designed to run primarily on one type of fuel;

▼ B

- (10) ‘mono fuel gas vehicle’ means a mono fuel vehicle that primarily runs on LPG, NG/biomethane, or hydrogen but may also have a petrol system for emergency purposes or starting only, where the petrol tank does not contain more than 15 litres of petrol;

▼ M3

- (11) ‘bi-fuel vehicle’ means a vehicle with two separate fuel storage systems that is designed to run primarily on only one fuel at a time;
- (12) ‘bi-fuel gas vehicle’ means a bi-fuel vehicle where the two fuels are petrol (petrol mode) and either LPG, NG/biomethane, or hydrogen;

▼ B

- (13) ‘flex fuel vehicle’ means a vehicle with one fuel storage system that can run on different mixtures of two or more fuels;
- (14) ‘flex fuel ethanol vehicle’ means a flex fuel vehicle that can run on petrol or a mixture of petrol and ethanol up to an 85 per cent ethanol blend (E85);
- (15) ‘flex fuel biodiesel vehicle’ means a flex fuel vehicle that can run on mineral diesel or a mixture of mineral diesel and biodiesel;
- (16) ‘hybrid electric vehicle’ (HEV) means a hybrid vehicle where one of the propulsion energy converters is an electric machine;
- (17) ‘properly maintained and used’ means, for the purpose of a test vehicle, that such a vehicle satisfies the criteria for acceptance of a selected vehicle laid down in section 2 of Appendix 3 to UN/ECE Regulation No 83 ⁽¹⁾;
- (18) ‘emission control system’ means, in the context of the OBD system, the electronic engine management controller and any emission-related component in the exhaust or evaporative system which supplies an input to or receives an output from this controller;
- (19) ‘malfunction indicator’ (MI) means a visible or audible indicator that clearly informs the driver of the vehicle in the event of a malfunction of any emission-related component connected to the OBD system, or of the OBD system itself;
- (20) ‘malfunction’ means the failure of an emission-related component or system that would result in emissions exceeding the limits in section 2.3 of Annex XI or if the OBD system is unable to fulfil the basic monitoring requirements set out in Annex XI;

⁽¹⁾ Regulation No 83 of the Economic Commission for Europe of the United Nations (UNECE) — Uniform provisions concerning the approval of vehicles with regard to the emission of pollutants according to engine fuel requirements [2015/1038] (OJ L 172, 3.7.2015, p. 1).

▼B

- (21) ‘secondary air’ means the air introduced into the exhaust system by means of a pump or aspirator valve or other means that is intended to aid in the oxidation of HC and CO contained in the exhaust gas stream;
- (22) ‘driving cycle’, means, in respect of vehicle OBD systems, the engine start-up, driving mode where a malfunction would be detected if present, and engine shut-off;
- (23) ‘access to information’ means the availability of all vehicle OBD and vehicle repair and maintenance information, required for the inspection, diagnosis, servicing or repair of the vehicle.
- (24) ‘deficiency’ means, in the context of the OBD system, that up to two separate components or systems which are monitored contain temporary or permanent operating characteristics that impair the otherwise efficient OBD monitoring of those components or systems or do not meet all of the other detailed requirements for OBD;
- (25) ‘deteriorated replacement pollution control device’ means a pollution control device as defined in Article 3(11) of Regulation (EC) No 715/2007 that has been aged or artificially deteriorated to such an extent that it fulfils the requirements laid out in section 1 to Appendix 1 to Annex XI of UN/ECE Regulation No 83;
- (26) ‘vehicle OBD information’ means information relating to an on-board diagnostic system for any electronic system on the vehicle
- (27) ‘reagent’ means any product other than fuel that is stored on-board the vehicle and is provided to the exhaust after-treatment system upon request of the emission control system;
- (28) ‘mass in running order’ means the mass of the vehicle, with its fuel tank(s) filled to at least 90 per cent of its or their capacity/capacities, including the mass of the driver, fuel and liquids, fitted with the standard equipment in accordance with the manufacturer’s specifications and, when they are fitted, the mass of the bodywork, the cabin, the coupling and the spare wheel(s) as well as the tools;
- (29) ‘engine misfire’ means lack of combustion in the cylinder of a positive ignition engine due to absence of spark, poor fuel metering, poor compression or any other cause;
- (30) ‘cold start system or device’ means a system which temporarily enriches the air/fuel mixture of the engine thus assisting the engine to start;
- (31) ‘power take-off operation or unit’ means an engine-driven output provision for the purposes of powering auxiliary, vehicle mounted, equipment;

▼M1

- (32) ‘small volume manufacturer’ means a manufacturer whose worldwide annual production is less than 10 000 units for the year prior to the one for which the type approval is granted and:
- (a) is not part of a group of connected manufacturers; or

▼ M1

- (b) is part of a group of connected manufacturers whose worldwide annual production is less than 10 000 units for the year prior to the one for which the type approval is granted; or
 - (c) is part of a group of connected manufacturers but operates its own production facilities and own design centre;
- (32a) ‘own production facility’ means a manufacturing or assembly plant used by the manufacturer for the purpose of manufacturing or assembling new vehicles for that manufacturer, including, where relevant, vehicles which are intended for export;
- (32b) ‘own design centre’ means a facility in which the whole vehicle is designed and developed, and which is under the control and use of the manufacturer;
- (32c) ‘ultra-small-volume manufacturers’ means a small volume manufacturer as defined in point (32) which has registrations of less than 1 000 in the Community for the year prior to the one the type approval is granted;

▼ M2

▼ M3

- (33) ‘pure ICE vehicle’ means a vehicle where all of the propulsion energy converters are internal combustion engines;

▼ B

- (34) ‘Pure electric vehicle’ (PEV) means a vehicle equipped with a powertrain containing exclusively electric machines as propulsion energy converters and exclusively rechargeable electric energy storage systems as propulsion energy storage systems;
- (35) ‘Fuel cell’ means an energy converter transforming chemical energy (input) into electrical energy (output) or vice versa;
- (36) ‘Fuel cell vehicle’ (FCV) means a vehicle equipped with a powertrain containing exclusively fuel cell(s) and electric machine(s) as propulsion energy converter(s);
- (37) ‘net power’ means the power obtained on a test bench at the end of the crankshaft or its equivalent at the corresponding engine or motor speed with the auxiliaries, tested in accordance with Annex XX (Measurements of net power and the maximum 30 minutes power of electric drive train), and determined under reference atmospheric conditions;

▼ M3

- (38) ‘rated engine power’ (P_{rated}) means the maximum net power of the engine or motor in kW measured in accordance with the requirements of Annex XX;

▼ B

- (39) ‘maximum 30 minutes power’ means the maximum net power of an electric drive train at DC voltage as set out in paragraph 5.3.2. of UN/ECE Regulation No 85 ⁽¹⁾;

⁽¹⁾ Regulation No 85 of the Economic Commission for Europe of the United Nations (UN/ECE) — Uniform provisions concerning the approval of internal combustion engines or electric drive trains intended for the propulsion of motor vehicles of categories M and N with regard to the measurement of net power and the maximum 30 minutes power of electric drive trains (OJ L 323, 7.11.2014, p. 52).

▼ B

- (40) ‘cold start’ means, in the context of the in use performance ratio of OBD monitors, an engine coolant temperature or equivalent temperature at engine start less than or equal to 35 °C and less than or equal to 7 °C higher than ambient temperature, if available;
- (41) ‘Real driving emissions (RDE)’ means the emissions of a vehicle under its normal conditions of use;
- (42) ‘Portable emissions measurement system’ (PEMS) means a portable emissions measurement system meeting the requirements specified in Appendix 1 to Annex IIIA;
- (43) ‘Base Emission Strategy’, (‘BES’) means an emission strategy that is active throughout the speed and load operating range of the vehicle unless an Auxiliary Emission Strategy is activated;
- (44) ‘Auxiliary Emission Strategy’, (‘AES’) means an emission strategy that becomes active and replaces or modifies a BES for a specific purpose and in response to a specific set of ambient or operating conditions and only remains operational as long as those conditions exist;

▼ M3

- (45) ‘Fuel tank system’ means the devices which allow storing the fuel, comprising the fuel tank, the fuel filler, the filler cap and the fuel pump when it is fitted in or on the fuel tank;
- (46) ‘permeability factor’ (PF) means the factor determined on the basis of hydrocarbon losses over a period of time and used to determine the final evaporative emissions;
- (47) ‘monolayer non-metal tank’ means a fuel tank constructed with a single layer of non-metal material including fluorinated/sulfonated materials;
- (48) ‘multilayer tank’ means a fuel tank constructed with at least two different layered materials, one of which is a hydrocarbon barrier material;

▼ M2

- (49) ‘inertia category’ means a category of test masses of the vehicle corresponding to an equivalent inertia as laid down in Table A4a/3 of Annex 4a to UN/ECE Regulation No 83 when the test mass is set equal to the reference mass.

▼ B*Article 3***Requirements for type-approval****▼ M3**

1. In order to receive an EC type-approval with regard to emissions and vehicle repair and maintenance information, the manufacturer shall demonstrate that the vehicles comply with the requirements of this Regulation when tested in accordance with the test procedures specified in Annexes IIIA to VIII, XI, XIV, XVI, XX, XXI and XXII. The manufacturer shall also ensure that the reference fuels comply with the specifications set out in Annex IX.

▼B

2. Vehicles shall be subject to the tests specified in Figure I.2.4 of Annex I.

3. As an alternative to the requirements contained in Annexes II, V to VIII, XI, XVI and XXI, small volume manufacturers may request the granting of EC type-approval to a vehicle type which was approved by an authority of a third country on the basis of the legislative acts listed in section 2.1 of Annex I.

The emissions tests for roadworthiness purposes set out in Annex IV, tests for fuel consumption and CO₂ emissions set out in Annex XXI and the requirements for access to vehicle OBD and vehicle repair and maintenance information set out in Annex XIV shall be required to obtain EC type-approval with regard to emissions and vehicle repair and maintenance information under this paragraph.

The approval authority shall inform the Commission of the circumstances of each type approval granted under this paragraph.

4. Specific requirements for inlets to fuel tanks and electronic system security are laid down in Section 2.2 and 2.3 of Annex I.

5. The manufacturer shall take technical measures so as to ensure that the tailpipe and evaporative emissions are effectively limited, in accordance with this Regulation, throughout the normal life of the vehicle and under normal conditions of use.

These measures shall include ensuring that the security of hoses, joints and connections, used within the emission control systems, are constructed so as to conform with the original design intent.

6. The manufacturer shall ensure that the emissions test results comply with the applicable limit value under the specified test conditions of this Regulation.

▼M3

7. For the Type 1 test set out in Annex XXI, vehicles that are fuelled with LPG or NG/biomethane shall be tested in the Type 1 test for variation in the composition of LPG or NG/biomethane, as set out in Annex 12 to UN/ECE Regulation No 83 for pollutant emissions, with the fuel used for the measurement of the net power in accordance with Annex XX to this Regulation.

Vehicles that can be fuelled both with petrol or LPG or NG/biomethane shall be tested on both the fuels, tests on LPG or NG/biomethane being performed for variation in the composition of LPG or NG/biomethane, as set out in Annex 12 to UN/ECE Regulation No 83, and with the fuel used for the measurement of the net power in accordance with Annex XX to this Regulation.

▼B

8. For the Type 2 test set out in Appendix 1 to Annex IV, at normal engine idling speed, the maximum permissible carbon monoxide content in the exhaust gases shall be that stated by the vehicle manufacturer. However, the maximum carbon monoxide content shall not exceed 0,3 % vol.

▼B

At high engine idling speed, the carbon monoxide content by volume of the exhaust gases shall not exceed 0,2 %, with the engine speed being at least 2 000 min⁻¹ and Lambda being $1 \pm 0,03$ or in accordance with the specifications of the manufacturer.

9. The manufacturer shall ensure that for the Type 3 test set out in Annex V, the engine's ventilation system does not permit the emission of any crankcase gases into the atmosphere.

10. The Type 6 test measuring emissions at low temperatures set out in Annex VIII shall not apply to diesel vehicles.

However, when applying for type-approval, manufacturers shall present to the approval authority with information showing that the NO_x after-treatment device reaches a sufficiently high temperature for efficient operation within 400 seconds after a cold start at - 7 °C as described in the Type 6 test.

In addition, the manufacturer shall provide the approval authority with information on the operating strategy of the exhaust gas recirculation system (EGR), including its functioning at low temperatures.

This information shall also include a description of any effects on emissions.

The approval authority shall not grant type-approval if the information provided is insufficient to demonstrate that the after-treatment device actually reaches a sufficiently high temperature for efficient operation within the designated period of time.

At the request of the Commission, the approval authority shall provide information on the performance of NO_x after-treatment devices and EGR system at low temperatures.

11. The manufacturer shall ensure that, throughout the normal life of a vehicle which is type approved in accordance with Regulation (EC) No 715/2007, its emissions as determined in accordance with the requirements set out in Annex IIIA and emitted at an RDE test performed in accordance with that Annex, shall not exceed the values set out therein.

Type approval in accordance with Regulation (EC) No 715/2007 may only be issued if the vehicle is part of a validated PEMS test family according to Appendix 7 of Annex IIIA.

▼M1

The requirements of Annex IIIA shall not apply to emission type-approvals according to Regulation (EC) No 715/2007 granted to ultra-small-volume manufacturers.

▼B*Article 4***Requirements for type-approval regarding the OBD system**

1. The manufacturer shall ensure that all vehicles are equipped with an OBD system.

▼ B

2. The OBD system shall be designed, constructed and installed on a vehicle so as to enable it to identify types of deterioration or malfunction over the entire life of the vehicle.

3. The OBD system shall comply with the requirements of this Regulation during normal conditions of use.

4. When tested with a defective component in accordance with Appendix 1 of Annex XI, the OBD system malfunction indicator shall be activated.

The OBD system malfunction indicator may also activate during this test at levels of emissions below the OBD thresholds limits specified in section 2.3 of Annex XI.

5. The manufacturer shall ensure that the OBD system complies with the requirements for in-use performance set out in section 3 of Appendix 1 to Annex XI of this Regulation under all reasonably foreseeable driving conditions.

6. In-use performance related data to be stored and reported by a vehicle's OBD system according to the provisions of Section 7.6 of Appendix 1 to Annex XI of UN/ECE Regulation No 83 shall be made readily available by the manufacturer to national authorities and independent operators without any encryption.

▼ M3*Article 4a***Requirements for type-approval regarding devices for monitoring the consumption of fuel and/or electric energy**

The manufacturer shall ensure that the following vehicles of categories M1 and N1 are equipped with a device for determining, storing and making available data on the quantity of fuel and/or electric energy used for the operation of the vehicle:

- (1) pure ICE and Not-Off-Vehicle Charging Hybrid Electric vehicles (NOVC-HEVs) powered exclusively by mineral diesel, biodiesel, petrol, ethanol or any combination of these fuels;
- (2) Off-Vehicle Charging Hybrid Electric Vehicles (OVC-HEVs) powered by electricity and any of the fuels mentioned in point 1.

The device for monitoring the consumption of fuel and/or electric energy shall comply with the requirements laid down in Annex XXII.

▼ B*Article 5***Application for EC type-approval of a vehicle with regard to emissions and access to vehicle repair and maintenance information**

1. The manufacturer shall submit to the approval authority an application for EC type-approval of a vehicle with regard to emissions and access to vehicle repair and maintenance information.

2. The application referred to in paragraph 1 shall be drawn up in accordance with the model of the information document set out in Appendix 3 to Annex I.

▼B

3. In addition, the manufacturer shall submit the following information:

- (a) in the case of vehicles equipped with positive-ignition engines, a declaration by the manufacturer of the minimum percentage of misfires out of a total number of firing events that either would result in emissions exceeding the limits given in section 2.3 of Annex XI if that percentage of misfire had been present from the start of a type 1 test as chosen for the demonstration according to Annex XI to this Regulation or could lead to an exhaust catalyst, or catalysts, overheating prior to causing irreversible damage;
- (b) detailed written information fully describing the functional operation characteristics of the OBD system, including a listing of all relevant parts of the emission control system of the vehicle that are monitored by the OBD system;
- (c) a description of the malfunction indicator used by the OBD system to signal the presence of a fault to a driver of the vehicle;
- (d) a declaration by the manufacturer that the OBD system complies with the provisions of section 3 of Appendix 1 to Annex XI relating to in-use performance under all reasonably foreseeable driving conditions;
- (e) a plan describing the detailed technical criteria and justification for incrementing the numerator and denominator of each monitor that must fulfil the requirements of paragraphs 7.2 and 7.3. of Appendix 1 to Annex XI of UN/ECE Regulation No 83, as well as for disabling numerators, denominators and the general denominator under the conditions outlined in paragraph 7.7 of Appendix 1 to Annex XI of UN/ECE Regulation No 83;
- (f) a description of the provisions taken to prevent tampering with and modification of the emission control computer, odometer including the recording of mileage values for the purposes of the requirements of Annexes XI and XVI;
- (g) if applicable, the particulars of the vehicle family as referred to in Appendix 2 to Annex 11 to UN/ECE Regulation No 83;
- (h) where appropriate, copies of other type-approvals with the relevant data to enable extension of approvals and establishment of deterioration factors.

4. For the purposes of point (d) of paragraph 3, the manufacturer shall use the model of manufacturer's certificate of compliance with the OBD in-use performance requirements set out in Appendix 7 of Annex I

5. For the purposes of point (e) of paragraph 3, the approval authority that grants the approval shall make the information referred to in that point available to the approval authorities or the Commission upon request.

6. For the purposes of points (d) and (e) of paragraph 3, approval authorities shall not approve a vehicle if the information submitted by the manufacturer is inappropriate for fulfilling the requirements of section 3 of Appendix 1 to Annex XI.

Paragraphs 7.2, 7.3 and 7.7 of Appendix 1 to Annex XI of UN/ECE Regulation No 83 shall apply under all reasonably foreseeable driving conditions.

▼B

For the assessment of the implementation of the requirements set out in these paragraphs, the approval authorities shall take into account the state of technology.

7. For the purposes of point (f) of paragraph 3, the provisions taken to prevent tampering with and modification of the emission control computer shall include the facility for updating using a manufacturer-approved programme or calibration.

8. For the tests specified in Figure I.2.4 of Annex I the manufacturer shall submit to the technical service responsible for the type-approval tests a vehicle representative of the type to be approved.

9. The application for type-approval of mono fuel, bi-fuel and flex-fuel vehicles shall comply with the additional requirements laid down in Sections 1.1 and 1.2 of Annex I.

10. Changes to the make of a system, component or separate technical unit that occur after a type-approval shall not automatically invalidate a type approval, unless its original characteristics or technical parameters are changed in such a way that the functionality of the engine or pollution control system is affected.

▼M1

11. In order for the approval authorities to be able to assess the proper use of AES, taking into account the prohibition of defeat devices contained in Article 5(2) of Regulation (EC) No 715/2007, the manufacturer shall also provide an extended documentation package, as described in Appendix 3a of Annex I to this Regulation.

▼M3

The extended documentation package shall be identified and dated by the approval authority and kept by that authority for at least 10 years after the approval is granted.

At the request of the manufacturer, the approval authority shall conduct a preliminary assessment of the AES for new vehicle types. In that case, the relevant documentation shall be provided to the type approval authority between 2 and 12 months before the start of the type-approval process.

The approval authority shall make a preliminary assessment on the basis of the extended documentation package, as described in point (b) of Appendix 3a to Annex I, provided by the manufacturer. The approval authority shall make the assessment in accordance with the methodology described in Appendix 3b of Annex I. The approval authority may deviate from that methodology in exceptional and duly justified cases.

The preliminary assessment of the AES for new vehicle types shall remain valid for the purposes of type approval for a period of 18 months. That period may be extended by a further 12 months if the manufacturer provides to the approval authority proof that no new technologies have become accessible in the market that would change the preliminary assessment of the AES.

A list of AES which were deemed non-acceptable by Type Approval Authorities shall be compiled yearly by the Type-Approval Authorities Expert Group (TAAEG) and made available to the public by the Commission.

▼M1

▼M3

12. The manufacturer shall also provide the type approval authority which granted the emission type-approval under this Regulation ('granting approval authority') with a package on Testing Transparency containing the necessary information in order to allow the performance of testing in accordance with point 5.9 of Part B of Annex II.

▼B*Article 6***Administrative provisions for EC type-approval of a vehicle with regard to emissions and access to vehicle repair and maintenance information**

1. If all the relevant requirements are met, the approval authority shall grant an EC type-approval and issue a type-approval number in accordance with the numbering system set out in Annex VII to Directive 2007/46/EC.

Without prejudice to the provisions of Annex VII to Directive 2007/46/EC, Section 3 of the type-approval number shall be drawn up in accordance with Appendix 6 to Annex I to this Regulation.

An approval authority shall not assign the same number to another vehicle type.

2. By way of derogation from paragraph 1, at the request of the manufacturer, a vehicle with an OBD system may be accepted for type-approval with regard to emissions and vehicle repair and maintenance information, even though the system contains one or more deficiencies such that the specific requirements of Annex XI are not fully met, provided that the specific administrative provisions set out in Section 3 of that Annex are complied with.

The approval authority shall notify the decision to grant such a type approval to all approval authorities in the other Member States in accordance with the requirements set out in Article 8 of Directive 2007/46/EC.

3. When granting an EC type approval under paragraph 1, the approval authority shall issue an EC type-approval certificate using the model set out in Appendix 4 to Annex I.

*Article 7***Amendments to type-approvals**

Articles 13, 14 and 16 of Directive 2007/46/EC shall apply to any amendments to the type-approvals granted in accordance to Regulation (EC) No 715/2007.

At the manufacturer's request the provisions specified in Section 3 of Annex I shall apply without the need for additional testing only to vehicles of the same type.

*Article 8***Conformity of production**

1. Measures to ensure the conformity of production shall be taken in accordance with the provisions of Article 12 of Directive 2007/46/EC.

▼B

In addition, the provisions laid down in Section 4 of Annex I to this Regulation and the relevant statistical method in Appendices 1 and 2 to that Annex shall apply.

2. Conformity of production shall be checked on the basis of the description in the type-approval certificate set out in Appendix 4 to Annex I to this Regulation.

*Article 9***In service conformity**

1. Measures to ensure in-service conformity of vehicles type-approved under this Regulation shall be taken in accordance with Annex X to Directive 2007/46/EC and Annex II to this Regulation.

▼M3

2. The in-service conformity checks shall be appropriate for confirming that tailpipe and evaporative emissions are effectively limited during the normal life of vehicles under normal conditions of use.

3. In-service conformity shall be checked on properly maintained and used vehicles, in accordance with Appendix 1 of Annex II, between 15 000 km or 6 months whichever occurs later and 100 000 km or 5 years whichever occurs sooner. In service conformity for evaporative emissions shall be checked on properly maintained and used vehicles, in accordance with Appendix 1 of Annex II, between 30 000 km or 12 months whichever occurs later and 100 000 km or 5 years whichever occurs sooner.

The requirements for in-service conformity checks are applicable until 5 years after the last Certificate of Conformity or individual approval certificate is issued for vehicles of that in-service conformity family.

4. In-service conformity checks shall not be mandatory if the annual sales of the in-service conformity family are less than 5 000 vehicles in the Union for the previous year. For such families, the manufacturer shall provide the approval authority with a report of any emissions related warranty, repair claim and OBD fault as set out in point 4.1 of Annex II. Such in-service conformity families may still be selected to be tested in accordance with Annex II.

5. The manufacturer and the granting type approval authority shall perform in-service conformity checks in accordance with Annex II.

▼M3

6. The granting approval authority shall take the decision on whether a family failed the provisions of in-service conformity, following a compliance assessment and approve the plan of remedial measures presented by the manufacturer in accordance with Annex II.

7. If a type approval authority has established that an in-service conformity family fails the in-service conformity check, it shall notify without delay the granting type approval authority, in accordance with Article 30(3) of Directive 2007/46/EC.

Following that notification and subject to the provisions of Article 30(6) of Directive 2007/46/EC, the granting approval authority shall inform the manufacturer that an in-service conformity family fails the in-service conformity checks and that the procedures described in points 6 and 7 of Annex II shall be followed.

If the granting approval authority establishes that no agreement can be reached with a type approval authority that has established that an in-service conformity family fails the in-service conformity check, the procedure pursuant to Article 30(6) of Directive 2007/46/EC shall be initiated.

8. In addition to points 1 to 7, the following shall apply to vehicles type approved according to Part B of Annex II.

- (a) Vehicles submitted to multi-stage type-approval, as defined in Article 3(7) of Directive 2007/46/EC, shall be checked for in service conformity in accordance with the rules for multistage approval set out in point 5.10.6 of Part B of Annex II to this Regulation.
- (b) Armoured vehicles, hearses and wheelchair accessible vehicles, as defined in points 5.2 and 5.5 of Part A of Annex II to Directive 2007/46/EC respectively, shall not be subject to the provisions of this Article. All other special purpose vehicles as defined in point 5 of Part A of Annex II to Directive 2007/46/EC, shall be checked for in service conformity in accordance with the rules for multistage type-approvals set out in Part B of Annex II to this Regulation.

▼B*Article 10***Pollution control devices**

1. The manufacturer shall ensure that replacement pollution control devices intended to be fitted to EC type-approved vehicles covered by the scope of Regulation (EC) No 715/2007 are EC type-approved, as separate technical units within the meaning of Article 10(2) of Directive 2007/46/EC, in accordance with Article 12, Article 13 and Annex XIII to this Regulation.

▼B

Catalytic converters and particulate filters shall be considered to be pollution control devices for the purposes of this Regulation.

The relevant requirements shall be deemed to be met if all the following conditions are fulfilled:

- (a) the requirements of Article 13 are met;
- (b) the replacement pollution control devices have been approved according to UN/ECE Regulation No 103 ⁽¹⁾.

In the case referred to in the third subparagraph Article 14 shall also apply.

2. Original equipment replacement pollution control devices, which fall within the type covered by point 2.3 of the Addendum to Appendix 4 to Annex I and are intended for fitment to a vehicle to which the relevant type-approval document refers, do not need to comply with Annex XIII provided they fulfil the requirements of points 2.1 and 2.2 of that Annex.

3. The manufacturer shall ensure that the original pollution control device carries identification markings.

4. The identification markings referred to in paragraph 3 shall comprise the following:

- (a) the vehicle or engine manufacturer's name or trade mark;
- (b) the make and identifying part number of the original pollution control device as recorded in the information referred to in point 3.2.12.2 of Appendix 3 to Annex I.

Article 11

Application for EC type-approval of a type of replacement pollution control device as a separate technical unit

1. The manufacturer shall submit to the approval authority an application for EC type-approval of a type of replacement pollution control device as a separate technical unit.

The application shall be drawn up in accordance with the model of the information document set out in Appendix 1 to Annex XIII.

2. In addition to the requirements laid down in paragraph 1, the manufacturer shall submit to the technical service responsible for the type-approval test all of the following:

- (a) a vehicle or vehicles of a type approved in accordance with this Regulation equipped with a new original equipment pollution control device;
- (b) one sample of the type of the replacement pollution control device;

⁽¹⁾ Regulation No 103 of the Economic Commission for Europe of the United Nations (UN/ECE) — Uniform provisions concerning the approval of replacement catalytic converters for power-driven vehicles (OJ L 158, 19.6.2007, p. 106).

▼B

(c) an additional sample of the type of the replacement pollution control device, in the case of a replacement pollution control device intended to be fitted to a vehicle equipped with an OBD system.

3. For the purposes of point (a) of paragraph 2, the test vehicles shall be selected by the applicant with the agreement of the technical service.

The test vehicles shall comply with the requirements set out in Section 3.2 of Annex 4a to UN/ECE Regulation No 83.

The test vehicles shall respect all of the following requirements:

- (a) they shall have no emission control system defects;
- (b) any excessively worn out or malfunctioning emission-related original part shall be repaired or replaced;
- (c) they shall be tuned properly and set to manufacturer's specification prior to emission testing.

4. For the purposes of points (b) and (c) of paragraph 2, the sample shall be clearly and indelibly marked with the applicant's trade name or mark and its commercial designation.

5. For the purposes of point (c) of paragraph 2, the sample shall have been deteriorated as defined under point (25) of Article 2.

Article 12

Administrative provisions for EC type-approval of replacement pollution control device as separate technical unit

1. If all the relevant requirements are met, the type approval authority shall grant an EC type-approval for replacement pollution control devices as separate technical unit and issue a type-approval number in accordance with the numbering system set out in Annex VII to Directive 2007/46/EC.

The approval authority shall not assign the same number to another replacement pollution control device type.

The same type-approval number may cover the use of that replacement pollution control device type on a number of different vehicle types.

2. For the purposes of paragraph 1, the approval authority shall issue an EC type-approval certificate established in accordance with the model set out in Appendix 2 to Annex XIII.

3. If the applicant for type-approval is able to demonstrate to the approval authority or technical service that the replacement pollution control device is of a type indicated in section 2.3 of the Addendum to Appendix 4 to Annex I, the granting of a type-approval shall not be dependent on verification of compliance with the requirements specified in section 4 of Annex XIII.

*Article 13***Access to vehicle OBD and vehicle repair and maintenance information**

1. Manufacturers shall put in place the necessary arrangements and procedures, in accordance with Articles 6 and 7 of Regulation (EC) No 715/2007 and Annex XIV of this regulation, to ensure that vehicle OBD and vehicle repair and maintenance information is readily accessible.
2. Approval authorities shall only grant type-approval after receiving from the manufacturer a Certificate on Access to Vehicle OBD and Vehicle Repair and Maintenance Information.
3. The Certificate on Access to Vehicle OBD and Vehicle Repair and Maintenance Information shall serve as the proof of compliance with Article 6(7) of Regulation (EC) No 715/2007.
4. The Certificate on Access to Vehicle OBD and Vehicle Repair and Maintenance Information shall be drawn up in accordance with the model set out in Appendix 1 of Annex XIV.
5. If the vehicle OBD and vehicle repair and maintenance information is not available, or does not conform to Article 6 and 7 of Regulation (EC) No 715/2007 and Annex XIV of this Regulation, when the application for type-approval is made, the manufacturer shall provide that information within six months of the date of type approval.
6. The obligations to provide information within the period specified in paragraph 5 shall apply only if, following type-approval, the vehicle is placed on the market.

When the vehicle is placed on the market more than six months after type-approval, the information shall be provided on the date on which the vehicle is placed on the market.

7. The approval authority may presume that the manufacturer has put in place satisfactory arrangements and procedures with regard to access to vehicle OBD and vehicle repair and maintenance information, on the basis of a completed Certificate on Access to Vehicle OBD and Vehicle Repair and Maintenance Information, providing that no complaint was made, and that the manufacturer provides this information within the period set out in paragraph 5.
8. In addition to the requirements for the access to OBD information that are specified in Section 4 of Annex XI, the manufacturer shall make available to interested parties the following information:
 - (a) relevant information to enable the development of replacement components which are critical to the correct functioning of the OBD system;
 - (b) information to enable the development of generic diagnostic tools.

▼B

For the purposes of point (a), the development of replacement components shall not be restricted by: the unavailability of pertinent information, the technical requirements relating to malfunction indication strategies if the OBD thresholds are exceeded or if the OBD system is unable to fulfil the basic OBD monitoring requirements of this Regulation; specific modifications to the handling of OBD information to deal independently with vehicle operation on petrol or on gas; and the type-approval of gas-fuelled vehicles that contain a limited number of minor deficiencies.

For the purposes of point (b), where manufacturers use diagnostic and test tools in accordance with ISO 22900 Modular Vehicle Communication Interface (MVCI) and ISO 22901 Open Diagnostic Data Exchange (ODX) in their franchised networks, the ODX files shall be accessible to independent operators via the web site of the manufacturer.

9. The Forum on Access to Vehicle Information (the Forum).

The Forum shall consider whether access to information affects the advances made in reducing vehicle theft and shall make recommendations for improving the requirements relating to access to information. In particular, the Forum shall advise the Commission on the introduction of a process for approving and authorising independent operators by accredited organisations to access information on vehicle security.

The Commission may decide to keep the discussions and findings of the Forum confidential.

Article 14

Compliance with the obligations regarding access to vehicle OBD and vehicle repair and maintenance information

1. An approval authority may, at any time, whether on its own initiative, on the basis of a complaint, or on the basis of an assessment by a technical service, check the compliance of a manufacturer with the provisions of Regulation (EC) No 715/2007, this Regulation, and the terms of the Certificate on Access to Vehicle OBD and Vehicle Repair and Maintenance Information.

2. Where an approval authority finds that the manufacturer has failed to comply with its obligations regarding access to vehicle OBD and vehicle repair and maintenance information, the approval authority which granted the relevant type approval shall take appropriate steps to remedy the situation.

3. The steps referred to in paragraph 2 may include withdrawal or suspension of type-approval, fines, or other measures adopted in accordance with Article 13 of Regulation (EC) No 715/2007.

4. The approval authority shall proceed to an audit in order to verify compliance by the manufacturer with the obligations concerning access to vehicle OBD and vehicle repair and maintenance information, if an independent operator or a trade association representing independent operators files a complaint to the approval authority.

▼ B

5. When carrying out the audit, the approval authority may ask a technical service or any other independent expert to carry out an assessment to verify whether these obligations are met.

*Article 15***Transitional provisions**

1. Until 31 August 2017 in the case of categories M1, M2 and category N1 class I vehicles, and until 31 August 2018 in the case of N1 vehicles of class II and III and category N2 vehicles manufacturers may request type-approval to be granted in accordance with this Regulation. Where such request is not made, Regulation (EC) No 692/2008 shall apply.

▼ M2

2. With effect from 1 September 2017 in the case of categories M1, M2 and category N1 class I vehicles, and from 1 September 2018 in the case of N1 vehicles of class II and III and category N2 vehicles, national authorities shall refuse, on grounds relating to emissions or fuel consumption, to grant EC type approval or national type approval, in respect to new vehicle types which do not comply with this Regulation.

▼ M3

With effect from 1 September 2019, national authorities shall refuse, on grounds relating to emissions or fuel consumption, to grant EC type approval or national type approval, in respect to new vehicle types which do not comply with Annex VI. At the request of the manufacturer, until 31 August 2019 the evaporative emissions test procedure set out in Annex 7 to UNECE Regulation 83 or the evaporative emissions test procedure set out in Annex VI of Regulation (EC) No 692/2008 may still be used for the purposes of type-approval under this Regulation.

▼ M2

3. With effect from 1 September 2018 in the case of categories M1, M2 and category N1 class I vehicles, and from 1 September 2019 in the case of N1 vehicles of class II and III and category N2 vehicles, national authorities shall, on grounds relating to emissions or fuel consumption, in the case of new vehicles which do not comply with this Regulation, consider certificates of conformity to be no longer valid for the purposes of Article 26 of Directive 2007/46/EC and shall prohibit the registration, sale or entry into service of such vehicles.

For new vehicles registered before 1 September 2019 the evaporative emissions test procedure laid down in Annex 7 to UN/ECE Regulation 83 may, at the request of the manufacturer, be applied instead of the procedure laid down in Annex VI to this Regulation for the purposes of determining the evaporative emissions of the vehicle.

▼ M3

With the exception of vehicles approved for evaporative emissions under the procedure laid down in Annex VI of Regulation (EC) No 692/2008, with effect from 1 September 2019, national authorities shall prohibit the registration, sale or entry into service of new vehicles that do not comply with Annex VI of this Regulation.

▼ B

4. Until three years after the dates specified in Article 10(4) of Regulation (EC) No 715/2007 in the case of new vehicle types and four years after the dates specified in Article 10(5) of that Regulation in the case of new vehicles, the following provisions shall apply:

▼ M1

(a) the requirements of point 2.1 of Annex IIIA with the exception of the requirements for the number of particles (PN) shall not apply;

▼ B

(b) the requirements of Annex IIIA other than that in point 2.1, including the requirements with regard to RDE tests to be performed and data to be recorded and made available, shall apply only to new type approvals granted in accordance with Regulation (EC) No 715/2007 from 27 July 2017;

(c) the requirements of Annex IIIA shall not apply to type approvals granted to small volume manufacturers.

▼ M3

▼ M1

Where a vehicle was type-approved in accordance with the requirements of Regulation (EC) No 715/2007 and its implementing legislation prior to 1 September 2017 in the case of category M and category N1 class I vehicles, or prior to 1 September 2018 in the case of category N1 class II and III and category N2 vehicles, it shall not be considered as belonging to a new type for the purpose of the first subparagraph. The same shall apply also where new types are created out of the original type exclusively due to the application of the new type definition in Article 2(1) of this Regulation. In these cases, the application of this subparagraph shall be mentioned in Section II. 5 Remarks of the EC-type-approval certificate, set out in Appendix 4 of Annex I to Regulation (EU) 2017/1151, including a reference to the previous type-approval.

▼ B

5. Until 8 years after the dates given in Article 10(4) of Regulation (EC) No 715/2007:

▼ M2

(a) type 1/I tests performed in accordance with Annex III to Regulation (EC) No 692/2008 until 3 years after the dates specified in Article 10(4) of Regulation (EC) No 715/2007 shall be recognised by the approval authority for the purposes of producing deteriorated or defective components to simulate failures for assessing the requirements of Annex XI to this Regulation;

▼ M3

(b) with respect to vehicles of a WLTP interpolation family which fulfil the extension rules specified in point 3.1.4 of Annex I of Regulation (EC) No 692/2008, procedures performed in accordance with Section 3.13 of Annex III to Regulation (EC) No 692/2008 until 3 years after the dates given in Article 10(4) of Regulation (EC) No 715/2007 shall be accepted by the approval authority for the purposes of fulfilling the requirements of Appendix 1 to Sub-Annex 6 to Annex XXI of this Regulation;

▼ M2

- (c) durability demonstrations where the first type 1/I test was performed and completed in accordance with Annex VII to Regulation (EC) No 692/2008 until 3 years after the dates specified in Article 10(4) of Regulation (EC) No 715/2007 shall be recognised by the approval authorities as equivalent for the purposes of fulfilling the requirements of Annex VII to this Regulation.

▼ M3

For the purposes of this point, the possibility to use test results from procedures performed and completed in accordance with Regulation (EC) No 692/2008 shall only be applicable to those vehicles of a WLTP interpolation family which fulfil the extension rules specified in point 3.3.1 of Annex I of Regulation (EC) No 692/2008.

▼ B

6. In order to ensure a fair treatment of previously existing type-approvals, the Commission shall examine the consequences of Chapter V of Directive 2007/46/EC for the purposes of this Regulation.

▼ M1

7. Until 5 years and 4 months following the dates specified in Article 10(4) and (5) of Regulation (EC) No 715/2007 the requirements of Point 2.1 of Annex IIIA shall not apply to emission type-approvals according to Regulation (EC) No 715/2007 granted to small volume manufacturers as defined in Article 2(32). However in the period between 3 years and 5 years and 4 months following the dates specified in Article 10(4) and between 4 years and 5 years 4 months following the dates specified in Article 10(5) of Regulation (EC) No 715/2007, small volume manufacturers shall monitor and report the RDE values of their vehicles.

▼ M3

8. Part B of Annex II shall apply to categories M1, M2 and category N1 class I based on types approved from 1 January 2019, and for category N1 class II and III and category N2 based on types approved from 1 September 2019. It shall also apply to all vehicles registered from 1 September 2019 for categories M1, M2 and category N1 class I, and to all vehicles registered from 1 September 2020 for category N1 class II and III and category N2. In all other cases Part A of Annex II shall apply.

9. With effect from 1 January 2020 in the case of vehicles as referred to in Article 4a of categories M1 and N1, class I, and from 1 January 2021 in the case of vehicles as referred to in Article 4a of category N1 vehicles, classes II and III, national authorities shall refuse, on grounds relating to emissions or fuel consumption, to grant EC type approval or national type approval in respect of new vehicle types which do not meet the requirements laid down in Article 4a.

With effect from 1 January 2021, in the case vehicles as referred to in Article 4a of categories M1 and N1, class I, and from 1 January 2022 in the case of vehicles as referred to in Article 4a of category N1 vehicles, classes II and III, national authorities shall prohibit the registration, sale or entry into service of new vehicles that do not comply with that Article.

▼ M3

10. With effect from 1 September 2019 national authorities shall prohibit the registration, sale or entry into service of new vehicles that do not comply with the requirements set out in Annex IX of the Directive 2007/46/EC as amended by Commission Regulation (EU) 2018/1832 ⁽¹⁾.

For all vehicles registered between 1 January and 31 August 2019 under new type approvals granted in the same period and where the information listed in Annex IX of the Directive 2007/46/EC as amended by Regulation (EU) 2018/1832 is not yet included in the Certificate of Conformity, the manufacturer shall make this information available free-of-charge within 5 working days of the request by an accredited lab or technical service for the purposes of testing under Annex II.

11. The requirements of Article 4a shall not apply to type approvals granted to small volume manufacturers.

▼ B*Article 16***Amendments to Directive 2007/46/EC**

Directive 2007/46/EC is amended in accordance with Annex XVIII to this Regulation.

*Article 17***Amendments to Regulation (EC) No 692/2008**

Regulation (EC) No 692/2008 is amended as follows:

(1) In Article 6, paragraph 1, shall be replaced by the following text:

‘1. If all the relevant requirements are met, the approval authority shall grant an EC type-approval and issue a type-approval number in accordance with the numbering system set out in Annex VII to Directive 2007/46/EC.

Without prejudice to the provisions of Annex VII to Directive 2007/46/EC, Section 3 of the type-approval number shall be drawn up in accordance with Appendix 6 to Annex I to this Regulation.

An approval authority shall not assign the same number to another vehicle type.

The requirements of Regulation (EC) No 715/2007 shall be deemed to be met if all the following conditions are fulfilled:

⁽¹⁾ Commission Regulation (EU) 2018/1832 of 5 November 2018 amending Directive 2007/46/EC of the European Parliament and of the Council, Commission Regulation (EC) No 692/2008 and Commission Regulation (EU) 2017/1151 for the purpose of improving the emission type approval tests and procedures for light passenger and commercial vehicles, including those for in-service conformity and real-driving emissions and introducing devices for monitoring the consumption of fuel and electric energy (OJ L 301, 27.11.2018, p. 1).

▼B

- (a) the requirements of Article 3(10) of this Regulation are met;
 - (b) the requirements of Article 13 of this Regulation are met;
 - (c) the vehicle has been approved according to UN/ECE Regulations No 83, series of amendments 07; No 85 and its supplements, No 101, Revision 3 (comprising series of amendments 01 and their supplements) and in the case of compression ignition vehicles No 24 Part III, series of amendments 03.
 - (d) the requirements of Article 5(11) and (12) are met.’
- (2) the following Article 16a is added:

‘Article 16a

Transitional provisions

With effect from 1 September 2017 in the case of categories M1, M2 and category N1 class I vehicles, and from 1 September 2018 in the case of N1 vehicles of class II and III and category N2 vehicles, this Regulation shall only apply for the purposes of assessing the following requirements of vehicles type-approved in accordance with this Regulation before those dates:

- (a) conformity of production in accordance with Article 8;
- (b) in-service conformity in accordance with Article 9;
- (c) access to vehicle OBD and vehicle repair and maintenance information in accordance with Article 13;

This Regulation shall also apply for the purposes of the correlation procedure set out in Commission Implementing Regulations (EU) 2017/1152 (*) and (EU) 2017/1153 (**).

(*) Commission Implementing Regulation (EU) 2017/1152 of 2 June 2017 setting out a methodology for determining the correlation parameters necessary for reflecting the change in the regulatory test procedure with regard to light commercial vehicles and amending Implementing Regulation (EU) No 293/2012 (See page 644 of this Official Journal).

(**) Commission Implementing Regulation (EU) 2017/1153 of 2 June 2017 setting out a methodology for determining the correlation parameters necessary for reflecting the change in the regulatory test procedure and amending Regulation (EU) No 1014/2010 (See page 679 of this Official Journal).’

- (3) Annex I is amended in accordance with Annex XVII to this Regulation.

▼B*Article 18***Amendments to Commission Regulation (EU) No 1230/2012 ⁽¹⁾**

In Regulation (EU) No 1230/2012, Article 2(5) is replaced by the following:

- (5) “Mass of the optional equipment” means the maximum mass of the combinations of optional equipment which may be fitted to the vehicle in addition to the standard equipment in accordance with the manufacturer's specifications;

▼M3**▼B***Article 19***Repeal**

Regulation (EC) No 692/2008 is repealed as from 1 January 2022.

*Article 20***Entry into force and application**

This Regulation shall enter into force on the twentieth day following its publication in the *Official Journal of the European Union*.

This Regulation shall be binding in its entirety and directly applicable in all Member States.

⁽¹⁾ Commission Regulation (EU) No 1230/2012 of 12 December 2012 implementing Regulation (EC) No 661/2009 of the European Parliament and of the Council with regard to type-approval requirements for masses and dimensions of motor vehicles and their trailers and amending Directive 2007/46/EC of the European Parliament and of the Council (OJ L 353, 21.12.2012, p. 31).



LIST OF ANNEXES

ANNEX I	Administrative provisions for EC type-approval
Appendix 1	Verification of conformity of production for Type 1 test — statistical method
Appendix 2	Calculations for Conformity of Production for EVs
Appendix 3	Model information document
Appendix 3a	Extended Documentation Package
Appendix 3b	Methodology for the assessment of AES
Appendix 4	Model EC type-approval certificate
Appendix 5	OBD related information
Appendix 6	EC type-approval certificate numbering system
Appendix 7	Manufacturer's certificate of compliance with OBD in-use performance requirements
Appendix 8a	Test Reports
Appendix 8b	Road Load Test Report
Appendix 8c	Template for Test Sheet
Appendix 8d	Evaporative emission test report
ANNEX II	In-service conformity
Appendix 1	In-service conformity check
Appendix 2	Statistical procedure for tailpipe emissions in-service conformity testing
Appendix 3	Responsibilities for in-service conformity
ANNEX IIIA	Verifying Real Driving Emissions (RDE)
Appendix 1	Test procedure for vehicle emissions testing with a Portable Emissions Measurement System (PEMS)
Appendix 2	Specifications and calibration of PEMS components and signals
Appendix 3	Validation of PEMS and non-traceable exhaust mass flow rate
Appendix 4	Determination of emissions
Appendix 5	Verification of overall trip dynamics using the moving averaging window method
Appendix 6	Calculation of the final rde emissions results
Appendix 7	Selection of vehicles for PEMS testing at initial type approval
Appendix 7a	Verification of trip dynamics
Appendix 7b	Procedure to determine the cumulative positive elevation gain of a PEMS trip

▼B

Appendix 8	Data exchange and reporting requirements
Appendix 9	Manufacturer's certificate of compliance Manufacturer's certificate of compliance with the Real Driving Emissions requirements
ANNEX IV	Emissions data required at type-approval for roadworthiness purposes
Appendix 1	Measuring carbon monoxide emissions at engine idling speeds (Type 2 test)
Appendix 2	Measurement of smoke opacity
ANNEX V	Verifying emissions of crankcase gases (Type 3 test)
ANNEX VI	Determination of evaporative emissions (Type 4 test)
Appendix 1	Type 4 test procedures and test conditions
ANNEX VII	Verifying the durability of pollution control devices (Type 5 test)
Appendix 1	Standard Bench Cycle (SBC)
Appendix 2	Standard Diesel Bench Cycle (SDBC)
Appendix 3	Standard Road Cycle (SRC)
ANNEX VIII	Verifying the average exhaust emissions at low ambient temperatures (Type 6 test)
ANNEX IX	Specifications of reference fuels
ANNEX X	Reserved
ANNEX XI	On-board diagnostics (OBD) for motor vehicles
Appendix 1	Functional aspects of on-board diagnostic (OBD) systems
Appendix 2	Essential characteristics of the vehicle family
ANNEX XII	Type-approval of vehicles fitted with eco-innovations and Determination of CO ₂ emissions and fuel consumption from vehicles submitted to multi-stage type-approval or individual vehicle approval
ANNEX XIII	EC Type-approval of replacement pollution control devices as separate technical unit
Appendix 1	Model information document
Appendix 2	Model EC type-approval certificate
Appendix 3	Model EC type-approval mark
ANNEX XIV	Access to vehicle OBD and vehicle repair and maintenance information
Appendix 1	Certificate of compliance
ANNEX XV	Reserved
ANNEX XVI	Requirements for vehicles that use a reagent for the exhaust after-treatment system
ANNEX XVII	Amendments to Regulation (EC) No 692/2008
ANNEX XVIII	Amendments to Directive 2007/46/EC
ANNEX XIX	Amendments to Regulation (EU) No 1230/2012
ANNEX XX	Measurement of net engine power
ANNEX XXI	Type 1 emissions test procedures
ANNEX XXII	Devices for monitoring on board the vehicle the consumption of fuel and/or electric energy

▼B*ANNEX I***ADMINISTRATIVE PROVISIONS FOR EC TYPE-APPROVAL**

1. ADDITIONAL REQUIREMENTS FOR GRANTING OF EC TYPE-APPROVAL
 - 1.1. **Additional requirements for mono fuel gas vehicles, and bi-fuel gas vehicles.**
 - 1.1.1. The additional requirements for granting of type-approval for mono fuel gas vehicles, and bi-fuel gas vehicles shall be those set out in sections 1, 2 and 3 and Appendices 1 and 2 to Annex 12 to UN/ECE Regulation No 83, with the exceptions set out below.
 - 1.1.2. The reference in paragraphs 3.1.2. and 3.1.4. of Annex 12 to UN/ECE Regulation No 83 to reference fuels of Annex 10a shall be understood as being reference to the appropriate reference fuel specifications in Section A of Annex IX to this Regulation.

▼M3

- 1.1.3. For LPG or NG, the fuel to be used shall be the one selected by the manufacturer for the measurement of the net power in accordance with Annex XX to this Regulation. The selected fuel shall be specified in the information document set out in Appendix 3 of Annex I to this Regulation.

▼B

- 1.2. **Additional requirements for flex fuel vehicles**

The additional requirements for granting of type-approval for flex fuel vehicles shall be those set out in paragraph 4.9. of UN/ECE Regulation No 83.
2. ADDITIONAL TECHNICAL REQUIREMENTS AND TESTS
 - 2.1. **Small volume manufacturers**
 - 2.1.1. List of legislative acts referred to in Article 3(3):

Legislative Act	Requirements
The California Code of Regulations, Title 13, Sections 1961(a) and 1961(b)(1)(C)(1) applicable to 2001 and later model year vehicles, 1968.1, 1968.2, 1968.5, 1976 and 1975, published by Barclay's Publishing	Type-approval must be granted under the California Code of Regulations applicable to the most recent model year of light-duty vehicle.

- 2.2. **Inlets to fuel tanks**
 - 2.2.1. The requirements for inlets to fuel tanks shall be those specified in paragraphs 5.4.1. and 5.4.2. of Annex XXI and point 2.2.2 below.
 - 2.2.2. Provision shall be made to prevent excess evaporative emissions and fuel spillage caused by a missing fuel filler cap. This may be achieved by using one of the following:

- (a) an automatically opening and closing, non-removable fuel filler cap,

▼ B

- (b) design features which avoid excess evaporative emissions in the case of a missing fuel filler cap,

- (c) any other provision which has the same effect. Examples may include, but are not limited to, a tethered filler cap, a chained filler cap or one utilizing the same locking key for the filler cap as for the vehicle's ignition. In this case the key shall be removable from the filler cap only in the locked condition.

2.3. Provisions for electronic system security**▼ M3**

- 2.3.1. Any vehicle with an emission control computer shall include features to deter modification, except as authorised by the manufacturer. The manufacturer shall authorise modifications if those modifications are necessary for the diagnosis, servicing, inspection, retrofitting or repair of the vehicle. Any reprogrammable computer codes or operating parameters shall be resistant to tampering and afford a level of protection at least equivalent to that afforded by the provisions of the standard ISO 15031-7:2013. Any removable calibration memory chips shall be potted, encased in a sealed container or protected by electronic algorithms and shall not be changeable without the use of specialised tools and procedures. Only features directly associated with emissions calibration or prevention of vehicle theft may be so protected.

- 2.3.2. Computer-coded engine operating parameters shall not be changeable without the use of specialised tools and procedures (e.g. soldered or potted computer components or sealed (or soldered) enclosures).

- 2.3.3. At the request of the manufacturer, the approval authority may grant exemptions to the requirements in points 2.3.1. and 2.3.2. for those vehicles that are unlikely to require protection. The criteria that the approval authority shall evaluate in considering an exemption shall include, but are not limited to, the current availability of performance chips, the high-performance capability of the vehicle and the projected sales volume of the vehicle.

- 2.3.4. Manufacturers using programmable computer code systems shall take the necessary measures to deter unauthorised reprogramming. Such measures shall include enhanced tamper protection strategies and write-protect features requiring electronic access to an off-site computer maintained by the manufacturer, to which independent operators shall also have access using the protection afforded in point 2.3.1. and point 2.2. of Annex XIV. Methods giving an adequate level of tamper protection shall be approved by the approval authority.

- 2.3.5. In the case of mechanical fuel-injection pumps fitted to compression-ignition engines, manufacturers shall take adequate steps to protect the maximum fuel delivery setting from tampering while a vehicle is in service.

▼ M3

- 2.3.6. Manufacturers shall effectively deter reprogramming of the odometer readings, in the board network, in any powertrain controller as well as in the transmitting unit for remote data exchange if applicable. Manufacturers shall include systematic tamper-protection strategies and write-protect features to protect the integrity of the odometer reading. Methods giving an adequate level of tamper protection shall be approved by the approval authority.

▼ B**2.4. Application of tests****▼ M3**

- 2.4.1. Figure I.2.4 illustrates the application of the tests for type-approval of a vehicle. The specific test procedures are described in Annexes II, IIIA, IV, V, VI, VII, VIII, XI, XVI, XX, XXI and XXII.

Figure 1.2.4

Application of test requirements for type-approval and extensions

Vehicle category	Vehicles with positive ignition engines including hybrids ⁽¹⁾ ⁽²⁾								Vehicles with compression ignition engines including hybrids	Pure electric vehicles	Hydrogen fuel cell vehicles
	Mono fuel				Bi-fuel ⁽³⁾			Flex-fuel ⁽³⁾			
Reference fuel	Petrol (E10)	LPG	NG/Biomethane	Hydrogen (ICE)	Petrol (E10)	Petrol (E10)	Petrol (E10)	Petrol (E10)	Diesel (B7)	—	Hydrogen (Fuel Cell)
					LPG	NG/Biomethane	Hydrogen (ICE) ⁽⁴⁾	Ethanol (E85)			
Gaseous pollutants (Type 1 test)	Yes	Yes	Yes	Yes ⁽⁴⁾	Yes (both fuels)	Yes (both fuels)	Yes (both fuels)	Yes (both fuels)	Yes	—	—
PM (Type 1 test)	Yes	—	—	—	Yes (petrol only)	Yes (petrol only)	Yes (petrol only)	Yes (both fuels)	Yes	—	—
PN	Yes	—	—	—	Yes (petrol only)	Yes (petrol only)	Yes (petrol only)	Yes (both fuels)	Yes	—	—
Gaseous pollutants, RDE (Type 1A test)	Yes	Yes	Yes	Yes ⁽⁴⁾	Yes (both fuels)	Yes (both fuels)	Yes (both fuels)	Yes (both fuels)	Yes	—	—
PN, RDE (Type 1A test) ⁽⁵⁾	Yes	—	—	—	Yes (petrol only)	Yes (petrol only)	Yes (petrol only)	Yes (both fuels)	Yes	—	—
ATCT (14 °C test)	Yes	Yes	Yes	Yes ⁽⁴⁾	Yes (both fuels)	Yes (both fuels)	Yes (both fuels)	Yes (both fuels)	Yes	—	—

▼ M3

Vehicle category	Vehicles with positive ignition engines including hybrids ⁽¹⁾ ⁽²⁾								Vehicles with compression ignition engines including hybrids	Pure electric vehicles	Hydrogen fuel cell vehicles
	Mono fuel				Bi-fuel ⁽³⁾			Flex-fuel ⁽³⁾			
Idle emissions (Type 2 test)	Yes	Yes	Yes	—	Yes (both fuels)	Yes (both fuels)	Yes (petrol only)	Yes (both fuels)	—	—	—
Crankcase emissions (Type 3 test)	Yes	Yes	Yes	—	Yes (petrol only)	Yes (petrol only)	Yes (petrol only)	Yes (petrol only)	—	—	—
Evaporative emissions (Type 4 test)	Yes	—	—	—	Yes (petrol only)	Yes (petrol only)	Yes (petrol only)	Yes (petrol only)	—	—	—
Durability (Type 5 test)	Yes	Yes	Yes	Yes	Yes (petrol only)	Yes (petrol only)	Yes (petrol only)	Yes (petrol only)	Yes	—	—
Low temperature emissions (Type 6 test)	Yes	—	—	—	Yes (petrol only)	Yes (petrol only)	Yes (petrol only)	Yes (both fuels)	—	—	—
In-service conformity	Yes	Yes	Yes	Yes	Yes (as at type approval)	Yes (as at type approval)	Yes (as at type approval)	Yes (both fuels)	Yes	—	—
On-board diagnostics	Yes	Yes	Yes	Yes	Yes	Yes	Yes	Yes	Yes	—	—
CO ₂ emissions, fuel consumption, electric energy consumption and electric range	Yes	Yes	Yes	Yes	Yes (both fuels)	Yes (both fuels)	Yes (both fuels)	Yes (both fuels)	Yes	Yes	Yes

▼ **M3**

Vehicle category	Vehicles with positive ignition engines including hybrids ⁽¹⁾ ⁽²⁾								Vehicles with compression ignition engines including hybrids	Pure electric vehicles	Hydrogen fuel cell vehicles
	Mono fuel				Bi-fuel ⁽³⁾			Flex-fuel ⁽³⁾			
Smoke opacity	—	—	—	—	—	—	—	—	Yes	—	—
Engine power	Yes	Yes	Yes	Yes	Yes	Yes	Yes	Yes	Yes	Yes	Yes

⁽¹⁾ Specific test procedures for hydrogen and flex fuel biodiesel vehicles will be defined at a later stage.

⁽²⁾ Particulate mass and particle number limits and respective measurement procedures shall apply only to vehicles with direct injection engines

⁽³⁾ When a bi-fuel vehicle is combined with a flex fuel vehicle, both test requirements are applicable.

⁽⁴⁾ Only NO_x emissions shall be determined when the vehicle is running on hydrogen.

⁽⁵⁾ The particle number RDE test only applies to vehicles for which Euro 6 PN emission limits are defined in Table 2 of Annex I to Regulation (EC) No 715/2007.

▼ B

3. EXTENSIONS TO TYPE-APPROVALS

3.1. **Extensions for tailpipe emissions (type 1 and type 2 tests)****▼ M3**

3.1.1. The type-approval shall be extended to vehicles if they conform to the criteria of Article 2 (1) or if they conform to Article 2 (1) (a) and (c) and fulfil all the following criteria:

(a) the CO₂ emission of the tested vehicle resulting from step 9 of Table A7/1 of Sub-Annex 7 to Annex XXI is less than or equal to the CO₂ emission obtained from the interpolation line corresponding to the cycle energy demand of the tested vehicle;

(b) the new interpolation range does not exceed the maximum range as set out in point 2.3.2.2. of Sub-Annex 6 to Annex XXI;

(c) the pollutant emissions respect the limits set out in Table 2 of Annex I to Regulation (EC) No 715/2007.

3.1.1.1. The type-approval shall not be extended to create an interpolation family if it has been granted only in relation to Vehicle High.

▼ B

3.1.2. Vehicles with periodically regenerating systems

▼ M3

For Ki tests undertaken under Appendix 1 to Sub-Annex 6 to Annex XXI (WLTP), the type-approval shall be extended to vehicles if they conform to the criteria of paragraph 5.9. of Annex XXI.

▼ B

For Ki tests undertaken under Annex 13 of UN/ECE Regulation No 83 (NEDC) the type-approval shall be extended to vehicles according to the requirements of Section 3.1.4. of Annex I to Regulation (EC) No 692/2008.

▼ M33.2. **Extensions for evaporative emissions (type 4 test)**

3.2.1. For tests performed in accordance with Annex 6 to UN/ECE Regulation No 83 [1 day NEDC] or the Annex to Regulation (EC) No 2017/1221 [2 days NEDC] the type-approval shall be extended to vehicles equipped with a control system for evaporative emissions which meet the following conditions:

3.2.1.1. The basic principle of fuel/air metering (e.g. single point injection) is the same.

3.2.1.2. The shape of the fuel tank is identical and the material of the fuel tank and liquid fuel hoses are technically equivalent.

3.2.1.3. The worst-case vehicle with regard to the cross-section and approximate hose length shall be tested. Whether non-identical vapour/liquid separators are acceptable is decided by the technical service responsible for the type-approval tests.

3.2.1.4. The fuel tank volume is within a range of $\pm 10\%$.

▼ M3

- 3.2.1.5. The setting of the fuel tank relief valve is identical.
- 3.2.1.6. The method of storage of the fuel vapour is identical, i.e. trap form and volume, storage medium, air cleaner (if used for evaporative emission control), etc.
- 3.2.1.7. The method of purging of the stored vapour is identical (e.g. air flow, start point or purge volume over the preconditioning cycle).
- 3.2.1.8. The method of sealing and venting of the fuel metering system is identical.
- 3.2.2. For tests performed according Annex VI [2 days WLTP] the type-approval shall be extended to vehicles equipped with a control system for evaporative emissions which meet the requirements of point 5.5.1. of Annex VI.
- 3.2.3. The type-approval shall be extended to vehicles with:
 - 3.2.3.1. different engine sizes;
 - 3.2.3.2. different engine powers;
 - 3.2.3.3. automatic and manual gearboxes;
 - 3.2.3.4. two and four wheel transmissions;
 - 3.2.3.5. different body styles; and
 - 3.2.3.6. different wheel and tyre sizes.

▼ B

- 3.3. **Extensions for durability of pollution control devices (type 5 test)**
 - 3.3.1. The type-approval shall be extended to different vehicle types, provided that the vehicle, engine or pollution control system parameters specified below are identical or remain within the prescribed tolerances:
 - 3.3.1.1. Vehicle:
 - Inertia category: the two inertia categories immediately above and any inertia category below.
 - Total road load at 80 km/h: + 5 % above and any value below.
 - 3.3.1.2. Engine
 - (a) engine cylinder capacity ($\pm 15\%$),
 - (b) number and control of valves,
 - (c) fuel system,
 - (d) type of cooling system,
 - (e) combustion process.
 - 3.3.1.3. Pollution control system parameters:
 - (a) Catalytic converters and particulate filters:
 - number of catalytic converters, filters and elements,
 - size of catalytic converters and filters (volume of monolith $\pm 10\%$),

▼B

type of catalytic activity (oxidizing, three-way, lean NO_x trap, SCR, lean NO_x catalyst or other),

precious metal load (identical or higher),

precious metal type and ratio ($\pm 15\%$),

substrate (structure and material),

cell density,

temperature variation of no more than 50 K at the inlet of the catalytic converter or filter. This temperature variation shall be checked under stabilized conditions at a vehicle speed of 120 km/h and the load setting of the type 1 test.

(b) Air injection:

with or without

type (pulsair, air pumps, other(s))

(c) EGR:

with or without

type (cooled or non-cooled, active or passive control, high pressure or low pressure).

3.3.1.4. The durability test may be carried out using a vehicle, which has a different body style, gear box (automatic or manual) and size of the wheels or tyres, from those of the vehicle type for which the type-approval is sought.

3.4. **Extensions for on-board diagnostics**

3.4.1. The type-approval shall be extended to different vehicles with identical engine and emission control systems as defined in Annex XI, Appendix 2. The type-approval shall be extended regardless of the following vehicle characteristics:

(a) engine accessories;

(b) tyres;

(c) equivalent inertia;

(d) cooling system;

(e) overall gear ratio;

(f) transmission type; and

(g) type of bodywork.

3.5. **Extensions for low temperature test (type 6 test)**

3.5.1. Vehicles with different reference masses

3.5.1.1. The type-approval shall be extended only to vehicles with a reference mass requiring the use of the next two higher equivalent inertia or any lower equivalent inertia.

3.5.1.2. For category N vehicles, the approval shall be extended only to vehicles with a lower reference mass, if the emissions of the vehicle already approved are within the limits prescribed for the vehicle for which extension of the approval is requested.

3.5.2. Vehicles with different overall transmission ratios

3.5.2.1. The type-approval shall be extended to vehicles with different transmission ratios only under certain conditions.

▼ B

- 3.5.2.2. To determine whether type-approval can be extended, for each of the transmission ratios used in the type 6 test, the proportion,

$$(E) = (V_2 - V_1)/V_1$$

shall be determined where, at an engine speed of 1 000 min⁻¹, V₁ is the speed of the vehicle-type approved and V₂ is the speed of the vehicle type for which extension of the approval is requested.

- 3.5.2.3. If, for each transmission ratio, E ≤ 8 %, the extension shall be granted without repeating the type 6 test.

- 3.5.2.4. If, for at least one transmission ratio, E > 8 %, and if, for each gear ratio, E ≤ 13 %, the type 6 test shall be repeated. The tests may be performed in a laboratory chosen by the manufacturer subject to the approval of the technical service. The report of the tests shall be sent to the technical service responsible for the type-approval tests.

- 3.5.3. Vehicles with different reference masses and transmission ratios

The type-approval shall be extended to vehicles with different reference masses and transmission ratios, provided that all the conditions prescribed in paragraphs 3.5.1 and 3.5.2 are fulfilled.

4. CONFORMITY OF PRODUCTION

4.1. Introduction

- 4.1.1. Every vehicle produced under a Type Approval according to this Regulation shall be so manufactured as to conform to the type approval requirements of this Regulation. The Manufacturer shall implement adequate arrangements and documented control plans and carry-out at specified intervals as given in this regulation the necessary emission and OBD tests to verify continued conformity with the approved type. The approval authority shall verify and agree with these arrangements and control plans of the manufacturer and perform audits and conduct emission and OBD tests at specific intervals, as given in this regulation, at the premises of the manufacturer, including production and test facilities as part of the product conformity and continued verification arrangements as described in Annex X of Directive 2007/46/EC.

▼ M3

- 4.1.2. The manufacturer shall check the conformity of production by testing the emissions of pollutants (given in Table 2 of Annex I to Regulation (EC) No 715/2007), the emission of CO₂ (along with the measurement of electric energy consumption, EC and, where applicable, the monitoring of the OBFCM device accuracy), the crankcase emissions, evaporative emissions and the OBD in accordance with the test procedures described in Annexes V, VI, XI, XXI and XXII. The verification shall therefore include the tests of types 1, 3, 4 and the test for OBD, as described in section 2.4.

The Type Approval Authority shall keep record for a period of at least 5 years of all the documentation related to the conformity of production test results and shall make it available to the Commission upon request.

The specific procedures for conformity of production are set out in Sections 4.2 to 4.7 and Appendixes 1 and 2.

▼ M3

4.1.3. For the purposes of the manufacturer's conformity of production check, the family means the conformity of production (COP) family for tests of Type 1, including the monitoring of the OBFCEM device accuracy, and Type 3, includes for the Type 4 test the extensions described in point 3.2 and the OBD family with the extensions described in point 3.4 for the OBD tests.

4.1.3.1. COP family criteria

4.1.3.1.1. For Category M vehicles and for Category N1 class I and class II vehicles, the COP family shall be identical to the interpolation family, as described in paragraph 5.6. of Annex XXI.

4.1.3.1.2 For Category N1 Class III and Category N2 vehicles, only vehicles that are identical with respect to the following vehicle/powertrain/transmission characteristics may be part of the same COP family:

(a) Type of internal combustion engine: fuel type (or types in the case of flex-fuel or bi-fuel vehicles), combustion process, engine displacement, full-load characteristics, engine technology, and charging system, and also other engine subsystems or characteristics that have a non-negligible influence on CO₂ mass emission under WLTP conditions;

(b) Operation strategy of all CO₂ mass emission influencing components within the powertrain;

(c) Transmission type (e.g. manual, automatic, CVT) and transmission model (e.g. torque rating, number of gears, number of clutches, etc.);

(d) Number of powered axles.

4.1.4. The frequency for product verification performed by the manufacturer shall be based on a risk assessment methodology consistent with the international standard ISO 31000:2018 — Risk Management — Principles and guidelines and at least for Type 1 with a minimum frequency per COP family of one verification per 5 000 vehicles produced or once per year, whichever comes first.

▼ B

4.1.5. The Approval Authority which has granted type-approval may at any time verify the conformity control methods applied in each production facility.

For the purpose of this regulation the Approval Authority shall perform audits for verifying the manufacturers arrangements and documented control plans at the premises of the manufacturer on a risk assessment methodology consistent with the international standard ISO 31000:2009 — Risk Management — Principles and guidelines and, in all cases, with a minimum frequency of one audit per year.

▼ M3

If the approval authority is not satisfied with the auditing procedure of the manufacturer, physical test shall directly be carried out on production vehicles as described in points 4.2 to 4.7.

▼ B

- 4.1.6. The normal frequency of physical test verifications by the Approval Authority shall be based on the results of the auditing procedure of the manufacturer on a risk assessment methodology and in all cases with a minimum frequency of one verification test per three years. ► **M3** The approval authority shall conduct these physical emission tests and OBD tests on production vehicles as described in points 4.2 to 4.7. ◀

In the case of the manufacturer running the physical tests, the Approval Authority shall witness the tests at the manufacturer's facility.

- 4.1.7. The Approval Authority shall report the results of all audit checks and physical tests performed on verifying conformity of the manufacturers and file it for a period of minimum 10 years. These reports should be available for other type approval authorities and the European Commission on request.
- 4.1.8. In case of non-conformity Article 30 of Directive 2007/46/EC shall apply.

4.2. **Checking the conformity of the vehicle for a type 1 test**

▼ M3

- 4.2.1. The Type 1 test shall be carried out on production vehicles of a valid member of the COP family as described in point 4.1.3.1. The test results shall be the values after all corrections according to this Regulation are applied. The limit values against which to check conformity for pollutants are set out in Table 2 of Annex I to Regulation (EC) No 715/2007. As regards CO₂ emissions, the limit value shall be the value determined by the manufacturer for the selected vehicle in accordance with the interpolation methodology set out in Sub-Annex 7 of Annex XXI. The interpolation calculation shall be verified by the approval authority.
- 4.2.2. A sample of three vehicles shall be selected at random in the COP family. After selection by the approval authority, the manufacturer shall not undertake any adjustment to the vehicles selected.

-
- 4.2.3. The statistical method for calculating the test criteria is described in Appendix 1.

The production of a COP family shall be deemed to not conform when a fail decision is reached for one or more of the pollutants and CO₂ values, in accordance with the test criteria in Appendix 1.

The production of a COP family shall be deemed to conform once a pass decision is reached for all the pollutants and CO₂ values in accordance with the test criteria in Appendix 1.

▼ B

When a pass decision has been reached for one pollutant, that decision shall not be changed by any additional tests carried out to reach a decision for the other pollutants and CO₂ values.

If a pass decision is not reached for all the pollutants and CO₂ values, a test shall be carried out on another vehicle, up to the maximum of 16 vehicles, and the procedure described in Appendix 1 for taking a pass or fail decision shall be repeated (see Figure I.4.2).

▼ B

Figure I.4.2

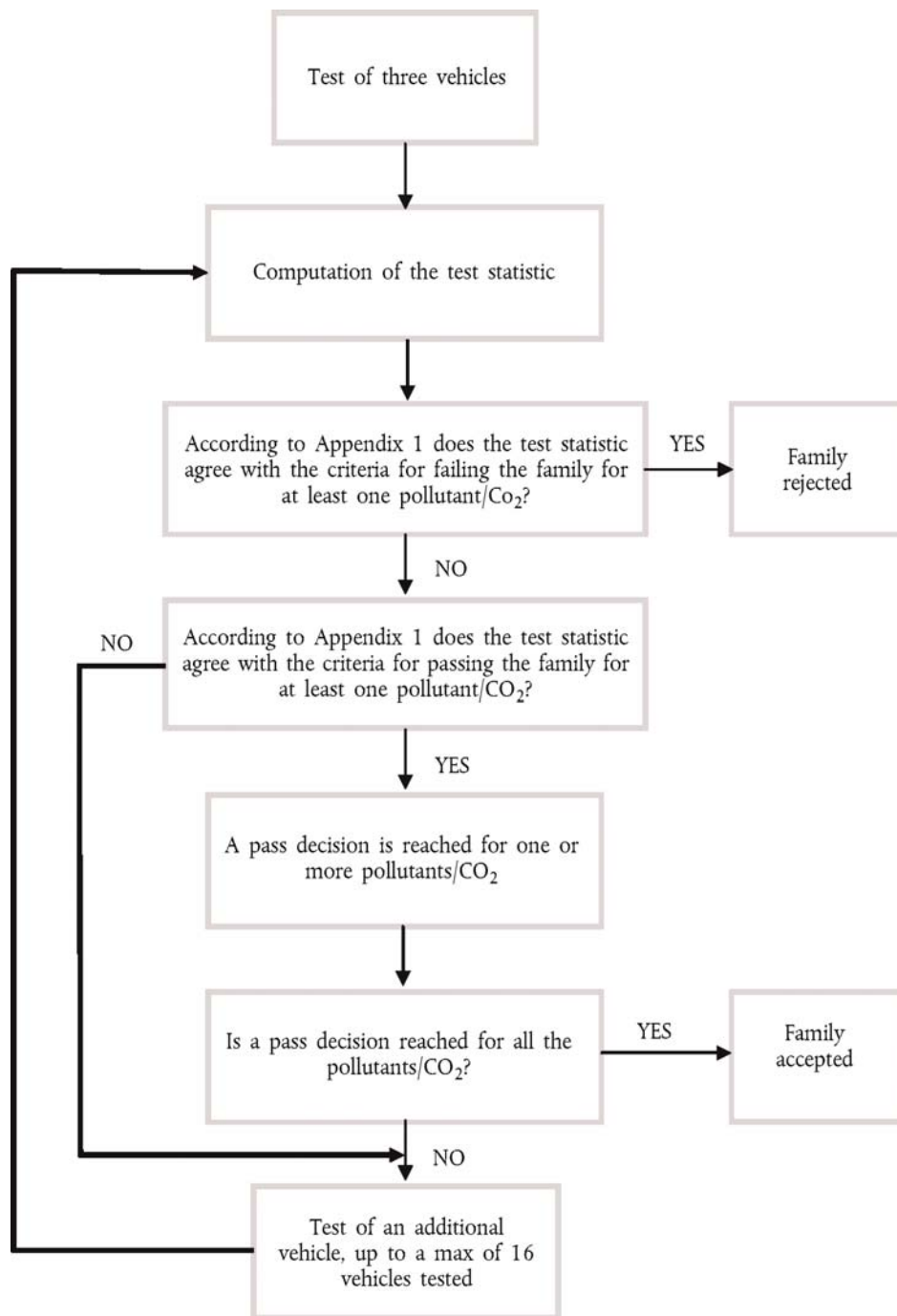
▼ M3

4.2.4. At the request of the manufacturer and with the acceptance of the approval authority, tests may be carried out on a vehicle of the COP family with a maximum of 15 000 km in order to establish measured evolution coefficients EvC for pollutants/CO₂ for each COP family. The running-in procedure shall be conducted by the manufacturer, who shall not to make any adjustments to these vehicles.

▼ B

4.2.4.1. In order to establish a measured evolution coefficient with a run-in vehicle the procedure shall be as follows:

- (a) the pollutants/CO₂ shall be measured at a mileage of at most 80 km and at 'x' km of the first tested vehicle;

▼ B

- (b) the evolution coefficient (EvC) of the pollutants/CO₂ between 80 km and 'x' km shall be calculated as:

$$\text{EvC}_{\text{meas}} = \text{values at 'x' km} / \text{values at 80 km}$$

▼ M3

- (c) the other vehicles in the COP family shall not be run in, but their zero km emissions/EC/CO₂ shall be multiplied by the evolution coefficient of the first run-in vehicle. In this case, the values to be taken for testing as in Appendix 1 shall be:

▼ B

- (i) the values at 'x' km for the first vehicle;
- (ii) the values at zero km multiplied by the relevant evolution coefficient for the other vehicles.

4.2.4.2. All these tests shall be conducted with commercial fuel. However, at the manufacturer's request, the reference fuels described in Annex IX may be used.

4.2.4.3. When checking the conformity of production for CO₂, as an alternative to the procedure mentioned in Section 4.2.4.1 the vehicle manufacturer may use a fixed evolution coefficient EvC of 0,98 and multiply all values of CO₂ measured at zero km by this factor.

4.2.5. Tests for conformity of production of vehicles fuelled by LPG or NG/biomethane may be performed with a commercial fuel of which the C3/C4 ratio lies between those of the reference fuels in the case of LPG, or of one of the high or low caloric fuels in the case of NG/biomethane. In all cases a fuel analysis shall be presented to the approval authority.

4.2.6. Vehicles fitted with eco-innovations

4.2.6.1. In the case of a vehicle type fitted with one or more eco-innovations, within the meaning of Article 12 of Regulation (EC) No 443/2009 for M1 vehicles or Article 12 of Regulation (EU) No 510/2011 for N1 vehicles, the conformity of production shall be demonstrated with respect to the eco-innovations, by checking the presence of the correct eco-innovation(s) in question.

4.3. **PEVs**

4.3.1. Measures to ensure the conformity of production with regard to electric energy consumption (EC) shall be checked on the basis of the type-approval certificate set out in Appendix 4 to this Annex.

4.3.2. Electric energy consumption verification for conformity of production

4.3.2.1. During the conformity of production procedure, the break-off criterion for the Type 1 test procedure according to paragraph 3.4.4.1.3 of Sub-Annex 8 to Annex XXI of this Regulation (consecutive cycle procedure) and paragraph 3.4.4.2.3. of Sub-Annex 8 to Annex XXI of this Regulation (Shortened Test Procedure) shall be replaced with the following:

The break-off criterion for the conformity of production procedure shall be reached with having finished the first applicable WLTP test cycle.

▼B

- 4.3.2.2. During this first applicable WLTP test cycle, the DC energy from the REESS(s) shall be measured according to the method described in Appendix 3 of Sub-Annex 8 to Annex XXI of this Regulation and divided by the driven distance in this applicable WLTP test cycle.
- 4.3.2.3. The value determined according to paragraph 4.3.2.2 shall be compared to the value determined according to paragraph 1.2 of Appendix 2.
- 4.3.2.4. Conformity for EC shall be checked using the statistical procedures described in Section 4.2 and Appendix 1. For the purposes of this conformity check, the terms pollutants/CO₂ shall be replaced by EC.

4.4. OVC-HEVs

- 4.4.1. Measures to ensure the conformity of production with regard to CO₂ mass emission and electric energy consumption from OVC-HEV shall be checked on the basis of the description in the type-approval certificate set out in Appendix 4 to this Annex.

4.4.2. CO₂ mass emission verification for conformity of production

- 4.4.2.1. The vehicle shall be tested according to the charge-sustaining Type 1 test as described in paragraph 3.2.5. of Sub-Annex 8 to Annex XXI of this Regulation.

- 4.4.2.2. During this test, the charge-sustaining CO₂ mass emission shall be determined according to Table A8/5 of Sub-Annex 8 to Annex XXI of this Regulation and compared to the charge-sustaining CO₂ mass emission according to paragraph 2.3 of Appendix 2.

- 4.4.2.3. Conformity for CO₂ emissions shall be checked using the statistical procedures described in Section 4.2 and Appendix 1.

4.4.3. Electric energy consumption verification for conformity of production

- 4.4.3.1. During the conformity of production procedure, the end of the charge-depleting Type 1 test procedure according to paragraph 3.2.4.4. of Sub-Annex 8 to Annex XXI of this Regulation shall be replaced with the following:

The end of the charge-depleting Type 1 test procedure for the conformity of production procedure shall be reached with having finished the first applicable WLTP test cycle.

- 4.4.3.2. During this first applicable WLTP test cycle, the DC energy from the REESS(s) shall be measured according to the method described in Appendix 3 of Sub-Annex 8 to Annex XXI of this Regulation and divided by the driven distance in this applicable WLTP test cycle.

▼M3

- 4.4.3.3. The value determined in accordance with point 4.4.3.2. shall be compared to the value determined in accordance with point 2.4. of Appendix 2.

▼B

- 4.4.1.4. Conformity for EC shall be checked using the statistical procedures described in Section 4.2 and Appendix 1. For the purposes of this conformity check, the terms pollutants/CO₂ shall be replaced by EC.

▼B**4.5. Checking the conformity of the vehicle for a Type 3 test**

4.5.1. If a verification of the Type 3 test is to be carried out, it shall be conducted in accordance with the following requirements:

4.5.1.1. When the approval authority determines that the quality of production seems unsatisfactory, a vehicle shall be randomly taken from the family and subjected to the tests described in Annex V.

4.5.1.2. The production shall be deemed to conform if this vehicle meets the requirements of the tests described in Annex V.

4.5.1.3. If the vehicle tested does not satisfy the requirements of Section 4.5.1.1, a further random sample of four vehicles shall be taken from the same family and subjected to the tests described in Annex V. The tests may be carried out on vehicles which have completed a maximum of 15 000 km with no modifications.

4.5.1.4. The production shall be deemed to conform if at least three vehicles meet the requirements of the tests described in Annex V.

4.6. Checking the conformity of the vehicle for a Type 4 test

4.6.1. If a verification of the Type 4 test is to be carried out, it shall be conducted in accordance with the following requirements:

4.6.1.1. When the approval authority determines that the quality of production seems unsatisfactory, a vehicle shall be randomly taken from the family and subjected to the tests described in Annex VI, or at least as in paragraph 7 of Annex 7 of UN Regulation 83.

4.6.1.2. The production shall be deemed to conform if this vehicle meets the requirements of the tests described in Annex VI, or paragraph 7 of Annex 7 of UN Regulation 83 depending on the test performed.

4.6.1.3. If the vehicle tested does not satisfy the requirements of section 4.6.1.1, a further random sample of four vehicles shall be taken from the same family and subjected to the tests described in Annex VI, or at least as in paragraph 7 of Annex 7 of UN Regulation 83. The tests may be carried out on vehicles which have completed a maximum of 15 000 km with no modifications.

4.6.1.4. The production shall be deemed to conform if at least three vehicles meet the requirements of the tests described in Annex VI, or paragraph 7 of Annex 7 of UN Regulation 83 depending on the test performed.

4.7. Checking the conformity of the vehicle for On-board Diagnostics (OBD)

4.7.1. If a verification of the performance of the OBD system is to be carried out, it shall be conducted in accordance with the following requirements:

4.7.1.1. When the approval authority determines that the quality of production seems unsatisfactory, a vehicle shall be randomly taken from the family and subjected to the tests described in Appendix 1 to Annex XI.

4.7.1.2. The production shall be deemed to conform if this vehicle meets the requirements of the tests described in Appendix 1 to Annex XI.

▼B

- 4.7.1.3. If the vehicle tested does not satisfy the requirements of section 4.7.1.1, a further random sample of four vehicles shall be taken from the same family and subjected to the tests described in Appendix 1 to Annex XI. The tests may be carried out on vehicles which have completed a maximum of 15 000 km with no modifications.
- 4.7.1.4. The production shall be deemed to conform if at least three vehicles meet the requirements of the tests described in Appendix 1 to Annex XI.

▼ B*Appendix 1***Verification of conformity of production for Type 1 test—statistical method****▼ M3**

1. This Appendix describes the procedure to be used to verify the production conformity requirements for the Type 1 test for pollutants/CO₂, including conformity requirements for PEVs and OVC-HEVs, and to monitor the OBFCM device accuracy.

▼ B

2. **► M3** Measurements of the pollutants specified in Table 2 of Annex I to Regulation (EC) No 715/2007, and the emission of CO₂ shall be carried out on a minimum number of 3 vehicles, and consecutively increase until a pass or fail decision is reached. The OBFCM device accuracy shall be determined for each of the N tests. ◀

From the number of N tests: x_1, x_2, \dots, x_N , the average X_{tests} and the variance VAR are to be determined from all N measurements:

$$X_{tests} = (x_1 + x_2 + x_3 + \dots + x_N)/N$$

and

$$VAR = ((x_1 - X_{tests})^2 + (x_2 - X_{tests})^2 + \dots + (x_N - X_{tests})^2)/(N - 1)$$

3. For each number of tests, one of the three following decisions (see (i) to (iii) below) can be reached for pollutants based on the limit value L for each pollutant, the average of all N tests: X_{tests} , the variance of the test results VAR and the number of tests N :

(i) Pass the family if $X_{tests} < A \times L - VAR/L$

(ii) Fail the family if $X_{tests} > A \times L - ((N - 3)/13) \times VAR/L$

(iii) Take another measurement if:

▼ M3

$$A \times L - VAR/L \leq X_{tests} \leq A \times L - ((N - 3)/13) \times VAR/L$$

▼ B

For the measurement of pollutants the factor A is set at 1,05 in order to take into account inaccuracies in the measurements.

4. For CO₂ and EC the normalised values for CO₂ and EC shall be used:

$$x_i = CO_{2test-i}/CO_{2declared}$$

$$x_i = EC_{test-i}/EC_{DC, COP}$$

In the case of CO₂ and EC the factor A is set at 1.01 and the value for L is set at 1. So in the case of CO₂ and EC the criteria are simplified to:

(i) Pass the family if $X_{tests} < A - VAR$

(ii) Fail the family if $X_{tests} > A - ((N - 3)/13) \times VAR$

▼ B

(iii) Take another measurement if:

▼ M3

$$A - VAR \leq X_{tests} \leq A - ((N - 3)/13) \times VAR$$

-
5. For vehicles referred to in Article 4a, the accuracy of the OBFCM device shall be calculated as follows:

$x_{i,OBFCM}$ = accuracy of the OBFCM device determined for each single test i in accordance with the formulae point 4.2 of Annex XXII.

The Type Approval authority shall keep a record of the determined accuracies for each COP family tested.



Appendix 2

Calculations for Conformity of Production of EVs

1. Calculations for conformity of production values for PEVs
 - 1.1 Interpolating of individual electric energy consumption of PEVs

$$EC_{DC-ind,COP} = EC_{DC-L,COP} + K_{ind} \times (EC_{DC-H,COP} - EC_{DC-L,COP})$$

where:

$EC_{DC-ind,COP}$ is the electric energy consumption of an individual vehicle for the conformity of production, Wh/km;

$EC_{DC-L,COP}$ is the electric energy consumption of vehicle L for the conformity of production, Wh/km;

$EC_{DC-H,COP}$ is the electric energy consumption of vehicle H for the conformity of production, Wh/km;

K_{ind} is the interpolation coefficient for the considered individual vehicle for the applicable WLTP test cycle.

- 1.2 Electric Consumption for PEVs

The following value shall be declared and used for verifying the conformity of production with respect to the electric consumption:

$$EC_{DC,COP} = EC_{DC,CD,first\ WLTC} \times AF_{EC}$$

where:

$EC_{DC,COP}$ is the electric energy consumption based on the REESS depletion of the first applicable WLTC test cycle provided for the verification during the conformity of production test procedure;

$EC_{DC,CD,first\ WLTC}$ is the electric energy consumption based on the REESS depletion of the first applicable WLTC test cycle according to paragraph 4.3. of Sub-Annex 8 to Annex XXI, in Wh/km;

AF_{EC} is the adjustment factor which compensates the difference between the charge-depleting electric energy consumption value declared after having performed the Type 1 test procedure during homologation and the measured test result determined during the conformity of production procedure

and

$$AF_{EC} = \frac{EC_{WLTC,declared}}{EC_{WLTC}}$$

▼ B

where

$EC_{WLTC,declared}$ is the declared electric energy consumption for PEVs according to ► **M3** paragraph 1.2.3. of Sub-Annex 6 to Annex XXI ◀

EC_{WLTC} is the measured electric energy consumption according to paragraph 4.3.4.2. of Sub-Annex 8 to Annex XXI.

2. Calculations for conformity of production values for OVC-HEVs
 - 2.1 Individual charge-sustaining CO₂ mass emission of OVC-HEVs for conformity of production

$$M_{CO_2-ind,CS,COP} = M_{CO_2-L,CS,COP} + K_{ind} \times (M_{CO_2-H,CS,COP} - M_{CO_2-L,CS,COP})$$

where:

$M_{CO_2-ind,CS,COP}$ is the charge-sustaining CO₂ mass emission of an individual vehicle for the conformity of production, g/km;

$M_{CO_2-L,CS,COP}$ is the charge-sustaining CO₂ mass emission of vehicle L for the conformity of production, g/km;

$M_{CO_2-H,CS,COP}$ is the charge-sustaining CO₂ mass emission of vehicle H for the conformity of production, g/km;

K_{ind} is the interpolation coefficient for the considered individual vehicle for the applicable WLTP test cycle.

- 2.2 Individual charge-depleting electric energy consumption of OVC-HEVs for conformity of production

$$EC_{DC-ind,CD,COP} = EC_{DC-L,CD,COP} + K_{ind} \times (EC_{DC-H,CD,COP} - EC_{DC-L,CD,COP})$$

where:

$EC_{DC-ind,CD,COP}$ is the charge-depleting electric energy consumption of an individual vehicle for the conformity of production, Wh/km;

$EC_{DC-L,CD,COP}$ is the charge-depleting electric energy consumption of vehicle L for the conformity of production, Wh/km;

$EC_{DC-H,CD,COP}$ is the charge-depleting electric energy consumption of vehicle H for the conformity of production, Wh/km;

K_{ind} is the interpolation coefficient for the considered individual vehicle for the applicable WLTP test cycle.

- 2.3 Charge-sustaining CO₂ mass emission value for conformity of production

The following value shall be declared and used for the verification of the conformity of production with respect to the charge-sustaining CO₂ mass emission:

$$M_{CO_2,CS,COP} = M_{CO_2,CS} \times AF_{CO_2,CS}$$

▼ B

where:

$M_{CO_2,CS,COP}$ is the charge-sustaining CO₂ mass emission value of the charge-sustaining Type 1 test provided for the verification during the conformity of production test procedure;

$M_{CO_2,CS}$ is the charge-sustaining CO₂ mass emission of the charge-sustaining Type 1 test according to ►**M3** paragraph 4.1.1. of Sub-Annex 8 to Annex XXI ◀, g/km;

$AF_{CO_2,CS}$ is the adjustment factor which compensates the difference between the value declared after having performed the Type 1 test procedure during homologation and the measured test result determined during the conformity of production procedure

And

$$AF_{CO_2,CS} = \frac{M_{CO_2,CS,e,declared}}{M_{CO_2,CS,e,6}}$$

where

$M_{CO_2,CS,e,declared}$ is the declared charge-sustaining CO₂ mass emission of the charge-sustaining Type 1 test according to step 7 of Table A8/5 of Sub-Annex 8 to Annex XXI.

$M_{CO_2,CS,e,6}$ is the measured charge-sustaining CO₂ mass emission of the charge-sustaining Type 1 test according to step 6 of Table A8/5 of Sub-Annex 8 to Annex XXI.

2.4 Charge-depleting electric energy consumption for conformity of production

The following value shall be declared and used for verifying the conformity of production with respect to the charge-depleting electric energy consumption

$$EC_{DC,CD,COP} = EC_{DC,CD,first\ WLTC} \times AF_{EC,AC,CD}$$

where:

$EC_{DC,CD,COP}$ is the charge-depleting electric energy consumption based on the REESS depletion of the first applicable WLTC test cycle of the charge-depleting Type 1 test provided for the verification during the conformity of production test procedure;

$EC_{DC,CD,first\ WLTC}$ is the charge-depleting electric energy consumption based on the REESS depletion of the first applicable WLTC test cycle of the charge-depleting Type 1 test according to paragraph 4.3. of Sub-Annex 8 to Annex XXI, Wh/km;

$AF_{EC,AC,CD}$ is the adjustment factor for the charge-depleting electric energy consumption which compensates the difference between the value declared after having performed the Type 1 test procedure during homologation and the measured test result determined during the conformity of production procedure

▼ B

and

$$AF_{EC,AC,CD} = \frac{EC_{AC,CD,declared}}{EC_{AC,CD}}$$

where

$EC_{AC,CD,declared}$ is the declared charge-depleting electric energy consumption of the charge-depleting Type 1 test according to ► **M3** paragraph 1.2.3. of Sub-Annex 6 to Annex XXI ◀.

$EC_{AC,CD}$ is the measured charge-depleting electric energy consumption of the charge-depleting Type 1 test according to paragraph 4.3.1. of Sub-Annex 8 to Annex XXI.

▼B*Appendix 3***MODEL****INFORMATION DOCUMENT No ...****RELATING TO EC TYPE-APPROVAL OF A VEHICLE WITH REGARD TO EMISSIONS AND ACCESS TO VEHICLE REPAIR AND MAINTENANCE INFORMATION**

The following information, if applicable, must be supplied in triplicate and include a list of contents. Any drawings must be supplied in appropriate scale and in sufficient detail on size A4 or on a folder of A4 format. Photographs, if any, must show sufficient detail.

If the systems, components or separate technical units have electronic controls, information concerning their performance must be supplied.

- 0 GENERAL
- 0.1. Make (trade name of manufacturer):
- 0.2. Type:
- 0.2.1. Commercial name(s) (if available):

▼M3

- 0.2.2.1. Allowed Parameter Values for multistage type approval to use the base vehicle emission values (insert range if applicable):
 - Final Vehicle mass in running order (in kg):
 - Frontal area for final vehicle (in cm²):
 - Rolling resistance (kg/t):
 - Cross-sectional area of air entrance of the front grille (in cm²):
- 0.2.3. Identifiers:
 - 0.2.3.1. interpolation family's identifier:
 - 0.2.3.2. ATCT family's identifier:
 - 0.2.3.3. PEMS family's identifier:
 - 0.2.3.4. Roadload family's identifier
 - 0.2.3.4.1. Roadload family of VH:
 - 0.2.3.4.2. Roadload family of VL:
 - 0.2.3.4.3. Roadload families applicable in the interpolation family:

▼ M3

- 0.2.3.5. Roadload Matrix family's identifier:
- 0.2.3.6. Periodic regeneration family's identifier:
- 0.2.3.7. Evaporative test family's identifier:
- 0.2.3.8. OBD family's identifier:
- 0.2.3.9. other family's identifier:

▼ B

- 0.4. Category of vehicle ^(c):
- 0.8. Name(s) and address(es) of assembly plant(s):
- 0.9. Name and address of the manufacturer's representative (if any):
- 1 GENERAL CONSTRUCTION CHARACTERISTICS
- 1.1. Photographs and/or drawings of a representative vehicle/component/separate technical unit ⁽¹⁾:
- 1.3.3. Powered axles (number, position, interconnection):
- 2 MASSES AND DIMENSIONS ^(f) ^(g) ⁽⁷⁾
(in kg and mm) (Refer to drawing where applicable)
- 2.6. Mass in running order ^(h)
(a) maximum and minimum for each variant:
.....
▶ **M3** ————— ◀

▼ M3

- 2.6.3. Rotational mass: 3 % of the sum of mass in running order and 25 kg or value, per axle (kg):

▼ B

- 2.8. Technically permissible maximum laden mass stated by the manufacturer ⁽ⁱ⁾ ⁽³⁾:
- 3 PROPULSION ENERGY CONVERTER ^(k)
- 3.1. Manufacturer of the propulsion energy converter(s):
- 3.1.1. Manufacturer's code (as marked on the propulsion energy converter or other means of identification):
- 3.2. Internal combustion engine
- 3.2.1.1. Working principle: positive ignition/compression ignition/dual fuel ⁽¹⁾
Cycle: four stroke/two stroke/rotary ⁽¹⁾

▼ B

- 3.2.1.2. Number and arrangement of cylinders:
- 3.2.1.2.1. Bore ⁽¹⁾: mm
- 3.2.1.2.2. Stroke ⁽¹⁾: mm
- 3.2.1.2.3. Firing order:
- 3.2.1.3. Engine capacity ^(m): cm³
- 3.2.1.4. Volumetric compression ratio ⁽²⁾:
- 3.2.1.5. Drawings of combustion chamber, piston crown and, in the case of positive ignition engines, piston rings:
- 3.2.1.6. Normal engine idling speed ⁽²⁾: min⁻¹
- 3.2.1.6.1. High engine idling speed ⁽²⁾: min⁻¹
- 3.2.1.8. Rated engine power ⁽ⁿ⁾: kW at min⁻¹ (manufacturer's declared value)
- 3.2.1.9. Maximum permitted engine speed as prescribed by the manufacturer: min⁻¹
- 3.2.1.10. Maximum net torque ⁽ⁿ⁾: ... Nm at ... min⁻¹ (manufacturer's declared value)
- 3.2.2. Fuel

▼ M3

- 3.2.2.1. Diesel/Petrol/LPG/NG or Biomethane/Ethanol (E 85)/Biodiesel/Hydrogen ⁽¹⁾, ⁽⁶⁾

▼ B

- 3.2.2.1.1. RON, unleaded:
- 3.2.2.4. Vehicle fuel type: Mono fuel, Bi fuel, Flex fuel ⁽¹⁾
- 3.2.2.5. Maximum amount of biofuel acceptable in fuel (manufacturer's declared value): % by volume
- 3.2.4. Fuel feed
 - 3.2.4.1. By carburettor(s): yes/no ⁽¹⁾
 - 3.2.4.2. By fuel injection (compression ignition or dual fuel only): yes/no ⁽¹⁾
 - 3.2.4.2.1. System description (common rail/unit injectors/distribution pump etc.):
 - 3.2.4.2.2. Working principle: direct injection/pre-chamber/swirl chamber ⁽¹⁾
 - 3.2.4.2.3. Injection/Delivery pump
 - 3.2.4.2.3.1. Make(s):
 - 3.2.4.2.3.2. Type(s):

▼ B

- 3.2.4.2.3.3. Maximum fuel delivery ⁽¹⁾ ⁽²⁾: mm³ /stroke or cycle at an engine speed of: min⁻¹ or, alternatively, a characteristic diagram: (When boost control is supplied, state the characteristic fuel delivery and boost pressure versus engine speed)
- 3.2.4.2.4. Engine speed limitation control
- 3.2.4.2.4.2.1. Speed at which cut-off starts under load: min⁻¹
- 3.2.4.2.4.2.2. Maximum no-load speed: min⁻¹
- 3.2.4.2.6. Injector(s)
- 3.2.4.2.6.1. Make(s):
- 3.2.4.2.6.2. Type(s):
- 3.2.4.2.8. Auxiliary starting aid
- 3.2.4.2.8.1. Make(s):
- 3.2.4.2.8.2. Type(s):
- 3.2.4.2.8.3. System description:
- 3.2.4.2.9. Electronic controlled injection: yes/no ⁽¹⁾
- 3.2.4.2.9.1. Make(s):
- 3.2.4.2.9.2. Type(s):
- 3.2.4.2.9.3. Description of the system:
- 3.2.4.2.9.3.1. Make and type of the control unit (ECU):
- 3.2.4.2.9.3.1.1. Software version of the ECU:
- 3.2.4.2.9.3.2. Make and type of the fuel regulator:
- 3.2.4.2.9.3.3. Make and type of the air-flow sensor:
- 3.2.4.2.9.3.4. Make and type of fuel distributor:
- 3.2.4.2.9.3.5. Make and type of the throttle housing:
- 3.2.4.2.9.3.6. Make and type or working principle of water temperature sensor:
- 3.2.4.2.9.3.7. Make and type or working principle of air temperature sensor:
- 3.2.4.2.9.3.8. Make and type or working principle of air pressure sensor:
- 3.2.4.3. By fuel injection (positive ignition only): yes/no ⁽¹⁾
- 3.2.4.3.1. Working principle: intake manifold (single-/multi-point/direct injection ⁽¹⁾ /other (specify):

▼ B

- 3.2.4.3.2. Make(s):
- 3.2.4.3.3. Type(s):
- 3.2.4.3.4. System description (In the case of systems other than continuous injection give equivalent details):
- 3.2.4.3.4.1. Make and type of the control unit (ECU):
- 3.2.4.3.4.1.1. Software version of the ECU:
- 3.2.4.3.4.3. Make and type or working principle of air-flow sensor:
- 3.2.4.3.4.8. Make and type of throttle housing:
- 3.2.4.3.4.9. Make and type or working principle of water temperature sensor:
- 3.2.4.3.4.10. Make and type or working principle of air temperature sensor:
- 3.2.4.3.4.11. Make and type or working principle of air pressure sensor:
- 3.2.4.3.5. Injectors
- 3.2.4.3.5.1. Make:
- 3.2.4.3.5.2. Type:
- 3.2.4.3.7. Cold start system
- 3.2.4.3.7.1. Operating principle(s):
- 3.2.4.3.7.2. Operating limits/settings ⁽¹⁾ ⁽²⁾:
- 3.2.4.4. Feed pump
- 3.2.4.4.1. Pressure ⁽²⁾: kPa or characteristic diagram ⁽²⁾:
- 3.2.4.4.2. Make(s):
- 3.2.4.4.3. Type(s):
- 3.2.5. Electrical system
- 3.2.5.1. Rated voltage: V, positive/negative ground ⁽¹⁾
- 3.2.5.2. Generator
- 3.2.5.2.1. Type:
- 3.2.5.2.2. Nominal output: VA
- 3.2.6. Ignition system (spark ignition engines only)
- 3.2.6.1. Make(s):
- 3.2.6.2. Type(s):
- 3.2.6.3. Working principle:
- 3.2.6.6. Spark plugs
- 3.2.6.6.1. Make:
- 3.2.6.6.2. Type:

▼B

- 3.2.6.6.3. Gap setting: mm
- 3.2.6.7. Ignition coil(s)
 - 3.2.6.7.1. Make:
 - 3.2.6.7.2. Type:
- 3.2.7. Cooling system: liquid/air ⁽¹⁾
 - 3.2.7.1. Nominal setting of the engine temperature control mechanism:
 - 3.2.7.2. Liquid
 - 3.2.7.2.1. Nature of liquid:
 - 3.2.7.2.2. Circulating pump(s): yes/no ⁽¹⁾
 - 3.2.7.2.3. Characteristics: or
 - 3.2.7.2.3.1. Make(s):
 - 3.2.7.2.3.2. Type(s):
 - 3.2.7.2.4. Drive ratio(s):
 - 3.2.7.2.5. Description of the fan and its drive mechanism:
 - 3.2.7.3. Air
 - 3.2.7.3.1. Fan: yes/no ⁽¹⁾
 - 3.2.7.3.2. Characteristics: or
 - 3.2.7.3.2.1. Make(s):
 - 3.2.7.3.2.2. Type(s):
 - 3.2.7.3.3. Drive ratio(s):
- 3.2.8. Intake system
 - 3.2.8.1. Pressure charger: yes/no ⁽¹⁾
 - 3.2.8.1.1. Make(s):
 - 3.2.8.1.2. Type(s):
 - 3.2.8.1.3. Description of the system (e.g. maximum charge pressure: kPa; wastegate if applicable):
 - 3.2.8.2. Intercooler: yes/no ⁽¹⁾
 - 3.2.8.2.1. Type: air-air/air-water ⁽¹⁾
 - 3.2.8.3. Intake depression at rated engine speed and at 100 % load (compression ignition engines only)
 - 3.2.8.4. Description and drawings of inlet pipes and their accessories (plenum chamber, heating device, additional air intakes, etc.):
 - 3.2.8.4.1. Intake manifold description (include drawings and/or photos):

▼B

- 3.2.8.4.2. Air filter, drawings: or
- 3.2.8.4.2.1. Make(s):
- 3.2.8.4.2.2. Type(s):
- 3.2.8.4.3. Intake silencer, drawings: or
- 3.2.8.4.3.1. Make(s):
- 3.2.8.4.3.2. Type(s):
- 3.2.9. Exhaust system
- 3.2.9.1. Description and/or drawing of the exhaust manifold:
- 3.2.9.2. Description and/or drawing of the exhaust system:
- 3.2.9.3. Maximum allowable exhaust back pressure at rated engine speed and at 100 % load (compression ignition engines only): kPa
- 3.2.10. Minimum cross-sectional areas of inlet and outlet ports:
- 3.2.11. Valve timing or equivalent data
- 3.2.11.1. Maximum lift of valves, angles of opening and closing, or timing details of alternative distribution systems, in relation to dead centres. For variable timing system, minimum and maximum timing:
- 3.2.11.2. Reference and/or setting ranges ⁽¹⁾:
- 3.2.12. Measures taken against air pollution
- 3.2.12.1. Device for recycling crankcase gases (description and drawings):
- 3.2.12.2. Pollution control devices (if not covered by another heading)
- 3.2.12.2.1. Catalytic converter
- 3.2.12.2.1.1. Number of catalytic converters and elements (provide the information below for each separate unit):
- 3.2.12.2.1.2. Dimensions, shape and volume of the catalytic converter(s):
- 3.2.12.2.1.3. Type of catalytic action:
- 3.2.12.2.1.4. Total charge of precious metals:
- 3.2.12.2.1.5. Relative concentration:
- 3.2.12.2.1.6. Substrate (structure and material):
- 3.2.12.2.1.7. Cell density:
- 3.2.12.2.1.8. Type of casing for the catalytic converter(s):
- 3.2.12.2.1.9. Location of the catalytic converter(s) (place and reference distance in the exhaust line):
- 3.2.12.2.1.10. Heat shield: yes/no ⁽¹⁾

▼ B

- 3.2.12.2.1.11. Normal operating temperature range: °C
- 3.2.12.2.1.12. Make of catalytic converter:
- 3.2.12.2.1.13. Identifying part number:
- 3.2.12.2.2. Sensors
- 3.2.12.2.2.1. Oxygen sensor: yes/no ⁽¹⁾
- 3.2.12.2.2.1.1. Make:
- 3.2.12.2.2.1.2. Location:
- 3.2.12.2.2.1.3. Control range:
- 3.2.12.2.2.1.4. Type or working principle:
- 3.2.12.2.2.1.5. Identifying part number:
- 3.2.12.2.2.2. NO_x sensor: yes/no ⁽¹⁾
- 3.2.12.2.2.2.1. Make:
- 3.2.12.2.2.2.2. Type:
- 3.2.12.2.2.2.3. Location
- 3.2.12.2.2.3. Particulate sensor: yes/no ⁽¹⁾
- 3.2.12.2.2.3.1. Make:
- 3.2.12.2.2.3.2. Type:
- 3.2.12.2.2.3.3. Location:
- 3.2.12.2.3. Air injection: yes/no ⁽¹⁾
- 3.2.12.2.3.1. Type (pulse air, air pump, etc.):
- 3.2.12.2.4. Exhaust gas recirculation (EGR): yes/no ⁽¹⁾
- 3.2.12.2.4.1. Characteristics (make, type, flow, high pressure/low pressure/combined pressure, etc.):
- 3.2.12.2.4.2. Water-cooled system (to be specified for each EGR system e.g. low pressure/high pressure/combined pressure: yes/no ⁽¹⁾)
- 3.2.12.2.5. Evaporative emissions control system (petrol and ethanol engines only): yes/no ⁽¹⁾
- 3.2.12.2.5.1. Detailed description of the devices:
- 3.2.12.2.5.2. Drawing of the evaporative control system:
- 3.2.12.2.5.3. Drawing of the carbon canister:
- 3.2.12.2.5.4. Mass of dry charcoal: g

▼ M3

- 3.2.12.2.5.5. Schematic drawing of the fuel tank (petrol and ethanol engines only):
- 3.2.12.2.5.5.1. Fuel tank system capacity, material and construction:
- 3.2.12.2.5.5.2. Description of vapour hose material, fuel line material and connection technique of the fuel system:
- 3.2.12.2.5.5.3. Sealed tank system: yes/no
- 3.2.12.2.5.5.4. Description of fuel tank relief valve setting (air ingestion and relief):

▼ M3

- 3.2.12.2.5.5.5. Description of the purge control system:
- 3.2.12.2.5.6. Description and schematic of the heat shield between tank and exhaust system:
- 3.2.12.2.5.7. Permeability factor:

▼ B

- 3.2.12.2.6. Particulate trap (PT): yes/no ⁽¹⁾
- 3.2.12.2.6.1. Dimensions, shape and capacity of the particulate trap:
- 3.2.12.2.6.2. Design of the particulate trap:
- 3.2.12.2.6.3. Location (reference distance in the exhaust line):
- 3.2.12.2.6.4. Make of particulate trap:
- 3.2.12.2.6.5. Identifying part number:
- 3.2.12.2.7. On-board-diagnostic (OBD) system: yes/no ⁽¹⁾
- 3.2.12.2.7.1. Written description and/or drawing of the MI:
- 3.2.12.2.7.2. List and purpose of all components monitored by the OBD system:
- 3.2.12.2.7.3. Written description (general working principles) for
 - 3.2.12.2.7.3.1. Positive-ignition engines
 - 3.2.12.2.7.3.1.1. Catalyst monitoring:
 - 3.2.12.2.7.3.1.2. Misfire detection:
 - 3.2.12.2.7.3.1.3. Oxygen sensor monitoring:
 - 3.2.12.2.7.3.1.4. Other components monitored by the OBD system:
 - 3.2.12.2.7.3.2. Compression-ignition engines:
 - 3.2.12.2.7.3.2.1. Catalyst monitoring:
 - 3.2.12.2.7.3.2.2. Particulate trap monitoring:
 - 3.2.12.2.7.3.2.3. Electronic fuelling system monitoring:
 - 3.2.12.2.7.3.2.5. Other components monitored by the OBD system:
- 3.2.12.2.7.4. Criteria for MI activation (fixed number of driving cycles or statistical method):
- 3.2.12.2.7.5. List of all OBD output codes and formats used (with explanation of each):
- 3.2.12.2.7.6. The following additional information shall be provided by the vehicle manufacturer for the purposes of enabling the manufacture of OBD-compatible replacement or service parts and diagnostic tools and test equipment.
 - 3.2.12.2.7.6.1. A description of the type and number of the preconditioning cycles used for the original type approval of the vehicle.

▼B

3.2.12.2.7.6.2. A description of the type of the OBD demonstration cycle used for the original type-approval of the vehicle for the component monitored by the OBD system.

3.2.12.2.7.6.3. A comprehensive document describing all sensed components with the strategy for fault detection and MI activation (fixed number of driving cycles or statistical method), including a list of relevant secondary sensed parameters for each component monitored by the OBD system. A list of all OBD output codes and format used (with an explanation of each) associated with individual emission related power-train components and individual non-emission related components, where monitoring of the component is used to determine MI activation, including in particular a comprehensive explanation for the data given in service \$05 Test ID \$21 to FF and the data given in service \$06.

In the case of vehicle types that use a communication link in accordance with ISO 15765-4 'Road vehicles, diagnostics on controller area network (CAN) — Part 4: requirements for emissions-related systems', a comprehensive explanation for the data given in service \$06 Test ID \$00 to FF, for each OBD monitor ID supported, shall be provided.

3.2.12.2.7.6.4. The information required above may be defined by completing a table as described below.

3.2.12.2.7.6.4.1. Light-duty vehicles

Component	Fault code	Monitoring strategy	Fault detection criteria	MI activation criteria	Secondary parameters	Preconditioning	Demonstration test
Catalyst	P0420	Oxygen sensor 1 and sensor 2 signals	Difference between sensor 1 and sensor 2 signals-	3rd cycle	Engine speed load, A/F mode, catalyst temperature	Two type I cycles	Type I

3.2.12.2.8. Other system:

3.2.12.2.8.2. Driver inducement system

3.2.12.2.8.2.3. Type of inducement system: no engine restart after countdown/no start after refuelling/fuel-lockout/performance restriction

3.2.12.2.8.2.4. Description of the inducement system

▼B

- 3.2.12.2.8.2.5. Equivalent to the average driving range of the vehicle with a complete tank of fuel: km
- 3.2.12.2.10. Periodically regenerating system: (provide the information below for each separate unit)
- 3.2.12.2.10.1. Method or system of regeneration, description and/or drawing:
- 3.2.12.2.10.2. The number of Type 1 operating cycles, or equivalent engine test bench cycles, between two cycles where regenerative phases occur under the conditions equivalent to Type 1 test (Distance 'D' in Figure A6.App1/1 in Appendix 1 to Sub-Annex 6 of Annex XXI to Regulation (EU) 2017/1151 or figure A13/1 in Annex 13 to UN/ECE Regulation 83 (as applicable)):
- 3.2.12.2.10.2.1. Applicable Type 1 cycle (indicate the applicable procedure: Annex XXI, Sub-Annex 4 or UN/ECE Regulation 83):
- 3.2.12.2.10.3. Description of method employed to determine the number of cycles between two cycles where regenerative phases occur:
- 3.2.12.2.10.4. Parameters to determine the level of loading required before regeneration occurs (i.e. temperature, pressure etc.):
- 3.2.12.2.10.5. Description of method used to load system in the test procedure described in paragraph 3.1., Annex 13 to UN/ECE Regulation 83:
- 3.2.12.2.11. Catalytic converter systems using consumable reagents (provide the information below for each separate unit) yes/no ⁽¹⁾
- 3.2.12.2.11.1. Type and concentration of reagent needed:
- 3.2.12.2.11.2. Normal operational temperature range of reagent:
- 3.2.12.2.11.3. International standard:
- 3.2.12.2.11.4. Frequency of reagent refill: continuous/maintenance (where appropriate):
- 3.2.12.2.11.5. Reagent indicator: (description and location)
- 3.2.12.2.11.6. Reagent tank
- 3.2.12.2.11.6.1. Capacity:
- 3.2.12.2.11.6.2. Heating system: yes/no
- 3.2.12.2.11.6.2.1. Description or drawing
- 3.2.12.2.11.7. Reagent control unit: yes/no ⁽¹⁾
- 3.2.12.2.11.7.1. Make:
- 3.2.12.2.11.7.2. Type:
- 3.2.12.2.11.8. Reagent injector (make type and location):

▼M3

- 3.2.12.2.12. Water injection: yes/no ⁽¹⁾

▼B

- 3.2.13. Smoke opacity
 - 3.2.13.1. Location of the absorption coefficient symbol (compression ignition engines only):
- 3.2.14. Details of any devices designed to influence fuel economy (if not covered by other items):.....
- 3.2.15. LPG fuelling system: yes/no ⁽¹⁾
 - 3.2.15.1. Type-approval number according to Regulation (EC) No 661/2009 (OJ L 200, 31.7.2009, p. 1):
 - 3.2.15.2. Electronic engine management control unit for LPG fuelling
 - 3.2.15.2.1. Make(s):
 - 3.2.15.2.2. Type(s):
 - 3.2.15.2.3. Emission-related adjustment possibilities:
 - 3.2.15.3. Further documentation
 - 3.2.15.3.1. Description of the safeguarding of the catalyst at switch-over from petrol to LPG or back:
 - 3.2.15.3.2. System lay-out (electrical connections, vacuum connections compensation hoses, etc.):
 - 3.2.15.3.3. Drawing of the symbol:
- 3.2.16. NG fuelling system: yes/no ⁽¹⁾
 - 3.2.16.1. Type-approval number according to Regulation (EC) No 661/2009:
 - 3.2.16.2. Electronic engine management control unit for NG fuelling
 - 3.2.16.2.1. Make(s):
 - 3.2.16.2.2. Type(s):
 - 3.2.16.2.3. Emission-related adjustment possibilities:
 - 3.2.16.3. Further documentation
 - 3.2.16.3.1. Description of the safeguarding of the catalyst at switch-over from petrol to NG or back:
 - 3.2.16.3.2. System lay-out (electrical connections, vacuum connections compensation hoses, etc.):
 - 3.2.16.3.3. Drawing of the symbol:
- 3.2.18. Hydrogen fuelling system: yes/no ⁽¹⁾
 - 3.2.18.1. EC type-approval number in accordance with Regulation (EC) No 79/2009:
 - 3.2.18.2. Electronic engine management control unit for hydrogen fuelling
 - 3.2.18.2.1. Make(s):
 - 3.2.18.2.2. Type(s):
 - 3.2.18.2.3. Emission-related adjustment possibilities:
 - 3.2.18.3. Further documentation
 - 3.2.18.3.1. Description of the safeguarding of the catalyst at switch-over from petrol to hydrogen or back:

▼ B

- 3.2.18.3.2. System lay-out (electrical connections, vacuum connections compensation hoses, etc.):
- 3.2.18.3.3. Drawing of the symbol:
- 3.2.19.4. Further documentation

▼ M3

▼ B

- 3.2.19.4.2. System lay-out (electrical connections, vacuum connections compensation hoses, etc.):
- 3.2.19.4.3. Drawing of the symbol:

▼ M3

- 3.2.20. Heat storage information

▼ B

- 3.2.20.1. Active heat storage device: yes/no ⁽¹⁾
- 3.2.20.1.1. Enthalpy: (J)

▼ M3

- 3.2.20.2. Insulation materials: yes/no ⁽¹⁾

▼ B

- 3.2.20.2.1. Insulation material:
- 3.2.20.2.2. Insulation volume:
- 3.2.20.2.3. Insulation weight:
- 3.2.20.2.4. Insulation location:

▼ M3

- 3.2.20.2.5. Worst case approach vehicle cool down: yes/no ⁽¹⁾
- 3.2.20.2.5.1. (not worst case approach) Minimum soaking time, $t_{\text{soak_ATCT}}$ (hours):.....
- 3.2.20.2.5.2. (not worst case approach) Location of the engine temperature measurement:
- 3.2.20.2.6. Single interpolation family within the ATCT family approach: yes/no ⁽¹⁾

- 3.3. Electric machine
- 3.3.1. Type (winding, excitation):
- 3.3.1.1. Maximum hourly output: kW
(manufacturer's declared value)
- 3.3.1.1.1. Maximum net power (a) kW
(manufacturer's declared value)
- 3.3.1.1.2. Maximum 30 minutes power (a) kW
(manufacturer's declared value)
- 3.3.1.2. Operating voltage:..... V
- 3.3.2. REESS
- 3.3.2.1. Number of cells:
- 3.3.2.2. Mass: kg
- 3.3.2.3. Capacity: Ah (Amp-hours)

▼ M3

3.3.2.4. Position:

▼ B

- 3.4. Combinations of propulsion energy converters
- 3.4.1. Hybrid electric vehicle: yes/no ⁽¹⁾
- 3.4.2. Category of hybrid electric vehicle: off-vehicle charging/not off-vehicle charging: ⁽¹⁾
- 3.4.3. Operating mode switch: with/without ⁽¹⁾
- 3.4.3.1. Selectable modes
- 3.4.3.1.1. Pure electric: yes/no ⁽¹⁾
- 3.4.3.1.2. Pure fuel consuming: yes/no ⁽¹⁾
- 3.4.3.1.3. Hybrid modes: yes/no ⁽¹⁾
(if yes, short description):
- 3.4.4. Description of the energy storage device: (REESS, capacitor, flywheel/generator)
- 3.4.4.1. Make(s):
- 3.4.4.2. Type(s):
- 3.4.4.3. Identification number:
- 3.4.4.4. Kind of electrochemical couple:
- 3.4.4.5. Energy: (for REESS: voltage and capacity Ah in 2 h, for capacitor: J,)
- 3.4.4.6. Charger: on board/external/without ⁽¹⁾
- 3.4.5. Electric machine (describe each type of electric machine separately)
- 3.4.5.1. Make:
- 3.4.5.2. Type:
- 3.4.5.3. Primary use: traction motor/generator ⁽¹⁾
- 3.4.5.3.1. When used as traction motor: single-/multimotors (number) ⁽¹⁾:
- 3.4.5.4. Maximum power: kW
- 3.4.5.5. Working principle
- 3.4.5.5.1. Direct current/alternating current/number of phases:
- 3.4.5.5.2. Separate excitation/series/compound ⁽¹⁾
- 3.4.5.5.3. Synchronous/asynchronous ⁽¹⁾
- 3.4.6. Control unit
- 3.4.6.1. Make(s):
- 3.4.6.2. Type(s):
- 3.4.6.3. Identification number:
- 3.4.7. Power controller
- 3.4.7.1. Make:
- 3.4.7.2. Type:
- 3.4.7.3. Identification number:
- 3.4.9. Manufacturer's recommendation for preconditioning:

▼B

3.5. Manufacturer's declared values for determination of CO₂ emissions/fuel consumption/electric consumption/electric range and details of eco-innovations (where applicable) (°)

3.5.7. Manufacturer's declared values

▼M3

3.5.7.1. Test vehicle parameters

Vehicle	Vehicle Low (VL) if existing	Vehicle High (VH)	VM if existing	V representative (only for road load matrix family (*))	Default values
Vehicle bodywork type			—		
Road load method used (measurement or calculation by road load family)			—	—	
Road load information:					
Tyres make and type, if measurement			—		
Tyre dimensions (front/rear), if measurement			—		
Tyre rolling resistance (front/rear) (kg/t)					
Tyre pressure (front/rear) (kPa), if measurement					
Delta C _D × A of vehicle L compared to vehicle H (IP_H minus IP_L)	—		—	—	
Delta C _D × A compared to road load family vehicle L (IP_H/L minus RL_L), if calculation by road load family			—	—	
Vehicle test mass (kg)					
Road load coefficients					
f ₀ (N)					
f ₁ (N/(km/h))					
f ₂ (N/(km/h) ²)					
Frontal area m ² (0,000 m ²)	—	—	—		
Cycle Energy Demand (J)					

(*) Representative vehicle is tested for the road load matrix family.

▼ M3

- 3.5.7.1.1. Fuel used for the Type 1 test and selected for the measurement of the net power in accordance with Annex XX to this Regulation (for LPG or NG vehicles only):
-

▼ B

- 3.5.7.2. Combined CO₂ mass emissions

▼ M3

- 3.5.7.2.1. CO₂ mass emission for pure ICE vehicles and NOVC-HEVs
- 3.5.7.2.1.0. Minimum and maximum CO₂ values within the interpolation family
- 3.5.7.2.1.1. Vehicle high: g/km
- 3.5.7.2.1.1.0. Vehicle high (NEDC): g/km
- 3.5.7.2.1.2. Vehicle low (if applicable): g/km
- 3.5.7.2.1.2.0. Vehicle low (if applicable) (NEDC): g/km
- 3.5.7.2.1.3. Vehicle M (if applicable): g/km
- 3.5.7.2.1.3.0. Vehicle M (if applicable) (NEDC): g/km
- 3.5.7.2.2. Charge-Sustaining CO₂ mass emission for OVC-HEVs
- 3.5.7.2.2.1. Charge Sustaining CO₂ mass emission vehicle high: g/km
- 3.5.7.2.2.1.0. Combined CO₂ mass emission vehicle high (NEDC Condition B): g/km
- 3.5.7.2.2.2. Charge Sustaining CO₂ mass emission vehicle low (if applicable): g/km
- 3.5.7.2.2.2.0. Combined CO₂ mass emission vehicle low (if applicable) (NEDC Condition B): g/km
- 3.5.7.2.2.3. Charge Sustaining CO₂ mass emission vehicle M (if applicable): g/km
- 3.5.7.2.2.3.0. Combined CO₂ mass emission vehicle M (if applicable) (NEDC Condition B): g/km
- 3.5.7.2.3. Charge Depleting CO₂ mass emission and weighted CO₂ mass emission for OVC-HEVs

▼ M3

- 3.5.7.2.3.1. Charge Depleting CO₂ mass emission of Vehicle high: g/km
- 3.5.7.2.3.1.0. Charge Depleting CO₂ mass emission of Vehicle high (NEDC Condition A): g/km
- 3.5.7.2.3.2. Charge Depleting CO₂ mass emission of Vehicle low (if applicable): g/km
- 3.5.7.2.3.2.0. Charge Depleting CO₂ mass emission of Vehicle low (if applicable) (NEDC Condition A): g/km
- 3.5.7.2.3.3. Charge Depleting CO₂ mass emission of Vehicle M (if applicable): g/km
- 3.5.7.2.3.3.0. Charge Depleting CO₂ mass emission of Vehicle M (if applicable) (NEDC Condition A): g/km
- 3.5.7.2.3.4. Minimum and maximum weighted CO₂ values within the OVC interpolation family

▼ B

- 3.5.7.3. Electric range for electrified vehicles
- 3.5.7.3.1. Pure Electric Range (PER) for PEVs
- 3.5.7.3.1.1. Vehicle high: km
- 3.5.7.3.1.2. Vehicle low (if applicable): km
- 3.5.7.3.2. All Electric Range AER for OVC-HEVs
- 3.5.7.3.2.1. Vehicle high: km
- 3.5.7.3.2.2. Vehicle low (if applicable): km
- 3.5.7.3.2.3. Vehicle M (if applicable): km
- 3.5.7.4. Charge Sustaining fuel consumption (FC_{CS}) for FCHVs
- 3.5.7.4.1. Vehicle high: kg/100 km
- 3.5.7.4.2. Vehicle low (if applicable): kg/100 km

▼ M3

▼B

- 3.5.7.5. Electric energy consumption for electrified vehicles
 - 3.5.7.5.1. Combined electric energy consumption (EC_{WLTC}) for Pure electric vehicles
 - 3.5.7.5.1.1. Vehicle high: Wh/km
 - 3.5.7.5.1.2. Vehicle low (if applicable): Wh/km
 - 3.5.7.5.2. UF-weighted charge-depleting electric consumption EC_{AC,CD} (combined)
 - 3.5.7.5.2.1. Vehicle high: Wh/km
 - 3.5.7.5.2.2. Vehicle low (if applicable): Wh/km
 - 3.5.7.5.2.3. Vehicle M (if applicable): Wh/km
- 3.5.8. Vehicle fitted with an eco-innovation within the meaning of Article 12 of Regulation (EC) No 443/2009 for M1 vehicles or Article 12 of Regulation (EU) No 510/2011 for N1 vehicles: yes/no ⁽¹⁾
 - 3.5.8.1. Type/Variant/Version of the baseline vehicle as referred to in Article 5 of Regulation (EU) No 725/2011 for M1 vehicles or Article 5 of Regulation (EU) No 427/2014 for N1 vehicles (if applicable):
 - 3.5.8.2. Existence of interactions between different eco-innovations: yes/no ⁽¹⁾

▼M3

- 3.5.8.3. Emissions data related to the use of eco-innovations (repeat the table for each reference fuel tested) (w¹)

Decision approving the eco-innovation (w ²)	Code of the eco-innovation (w ³)	1. CO ₂ emissions of the baseline vehicle (g/km)	2. CO ₂ emissions of the eco-innovation vehicle (g/km)	3. CO ₂ emissions of the baseline vehicle under type 1 test-cycle (w ⁴)	4. CO ₂ emissions of the eco-innovation vehicle under type 1 test-cycle	5. Usage factor (UF), i.e. temporal share of technology usage in normal operation conditions	CO ₂ emissions savings ((1 - 2) - (3 - 4))*5
xxxx/201x							

Total NEDC CO₂ emissions saving (g/km)(w⁵)
 Total WLTP CO₂ emissions saving (g/km)(w⁵)

▼B

- 3.6. Temperatures permitted by the manufacturer
 - 3.6.1. Cooling system

▼ B

- 3.6.1.1. Liquid cooling
Maximum temperature at outlet: K
- 3.6.1.2. Air cooling
 - 3.6.1.2.1. Reference point:
 - 3.6.1.2.2. Maximum temperature at reference point: K
- 3.6.2. Maximum outlet temperature of the inlet intercooler: K
- 3.6.3. Maximum exhaust temperature at the point in the exhaust pipe(s) adjacent to the outer flange(s) of the exhaust manifold or turbocharger: K
- 3.6.4. Fuel temperature
Minimum: K — maximum: K
For diesel engines at injection pump inlet, for gas fuelled engines at pressure regulator final stage
- 3.6.5. Lubricant temperature
Minimum: K — maximum: K
- 3.8. Lubrication system
 - 3.8.1. Description of the system
 - 3.8.1.1. Position of lubricant reservoir:
 - 3.8.1.2. Feed system (by pump/injection into intake/mixing with fuel, etc.) ⁽¹⁾
 - 3.8.2. Lubricating pump
 - 3.8.2.1. Make(s):
 - 3.8.2.2. Type(s):
 - 3.8.3. Mixture with fuel
 - 3.8.3.1. Percentage:
 - 3.8.4. Oil cooler: yes/no ⁽¹⁾
 - 3.8.4.1. Drawing(s): or
 - 3.8.4.1.1. Make(s):
 - 3.8.4.1.2. Type(s):

▼ M3

- 3.8.5. Lubricant specification:W.....

▼ B

- 4 TRANSMISSION ^(P)
 - 4.3. Moment of inertia of engine flywheel:
 - 4.3.1. Additional moment of inertia with no gear engaged:
 - 4.4. Clutch(es)
 - 4.4.1. Type:
 - 4.4.2. Maximum torque conversion:
 - 4.5. Gearbox
 - 4.5.1. Type (manual/automatic/CVT (continuously variable transmission)) ⁽¹⁾

▼ M3

▼ B

4.5.1.4. Torque rating:

4.5.1.5. Number of clutches:

4.6. Gear ratios

Gear	Internal gearbox ratios (ratios of engine to gearbox output shaft revolutions)	Final drive ratio(s) (ratio of gearbox output shaft to driven wheel revolutions)	Total gear ratios
Maximum for CVT			
1			
2			
3			
...			
Minimum for CVT			
► M3 ←			

▼ M3

4.6.1. Gearshift

4.6.1.1. Gear 1 excluded: yes/no ⁽¹⁾4.6.1.2. n_{95_high} for each gear: min^{-1} 4.6.1.3. $n_{\text{min_drive}}$ 4.6.1.3.1. 1st gear: min^{-1} 4.6.1.3.2. 1st gear to 2nd: min^{-1} 4.6.1.3.3. 2nd gear to standstill: min^{-1} 4.6.1.3.4. 2nd gear: min^{-1} 4.6.1.3.5. 3rd gear and beyond: min^{-1} 4.6.1.4. $n_{\text{min_drive_set}}$ for acceleration/constant speed phases
($n_{\text{min_drive_up}}$): min^{-1} 4.6.1.5. $n_{\text{min_drive_set}}$ for deceleration phases ($n_{\text{min_drive_down}}$):

4.6.1.6. initial period of time

4.6.1.6.1. $t_{\text{start_phase}}$: s4.6.1.6.2. $n_{\text{min_drive_start}}$: min^{-1} 4.6.1.6.3. $n_{\text{min_drive_up_start}}$: min^{-1} 4.6.1.7. use of ASM: yes/no ⁽¹⁾

4.6.1.7.1. ASM values:

▼ B4.7. Maximum vehicle design speed (in km/h) ⁽⁹⁾:

▼ M3

4.12. Gearbox lubricant:W.....

▼ B

6 SUSPENSION

6.6. Tyres and wheels

6.6.1. Tyre/wheel combination(s)

6.6.1.1. Axles

6.6.1.1.1. Axle 1:

6.6.1.1.1.1. Tyre size designation

6.6.1.1.2. Axle 2:

6.6.1.1.2.1. Tyre size designation

etc.

6.6.2. Upper and lower limits of rolling radii

6.6.2.1. Axle 1:

6.6.2.2. Axle 2:

6.6.3. Tyre pressure(s) as recommended by the vehicle manufacturer: kPa

9 BODYWORK

9.1. Type of bodywork using the codes defined in Part C of Annex II of Directive 2007/46/EC:

▼ M312.8. Devices or systems with driver selectable modes which influence CO₂ emissions and/or criteria emissions and do not have a predominant mode: yes/no ⁽¹⁾

12.8.1. Charge sustaining test (if applicable) (state for each device or system)

12.8.1.1. Best case mode:

12.8.1.2. Worst case mode:

12.8.2. Charge depleting test (if applicable) (state for each device or system)

12.8.2.1. Best case mode:

12.8.2.2. Worst case mode:

12.8.3. Type 1 test (if applicable) (state for each device or system)

12.8.3.1. Best case mode:

12.8.3.2. Worst case mode:

▼ B

16	ACCESS TO VEHICLE REPAIR AND MAINTENANCE INFORMATION
16.1.	Address of principal website for access to vehicle repair and maintenance information:
16.1.1.	Date from which it is available (no later than 6 months from the date of type-approval):
16.2.	Terms and conditions of access to website:
16.3.	Format of the vehicle repair and maintenance information accessible through website:

▼ M2*Explanatory notes*

- ⁽¹⁾ Delete where not applicable (there are cases where nothing needs to be deleted when more than one entry is applicable).
- ⁽²⁾ Specify the tolerance.
- ⁽³⁾ Please fill in here the upper and lower values for each variant.
- ⁽⁶⁾ Vehicles can be fuelled with both petrol and a gaseous fuel but, where the petrol system is fitted for emergency purposes or starting only and of which the petrol tank cannot contain more than 15 litres of petrol, will be regarded for the test as vehicles which can only run a gaseous fuel.
- ⁽⁷⁾ Optional equipment that affects the dimensions of the vehicle shall be specified.
- ^(c) Classified according to the definitions set out in Part A of Annex II.
- ^(f) Where there is one version with a normal cab and another with a sleeper cab, both sets of masses and dimensions are to be stated.
- ^(g) Standard ISO 612: 1978 — Road vehicles — Dimensions of motor vehicles and towed vehicles — terms and definitions.
- ^(h) The mass of the driver is assessed at 75 kg.
The liquid containing systems (except those for used water that must remain empty) are filled to 100 % of the capacity specified by the manufacturer.
The information referred to in points 2.6(b) and 2.6.1(b) do not need to be provided for vehicle categories N 2, N 3, M 2, M 3, O 3, and O 4.
- ⁽ⁱ⁾ For trailers or semi-trailers, and for vehicles coupled with a trailer or a semi-trailer, which exert a significant vertical load on the coupling device or the fifth wheel, this load, divided by standard acceleration of gravity, is included in the maximum technically permissible mass.
- ^(k) In the case of a vehicle that can run either on petrol, diesel, etc., or also in combination with another fuel, items shall be repeated.
In the case of non-conventional engines and systems, particulars equivalent to those referred to here shall be supplied by the manufacturer.
- ^(l) This figure shall be rounded off to the nearest tenth of a millimetre.
- ^(m) This value shall be calculated ($\pi = 3,1416$) and rounded off to the nearest cm³.
- ⁽ⁿ⁾ Determined in accordance with the requirements of Regulation (EC) No 715/2007 or Regulation (EC) No 595/2009 as applicable.
- ^(o) Determined in accordance with the requirements of Council Directive 80/1268/EEC (OJ L 375, 31.12.1980, p. 36).
- ^(p) The specified particulars are to be given for any proposed variants.
- ^(q) With respect to trailers, maximum speed permitted by the manufacturer.
- ^(w) Eco-innovations.
- ^(w¹) Expand the table if necessary, using one extra row per eco-innovation.
- ^(w²) Number of the Commission Decision approving the eco-innovation.
- ^(w³) Assigned in the Commission Decision approving the eco-innovation.
- ^(w⁴) Under agreement of the type-approval authority, if a modelling methodology is applied instead of the type 1 test cycle, this value shall be the one provided by the modelling methodology.
- ^(w⁵) Sum of the CO₂ emissions savings of each individual eco-innovation.

▼ M1*Appendix 3a***Extended Documentation Package**

The extended documentation package shall include the following information on all AES:

- (a) a declaration of the manufacturer that the vehicle does not contain any defeat device not covered by one of the exceptions in Article 5(2) of Regulation (EC) No 715/2007;
- (b) a description of the engine and the emission control strategies and devices employed, whether software or hardware, and any condition(s) under which the strategies and devices will not operate as they do during testing for TA;
- (c) a declaration of the software versions used to control these AES/BES, including the appropriate checksums of these software versions and instructions to the authority on how to read the checksums; the declaration shall be updated and sent to the Type Approval Authority that holds this extended documentation package each time there is a new software version that has an impact to the AES/BES;

▼ M3

- (d) detailed technical reasoning of any AES including a risk assessment estimating the risk with the AES and without it, and information on the following:
 - (i) why any of the exception clauses from the defeat device prohibition in Article 5(2) of Regulation (EC) No 715/2007 apply;
 - (ii) hardware element(s) that need to be protected by the AES, where applicable;
 - (iii) proof of sudden and irreparable engine damage that cannot be prevented by regular maintenance and would occur in the absence of the AES, where applicable;
 - (iv) a reasoned explanation on why there is a need to use an AES upon engine start, where applicable;

▼ M1

- (e) a description of the fuel system control logic, timing strategies and switch points during all modes of operation;
- (f) a description of the hierarchical relations among the AES (i.e., when more than one AES can be active concurrently, an indication of which AES is primary in responding, the method by which strategies interact, including data flow diagrams and decision logic and how does the hierarchy assure emissions from all AES are controlled to the lowest practical level;
- (g) a list of parameters which are measured and/or calculated by the AES, along with the purpose of every parameter measured and/or calculated and how each of those parameters relates to engine damage; including the method of calculation and how well these calculated parameters correlate with the true state of the parameter being controlled and any resulting tolerance or factor of safety incorporated into the analysis;
- (h) a list of engine/emission control parameters which are modulated as a function of the measured or calculated parameter(s) and the range of modulation for each engine/emission control parameter; along with the relationship between engine/emission control parameters and measured or calculated parameters;
- (i) an evaluation of how the AES will control real-driving emissions to the lowest practical level, including a detailed analysis of the expected increase of total regulated pollutants and CO₂ emissions by using the AES, compared to the BES.

▼ **M3**

The extended documentation package shall be limited to 100 pages and shall include all the main elements to allow the type approval authority to assess the AES. The package may be complemented with annexes and other attached documents, containing additional and complementary elements, if necessary. The manufacturer shall send a new version of the extended documentation package to the type approval authority every time changes are introduced to the AES. The new version shall be limited to the changes and their effect. The new version of the AES shall be evaluated and approved by the type approval authority.

The extended documentation package shall be structured as follows:

Extended Documentation Package for AES Application No. YYY/OEM in accordance with Regulation (EU) 2017/1151

Parts	Paragraph	Point	Explanation
Introduction documents		Introduction letter to TAA	Reference of the document with the version, the date of issuing the document, signature by the relevant person in the manufacturer organisation
		Versioning table	Content of each version modifications: and with part is modified
		Description of the (emission) types concerned	
		Attached documents table	List of all attached documents
		Cross references	link to paragraph (a) to (i) of Appendix 3a (where to find each requirement of the regulation)
		Absence of defeat device declaration	+ signature
Core document	0	Acronyms/abbreviations	
	1	GENERAL DESCRIPTION	
	1.1	Engine general presentation	Description of main characteristics: displacement, after treatment,...
	1.2	General system architecture	System bloc diagram: list of sensors and actuators, explanation of engine general functions
	1.3	Reading of software and calibration version	E.g. scan-tool explanation
	2	Base Emission Strategies	
	2.x	BES x	Description of strategy x
	2.y	BES y	Description of strategy y
	3	Auxiliary Emission Strategies	

▼ M3

Parts	Paragraph	Point	Explanation
	3.0	Presentation of the AESs	Hierarchical relations among AES: description and justification (e.g. safety, reliability, etc.)
	3.x	AES x	3.x.1 AES justification 3.x.2 measured and/or modelled parameters for AES characterization 3.x.3 Action mode of AES - Parameters used 3.x.4 Effect of AES on pollutants and CO ₂
	3.y	AES y	3.y.1 3.y.2 etc.
100 page limit ends here			
	Annex		List of types covered by this BES-AES: including TA reference, software reference, calibration number, checksums of each version and of each CU (engine and/or after-treatment if any)
Attached documents		Technical note for AES justification n° xxx	Risk assessment or justification by testing or example of sudden damage, if any
		Technical note for AES justification n° yyy	
		Test report for specific AES impact quantification	test report of all specific tests done for AES justification, test conditions details, description of the vehicle / date of the tests emission/ CO ₂ impact with/without AES activation

▼ **M3***Appendix 3b***Methodology for the assessment of AES**

The assessment of the AES by the type-approval authority shall include at least the following verifications:

- (1) The increase of emissions induced by the AES shall be kept at the lowest possible level:
 - (a) The increase of total emissions when using an AES shall be kept at the lowest possible level throughout the normal use and life of the vehicles;
 - (b) Whenever a technology or design that would allow for improved emission control is available on the market at the time of the AES preliminary assessment it shall be used with no unjustified modulation
- (2) When used to justify an AES, the risk of sudden and irreparable damage to the 'propulsion energy converter and the drivetrain', as defined in Mutual Resolution No. 2 (M.R.2) of the 1958 and 1998 Agreements of UNECE containing Vehicle Propulsion System Definitions ⁽¹⁾, shall be appropriately demonstrated and documented, including the following information:
 - (a) Proof of catastrophic (i.e. sudden and irreparable) engine damage shall be provided by the manufacturer, along with a risk assessment which includes an evaluation of the likelihood of the risk occurring and severity of the possible consequences, including results of tests carried out to this effect;
 - (b) When a technology or design is available on the market at the time of the AES application that eliminates or reduces that risk, it shall be used to the largest extent technically possible (i.e. with no unjustified modulation);
 - (c) Durability and the long-term protection of the engine or components of the emission control system from wear and malfunctioning shall not be considered an acceptable reason to grant an exemption from the defeat device prohibition.
- (3) An adequate technical description shall document why it is necessary to use an AES for the safe operation of the vehicle:
 - (a) Proof of an increased risk to the safe operation of the vehicle should be provided by the manufacturer along with a risk assessment which includes an evaluation of the likelihood of the risk occurring and severity of the possible consequences, including results of tests carried out to this effect;
 - (b) When a different technology or design is available on the market at the time of the AES application that would allow for lowering the safety risk, it shall be used to the largest extent technically possible (i.e. with no unjustified modulation).
- (4) An adequate technical description shall document why it is necessary to use an AES during engine start:
 - (a) Proof of the need to use an AES during engine start shall be provided by the manufacturer along with a risk assessment which includes an evaluation of the likelihood of the risk occurring and severity of the possible consequences, including results of tests carried out to this effect;

⁽¹⁾ Document ECE/TRANS/WP.19/1121 found in the following webpage: <https://ec.europa.eu/docsroom/documents/31821>

▼ **M3**

- (b) Where a different technology or design is available on the market at the time of the AES application that would allow for improved emission control upon engine start, it shall be used to the largest extent technically possible.
-

▼B*Appendix 4***MODEL OF EC TYPE-APPROVAL CERTIFICATE**

(Maximum format: A4 (210 × 297 mm))

EC TYPE-APPROVAL CERTIFICATE*Stamp of administration*

Communication concerning the:

- EC type-approval ⁽¹⁾,
- extension of EC type-approval ⁽¹⁾,
- refusal of EC type-approval ⁽¹⁾,
- withdrawal of EC type-approval ⁽¹⁾,
- of a type of system/type of a vehicle with regard to a system ⁽¹⁾ with regard to Regulation (EC) No 715/2007 ⁽²⁾ and Regulation (EU) 2017/1151 ⁽³⁾

EC type-approval number: ...

Reason for extension: ...

SECTION I

- 0.1. Make (trade name of manufacturer): ...
- 0.2. Type: ...
 - 0.2.1. Commercial name(s) (if available): ...
- 0.3. Means of identification of type if marked on the vehicle ⁽⁴⁾
 - 0.3.1. Location of that marking: ...
- 0.4. Category of vehicle ⁽⁵⁾

▼M3

- 0.4.2. Base vehicle ^(5a) ⁽¹⁾: yes/no ⁽¹⁾

▼B

- 0.5. Name and address of manufacturer: ...
- 0.8. Name(s) and address(es) of assembly plant(s): ...
- 0.9. Representative of the manufacturer: ...

SECTION II — to be repeated for each interpolation family, as defined in paragraph 5.6. of Annex XXI

- 0. Interpolation family identifier as defined in paragraph 5.0 of Annex XXI
 - 1. Additional information (where applicable): (see addendum)
 - 2. Technical service responsible for carrying out the tests: ...
 - 3. Date of type 1 test report: ...
 - 4. Number of the type 1 test report: ...
 - 5. Remarks (if any): (see addendum)

▼B

6. Place: ...
7. Date: ...
8. Signature: ...

<i>Attachments:</i>	Information package ⁽⁶⁾ .
---------------------	--------------------------------------

▼ B

Addendum to EC type-approval certificate No ...

concerning the type-approval of a vehicle with regard to emissions and access to vehicle repair and maintenance information according to Regulation (EC) No 715/2007

Cross references to information in Test Report or Information Document should be avoided when completing the TA certificate.

▼ M3

0. INTERPOLATION FAMILY IDENTIFIER AS DEFINED IN PARAGRAPH 5.0 OF ANNEX XXI OF REGULATION (EU) 2017/1151

0.1. Identifier: ...

0.2. Base vehicle identifier ^(5a) (1): ...

▼ B

1. ADDITIONAL INFORMATION

▼ M3

1.1. Mass of the vehicle in running order:

VL (1): ...

VH: ...

1.2. Maximum mass:

VL (1): ...

VH: ...

1.3. Reference mass:

VL (1): ...

VH: ...

▼ B

1.4. Number of seats: ...

1.6. Type of bodywork:

1.6.1. for M1, M2: saloon, hatchback, station wagon, coupé, convertible, multipurpose vehicle (1)

1.6.2. for N1, N2: lorry, van (1)

1.7. Drive wheels: front, rear, 4 × 4 (1)

1.8. Pure electric vehicle: yes/no (1)

1.9. Hybrid electric vehicle: yes/no (1)

1.9.1. Category of Hybrid Electric vehicle: Off Vehicle Charging/Not Off Vehicle charging / Fuel Cell (1)

1.9.2. Operating mode switch: with/without (1)

1.10. Engine identification:

1.10.1. Engine displacement:

1.10.2. Fuel supply system: direct injection/indirect injection (1)

▼ B

- 1.10.3. Fuel recommended by the manufacturer:
- 1.10.4.1. Maximum power: kW at min^{-1}
- 1.10.4.2. Maximum torque: Nm at min^{-1}
- 1.10.5. Pressure charging device: yes/no ⁽¹⁾
- 1.10.6. Ignition system: compression ignition/positive ignition ⁽¹⁾
- 1.11. Power train (for pure electric vehicle or hybrid electric vehicle) ⁽¹⁾
- 1.11.1. Maximum net power: ... kW, at: ... to ... min^{-1}
- 1.11.2. Maximum thirty minutes power: ... kW
- 1.11.3. Maximum net torque: ... Nm, at ... min^{-1}
- 1.12. Traction battery (for pure electric vehicle or hybrid electric vehicle)
- 1.12.1. Nominal voltage: V
- 1.12.2. Capacity (2 h rate): Ah
- 1.13. Transmission: ..., ...
- 1.13.1. Type of gearbox: manual/automatic/variable transmission ⁽¹⁾
- 1.13.2. Number of gear ratios:
- 1.13.3. Total gear ratios (including the rolling circumferences of the tyres under load): (vehicle speed (km/h)) / (engine speed (1 000 (min^{-1})))

First gear: ...	Sixth gear: ...
Second gear: ...	Seventh gear: ...
Third gear: ...	Eighth gear: ...
Fourth gear: ...	Overdrive: ...
Fifth gear: ...	

- 1.13.4. Final drive ratio:
- 1.14. Tyres: ..., ..., ...
- Type: radial/bias/... ⁽⁷⁾
- Dimensions: ...
- Rolling circumference under load:
- Rolling circumference of tyres used for the Type 1 test

2. TEST RESULTS

▼ M3

- 2.1. Tailpipe emissions test results
- Emissions classification: ...
- Type 1 test results, where applicable

▼ **M3**Type approval number if not parent vehicle ⁽¹⁾: ...**Test 1**

Type 1 Result	CO (mg/km)	THC (mg/km)	NMHC (mg/km)	NO _x (mg/km)	THC + NO _x (mg/km)	PM (mg/km)	PN (#.10 ¹¹ / km)
Measured ⁽⁸⁾ ⁽⁹⁾							
Ki × ⁽⁸⁾ ⁽¹⁰⁾					⁽¹¹⁾		
Ki + ⁽⁸⁾ ⁽¹⁰⁾					⁽¹¹⁾		
Mean value calculated with Ki (M × Ki or M + Ki) ⁽⁹⁾					⁽¹²⁾		
DF (+) ⁽⁸⁾ ⁽¹⁰⁾							
DF (×) ⁽⁸⁾ ⁽¹⁰⁾							
Final mean value calculated with Ki and DF ⁽¹³⁾							
Limit value							

Test 2 (if applicable)

Repeat Test 1 table with the second test results.

Test 3 (if applicable)

Repeat Test 1 table with the third test results.

Repeat Test 1, test 2 (if applicable) and test 3 (if applicable) for
Vehicle Low (if applicable), and VM (if applicable)**ATCT test**

CO ₂ Emission (g/km)	Combined
ATCT (14 °C) M _{CO2,Treg}	
Type 1 (23 °C) M _{CO2,23°}	
Family correction factor (FCF)	

ATCT test Result	CO (mg/km)	THC (mg/km)	NMHC (mg/km)	NO _x (mg/km)	THC + NO _x (mg/km)	PM (mg/km)	PN (#.10 ¹¹ /km)
Measured ⁽¹⁾ ⁽²⁾							
Limit values							

⁽¹⁾ Where applicable.⁽²⁾ Round to two decimal numbers.

▼ M3

Difference between engine coolant end temperature and average soak area temperature of the last 3 hours ΔT_{ATCT} (°C) for the reference vehicle: ...

The minimum soaking time t_{soak_ATCT} (s): ...

Location of temperature sensor: ...

ATCT family identifier: ...

Type 2: (including data required for roadworthiness testing):

Test	CO value (% vol)	Lambda ⁽¹⁾	Engine speed (min ⁻¹)	Engine oil temperature (°C)
Low idle test		N/A		
High idle test				

Type 3: ...

Type 4: ... g/test;

Test procedure in accordance with: Annex 6 to UN/ECE Regulation No 83 [1 day NEDC] / the Annex to Regulation (EC) 2017/1221 [2 days NEDC] / Annex VI to Regulation (EU) 2017/1151 [2 days WLTP] ⁽¹⁾.

Type 5:

— Durability test: whole vehicle test/bench ageing test/none ⁽¹⁾

— Deterioration factor DF: calculated/assigned ⁽¹⁾

— Specify the values: ...

— Applicable Type 1 cycle (Sub-Annex 4 to Annex XXI of Regulation (EU) 2017/1151 or UN/ECE Regulation No 83) ⁽¹⁴⁾: ...

Type 6	CO (g/km)	THC (g/km)
Measured value		
Limit value		

▼ B

2.1.1.

For bi fuel vehicles, the type 1 table shall be repeated for both fuels. For flex fuel vehicles, when the type 1 test is to be performed on both fuels according to Figure I.2.4 of Annex I,

▼ B

and for vehicles running on LPG or NG/Biomethane, either mono fuel or bi fuel, the table shall be repeated for the different reference gases used in the test, and an additional table shall display the worst results obtained. When applicable, in accordance with section 3.1.4 of Annex 12 to UN/ECE Regulation No 83, it shall be shown if the results are measured or calculated.

- 2.1.2. Written description and/or drawing of the MI: ...
- 2.1.3. List and function of all components monitored by the OBD system: ...
- 2.1.4. Written description (general working principles) for: ...
 - 2.1.4.1. Misfire detection ⁽¹⁵⁾: ...
 - 2.1.4.2. Catalyst monitoring ⁽¹⁵⁾: ...
 - 2.1.4.3. Oxygen sensor monitoring ⁽¹⁵⁾: ...
 - 2.1.4.4. Other components monitored by the OBD system ⁽¹⁵⁾: ...
 - 2.1.4.5. Catalyst monitoring ⁽¹⁶⁾: ...
 - 2.1.4.6. Particulate trap monitoring ⁽¹⁶⁾: ...
 - 2.1.4.7. Electronic fuelling system actuator monitoring ⁽¹⁶⁾: ...
 - 2.1.4.8. Other components monitored by the OBD system: ...
- 2.1.5. Criteria for MI activation (fixed number of driving cycles or statistical method): ...
- 2.1.6. List of all OBD output codes and formats used (with explanation of each): ...
- 2.2. Reserved
- 2.3. Catalytic converters yes/no ⁽¹⁾
 - 2.3.1. Original equipment catalytic converter tested to all relevant requirements of this Regulation yes/no ⁽¹⁾
- 2.4. Smoke opacity test results ⁽¹⁾
 - 2.4.1. At steady engine speeds: See technical service test report number: ...
 - 2.4.2. Free acceleration tests

▼ B

- 2.4.2.1. Measured value of the absorption coefficient: ... m⁻¹
- 2.4.2.2. Corrected value of the absorption coefficient: ... m⁻¹
- 2.4.2.3. Location of the absorption coefficient symbol on the vehicle: ...
- 2.5. CO₂ emissions and fuel consumption test results

▼ M3

- 2.5.1. Pure ICE vehicle and Not Externally Chargeable (NOVC) Hybrid Electric Vehicle
- 2.5.1.0. Minimum and maximum CO₂ values within the interpolation family

▼ B

- 2.5.1.1. Vehicle High
- 2.5.1.1.1. Cycle Energy Demand: ... J
- 2.5.1.1.2. Road load coefficients
- 2.5.1.1.2.1. f_0 , N: ...
- 2.5.1.1.2.2. f_1 , N/(km/h): ...
- 2.5.1.1.2.3. f_2 , N/(km/h)²: ...

▼ M3

- 2.5.1.1.3. CO₂ mass emissions (provide values for each reference fuel tested, for the phases: the measured values, for the combined see points 1.2.3.8. and 1.2.3.9. of Sub-Annex 6 to Annex XXI of Regulation (EU) 2017/1151)

CO ₂ Emission (g/km)	Test	Low	Medium	High	Extra High	Combined
$M_{CO_2,p,5} / M_{CO_2,c,5}$	1					
	2					
	3					
	average					
Final $M_{CO_2,p,H} / M_{CO_2,c,H}$						

- 2.5.1.1.4. Fuel consumption (provide values for each reference fuel tested, for the phases: the measured values for the combined see paragraphs 1.2.3.8 and 1.2.3.9 of Sub-Annex 6 to Annex XXI)

Fuel consumption (l/100 km) or m ³ /100 km or kg/100 km (l)	Low	Medium	High	Extra High	Combined
Final values $FC_{p,H}/FC_{c,H}$					

- 2.5.1.2. Vehicle Low (if applicable)
- 2.5.1.2.1. Cycle Energy Demand: ... J
- 2.5.1.2.2. Road load coefficients

▼ **M3**2.5.1.2.2.1. f_0 , N: ...2.5.1.2.2.2. f_1 , N/(km/h): ...2.5.1.2.2.3. f_2 , N/(km/h) (2): ...2.5.1.2.3. CO₂ mass emissions (provide values for each reference fuel tested, for the phases: the measured values for the combined see points 1.2.3.8. and 1.2.3.9. of Sub-Annex 6 to Annex XXI)

CO ₂ Emission (g/km)	Test	Low	Medium	High	Extra High	Combined
$M_{CO_2,p,5}/M_{CO_2,e,5}$	1					
	2					
	3					
	average					
Final $M_{CO_2,p,L}/M_{CO_2,e,L}$						

2.5.1.2.4. Fuel consumption (provide values for each reference fuel tested, for the phases: the measured values for the combined see points 1.2.3.8 and 1.2.3.9 of Sub-Annex 6 to Annex XXI)

Fuel consumption (l/100 km) or m ³ /100 km or kg/100 km (¹)	Low	Medium	High	Extra High	Combined
Final values $FC_{p,L}/FC_{c,L}$					

2.5.1.3. Vehicle M for NOVC-HEV (if applicable)

2.5.1.3.1. Cycle Energy Demand: ... J

2.5.1.3.2. Road load coefficients

2.5.1.3.2.1. f_0 , N: ...2.5.1.3.2.2. f_1 , N/(km/h): ...2.5.1.3.2.3. f_2 , N/(km/h) (2): ...2.5.1.3.3. CO₂ mass emissions (provide values for each reference fuel tested, for the phases: the measured values for the combined see paragraphs 1.2.3.8. and 1.2.3.9. of Sub-Annex 6 to Annex XXI)

CO ₂ Emission (g/km)	Test	Low	Medium	High	Extra High	Combined
$M_{CO_2,p,5}/M_{CO_2,e,5}$	1					
	2					
	3					
	average					
Final $M_{CO_2,p,L}/M_{CO_2,e,L}$						

▼ M3

- 2.5.1.3.4. Fuel consumption (provide values for each reference fuel tested, for the phases: the measured values for the combined see paragraphs 1.2.3.8. and 1.2.3.9. of Sub-Annex 6 to Annex XXI)

Fuel consumption (l/100 km) or m ³ /100 km or kg/100 km ⁽¹⁾	Low	Medium	High	Extra High	Combined
Final values FC _{p,L} / FC _{c,L}					

- 2.5.1.4. For vehicles powered by an internal combustion engine which are equipped with periodically regenerating systems as defined in point 6 of Article 2 of this Regulation, the test results shall be adjusted by the Ki factor as specified in Appendix 1 to Sub-Annex 6 of Annex XXI.

- 2.5.1.4.1. Information about regeneration strategy for CO₂ emissions and fuel consumption

D — number of operating cycles between 2 cycles where regenerative phases occur: ...

d — number of operating cycles required for regeneration: ...

Applicable Type 1 cycle (Sub-Annex 4 to Annex XXI of Regulation (EU) 2017/1151, or UN/ECE Regulation 83) ⁽¹⁴⁾: ...

	Combined
Ki (additive / multiplicative) ⁽¹⁾	
Values for CO ₂ and fuel consumption ⁽¹⁰⁾	

Repeat 2.5.1. in case of base vehicle.

▼ B

- 2.5.2. Pure electric vehicles ⁽¹⁾

▼ M3

- 2.5.2.1. Electric energy consumption

- 2.5.2.1.1. Vehicle High

- 2.5.2.1.1.1. Cycle Energy Demand: ... J

- 2.5.2.1.1.2. Road load coefficients

- 2.5.2.1.1.2.1. f₀, N: ...

- 2.5.2.1.1.2.2. f₁, N/(km/h): ...

- 2.5.2.1.1.2.3. f₂, N/(km/h) ⁽²⁾: ...

EC (Wh/km)	Test	City	Combined
Calculated EC	1		
	2		
	3		
	average		
Declared value		—	

- 2.5.2.1.1.3. Total time out of tolerance for the conduct of the cycle: ... sec

▼ M3

2.5.2.1.2. Vehicle Low (if applicable)

2.5.2.1.2.1. Cycle Energy Demand: ... J

2.5.2.1.2.2. Road load coefficients

2.5.2.1.2.2.1. f_0 , N: ...2.5.2.1.2.2.2. f_1 , N/(km/h): ...2.5.2.1.2.2.3. f_2 , N/(km/h) (2): ...

EC (Wh/km)	Test	City	Combined
Calculated EC	1		
	2		
	3		
	average		
Declared value		—	

2.5.2.1.2.3. Total time out of tolerance for the conduct of the cycle: ... sec

2.5.2.2. Pure Electric Range

2.5.2.2.1. Vehicle High

PER (km)	Test	City	Combined
Measured Pure Electric Range	1		
	2		
	3		
	average		
Declared value		—	

2.5.2.2.2. Vehicle Low (if applicable)

PER (km)	Test	City	Combined
Measured Pure Electric Range	1		
	2		
	3		
	average		
Declared value		—	

▼ B

2.5.3. Externally chargeable (OVC) Hybrid Electric Vehicle:

▼ **M3**2.5.3.1. CO₂ mass emission charge sustaining

2.5.3.1.1. Vehicle High

2.5.3.1.1.1. Cycle Energy Demand: ... J

2.5.3.1.1.2. Road load coefficients

2.5.3.1.1.2.1. f_0 , N: ...2.5.3.1.1.2.2. f_1 , N/(km/h): ...2.5.3.1.1.2.3. f_2 , N/(km/h) (²): ...

CO ₂ Emission (g/km)	Test	Low	Medium	High	Extra High	Combined
$M_{CO_2,p,5}/M_{CO_2,c,5}$	1					
	2					
	3					
	Average					
Final $M_{CO_2,p,H}/M_{CO_2,c,H}$						

2.5.3.1.2. Vehicle Low (if applicable)

2.5.3.1.2.1. Cycle Energy Demand: ... J

2.5.3.1.2.2. Road load coefficients

2.5.3.1.2.2.1. f_0 , N: ...2.5.3.1.2.2.2. f_1 , N/(km/h): ...2.5.3.1.2.2.3. f_2 , N/(km/h) (²): ...

CO ₂ Emission (g/km)	Test	Low	Medium	High	Extra High	Combined
$M_{CO_2,p,5}/M_{CO_2,c,5}$	1					
	2					
	3					
	Average					
Final $M_{CO_2,p,L}/M_{CO_2,c,L}$						

2.5.3.1.3. Vehicle M (if applicable)

2.5.3.1.3.1. Cycle Energy Demand: ... J

2.5.3.1.3.2. Road load coefficients

2.5.3.1.3.2.1. f_0 , N: ...2.5.3.1.3.2.2. f_1 , N/(km/h): ...

▼ **M3**2.5.3.1.3.2.3. f_2 , N/(km/h) ⁽²⁾: ...

CO ₂ Emission (g/km)	Test	Low	Medium	High	Extra High	Combined
$M_{CO_2,p,5}/M_{CO_2,e,5}$	1					
	2					
	3					
	Average					
$M_{CO_2,p,M}/M_{CO_2,e,M}$						

2.5.3.2. CO₂ mass emission charge depleting

Vehicle High

CO ₂ Emission (g/km)	Test	Combined
$M_{CO_2,CD}$	1	
	2	
	3	
	Average	
Final $M_{CO_2,CD,H}$		

Vehicle Low (if applicable)

CO ₂ Emission (g/km)	Test	Combined
$M_{CO_2,CD}$	1	
	2	
	3	
	Average	
Final $M_{CO_2,CD,L}$		

Vehicle M (if applicable)

CO ₂ Emission (g/km)	Test	Combined
$M_{CO_2,CD}$	1	
	2	
	3	
	Average	
Final $M_{CO_2,CD,M}$		

▼ **B**2.5.3.3. CO₂ mass emission (weighted, combined) ⁽¹⁷⁾:Vehicle High: $M_{CO_2,weighted}$... g/kmVehicle Low (if applicable): $M_{CO_2,weighted}$... g/kmVehicle M (if applicable): $M_{CO_2,weighted}$... g/km

▼ M3

2.5.3.3.1. Minimum and maximum CO₂ values within the interpolation family.

▼ B

2.5.3.4. Fuel consumption Charge Sustaining

Vehicle High

Fuel Consumption (l/100 km)	Low	Medium	High	Extra High	Combined
Final values FC _{p,H} / FC _{c,H}					

Vehicle Low (if applicable)

Fuel Consumption (l/100 km)	Low	Medium	High	Extra High	Combined
Final values FC _{p,L} / FC _{c,L}					

Vehicle M (if applicable)

Fuel Consumption (l/100 km)	Low	Medium	High	Extra High	Combined
Final values FC _{p,M} / FC _{c,M}					

▼ M3

2.5.3.5. Fuel consumption Charge Depleting

Vehicle High

Fuel consumption (l/100km)	Combined
Final values FC _{CD,H}	

Vehicle Low (if applicable)

Fuel consumption (l/100km)	Combined
Final values FC _{CD,L}	

Vehicle M (if applicable)

Fuel consumption (l/100km)	Combined
Final values FC _{CD,M}	

▼ B

2.5.3.6. Fuel consumption (weighted, combined)⁽¹⁷⁾:

Vehicle High: FC_{weighted} ... l/100 km

Vehicle Low (if applicable): FC_{weighted} ... l/100 km

Vehicle M (if applicable): FC_{weighted} ... l/100 km

2.5.3.7. Ranges:

▼ M3

2.5.3.7.1. All Electric Range AER

AER (km)	Test	City	Combined
AER values	1		
	2		
	3		
	Average		
Final values AER			

▼ B

2.5.3.7.2. Equivalent All Electric Range EAER

EAER (km)	City	Combined
EAER values		

2.5.3.7.3. Actual Charge Depleting Range R_{CDA}

R_{CDA} (km)	Combined
R_{CDA} values	

▼ M32.5.3.7.4. Charge Depleting Cycle Range R_{CDC}

R_{CDC} (km)	Test	Combined
R_{CDC} values	1	
	2	
	3	
	Average	
Final values R_{CDC}		

▼ B

2.5.3.8. Electric consumption

2.5.3.8.1. Electric Consumption EC

EC (Wh/km)	Low	Medium	High	Extra High	City	Combined
Electric consumption values						

▼ M32.5.3.8.2. UF-weighted charge-depleting electric consumption $EC_{AC,CD}$ (combined)

$EC_{AC,CD}$ (Wh/km)	Test	Combined
$EC_{AC,CD}$ values	1	
	2	
	3	
	Average	
Final values $EC_{AC,CD}$		

▼ **M3**2.5.3.8.3. UF-weighted electric consumption $EC_{AC, weighted}$ (combined)

$EC_{AC, weighted}$ (Wh/km)	Test	Combined
$EC_{AC, weighted}$ values	1	
	2	
	3	
	Average	
Final values $EC_{AC, weighted}$		

Repeat 2.5.3. in case of base vehicle.

2.5.4. Fuel cell vehicles (FCV)

Fuel Consumption (kg/100 km)	Combined
Final values FC_c	

Repeat 2.5.4. in case of base vehicle.

2.5.5. Device for monitoring the consumption of fuel and/or electric energy: yes/not applicable ...

▼ **B**2.6. Test results of eco-innovations ⁽¹⁸⁾ ⁽¹⁹⁾

Decision approving the eco-innovation ⁽²⁰⁾	Code of the eco-innovation ⁽²¹⁾	Type 1/I cycle ⁽²²⁾	1. CO ₂ emissions of the baseline vehicle (g/km)	2. CO ₂ emissions of the eco-innovation vehicle (g/km)	3. CO ₂ emissions of the baseline vehicle under type 1 test-cycle ⁽²³⁾	4. CO ₂ emissions of the eco-innovation vehicle under type 1 test-cycle	5. Usage factor (UF) i.e. temporal share of technology usage in normal operation conditions	CO ₂ emissions savings ((1 - 2) - (3 - 4)) * 5
xxx/201x								
	Total CO ₂ emissions saving on NEDC (g/km) ⁽²⁴⁾							
	Total CO ₂ emissions saving on WLTP (g/km) ⁽²⁵⁾							

▼B

- 2.6.1. *General code of the eco-innovation(s)* ⁽²⁶⁾: ...
3. VEHICLE REPAIR INFORMATION
- 3.1. Address of website for access to vehicle repair and maintenance information: ...
- 3.1.1. Date from which it is available (up to 6 months from the date of type approval): ...
- 3.2. Terms and conditions of access (i.e. duration of access, price of access on an hourly, daily, monthly, annual and per-transaction basis) to websites referred to in point 3.1): ...
- 3.3. Format of vehicle repair and maintenance information accessible through website referred to in point 3.1): ...
- 3.4. Manufacturer's certificate on access to vehicle repair and maintenance information provided: ...
4. POWER MEASUREMENT
- Maximum engine net power of internal combustion engine, net power and maximum 30 minutes power of electric drive train
- 4.1. **Internal combustion engine net power**
- 4.1.1. Engine speed (min^{-1}) ...
- 4.1.2. Measured fuel flow (g/h) ...
- 4.1.3. Measured torque (Nm) ...
- 4.1.4. Measured power (kW) ...
- 4.1.5. Barometric pressure (kPa) ...
- 4.1.6. Water vapour pressure (kPa) ...
- 4.1.7. Intake air temperature (K) ...
- 4.1.8. Power correction factor when applied ...
- 4.1.9. Corrected power (kW) ...
- 4.1.10. Auxiliary power (kW) ...
- 4.1.11. Net power (kW) ...
- 4.1.12. Net torque (Nm) ...
- 4.1.13. Corrected specific fuel consumption (g/kWh) ...
- 4.2. **Electric drive train(s):**
- 4.2.1. Declared figures
- 4.2.2. Maximum net power: ... kW, at ... min^{-1}
- 4.2.3. Maximum net torque: ... Nm, at ... min^{-1}
- 4.2.4. Maximum net torque at zero engine speed: ... Nm
- 4.2.5. Maximum 30 minutes power: ... kW

▼B

- 4.2.6. Essential characteristics of the electric drive train
- 4.2.7. Test DC voltage: ... V
- 4.2.8. Working principle: ...
- 4.2.9. Cooling system:
- 4.2.10. Motor: liquid/air ⁽¹⁾
- 4.2.11. Variator: liquid/air ⁽¹⁾
- 5. REMARKS: ...

Explanatory Notes

- ⁽¹⁾ Delete where not applicable (there are cases where nothing needs to be deleted when more than one entry is applicable)
- ⁽²⁾ OJ L 171, 29.6.2007, p. 1.
- ⁽³⁾ OJ L 175, 7.7.2017, p. 1.
- ⁽⁴⁾ If the means of identification of type contains characters not relevant to describe the vehicle, component or separate technical unit types covered by this information, such characters shall be represented in the documentation by the symbol '?' (e.g. ABC??123??)
- ⁽⁵⁾ As defined in Annex II, Section A

▼M3

- ^(5a) As defined in article 3, point 18 of Directive 2007/46/EC

▼B

- ⁽⁶⁾ As defined in article 3, paragraph 39 of Directive 2007/46/EC
- ⁽⁷⁾ Type of tyre according UN/ECE Regulation 117
- ⁽⁸⁾ Where applicable.
- ⁽⁹⁾ Round to 2 decimal places
- ⁽¹⁰⁾ Round to 4 decimal places
- ⁽¹¹⁾ Not applicable
- ⁽¹²⁾ Mean value calculated by adding mean values (M.Ki) calculated for THC and NOx.
- ⁽¹³⁾ Round to 1 decimal place more than limit value.
- ⁽¹⁴⁾ Indicate the applicable procedure.
- ⁽¹⁵⁾ For vehicles equipped with positive-ignition engines.
- ⁽¹⁶⁾ For compression-ignition engine vehicles
- ⁽¹⁷⁾ Measured over the combined cycle
- ⁽¹⁸⁾ Repeat the table for each reference fuel tested.
- ⁽¹⁹⁾ Expand the table if necessary, using one extra row per eco-innovation.
- ⁽²⁰⁾ Number of the Commission Decision approving the eco-innovation.
- ⁽²¹⁾ Assigned in the Commission Decision approving the eco-innovation.
- ⁽²²⁾ Applicable Type 1 cycle: Annex XXI, Sub-Annex 4 or UN/ECE Regulation 83
- ⁽²³⁾ If modelling is applied instead of the type 1 test-cycle, this value shall be the one provided by the modelling methodology.
- ⁽²⁴⁾ Sum of the emissions saving of each individual eco-innovation on Type I according to UN/ECE Regulation 83.
- ⁽²⁵⁾ Sum of the emissions saving of each individual eco-innovation on Type 1 according to Annex XXI, Sub-Annex 4 of this regulation
- ⁽²⁶⁾ The general code of the eco-innovation(s) shall consist of the following elements, each separated by a blank space:
 - Code of the type-approval authority as set out in Annex VII to Directive 2007/46/EC;
 - Individual code of each eco-innovation fitted in the vehicle, indicated in chronological order of the Commission approval decisions.

(E.g. the general code of three eco-innovations approved chronologically as 10, 15 and 16 and fitted to a vehicle certified by the German type approval authority should be: 'e1 10 15 16')

▼B*Appendix to the Addendum to the Type Approval Certificate*

Transitional period (correlation output)

(Transitional provision):

▼M3

1. CO₂ emissions determined in accordance with point 3.2. of Annex I to Implementing Regulations (EU) 2017/1152 and (EU) 2017/1153

▼B

- 1.1 Co2mpas version
 1.2. Vehicle High
 1.2.1. CO₂ mass emissions (for each reference fuel tested)

CO ₂ Emission (g/km)	Urban	Extra Urban	Combined
M _{CO2,NEDC_H,co2mpas}			

- 1.3. Vehicle Low (if applicable)
 1.3.1. CO₂ mass emissions (for each reference fuel tested)

CO ₂ Emission (g/km)	Urban	Extra Urban	Combined
M _{CO2,NEDC_L,co2mpas}			

2. CO₂ emissions test results (if applicable)

- 2.1. Vehicle High

▼M3

- 2.1.1. CO₂ mass emissions (for each reference fuel tested) for pure ICE and NOVC-HEV

CO ₂ Emission (g/km)	Urban	Extra Urban	Combined
M _{CO2,NEDC_H,test}			

- 2.1.2. OVC test results

- 2.1.2.1. CO₂ mass emissions for OVC-HEV

CO ₂ Emission (g/km)	Combined
M _{CO2,NEDC_H,test,condition A}	
M _{CO2,NEDC_H,test,condition B}	
M _{CO2,NEDC_H,test,weighted}	

▼B

2.2. Vehicle Low (if applicable)

▼M32.2.1. CO₂ mass emissions (for each reference fuel tested) for pure ICE and NOVC-HEV

CO ₂ Emission (g/km)	Urban	Extra Urban	Combined
M _{CO2,NEDC_L,test}			

2.2.2. OVC test results

2.2.2.1. CO₂ mass emissions for OVC-HEV

CO ₂ Emission (g/km)	Combined
M _{CO2,NEDC_L,test,condition A}	
M _{CO2,NEDC_L,test,condition B}	
M _{CO2,NEDC_L,test,weighted}	

3. Deviation and verification factors (determined in accordance with point 3.2.8 of Implementing Regulation (EU) 2017/1152 and (EU) 2017/1153)

Deviation factor (if applicable)	
Verification factor (if applicable)	'1' or '0'
Hash identifier code of the complete correlation file (point 3.1.1.2 of Annex I to Implementing Regulations (EU) 2017/1152 and (EU) 2017/1153)	

4. Final NEDC CO₂ and fuel consumption values

4.1. Final NEDC values (for each reference fuel tested) for pure ICE and NOVC-HEV

		Urban	Extra Urban	Combined
CO ₂ Emission (g/km)	M _{CO2,NEDC_L, final}			
	M _{CO2,NEDC_H, final}			
Fuel Consumption (l/100km)	FC _{NEDC_L, final}			
	FC _{NEDC_H, final}			

4.2. final NEDC values (for each reference fuel tested) for OVC-HEV

▼ M3

- 4.2.1. CO₂ Emission (g/km): see points 2.1.2.1. and 2.2.2.1.
- 4.2.2. Electric energy consumption (Wh/km): see points 2.1.2.2. and 2.2.2.2.
- 4.2.3. Fuel consumption (l/100 km)

Fuel consumption (l/100 km)	Combined
FC _{NEDC_L,test,condition A}	
FC _{NEDC_L,test,condition B}	
FC _{NEDC_L,test,weighted}	



Appendix 5

Vehicle OBD information

1. The information required in this Appendix shall be provided by the vehicle manufacturer for the purposes of enabling the manufacture of OBD-compatible replacement or service parts and diagnostic tools and test equipment.
2. Upon request, the following information shall be made available to any interested component, diagnostic tools or test equipment manufacturer, on a non-discriminatory basis:
 - 2.1. A description of the type and number of the preconditioning cycles used for the original type-approval of the vehicle;
 - 2.2. A description of the type of the OBD demonstration cycle used for the original type-approval of the vehicle for the component monitored by the OBD system;
 - 2.3. A comprehensive document describing all sensed components with the strategy for fault detection and MI activation (fixed number of driving cycles or statistical method), including a list of relevant secondary sensed parameters for each component monitored by the OBD system and a list of all OBD output codes and format used (with an explanation of each) associated with individual emission-related power-train components and individual non-emission related components, where monitoring of the component is used to determine MI activation. In particular, a comprehensive explanation for the data given in service \$ 05 Test ID \$ 21 to FF and the data given in service \$ 06 shall be provided. In the case of vehicle types that use a communication link in accordance with ISO 15765-4 'Road vehicles — Diagnostics on Controller Area Network (CAN) — Part 4: Requirements for emissions-related systems', a comprehensive explanation for the data given in service \$ 06 Test ID \$ 00 to FF, for each OBD monitor ID supported, shall be provided.

This information may be provided in the form of a table, as follows:

Component	Fault code	Monitoring strategy	Fault detection criteria	MI activation criteria	Secondary parameters	Preconditioning	Demonstration test
Catalyst	P0420	Oxygen sensor 1 and 2 signals	Difference between sensor 1 and sensor 2 signals	3rd cycle	Engine speed, engine load, A/F mode, catalyst temperature	e.g. Two Type 1 cycles (as described in Annex III of Regulation (EC) No 692/2008 or in Annex XXI to Regulation (EU) 2017/1151)	e.g. Type 1 test (as described in Annex III of Regulation (EC) No 692/2008 or in Annex XXI to Regulation (EU) 2017/1151)

3. INFORMATION REQUIRED FOR THE MANUFACTURE OF DIAGNOSTIC TOOLS

In order to facilitate the provision of generic diagnostic tools for multi-make repairers, vehicle manufacturers shall make available the information referred to in the points 3.1 to 3.3. through their repair information

▼B

web-sites. This information shall include all diagnostic tool functions and all the links to repair information and troubleshooting instructions. The access to this information may be subject to the payment of a reasonable fee.

3.1. Communication Protocol Information

The following information shall be required indexed against vehicle make, model and variant, or other workable definition such as VIN or vehicle and systems identification:

- (a) Any additional protocol information system necessary to enable complete diagnostics in addition to the standards prescribed in Section 4 of Annex XI, including any additional hardware or software protocol information, parameter identification, transfer functions, 'keep alive' requirements, or error conditions;
- (b) Details of how to obtain and interpret all fault codes not in accordance with the standards prescribed in Section 4 of Annex XI;
- (c) A list of all available live data parameters including scaling and access information;
- (d) A list of all available functional tests including device activation or control and the means to implement them;
- (e) Details of how to obtain all component and status information, time stamps, pending DTC and freeze frames;
- (f) Resetting adaptive learning parameters, variant coding and replacement component setup, and customer preferences;
- (g) ECU identification and variant coding;
- (h) Details of how to reset service lights;
- (i) Location of diagnostic connector and connector details;
- (j) Engine code identification.

3.2. Test and diagnosis of OBD monitored components

The following information shall be required:

- (a) A description of tests to confirm its functionality, at the component or in the harness
- (b) Test procedure including test parameters and component information
- (c) Connection details including minimum and maximum input and output and driving and loading values

▼B

- (d) Values expected under certain driving conditions including idling
- (e) Electrical values for the component in its static and dynamic states
- (f) Failure mode values for each of the above scenarios
- (g) Failure mode diagnostic sequences including fault trees and guided diagnostics elimination.

3.3. Data required to perform the repair

The following information shall be required:

- (a) ECU and component initialisation (in the event of replacements being fitted)
- (b) Initialisation of new or replacement ECUs where relevant using pass-through (re-) programming techniques.

▼ B*Appendix 6***EC Type-Approval Certification Numbering System**

1. Section 3 of the EC type-approval number issued according to Article 6(1) shall be composed by the number of the implementing regulatory act or the latest amending regulatory act applicable to the EC type-approval. This number shall be followed by one or more characters reflecting the different categories in accordance with Table 1.

▼ M2*Table 1*

Character	Emission standard	OBD standard	Vehicle category and class	Engine	Implementation date: new types	Implementation date: new vehicles	Last date of registration
AA	Euro 6c	Euro 6-1	M, N1 class I	PI, CI			31.8.2018
BA	Euro 6b	Euro 6-1	M, N1 class I	PI, CI			31.8.2018
AB	Euro 6c	Euro 6-1	N1 class II	PI, CI			31.8.2019
BB	Euro 6b	Euro 6-1	N1 class II	PI, CI			31.8.2019
AC	Euro 6c	Euro 6-1	N1 class III, N2	PI, CI			31.8.2019
BC	Euro 6b	Euro 6-1	N1 class III, N2	PI, CI			31.8.2019
AD	Euro 6c	Euro 6-2	M, N1 class I	PI, CI		1.9.2018	31.8.2019
AE	Euro 6c-EVAP	Euro 6-2	N1 class II	PI, CI		1.9.2019	31.8.2020
AF	Euro 6c-EVAP	Euro 6-2	N1 class III, N2	PI, CI		1.9.2019	31.8.2020
AG	Euro 6d-TEMP	Euro 6-2	M, N1 class I	PI, CI	1.9.2017 ⁽¹⁾		31.8.2019
BG	Euro 6d-TEMP-EVAP	Euro 6-2	M, N1 class I	PI, CI			31.8.2019
CG	Euro 6d-TEMP-ISC	Euro 6-2	M, N1 class I	PI, CI	1.1.2019		31.8.2019
DG	Euro 6d-TEMP-EVAP-ISC	Euro 6-2	M, N1 class I	PI, CI	1.9.2019	1.9.2019	31.12.2020
AH	Euro 6d-TEMP	Euro 6-2	N1 class II	PI, CI	1.9.2018 ⁽¹⁾		31.8.2019

▼ M3

▼ M3

Character	Emission standard	OBD standard	Vehicle category and class	Engine	Implementation date: new types	Implementation date: new vehicles	Last date of registration
▼ <u>C3</u> BH	Euro 6d-TEMP-EVAP	Euro 6-2	N1 class II	PI, CI			31.8.2020
▼ <u>M3</u> CH	Euro 6d-TEMP-EVAP-ISC	Euro 6-2	N1 class II	PI, CI	1.9.2019	1.9.2020	31.12.2021
AI	Euro 6d-TEMP	Euro 6-2	N1 class III, N2	PI, CI	1.9.2018 ⁽¹⁾		31.8.2019
▼ <u>C3</u> BI	Euro 6d-TEMP-EVAP	Euro 6-2	N1 class III, N2	PI, CI			31.8.2020
▼ <u>M3</u> CI	Euro 6d-TEMP-EVAP-ISC	Euro 6-2	N1 class III, N2	PI, CI	1.9.2019	1.9.2020	31.12.2021
AJ	Euro 6d	Euro 6-2	M, N1 class I	PI, CI			31.8.2019
AK	Euro 6d	Euro 6-2	N1 class II	PI, CI			31.8.2020
AL	Euro 6d	Euro 6-2	N1 class III, N2	PI, CI			31.8.2020
AM	Euro 6d-ISC	Euro 6-2	M, N1 class I	PI, CI			31.12.2020
AN	Euro 6d-ISC	Euro 6-2	N1 class II	PI, CI			31.12.2021
AO	Euro 6d-ISC	Euro 6-2	N1 class III, N2	PI, CI			31.12.2021
AP	Euro 6d-ISC-FCM	Euro 6-2	M, N1 class I	PI, CI	1.1.2020	1.1.2021	
AQ	Euro 6d-ISC-FCM	Euro 6-2	N1 class II	PI, CI	1.1.2021	1.1.2022	
AR	Euro 6d-ISC-FCM	Euro 6-2	N1 class III, N2	PI, CI	1.1.2021	1.1.2022	
▼ <u>M2</u> AX	n.a.	n.a.	All vehicles	Battery full electric			
AY	n.a.	n.a.	All vehicles	Fuel cell			

▼ M2

Character	Emission standard	OBD standard	Vehicle category and class	Engine	Implementation date: new types	Implementation date: new vehicles	Last date of registration
AZ	n.a.	n.a.	All vehicles using certificates according to point 2.1.1 of Annex I	PI, CI			

(¹) This limitation does not apply if a vehicle was type-approved in accordance with the requirements of Regulation (EC) No 715/2007 and its implementing legislation prior to 1 September 2017 in the case of category M and N1 class I vehicles, or prior to 1 September 2018 in the case of category N1 class II and III and category N2 vehicles, according to the last subparagraph of Article 15(4).

Key:

'Euro 6-1' OBD standard = Full Euro 6 OBD requirements but with preliminary OBD threshold limits as defined in point 2.3.4 of Annex XI and partially relaxed IUPR;

'Euro 6-2' OBD standard = Full Euro 6 OBD requirements but with final OBD threshold limits as defined in point 2.3.3 of Annex XI;

'Euro 6b' emissions standard = Euro 6 emission requirements including revised measurement procedure for particulate matter, particle number standards (preliminary values for PI direct injection);

'Euro 6c' emissions standard = RDE NOx testing for monitoring only (no NTE emission limits applied), otherwise full Euro 6 tailpipe emission requirements (including PN RDE);

'Euro 6c-EVAP' emissions standard = RDE NOx testing for monitoring only (no NTE emission limits applied), otherwise full Euro 6 tailpipe emission requirements (including PN RDE), revised evaporative emissions test procedure;

'Euro 6d-TEMP' emissions standard = RDE NOx testing against temporary conformity factors, otherwise full Euro 6 tailpipe emission requirements (including PN RDE);

▼ M3

'Euro 6d-TEMP-ISC' emissions standard= RDE testing against temporary conformity factors, full Euro 6 tailpipe emission requirements (including PN RDE) and new ISC procedure;

'Euro 6d-TEMP-EVAP-ISC' emissions standard= RDE NOx testing against temporary conformity factors, full Euro 6 tailpipe emission requirements (including PN RDE), 48H evaporative emissions test procedure and new ISC procedure;

▼ M2

'Euro 6d-TEMP-EVAP' emissions standard = RDE NOx testing against temporary conformity factors, otherwise full Euro 6 tailpipe emission requirements (including PN RDE), revised evaporative emissions test procedure;

'Euro 6d' emissions standard = RDE testing against final conformity factors, otherwise full Euro 6 tailpipe emission requirements, revised evaporative emissions test procedure;

▼ M3

'Euro 6d-ISC' RDE' = testing against final conformity factors, full Euro 6 tailpipe emission requirements, 48H evaporative emissions test procedure and new ISC procedure;

'Euro 6d-ISC-FCM' RDE' = testing against final conformity factors, full Euro 6 tailpipe emission requirements, 48H evaporative emissions test procedure, devices for monitoring the consumption of fuel and/or electric energy and new ISC procedure.

▼ B

2. EXAMPLES OF TYPE-APPROVAL CERTIFICATION NUMBERS

2.1 An example is provided below of an approval of a Euro 6 light passenger car to the 'Euro 6d' emission standard and 'Euro 6-2' OBD standard, identified by the characters AJ according to table 1, issued by Luxembourg, identified by the code e13. The approval was granted for the base Regulation (EC) 715/2007 and its implementing Regulation (EC) xxx/2016 without any amendments. It is the 17th approval of this kind without any extension, so the fourth and fifth components of the certification number are 0017 and 00, respectively.

▼B

- 2.2 This second example shows an approval of a Euro 6 N1 class II light commercial vehicle to the 'Euro 6d-TEMP' emission standard and 'Euro 6-2' OBD standard, identified by the characters AH according to table 1, issued by Romania, identified by the code e19. The approval was granted for the base Regulation (EC) 715/2007 and its implementing legislation as last amended by a Regulation xyz/2018. It is the 1st approval of this kind without extension, so the fourth and fifth components of the certification number are 0001 and 00, respectively.

e19 × 715/2007 × xyz/2018AH × 0001 × 00

▼ B

Appendix 7

Manufacturer's certificate of compliance with the OBD in-use performance requirements

(Manufacturer):

(Address of the manufacturer):

Certifies that

- The vehicle types listed in attachment to this Certificate are in compliance with the provisions of section 3 of Appendix 1 to Annex XI of Commission Regulation (EU) 2017/1151 relating to the in-use performance of the OBD system under all reasonably foreseeable driving conditions.
- The plan(s) describing the detailed technical criteria for incrementing the numerator and denominator of each monitor attached to this Certificate are correct and complete for all types of vehicles to which the Certificate applies.

Done at [..... Place]

On [..... Date]

.....
[Signature of the Manufacturer's Representative]

Annexes:

- List of vehicle types to which this Certificate applies
- Plan(s) describing the detailed technical criteria for incrementing the numerator and denominator of each monitor, as well as plan(s) for disabling numerators, denominators and general denominator.

▼ **M3***Appendix 8a***Test Reports**

A Test Report is the report issued by the technical service responsible for conducting the tests according this regulation.

PART I

The following information, if applicable, is the minimum data required for the Type 1 test.

REPORT number

APPLICANT		
Manufacturer		
SUBJECT	...	
Roadload family identifier(s)	:	
Interpolation family identifier(s)	:	
Object submitted to tests		
	Make	:
	IP identifier	:
CONCLUSION	The object submitted to tests complies with the requirements mentioned in the subject.	

PLACE,	DD/MM/YYYY
--------	------------

General notes:

If there are several options (references), the one tested should be described in the test report

If there are not, a single reference to the information document at the start of the test report may be sufficient.

Every Technical Service is free to include some additional information

(a) Specific to positive ignition engine

(b) Specific to compression ignition engine

1. DESCRIPTION OF TESTED VEHICLE(S): HIGH, LOW AND M (IF APPLICABLE)

▼ **M3**1.1. **General**

Vehicle numbers	:	Prototype number and VIN
Category	:	
Bodywork	:	
Drive wheels	:	

1.1.1. *Powertrain Architecture*

Powertrain architecture	:	pure ICE, hybrid, electric or fuel cell
-------------------------	---	---

1.1.2. *INTERNAL COMBUSTION ENGINE (if applicable)*

For more than one ICE, please repeat the point

Make	:	
Type	:	
Working principle	:	two/four stroke
Cylinders number and arrangement	:	
Engine capacity (cm ³)	:	
Engine idling speed (min ⁻¹)	:	+
High engine idling speed (min ⁻¹) (a)	:	+
Rated engine power	:	kW at rpm
Maximum net torque	:	Nm at rpm
Engine lubricant	:	make and type
Cooling system	:	Type: air/water/oil
Insulation	:	material, amount, location, volume and weight

1.1.3. *TEST FUEL for Type 1 test (if applicable)*

For more than one test fuel, please repeat the point

Make	:	
Type	:	Petrol E10 - Diesel B7 - LPG - NG - ...
Density at 15 °C	:	
Sulphur content	:	Only for Diesel B7 and Petrol E10
Batch number	:	
Willans factors (for ICE) for CO ₂ emission (gCO ₂ /MJ)	:	

▼ **M3**1.1.4. *FUEL FEED SYSTEM (if applicable)*

For more than one fuel feed system, please repeat the point

Direct injection	:	yes/no or description
Vehicle fuel type	:	Monofuel / bifuel / flex fuel
Control unit		
Part reference	:	same as information document
Software tested	:	read via scantool, for example
Air flowmeter	:	
Throttle body	:	
Pressure sensor	:	
Injection pump	:	
Injector(s)	:	

1.1.5. *INTAKE SYSTEM (if applicable)*

For more than one intake system, please repeat the point

Pressure charger	:	Yes/no make & type (1)
Intercooler	:	yes/no type (air/air – air/water) (1)
Air filter (element) (1)	:	make & type
Intake silencer (1)	:	make & type

1.1.6. *EXHAUST SYSTEM AND ANTI-EVAPORATIVE SYSTEM (if applicable)*

For more than one, please repeat the point

First catalytic converter	:	make & reference (1) principle: three way / oxidising / NO _x trap / NO _x storage system / Selective Catalyst Reduction...
Second catalytic converter	:	make & reference (1) principle: three way/oxidising / NO _x trap / NO _x storage system / Selective Catalyst Reduction...
Particulate trap	:	with/without/not applicable catalysed: yes/no make & reference (1)
Reference and position of oxygen sensor(s)	:	before catalyst/after catalyst
Air injection	:	with/without/not applicable
Water injection	:	with/without/not applicable
EGR	:	with/without/not applicable cooled/non-cooled HP/LP
Evaporative emission control system	:	with/without/not applicable
Reference and position of NO _x sensor(s)	:	Before/after
General description (1)	:	

▼ **M3**1.1.7. *HEAT STORAGE DEVICE (if applicable)*

For more than one Heat Storage System, please repeat the point

Heat storage device	:	yes/no
Heat capacity (enthalpy stored J)	:	
Time for heat release (s)	:	

1.1.8. *TRANSMISSION (if applicable)*

For more than one Transmission, please repeat the point

Gearbox	:	manual / automatic / continuous variation
Gear shifting procedure		
Predominant mode (*)	:	yes/no normal / drive / eco/...
Best case mode for CO ₂ emissions and fuel consumption (if applicable)	:	
Worst case mode for CO ₂ emissions and fuel consumption (if applicable)	:	
Highest electric energy consumption mode (if applicable)	:	
Control unit	:	
Gearbox lubricant	:	make and type
Tyres		
Make	:	
Type	:	
Dimensions front/rear	:	
Dynamic circumference (m)	:	
Tyre pressure (kPa)	:	

(*) for OVC-HEV, specify for charge sustaining and for charge depleting operating conditions.

Transmission ratios (R.T.), primary ratios (R.P.) and (vehicle speed (km/h) / (engine speed (1 000 (min⁻¹)) (V₁₀₀₀)) for each of the gearbox ratios (R.B.).

R.B.	R.P.	R.T.	V ₁₀₀₀
1st	1/1		
2nd	1/1		
3rd	1/1		
4th	1/1		
5th	1/1		
...			

▼ **M3**1.1.9. *ELECTRIC MACHINE (if applicable)*

For more than one Electric Machine, please repeat the point

Make	:	
Type	:	
Peak Power (kW)	:	

1.1.10. *TRACTION REESS (if applicable)*

For more than one Traction REESS, please repeat the point

Make	:	
Type	:	
Capacity (Ah)	:	
Nominal Voltage (V)	:	

1.1.11. *FUEL CELL (if applicable)*

For more than one Fuel Cell, please repeat the point

Make	:	
Type	:	
Maximum Power (kW)	:	
Nominal Voltage (V)	:	

1.1.12. *POWER ELECTRONICS (if applicable)*

Can be more than one PE (propulsion converter, low voltage system or charger)

Make	:	
Type	:	
Power (kW)	:	

1.2. **Vehicle high description**1.2.1. *MASS*

Test mass of VH (kg)	:	
----------------------	---	--

1.2.2. *ROAD LOAD PARAMETERS*

f_0 (N)	:	
f_1 (N/(km/h))	:	
f_2 (N/(km/h) ²)	:	
Cycle energy demand (J)	:	
Road load test report reference	:	
Road load family's identifier	:	

▼ **M3**1.2.3. *CYCLE SELECTION PARAMETERS*

Cycle (without downscaling)	:	Class 1 / 2 / 3a / 3b
Ratio of rated power to mass in running order (PMR)(W/kg)	:	(if applicable)
Capped speed process used during measurement	:	yes/no
Maximum speed of the vehicle (km/h)	:	
Downscaling (if applicable)	:	yes/no
Downscaling factor fdsc	:	
Cycle distance (m)	:	
Constant speed (in the case of the shortened test procedure)	:	if applicable

1.2.4. *GEAR SHIFT POINT (IF APPLICABLE)*

Version of Gear Shift calculation	:	(indicate the applicable amendment to Regulation (EU)_2017/1151)
Gear shifting	:	Average gear for $v \geq 1$ km/h, rounded to four places of decimal

nmin drive

1st gear	:	...min ⁻¹
1st gear to 2nd	:	...min ⁻¹
2nd gear to standstill	:	...min ⁻¹
2nd gear	:	...min ⁻¹
3rd gear and beyond	:	...min ⁻¹
Gear 1 excluded	:	yes/no
n_95_high for each gear	:	...min ⁻¹
n_min_drive_set for acceleration/constant speed phases (n_min_drive_up)	:	...min ⁻¹
n_min_drive_set for deceleration phases (nmin_drive_down)	:	...min ⁻¹
t_start_phase	:	...s
n_min_drive_start	:	...min ⁻¹
N_min_drive_up_start	:	...min ⁻¹
use of ASM	:	yes/no
ASM values	:	

▼ **M3**1.3. **Vehicle low description (if applicable)**1.3.1. *MASS*

Test mass of VL(kg)	:	
---------------------	---	--

1.3.2. *ROAD LOAD PARAMETERS*

f_0 (N)	:	
f_1 (N/(km/h))	:	
f_2 (N/(km/h) ²)	:	
Cycle energy demand (J)	:	
$\Delta(C_D \times A_f)_{LH}$ (m ²)	:	
Road load test report reference	:	
Road load family's identifier	:	

1.3.3. *CYCLE SELECTION PARAMETERS*

Cycle (without downscaling)	:	Class 1 / 2 / 3a / 3b
Ratio of rated power to mass in running order (PMR)(W/kg)	:	(if applicable)
Capped speed process used during measurement	:	yes/no
Maximum speed of the vehicle	:	
Downscaling (if applicable)	:	yes/no
Downscaling factor f_{dsc}	:	
Cycle distance (m)	:	
Constant speed (in the case of the shortened test procedure)	:	if applicable

1.3.4. *GEAR SHIFT POINT (IF APPLICABLE)*

Gear shifting	:	Average gear for $v \geq 1$ km/h, rounded to four places of decimal
---------------	---	---

1.4. **Vehicle M description (if applicable)**1.4.1. *MASS*

Test mass of VL(kg)	:	
---------------------	---	--

▼ **M3**1.4.2. *ROAD LOAD PARAMETERS*

f_0 (N)	:	
f_1 (N/(km/h))	:	
f_2 (N/(km/h) ²)	:	
Cycle energy demand (J)	:	
$\Delta(C_D \times A_f)_{LH}$ (m ²)	:	
Road load test report reference	:	
Road load family's identifier	:	

1.4.3. *CYCLE SELECTION PARAMETERS*

Cycle (without downscaling)	:	Class 1 / 2 / 3a / 3b
Ratio of rated power to mass in running order (PMR)(W/kg)	:	(if applicable)
Capped speed process used during measurement	:	yes/no
Maximum speed of the vehicle	:	
Downscaling (if applicable)	:	yes/no
Downscaling factor fd_{sc}	:	
Cycle distance (m)	:	
Constant speed (in the case of the shortened test procedure)	:	if applicable

1.4.4. *GEAR SHIFT POINT (IF APPLICABLE)*

Gear shifting	:	Average gear for $v \geq 1$ km/h, rounded to four places of decimal
---------------	---	---

2. TEST RESULTS

2.1. **Type 1 test**

Method of chassis dyno setting	:	Fixed run / iterative / alternative with its own warmup cycle
Dynamometer in 2WD/4WD operation	:	2WD/4WD
For 2WD operation, was the non-powered axle rotating	:	yes/no/not applicable
Dynamometer operation mode	:	yes/no
Coastdown mode	:	yes/no
Additional preconditioning	:	yes/no description
Deterioration factors	:	assigned / tested

▼ **M3**2.1.1. *Vehicle high*

Date of tests	:	(day/month/year)
Place of the test	:	Chassis dyno, location, country
Height of the lower edge above ground of cooling fan (cm)	:	
Lateral position of fan centre (if modified as request by the manufacturer)	:	in the vehicle centre-line/...
Distance from the front of the vehicle (cm)	:	
IWR: Inertial Work Rating (%)	:	x,x
RMSSE: Root Mean Squared Speed Error (km/h)	:	x,xx
Description of the accepted deviation of the driving cycle	:	PEV before break off criteria or Fully operated acceleration pedal

2.1.1.1. Pollutant emissions (if applicable)

2.1.1.1.1. Pollutant emissions of vehicles with at least one combustion engine, of NOVC-HEVs and of OVC-HEVs in case of a charge-sustaining Type 1 test

For each driver selectable mode tested the points below shall be repeated (predominant mode or best case mode and worst case, mode if applicable)

Test 1

Pollutants	CO	THC (a)	NMHC (a)	NO _x	THC + NO _x (b)	Particulate Matter	Particle Number
	(mg/km)	(mg/km)	(mg/km)	(mg/km)	(mg/km)	(mg/km)	(#.10 ¹¹ /km)
Measured values							
Regeneration factors (Ki)(2) Additive							
Regeneration factors (Ki)(2) Multiplicative							
Deterioration factors (DF) additive							
Deterioration factors (DF) multi- multiplicative							
Final values							
Limit values							

(2) See Ki family report(s)

Type 1/I performed for Ki determination : Annex XXI, Sub-Annex 4 or UN/ECE Regulation No 83 ⁽²⁾

Regeneration family's identifier :

⁽²⁾ Indicate as applicable

▼ **M3**

Test 2 if applicable: for CO₂ reason (d_{CO2}¹) / for pollutants reason (90 % of the limits) / for both

Record test results in accordance with the table of Test 1

Test 3 if applicable: for CO₂ reason (d_{CO2}²)

Record test results in accordance with the table of Test 1

2.1.1.1.2. Pollutant emissions of OVC-HEVs in case of a charge-depleting Type 1 test

Test 1

Pollutant emission limits have to be fulfilled and the following point has to be repeated for each driven test cycle.

Pollutants	CO	THC (a)	NMHC (-a)	NO _x	THC + NO _x (b)	Particulate Matter	Particle Number
	(mg/km)	(mg/km)	(mg/km)	(mg/km)	(mg/km)	(mg/km)	(#.10 ¹¹ /km)
Measured single cycle values							
Limit single cycle values							

Test 2 (if applicable): for CO₂ reason (d_{CO2}¹) / for pollutants reason (90 % of the limits) / for both

Record test results in accordance with the table of Test 1

Test 3 (if applicable): for CO₂ reason (d_{CO2}²)

Record test results in accordance with the table of Test 1

2.1.1.1.3. UF-WEIGHTED POLLUTANT EMISSIONS OF OVC-HEVS

Pollutants	CO	THC (a)	NMHC (-a)	NO _x	THC + NO _x (b)	Particulate Matter	Particle Number
	(mg/km)	(mg/km)	(mg/km)	(mg/km)	(mg/km)	(mg/km)	(#.10 ¹¹ /km)
Calculated values							

2.1.1.2. CO₂ emission (if applicable)

2.1.1.2.1. CO₂ emission of vehicles with at least one combustion engine, of NOVC-HEV and of OVC-HEV in the case of a charge-sustaining Type 1 test

For each driver selectable mode tested the points below have to be repeated (predominant mode or best case mode and worst case, mode if applicable)

▼ **M3****Test 1**

CO ₂ emission	Low	Medium	High	Extra High	Combined
Measured value $M_{CO_2,p,1}$					—
Speed and distance corrected value $M_{CO_2,p,1b} / M_{CO_2,e,2}$					
RCB correction coefficient: (5)					
$M_{CO_2,p,3} / M_{CO_2,e,3}$					
Regeneration factors (Ki) Additive					
Regeneration factors (Ki) Multiplicative					
$M_{CO_2,e,4}$			—		
$AF_{Ki} = M_{CO_2,e,3} / M_{CO_2,e,4}$			—		
$M_{CO_2,p,4} / M_{CO_2,e,4}$					—
ATCT correction (FCF) (4)					
Temporary values $M_{CO_2,p,5} / M_{CO_2,e,5}$					
Declared value	—	—	—	—	
$d_{CO_2}^1$ * declared value	—	—	—	—	

(4) FCF: family correction factor for correcting for representative regional temperature conditions (ATCT)

See FCF family report(s)	:	
ATCT family's identifier	:	

(5) correction as referred to in Sub-Annex 6 Appendix 2 of Annex XXI of Regulation (EU) 2017/1151 for pure ICE vehicles, and Sub-Annex 8 Appendix 2 of Annex XXI of Regulation (EU) 2017/1151 for HEVs (K_{CO_2})

Test 2 (if applicable)

Record test results in accordance with the table of Test 1

Test 3 (if applicable)

Record test results in accordance with the table of Test 1

Conclusion

CO ₂ emission (g/km)	Low	Medium	High	Extra High	Combined
Averaging $M_{CO_2,p,6} / M_{CO_2,e,6}$					
Alignment $M_{CO_2,p,7} / M_{CO_2,e,7}$					
Final values $M_{CO_2,p,H} / M_{CO_2,e,H}$					

▼ **M3**

Information for Conformity of Production for OVC-HEV

	Combined
CO ₂ emission (g/km)	
M _{CO₂,CS,COP}	
AF _{CO₂,CS}	

2.1.1.2.2. CO₂ mass emission of OVC-HEVs in case of a charge-depleting Type 1 test**Test 1**

CO ₂ mass emission (g/km)	Combined
Calculated value M _{CO₂,CD}	
Declared value	
d _{CO₂} ¹	

Test 2 (if applicable)

Record test results in accordance with the table of Test 1

Test 3 (if applicable)

Record test results in accordance with the table of Test 1

Conclusion

CO ₂ mass emission (g/km)	Combined
Averaging M _{CO₂,CD}	
Final value M _{CO₂,CD}	

2.1.1.2.4. UF-WEIGHTED CO₂ mass emission of OVC-HEVs

CO ₂ mass emission (g/km)	Combined
Calculated value M _{CO₂,weighted}	

2.1.1.3 FUEL CONSUMPTION (IF APPLICABLE)

2.1.1.3.1. Fuel consumption of vehicles with only a combustion engine, of NOVC-HEVs and of OVC-HEVs in case of a charge-sustaining Type 1 test

For each driver selectable mode tested the points below has to be repeated (predominant mode or best case mode and worst case, mode if applicable)

Fuel consumption (l/100 km)	Low	Medium	High	Extra High	Combined
Final values FC _{p,H} / FC _{c,H} ⁽⁶⁾					

⁽⁶⁾ Calculated from aligned CO₂ values

▼ **M3**

A- On-board Fuel and/or Energy Consumption Monitoring for vehicles referred to in Article 4a

a. Data accessibility

The parameters listed in point 3 of Annex XXII are accessible:
yes/not applicable

b. Accuracy (if applicable)

Fuel_Consumed _{WLTP} (litres) ⁽⁸⁾	Vehicle HIGH - Test 1	x,xxx
	Vehicle HIGH - Test 2 (if applicable)	x,xxx
	Vehicle HIGH - Test 3 (if applicable)	x,xxx
	Vehicle LOW - Test 1 (if applicable)	x,xxx
	Vehicle LOW Test 2 (if applicable)	x,xxx
	Vehicle LOW - Test 3 (if applicable)	x,xxx
	Total	x,xxx
Fuel_Consumed _{OBFCM} (litres) ⁽⁸⁾	Vehicle HIGH - Test 1	x,xx
	Vehicle HIGH - Test 2 (if applicable)	x,xx
	Vehicle HIGH - Test 3 (if applicable)	x,xx
	Vehicle LOW - Test 1 (if applicable)	x,xx
	Vehicle LOW Test 2 (if applicable)	x,xx
	Vehicle LOW - Test 3 (if applicable)	x,xx
	Total	x,xx
Accuracy ⁽⁸⁾		x,xxx

⁽⁸⁾ in accordance with Annex XXII

2.1.1.3.2. Fuel consumption of OVC-HEVs in case of a charge-depleting Type 1 test

Test 1:

Fuel consumption (l/100 km)	Combined
Calculated value FC _{CD}	

Test 2 (if applicable)

Record test results in accordance with the table of Test 1

Test 3 (if applicable)

Record test results in accordance with the table of Test 1

▼ **M3****Conclusion**

Fuel consumption (l/100km)	Combined
Averaging FC_{CD}	
Final value FC_{CD}	

2.1.1.3.3. UF-Weighted Fuel consumption of OVC-HEVs

Fuel consumption (l/100 km)	Combined
Calculated value $FC_{weighted}$	

2.1.1.3.4. Fuel consumption of vehicles of NOVC-FCHVs in case of a charge-sustaining Type 1 test

For each driver selectable mode tested the points below has to be repeated (predominant mode or best case mode and worst case, mode if applicable)

Fuel consumption (kg/100 km)	Combined
Measured values	
RCB correction coefficient	
Final values FC_c	

2.1.1.4. RANGES (IF APPLICABLE)

2.1.1.4.1. Ranges for OVC-HEVs (if applicable)

2.1.1.4.1.1. All electric range

Test 1

AER (km)	City	Combined
Measured/Calculated values AER		
Declared value	—	

Test 2 (if applicable)

Record test results in accordance with the table of Test 1

Test 3 (if applicable)

Record test results in accordance with the table of Test 1

Conclusion

AER (km)	City	Combined
Averaging AER (if applicable)		
Final values AER		

▼ **M3**

2.1.1.4.1.2. Equivalent All electric Range

EAER (km)	Low	Medium	High	Extra High	City	Combined
Final values EAER						

2.1.1.4.1.3. Actual Charge-Depleting Range

R _{CDA} (km)	Combined
Final value R _{CDA}	

2.1.1.4.1.4. Charge-Depleting Cycle Range

Test 1

R _{CDC} (km)	Combined
Final value R_{CDC}	
Index Number of the transition cycle	
REEC of confirmation-cycle (%)	

Test 2 (if applicable)

Record test results in accordance with the table of Test 1

Test 3 (if applicable)

Record test results in accordance with the table of Test 1

2.1.1.4.2. Ranges for PEVs - Pure electric range (if applicable)

Test 1

PER (km)	Low	Medium	High	Extra High	City	Combined
Calculated values PER						
Declared value	—	—	—	—	—	

Test 2 (if applicable)

Record test results in accordance with the table of Test 1

Test 3 (if applicable)

Record test results in accordance with the table of Test 1

Conclusion

PER (km)	City	Combined
Averaging PER		
Final values PER		

▼ M3

2.1.1.5. ELECTRIC CONSUMPTION (IF APPLICABLE)

2.1.1.5.1. Electric consumption of OVC-HEVs (if applicable)

2.1.1.5.1.1. Electric consumption (EC)

EC (Wh/km)	Low	Medium	High	Extra High	City	Combined
Final values EC						

2.1.1.5.1.2. UF-weighted charge-depleting electric consumption

Test 1

$EC_{AC,CD}$ (Wh/km)	Combined
Calculated value $EC_{AC,CD}$	

Test 2 (if applicable)

Record test results in accordance with the table of Test 1

Test 3 (if applicable)

Record test results in accordance with the table of Test 1

Conclusion (if applicable)

$EC_{AC,CD}$ (Wh/km)	Combined
Averaging $EC_{AC,CD}$	
Final value	

2.1.1.5.1.3. UF-weighted electric consumption

Test 1

$EC_{AC,weighted}$ (Wh)	Combined
Calculated value $EC_{AC,weighted}$	

Test 2 (if applicable)

Record test results in accordance with the table of Test 1

Test 3 (if applicable)

Record test results in accordance with the table of Test 1

Conclusion (if applicable)

$EC_{AC,weighted}$ (Wh/km)	Combined
Averaging $EC_{AC,weighted}$	
Final value	

▼ **M3**

2.1.1.5.1.4. Information for COP

	Combined
Electric consumption (Wh/km) $EC_{DC,CD,COP}$	
$AF_{EC,AC,CD}$	

2.1.1.5.2. Electric consumption of PEVs (if applicable)

Test 1

EC (Wh/km)	City	Combined
Calculated values EC		
Declared value	—	

Test 2 (if applicable)

Record test results in accordance with the table of Test 1

Test 3 (if applicable)

Record test results in accordance with the table of Test 1

EC (Wh/km)	Low	Medium	High	Extra High	City	Combined
Averaging EC						
Final values EC						

Information for COP

	Combined
Electric Consumption (Wh/km) $EC_{DC,COP}$	
AF_{EC}	

2.1.2. *VEHICLE LOW (IF APPLICABLE)*

Repeat § 2.1.1.

2.1.3. *VEHICLE M (IF APPLICABLE)*

Repeat § 2.1.1.

2.1.4. *FINAL CRITERIA EMISSIONS VALUES (IF APPLICABLE)*

Pollutants	CO	THC (a)	NMHC (a)	NO _x	THC + NO _x (b)	PM	PN
	(mg/km)	(mg/km)	(mg/km)	(mg/km)	(mg/km)	(mg/km)	(#.10 ¹¹ /km)
Highest values ⁽³⁾							

⁽³⁾ for each pollutant within all test results of VH, VL (if applicable) and VM (if applicable)

▼ **M3****2.2. Type 2 (a) test**

Included the emissions data required for roadworthiness testing

Test	CO (% vol)	Lambda (°)	Engine speed (min ⁻¹)	Oil temperature (°C)
Idle		—		
High idle				

(°) Delete where not applicable (there are cases where nothing needs to be deleted when more than one entry is applicable)

2.3. Type 3 (a) test

Emission of crankcase gases into the atmosphere: none

2.4. Type 4 (a) test

Family's identifier	:	
See report(s)	:	

2.5. Type 5 test

Family's identifier	:	
See durability family report(s)	:	
Type 1/I cycle for criteria emissions testing	:	Annex XXI, Sub-Annex 4 or UN/ECE Regulation No 83 ⁽³⁾

⁽³⁾ Indicate as applicable**2.6. RDE test**

RDE family number	:	MSxxxx
See family report(s)	:	

2.7. Type 6 (a) test

Family's identifier	:	
Date of tests	:	(day/month/year)
Place of tests	:	
Method of setting of the chassis dyno	:	coast down (road load reference)
Inertia mass (kg)	:	
If deviation from the vehicle of Type 1 test	:	
Tyres	:	
Make	:	
Type	:	
Dimensions front/rear	:	
Dynamic circumference (m)	:	
Tyre pressure (kPa)	:	

▼ **M3**

Pollutants		CO (g/km)	HC (g/km)
Test	1		
	2		
	3		
Average			
Limit			

2.8. **On board diagnostic system**

Family's identifier	:	
See family report(s)	:	

2.9. **Smoke opacity (b) test**2.9.1. *STEADY SPEEDS TEST*

See family report(s)	:	
----------------------	---	--

2.9.2. *FREE ACCELERATION TEST*

Measured absorption value (m^{-1})	:	
Corrected absorption value (m^{-1})	:	

2.10. **Engine power**

See report(s) or approval number	:	
----------------------------------	---	--

2.11. **Temperature information related to vehicle high (VH)**

Worst case approach vehicle cool down	:	yes/no (?)
ATCT family composed of a single Interpolation family	:	yes/no (?)
Engine coolant temperature at the end of soaking time (°C)	:	
Average soak area temperature over the 3 last hours (°C)	:	
Difference between engine coolant end temperature and average soak area temperature of the last 3 hours Δ_{T_ATCT} (°C)	:	
The minimum soaking time t_{soak_ATCT} (s)	:	

▼M3

Location of temperature sensor	:	
Measured engine temperature	:	oil/coolant

(7) if 'yes' then the six last lines are not applicable

▼ **M3***Annexes to the test report*

(not applicable to ATCT test and PEV)

1. All the input data for the correlation tool, listed in point 2.4 of Annex I to Regulations (EU) 2017/1152 and (EU) 2017/1153 (Correlation Regulations);

and

Reference of input file: ...

2. Complete correlation file referred to in point 3.1.1.2. of Annex I to Implementing Regulations (EU) 2017/1152 and (EU) 2017/1153;
3. Pure ICE and NOVC-HEV

Results NEDC Correlation		vehicle High	vehicle Low
NEDC CO ₂ declared value		xxx,xx	xxx,xx
CO ₂ -result CO ₂ MPAS (including Ki)		xxx,xx	xxx,xx
CO ₂ -result double-test or dice-test (including Ki)		xxx,xx	xxx,xx
Hash number			
Dice decision			
Deviation factor (value or not applicable)			
Verification factor (0/1/not applicable)			
Declared value confirmed by (CO ₂ MPAS / double-test)			
CO ₂ -result CO ₂ MPAS (excluding Ki)			
	urban		
	extra urban		
	combined		

Physical measurement results

Date of test (s)	Test 1	dd/mm/yyyy	dd/mm/yyyy	
	Test 2			
	Test 3			
CO ₂ emissions combined	Test 1	urban	xxx,xxx	xxx,xxx
		extra urban	xxx,xxx	xxx,xxx
		combined	xxx,xxx	xxx,xxx
	Test 2	urban		
		extra urban		
		combined		

▼ M3

Results NEDC Correlation			vehicle High	vehicle Low
	Test 3	urban		
		extra urban		
		combined		
Ki CO ₂			1,xxxx	
CO ₂ emissions combined including Ki	Average	combined		
Comparison with the declared value (declared-average)/declared %				
Road Load values for testing				
f ₀ (N)			x,x	x,x
f ₁ (N/(km/h))			x,xxx	x,xxx
f ₂ (N/(km/h) ²)			x,xxxxx	x,xxxxx
inertia class (kg)				
Final results				
NEDC CO ₂ [g/km]		urban	xxx,xx	xxx,xx
		extra urban	xxx,xx	xxx,xx
		combined	xxx,xx	xxx,xx
NEDC FC [l/100km]		urban	x,xxx	x,xxx
		extra urban	x,xxx	x,xxx
		combined	x,xxx	x,xxx

4. OVC-HEV test results

4.1. Vehicle High

4.1.1. CO₂ mass emissions for OVC-HEV

CO ₂ Emission (g/km)	Combined (including Ki)
Ki CO ₂	1,xxxx
M _{CO2,NEDC_H,test,condition A}	
M _{CO2,NEDC_H,test,condition B}	
M _{CO2,NEDC_H,test,weighted}	

4.1.2. Electric energy consumption for OVC-HEV

Electric energy consumption (Wh/km)	Combined
EC _{NEDC_H,test,condition A}	
EC _{NEDC_H,test,condition B}	
EC _{NEDC_H,test,weighted}	

▼ **M3**

4.1.3. Fuel consumption (l/100 km)

Fuel consumption (l/100 km)	Combined
$FC_{NEDC_L,test,condition\ A}$	
$FC_{NEDC_L,test,condition\ B}$	
$FC_{NEDC_L,test,weighted}$	

4.2. Vehicle Low (if applicable)

4.2.1. CO₂ mass emissions for OVC-HEV

CO ₂ Emission (g/km)	Combined (including Ki)
Ki CO ₂	1,xxxx
$M_{CO2,NEDC_L,test,condition\ A}$	
$M_{CO2,NEDC_L,test,condition\ B}$	
$M_{CO2,NEDC_L,test,weighted}$	

4.2.2. Electric energy consumption for OVC-HEV

Electric energy consumption (Wh/km)	Combined
$EC_{NEDC_L,test,condition\ A}$	
$EC_{NEDC_L,test,condition\ B}$	
$EC_{NEDC_L,test,weighted}$	

4.2.3. Fuel consumption (l/100 km)

Fuel consumption (l/100 km)	Combined
$FC_{NEDC_L,test,condition\ A}$	
$FC_{NEDC_L,test,condition\ B}$	
$FC_{NEDC_L,test,weighted}$	

▼ **M3**

PART II

The following information, if applicable, is the minimum data required for the ATCT test.

Report number

APPLICANT		
Manufacturer		
SUBJECT	...	
Roadload family identifier(s)	:	
Interpolation family identifier(s)	:	
ATCT identifier(s)	:	
Object submitted to tests		
	Make	:
	IP identifier	:
CONCLUSION	The object submitted to tests complies with the requirements mentioned in the subject.	

PLACE,	DD/MM/YYYY
--------	------------

General notes:

If there are several options (references), the one tested should be described in the test report

If there are not, a single reference to the information document at the start of the test report may be sufficient.

Every Technical Service is free to include some additional information

(a) Specific to positive ignition engine

(b) Specific to compression ignition engine

1. DESCRIPTION OF TESTED VEHICLE**1.1. GENERAL**

Vehicle numbers	:	Prototype number and VIN
Category	:	
Number of seats including the driver	:	
Bodywork	:	
Drive wheels	:	

▼ **M3**

1.1.1. Powertrain Architecture

Powertrain architecture	:	pure ICE, hybrid, electric or fuel cell
-------------------------	---	---

1.1.2. INTERNAL COMBUSTION ENGINE (if applicable)

For more than one ICE, please repeat the point

Make	:						
Type	:						
Working principle	:	two/four stroke					
Cylinders number and arrangement	:	...					
Engine capacity (cm ³)	:						
Engine idling speed (min ⁻¹)	:	±					
High engine idling speed (min ⁻¹) (a)	:	±					
Rated engine power	:	<table border="1"> <tr> <td></td> <td>kW</td> <td>At</td> <td></td> <td>rpm</td> </tr> </table>		kW	At		rpm
	kW	At		rpm			
Maximum net torque	:	<table border="1"> <tr> <td></td> <td>Nm</td> <td>At</td> <td></td> <td>rpm</td> </tr> </table>		Nm	At		rpm
	Nm	At		rpm			
Engine lubricant	:	make and type					
Cooling system	:	Type: air/water/oil					
Insulation	:	material, amount, location, volume and weight					

1.1.3. TEST FUEL for type 1 test (if applicable)

For more than one test fuel, please repeat the point

Make	:	
Type	:	Petrol E10 - Diesel B7 - LPG - NG - ...
Density at 15 °C	:	
Sulphur content	:	Only for Diesel B7 and Petrol E10
Annex IX	:	
Batch number	:	
Willans factors (for ICE) for CO ₂ emission (gCO ₂ /MJ)	:	

▼ **M3**

1.1.4. FUEL FEED SYSTEM (if applicable)

For more than one fuel feed system, please repeat the point

Direct injection	:	yes/no or description
Vehicle fuel type	:	Monofuel / bifuel / flex fuel
Control unit		
Part reference	:	same as information document
Software tested	:	read via scantool, for example
Air flowmeter	:	
Throttle body	:	
Pressure sensor	:	
Injection pump	:	
Injector(s)	:	

1.1.5. INTAKE SYSTEM (if applicable)

For more than one intake system, please repeat the point

Pressure charger	:	Yes/no make & type (1)
Intercooler	:	yes/no type (air/air – air/water) (1)
Air filter (element) (1)	:	make & type
Intake silencer (1)	:	make & type

1.1.6. EXHAUST SYSTEM AND ANTI-EVAPORATIVE SYSTEM (if applicable)

For more than one, please repeat the point

First catalytic converter	:	make & reference (1) principle: three way / oxidising / NO _x trap / Nox storage system / Selective Catalyst Reduction...
Second catalytic converter	:	make & reference (1) principle: three way / oxidising / NO _x trap / Nox storage system / Selective Catalyst Reduction...
Particulate trap	:	with/without/not applicable catalysed: yes/no make & reference (1)
Reference and position of oxygen sensor(s)	:	before catalyst / after catalyst
Air injection	:	with/without/not applicable

▼ **M3**

EGR	:	with/without/not applicable cooled/non-cooled HP/LP
Evaporative emission control system	:	with/without/not applicable
Reference and position of NO _x sensor(s)	:	Before/ after
General description (1)	:	

1.1.7. HEAT STORAGE DEVICE (if applicable)

For more than one Heat Storage System, please repeat the point

Heat storage device	:	yes/no
Heat capacity (enthalpy stored J)	:	
Time for heat release (s)	:	

1.1.8. TRANSMISSION (if applicable)

For more than one Transmission, please repeat the point

Gearbox	:	manual / automatic / continuous variation
Gear shifting procedure		
Predominant mode	:	yes/no normal / drive / eco/...
Best case mode for CO ₂ emissions and fuel consumption (if applicable)	:	
Worst case mode for CO ₂ emissions and fuel consumption (if applicable)	:	
Control unit	:	
Gearbox lubricant	:	make and type
Tyres		
Make	:	
Type	:	
Dimensions front/rear	:	
Dynamic circumference (m)	:	
Tyre pressure (kPa)	:	

Transmission ratios (R.T.), primary ratios (R.P.) and (vehicle speed (km/h)) / (engine speed (1 000 (min⁻¹))) (V₁₀₀₀) for each of the gearbox ratios (R.B.).

▼ **M3**

R.B.	R.P.	R.T.	V ₁₀₀₀
1st	1/1		
2nd	1/1		
3rd	1/1		
4th	1/1		
5th	1/1		
...			

1.1.9. ELECTRIC MACHINE (if applicable)

For more than one electric machine, please repeat the point

Make	:	
Type	:	
Peak Power (kW)	:	

1.1.10. TRACTION REESS (if applicable)

For more than one traction REESS, please repeat the point

Make	:	
Type	:	
Capacity (Ah)	:	
Nominal Voltage (V)	:	

1.1.11. POWER ELECTRONICS (if applicable)

Can be more than one PE (propulsion converter, low voltage system or charger)

Make	:	
Type	:	
Power (kW)	:	

1.2. VEHICLE DESCRIPTION

1.2.1. MASS

Test mass of VH (kg)	:	
----------------------	---	--

▼ **M3**

1.2.2. ROAD LOAD PARAMETERS

f_0 (N)	:	
f_1 (N/(km/h))	:	
f_2 (N/(km/h) ²)	:	
f_{2_TReg} (N/(km/h) ²)	:	
Cycle energy demand (J)	:	
Road load test report reference	:	
Road load family's identifier	:	

1.2.3. CYCLE SELECTION PARAMETERS

Cycle (without downscaling)	:	Class 1 / 2 / 3a / 3b
Ratio of rated power to mass in running order (PMR)(W/kg)	:	(if applicable)
Capped speed process used during measurement	:	yes/no
Maximum speed of the vehicle (km/h)	:	
Downscaling (if applicable)	:	yes/no
Downscaling factor fdsc	:	
Cycle distance (m)	:	
Constant speed (in the case of the shortened test procedure)	:	if applicable

1.2.4. GEAR SHIFT POINT (IF APPLICABLE)

Version of Gear Shift calculation	:	(indicate the applicable amendment to Regulation (EU)_2017/1151)
Gear shifting	:	Average gear for $v \geq 1$ km/h, rounded to four places of decimal
nmin drive		
1st gear	:	...min ⁻¹
1st gear to 2nd	:	...min ⁻¹
2nd gear to standstill	:	...min ⁻¹
2nd gear	:	...min ⁻¹
3rd gear and beyond	:	...min ⁻¹
Gear 1 excluded	:	yes/no
n_95_high for each gear	:	...min ⁻¹
n_min_drive_set for acceleration/constant speed phases (n_min_drive_up)	:	...min ⁻¹

▼ **M3**

n_min_drive_set for deceleration phases (nmin_drive_down)	:	...min ⁻¹
t_start_phase	:	...s
n_min_drive_start	:	...min ⁻¹
n_min_drive_up_start	:	...min ⁻¹
use of ASM	:	yes/no
ASM values	:	

2. **TEST RESULTS**

Method of chassis dyno setting	:	Fixed run / iterative / alternative with its own warmup cycle
Dynamometer in 2WD/4WD operation	:	2WD/4WD
For 2WD operation, was the non-powered axle rotating	:	yes/no/not applicable
Dynamometer operation mode	:	yes/no
Coastdown mode	:	yes/no

2.1 TEST AT 14 °C

Date of tests	:	(day/month/year)
Place of the test	:	
Height of the lower edge above ground of cooling fan (cm)	:	
Lateral position of fan centre (if modified as request by the manufacturer)	:	in the vehicle centre-line/...
Distance from the front of the vehicle (cm)	:	
IWR: Inertial Work Rating (%)	:	x,x
RMSSE: Root Mean Squared Speed Error (km/h)	:	x,xx
Description of the accepted deviation of the driving cycle	:	Fully operated acceleration pedal

2.1.1. Pollutant emissions of vehicle with at least one combustion engine, of NOVC-HEVs and of OVC-HEVs in case of a charge-sustaining

Pollutants	CO	THC (a)	NMHC (a)	NO _x	THC + NO _x (b)	Particulate Matter	Particle Number
	(mg/km)	(mg/km)	(mg/km)	(mg/km)	(mg/km)	(mg/km)	(#.10 ¹¹ /km)
Measured values							
Limit values							

2.1.2. CO₂ emission of vehicle with at least one combustion engine, of NOVC-HEV and of OVC-HEV in case of a charge-sustaining tests

▼ M3

CO ₂ emission (g/km)	Low	Medium	High	Extra High	Combined
Measured value $M_{CO_2,p,1}$					—
Measured Speed and distance corrected value $M_{CO_2,p,1b} / M_{CO_2,c,2}$					
RCB correction coefficient (²)					
$M_{CO_2,p,3} / M_{CO_2,c,3}$					

(²) correction as referred to in Sub-Annex 6 Appendix 2 of Annex XXI of this Regulation for ICE vehicles, K_{CO_2} for HEVs

2.2 TEST AT 23 °C

Provide information or refer to type 1 test report

Date of tests	:	(day/month/year)
Place of the test	:	
Height of the lower edge above ground of cooling fan (cm)	:	
Lateral position of fan centre (if modified as request by the manufacturer)	:	in the vehicle centre-line/...
Distance from the front of the vehicle (cm)	:	
IWR: Inertial Work Rating (%)	:	x,x
RMSSE: Root Mean Squared Speed Error (km/h)	:	x,xx
Description of the accepted deviation of the driving cycle	:	Fully operated acceleration pedal

2.2.1. Pollutant emissions of vehicle with at least one combustion engine, of NOVC-HEVs and of OVC-HEVs in case of a charge-sustaining

Pollutants	CO	THC (a)	NMHC (a)	NO _x	THC + NO _x (b)	Particulate Matter	Particle Number
	(mg/km)	(mg/km)	(mg/km)	(mg/km)	(mg/km)	(mg/km)	(#.10 ¹¹ /km)
Final values							
Limit values							

2.2.2. CO₂ emission of vehicle with at least one combustion engine, of NOVC-HEV and of OVC-HEV in case of a charge-sustaining tests

CO ₂ emission (g/km)	Low	Medium	High	Extra High	Combined
Measured value $M_{CO_2,p,1}$					—
Measured Speed and distance corrected value $M_{CO_2,p,1b} / M_{CO_2,c,2}$					
RCB correction coefficient (²)					
$M_{CO_2,p,3} / M_{CO_2,c,3}$					

(²) correction as referred to in Sub-Annex 6 Appendix 2 of Annex XXI of this Regulation for ICE vehicles, and Sub-Annex 8 Appendix 2 of Annex XXI of Regulation (EU) 2017/1151 for HEVs (K_{CO_2})

▼ **M3**

2.3 CONCLUSION

CO ₂ emission (g/km)	Combined
ATCT (14 °C) M _{CO₂,Treg}	
Type 1 (23 °C) M _{CO₂,23°}	
Family correction factor (FCF)	

2.4. TEMPERATURE INFORMATION OF THE REFERENCE VEHICLE AFTER 23 °C TEST

Worst case approach vehicle cool down	:	yes/no ⁽³⁾
ATCT family composed of a single Interpolation family	:	yes/no ⁽³⁾
Engine coolant temperature at the end of soaking time (°C)	:	
Average soak area temperature over the 3 last hours (°C)	:	
Difference between engine coolant end temperature and average soak area temperature of the last 3 hours Δ_{T_ATCT} (°C)	:	
The minimum soaking time t_{soak_ATCT} (s)	:	
Location of temperature sensor	:	
Measured engine temperature	:	oil/coolant

⁽³⁾ if 'yes' then the six last lines are not applicable

▼ **M3***Appendix 8b***Road Load Test Report**

The following information, if applicable, is the minimum data required for the road load determination test.

Report number

APPLICANT		
Manufacturer		
SUBJECT	Determination of a vehicle road load /...	
Roadload family identifier(s)	:	

Object submitted to tests

	Make	:	
	Type	:	
CONCLUSION	The object submitted to tests complies with the requirements mentioned in the subject.		

PLACE,	DD/MM/YYYY
--------	------------

1. CONCERNED VEHICLE(S)

Make(s) concerned	:	
Type(s) concerned	:	
Commercial description	:	
Maximal speed (km/h)	:	
Powered axle(s)	:	

2. DESCRIPTION OF TESTED VEHICLES

If no interpolation: the worst-case vehicle (regarding energy demand) shall be described

2.1. Wind tunnel method

Combination with	:	Flat belt dynamometer / chassis dynamometer
------------------	---	---

▼ **M3**

2.1.1 General

	Wind tunnel		Dynamometer	
	H _R	L _R	H _R	L _R
Make				
Type				
Version				
Cycle energy demand over a complete WLTC Class 3 cycle (kJ)				
Deviation from production series	—	—		
Mileage (km)	—	—		

Or (in case of roadload matrix family):

Make	:	
Type	:	
Version	:	
Cycle energy demand over a complete WLTC (kJ)	:	
Deviation from production series	:	
Mileage (km)	:	

2.1.2 Masses

	Dynamometer	
	H _R	L _R
Test mass (kg)		
Average mass m _{av} (kg)		
Value of m _r (kg per axle)		
Category M vehicle: proportion of the vehicle mass in running order on the front axle (%)		
Category N vehicle: weight distribution (kg or %)		

Or (in case of roadload matrix family):

Test mass (kg)	:	
Average mass m _{av} (kg)	:	(average before and after the test)

▼ **M3**

Technically permissible maximum laden mass	:	
Estimated arithmetic average of the mass of optional equipment	:	
Category M vehicle: proportion of the vehicle mass in running order on the front axle (%)	:	
Category N vehicle: weight distribution (kg or %)	:	

2.1.3 Tyres

	Wind tunnel		Dynamometer	
	H _R	L _R	H _R	L _R
Size designation				
Make				
Type				
Rolling resistance				
Front (kg/t)	—	—		
Rear (kg/t)	—	—		
Tyre pressure				
Front (kPa)	—	—		
Rear (kPa)	—	—		

Or (in case of roadload matrix family):

Size designation		
Make	:	
Type	:	
Rolling resistance		
Front (kg/t)	:	
Rear (kg/t)	:	
Tyre pressure		
Front (kPa)	:	
Rear (kPa)	:	

▼ **M3**

2.1.4. Bodywork

	Wind tunnel	
	H _R	L _R
Type	AA/AB/AC/ AD/AE/AF BA/BB/BC/ BD	
Version		
Aerodynamic devices		
Movable aerodynamic body parts	y/n and list if applicable	
Installed aerodynamic options list		
Delta ($C_D \times A_{pLH}$ compared to H _R (m ²))	—	

Or (in case of roadload matrix family):

Body shape description	:	Square box (if no representative body shape for a complete vehicle can be determined)
Frontal area Afr (m ²)	:	

2.2 ON ROAD

2.2.1. General

	H _R	L _R
Make		
Type		
Version		
Cycle energy demand over a complete WLTC Class 3 cycle (kJ)		
Deviation from production series		
Mileage		

Or (in case of roadload matrix family):

Make	:	
Type	:	
Version	:	
Cycle energy demand over a complete WLTC (kJ)	:	
Deviation from production series	:	
Mileage (km)	:	

▼ **M3**

2.2.2 Masses

	H _R	L _R
Test mass (kg)		
Average mass m _{av} (kg)		
Value of m _r (kg per axle)		
Category M vehicle: proportion of the vehicle mass in running order on the front axle (%)		
Category N vehicle: weight distribution (kg or %)		

Or (in case of roadload matrix family):

Test mass (kg)	:	
Average mass m _{av} (kg)	:	(average before and after the test)
Technically permissible maximum laden mass	:	
Estimated arithmetic average of the mass of optional equipment	:	
Category M vehicle: proportion of the vehicle mass in running order on the front axle (%)		
Category N vehicle: weight distribution (kg or %)		

2.2.3 Tyres

	H _R	L _R
Size designation		
Make		
Type		
Rolling resistance		
Front (kg/t)		
Rear (kg/t)		
Tyre pressure		
Front (kPa)		
Rear (kPa)		

▼ **M3**

Or (in case of roadload matrix family):

Size designation	:	
Make	:	
Type	:	
Rolling resistance		
Front (kg/t)	:	
Rear (kg/t)	:	
Tyre pressure		
Front (kPa)	:	
Rear (kPa)	:	

2.2.4. Bodywork

	H _R	L _R
Type	AA/AB/AC/ AD/AE/AF BA/BB/BC/ BD	
Version		
Aerodynamic devices		
Movable aerodynamic body parts	y/n and list if applicable	
Installed aerodynamic options list		
Delta ($C_D \times A_f$) _{LH} compared to H _R (m ²)	—	

Or (in case of roadload matrix family):

Body shape description	:	Square box (if no representative body shape for a complete vehicle can be determined)
Frontal area A _f (m ²)	:	

2.3. POWERTRAIN

2.3.1. Vehicle High

Engine code	:	
Transmission type	:	manual, automatic, CVT
Transmission model (manufacturer's codes)	:	(torque rating and no of clutches à to be included in info doc)

▼ **M3**

Covered transmission models (manufacturer's codes)	:			
Engine rotational speed divided by vehicle speed	:	Gear	Gear ratio	N/V ratio
		1st	1/..	
		2nd	1..	
		3rd	1/..	
		4th	1/..	
		5th	1/..	
		6th	1/..	
		..		
		..		
Electric machine(s) coupled in position N	:	n.a. (no electric machine or no coastdown mode)		
Type and number of electric machines	:	construction type: asynchronous/ synchronous...		
Type of coolant	:	air, liquid,...		

2.3.2. Vehicle Low

Repeat §2.3.1. with VL data

2.4. TEST RESULTS

2.4.1. Vehicle High

Dates of tests	:	dd/mm/yyyy (wind tunnel) dd/mm/yyyy (dynamometer) or dd/mm/yyyy (on road)
----------------	---	--

ON ROAD

Method of the test	:	coastdown or torque meter method
Facility (name / location / track's reference)	:	
Coastdown mode	:	y/n
Wheel alignment	:	Toe and camber values
Maximum reference speed (km/h)	:	
Anemometry	:	stationary or on board: influence of anemometry ($C_D \times A$) and if it was corrected.
Number of split(s)	:	
Wind	:	average, peaks and direction in conjunction with direction of the test track

▼ **M3**

Air pressure	:	
Temperature (mean value)	:	
Wind correction	:	y/n
Tyre pressure adjustment	:	y/n
Raw results	:	Torque method: $c_0 =$ $c_1 =$ $c_2 =$ Coastdown method: f_0 f_1 f_2
Final results	:	Torque method: $c_0 =$ $c_1 =$ $c_2 =$ and $f_0 =$ $f_1 =$ $f_2 =$ Coastdown method: $f_0 =$ $f_1 =$ $f_2 =$

Or

WIND TUNNEL METHOD

Facility (name/location/dynamometer's reference)	:		
Qualification of the facilities	:	Report reference and date	
Dynamometer			
Type of dynamometer	:	flat belt or chassis dynamometer	
Method	:	stabilised speeds or deceleration method	
Warm up	:	warm-up by dyno or by driving the vehicle	
Correction of the roller curve	:	(for chassis dynamometer, if applicable)	
Method of chassis dynamometer setting	:	Fixed run / iterative / alternative with its own warmup cycle	
Measured aerodynamic drag coefficient multiplied by the frontal area	:	Velocity (km/h)	$C_D \times A$ (m ²)
	
	
Result	:	$f_0 =$ $f_1 =$ $f_2 =$	

▼ M3

Or

ROAD LOAD MATRIX ON ROAD

Method of the test	:	coastdown or torque meter method
Facility (name/location/track's reference)	:	
Coastdown mode	:	y/n
Wheel alignment	:	Toe and camber values
Maximum reference speed (km/h)	:	
Anemometry	:	stationary or on board: influence of anemometry ($C_D \times A$) and if it was corrected.
Number of split(s)	:	
Wind	:	average, peaks and direction in conjunction with direction of the test track
Air pressure	:	
Temperature (mean value)	:	
Wind correction	:	y/n
Tyre pressure adjustment	:	y/n
Raw results	:	Torque method: $c_{0r} =$ $c_{1r} =$ $c_{2r} =$ Coastdown method: $f_{0r} =$ $f_{1r} =$ $f_{2r} =$
Final results	:	Torque method: $c_{0r} =$ $c_{1r} =$ $c_{2r} =$ and f_{0r} (calculated for vehicle H_M) = f_{2r} (calculated for vehicle H_M) = f_{0r} (calculated for vehicle L_M) = f_{2r} (calculated for vehicle L_M) = Coastdown method: f_{0r} (calculated for vehicle H_M) = f_{2r} (calculated for vehicle H_M) = f_{0r} (calculated for vehicle L_M) = f_{2r} (calculated for vehicle L_M) =

▼ **M3**

Or

ROAD LOAD MATRIX WIND TUNNEL METHOD

Facility (name/location/dynamometer's reference)	:		
Qualification of the facilities	:	Report reference and date	
Dynamometer			
Type of dynamometer	:	flat belt or chassis dynamometer	
Method	:	stabilised speeds or deceleration method	
Warm up	:	warm-up by dyno or by driving the vehicle	
Correction of the roller curve	:	(for chassis dynamometer, if applicable)	
Method of chassis dynamometer setting	:	Fixed run / iterative / alternative with its own warmup cycle	
Measured aerodynamic drag coefficient multiplied by the frontal area	:	Velocity (km/h)	$C_D \times A$ (m ²)
	
	
Result	:	$f_{0r} =$ $f_{1r} =$ $f_{2r} =$ f_{0r} (calculated for vehicle H _M) = f_{2r} (calculated for vehicle H _M) = f_{0r} (calculated for vehicle L _M) = f_{2r} (calculated for vehicle L _M) =	

2.4.2. Vehicle Low

Repeat §2.4.1. with VL data

▼ M3

Appendix 8c

Template for Test Sheet

The test sheet shall include the test data that are recorded, but not included in any test report.

The test sheet(s) shall be retained by the technical service or the manufacturer for at least 10 years.

The following information, if applicable, is the minimum data required for test sheets.

Information from Annex XXI, Sub-Annex 4 to Regulation (EU) 2017/1151																												
Adjustable wheel alignment parameters	:																											
The coefficients, c_0 , c_1 and c_2 ,	:	$c_0 =$ $c_1 =$ $c_2 =$																										
The coastdown times measured on the chassis dynamometer	:	<table border="1"> <thead> <tr> <th>Reference speed (km/h)</th> <th>Coastdown time (s)</th> </tr> </thead> <tbody> <tr><td>130</td><td></td></tr> <tr><td>120</td><td></td></tr> <tr><td>110</td><td></td></tr> <tr><td>100</td><td></td></tr> <tr><td>90</td><td></td></tr> <tr><td>80</td><td></td></tr> <tr><td>70</td><td></td></tr> <tr><td>60</td><td></td></tr> <tr><td>50</td><td></td></tr> <tr><td>40</td><td></td></tr> <tr><td>30</td><td></td></tr> <tr><td>20</td><td></td></tr> </tbody> </table>	Reference speed (km/h)	Coastdown time (s)	130		120		110		100		90		80		70		60		50		40		30		20	
		Reference speed (km/h)	Coastdown time (s)																									
		130																										
		120																										
		110																										
		100																										
		90																										
		80																										
		70																										
		60																										
		50																										
		40																										
30																												
20																												
Additional weight may be placed on or in the vehicle to eliminate tyre slippage	:	weight (kg) on/in the vehicle																										

▼ M3

The coastdown times after performing the vehicle coast down procedure	:	Reference speed (km/h)	Coastdown time (s)
		130	
		120	
		110	
		100	
		90	
		80	
		70	
		60	
		50	
		40	
		30	
		20	

Information from Annex XXI, Sub-Annex 5 to Regulation (EU) 2017/1151

<u>NO_x converter efficiency</u>	:	(a) =
Indicated concentrations (a); (b), (c), (d), and the concentration when the NO _x analyser is in the NO mode so that the calibration gas does not pass through the converter		(b) =
		(c) =
		(d) =
		Concentration in NO mode =

Information from Annex XXI, Sub-Annex 6 to Regulation (EU) 2017/1151

The distance actually driven by the vehicle	:	
For manual shift transmission vehicle, MT vehicle that cannot follow the cycle trace: The deviations from the driving cycle	:	
<u>Drive trace indices:</u> The following indices shall be calculated in accordance with the standard SAE J2951(Revised Jan-2014): IWR: Inertial Work Rating RMSSE: Root Mean Squared Speed Error	:	
<u>Particulate sample filter weighing</u> Filter before the test Filter after the test Reference filter	:	
Content of each of the compounds measured after stabilization of the measuring device	:	

▼ M3

<u>Regeneration factor determination</u>	
The number of cycles D between two WLTCs where regeneration events occur	:
The number of cycles over which emission measurements are made n	:
The mass emissions measurement M'_{sij} for each compound i over each cycle j	:
<u>Regeneration factor determination</u>	:
The number of applicable test cycles d measured for complete regeneration	:
<u>Regeneration factor determination</u>	
Msi	:
Mpi	:
Ki	:

Information from Annex XXI, Sub-Annex 6a to Regulation (EU) 2017/1151

<u>ATCT</u>	:	Temperature set point = T_{reg} Actual temperature value $\pm 3\text{ }^{\circ}\text{C}$ at the start of the test $\pm 5\text{ }^{\circ}\text{C}$ during the test
The air temperature and humidity of the test cell measured at the vehicle cooling fan outlet at a minimum frequency of 0,1 Hz.		
The temperature of the soak area measured continuously at a minimum frequency of 0,033 Hz.	:	Temperature set point = T_{reg} Actual temperature value $\pm 3\text{ }^{\circ}\text{C}$ at the start of the test $\pm 5\text{ }^{\circ}\text{C}$ during the test
The time of transfer from the preconditioning to the soak area	:	≤ 10 minutes
The time between the end of the Type 1 test and the cool down procedure	:	≤ 10 minutes
The measured soaking time, and shall be recorded in all relevant test sheets.	:	time between the measurement of the end temperature and the end of the Type 1 test at $23\text{ }^{\circ}\text{C}$

Information from Annex VI to Regulation (EU) 2017/1151

<u>Diurnal testing</u>	:	
Ambient temperature during the two diurnal cycles (recorded at least every minute)		
<u>Canister puff loss loading</u>	:	
Ambient temperature during the first 11-hour profile (recorded at least every 10 minutes)		

▼ **M3***Appendix 8d***Evaporative emission test report**

The following information, if applicable, is the minimum data required for the evaporative emission test.

REPORT number

APPLICANT		
Manufacturer		
SUBJECT	...	
Evaporative family identifier	:	
Object submitted to tests		
	Make	:
CONCLUSION	The object submitted to tests complies with the requirements mentioned in the subject.	

PLACE,	DD/MM/YYYY
--------	------------

Every Technical Service is free to include additional information

1. DESCRIPTION OF TESTED VEHICLE HIGH

Vehicle numbers	:	Prototype number and VIN
Category	:	

1.1. Powertrain Architecture

Powertrain architecture	:	internal combustion, hybrid, electric or fuel cell
-------------------------	---	--

1.2. Internal combustion engine

For more than one ICE, please repeat the point

Make	:	
Type	:	
Working principle	:	two/four stroke
Cylinders number and arrangement	:	
Engine capacity (cm ³)	:	
Supercharging	:	yes/no
Direct injection	:	yes/no or description
Vehicle fuel type	:	Monofuel / bifuel / flex fuel
Engine lubricant	:	Make and type
Cooling system	:	Type: air/water/oil

▼ **M3**1.4. **Fuel system**

Injection pump	:	
Injector(s)	:	
Fuel tank		
Layer(s)	:	monolayer/ multilayer
Material for the fuel tank	:	metal / ...
Material for other parts of the fuel system	:	...
Sealed	:	yes/no
Nominal tank capacity (l)	:	
Canister		
Make and type	:	
Type of activated carbon	:	
Volume of charcoal (l)	:	
Mass of charcoal (g)	:	
Declared BWC (g)	:	xx,x

2. TEST RESULTS

2.1. **Canister bench ageing**

Date of tests	:	(day/month/year)
Place of the test	:	
Canister ageing test report	:	
Loading rate	:	
Fuel specification		
Make	:	
Density at 15 °C (kg/m ³)	:	
Ethanol content (%)	:	
Batch number	:	

2.2. **Determination of the permeability factor (PF)**

Date of tests	:	(day/month/year)
Place of the test	:	
Permeability factor test report	:	
HC measured at week 3, HC _{3w} (mg/24 h)	:	xxx
HC measured at week 20, HC _{20w} (mg/24 h)	:	xxx
Permeability Factor, PF (mg/24 h)	:	xxx

▼ **M3**

In case of multilayer tanks or metal tanks

Alternative Permeability Factor, PF (mg/24 h)	:	yes/no
---	---	--------

2.3. Evaporative test

Date of tests	:	(day/month/year)
Place of the test	:	
Method of chassis dyno setting	:	Fixed run / iterative / alternative with its own warmup cycle
Dynamometer operation mode	:	yes/no
Coastdown mode	:	yes/no

2.3.1. Mass

Test mass of VH (kg)	:	
----------------------	---	--

2.3.2. Roadload parameters

f_0 (N)	:	
f_1 (N/(km/h))	:	
f_2 (N/(km/h) ²)	:	

2.3.3. Cycle and Gear shift point (if applicable)

Cycle (without downscaling)	:	Class 1 / 2 / 3
Gear shifting	:	Average gear for $v \geq 1$ km/h, rounded to four places of decimal

2.3.4. Vehicle

Tested vehicle	:	VH or description
Mileage (km)	:	
Age (weeks)	:	

2.3.5. Procedure of test and results

Test procedure	:	Continuous (sealed fuel tank systems) / Continuous (non-sealed fuel tank systems) / Stand-alone (sealed fuel tank systems)
Description of soak periods (time and temperature)	:	
Puff loss loading value (g)	:	xx,x (if applicable)

Evaporative test	hot soak, M_{HS}	1st 24h diurnal, M_{D1}	2nd 24h diurnal, M_{D2}
Mean temperature (°C)		—	—
Evaporative emission (g/test)	x,xxx	x,xxx	x,xxx
Final result, $M_{HS} + M_{D1} + M_{D2} + (2 \times PF)$ (g/test)		x,xx	
Limit (g/test)		2,0	

▼B*ANNEX II***▼M3**

PART A

▼B**IN-SERVICE CONFORMITY**

1. INTRODUCTION

▼M3

- 1.1. This Part shall apply to M and N1 class I vehicles based on types approved until 31 December 2018 and registered until 31 August 2019 and to N1 classes II and III and N2 vehicles based on types approved until 31 August 2019 and registered until 31 August 2020.

▼B

2. REQUIREMENTS

The in-service conformity requirements shall be those specified in paragraph 9 and Appendices 3, 4 and 5 of UN/ECE Regulation No 83 with exceptions described in the following sections.

- 2.1. Paragraph 9.2.1. of UN/ECE Regulation No 83 shall be understood as being as follows:

The audit of in-service conformity by the approval authority shall be conducted on the basis of any relevant information that the manufacturer has, under the same procedures as those for the conformity of production defined in Article 12(1) and (2) of Directive 2007/46/EC and in points 1 and 2 of Annex X to that Directive. If information is provided to the approval authority from any approval authority or Member State surveillance testing, it shall complement the in-service monitoring reports supplied by the manufacturer.

- 2.2. Paragraph 9.3.5.2 of UN/ECE Regulation No 83 shall be amended with the addition of the following new sub-paragraph:

‘...’

Vehicles of small series productions with less than 1 000 vehicles per OBD family are exempted from minimum IUPR requirements as well as the requirement to demonstrate these to the approval authority.’

- 2.3. References to ‘Contracting Parties’ shall be understood as references to ‘Member States’.

- 2.4. Paragraph 2.6. of Appendix 3 to UN/ECE Regulation No 83 shall be replaced with the following:

The vehicle shall belong to a vehicle type that is type-approved under this Regulation and covered by a certificate of conformity in accordance with Directive 2007/46/EC. It shall be registered and have been used in the Union.

- 2.5. The reference in paragraph 2.2. of Appendix 3 to UN/ECE Regulation No 83 to the ‘1958 Agreement’ shall be understood as reference to Directive 2007/46/EC.

- 2.6. Paragraph 2.6. of Appendix 3 to UN/ECE Regulation No 83 shall be replaced with the following:

The lead content and sulphur content of a fuel sample from the vehicle tank shall meet the applicable standards laid down in Directive 2009/30/EC of the European Parliament and of the Council⁽¹⁾ and there shall be no evidence of mis-fuelling. Checks may be done in the tailpipe.

- 2.7. Reference in paragraph 4.1. of Appendix 3 to UN/ECE Regulation No 83 to ‘emissions tests in accordance with Annex 4a’ shall be understood as being to ‘emissions tests conducted in accordance with Annex XXI to this Regulation’.

⁽¹⁾ OJ L 140, 5.6.2009, p. 88.

▼ B

- 2.8. Reference in paragraph 4.1. of Appendix 3 to UN/ECE Regulation No 83 to ‘paragraph 6.3. of Annex 4a’ shall be understood as being to ‘paragraph 1.2.6. of Sub-Annex 6 to Annex XXI to this Regulation’.
- 2.9. Reference in paragraph 4.4. of Appendix 3 to UN/ECE Regulation No 83 to ‘the 1958 Agreement’ shall be understood as reference to ‘Article 13(1) or (2) of Directive 2007/46/EC’.

▼ M3

- 2.10. In paragraph 3.2.1., paragraph 4.2. and footnotes 1 and 2 of Appendix 4 to UN/ECE Regulation No 83, the reference to the limit values given in Table 1 of paragraph 5.3.1.4. shall be understood as reference to Table 2 of Annex I to Regulation (EC) No 715/2007.

PART B

NEW IN-SERVICE CONFORMITY METHODOLOGY

1. Introduction

This Part shall apply to M and N1 class I vehicles based on types approved after 1 January 2019 and to all vehicles registered after 1 September 2019 and to N1 classes II and III and N2 vehicles based on types approved after 1 September 2019 and registered after 1 September 2020.

It sets out the in-service conformity (ISC) requirements for checking compliance against the emission limits for tailpipe (including low temperature) and evaporative emissions throughout the normal life of the vehicle up to five years or 100 000 km, whichever is sooner.

2. Process description

Figure B.1

Illustration of the in-service conformity process (where GTAA refers to the granting type approval authority and OEM refers to the manufacturer)

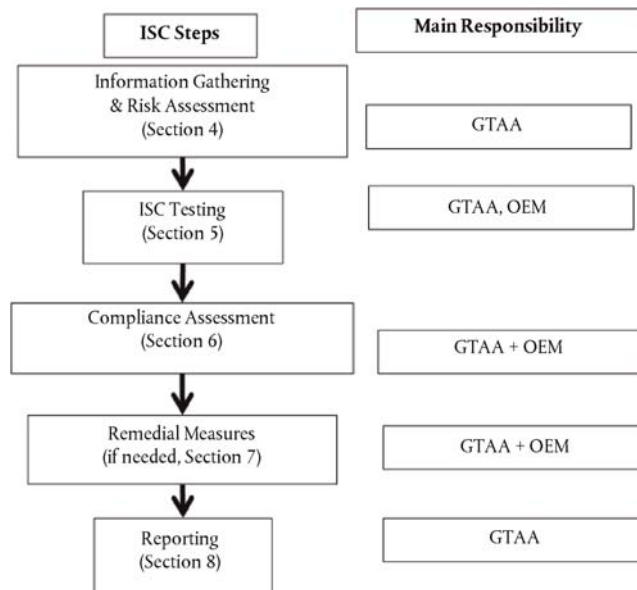

▼ M3

3. ISC family definition

An ISC family shall be composed of the following vehicles:

- (a) For tailpipe emissions (Type 1 and Type 6 tests), the vehicles covered by the PEMS test family, as described in Appendix 7 of Annex IIIA,
- (b) For evaporative emissions (Type 4 test), the vehicles included in the evaporative emission family, as described in Point 5.5 of Annex VI.

4. Information gathering and initial risk assessment

The granting type approval authority shall gather all relevant information on possible emission non-compliances relevant for deciding which ISC families to check in a particular year. The granting type-approval authority shall take into account in particular information indicating vehicle types with high emissions in real driving conditions. That information shall be obtained through the use of appropriate methods, which may include remote sensing, simplified on-board emissions monitoring systems (SEMS) and testing with PEMS. The number and importance of exceedances observed during such testing may be used to prioritise ISC testing.

As part of the information provided for the ISC checks, each manufacturer shall report to the granting type approval authority on emission-related warranty claims, and any emission-related warranty repair works performed or recorded during servicing, in accordance with a format agreed between the granting type approval authority and the manufacturer at type approval. The information shall detail the frequency and nature of faults for emissions-related components and systems by ISC family. The reports shall be filed at least once a year for each vehicle ISC family for the duration of the period during which in-service conformity checks are to be performed in accordance with Article 9(3).

On the basis of the information referred to in the first and second paragraphs, the granting type approval authority shall make an initial assessment of the risk of an ISC family to not comply with the in-service conformity rules and on that basis shall take a decision on which families to test and which types of tests to perform under the ISC provisions. Additionally, the granting type approval authority may randomly choose ISC families to test.

5. ISC testing

The manufacturer shall perform ISC testing for tailpipe emissions comprising at least the Type 1 test for all ISC families. The manufacturer may also perform RDE, Type 4 and Type 6 tests for all or part of the ISC families. The manufacturer shall report to the granting type approval authority all results of the ISC testing using the Electronic Platform for in-service conformity described in point 5.9.

The granting type approval authority shall check an appropriate number of ISC families each year, as set out in point 5.4. The granting type approval authority shall include all results of the ISC testing in the Electronic Platform for in-service conformity described in point 5.9.

▼ M3

Accredited laboratories or technical services may perform checks on any number of ISC families each year. The accredited laboratories or technical services shall report to the granting type approval authority all results of the ISC testing using the Electronic Platform for in-service conformity described in point 5.9.

5.1. Quality assurance of testing

Inspection bodies and laboratories performing ISC checks, that are not a designated technical service, shall be accredited according to EN ISO/IEC 17020:2012 for the ISC procedure. Laboratories performing ISC tests and which are not designated technical services within the meaning of Article 41 of Directive 2007/46, may only undertake ISC testing if they are accredited according to EN ISO/IEC 17025:2017.

The granting type approval authority shall annually audit the ISC checks performed by the manufacturer. The granting type approval authority may also audit the ISC checks performed by accredited laboratories and technical services. The audit shall be based on the information provided by the manufacturers, accredited laboratory or technical service which shall include at least the detailed ISC report in accordance with Appendix 3. The granting type approval authority may require the manufacturers, accredited laboratories or technical services to provide additional information.

5.2. Disclosure of tests results by accredited laboratories and technical services

The granting type approval authority shall communicate the results of the compliance assessment and remedial measures for a particular ISC family to the accredited laboratories or technical services which provided test results for that family as soon as they become available.

The results of the tests, including the detailed data for all vehicles tested, may only be disclosed to the public after the publication by the granting type approval authority of the annual report or the results of an individual ISC procedure or after the closure of the statistical procedure (see point 5.10.) without a result. If the results of the ISC tests are published, reference shall be made to the annual report by the granting type approval authority which included them.

5.3. Types of tests

ISC testing shall only be performed on vehicles selected in accordance with Appendix 1.

ISC testing with the Type 1 test shall be performed in accordance with Annex XXI.

ISC testing with the RDE tests shall be performed in accordance with Annex IIIA, Type 4 tests shall be performed in accordance with Appendix 2 to this Annex and Type 6 tests shall be performed in accordance with Annex VIII.

5.4. Frequency and scope of ISC testing

The time period between commencing two in-service conformity checks by the manufacturer for a given ISC family shall not exceed 24 months.

▼ M3

The frequency of ISC testing performed by the granting type approval authority shall be based on a risk assessment methodology consistent with the international standard ISO 31000:2018 — Risk Management — Principles and guidelines which shall include the results of the initial assessment made according to point 4.

As of 1 January 2020, granting type approval authorities shall perform the Type 1 and RDE tests on a minimum of 5 % of the ISC families per manufacturer per year or at least two ISC families per manufacturer per year, where available. The requirement for testing a minimum of 5 % or at least two ISC families per manufacturer per year shall not apply to small volume manufacturers. The granting type approval authority shall ensure the widest possible coverage of ISC families and vehicle age in a particular in-service conformity family in order to ensure compliance according to Article 8, paragraph 3. The granting type approval authority shall complete the statistical procedure for each ISC family it has started within 12 months.

Type 4 or Type 6 ISC tests shall have no minimum frequency requirements.

5.5. Funding for ISC testing by the granting type approval authorities

The granting type approval authority shall ensure that sufficient resources are available to cover the costs for in-service conformity testing. Without prejudice to national law, those costs shall be recovered by fees that can be levied on the manufacturer by the granting type approval authority. Such fees shall cover ISC testing of up to 5 % of the in-service conformity families per manufacturer per year or at least two ISC families per manufacturer per year.

5.6. Testing plan

When performing RDE testing for ISC, the granting type approval authority shall draft a testing plan. That plan shall include testing to check ISC compliance under a wide range of conditions in accordance with Annex IIIA.

5.7. Selection of vehicles for ISC testing

The information gathered shall be sufficiently comprehensive to ensure that in-service performance can be assessed for vehicles that are properly maintained and used. The tables in Appendix 1 shall be used to decide whether the vehicle can be selected for the purposes of ISC testing. During the check against the tables in Appendix 1, some vehicles may be declared as faulty and not tested during ISC, when there is evidence that parts of the emission control system were damaged.

The same vehicle may be used to perform and establish reports from more than one type of tests (Type 1, RDE, Type 4, Type 6) but only the first valid test of each type shall be taken into account for the statistical procedure.

▼ M3

5.7.1. General requirements

The vehicle shall belong to an ISC family as described in point 3 and shall comply with the checks set out in the table in Appendix 1. It shall be registered in the Union and have been driven in the Union for at least 90 % of its driving time. The emissions testing may be done in a different geographical region from that where the vehicles have been selected.

The vehicles selected shall be accompanied by a maintenance record which shows that the vehicle has been properly maintained and has been serviced in accordance with the manufacturer's recommendations with only original parts used for the replacement of emissions related parts.

Vehicles exhibiting indications of abuse, improper use that could affect its emissions performance, tampering or conditions that may lead to unsafe operation shall be excluded from ISC.

The vehicles shall not have undergone aerodynamic modifications that cannot be removed prior to testing.

A vehicle shall be excluded from ISC testing if the information stored in the on-board computer shows that the vehicle was operated after a fault code was displayed and a repair was not carried out in accordance with manufacturer specifications.

A vehicle shall be excluded from ISC testing if the fuel from the vehicle tank does not meet the applicable standards laid down in Directive 98/70/EC of the European Parliament and of the Council ⁽¹⁾ or if there is evidence or record of fuelling with the wrong type of fuel.

5.7.2. Vehicle Examination and Maintenance

Diagnosis of faults and any normal maintenance necessary in accordance with Appendix 1 shall be performed on vehicles accepted for testing, prior to or after proceeding with ISC testing.

The following checks shall be carried out: OBD checks (performed before or after the test), visual checks for lit malfunction indicator lamps, checks on air filter, all drive belts, all fluid levels, radiator and fuel filler cap, all vacuum and fuel system hoses and electrical wiring related to the after-treatment system for integrity; checks on ignition, fuel metering and pollution control device components for maladjustments and/or tampering.

If the vehicle is within 800 km of a scheduled maintenance service, that service shall be performed.

The window washer fluid shall be removed before the Type 4 test and replaced with hot water.

A fuel sample shall be collected and kept in accordance with the requirements of Annex IIIA for further analysis in case of fail.

⁽¹⁾ Directive 98/70/EC of the European Parliament and of the Council of 13 October 1998 relating to the quality of petrol and diesel fuels and amending Council Directive 93/12/EEC (OJ L 350, p. 58).

▼ **M3**

All faults shall be recorded. When the fault is on the pollution control devices then the vehicle shall be reported as faulty and not be used further for testing, but the fault shall be taken into account for the purposes of the compliance assessment performed in accordance with point 6.1.

5.8. Sample size

When manufacturers apply the statistical procedure set out in point 5.10 for the Type 1 test, the number of sample lots shall be set on the basis of the annual sales volume of an in-service family in the Union, as described in the following table:

Table B.1

Number of sample lots for ISC testing with Type 1 tests

EU Registrations per calendar year of vehicles in the sampling period	Number of sample lots (for Type 1 tests)
up to 100 000	1
100 001 to 200 000	2
above 200 000	3

Each sample lot shall include enough vehicle types, in order to ensure that at least 20 % of the total family sales are covered. When a family requires more than one sample lot to be tested, the vehicles in the second and third sample lots shall reflect different vehicle use conditions from those selected for the first sample.

5.9. Use of the Electronic Platform for in-service conformity and access to data required for testing

The Commission shall set up an electronic platform in order to facilitate the exchange of data between on the one side, the manufacturers, accredited labs or technical services and on the other side the granting type approval authority and the taking of the decision on the sample fail or pass.

The manufacturer shall complete the package on Testing Transparency referred to in Article 5 (12) in the format specified in Tables 1 and 2 of Appendix 5 and in the Table in this point and transmit it to the type-approval authority which grants the emission type-approval. Table 2 of Appendix 5 shall be used in order to allow the selection of vehicles from the same family for testing and along with the Table 1 provide sufficient information for vehicles to be tested.

Once the electronic platform referred to in the first paragraph becomes available, the type-approval authority which grants the emission type-approval shall upload the information in Tables 1 and 2 of Appendix 5 to this platform within 5 working days of receiving it.

All information in Tables 1 and 2 of Appendix 5 shall be accessible to the public in an electronic form free of charge.

The following information shall also be part of the package on Testing Transparency and shall be provided by the manufacturer free-of-charge within 5 working days of the request by an accredited laboratory or technical service.

▼ M3

ID	Input	Description
1.	Special Procedure for conversion of vehicles (4WD to 2WD) for dyno testing if available	As defined in Sub-Annex 6 of Annex XXI; point 2.4.2.4.
2.	Dyno mode instructions, if available	How to enable the dyno mode as done also during TA tests
3.	Coastdown mode used during the TA tests	If the vehicle has coastdown mode instructions how to enable this mode
4.	Battery discharge procedure (OVC-HEV, PEV)	OEM procedure to deplete battery for preparing OVC-HEV for charge sustaining tests, and PEV to charge the battery
5.	Procedure to deactivate all auxiliaries	If used during TA

5.10. Statistical Procedure

5.10.1. General

The verification of in-service conformity shall rely on a statistical method following the general principles of sequential sampling for inspection by attributes. The minimum sample size for a pass result is three vehicles, and the maximum cumulative sample size is ten vehicles for the Type 1 and RDE tests.

For the Type 4 and Type 6 tests a simplified method may be used, where the sample shall consist of three vehicles and shall be considered a fail if all three vehicles fail to pass the test, and a pass if all three vehicles pass the test. In cases where two out of three passed or failed, the type approval authority may decide to conduct further tests or proceed with accessing the compliance in accordance with point 6.1.

Test results shall not be multiplied by deterioration factors.

For vehicles that have a Declared Maximum RDE Values reported in point 48.2 of the Certificate of Conformity, as described in Annex IX of Directive 2007/46/EC which is lower than the emission limits set out in Annex I to Regulation (EC) No 715/2007, the conformity shall be checked both against the Declared Maximum RDE Value increased by the margin set out in point 2.1.1 of Annex IIIA and the not-to-exceed limit set out in section 2.1. of that Annex. If the sample is found not to conform with the Declared Maximum RDE Values increased by the applicable measurement uncertainty margin, but pass with the not-to-exceed limit, the granting type approval authority shall require the manufacturer to take corrective actions.

▼ M3

Prior to the performance of the first ISC test, the manufacturer, accredited laboratory or technical service ('party') shall notify the intent of performing in-service conformity testing of a given vehicle family to the granting type approval authority. Upon this notification, the granting type approval authority shall open a new statistical folder to process the results for each relevant combination of the following parameters for that particular party/or that pool of parties: vehicle family, emissions test type and pollutant. Separate statistical procedures shall be opened for each relevant combination of those parameters.

The granting type approval authority shall incorporate in each statistical folder only the results provided by the relevant party. The granting type approval authority shall keep a record of the number of tests performed, the number of failed and passed tests and other necessary data to support the statistical procedure.

Whereas more than one statistical procedure can be open at the same time for a given combination of test type and vehicle family, a party shall only be allowed to provide test results to one open statistical procedure for a given combination of test type and vehicle family. Each test shall be reported only once and all tests (valid, not valid, fail or pass, etc.) shall be reported.

Each ISC statistical procedure shall remain open until an outcome is reached when the statistical procedure arrives to a pass or fail decision for the sample in accordance point 5.10.5. However, if an outcome is not reached within 12 months of the opening of a statistical folder, the granting type approval authority shall close the statistical folder unless it decides to complete testing for that statistical folder within the following 6 months.

5.10.2. Pooling of ISC results

Test results from two or more accredited laboratories or technical services may be pooled for the purposes of a common statistical procedure. The pooling of test results shall require the written consent from all the interested parties providing test results to a pool of results, and a notification to the granting type approval authority prior to the start of testing. One of the parties pooling test results shall be designated as leader of the pool and be responsible for data reporting and communication with the granting type approval authority.

5.10.3. Pass/Fail/Invalid outcome for a single test

An ISC emissions test shall be considered as 'passed' for one or more pollutants when the emissions result is equal or below the emission limit set out in Annex I of Regulation (EC) No 715/2007 for that type of test.

An emissions test shall be considered as 'failed' for one or more pollutants when the emissions result is greater than the corresponding emission limit for that type of test. Each failed test result shall increase the 'f' count (see point 5.10.5) by 1 for that statistical instance.

An ISC emissions test shall be considered invalid if it does not respect the test requirements referred to in point 5.3. Invalid test results shall be excluded from the statistical procedure.

▼ M3

The results of all ISC tests shall be submitted to the granting type approval authority within ten working days from the execution of each test. The test results shall be accompanied by a comprehensive test report at the end of the tests. The results shall be incorporated in the sample in chronological order of execution.

The granting type approval authority shall incorporate all valid emission test results to the relevant open statistical procedure until a 'sample fail' or a 'sample pass' outcome is reached in accordance with point 5.10.5.

5.10.4. Treatment of Outliers

The presence of outlying results in the sample statistical procedure may lead to a 'fail' outcome in accordance with the procedures described below:

Outliers shall be categorised as intermediate or extreme.

An emissions test result shall be considered as an intermediate outlier if it is equal or greater than 1,3 times the applicable emission limit. The presence of two such outliers in a sample shall lead to a fail of the sample.

An emissions result shall be considered as an extreme outlier if it is equal or greater than 2,5 times the applicable emission limit. The presence of one such outlier in a sample shall lead to a fail of the sample. In such case, the plate number of the vehicle shall be communicated to the manufacturer and to the granting type approval authority. This possibility shall be communicated to the vehicle owners before testing.

5.10.5. Pass/Fail decision for a sample

For the purposes of deciding on a pass/fail result for the sample, 'p' is the count of passed results, and 'f' is the count of failed results. Each passed test result shall increase the 'p' count by 1 and each failed test result shall increase the 'f' count by 1 for the relevant open statistical procedure.

Upon the incorporation of valid emission test results to an open instance of the statistical procedure, the type approval authority shall perform the following actions:

- update the cumulative sample size 'n' for that instance to reflect the total number of valid emissions tests incorporated to the statistical procedure;
- following an evaluation of the results, update the count of passed results 'p' and the count of failed results 'f';
- compute the number of extreme and intermediate outliers in the sample in accordance with point 5.10.4.
- check whether a decision is reached with the procedure described below.

The decision depends on the cumulative sample size 'n', the passed and failed result counts 'p' and 'f', as well as the number of intermediate and/or extreme outliers in the sample. For the decision on a pass/fail of an ISC sample the granting type approval authority shall use the decision chart in Figure B.2 for vehicles based on types approved as of

▼ **M3**

1 January 2020 and the decision chart in Figure B.2.a for vehicles based on types approved until 31 December 2019. The charts indicate the decision to be taken for a given cumulative sample size 'n' and failed count result 'f'.

Two decisions are possible for a statistical procedure for a given combination of vehicle family, emissions test type and pollutant:

'Sample pass' outcome shall be reached when the applicable decision chart from Figure B.2 or Figure B.2.a gives a 'PASS' outcome for the current cumulative sample size 'n' and the count of failed results 'f'.

'Sample fail' decision shall be reached when, for a given cumulative sample size 'n', when at least one of the following conditions is fulfilled:

- the applicable decision chart from Figure B.2 or Figure B.2.a gives a 'FAIL' decision for the current cumulative sample size 'n' and the count of failed results 'f'.
- there are two intermediate outliers;
- there is one extreme outlier.

If no decision is reached, the statistical procedure shall remain open and further results shall be incorporated into it until a decision is reached or the procedure is closed in accordance with point 5.10.1.

Figure B.2

Decision chart for the statistical procedure for vehicles based on types approved as of 1 January 2020 (where 'UND' means undecided)

Failed result count f	10							FAIL
	9						FAIL	FAIL
	8					FAIL	FAIL	FAIL
	7				FAIL	FAIL	FAIL	FAIL
	6			FAIL	FAIL	FAIL	FAIL	FAIL
	5		FAIL	FAIL	FAIL	UND	UND	PASS
	4		FAIL	FAIL	UND	UND	UND	PASS
	3	FAIL	FAIL	UND	UND	UND	UND	PASS
	2	UND	UND	UND	UND	PASS	PASS	PASS
	1	UND	PASS	PASS	PASS	PASS	PASS	PASS
	0	PASS	PASS	PASS	PASS	PASS	PASS	PASS
	3	4	5	6	7	8	9	10
Cumulative sample size n								

▼ M3

Figure B.2.a

Decision chart for the statistical procedure for vehicles type approved until 31 December 2019 (where 'UND' means undecided)

Failed result count f	10							FAIL
	9						FAIL	FAIL
	8					FAIL	FAIL	FAIL
	7				FAIL	FAIL	FAIL	FAIL
	6			FAIL	FAIL	FAIL	FAIL	FAIL
	5		FAIL	UND	UND	UND	UND	PASS
	4	UND	UND	UND	UND	UND	PASS	PASS
	3	UND	UND	UND	UND	UND	PASS	PASS
	2	UND	UND	UND	PASS	PASS	PASS	PASS
	1	UND	PASS	PASS	PASS	PASS	PASS	PASS
	0	PASS	PASS	PASS	PASS	PASS	PASS	PASS
	3	4	5	6	7	8	9	10

Cumulative sample size n

5.10.6. ISC for completed vehicles and special purpose vehicles

The manufacturer of the base vehicle shall determine the allowed values for the parameters listed in Table B.3. The allowed Parameter Values for each family shall be recorded in the information document of the emissions type approval (see Appendix 3 to Annex I) and in the Transparency list 1 of Appendix 5 (rows 45 to 48). The second-stage manufacturer shall only be allowed to use the base vehicle emission values if the completed vehicle remains within the allowed Parameter Values. The parameter values for each completed vehicle shall be recorded in its Certificate of Conformity.

Table B.3

Allowed Parameter Values for multistage and special purpose vehicles to use the base vehicle emission type approval

Parameter Values:	Allowed values from - to:
Final Vehicle mass in running order (in kg)	
Frontal area for final vehicle (in cm ²)	
Rolling resistance (kg/t)	
Projected frontal area of air entrance of the front grille (in cm ²)	

If a completed or special purpose vehicle is tested and the result of the test is below the applicable emission limit, the vehicle shall be considered as a pass for the ISC family for the purposes of point 5.10.3.

▼ M3

If the result of the test on a completed or special purpose vehicle exceeds the applicable emission limits but is not higher than 1,3 times the applicable emission limits, the tester shall examine whether that vehicle complies with the values in table B.3. Any non-compliance with these values shall be reported to the granting type approval authority. If the vehicle does not comply with those values, the granting type approval authority shall investigate the reasons for the non-compliance and take the appropriate measures regarding the manufacturer of the completed or special purpose vehicle to restore conformity, including the withdrawal of the type-approval. If the vehicle complies with the values in table B.3, it shall be considered as a flagged vehicle for the in-service conformity family for the purposes of point 6.1.

If the result of the test exceeds 1,3 times the applicable emission limits, shall be considered as a fail for the in-service conformity family for the purposes of point 6.1., but not as an outlier for the relevant ISC family. If the completed or special purpose vehicle does not comply with the values in table B.3, this shall be reported to the granting type approval authority, who shall investigate the reasons for the non-compliance and take the appropriate measures regarding the manufacturer of the completed or special purpose vehicle to restore conformity, including the withdrawal of the type-approval.

6. Compliance Assessment

- 6.1. Within 10 days of the end of the ISC testing for the sample as referred to in point 5.10.5, the granting type approval authority shall start detailed investigations with the manufacturer in order to decide whether the ISC family (or part of it) complies with the ISC rules and whether it requires remedial measures. For multistage or special purpose vehicles the granting type approval authority shall also perform detailed investigations when there are at least three faulty vehicles with the same fault or five flagged vehicles in the same ISC family, as set out in point 5.10.6.
- 6.2. The granting type approval authority shall ensure that sufficient resources are available to cover the costs for compliance assessment. Without prejudice to national law, those costs shall be recovered by fees that can be levied on the manufacturer by the granting type approval authority. Such fees shall cover all testing or auditing needed in order for an assessment on compliance to be reached.
- 6.3. On the request of the manufacturer, the granting type approval authority may extend the investigations to vehicles in service of the same manufacturer belonging to other ISC families which are likely to be affected by the same defects.
- 6.4. The detailed investigation shall take no more than 60 working days after the start of the investigation by the granting type approval authority. The granting type approval authority may conduct additional ISC tests designed to determine why vehicles have failed during the original ISC tests. The additional tests shall be conducted under similar conditions as the original ISC failed tests.

▼ M3

Upon the request of the granting type approval authority, the manufacturer shall provide additional information, showing in particular the possible cause of the failures, which parts of the family might be affected, whether other families might be affected, or why the problem which caused the failure at the original ISC tests is not related to in-service conformity, if applicable. The manufacturer shall be given the opportunity to prove that the in-service conformity provisions have been complied with.

- 6.5. Within the deadline set out in point 6.3, the granting type approval authority shall take a decision on the compliance and the need to apply remedial measures for the ISC family covered by the detailed investigations and shall notify it to the manufacturer.

7. Remedial Measures

- 7.1. The manufacturer shall establish a plan of remedial measures and submit it to the granting type approval authority within 45 working days of the notification referred to in point 6.4. That period may be extended by up to an additional 30 working days where the manufacturer demonstrates to the granting type approval authority that further time is required to investigate the non-compliance.

- 7.2. The remedial measures required by the granting type approval authority shall include reasonably designed and necessary tests on components and vehicles in order to demonstrate the effectiveness and durability of the remedial measures.

- 7.3. The manufacturer shall assign a unique identifying name or number to the plan of remedial measures. The plan of remedial measures shall include at least the following:

- (a) a description of each vehicle emission type included in the plan of remedial measures;
- (b) a description of the specific modifications, alterations, repairs, corrections, adjustments or other changes to be made to bring the vehicles into conformity including a brief summary of the data and technical studies which support the decision of the manufacturer as to the particular remedial measures to be taken;
- (c) a description of the method by which the manufacturer will inform the vehicle owners of the planned remedial measures;
- (d) a description of the proper maintenance or use, if any, which the manufacturer stipulates as a condition of eligibility for repair under the plan of remedial measures, and an explanation of the need for such condition;
- (e) a description of the procedure to be followed by vehicle owners to obtain correction of the non-conformity; that description shall include a date after which the remedial measures shall be taken, the estimated time for the workshop to perform the repairs and where they can be done;
- (f) an example of the information transmitted to the vehicle owner;
- (g) a brief description of the system which the manufacturer uses to assure an adequate supply of component or systems for fulfilling the remedial action, including information on when an adequate supply of the components, software or systems needed to initiate the application of remedial measures will be available;

▼ M3

- (h) an example of all instructions to be sent to the repair shops which will perform the repair;
- (i) a description of the impact of the proposed remedial measures on the emissions, fuel consumption, driveability, and safety of each vehicle emission type, covered by the plan of remedial measures, including supporting data and technical studies;
- (j) where the plan of remedial measures includes a recall, a description of the method for recording the repair shall be submitted to the granting type approval authority. If a label is used, an example of it shall also be submitted.

For the purposes of point (d), the manufacturer may not impose maintenance or use conditions which are not demonstrably related to the non-conformity and the remedial measures.

- 7.4. The repair shall be done expeditiously, within a reasonable time after the vehicle is received by the manufacturer for repair. Within 15 working days of receiving the proposed plan of remedial measures, the granting type approval authority shall approve it or require a new plan in accordance with point 7.5.
- 7.5. When the granting type approval authority does not approve the plan of remedial measures, the manufacturer shall develop a new plan and submit it to the granting type approval authority within 20 working days of notification of the decision of the granting type approval authority.
- 7.6. If the granting type approval authority does not approve the second plan submitted by the manufacturer, it shall take all appropriate measures, in accordance with Article 30 of Directive 2007/46/EC, to restore conformity, including withdrawal of type approval where necessary.
- 7.7. The granting type approval authority shall notify its decision to all Member States and the Commission within 5 working days.
- 7.8. The remedial measures shall apply to all vehicles in the ISC family (or other relevant families identified by the manufacturer in accordance with point 6.2) that are likely to be affected by the same defect. The granting type approval authority shall decide if it is necessary to amend the type approval.
- 7.9. The manufacturer is responsible for the execution of the approved plan of remedial measures in all Member States and for keeping a record of every vehicle removed from the market or recalled and repaired and the workshop which performed the repair.
- 7.10. The manufacturer shall keep a copy of the communication with the customers of affected vehicles related to the plan of remedial measures. The manufacturer shall also maintain a record of the recall campaign, including the total number of vehicles affected per Member State and the total number of vehicles already recalled per Member State, along with an explanation of any delays in the application of the remedial measures. The manufacturer shall provide that record of the recall campaign to the granting type approval authority, the type approval authorities of each Member State and the Commission every two months.
- 7.11. Member States shall take measures to ensure that the approved plan of remedial measures is applied within two years to at least 90 % of affected vehicles registered in their territory.

▼ M3

7.12. The repair and modification or addition of new equipment shall be recorded in a certificate provided to the vehicle owner, which shall include the number of the remedial campaign.

8. Annual report by the granting type approval authority

The granting type approval authority shall make available on a publicly accessible website, free of charge and without the need for the user to reveal their identity or sign up, a report with the results of all the finalised ISC investigations of the previous year, at the latest by the 31 March of each year. In case some ISC investigations of the previous year are still open by that date, they shall be reported as soon as the investigation is finalised. The report shall contain at least the items listed in Appendix 4.

▼ M3

Appendix 1

Criteria for vehicle selection and failed vehicles decision

Selection of Vehicles for In Service Conformity Emissions Testing

Confidential

Date:			x
Name of investigator:			x
Location of test:			x
Country of registration (in EU only):		x	

Vehicle Characteristics

x = Exclusion Criteria X = Checked and reported

Registration plate number:		x	x
Mileage: <i>The vehicle must have between 15 000 km (or 30 000 km for testing evaporative emissions) and 100 000 km</i>	x		
Date of first registration: <i>The vehicle must be between 6 months (or 12 months for testing evaporative emissions) and 5 years old</i>	x		
VIN:		x	
Emission class and character:		x	
Country of registration: <i>The vehicle must be registered in the EU</i>	x	x	
Model:		x	
Engine code:		x	
Engine volume (l):		x	
Engine power (kW):		x	
Gearbox type (auto/manual):		x	
Drive axle (FWD/AWD/RWD):		x	
Tyre size (front and rear if different):		x	
Is the vehicle involved in a recall or service campaign? If yes: Which one? Has the campaign repairs already been done? <i>The repairs must have been done</i>	x	x	

▼ M3**Vehicle Owner Interview**

(the owner will only be asked the main questions and shall have no knowledge of the implications of the replies)

Name of the owner (only available to the accredited inspection body or laboratory/technical service)			x
Contact (address / telephone) (only available to the accredited inspection body or laboratory/technical service)			x
How many owners did the vehicle have?		x	
Did the odometer not work? <i>If yes, the vehicle cannot be selected.</i>	x		
Was the vehicle used for one of the following?			
As car used in show-rooms?		x	
As a taxi?		x	
As delivery vehicle?		x	
For racing / motor sports?	x		
As a rental car?		x	
Has the vehicle carried heavy loads over the specifications of the manufacturer? <i>If yes, the vehicle cannot be selected.</i>	x		
Have there been major engine or vehicle repairs?		x	
Have there been unauthorised major engine or vehicle repairs? <i>If yes, the vehicle cannot be selected.</i>	x		
Has there been a power increase/tuning? <i>If yes, the vehicle cannot be selected.</i>	x		
Was any part of the emissions after-treatment and/or the fuel system replaced? Were original parts used? <i>If original parts were not used, the vehicle cannot be selected.</i>	x	x	
Was any part of the emissions after-treatment system permanently removed? <i>If yes, the vehicle cannot be selected</i>	x		
Were there any unauthorised devices installed (Urea killer, emulator, etc)? <i>If yes, the vehicle cannot be selected</i>	x		

▼ M3

Was the vehicle involved in a serious accident? Provide a list of damage and repairs done afterwards		x	
Has the car been used with a wrong fuel type (i.e. gasoline instead of diesel) in the past? Has the car been used with non-commercially available EU-quality fuel (black market, or blended fuel?) <i>If yes, the vehicle cannot be selected.</i>	x		
Did you use air-fresher, cockpit-spray, brake cleaner or other high hydrocarbon emission source around the vehicle during the last month? <i>If yes, the vehicle cannot be selected for evaporative testing.</i>	x		
Was there a gasoline spill in the inside or outside of the vehicle during the last 3 months? <i>If yes, the vehicle cannot be selected for evaporative testing.</i>	x		
Did anyone smoke in the car during the last 12 months? <i>If yes, the vehicle cannot be selected for evaporative testing</i>	x		
Did you apply corrosion protection, stickers, under seal protection, on any other potential sources of volatile compounds to the car? <i>If yes, the vehicle cannot be selected for evaporative testing</i>	x		
Was the car repainted? <i>If yes, the vehicle cannot be selected for evaporative testing</i>	x		
Where do you use your vehicle more often?			
% motorway		x	
% rural		x	
% urban		x	
Did you drive the vehicle in a non EU Member State for more than 10 % of driving time? <i>If yes, the vehicle cannot be selected</i>	x	—	
In which country was the vehicle refuelled during the last two times? <i>If the vehicle was refuelled the last two times outside a state applying the EU Fuel Standards, the vehicle cannot be selected.</i>	x		
Has a fuel additive, not approved by the manufacturer been used? <i>If yes then the vehicle cannot be selected.</i>	x		
Has the vehicle been maintained and used in accordance with the manufacturer's instructions? <i>If not, the vehicle cannot be selected.</i>	x		

▼ **M3**

Full service and repair history including any re-works <i>If the full documentation cannot be provided, the vehicle cannot be selected.</i>	x		
---	---	--	--

Vehicle Examination and Maintenance

X = Exclusion Criteria/
F = Faulty Vehicle

X = checked and
reported

1	Fuel tank level (full / empty) Is the fuel reserve light ON? <i>If yes, refuel before test.</i>		x
2	Are there any warning lights on the instrument panel activated indicating a vehicle or exhaust after-treatment system malfunctioning that cannot be resolve by normal maintenance? (Malfunction Indication Light, Engine Service Light, etc?) <i>If yes, the vehicle cannot be selected</i>	x	
3	Is the SCR light on after engine-on? <i>If yes, the AdBlue should be filled in, or the repair executed before the vehicle is used for testing.</i>	x	
4	Visual inspection exhaust system Check leaks between exhaust manifold and end of tailpipe. Check and document (with photos) <i>If there is damage or leaks, the vehicle is declared faulty.</i>	F	
5	Exhaust gas relevant components Check and document (with photos) all emissions relevant components for damage. <i>If there is damage, the vehicle is declared faulty.</i>	F	
6	Evap system Pressurize fuel-system (from canister side), testing for leaks in a constant ambient temperature environment, FID sniff test around and in the vehicle. <i>If the FID sniff test is not passed, the vehicle is declared faulty.</i>	F	
7	Fuel sample Collect fuel sample from the fuel tank.		x

▼ M3

8	<p>Air filter and oil filter</p> <p>Check for contamination and damage and change if damaged or heavily contaminated or less than 800 km before the next recommended change.</p>		x
9	<p>Window washer fluid (only for evaporative testing)</p> <p>Remove window washer fluid and fill tank with hot water.</p>		x
10	<p>Wheels (front & rear)</p> <p>Check whether the wheels are freely moveable or blocked by the brake.</p> <p><i>If not, the vehicle cannot be selected.</i></p>	x	
11	<p>Tyres (only for evaporative testing)</p> <p>Remove spare tyre, change to stabilised tyres if the tyres were changes less than 15 000 km ago. Use summer and all season tyres only.</p>		x
12	<p>Drive belts & cooler cover</p> <p><i>In case of damage, the vehicle is declared faulty. Document with photos</i></p>	F	
13	<p>Check fluid levels</p> <p>Check the max. and min. levels (engine oil, cooling liquid) / top up if below minimum</p>		x
14	<p>Filler flap (only for evaporative testing)</p> <p>Check overfill line within filler flap is completely free of residues or flush the hose with hot water.</p>		x
15	<p>Vacuum hoses and electrical wiring</p> <p>Check all for integrity. <i>In case of damage, the vehicle is declared faulty. Document with photos</i></p>	F	
16	<p>Injection valves / cabling</p> <p>Check all cables and fuel lines. <i>In case of damage, the vehicle is declared faulty. Document with photos</i></p>	F	
17	<p>Ignition cable (gasoline)</p> <p>Check spark plugs, cables, etc. In case of damage, replace them.</p>		x

▼ **M3**

18	EGR & Catalyst, Particle Filter Check all cables, wires and sensors. <i>In case of tampering, the vehicle cannot be selected.</i> <i>In case of damage the vehicle is declared Faulty, Document with photos</i>	x/F	
19	Safety condition Check tyres, vehicle's body, electrical and braking system status are in safe conditions for the test and respect road traffic rules. <i>If not, the vehicle cannot be selected.</i>	x	
20	Semi-trailer Are there electric cables for semi-trailer connection, where required?		x
21	Aerodynamic modifications Verify no aftermarket aerodynamics modification that cannot be removed before testing was made (roof boxes, load racking, spoilers, etc.) and no standard aerodynamics components are missing (front deflectors, diffusers, splitters, etc.). <i>If yes, the vehicle cannot be selected. Document with photos.</i>	x	
22	Check if less than 800 km away from next scheduled service, if yes, then perform the service.		x
23	All checks requiring OBD connections to be performed before and/or after the end of testing		
24	Powertrain Control Module calibration part number and checksum		x
25	OBD diagnosis (before or after the emissions test) Read Diagnostic Trouble Codes & Print error log		x
26	OBD Service Mode 09 Query (before or after the emissions test) Read Service Mode 09. Record the information.		x
27	OBD mode 7 (before or after the emissions test) Read Service Mode 07. Record the information		

Remarks for: Repair / replacement of components / part numbers

▼ M3*Appendix 2***Rules for performing Type 4 tests during in-service conformity**

Type 4 tests for in-service conformity shall be performed in accordance with Annex VI (or Annex VI of Regulation (EC) No 692/2008 where applicable), with the following exceptions:

- Vehicles tested with the Type 4 test shall be at least 12 months of age.
- The canister shall be considered aged and therefore the Canister Bench Ageing procedure shall not be followed.
- The canister shall be loaded outside the vehicle, following the procedure described for this purpose in Annex VI and shall be removed and mounted to the vehicle following the repair instructions of the manufacturer. An FID sniff test (with results less than 100 ppm at 20 °C) shall be made as close as possible to the canister before and after the loading to confirm that the canister is mounted properly.
- The tank shall be considered aged and therefore no Permeability Factor shall be added in the calculation of the result of the Type 4 test.

▼ M3*Appendix 3***Detailed ISC report**

The following information shall be included in the detailed ISC report:

1. the name and address of the manufacturer;
2. the name, address, telephone and fax numbers and e-mail address of the responsible testing laboratory;
3. the model name(s) of the vehicles included in the test plan;
4. where appropriate, the list of vehicle types covered within the manufacturer's information, i.e. for tailpipe emissions, the in-service family group;
5. the numbers of the type approvals applicable to these vehicle types within the family, including, where applicable, the numbers of all extensions and field fixes/recalls (re-works);
6. details of extensions, field fixes/recalls to those type approvals for the vehicles covered within the manufacturer's information (if requested by the approval authority);
7. the period of time over which the information was collected;
8. the vehicle build period covered (e.g. vehicles manufactured during the 2017 calendar year);
9. the ISC checking procedure, including:
 - (i) vehicle sourcing method;
 - (ii) vehicle selection and rejection criteria (including the answers to the table in Appendix 1, including photos);
 - (iii) test types and procedures used for the programme;
 - (iv) the acceptance/rejection criteria for the family group;
 - (v) geographical area(s) within which the manufacturer has collected information;
 - (vi) sample size and sampling plan used;
10. the results of the ISC procedure, including:
 - (i) identification of the vehicles included in the programme (whether tested or not). The identification shall include the Table in Appendix 1.
 - (ii) test data for tailpipe emissions:
 - test fuel specifications (e.g. test reference fuel or market fuel),

▼ **M3**

- test conditions (temperature, humidity, dynamometer inertia weight),
- dynamometer settings (e.g. road load, power setting),
- test results and calculation of pass/fail;

(iii) test data for evaporative emissions:

- test fuel specifications (e.g. test reference fuel or market fuel),
- test conditions (temperature, humidity, dynamometer inertia weight),
- dynamometer settings (e.g. road load, power setting),
- test results and calculation of pass/fail.

▼ M3*Appendix 4***Format of the annual ISC Report by the granting type approval authority**

TITLE

- A. Quick overview and main conclusions
- B. ISC activities performed by the manufacturer in the previous year:
 - (1) Information gathering by manufacturer
 - (2) ISC testing (including planning and selection of families tested, and final results of tests)
- C. ISC activities performed by accredited laboratories or technical services in the previous year:
 - (3) Information gathering and risk assessment
 - (4) ISC testing (including planning and selection of families tested, and final results of tests)
- D. ISC activities performed by the granting type approval authority in the previous year:
 - (5) Information gathering and risk assessment
 - (6) ISC testing (including planning and selection of families tested, and final results of tests)
 - (7) Detailed investigations
 - (8) Remedial measures
- E. Assessment of the yearly expected emissions decrease due to any ISC remedial measures
- F. Lessons Learned (including for performance of instruments used)
- G. Report of other invalid tests

▼ **M3***Appendix 5***Transparency***Table 1***Transparency list 1**

ID	Input	Type of data	Unit	Description
1	2017/1151 TA Number	Text	—	As defined in Annex I/Appendix 4
2	Interpolation Family ID	Text	—	As defined in Annex XXI, paragraph 5.6. in general req.
3	PEMS Family ID	Text	—	As defined in Annex IIIa, App.7, paragraph 5.2.
4	Ki family ID	Text	—	As defined in Annex XXI, paragraph 5.9.
5	ATCT family ID	Text	—	As defined in Sub-Annex 6a of Annex XXI
6	Evap family ID	Text	—	As defined in Annex VI
7	RL family ID of vehicle H	Text	—	As defined in Annex XXI, paragraph 5.7.
7a	RL family ID of vehicle L (if relevant)	Text	—	As defined in Annex XXI, paragraph 5.7.
8	Test Mass of vehicle H	Number	kg	WLTP Test Mass as defined in 3.2.25. definitions in Annex XXI
8a	Test Mass of vehicle L (if relevant)	Number	kg	WLTP Test Mass as defined in 3.2.25. definitions in Annex XXI
9	F0 of vehicle H	Number	N	Road load coefficient as defined in Sub-Annex 4 of Annex XXI
9a	F0 of vehicle L (if relevant)	Number	N	Road load coefficient as defined in Sub-Annex 4 of Annex XXI
10	F1 of vehicle H	Number	N/km/h	Road load coefficient as defined in Sub-Annex 4 of Annex XXI

▼ **M3**

ID	Input	Type of data	Unit	Description
10a	F1 of vehicle L (if relevant)	Number	N/km/h	Road load coefficient as defined in Sub-Annex 4 of Annex XXI
11	F2 of vehicle H	Number	N/(km/h) ²	Road load coefficient as defined in Sub-Annex 4 of Annex XXI
11a	F2 of vehicle L (if relevant)	Number	N/(km/h) ²	Road load coefficient as defined in Sub-Annex 4 of Annex XXI
12a	CO ₂ mass emissions for ICE and NOVC vehicles of vehicle H	Numbers	g/km	WLTP CO ₂ emissions (Low, Medium, High, Extra-High, Combined) as calculated from: — Step 9, table A7/1 of Sub-Annex 7, Annex XXI for ICE vehicles, or — Step 8 from table A8/5 of Sub-Annex 8, Annex XXI for NOVC vehicles
12aa	CO ₂ mass emissions for ICE and NOVC vehicles of vehicle L (if relevant)	Numbers	g/km	WLTP CO ₂ emissions (Low, Medium, High, Extra-High, Combined) as calculated from: — Step 9, table A7/1 of Sub-Annex 7, Annex XXI for ICE vehicles, or — Step 8 from table A8/5 of Sub-Annex 8, Annex XXI for NOVC vehicles
12b	CO ₂ mass emissions for OVC vehicles of vehicle H	Numbers	g/km	WLTP CS CO ₂ emissions (Low, Medium, High, Extra-High, Combined) as calculated from Step 8 from table A8/5 of Sub-Annex 8, Annex XXI, WLTP CD CO ₂ emissions (combined) and WLTP CO ₂ emissions (weighted, combined) as calculated from Step 10 from table A8/8 of Sub-Annex 8, Annex XXI.
12ba	CO ₂ mass emissions for OVC vehicles of vehicle L (if relevant)	Numbers	g/km	WLTP CS CO ₂ emissions (Low, Medium, High, Extra-High, Combined) as calculated from Step 8 from table A8/5 of Sub-Annex 8, Annex XXI, WLTP CD CO ₂ emissions (combined) and WLTP CO ₂ emissions (weighted, combined) as calculated from Step 10 from table A8/8 of Sub-Annex 8, Annex XXI.
13	Drive wheels of vehicle in family	Text	front, rear, 4x4	Annex I, Appendix 4 addendum 1.7

▼ **M3**

ID	Input	Type of data	Unit	Description
14	Chassis Dyno configuration during TA test	Text	single or dual-axle	As defined in Annex XXI, Sub-Annex 6; 2.4.2.4. and 2.4.2.5.
15	Declared Vmax of vehicle H	Number	km/h	Maximum vehicle speed as defined in 3.7.2. definitions in Annex XXI
15a	Declared Vmax of vehicle L (if relevant)	Number	km/h	Maximum vehicle speed as defined in 3.7.2. definitions in Annex XXI
16	Maximum net power at engine speed	Number	... kW/... min	As defined in Sub-Annex 2 of Annex XXI
17	Mass in Running order of vehicle H	Number	kg	MRO as defined in 3.2.5. definitions in Annex XXI
17a	Mass in Running order of vehicle L (if relevant)	Number	kg	MRO as defined in 3.2.5. definitions in Annex XXI
18	Driver selectable mode(s) used during the TA tests (pure ICE) or for charge sustaining test (,NOVC-HEV, OVC-HEV, NOVC-FCHV)	Different formats possible (text, pictures, etc)	—	In case there are non predominant driver selectable modes the text shall describe all the modes used during the tests
19	Driver selectable mode(s) used during the TA tests for charge depleting test (OVC-HEV)	Different formats possible (text, pictures, etc)	—	In case there are non predominant driver selectable modes the text shall describe all the modes used during the tests
20	Idling engine speed	Number	rpm	As defined in Sub-Annex 2 of Annex XXI
21	n. of gears	Number	—	As defined in Sub-Annex 2 of Annex XXI
22	Gear ratios	Table values	—	Internal gearbox ratios; final drive ratio(s); total gear ratios

▼ M3

ID	Input	Type of data	Unit	Description
23	Tyre dimensions of the test vehicle front/rear	Letters/ Number	—	Used in TA
24	Full load power curve for ICEVs	Table values	rpm vs. kW	The full load power curve over the engine speed range from n_{idle} to n_{rated} or n_{max} , or $n_{dv}(n_{gvmax}) \times v_{max}$, whichever is higher
25	Additional safety margin	Vector	%	As defined in Sub-Annex 2 of Annex XXI
26	Specific n_{min_drive}	Number Table (from standstill to 1, from 2 to 3, ...)	rpm	As defined in Sub-Annex 2 of Annex XXI
27	Cycle check-sum of vehicle L and H	Number	—	Different for vehicle L and H. To verify the correctness of the cycle used. To be introduced only in case of cycle different from 3b
28	Gear Shift average Gear of vehicle H	Number	—	To validate different GS calculations.
29	ATCT FCF (family correction factor)	Number	—	As defined in Sub-Annex 6a, section 3.8.1. of Annex XXI. One value per each fuel in case of multiple fuel vehicles.
30a	Additive K_i factor(s)	Table values	—	Table defining per each pollutant and for CO_2 the value (g/km, mg/km, ...). Empty if multiplicative K_i factors are provided.
30b	Multiplicative K_i factors(s)	Table values	—	Table defining per each pollutant and for CO_2 the value. Empty if additive K_i factors are provided
31a	Additive Deterioration Factors (DF)	Table values	—	Table defining per each pollutant and the value (g/km, mg/km, ...). Empty if multiplicative DF factors are provided
31b	Multiplicative Deterioration Factors (DF)	Table values	—	Table defining per each pollutant the value. Empty if additive DF factors are provided

▼ M3

ID	Input	Type of data	Unit	Description
32	Battery voltage for all REESS	Numbers	V	As defined in Sub-Annex 6 Appendix 2 of Annex XXI for RCB correction in case of ICE, and in Sub-Annex 8 Appendix 2 of Annex XXI for HEVs, PEVs, and FCHVs (DIN EN 60050-482)
33	K correction coefficient	Number	(g/km)/(Wh/km)	For NOVC and OVC-HEVs correction of CS CO ₂ emissions as defined in Sub-Annex 8 of Annex XXI; phase-specific or combined
34a	Electric energy consumption of vehicle H	Number	Wh/km	For OVC-HEVs this is EC _{AC,weighted} (combined) and for PEVs Electric Consumption (combined) as defined in Sub-Annex 8 of Annex XXI
34b	Electric energy consumption of vehicle L (if relevant)	Number	Wh/km	For OVC-HEVs this is EC _{AC,weighted} (combined) and for PEVs Electric Consumption (combined) as defined in Sub-Annex 8 of Annex XXI
35a	Electric range of vehicle H	Number	km	For OVC-HEVs this is EAER (combined) and for PEVs Pure Electric Range (Combined) as defined in Sub-Annex 8 of Annex XXI
35b	Electric range of vehicle L (if relevant)	Number	km	For OVC-HEVs this is EAER (combined) and for PEVs Pure Electric Range (Combined) as defined in Sub-Annex 8 of Annex XXI
36a	Electric range city of vehicle H	Number	km	For OVC-HEVs this is EAER _{city} and for PEVs Pure Electric Range (City) as defined in Sub-Annex 8 of Annex XXI
36b	Electric range city of vehicle L (if relevant)	Number	km	For OVC-HEVs this is EAER _{city} and for PEVs Pure Electric Range (City) as defined in Sub-Annex 8 of Annex XXI
37a	Driving cycle class of vehicle H	Text	—	To know which cycle (class 1/2/3a/3b) has been used to calculate cycle energy demand for individual vehicle

▼ M3

ID	Input	Type of data	Unit	Description
37b	Driving cycle class of vehicle L (if relevant)	Text	—	To know which cycle (class 1/2/3a/3b) has been used to calculate cycle energy demand for individual vehicle
38a	Downscaling f_dsc of vehicle H	Number	—	To know if downscaling is needed and has been used to calculate cycle energy demand for individual vehicle
38b	Downscaling f_dsc of vehicle L if relevant	Number	—	To know if downscaling is needed and has been used to calculate cycle energy demand for individual vehicle
39a	Capped speed of vehicle H	yes/no	km/h	To know if capped speed procedure is needed and has to be used to calculate cycle energy demand for individual vehicle
39b	Capped speed of vehicle L (if relevant)	yes/no	km/h	To know if capped speed procedure is needed and has to be used to calculate cycle energy demand for individual vehicle
40a	Technically permissible maximum laden mass of vehicle H	Number	kg	
40b	Technically permissible maximum laden mass of vehicle L (if relevant)	Number	kg	
41	Direct injection	yes/no	—	
42	Regeneration recognition	Text	—	Description by vehicle manufacturer on how to recognize that a regeneration occurred during a test
43	Regeneration completion	Text	—	Description of the procedure to complete the regeneration
44	Weight distribution	Vector	—	Percentage of vehicle weight applied to each axle

For multistage or special purpose vehicles

45	Allowed final Vehicle mass in running order		kg	From-to
46	Allowed frontal area for final vehicle		cm ²	From-to
47	Allowed Rolling resistance		kg/t	From-to
48	Allowed projected frontal area of air entrance of the front grille		cm ²	From-to

▼ **M3**

Table 2

Transparency list 2

The Transparency list 2 is composed of two datasets characterized by the fields reported in Table 3 and Table 4.

Table 3

Dataset 1 of the Transparency list 2

Field	Type of data	Description
ID1	Number	Unique row identifier of the Dataset 1 in the Transparency list 2
TVV	Text	Unique identifier of the Type, Variant, Version of the vehicle (key field in the Dataset 1)
IF ID	Text	Identifier of the Interpolation family
RL ID	Text	Identifier of the Road Load Family
Make	Text	Trade name of manufacturer
Commercial name	Text	Commercial name of the TVV
Category	Text	Category of vehicle
Bodywork	Text	Type of bodywork

Table 4

Dataset 2 of the Transparency List 2

Field	Type of data	Description
ID2	Number	Unique row identifier of the Dataset 2 in the Transparency list 2
IF ID	Text	Unique identifier of the Interpolation family (key field in the Dataset 2)
WVTA Number	Text	Identifier of the Whole Vehicle Type-Approval
Emissions TA Number	Text	Identifier of the Emissions Type-Approval
PEMS ID	Text	Identifier of the PEMS family
EF ID	Text	Identifier of the Evap Family
ATCT ID	Text	Identifier of the ATCT Family
Ki ID	Text	Identifier of the Ki family
Durability ID	Text	Identifier of the Durability Family
Fuel	Text	Vehicle Fuel Type

▼ **M3**

Field	Type of data	Description
Dual Fuel	Yes/No	If the vehicle can use more than one fuel
Engine Capacity	Number	Engine capacity in cm ³
Rated Engine Power	Number	Rated power of the engine (kW at min ⁻¹)
Transmission type	Text	Type of vehicle transmission
Powered axles	Text	Number and position of the powered axles
Electric machine	Text	Number and type of electric machine(s)
Maximum net power	Number	Maximum net power of the electric machine
HEV Category	Text	Category of the hybrid electric vehicle

▼B

ANNEX III

[Reserved]



ANNEX IIIA

VERIFYING REAL DRIVING EMISSIONS

1. INTRODUCTION, DEFINITIONS AND ABBREVIATIONS

1.1. **Introduction**

This Annex describes the procedure to verify the Real Driving Emissions (RDE) performance of light passenger and commercial vehicles.

1.2. **Definitions**

1.2.1. ‘*Accuracy*’ means the deviation between a measured or calculated value and a traceable reference value.

1.2.2. ‘*Analyser*’ means any measurement device that is not part of the vehicle but installed to determine the concentration or the amount of gaseous or particle pollutants.

1.2.3. ‘*Axis intercept*’ of a linear regression (a_0) means:

$$a_0 = \bar{y} - (a_1 \times \bar{x})$$

where:

a_1 is the slope of the regression line

\bar{x} is the mean value of the reference parameter

\bar{y} is the mean value of the parameter to be verified

1.2.4. ‘*Calibration*’ means the process of setting the response of an analyser, flow-measuring instrument, sensor, or signal so that its output agrees with one or multiple reference signals.

1.2.5. ‘*Coefficient of determination*’ (r^2) means:

$$r^2 = 1 - \frac{\sum_{i=1}^n [y_i - a_0 - (a_1 \times x_i)]^2}{\sum_{i=1}^n (y_i - \bar{y})^2}$$

where:

a_0 is the axis intercept of the linear regression line

a_1 is the slope of the linear regression line

x_i is the measured reference value

y_i is the measured value of the parameter to be verified

\bar{y} is the mean value of the parameter to be verified

n is the number of values

▼ B

- 1.2.6. ‘*Cross-correlation coefficient*’ (r) means:

$$r = \frac{\sum_{i=1}^{n-1} (x_i - \bar{x}) \times (y_i - \bar{y})}{\sqrt{\sum_{i=1}^{n-1} (x_i - \bar{x})^2} \times \sqrt{\sum_{i=1}^{n-1} (y_i - \bar{y})^2}}$$

where:

x_i is the measured reference value

y_i is the measured value of the parameter to be verified

\bar{x} is the mean reference value

\bar{y} is the mean value of the parameter to be verified

n is the number of values

- 1.2.7. ‘*Delay time*’ means the time from the gas flow switching (t_0) until the response reaches 10 per cent (t_{10}) of the final reading.
- 1.2.8. ‘*Engine control unit (ECU) signals or data*’ means any vehicle information and signal recorded from the vehicle network using the protocols specified in point 3.4.5. of Appendix 1.
- 1.2.9. ‘*Engine control unit*’ means the electronic unit that controls various actuators to ensure the optimal performance of the powertrain.
- 1.2.10. ‘*Emissions*’ also referred to as ‘*components*’, ‘*pollutant components*’ or ‘*pollutant emissions*’ means the regulated gaseous or particle constituents of the exhaust.
- 1.2.11. ‘*Exhaust*’, also referred to as exhaust gas, means the total of all gaseous and particulate components emitted at the exhaust outlet or tailpipe as the result of fuel combustion within the vehicle’s internal combustion engine.

▼ M1

- 1.2.12. ‘*Exhaust emissions*’ means the tailpipe emissions of gaseous, solid and liquid compounds.

▼ B

- 1.2.13. ‘*Full scale*’ means the full range of an analyser, flow-measuring instrument or sensor as specified by the equipment manufacturer. If a sub-range of the analyser, flow-measuring instrument or sensor is used for measurements, full scale shall be understood as the maximum reading.
- 1.2.14. ‘*Hydrocarbon response factor*’ of a particular hydrocarbon species means the ratio between the reading of a FID and the concentration of the hydrocarbon species under consideration in the reference gas cylinder, expressed as ppmC₁.
- 1.2.15. ‘*Major maintenance*’ means the adjustment, repair or replacement of an analyser, flow-measuring instrument or sensor that could affect the accuracy of measurements.

▼ M3

- 1.2.16. ‘*Noise*’ means two times the root mean square of ten standard deviations, each calculated from the zero responses measured at a constant frequency which is a multiple of 1,0 Hz during a period of 30 seconds.

▼ B

- 1.2.17. ‘*Non-methane hydrocarbons*’ (NMHC) means the total hydrocarbons (THC) excluding methane (CH₄).

▼ M1

- 1.2.18. ‘*Particle number emissions*’ (PN) means the total number of solid particles emitted from the vehicle exhaust quantified according to the dilution, sampling and measurement methods as specified in Annex XXI.

▼ B

- 1.2.19. ‘*Precision*’ means 2.5 times the standard deviation of 10 repetitive responses to a given traceable standard value.
- 1.2.20. ‘*Reading*’ means the numerical value displayed by an analyser, flow-measuring instrument, sensor or any other measurement device applied in the context of vehicle emission measurements.
- 1.2.21. ‘*Response time*’ (t_{90}) means the sum of the delay time and the rise time.
- 1.2.22. ‘*Rise time*’ means the time between the 10 per cent and 90 per cent response ($t_{90} - t_{10}$) of the final reading.
- 1.2.23. ‘*Root mean square*’ (x_{rms}) means the square root of the arithmetic mean of the squares of values and defined as:

$$x_{\text{rms}} = \sqrt{\frac{1}{n}(x_1^2 + x_2^2 + \dots + x_n^2)}$$

where:

x is the measured or calculated value

n is the number of values

- 1.2.24. ‘*Sensor*’ means any measurement device that is not part of the vehicle itself but installed to determine parameters other than the concentration of gaseous and particle pollutants and the exhaust mass flow.

▼ M1

- 1.2.25. ‘*Span*’ means to adjust an instrument so that it gives a proper response to a calibration standard that represents between 75 per cent and 100 per cent of the maximum value in the instrument range or expected range of use.

▼ B

- 1.2.26. ‘*Span response*’ means the mean response to a span signal over a time interval of at least 30 seconds.
- 1.2.27. ‘*Span response drift*’ means the difference between the mean response to a span signal and the actual span signal that is measured at a defined time period after an analyser, flow-measuring instrument or sensor was accurately spanned.
- 1.2.28. ‘*Slope*’ of a linear regression (a_1) means:

$$a_1 = \frac{\sum_{i=1}^n (y_i - \bar{y}) \times (x_i - \bar{x})}{\sum_{i=1}^n (x_i - \bar{x})^2}$$

where:

\bar{x} is the mean value of the reference parameter

\bar{y} is the mean value of the parameter to be verified

x_i is the actual value of the reference parameter

▼ **B**

y_i is the actual value of the parameter to be verified

n is the number of values

1.2.29. ‘*Standard error of estimate*’ (*SEE*) means:

$$SEE = \frac{1}{x_{\max}} \times \sqrt{\frac{\sum_{i=1}^n (y_i - \hat{y})^2}{(n - 2)}}$$

where:

\hat{y} is the estimated value of the parameter to be verified

y_i is the actual value of the parameter to be verified

x_{\max} is the maximum actual value of the reference parameter

n is the number of values

1.2.30. ‘*Total hydrocarbons*’ (THC) means the sum of all volatile compounds measurable by a flame ionization detector (FID).

1.2.31. ‘*Traceable*’ means the ability to relate a measurement or reading through an unbroken chain of comparisons to a known and commonly agreed standard.

1.2.32. ‘*Transformation time*’ means the time difference between a change of concentration or flow (t_0) at the reference point and a system response of 50 per cent of the final reading (t_{50}).

1.2.33. ‘*Type of analyser*’, also referred to as ‘*analyser type*’ means a group of analysers produced by the same manufacturer that apply an identical principle to determine the concentration of one specific gaseous component or the number of particles.

1.2.34. ‘*Type of exhaust mass flow meter*’ means a group of exhaust mass flow meters produced by the same manufacturer that share a similar tube inner diameter and function on an identical principle to determine the mass flow rate of the exhaust gas.

1.2.35. ‘*Validation*’ means the process of evaluating the correct installation and functionality of a Portable Emissions Measurement System and the correctness of exhaust mass flow rate measurements as obtained from one or multiple non-traceable exhaust mass flow meters or as calculated from sensors or ECU signals.

1.2.36. ‘*Verification*’ means the process of evaluating whether the measured or calculated output of an analyser, flow-measuring instrument, sensor or signal agrees with a reference signal within one or more predetermined thresholds for acceptance.

1.2.37. ‘*Zero*’ means the calibration of an analyser, flow-measuring instrument or sensor so that it gives an accurate response to a zero signal.

1.2.38. ‘*Zero response*’ means the mean response to a zero signal over a time interval of at least 30 seconds.

1.2.39. ‘*Zero response drift*’ means the difference between the mean response to a zero signal and the actual zero signal that is measured over a defined time period after an analyser, flow-measuring instrument or sensor has been accurately zero calibrated.

▼ M1

- 1.2.40. ‘*Off-vehicle charging hybrid electric vehicle*’ (OVC-HEV) means a hybrid electric vehicle that can be charged from an external source.
- 1.2.41. ‘*Not off-vehicle charging hybrid electric vehicle*’ (NOVC-HEV) means a vehicle with at least two different energy converters and two different energy storage systems that are used for the purpose of vehicle propulsion and that cannot be charged from an external source.

▼ B1.3. **Abbreviations**

Abbreviations refer generically to both the singular and the plural forms of abbreviated terms.

CH ₄	— Methane
CLD	— ChemiLuminescence Detector
CO	— Carbon Monoxide
CO ₂	— Carbon Dioxide
CVS	— Constant Volume Sampler
DCT	— Dual Clutch Transmission
ECU	— Engine Control Unit
EFM	— Exhaust mass Flow Meter
FID	— Flame Ionisation Detector
FS	— full scale
GPS	— Global Positioning System
H ₂ O	— Water
HC	— HydroCarbons
HCLD	— Heated ChemiLuminescence Detector
HEV	— Hybrid Electric Vehicle
ICE	— Internal Combustion Engine
ID	— identification number or code
LPG	— Liquid Petroleum Gas
MAW	— Moving Average Window
max	— maximum value
N ₂	— Nitrogen
NDIR	— Non-Dispersive InfraRed analyser
NDUV	— Non-Dispersive UltraViolet analyser
NEDC	— New European Driving Cycle
NG	— Natural Gas

▼ B

NMC	— Non-Methane Cutter
NMC-FID	— Non-Methane Cutter in combination with a Flame-Ionisation Detector
NMHC	— Non-Methane HydroCarbons
NO	— Nitrogen Monoxide
No.	— number
NO ₂	— Nitrogen Dioxide
NO _x	— Nitrogen Oxides
NTE	— Not-to-exceed
O ₂	— Oxygen
OBD	— On-Board Diagnostics
PEMS	— Portable Emissions Measurement System
PHEV	— Plug-in Hybrid Electric Vehicle
PN	— particle number
RDE	— Real Driving Emissions
RPA	— Relative Positive Acceleration
SCR	— Selective Catalytic Reduction
SEE	— Standard Error of Estimate
THC	— Total HydroCarbons
UN/ECE	— United Nations Economic Commission for Europe
VIN	— Vehicle Identification Number
WLTC	— Worldwide harmonized Light vehicles Test Cycle
WWH-OBD	— WorldWide Harmonised On-Board Diagnostics

2. GENERAL REQUIREMENTS

2.1. **Not-to-exceed emission limits**

Throughout the normal life of a vehicle type approved according to Regulation (EC) No 715/2007, its emissions determined in accordance with the requirements of this Annex and emitted at any possible RDE test performed in accordance with the requirements of this Annex, shall not be higher than the following pollutant-specific not-to-exceed (NTE) values:

▼ M3

$$NTE_{\text{pollutant}} = CF_{\text{pollutant}} \times \text{EURO-6}$$

▼B

where EURO-6 is the applicable Euro 6 emission limit laid down in Table 2 of Annex 1 to Regulation (EC) No 715/2007.

2.1.1. Final Conformity Factors

The conformity factor $CF_{pollutant}$ for the respective pollutant is specified as follows:

Pollutant	Mass of oxides of nitrogen (NO _x)	Number of particles (PN)	Mass of carbon monoxide (CO) ⁽¹⁾	Mass of total hydrocarbons (THC)	Combined mass of total hydrocarbons and oxides of nitrogen (THC + NO _x)
$CF_{pollutant}$	► M3 1 + <i>margin</i> NO _x with <i>margin</i> NO _x = 0,43 ◀	► M1 1 + <i>margin</i> PN with <i>margin</i> PN = 0,5 ◀	—	—	—

(¹) CO emissions shall be measured and recorded at RDE tests.

margin is a parameter taking into account the additional measurement uncertainties introduced by the PEMS equipment, which are subject to an annual review and shall be revised as a result of the improved quality of the PEMS procedure or technical progress.

► **M1** 'margin PN' is a parameter taking into account the additional measurement uncertainties introduced by the PEMS PN equipment, which are subject to an annual review and shall be revised as a result of the improved quality of the PEMS PN procedure or technical progress. ◀

2.1.2. Temporary Conformity Factors

By way of exception to the provisions of point 2.1.1, during a period of 5 years and 4 months following the dates specified in Article 10(4) and (5) of Regulation (EC) 715/2007 and upon request of the manufacturer, the following temporary conformity factors may apply:

Pollutant	Mass of oxides of nitrogen (NO _x)	Number of particles (PN)	Mass of carbon monoxide (CO) ⁽¹⁾	Mass of total hydrocarbons (THC)	Combined mass of total hydrocarbons and oxides of nitrogen (THC + NO _x)
$CF_{pollutant}$	2,1	► M1 1 + <i>margin</i> PN with <i>margin</i> PN = 0,5 ◀	—	—	—

(¹) CO emissions shall be measured and recorded at RDE tests.

► **M1** 'margin PN' is a parameter taking into account the additional measurement uncertainties introduced by the PEMS PN equipment, which are subject to an annual review and shall be revised as a result of the improved quality of the PEMS PN procedure or technical progress. ◀

The application of temporary conformity factors shall be recorded in the certificate of conformity of the vehicle.

▼M3

For type approvals under this exception there shall be no declared maximum RDE value.

2.1.3. The manufacturer shall confirm compliance with point 2.1 by completing the certificate set out in Appendix 9. Verification of compliance shall be made in accordance with the rules of in-service conformity.

▼ B

- 2.2. The RDE tests required by this Annex at type approval and during the lifetime of a vehicle provide a presumption of conformity with the requirement set out in point 2.1. The presumed conformity may be reassessed by additional RDE tests.
- 2.3. Member States shall ensure that vehicles can be tested with PEMS on public roads in accordance with the procedures under their own national law, while respecting local road traffic legislation and safety requirements.
- 2.4. Manufacturers shall ensure that vehicles can be tested with PEMS by an independent party on public roads, e.g. by making available suitable adapters for exhaust pipes, granting access to ECU signals and making the necessary administrative arrangements. ► **M1** ► **C1** If the respective PEMS test is not required by this Regulation the manufacturer may charge a reasonable fee similar to the provision in Article 7(1) of Regulation (EC) No 715/2007. ◀ ◀

3. RDE TEST TO BE PERFORMED

▼ M2

- 3.1. The following requirements apply to PEMS tests referred to in Article 3(11), second subparagraph.

▼ M3

- 3.1.0. The requirements of point 2.1 shall be fulfilled for the urban and the complete PEMS trip, where the emissions of the vehicle tested shall be calculated in accordance with Appendices 4 and 6, and shall remain always equal or below the NTE ($M_{RDE,k} \leq NTE_{pollutant}$).

▼ B

- 3.1.1. For type approval, the exhaust mass flow shall be determined by measurement equipment functioning independently from the vehicle and no vehicle ECU data shall be used in this respect. Outside the type approval context, alternative methods to determine the exhaust mass flow can be used according to Appendix 2, Section 7.2.

▼ M3

- 3.1.2. During type approval tests, if the approval authority is not satisfied with the data quality check and validation results of a PEMS test conducted in accordance with Appendices 1 and 4, the approval authority may consider the test to be void. In such case, the test data and the reasons for voiding the test shall be recorded by the approval authority.

▼ M3

3.1.3. Reporting and dissemination of RDE type approval test information

▼ B

3.1.3.1. A technical report prepared by the manufacturer in accordance with Appendix 8 shall be made available to the approval authority.

▼ M1

3.1.3.2. The manufacturer shall ensure that the information listed in point 3.1.3.2.1. is made available on a publicly accessible website without costs and without the need for the user to reveal his identity or sign up. The manufacturer shall keep the Commission and Type Approval Authorities informed on the location of the website.

▼ M3

3.1.3.2.1. The website shall allow a wildcard search of the underlying database based on one or more of the following:

Make, Type, Variant, Version, Commercial name, or Type Approval Number as referred to in the certificate of conformity, pursuant to Annex IX to Directive 2007/46/EC.

The information described below shall be made available for each vehicle in a search:

— The PEMS family ID to which that vehicle belongs, in accordance with item number 3 in the Transparency List 1 set out in Table 1 of Appendix 5 to Annex II;

— The Declared Maximum RDE Values as reported in point 48.2 of the Certificate of Conformity, as described in Annex IX to Directive 2007/46/EC.

▼ M1**▼ B**

3.1.3.3. Upon request, without costs and within 30 days, the manufacturer shall make available the technical report referred to in point 3.1.3.1 to any interested party.

3.1.3.4. Upon request, the type approval authority shall make available the information listed under points 3.1.3.1 and 3.1.3.2 within 30 days of receiving the request. The type approval authority may charge a reasonable and proportionate fee, which does not discourage an inquirer with a justified interest from requesting the respective information or exceed the internal costs of the authority for making the requested information available.

4. GENERAL REQUIRMENTS

4.1. The RDE performance shall be demonstrated by testing vehicles on the road operated over their normal driving patterns, conditions and payloads. The RDE test shall be representative for vehicles operated on their real driving routes, with their normal load.

▼ M3

- 4.2. For type approval, the manufacturer shall demonstrate to the approval authority that the chosen vehicle, driving patterns, conditions and payloads are representative of the PEMS test family. The payload and ambient conditions requirements, as specified in points 5.1 and 5.2, shall be used ex-ante to determine whether the conditions are acceptable for RDE testing.

▼ M1

- 4.3. The approval authority shall propose a test trip in urban, rural and motorway environments meeting the requirements of point 6. For the purpose of trip design, the urban, rural and motorway parts shall be selected based on a topographic map. The urban part of the trip should be driven on urban roads with a speed limit of 60 km/h or less. In case the urban part of the trip needs to be driven for a limited period of time on roads with speed limit higher than 60 km/h, the vehicle shall be driven with speeds up to 60 km/h.

▼ B

- 4.4. If for a vehicle the collection of ECU data influences the vehicle's emissions or performance the entire PEMS test family to which the vehicle belongs as defined in Appendix 7 shall be considered as non-compliant. Such functionality shall be considered as a 'defeat device' as defined in Article 3(10) of Regulation (EC) 715/2007.

▼ M3

- 4.5. In order to also assess emissions during trips in hot start, a certain number of vehicles per PEMS test family, specified in point 4.2.8 in Appendix 7, shall be tested without conditioning the vehicle as described in point 5.3, but with a warm engine with engine coolant temperature and/or engine oil temperature above 70 °C.

- 4.6. For RDE tests performed during type approval the TAA may verify if the test setup and the equipment used fulfills the requirements of Appendices 1 and 2, through a direct inspection or an analysis of the supporting evidence (e.g. photographs, records).

- 4.7. Compliance of the software tool used to verify the trip validity and calculate emissions in accordance with the provisions laid down in Appendices 4, 5, 6, 7a, and 7b shall be validated by the tool provider or a type approval authority. Where such software tool is incorporated in the PEMS instrument, proof of the validation shall be provided along with the instrument.

▼ B

5. BOUNDARY CONDITIONS
- 5.1. Vehicle payload and test mass
- 5.1.1. The vehicle's basic payload shall comprise the driver, a witness of the test (if applicable) and the test equipment, including the mounting and the power supply devices.

▼ B

- 5.1.2. For the purpose of testing some artificial payload may be added as long as the total mass of the basic and artificial payload does not exceed 90% of the sum of the ‘mass of the passengers’ and the ‘payload’ defined in points 19 and 21 of Article 2 of Commission Regulation (EU) No 1230/2012 (*).

(*) Commission Regulation (EU) No 1230/2012 of 12 December 2012 implementing Regulation (EC) No 661/2009 of the European Parliament and of the Council with regard to type-approval requirements for masses and dimensions of motor vehicles and their trailers and amending Directive 2007/46/EC of the European Parliament and of the Council (OJ L 353, 21.12.2012, p. 31).

- 5.2. Ambient conditions

▼ M1

- 5.2.1. The test shall be conducted under ambient conditions laid down in this section. The ambient conditions become ‘extended’ when at least one of the temperature and altitude conditions is extended. The correction factor for extended conditions for temperature and altitude shall only be applied once. If a part of the test or the entire test is performed outside of normal or extended conditions, the test shall be invalid.

▼ B

- 5.2.2. Moderate altitude conditions: Altitude lower or equal to 700 meters above sea level.
- 5.2.3. Extended altitude conditions: Altitude higher than 700 meters above sea level and lower or equal to 1300 meters above sea level.

▼ M1

- 5.2.4. Moderate temperature conditions: Greater than or equal to 273,15 K (0 °C) and lower than or equal to 303,15 K (30 °C).
- 5.2.5. Extended temperature conditions: Greater than or equal to 266,15 K (– 7 °C) and lower than 273,15 K (0 °C) or greater than 303,15 K (30 °C) and lower than or equal to 308,15 K (35 °C).
- 5.2.6. By way of derogation from the provisions of points 5.2.4 and 5.2.5 the lower temperature for moderate conditions shall be greater or equal to 276,15 K (3 °C) and the lower temperature for extended conditions shall be greater or equal to 271,15 K (– 2 °C) between the start of the application of binding NTE emission limits as defined in section 2.1 and until five years and four months after the dates given in paragraphs 4 and 5 of Article 10, of Regulation (EC) No 715/2007.

- 5.3. Vehicle conditioning for cold engine-start testing

Before RDE testing, the vehicle shall be preconditioned in the following way:

Driven for at least 30 min, parked with doors and bonnet closed and kept in engine-off status within moderate or extended altitude and temperatures in accordance with points 5.2.2 to 5.2.6 between 6 and 56 hours. Exposure to extreme atmospheric conditions (heavy snowfall, storm, hail) and excessive amounts of dust should be avoided. Before the test start, the vehicle and equipment shall be checked for damages and the absence of warning signals, suggesting malfunctioning.

▼ B

5.4. Dynamic conditions

The dynamic conditions encompass the effect of road grade, head wind and driving dynamics (accelerations, decelerations) and auxiliary systems upon energy consumption and emissions of the test vehicle. The verification of the normality of dynamic conditions shall be done after the test is completed, using the recorded PEMS data. This verification shall be conducted in 2 steps:

▼ M3

5.4.1. The excess or insufficiency of driving dynamics during the trip shall be checked using the methods described in Appendix 7a.

5.4.2. If the trip results are valid following the verifications in accordance with point 5.4.1, the methods for verifying the normality of the test conditions as laid down in Appendices 5, 7a and 7b shall be used.

▼ B

5.5. Vehicle condition and operation

▼ M3

5.5.1. The air conditioning system or other auxiliary devices shall be operated in a way which corresponds to their typically intended use at real driving on the road. Any use shall be documented. The vehicle windows shall be closed when the air conditioning or heating are used.

▼ M1

5.5.2. Vehicles equipped with periodically regenerating systems

5.5.2.1. 'Periodically regenerating systems' shall be understood in accordance with the definition in point 3.8.1 of Annex XXI.

▼ M3

5.5.2.2. All results shall be corrected with the K_i factors or with the K_i offsets developed by the procedures in Appendix 1 to Sub-Annex 6 of Annex XXI for type-approval of a vehicle type with a periodically regenerating system. The K_i factor or the K_i offset shall be applied to the final results after evaluation in accordance with Appendix 6.

5.5.2.3. If the emissions do not fulfil the requirements of point 3.1.0, then the occurrence of regeneration shall be verified. The verification of regeneration may be based on expert judgement through cross-correlation of several of the following signals, which may include exhaust temperature, PN, CO₂, O₂ measurements in combination with vehicle speed and acceleration. If the vehicle has a regeneration recognition feature declared in Transparency List 1 set out in Table 1 of Appendix 5 to Annex II, it shall be used to determine the occurrence of regeneration. The manufacturer shall also declare in Transparency List 1 of set out in Table 1 of Appendix 5 to Annex II the procedure needed in order to complete the regeneration. The manufacturer may advise how to recognise whether regeneration has taken place in case such a signal is not available.

If regeneration occurred during the test, the result without the application of either the K_i -factor or the K_i offset shall be checked against the requirements of point 3.1.0. If the resulting emissions do not fulfil the requirements, then the test shall be voided and repeated once. The completion of the regeneration and stabilisation through at least 1 hour of driving shall be ensured prior to the start of the second test. The second test is considered valid even if regeneration occurs during it.

▼ M3

5.5.2.4. Even if the vehicle fulfils the requirements of point 3.1.0, the occurrence of regeneration may be verified as in point 5.5.2.3. If the presence of regeneration can be proved and with the agreement of the Type Approval Authority, the final results will be calculated without the application of either the Ki factor or the Ki offset.

5.5.3. OVC-HEVs vehicles may be tested in any selectable mode, including battery charge mode.

5.5.4. Modifications that affect the vehicle aerodynamics are not permitted with the exception of the PEMS installation.

5.5.5. The test vehicles shall not be driven with the intention to generate a passed or failed test due to extreme driving patterns that do not represent normal conditions of use. In case of need, verification of normal driving may be based on expert judgement made by or on behalf of the granting type approval authority through cross-correlation on several signals, which may include exhaust flow rate, exhaust temperature, CO₂, O₂ etc. in combination with vehicle speed, acceleration and GPS data and potentially further vehicle data parameters like engine speed, gear, accelerator pedal position etc.

5.5.6. The vehicle shall be in good mechanical condition and shall have been run in and driven at least 3 000 km before the test. The mileage and the age of the vehicle used for RDE testing shall be recorded.

▼ B**6. TRIP REQUIREMENTS**

6.1. The shares of urban, rural and motorway driving, classified by instantaneous speed as described in points 6.3 to 6.5, shall be expressed as a percentage of the total trip distance.

▼ M3

6.2. The trip shall always start with urban driving followed by rural and motorway driving in accordance with the shares specified in point 6.6. The urban, rural and motorway operation shall be run consecutively in accordance with point 6.12, but may also include a trip which starts and ends at the same point. Rural operation may be interrupted by short periods of urban operation when driving through urban areas. Motorway operation may be interrupted by short periods of urban or rural operation, e.g., when passing toll stations or sections of road works.

▼ B

6.3. Urban operation is characterised by vehicle speeds lower than or equal to 60 km/h.

▼ M1

- 6.4. Rural operation is characterised by vehicle speeds higher than 60 km/h and lower than or equal to 90 km/h. For N2 category vehicles that are equipped in accordance with Directive 92/6/EEC with a device limiting vehicle speed to 90 km/h, rural operation is characterised by vehicle speed higher than 60 km/h and lower than or equal to 80 km/h.
- 6.5. Motorway operation is characterised by speeds above 90 km/h. For N2 category vehicles that are equipped in accordance with Directive 92/6/EEC with a device limiting vehicle speed to 90 km/h, motorway operation is characterised by speed higher than 80 km/h.

▼ B

- 6.6. The trip shall consist of approximately 34 % per cent urban, 33 % per cent rural and 33 % per cent motorway driving classified by speed as described in points 6.3 to 6.5 above. 'Approximately' shall mean the interval of ± 10 per cent points around the stated percentages. The urban driving shall however never be less than 29% of the total trip distance.
- 6.7. The vehicle velocity shall normally not exceed 145 km/h. This maximum speed may be exceeded by a tolerance of 15 km/h for not more than 3 % of the time duration of the motorway driving. Local speed limits remain in force during a PEMS test, notwithstanding other legal consequences. Violations of local speed limits per se do not invalidate the results of a PEMS test.

▼ M1

- 6.8. The average speed (including stops) of the urban driving part of the trip should be between 15 and 40 km/h. Stop periods, defined by vehicle speed of less than 1 km/h, shall account for 6-30 % of the time duration of urban operation. Urban operation may contain several stop periods of 10 s or longer. However, individual stop periods shall not exceed 300 consecutive seconds; else the trip shall be voided.
- 6.9. The speed range of the motorway driving shall properly cover a range between 90 and at least 110 km/h. The vehicle's velocity shall be above 100 km/h for at least 5 minutes.

For M2 category vehicles that are equipped in accordance with Directive 92/6/EEC with a device limiting vehicle speed to 100 km/h, the speed range of the motorway driving shall properly cover a range between 90 and 100 km/h. The vehicle's velocity shall be above 90 km/h for at least 5 minutes.

For N2 category vehicles that are equipped in accordance with Directive 92/6/EEC with a device limiting vehicle speed to 90 km/h, the speed range of the motorway driving shall properly cover a range between 80 and 90 km/h. The vehicle's velocity shall be above 80 km/h for at least 5 minutes.

▼ B

- 6.10. The trip duration shall be between 90 and 120 minutes.

▼ M1

- 6.11. The start and the end point of a trip shall not differ in their elevation above sea level by more than 100 m. In addition, the proportional cumulative positive altitude gain over the entire trip and over the urban part of the trip as determined in accordance with point 4.3 shall be less than 1 200 m/100 km and be determined in accordance with Appendix 7b.

▼ B

- 6.12. The minimum distance of each, the urban, rural and motorway operation shall be 16 km.

▼ M1

- 6.13. The average speed (including stops) during cold start period as defined in Appendix 4, point 4 shall be between 15 and 40 km/h. The maximum speed during the cold start period shall not exceed 60 km/h.

▼ B**7. OPERATIONAL REQUIREMENTS**

- 7.1. The trip shall be selected in such a way that the testing is uninterrupted and the data continuously recorded to reach the minimum test duration defined in point 6.10.
- 7.2. Electrical power shall be supplied to the PEMS by an external power supply unit and not from a source that draws its energy either directly or indirectly from the engine of the test vehicle.
- 7.3. The installation of the PEMS equipment shall be done in a way to influence the vehicle emissions or performance or both to the minimum extent possible. Care should be exercised to minimize the mass of the installed equipment and potential aerodynamic modifications of the test vehicle. The vehicle payload shall be in accordance with point 5.1.
- 7.4. RDE tests shall be conducted on working days as defined for the Union in Council Regulation (EEC, Euratom) No 1182/71 (*)

(*) Regulation (EEC, Euratom) No 1182/71 of the Council of 3 June 1971 determining the rules applicable to periods, dates and time limits (OJ L 124, 8.6.1971, p. 1).

- 7.5. RDE tests shall be conducted on paved roads and streets (e.g. off road operation is not permitted).

▼ M3

- 7.6. At the test start as defined in point 5.1. of Appendix 1, the vehicle shall move within 15 seconds. The vehicle stop during the entire cold start period, as defined in point 4 of Appendix 4, shall be kept to the minimum possible and it shall not exceed in total 90 seconds. If the engine stalls during the test, it may be restarted, but the sampling shall not be interrupted. If the engine stops during the test, the sampling shall not be interrupted.

▼ B**8. LUBRICATING OIL, FUEL AND REAGENT**

- 8.1. The fuel, lubricant and reagent (if applicable) used for RDE testing shall be within the specifications issued by the manufacturer for vehicle operation by the customer.

▼ M3

- 8.2. In the case of an RDE test with a failed result, samples of fuel, lubricant and reagent (if applicable) shall be taken and kept for at least 1 year under conditions guaranteeing the integrity of the sample. Once analysed, the samples can be discarded.

▼ B

9. EMISSIONS AND TRIP EVALUATION
- 9.1. The test shall be conducted in accordance with Appendix 1 of this Annex.

▼ M3

- 9.2. The trip validity shall be verified in a three-step procedure as follows:

STEP A: The trip complies with the general requirements, boundary conditions, trip and operational requirements, and the specifications for lubricating oil, fuel and reagents set out in points 4 to 8;

STEP B: The trip complies with the requirements set out in Appendices 7a and 7b.

STEP C: The trip complies with the requirements set out in Appendix 5.

The steps of the procedure are detailed in Figure 1.

Figure 1
Verification of trip validity

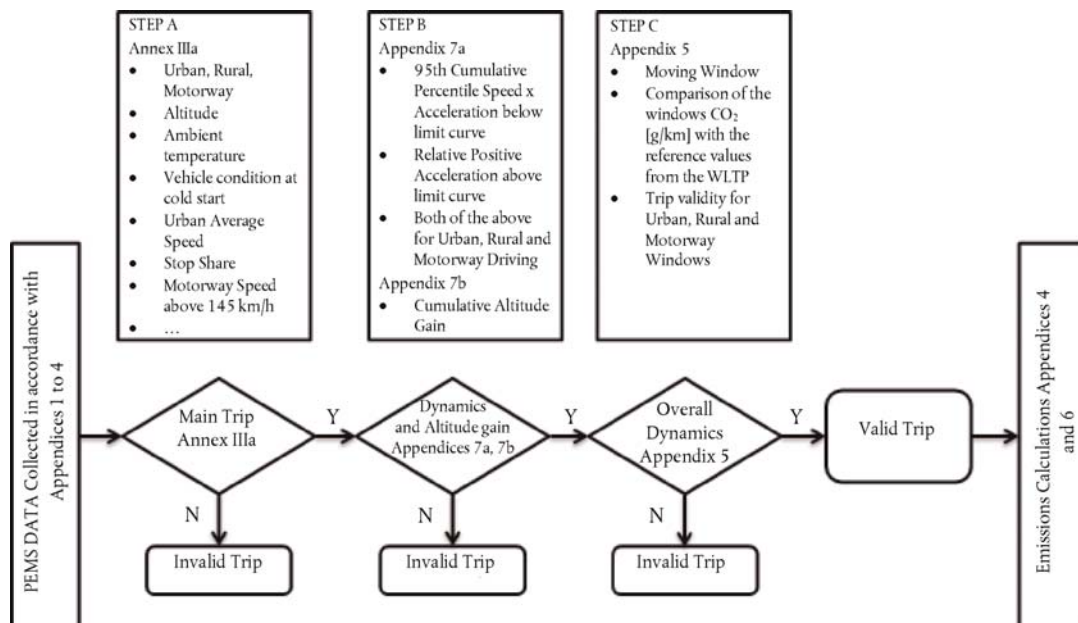

If at least one of the requirements is not fulfilled, the trip shall be declared invalid.

▼ B

- 9.3. It shall not be permitted to combine data of different trips or to modify or remove data from a trip with exception of provisions for long stops as described in 6.8.

▼ M3

- 9.4. After establishing the validity of a trip in accordance with point 9.2, emission results shall be calculated using the methods laid down in Appendix 4 and Appendix 6. The emissions calculations shall be made between test start and test end, as defined in Appendix 1, points 5.1. and 5.3. respectively.

▼ B

- 9.5. If during a particular time interval the ambient conditions are extended in accordance with point 5.2, the pollutant emissions during this particular time interval, calculated according to Appendix 4, shall be divided by a value of 1,6 before being evaluated for compliance with the requirements of this Annex. This provision does not apply to carbon dioxide emissions.

▼ M3

- 9.6. Gaseous pollutant and particle number emissions during cold start, as defined in point 4 of Appendix 4, shall be included in the normal evaluation in accordance with Appendices 4, 5 and 6. If the vehicle was conditioned for the last three hours prior to the test at an average temperature that falls within the extended range in accordance with point 5.2, then the provisions of point 9.5 apply to the data collected during the cold start period, even if the running conditions are not within the extended temperature range.

▼B*Appendix 1***Test procedure for vehicle emissions testing with a Portable Emissions Measurement System (PEMS)**

1. INTRODUCTION

This Appendix describes the test procedure to determine exhaust emissions from light passenger and commercial vehicles using a Portable Emissions Measurement System.

2. SYMBOLS, PARAMETERS AND UNITS

≤	— smaller or equal
#	— number
#/m ³	— number per cubic metre
%	— per cent
°C	— degree centigrade
g	— gramme
g/s	— gramme per second
h	— hour
Hz	— hertz
K	— kelvin
kg	— kilogramme
kg/s	— kilogramme per second
km	— kilometre
km/h	— kilometre per hour
kPa	— kilopascal
kPa/min	— kilopascal per minute
l	— litre
l/min	— litre per minute
m	— metre
m ³	— cubic-metre
mg	— milligram
min	— minute
p_e	— evacuated pressure [kPa]
q_{vs}	— volume flow rate of the system [l/min]
ppm	— parts per million

▼B

ppmC ₁	— parts per million carbon equivalent
rpm	— revolutions per minute
s	— second
V _s	— system volume [l]

3. GENERAL REQUIREMENTS

3.1. PEMS

The test shall be carried out with a PEMS, composed of components specified in points 3.1.1 to 3.1.5. If applicable, a connection with the vehicle ECU may be established to determine relevant engine and vehicle parameters as specified in point 3.2.

- 3.1.1. Analysers to determine the concentration of pollutants in the exhaust gas.
- 3.1.2. One or multiple instruments or sensors to measure or determine the exhaust mass flow.
- 3.1.3. A Global Positioning System to determine the position, altitude and speed of the vehicle.
- 3.1.4. If applicable, sensors and other appliances being not part of the vehicle, e.g., to measure ambient temperature, relative humidity, air pressure, and vehicle speed.
- 3.1.5. An energy source independent of the vehicle to power the PEMS.

3.2. Test parameters

▼M3

Test parameters as specified in Table 1 of this Appendix shall be measured at a constant frequency of 1,0 Hz or higher and recorded and reported in accordance with the requirements of Appendix 8 at a frequency of 1,0 Hz. If ECU parameters are available, these may be obtained at a substantially higher frequency but the recording rate shall be 1,0 Hz. The PEMS analysers, flow-measuring instruments and sensors shall comply with the requirements laid down in Appendices 2 and 3.

▼B

Table 1

Test parameters

Parameter	Recommended unit	Source ⁽⁸⁾
THC concentration ^{(1), (4)}	ppm C ₁	Analyser
CH ₄ concentration ^{(1), (4)}	ppm C ₁	Analyser
NMHC concentration ^{(1), (4)}	ppm C ₁	Analyser ⁽⁶⁾
CO concentration ^{(1), (4)}	ppm	Analyser
CO ₂ concentration ⁽¹⁾	ppm	Analyser

▼B**▼M1**

▼B

Parameter	Recommended unit	Source ⁽⁸⁾
NO _x concentration ⁽¹⁾ , ⁽⁴⁾	ppm	Analyser ⁽⁷⁾
PN concentration ⁽⁴⁾	#/m ³	Analyser
Exhaust mass flow rate	kg/s	EFM, any methods described in point 7 of Appendix 2
Ambient humidity	%	Sensor
Ambient temperature	K	Sensor
Ambient pressure	kPa	Sensor
Vehicle speed	km/h	Sensor, GPS, or ECU ⁽³⁾
Vehicle latitude	Degree	GPS
Vehicle longitude	Degree	GPS
Vehicle altitude ⁽⁵⁾ , ⁽⁹⁾	M	GPS or Sensor
Exhaust gas temperature ⁽⁵⁾	K	Sensor
Engine coolant temperature ⁽⁵⁾	K	Sensor or ECU
Engine speed ⁽⁵⁾	rpm	Sensor or ECU
Engine torque ⁽⁵⁾	Nm	Sensor or ECU
Torque at driven axle ⁽⁵⁾	Nm	Rim torque meter
Pedal position ⁽⁵⁾	%	Sensor or ECU
Engine fuel flow ⁽²⁾	g/s	Sensor or ECU
Engine intake air flow ⁽²⁾	g/s	Sensor or ECU
Fault status ⁽⁵⁾	—	ECU
Intake air flow temperature	K	Sensor or ECU
Regeneration status ⁽⁵⁾	—	ECU
Engine oil temperature ⁽⁵⁾	K	Sensor or ECU
Actual gear ⁽⁵⁾	#	ECU
Desired gear (e.g. gear shift indicator) ⁽⁵⁾	#	ECU
Other vehicle data ⁽⁵⁾	unspecified	ECU

⁽¹⁾ to be measured on a wet basis or to be corrected as described in point 8.1 of Appendix 4

⁽²⁾ to be determined only if indirect methods are used to calculate exhaust mass flow rate as described in paragraphs 10.2 and 10.3 of Appendix 4

⁽³⁾ method to be chosen according to point 4.7

⁽⁴⁾ parameter only mandatory if measurement required by Annex IIIA, section 2.1

⁽⁵⁾ to be determined only if necessary to verify the vehicle status and operating conditions

⁽⁶⁾ may be calculated from THC and CH₄ concentrations according to point 9.2 of Appendix 4

⁽⁷⁾ may be calculated from measured NO and NO₂ concentrations

⁽⁸⁾ Multiple parameter sources may be used.

⁽⁹⁾ The preferable source is the ambient pressure sensor.

3.3. Preparation of the vehicle

The preparation of the vehicle shall include a general verification of the correct technical functioning of the test vehicle.

▼ B**3.4. Installation of PEMS****▼ M1****3.4.1. General:**

The installation of the PEMS shall follow the instructions of the PEMS manufacturer and the local health and safety regulations. The PEMS should be installed as to minimise during the test electromagnetic interferences as well as exposure to shocks, vibration, dust and variability in temperature. The installation and operation of the PEMS shall be leak-tight and minimise heat loss. The installation and operation of PEMS shall not change the nature of the exhaust gas nor unduly increase the length of the tailpipe. To avoid the generation of particles, connectors shall be thermally stable at the exhaust gas temperatures expected during the test. It is recommended not to use elastomer connectors to connect the vehicle exhaust outlet and the connecting tube. Elastomer connectors, if used, shall have no contact with the exhaust gas to avoid artefacts at high engine load.

▼ M3**3.4.2. Permissible backpressure**

The installation and operation of the PEMS sampling probes shall not unduly increase the pressure at the exhaust outlet in a way that may influence the representativeness of the measurements. It is thus recommended that only one sampling probe is installed in the same plane. If technically feasible, any extension to facilitate the sampling or connection with the exhaust mass flow meter shall have an equivalent, or larger, cross sectional area than the exhaust pipe.

3.4.3. Exhaust mass flow meter

Whenever used, the exhaust mass flow meter shall be attached to the vehicle's tailpipe(s) in accordance with the recommendations of the EFM manufacturer. The measurement range of the EFM shall match the range of the exhaust mass flow rate expected during the test. It is recommended to select the EFM in order to have the maximum expected flow rate during the test covering at least 75 % of the EFM full range. The installation of the EFM and any exhaust pipe adaptors or junctions shall not adversely affect the operation of the engine or exhaust after-treatment system. A minimum of four pipe diameters or 150 mm of straight tubing, whichever is larger, shall be placed at either side of the flow-sensing element. When testing a multi-cylinder engine with a branched exhaust manifold, it is recommended to position the exhaust mass flow meter downstream of where the manifolds combine and to increase the cross section of the piping such as to have an equivalent, or larger, cross sectional area from which to sample. If this is not feasible, exhaust flow measurements with several exhaust mass flow meters may be used. The wide variety of exhaust pipe configurations, dimensions and exhaust mass flow rates may require compromises, guided by good engineering judgement, when selecting and installing the EFM(s). It is permissible to install an EFM with a diameter smaller than that of the exhaust outlet or the total projected frontal area of multiple outlets, providing it improves measurement accuracy and does not adversely affect the operation or the exhaust after-treatment as specified in point 3.4.2. It is recommended to document the EFM set-up using photographs.

▼B3.4.4. *Global Positioning System (GPS)*

The GPS antenna should be mounted, e.g. at the highest possible location, as to ensure good reception of the satellite signal. The mounted GPS antenna shall interfere as little as possible with the vehicle operation.

3.4.5. *Connection with the Engine Control Unit (ECU)*

If desired, relevant vehicle and engine parameters listed in Table 1 can be recorded by using a data logger connected with the ECU or the vehicle network through standards, such as ISO 15031-5 or SAE J1979, OBD-II, EOBD or WWH-OBD. If applicable, manufacturers shall disclose labels to allow the identification of required parameters.

3.4.6. *Sensors and auxiliary equipment*

Vehicle speed sensors, temperature sensors, coolant thermocouples or any other measurement device not part of the vehicle shall be installed to measure the parameter under consideration in a representative, reliable and accurate manner without unduly interfering with the vehicle operation and the functioning of other analysers, flow-measuring instruments, sensors and signals. Sensors and auxiliary equipment shall be powered independently of the vehicle. It is permitted to power any safety-related illumination of fixtures and installations of PEMS components outside of the vehicle's cabin by the vehicle's battery.

▼M13.5. **Emissions sampling**

Emissions sampling shall be representative and conducted at locations of well-mixed exhaust where the influence of ambient air downstream of the sampling point is minimal. If applicable, emissions shall be sampled downstream of the exhaust mass flow meter, respecting a distance of at least 150 mm to the flow sensing element. The sampling probes shall be fitted at least 200 mm or three times the inner diameter of the exhaust pipe, whichever is larger, upstream of the point at which the exhaust exits the PEMS sampling installation into the environment. If the PEMS feeds back a flow to the tail pipe, this shall occur downstream of the sampling probe in a manner that does not affect during engine operation the nature of the exhaust gas at the sampling point(s). If the length of the sampling line is changed, the system transport times shall be verified and if necessary corrected.

If the engine is equipped with an exhaust after-treatment system, the exhaust sample shall be taken downstream of the exhaust after-treatment system. When testing a vehicle with a branched exhaust manifold, the inlet of the sampling probe shall be located sufficiently far downstream so as to ensure that the sample is representative of the average exhaust emissions of all cylinders. In multi-cylinder engines, having distinct groups of manifolds, such as in a 'V' engine configuration, the sampling probe shall be positioned downstream of where the manifolds combine. If this is technically not feasible, multi-point sampling at locations of well-mixed exhaust may be used, if approved by the Type Approval Authority. In this case, the number and location of sampling probes shall match as far as possible those of the exhaust mass flow meters. In case of unequal exhaust flows, proportional sampling or sampling with multiple analysers shall be considered.

▼ M3

If the engine is equipped with an exhaust after-treatment system, the exhaust sample shall be taken downstream of the exhaust after-treatment system. When testing a vehicle with a branched exhaust manifold, the inlet of the sampling probe shall be located sufficiently far downstream so as to ensure that the sample is representative of the average exhaust emissions of all cylinders. In multi-cylinder engines having distinct groups of manifolds, such as in a 'V' engine configuration, the sampling probe shall be positioned downstream of the point where the manifolds combine. If this is technically not feasible, multi-point sampling at locations of well-mixed exhaust may be used. In this case, the number and location of sampling probes shall match as far as possible those of the exhaust mass flow meters. In case of unequal exhaust flows, proportional sampling or sampling with multiple analysers shall be considered.

▼ M1

If hydrocarbons are measured, the sampling line shall be heated to 463 ± 10 K (190 ± 10 °C). For the measurement of other gaseous components with or without cooler, the sampling line shall be kept at a minimum of 333 K (60 °C) to avoid condensation and to ensure appropriate penetration efficiencies of the various gases. For low pressure sampling systems, the temperature can be lowered corresponding to the pressure decrease provided that the sampling system ensures a penetration efficiency of 95 % for all regulated gaseous pollutants. If particles are sampled and not diluted at the tailpipe, the sampling line from the raw exhaust sample point to the point of dilution or particle detector shall be heated to a minimum of 373 K (100 °C). The residence time of the sample in the particle sampling line shall be less than 3 s until reaching first dilution or the particle detector.

All parts of the sampling system from the exhaust pipe up to the particle detector, which are in contact with raw or diluted exhaust gas, shall be designed to minimize deposition of particles. All parts shall be made from antistatic material to prevent electrostatic effects.

▼ B**4. PRE-TEST PROCEDURES****4.1. PEMS leak check**

After the installation of the PEMS is completed, a leak check shall be performed at least once for each PEMS-vehicle installation as prescribed by the PEMS manufacturer or as follows. The probe shall be disconnected from the exhaust system and the end plugged. The analyser pump shall be switched on. After an initial stabilization period all flow meters shall read approximately zero in the absence of a leak. Else, the sampling lines shall be checked and the fault be corrected.

The leakage rate on the vacuum side shall not exceed 0.5 per cent of the in-use flow rate for the portion of the system being checked. The analyser flows and bypass flows may be used to estimate the in-use flow rate.

Alternatively, the system may be evacuated to a pressure of at least 20 kPa vacuum (80 kPa absolute). After an initial stabilization period the pressure increase Δp (kPa/min) in the system shall not exceed:

$$\Delta p = \frac{P_e}{V_s} \times q_{vs} \times 0.005$$

▼ B

Alternatively, a concentration step change at the beginning of the sampling line shall be introduced by switching from zero to span gas while maintaining the same pressure conditions as under normal system operation. If for a correctly calibrated analyser after an adequate period of time the reading is ≤ 99 per cent compared to the introduced concentration, the leakage problem shall be corrected.

▼ M1**4.2. Starting and stabilizing the PEMS**

The PEMS shall be switched on, warmed up and stabilized in accordance with the specifications of the PEMS manufacturer until key functional parameters, e.g., pressures, temperatures and flows have reached their operating set points before test start. To ensure correct functioning, the PEMS may be kept switched on or can be warmed up and stabilized during vehicle conditioning. The system shall be free of errors and critical warnings.

4.3. Preparing the sampling system

The sampling system, consisting of the sampling probe and sampling lines shall be prepared for testing by following the instruction of the PEMS manufacturer. It shall be ensured that the sampling system is clean and free of moisture condensation.

▼ B**4.4. Preparing the Exhaust mass Flow Meter (EFM)**

If used for measuring the exhaust mass flow, the EFM shall be purged and prepared for operation in accordance with the specifications of the EFM manufacturer. This procedure shall, if applicable, remove condensation and deposits from the lines and the associated measurement ports.

4.5. Checking and calibrating the analysers for measuring gaseous emissions

Zero and span calibration adjustments of the analysers shall be performed using calibration gases that meet the requirements of point 5 of Appendix 2. The calibration gases shall be chosen to match the range of pollutant concentrations expected during the RDE test. To minimize analyser drift, one should conduct the zero and span calibration of analysers at an ambient temperature that resembles, as closely as possible, the temperature experienced by the test equipment during the trip.

▼ M3**4.6. Checking the analyser for measuring particle emissions**

The zero level of the analyser shall be recorded by sampling HEPA filtered ambient air at an appropriate sampling point, usually at the inlet of the sampling line. The signal shall be recorded at a constant frequency which is a multiple of 1,0 Hz averaged over a period of 2 minutes; the final concentration shall be within the manufacturer's specifications, but shall not exceed 5 000 particles per cubic-centimetre.

▼ B**4.7. Determining vehicle speed**

Vehicle speed shall be determined by at least one of the following methods:

- (a) a GPS; if vehicle speed is determined by a GPS, the total trip distance shall be checked against the measurements of another method according to point 7 of Appendix 4.

▼ B

- (b) a sensor (e.g., optical or micro-wave sensor); if vehicle speed is determined by a sensor, the speed measurements shall comply with the requirements of point 8 of Appendix 2, or alternatively, the total trip distance determined by the sensor shall be compared with a reference distance obtained from a digital road network or topographic map. The total trip distance determined by the sensor shall deviate by no more than 4 % from the reference distance.
- (c) the ECU; if vehicle speed is determined by the ECU, the total trip distance shall be validated according to point 3 of Appendix 3 and the ECU speed signal adjusted, if necessary to fulfil the requirements of point 3.3 of Appendix 3. Alternatively, the total trip distance as determined by the ECU can be compared with a reference distance obtained from a digital road network or topographic map. The total trip distance determined by the ECU shall deviate by no more than 4 % from the reference.

4.8. Check of PEMS set up

The correctness of connections with all sensors and, if applicable, the ECU shall be verified. If engine parameters are retrieved, it shall be ensured that the ECU reports values correctly (e.g., zero engine speed [rpm] while the combustion engine is in key-on-engine-off status).
► M1 The PEMS shall function free of errors and critical warnings. ◀

5. EMISSIONS TEST**▼ M3****5.1. Test start**

Test start (see Figure App.1.1) shall be defined by either:

- the first ignition of the internal combustion engine;
- or the first movement of the vehicle with speed greater than 1 km/h for OVC-HEVs and NOVC-HEVs starting with the internal combustion engine off.

Sampling, measurement and recording of parameters shall begin prior to the test start. Before the test start it shall be confirmed that all necessary parameters are recorded by the data logger.

To facilitate time alignment, it is recommended to record the parameters that are subject to time alignment either by a single data recording device or with a synchronised time stamp.

Figure App.1.1

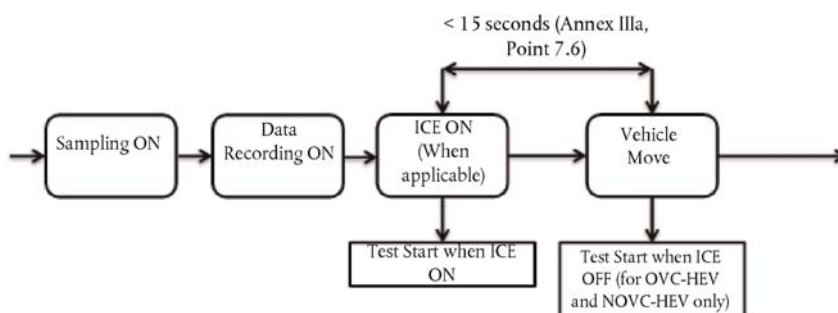
Test Start Sequence

▼ M1**5.2. Test**

Sampling, measurement and recording of parameters shall continue throughout the on-road test of the vehicle. The engine may be stopped and started, but emissions sampling and parameter recording shall continue. Any warning signals, suggesting malfunctioning of the PEMS, shall be documented and verified. If any error signal(s) appear during the test, the test shall be voided. Parameter recording shall reach a data completeness of higher than 99 %. Measurement and data recording may be interrupted for less than 1 % of the total trip duration but for no more than a consecutive period of 30 s solely in the case of unintended signal loss or for the purpose of PEMS system maintenance. Interruptions may be recorded directly by the PEMS but it is not permissible to introduce interruptions in the recorded parameter via the pre-processing, exchange or post-processing of data. If conducted, auto zeroing shall be performed against a traceable zero standard similar to the one used to zero the analyser. It is strongly recommended to initiate PEMS system maintenance during periods of zero vehicle speed.

▼ M3**5.3. Test end**

The end of the test (see Figure App.1.2) is reached when the vehicle has completed the trip and either when:

- the internal combustion engine is switched off;
- or:
- for OVC-HEVs and NOVC-HEVs finishing the test with the internal combustion engine off, the vehicle stops and the speed is lower than or equal to 1 km/h.

Excessive idling of the engine after the completion of the trip shall be avoided. The data recording shall continue until the response time of the sampling systems has elapsed. For vehicles with a signal detecting regeneration (see line 42 in the Transparency List 1 in Appendix 5 of Annex II), the OBD-check shall be performed and documented directly after data recording and before any further driven distance is driven.

Figure App.1.2

Test End Sequence

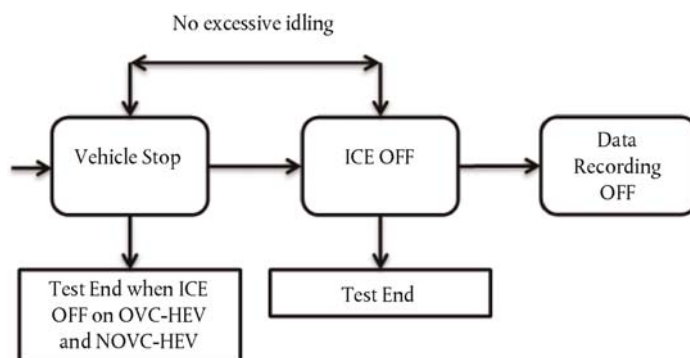
**▼ B****6. POST-TEST PROCEDURE****6.1. Checking the analysers for measuring gaseous emissions**

The zero and span of the analysers of gaseous components shall be checked by using calibration gases identical to the ones applied under point 4.5 to evaluate the analyser's zero and response drift compared to the pre-test calibration. It is permissible to zero the analyser prior to verifying the span drift, if the zero drift was determined to be within the permissible range. The post-test drift check shall be completed as

▼B

soon as possible after the test and before the PEMS, or individual analysers or sensors, are turned off or have switched into a non-operating mode. The difference between the pre-test and post-test results shall comply with the requirements specified in Table 2.

Table 2

Permissible analyser drift over a PEMS test**▼M1**

Pollutant	Absolute Zero response drift	Absolute Span response drift ⁽¹⁾
CO ₂	≤ 2 000 ppm per test	≤ 2 % of reading or ≤ 2 000 ppm per test, whichever is larger
CO	≤ 75 ppm per test	≤ 2 % of reading or ≤ 75 ppm per test, whichever is larger
NO _x	≤ 5 ppm per test	≤ 2 % of reading or ≤ 5 ppm per test, whichever is larger
CH ₄	≤ 10 ppm C ₁ per test	≤ 2 % of reading or ≤ 10 ppm C ₁ per test, whichever is larger
THC	≤ 10 ppm C ₁ per test	≤ 2 % of reading or ≤ 10 ppm C ₁ per test, whichever is larger

⁽¹⁾ If the zero drift is within the permissible range, it is permissible to zero the analyser prior to verifying the span drift.

▼B

If the difference between the pre-test and post-test results for the zero and span drift is higher than permitted, all test results shall be voided and the test repeated.

▼M1**6.2. Checking the analyser for measuring particle emissions**

The zero level of the analyser shall be recorded in accordance with point 4.6.

▼M3**6.3. Checking the on-road emission measurements**

The span gas concentration that was used for the calibration of the analysers in accordance with paragraph 4.5 at the test start shall cover at least 90 % of the concentration values obtained from 99 % of the measurement of the valid parts of the emissions test. It is permissible that 1 % of the total number of measurements used for evaluation exceeds the used span gas by up to a factor of two. If these requirements are not met, the test shall be voided.



Appendix 2

Specifications and calibration of PEMS components and signals

1. INTRODUCTION

This appendix sets out the specifications and calibration of PEMS components and signals.

2. SYMBOLS, PARAMETERS AND UNITS

>	— larger than
≥	— larger than or equal to
%	— per cent
≤	— smaller than or equal to
A	— undiluted CO ₂ concentration [%]
a_0	— y-axis intercept of the linear regression line
a_1	— slope of the linear regression line
B	— diluted CO ₂ concentration [%]
C	— diluted NO concentration [ppm]
c	— analyser response in the oxygen interference test
$c_{FS,b}$	— full scale HC concentration in step (b) [ppmC ₁]
$c_{FS,d}$	— full scale HC concentration in step (d) [ppmC ₁]
$c_{HC(w/NMC)}$	— HC concentration with CH ₄ or C ₂ H ₆ flowing through the NMC [ppmC ₁]
$c_{HC(w/o NMC)}$	— HC concentration with CH ₄ or C ₂ H ₆ bypassing the NMC [ppmC ₁]
$c_{m,b}$	— measured HC concentration in step (b) [ppmC ₁]
$c_{m,d}$	— measured HC concentration in step (d) [ppmC ₁]
$c_{ref,b}$	— reference HC concentration in step (b) [ppmC ₁]
$c_{ref,d}$	— reference HC concentration in step (d) [ppmC ₁]
°C	— degree centigrade
D	— undiluted NO concentration [ppm]
D_e	— expected diluted NO concentration [ppm]
E	— absolute operating pressure [kPa]

▼ B

E_{CO_2} — per cent CO₂ quench

▼ M1

$E(d_p)$ — PEMS-PN analyser efficiency

▼ B

E_E — ethane efficiency

$E_{\text{H}_2\text{O}}$ — per cent water quench

E_M — methane efficiency

E_{O_2} — oxygen interference

F — water temperature [K]

G — saturation vapour pressure [kPa]

g — gram

gH₂O/kg — gramme water per kilogram

h — hour

H — water vapour concentration [%]

H_m — maximum water vapour concentration [%]

Hz — hertz

K — kelvin

kg — kilogramme

km/h — kilometre per hour

kPa — kilopascal

max — maximum value

$\text{NO}_{\text{X,dry}}$ — moisture-corrected mean concentration of the stabilized NO_x recordings

$\text{NO}_{\text{X,m}}$ — mean concentration of the stabilized NO_x recordings

$\text{NO}_{\text{X,ref}}$ — reference mean concentration of the stabilized NO_x recordings

ppm — parts per million

ppmC₁ — parts per million carbon equivalents

r^2 — coefficient of determination

s — second

t_0 — time point of gas flow switching [s]

t_{10} — time point of 10 % response of the final reading

t_{50} — time point of 50 % response of the final reading

▼ B

t_{90}	— time point of 90 % response of the final reading
tbd	— to be determined
x	— independent variable or reference value
χ_{\min}	— minimum value
y	— dependent variable or measured value

3. LINEARITY VERIFICATION

3.1. General

► **M1** The accuracy and linearity of analysers, flow-measuring instruments, sensors and signals, shall be traceable to international or national standards. ◀ Any sensors or signals that are not directly traceable, e.g., simplified flow-measuring instruments shall be calibrated alternatively against chassis dynamometer laboratory equipment that has been calibrated against international or national standards.

3.2. Linearity requirements

All analysers, flow-measuring instruments, sensors and signals shall comply with the linearity requirements given in Table 1. If air flow, fuel flow, the air-to-fuel ratio or the exhaust mass flow rate is obtained from the ECU, the calculated exhaust mass flow rate shall meet the linearity requirements specified in Table 1.

Table 1

Linearity requirements of measurement parameters and systems**▼ M1**

Measurement parameter/instrument	$ \chi_{\min} \times (a_1 - 1) + a_0 $	Slope a_1	Standard error SEE	Coefficient of determination r^2
Fuel flow rate ⁽¹⁾	$\leq 1\%$ max	0,98 – 1,02	$\leq 2\%$	$\geq 0,990$
Air flow rate ⁽¹⁾	$\leq 1\%$ max	0,98 – 1,02	$\leq 2\%$	$\geq 0,990$
Exhaust mass flow rate	$\leq 2\%$ max	0,97 – 1,03	$\leq 3\%$	$\geq 0,990$
Gas analysers	$\leq 0,5\%$ max	0,99 – 1,01	$\leq 1\%$	$\geq 0,998$
Torque ⁽²⁾	$\leq 1\%$ max	0,98 – 1,02	$\leq 2\%$	$\geq 0,990$
PN analysers ⁽³⁾	$\leq 5\%$ max	0,85 – 1,15 ⁽⁴⁾	$\leq 10\%$	$\geq 0,950$

⁽¹⁾ optional to determine exhaust mass flow

⁽²⁾ optional parameter

⁽³⁾ The linearity check shall be verified with soot-like particles, as these are defined in point 6.2

⁽⁴⁾ To be updated based on error propagation and traceability charts.

3.3. Frequency of linearity verification

The linearity requirements pursuant to point 3.2 shall be verified:

- for each gas analyser at least every 12 months or whenever a system repair or component change or modification is made that could influence the calibration;
- for other relevant instruments, such as PN analysers, exhaust mass flow meters and traceably calibrated sensors, whenever damage is observed, as required by internal audit procedures or by the instrument manufacturer but no longer than one year before the actual test.

▼ M1

The linearity requirements pursuant to point 3.2 for sensors or ECU signals that are not directly traceable shall be performed with a traceably calibrated measurement device on the chassis dynamometer once for each PEMS-vehicle setup.

▼ B**3.4. Procedure of linearity verification****3.4.1. General requirements**

The relevant analysers, instruments and sensors shall be brought to their normal operating condition according to the recommendations of their manufacturer. The analysers, instruments and sensors shall be operated at their specified temperatures, pressures and flows.

3.4.2. General procedure

The linearity shall be verified for each normal operating range by executing the following steps:

- (a) The analyser, flow-measuring instrument or sensor shall be set to zero by introducing a zero signal. For gas analysers, purified synthetic air or nitrogen shall be introduced to the analyser port via a gas path that is as direct and short as possible.
- (b) The analyser, flow-measuring instrument or sensor shall be spanned by introducing a span signal. For gas analysers, an appropriate span gas shall be introduced to the analyser port via a gas path that is as direct and short as possible.
- (c) The zero procedure of (a) shall be repeated.
- (d) The linearity shall be verified by introducing at least 10, approximately equally spaced and valid, reference values (including zero). The reference values with respect to the concentration of components, the exhaust mass flow rate or any other relevant parameter shall be chosen to match the range of values expected during the emissions test. For measurements of exhaust mass flow, reference points below 5 % of the maximum calibration value can be excluded from the linearity verification.
- (e) For gas analysers, known gas concentrations in accordance with point 5 shall be introduced to the analyser port. Sufficient time for signal stabilisation shall be given.

▼ M3

- (f) The values under evaluation and, if needed, the reference values shall be recorded at a constant frequency which is a multiple of 1,0 Hz over a period of 30 seconds.

▼ B

- (g) The arithmetic mean values over the 30 seconds period shall be used to calculate the least squares linear regression parameters, with the best-fit equation having the form:

$$y = a_1x + a_0$$

where:

y is the actual value of the measurement system

a_1 is the slope of the regression line

x is the reference value

a_0 is the y intercept of the regression line

▼B

The standard error of estimate (SEE) of y on x and the coefficient of determination (r^2) shall be calculated for each measurement parameter and system.

- (h) The linear regression parameters shall meet the requirements specified in Table 1.

3.4.3. *Requirements for linearity verification on a chassis dynamometer*

Non-traceable flow-measuring instruments, sensors or ECU signals that cannot directly be calibrated according to traceable standards, shall be calibrated on a chassis dynamometer. The procedure shall follow as far as applicable, the requirements of Annex 4a to UN/ECE Regulation No 83. If necessary, the instrument or sensor to be calibrated shall be installed on the test vehicle and operated according to the requirements of Appendix 1. The calibration procedure shall follow whenever possible the requirements of point 3.4.2; at least 10 appropriate reference values shall be selected as to ensure that at least 90 % of the maximum value expected to occur during the RDE test is covered.

If a not directly traceable flow-measuring instrument, sensor or ECU signal for determining exhaust flow is to be calibrated, a traceably calibrated reference exhaust mass flow meter or the CVS shall be attached to the vehicle's tailpipe. It shall be ensured that the vehicle exhaust is accurately measured by the exhaust mass flow meter according to point 3.4.3 of Appendix 1. The vehicle shall be operated by applying constant throttle at a constant gear selection and chassis dynamometer load.

4. ANALYSERS FOR MEASURING GASEOUS COMPONENTS

4.1. **Permissible types of analysers**

4.1.1. *Standard analysers*

The gaseous components shall be measured with analysers specified in points 1.3.1 to 1.3.5 of Appendix 3, Annex 4A to UN/ECE Regulation No 83, 07 series of amendments. If an NDUV analyser measures both NO and NO₂, a NO₂/NO converter is not required.

4.1.2. *Alternative analysers*

Any analyser not meeting the design specifications of point 4.1.1 is permissible provided that it fulfils the requirements of point 4.2. The manufacturer shall ensure that the alternative analyser achieves an equivalent or higher measurement performance compared to a standard analyser over the range of pollutant concentrations and co-existing gases that can be expected from vehicles operated with permissible fuels under moderate and extended conditions of valid RDE testing as specified in points 5, 6 and 7 of this Annex. Upon request, the manufacturer of the analyser shall submit in writing supplemental information, demonstrating that the measurement performance of the alternative analyser is consistently and reliably in line with the measurement performance of standard analysers. Supplemental information shall contain:

- (a) a description of the theoretical basis and the technical components of the alternative analyser;

▼M3

- (b) a demonstration of equivalency with the respective standard analyser specified in point 4.1.1 over the expected range of pollutant concentrations and ambient conditions of the type-approval test defined in Annex XXI to this Regulation as well as a validation test as described in point 3 of Appendix 3 for a vehicle equipped with a spark-ignition and compression-ignition engine; the manufacturer of the analyser shall demonstrate the significance of equivalency within the permissible tolerances given in point 3.3 of Appendix 3.

▼ B

- (c) a demonstration of equivalency with the respective standard analyser specified in point 4.1.1 with respect to the influence of atmospheric pressure on the measurement performance of the analyser; the demonstration test shall determine the response to span gas having a concentration within the analyser range to check the influence of atmospheric pressure under moderate and extended altitude conditions defined in point 5.2 of this Annex. Such a test can be performed in an altitude environmental test chamber.
- (d) a demonstration of equivalency with the respective standard analyser specified in point 4.1.1 over at least three on-road tests that fulfil the requirements of this Annex.

▼ M3

- (e) a demonstration that the influence of vibrations, accelerations and ambient temperature on the analyser reading does not exceed the noise requirements for analysers set out in point 4.2.4.

▼ B

Approval authorities may request additional information to substantiate equivalency or refuse approval if measurements demonstrate that an alternative analyser is not equivalent to a standard analyser.

4.2. Analyser specifications

4.2.1. General

In addition to the linearity requirements defined for each analyser in point 3, the compliance of analyser types with the specifications laid down in points 4.2.2 to 4.2.8 shall be demonstrated by the analyser manufacturer. Analysers shall have a measuring range and response time appropriate to measure with adequate accuracy the concentrations of the exhaust gas components at the applicable emissions standard under transient and steady state conditions. The sensitivity of the analysers to shocks, vibration, aging, variability in temperature and air pressure as well as electromagnetic interferences and other impacts related to vehicle and analyser operation shall be limited as far as possible.

4.2.2. Accuracy

The accuracy, defined as the deviation of the analyser reading from the reference value, shall not exceed 2 % of reading or 0.3 % of full scale, whichever is larger.

4.2.3. Precision

The precision, defined as 2.5 times the standard deviation of 10 repetitive responses to a given calibration or span gas, shall be no greater than 1 % of the full scale concentration for a measurement range equal or above 155 ppm (or ppmC₁) and 2 % of the full scale concentration for a measurement range of below 155 ppm (or ppmC₁).

▼ M3

4.2.4. Noise

The noise shall not exceed 2 % of full scale. Each of the 10 measurement periods shall be interspersed with an interval of 30 seconds in which the analyser is exposed to an appropriate span gas. Before each sampling period and before each span period, sufficient time shall be given to purge the analyser and the sampling lines.

▼ B

4.2.5. Zero response drift

The drift of the zero response, defined as the mean response to a zero gas during a time interval of at least 30 seconds, shall comply with the specifications given in Table 2.

▼B4.2.6. *Span response drift*

The drift of the span response, defined as the mean response to a span gas during a time interval of at least 30 seconds, shall comply with the specifications given in Table 2.

Table 2

Permissible zero and span response drift of analysers for measuring gaseous components under laboratory conditions

▼M1

Pollutant	Absolute Zero response drift	Absolute Span response drift
CO ₂	≤ 1 000 ppm over 4 h	≤ 2 % of reading or ≤ 1 000 ppm over 4 h, whichever is larger
CO	≤ 50 ppm over 4 h	≤ 2 % of reading or ≤ 50 ppm over 4 h, whichever is larger
PN	5 000 particles per cubic centimetre over 4 h	According to manufacturer specifications
NO _x	≤ 5 ppm over 4 h	≤ 2 % of reading or 5 ppm over 4 h, whichever is larger
CH ₄	≤ 10 ppm C ₁	≤ 2 % of reading or ≤ 10 ppm C ₁ over 4 h, whichever is larger
THC	≤ 10 ppm C ₁	≤ 2 % of reading or ≤ 10 ppm C ₁ over 4 h, whichever is larger

▼B4.2.7. *Rise time*

The rise time, defined as the time between the 10 per cent and 90 per cent response of the final reading ($t_{90} - t_{10}$; see point 4.4), shall not exceed 3 seconds.

4.2.8. *Gas drying*

Exhaust gases may be measured wet or dry. A gas-drying device, if used, shall have a minimal effect on the composition of the measured gases. Chemical dryers are not permitted.

4.3. **Additional requirements**4.3.1. *General*

The provisions in points 4.3.2 to 4.3.5 define additional performance requirements for specific analyser types and apply only to cases, in which the analyser under consideration is used for RDE emission measurements.

4.3.2. *Efficiency test for NO_x converters*

If a NO_x converter is applied, for example to convert NO₂ into NO for analysis with a chemiluminescence analyser, its efficiency shall be tested by following the requirements of point 2.4 of Appendix 3 of Annex 4a to UN/ECE Regulation No 83, 07 series of amendments. The efficiency of the NO_x converter shall be verified no longer than one month before the emissions test.

4.3.3. *Adjustment of the Flame Ionisation Detector (FID)*

(a) Optimization of the detector response

If hydrocarbons are measured, the FID shall be adjusted at intervals specified by the analyser manufacturer by following point 2.3.1 of

▼B

Appendix 3 of Annex 4a to UN/ECE Regulation No 83, 07 series of amendments. A propane-in-air or propane-in-nitrogen span gas shall be used to optimize the response in the most common operating range.

(b) Hydrocarbon response factors

If hydrocarbons are measured, the hydrocarbon response factor of the FID shall be verified by following the provisions of point 2.3.3 of Appendix 3 of Annex 4a to UN/ECE Regulation No 83, 07 series of amendments, using propane-in-air or propane-in-nitrogen as span gases and purified synthetic air or nitrogen as zero gases, respectively.

(c) Oxygen interference check

The oxygen interference check shall be performed when introducing a FID into service and after major maintenance intervals. A measuring range shall be chosen in which the oxygen interference check gases fall in the upper 50 per cent. The test shall be conducted with the oven temperature set as required. The specifications of the oxygen interference check gases are described in point 5.3.

The following procedure applies:

- (i) The analyser shall be set at zero;
- (ii) The analyser shall be spanned with a 0 per cent oxygen blend for positive ignition engines and a 21 per cent oxygen blend for compression ignition engines;
- (iii) The zero response shall be rechecked. If it has changed by more than 0.5 per cent of full scale, steps (i) and (ii) shall be repeated;
- (iv) The 5 per cent and 10 per cent oxygen interference check gases shall be introduced;
- (v) The zero response shall be rechecked. If it has changed by more than ± 1 per cent of full scale, the test shall be repeated;
- (vi) The oxygen interference E_{O_2} shall be calculated for each oxygen interference check gas in step (iv) as follows:

$$E_{O_2} = \frac{(c_{\text{ref,d}} - c)}{c_{\text{ref,d}}} \times 100$$

where the analyser response is:

$$c = \frac{(c_{\text{ref,d}} \times c_{FS,b})}{c_{m,b}} \times \frac{c_{m,b}}{c_{FS,d}}$$

where:

$c_{\text{ref,b}}$ is the reference HC concentration in step (ii) [ppmC₁]

▼ B

$c_{\text{ref,d}}$ is the reference HC concentration in step (iv) [ppmC₁]

$c_{\text{FS,b}}$ is the full scale HC concentration in step (ii) [ppmC₁]

$c_{\text{FS,d}}$ is the full scale HC concentration in step (iv) [ppmC₁]

$c_{\text{m,b}}$ is the measured HC concentration in step (ii) [ppmC₁]

$c_{\text{m,d}}$ is the measured HC concentration in step (iv) [ppmC₁]

(vii) The oxygen interference E_{O_2} shall be less than ± 1.5 per cent for all required oxygen interference check gases.

(viii) If the oxygen interference E_{O_2} is higher than ± 1.5 per cent, corrective action may be taken by incrementally adjusting the air flow (above and below the manufacturer's specifications), the fuel flow and the sample flow.

(ix) The oxygen interference check shall be repeated for each new setting.

4.3.4. Conversion efficiency of the non-methane cutter (NMC)

If hydrocarbons are analysed, a NMC can be used to remove non-methane hydrocarbons from the gas sample by oxidizing all hydrocarbons except methane. Ideally, the conversion for methane is 0 per cent and for the other hydrocarbons represented by ethane is 100 per cent. For the accurate measurement of NMHC, the two efficiencies shall be determined and used for the calculation of the NMHC emissions (see point 9.2 of Appendix 4). It is not necessary to determine the methane conversion efficiency in case the NMC-FID is calibrated according to method (b) in point 9.2 of Appendix 4 by passing the methane/air calibration gas through the NMC.

(a) Methane conversion efficiency

Methane calibration gas shall be flown through the FID with and without bypassing the NMC; the two concentrations shall be recorded. The methane efficiency shall be determined as:

$$E_M = 1 - \frac{c_{\text{HC(w/NMC)}}}{c_{\text{HC(w/oNMC)}}$$

where:

$c_{\text{HC(w/NMC)}}$ is the HC concentration with CH₄ flowing through the NMC [ppmC₁]

$c_{\text{HC(w/o NMC)}}$ is the HC concentration with CH₄ bypassing the NMC [ppmC₁]

(b) Ethane conversion efficiency

Ethane calibration gas shall be flown through the FID with and without bypassing the NMC; the two concentrations shall be recorded. The ethane efficiency shall be determined as:

$$E_E = 1 - \frac{c_{\text{HC(w/NMC)}}}{c_{\text{HC(w/oNMC)}}$$

where:

$c_{\text{HC(w/NMC)}}$ is the HC concentration with C₂H₆ flowing through the NMC [ppmC₁]

▼ B

$c_{\text{HC(w/o NMC)}}$ is the HC concentration with C_2H_6 bypassing the NMC [ppmC_1]

4.3.5. *Interference effects*

(a) General

Other gases than the ones being analysed can affect the analyser reading. A check for interference effects and the correct functionality of analysers shall be performed by the analyser manufacturer prior to market introduction at least once for each type of analyser or device addressed in points (b) to (f).

(b) CO analyser interference check

Water and CO_2 can interfere with the measurements of the CO analyser. Therefore, a CO_2 span gas having a concentration of 80 to 100 per cent of full scale of the maximum operating range of the CO analyser used during the test shall be bubbled through water at room temperature and the analyser response recorded. The analyser response shall not be more than 2 per cent of the mean CO concentration expected during normal on-road testing or ± 50 ppm, whichever is larger. The interference check for H_2O and CO_2 may be run as separate procedures. If the H_2O and CO_2 levels used for the interference check are higher than the maximum levels expected during the test, each observed interference value shall be scaled down by multiplying the observed interference with the ratio of the maximum expected concentration value during the test and the actual concentration value used during this check. Separate interference checks with concentrations of H_2O that are lower than the maximum concentration expected during the test may be run and the observed H_2O interference shall be scaled up by multiplying the observed interference with the ratio of the maximum H_2O concentration value expected during the test and the actual concentration value used during this check. The sum of the two scaled interference values shall meet the tolerance specified in this point.

(c) NO_x analyser quench check

The two gases of concern for CLD and HCLD analysers are CO_2 and water vapour. The quench response to these gases is proportional to the gas concentrations. A test shall determine the quench at the highest concentrations expected during the test. If the CLD and HCLD analysers use quench compensation algorithms that utilize H_2O or CO_2 measurement analysers or both, quench shall be evaluated with these analysers active and with the compensation algorithms applied.

(i) CO_2 quench check

A CO_2 span gas having a concentration of 80 to 100 per cent of the maximum operating range shall be passed through the NDIR analyser; the CO_2 value shall be recorded as A. The CO_2 span gas shall then be diluted by approximately 50 per cent with NO span gas and passed through the NDIR and CLD or HCLD; the CO_2 and NO values shall be recorded as B and C, respectively. The CO_2 gas flow shall then be shut off and only the NO span gas shall be passed through the CLD or HCLD; the NO value shall be recorded as D. The per cent quench shall be calculated as:

$$E_{\text{CO}_2} = \left[1 - \left(\frac{C \times A}{(D \times A) - (D \times B)} \right) \right] \times 100$$

▼ B

where:

A is the undiluted CO₂ concentration measured with the NDIR [%]

B is the diluted CO₂ concentration measured with the NDIR [%]

C is the diluted NO concentration measured with the CLD or HCLD [ppm]

D is the undiluted NO concentration measured with the CLD or HCLD [ppm]

Alternative methods of diluting and quantifying of CO₂ and NO span gas values such as dynamic mixing/blending are permitted upon approval of the approval authority.

(ii) Water quench check

This check applies to measurements of wet gas concentrations only. The calculation of water quench shall consider dilution of the NO span gas with water vapour and the scaling of the water vapour concentration in the gas mixture to concentration levels that are expected to occur during an emissions test. A NO span gas having a concentration of 80 per cent to 100 per cent of full scale of the normal operating range shall be passed through the CLD or HCLD; the NO value shall be recorded as *D*. The NO span gas shall then be bubbled through water at room temperature and passed through the CLD or HCLD; the NO value shall be recorded as *C*. The analyser's absolute operating pressure and the water temperature shall be determined and recorded as *E* and *F*, respectively. The mixture's saturation vapour pressure that corresponds to the water temperature of the bubbler *F* shall be determined and recorded as *G*. The water vapour concentration *H* [%] of the gas mixture shall be calculated as:

▼ C2

$$H = \frac{G}{E} \times 100$$

▼ B

The expected concentration of the diluted NO-water vapour span gas shall be recorded as *D_e* after being calculated as:

$$D_e = D \times \left(1 - \frac{H}{100}\right)$$

For diesel exhaust, the maximum concentration of water vapour in the exhaust gas (in per cent) expected during the test shall be recorded as *H_m* after being estimated, under the assumption of a fuel H/C ratio of 1.8/1, from the maximum CO₂ concentration in the exhaust gas *A* as follows:

$$H_m = 0,9 \times A$$

The per cent water quench shall be calculated as:

$$E_{H_2O} = \left(\left(\frac{D_e - C}{D_e} \right) \times \left(\frac{H_m}{H} \right) \right) \times 100$$

where:

D_e is the expected diluted NO concentration [ppm]

▼B

C is the measured diluted NO concentration [ppm]

H_m is the maximum water vapour concentration [%]

H is the actual water vapour concentration [%]

(iii) Maximum allowable quench

The combined CO₂ and water quench shall not exceed 2 per cent of full scale.

(d) Quench check for NDUV analysers

Hydrocarbons and water can positively interfere with NDUV analysers by causing a response similar to that of NO_x. The manufacturer of the NDUV analyser shall use the following procedure to verify that quench effects are limited:

- (i) The analyser and chiller shall be set up by following the operating instructions of the manufacturer; adjustments should be made as to optimise the analyser and chiller performance.
- (ii) A zero calibration and span calibration at concentration values expected during emissions testing shall be performed for the analyser.
- (iii) A NO₂ calibration gas shall be selected that matches as far as possible the maximum NO₂ concentration expected during emissions testing.
- (iv) The NO₂ calibration gas shall overflow at the gas sampling system's probe until the NO_x response of the analyser has stabilised.
- (v) The mean concentration of the stabilized NO_x recordings over a period of 30 s shall be calculated and recorded as NO_{x,ref}.
- (vi) The flow of the NO₂ calibration gas shall be stopped and the sampling system saturated by overflowing with a dew point generator's output, set at a dew point of 50 °C. The dew point generator's output shall be sampled through the sampling system and chiller for at least 10 minutes until the chiller is expected to be removing a constant rate of water.
- (vii) Upon completion of (iv), the sampling system shall again be overflowed by the NO₂ calibration gas used to establish NO_{x,ref} until the total NO_x response has stabilized.
- (viii) The mean concentration of the stabilized NO_x recordings over a period of 30 s shall be calculated and recorded as NO_{x,m}.
- (ix) NO_{x,m} shall be corrected to NO_{x,dry} based upon the residual water vapour that passed through the chiller at the chiller's outlet temperature and pressure.

The calculated NO_{x,dry} shall at least amount to 95 % of NO_{x,ref}.

▼ B

(e) Sample dryer

A sample dryer removes water, which can otherwise interfere with the NO_x measurement. For dry CLD analysers, it shall be demonstrated that at the highest expected water vapour concentration H_m the sample dryer maintains the CLD humidity at ≤ 5 g water/kg dry air (or about 0.8 per cent H₂O), which is 100 per cent relative humidity at 3.9 °C and 101.3 kPa or about 25 per cent relative humidity at 25 °C and 101.3 kPa. Compliance may be demonstrated by measuring the temperature at the outlet of a thermal sample dryer or by measuring the humidity at a point just upstream of the CLD. The humidity of the CLD exhaust might also be measured as long as the only flow into the CLD is the flow from the sample dryer.

(f) Sample dryer NO₂ penetration

Liquid water remaining in an improperly designed sample dryer can remove NO₂ from the sample. If a sample dryer is used in combination with a NDUV analyser without an NO₂/NO converter upstream, water could therefore remove NO₂ from the sample prior to the NO_x measurement. The sample dryer shall allow for measuring at least 95 per cent of the NO₂ contained in a gas that is saturated with water vapour and consists of the maximum NO₂ concentration expected to occur during emission testing.

4.4. **Response time check of the analytical system**

For the response time check, the settings of the analytical system shall be exactly the same as during the emissions test (i.e. pressure, flow rates, filter settings in the analysers and all other parameters influencing the response time). The response time shall be determined with gas switching directly at the inlet of the sample probe. The gas switching shall be done in less than 0.1 second. The gases used for the test shall cause a concentration change of at least 60 per cent full scale of the analyser.

The concentration trace of each single gas component shall be recorded. The delay time is defined as the time from the gas switching (t_0) until the response is 10 per cent of the final reading (t_{10}). The rise time is defined as the time between 10 per cent and 90 per cent response of the final reading ($t_{90} - t_{10}$). The system response time (t_{90}) consists of the delay time to the measuring detector and the rise time of the detector.

For time alignment of the analyser and exhaust flow signals, the transformation time is defined as the time from the change (t_0) until the response is 50 per cent of the final reading (t_{50}).

The system response time shall be ≤ 12 s with a rise time of ≤ 3 seconds for all components and all ranges used. When using a NMC for the measurement of NMHC, the system response time may exceed 12 seconds.

5. GASES

▼ M35.1. **Calibration and span gases for RDE tests**5.1.1. *General*

The shelf life of calibration and span gases shall be respected. Pure as well as mixed calibration and span gases shall fulfil the specifications of Sub-Annex 5 of Annex XXI to this Regulation.

▼ M35.1.2. *NO₂ calibration gas*

In addition, NO₂ calibration gas is permissible. The concentration of the NO₂ calibration gas shall be within two per cent of the declared concentration value. The amount of NO contained in the NO₂ calibration gas shall not exceed 5 per cent of the NO₂ content.

5.1.3. *Multicomponent mixtures*

Only multicomponent mixtures which fulfil the requirements of point 5.1.1. shall be used. These mixtures may contain two or more of the components. Multicomponent mixtures containing both NO and NO₂ are exempted of the NO₂ impurity requirement set out in points 5.1.1 and 5.1.2.

▼ B5.2. **Gas dividers**

Gas dividers, i.e., precision blending devices that dilute with purified N₂ or synthetic air, can be used to obtain calibration and span gases. The accuracy of the gas divider shall be such that the concentration of the blended calibration gases is accurate to within ± 2 per cent. The verification shall be performed at between 15 and 50 per cent of full scale for each calibration incorporating a gas divider. An additional verification may be performed using another calibration gas, if the first verification has failed.

Optionally, the gas divider may be checked with an instrument which by nature is linear, e.g. using NO gas in combination with a CLD. The span value of the instrument shall be adjusted with the span gas directly connected to the instrument. The gas divider shall be checked at the settings typically used and the nominal value shall be compared with the concentration measured by the instrument. The difference shall in each point be within ± 1 per cent of the nominal concentration value.

5.3. **Oxygen interference check gases**

Oxygen interference check gases consist of a blend of propane, oxygen and nitrogen and shall contain propane at a concentration of 350 ± 75 ppmC₁. The concentration shall be determined by gravimetric methods, dynamic blending or the chromatographic analysis of total hydrocarbons plus impurities. The oxygen concentrations of the oxygen interference check gases shall meet the requirements listed in Table 3; the remainder of the oxygen interference check gas shall consist of purified nitrogen.

Table 3

Oxygen interference check gases

	Engine type	
	Compression ignition	Positive ignition
O ₂ concentration	21 \pm 1 %	10 \pm 1 %
	10 \pm 1 %	5 \pm 1 %
	5 \pm 1 %	0,5 \pm 0,5 %

▼ M1

6. ANALYSERS FOR MEASURING (SOLID) PARTICLE EMISSIONS

▼ B

This sections will define future requirement for analysers for measuring particle number emissions, once their measurement becomes mandatory.

▼ **M1**6.1. **General**

The PN analyser shall consist of a pre-conditioning unit and a particle detector that counts with 50 % efficiency from approximately 23 nm. It is permissible that the particle detector also pre-conditions the aerosol. The sensitivity of the analysers to shocks, vibration, aging, variability in temperature and air pressure as well as electromagnetic interferences and other impacts related to vehicle and analyser operation shall be limited as far as possible and shall be clearly stated by the equipment manufacturer in its support material. The PN analyser shall only be used within its manufacturer's declared parameters of operation.

Figure 1

Example of a PN analyser setup: Dotted lines depict optional parts.
EFM = Exhaust mass Flow Meter, d = inner diameter, PND = Particle Number Diluter.

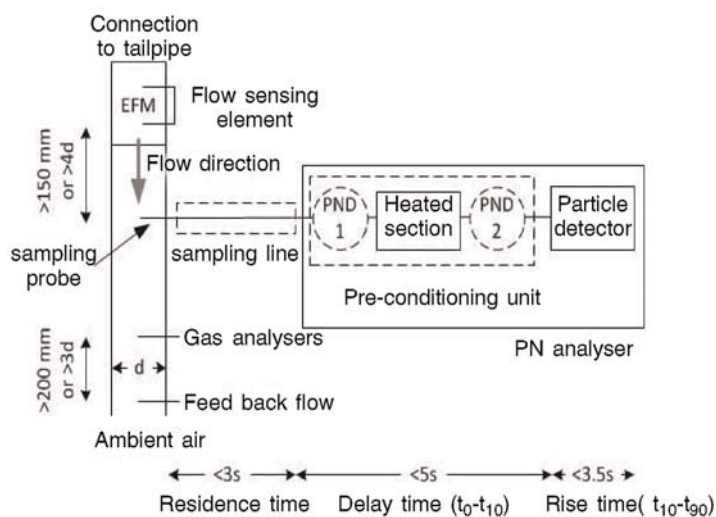

The PN analyser shall be connected to the sampling point via a sampling probe which extracts a sample from the centreline of the tailpipe tube. As specified in point 3.5 of Appendix 1, if particles are not diluted at the tailpipe, the sampling line shall be heated to a minimum temperature of 373 K (100 °C) until the point of first dilution of the PN analyser or the particle detector of the analyser. The residence time in the sampling line shall be less than 3 s.

All parts in contact with the sampled exhaust gas shall be always kept at a temperature that avoids condensation of any compound in the device. This can be achieved, e.g. by heating at a higher temperature and diluting the sample or oxidizing the (semi)volatile species.

The PN analyser shall include a heated section at wall temperature ≥ 573 K. The unit shall control the heated stages to constant nominal operating temperatures, within a tolerance of ± 10 K and provide an indication of whether or not heated stages are at their correct operating temperatures. Lower temperatures are acceptable as long as the volatile particle removal efficiency fulfils the specifications of 6.4.

▼ M1

Pressure, temperature and other sensors shall monitor the proper operation of the instrument during operation and trigger a warning or message in case of malfunction.

The delay time of the PN analyser shall be ≤ 5 s.

The PN analyser (and/or particle detector) shall have a rise time of $\leq 3,5$ s.

Particle concentration measurements shall be reported normalised to 273 K and 101,3 kPa. If necessary, the pressure and/or temperature at the inlet of the detector shall be measured and reported for the purposes of normalizing the particle concentration.

PN systems that comply with the calibration requirements of the UNECE Regulations 83 or 49 or GTR 15 automatically comply with the calibration requirements of this Annex.

6.2. Efficiency requirements

The complete PN analyser system including the sampling line shall fulfil the efficiency requirements of Table 3a.

Table 3a

PN analyser (including the sampling line) system efficiency requirements

d_p [nm]	Sub-23	23	30	50	70	100	200
E(d_p) PN analyser	To be determined	0,2 – 0,6	0,3 – 1,2	0,6 – 1,3	0,7 – 1,3	0,7 – 1,3	0,5 – 2,0

Efficiency E(d_p) is defined as the ratio in the readings of the PN analyser system to a reference Condensation Particle Counter (CPC)'s ($d_{50} \% = 10$ nm or lower, checked for linearity and calibrated with an electrometer) or an Electrometer's number concentration measuring in parallel mono-disperse aerosol of mobility diameter d_p and normalized at the same temperature and pressure conditions.

The efficiency requirements will need to be adapted, in order to make sure that the efficiency of the PN analysers remains consistent with the margin PN. The material should be thermally stable soot-like (e.g. spark discharged graphite or diffusion flame soot with thermal pre-treatment). If the efficiency curve is measured with a different aerosol (e.g. NaCl), the correlation to the soot-like curve must be provided as a chart, which compares the efficiencies obtained using both test aerosols. The differences in the counting efficiencies have to be taken into account by adjusting the measured efficiencies based on the provided chart to give soot-like aerosol efficiencies. The correction for multiply charged particles should be applied and documented but shall not exceed 10 %. These efficiencies refer to the PN analysers with the sampling line. The PN analyser can also be calibrated in parts (i.e. the pre-conditioning unit separately from the particle detector) as long as it is proven that PN analyser and the sampling line together fulfil the requirements of Table 3a. The measured signal from the detector shall be > 2 times the limit of detection (here defined as the zero level plus 3 standard deviations).

▼ M1**6.3. Linearity requirements**

The PN analyser including the sampling line shall fulfil the linearity requirements of point 3.2 in Appendix 2 using monodisperse or polydisperse soot-like particles. The particle size (mobility diameter or count median diameter) should be larger than 45 nm. The reference instrument shall be an Electrometer or a Condensation Particle Counter (CPC) with $d_{50} = 10$ nm or lower, verified for linearity. Alternatively, a particle number system compliant with UNECE Regulation 83.

In addition the differences of the PN analyser from the reference instrument at all points checked (except the zero point) shall be within 15 % of their mean value. At least 5 points equally distributed (plus the zero) shall be checked. The maximum checked concentration shall be the maximum allowed concentration of the PN analyser.

If the PN analyser is calibrated in parts, then the linearity can be checked only for the PN detector, but the efficiencies of the rest parts and the sampling line have to be considered in the slope calculation.

6.4. Volatile removal efficiency

The system shall achieve > 99 % removal of ≥ 30 nm tetracontane ($\text{CH}_3(\text{CH}_2)_{38}\text{CH}_3$) particles with an inlet concentration of $\geq 10\,000$ particles per cubic-centimetre at the minimum dilution.

The system shall also achieve a > 99 % removal efficiency of polydisperse alkane (decane or higher) or emery oil with count median diameter > 50 nm and mass > 1 mg/m^3 .

The volatile removal efficiency with tetracontane and/or polydisperse alkane or oil have to be proven only once for the instrument family. The instrument manufacturer though has to provide the maintenance or replacement interval that ensures that the removal efficiency does not drop below the technical requirements. If such information is not provided, the volatile removal efficiency has to be checked yearly for each instrument.

▼ B**7. INSTRUMENTS FOR MEASURING EXHAUST MASS FLOW****7.1. General**

Instruments, sensors or signals for measuring the exhaust mass flow rate shall have a measuring range and response time appropriate for the accuracy required to measure the exhaust mass flow rate under transient and steady state conditions. The sensitivity of instruments, sensors and signals to shocks, vibration, aging, variability in temperature, ambient air pressure, electromagnetic interferences and other impacts related to vehicle and instrument operation shall be on a level as to minimize additional errors.

7.2. Instrument specifications

The exhaust mass flow rate shall be determined by a direct measurement method applied in either of the following instruments:

- (a) Pitot-based flow devices;
- (b) Pressure differential devices like flow nozzle (details see ISO 5167);
- (c) Ultrasonic flow meter;
- (d) Vortex flow meter.

▼ B

Each individual exhaust mass flow meter shall fulfil the linearity requirements set out in point 3. Furthermore, the instrument manufacturer shall demonstrate the compliance of each type of exhaust mass flow meter with the specifications in points 7.2.3 to 7.2.9.

It is permissible to calculate the exhaust mass flow rate based on air flow and fuel flow measurements obtained from traceably calibrated sensors if these fulfil the linearity requirements of point 3, the accuracy requirements of point 8 and if the resulting exhaust mass flow rate is validated according to point 4 of Appendix 3.

In addition, other methods that determine the exhaust mass flow rate based on not directly traceable instruments and signals, such as simplified exhaust mass flow meters or ECU signals are permissible if the resulting exhaust mass flow rate fulfils the linearity requirements of point 3 and is validated according to point 4 of Appendix 3.

7.2.1. Calibration and verification standards

The measurement performance of exhaust mass flow meters shall be verified with air or exhaust gas against a traceable standard such as, e.g. a calibrated exhaust mass flow meter or a full flow dilution tunnel.

7.2.2. Frequency of verification

The compliance of exhaust mass flow meters with points 7.2.3 and 7.2.9 shall be verified no longer than one year before the actual test.

▼ M3**7.2.3. Accuracy**

The accuracy of the EFM, defined as the deviation of the EFM reading from the reference flow value, shall not exceed ± 3 percent of the reading, 0,5 % of full scale or $\pm 1,0$ per cent of the maximum flow at which the EFM has been calibrated, whichever is larger.

▼ B**7.2.4. Precision**

The precision, defined as 2,5 times the standard deviation of 10 repetitive responses to a given nominal flow, approximately in the middle of the calibration range, shall not exceed 1 per cent of the maximum flow at which the EFM has been calibrated.

▼ M3**7.2.5. Noise**

The noise shall not exceed 2 per cent of the maximum calibrated flow value. Each of the 10 measurement periods shall be interspersed with an interval of 30 seconds in which the EFM is exposed to the maximum calibrated flow.

▼ B**7.2.6. Zero response drift**

The zero response drift is defined as the mean response to zero flow during a time interval of at least 30 seconds. The zero response drift can be verified based on the reported primary signals, e.g., pressure. The drift of the primary signals over a period of 4 hours shall be less than ± 2 per cent of the maximum value of the primary signal recorded at the flow at which the EFM was calibrated.

▼B**7.2.7. Span response drift**

The span response drift is defined as the mean response to a span flow during a time interval of at least 30 seconds. The span response drift can be verified based on the reported primary signals, e.g., pressure. The drift of the primary signals over a period of 4 hours shall be less than ± 2 per cent of the maximum value of the primary signal recorded at the flow at which the EFM was calibrated.

7.2.8. Rise time

The rise time of the exhaust flow instruments and methods should match as far as possible the rise time of the gas analysers as specified in point 4.2.7 but shall not exceed 1 second.

7.2.9. Response time check

The response time of exhaust mass flow meters shall be determined by applying similar parameters as those applied for the emissions test (i.e., pressure, flow rates, filter settings and all other response time influences). The response time determination shall be done with gas switching directly at the inlet of the exhaust mass flow meter. The gas flow switching shall be done as fast as possible, but highly recommended in less than 0,1 second. The gas flow rate used for the test shall cause a flow rate change of at least 60 per cent full scale of the exhaust mass flow meter. The gas flow shall be recorded. The delay time is defined as the time from the gas flow switching (t_0) until the response is 10 per cent (t_{10}) of the final reading. The rise time is defined as the time between 10 per cent and 90 per cent response ($t_{90} - t_{10}$) of the final reading. The response time (t_{90}) is defined as the sum of the delay time and the rise time. The exhaust mass flow meter response time (t_{90}) shall be ≤ 3 seconds with a rise time ($t_{90} - t_{10}$) of ≤ 1 second in accordance with point 7.2.8.

8. SENSORS AND AUXILIARY EQUIPMENT

Any sensor and auxiliary equipment used to determine, e.g., temperature, atmospheric pressure, ambient humidity, vehicle speed, fuel flow or intake air flow shall not alter or unduly affect the performance of the vehicle's engine and exhaust after-treatment system. The accuracy of sensors and auxiliary equipment shall fulfil the requirements of Table 4. Compliance with the requirements of Table 4 shall be demonstrated at intervals specified by the instrument manufacturer, as required by internal audit procedures or in accordance with ISO 9000.

Table 4

Accuracy requirements for measurement parameters

Measurement parameter	Accuracy
Fuel flow ⁽¹⁾	± 1 % of reading ⁽³⁾
Air flow ⁽¹⁾	± 2 % of reading
Vehicle speed ⁽²⁾	$\pm 1,0$ km/h absolute
Temperatures ≤ 600 K	± 2 K absolute

▼ B

Measurement parameter	Accuracy
Temperatures >600 K	± 0,4 % of reading in Kelvin
Ambient pressure	± 0,2 kPa absolute
Relative humidity	± 5 % absolute
Absolute humidity	± 10 % of reading or, 1 gH ₂ O/kg dry air, whichever is larger

(¹) optional to determine exhaust mass flow

(²) This requirement applies to the speed sensor only; if vehicle speed is used to determine parameters like acceleration, the product of speed and positive acceleration, or RPA, the speed signal shall have an accuracy of 0,1 % above 3 km/h and a sampling frequency of 1 Hz. This accuracy requirement can be met by using the signal of a wheel rotational speed sensor.

(³) The accuracy shall be 0,02 per cent of reading if used to calculate the air and exhaust mass flow rate from the fuel flow according to point 10 of Appendix 4.

▼B*Appendix 3***Validation of PEMS and non-traceable exhaust mass flow rate**

1. INTRODUCTION

This appendix describes the requirements to validate under transient conditions the functionality of the installed PEMS as well as the correctness of the exhaust mass flow rate obtained from non-traceable exhaust mass flow meters or calculated from ECU signals.

2. SYMBOLS, PARAMETERS AND UNITS

%	—	per cent
#/km	—	number per kilometre
a_0	—	y intercept of the regression line
a_1	—	slope of the regression line
g/km	—	gramme per kilometre
Hz	—	hertz
km	—	kilometre
m	—	metre
mg/km	—	milligramme per kilometre
r^2	—	coefficient of determination
x	—	actual value of the reference signal
y	—	actual value of the signal under validation

3. VALIDATION PROCEDURE FOR PEMS

3.1. **Frequency of PEMS validation**

It is recommended to validate the installed PEMS once for each PEMS-vehicle combination either before the RDE test or, alternatively, after the completion of the test.

3.2. **PEMS validation procedure**3.2.1. *PEMS installation*

The PEMS shall be installed and prepared according to the requirements of Appendix 1. The PEMS installation shall be kept unchanged in the time period between the validation and the RDE test.

▼M33.2.2. *Test conditions*

The validation test shall be conducted on a chassis dynamometer, as far as possible, under type approval conditions by following the requirements of Annex XXI to this Regulation. It is recommended to feed the exhaust flow extracted by the PEMS during the validation test back to the CVS. If this is not feasible, the CVS results shall be corrected for the extracted exhaust mass. If the exhaust mass flow rate is validated with an exhaust mass flow meter, it is recommended to cross-check the mass flow rate measurements with data obtained from a sensor or the ECU.

▼ M33.2.3. *Data analysis*

The total distance-specific emissions [g/km] measured with laboratory equipment shall be calculated in accordance to Sub-Annex 7 of Annex XXI. The emissions as measured with the PEMS shall be calculated in accordance with point 9 of Appendix 4, summed to give the total mass of pollutant emissions [g] and then divided by the test distance [km] as obtained from the chassis dynamometer. The total distance-specific mass of pollutants [g/km], as determined by the PEMS and the reference laboratory system, shall be evaluated against the requirements specified in point 3.3. For the validation of NOX emission measurements, humidity correction shall be applied in accordance with Sub-Annex 7 of Annex XXI to this Regulation.

▼ B3.3. **Permissible tolerances for PEMS validation**

The PEMS validation results shall fulfil the requirements given in Table 1. If any permissible tolerance is not met, corrective action shall be taken and the PEMS validation shall be repeated.

▼ M1

Table 1

Permissible tolerances

Parameter [Unit]	Permissible absolute tolerance
Distance [km] ⁽¹⁾	250 m of the laboratory reference
THC ⁽²⁾ [mg/km]	15 mg/km or 15 % of the laboratory reference, whichever is larger
CH ₄ ⁽²⁾ [mg/km]	15 mg/km or 15 % of the laboratory reference, whichever is larger
NMHC ⁽²⁾ [mg/km]	20 mg/km or 20 % of the laboratory reference, whichever is larger
PN ⁽²⁾ [# /km]	1•10 ¹¹ p/km or 50 % of the laboratory reference ⁽³⁾ whichever is larger
CO ⁽²⁾ [mg/km]	150 mg/km or 15 % of the laboratory reference, whichever is larger
CO ₂ [g/km]	10 g/km or 10 % of the laboratory reference, whichever is larger
NO _x ⁽²⁾ [mg/km]	15 mg/km or 15 % of the laboratory reference, whichever is larger

⁽¹⁾ only applicable if vehicle speed is determined by the ECU; to meet the permissible tolerance it is permitted to adjust the ECU vehicle speed measurements based on the outcome of the validation test

⁽²⁾ parameter only mandatory if measurement required by point 2.1 of this Annex.

⁽³⁾ PMP system.

▼B

4. VALIDATION PROCEDURE FOR THE EXHAUST MASS FLOW RATE DETERMINED BY NON-TRACEABLE INSTRUMENTS AND SENSORS

▼M3

- 4.1. **Frequency of validation**

In addition to fulfilling the linearity requirements of point 3 of Appendix 2 under steady-state conditions, the linearity of non-traceable exhaust mass flow meters or the exhaust mass flow rate calculated from non-traceable sensors or ECU signals shall be validated under transient conditions for each test vehicle against a calibrated exhaust mass flow meter or the CVS.

- 4.2. **Validation procedure**

The validation shall be conducted on a chassis dynamometer under type approval conditions, as far as applicable. As reference, a traceably calibrated flow meter shall be used. The ambient temperature can be any within the range specified in point 5.2. of this Annex. The installation of the exhaust mass flow meter and the execution of the test shall fulfil the requirement of point 3.4.3 of Appendix 1 to this Annex.

▼B

- 4.3. **Requirements**

The linearity requirements given in Table 2 shall be fulfilled. If any permissible tolerance is not met, corrective action shall be taken and the validation shall be repeated.

Table 2

Linearity requirements of calculated and measured exhaust mass flow

Measurement parameter/system	a_0	Slope a_1	Standard error SEE	Coefficient of determination r^2
Exhaust mass flow	$0,0 \pm 3,0$ kg/h	$1,00 \pm 0,075$	≤ 10 % max	$\geq 0,90$

▼ B*Appendix 4***Determination of emissions****▼ M3**

1. INTRODUCTION

This Appendix describes the procedure to determine the instantaneous mass and particle number emissions [g/s; #/s] that shall be used for the subsequent evaluation of an RDE trip and the calculation of the final emission result as described in Appendix 6.

▼ B

2. SYMBOLS, PARAMETERS AND UNITS

%	—	per cent
<	—	smaller than
#/s	—	number per second
α	—	molar hydrogen ratio (H/C)
β	—	molar carbon ratio (C/C)
γ	—	molar sulphur ratio (S/C)
δ	—	molar nitrogen ratio (N/C)
$\Delta t_{t,i}$	—	transformation time t of the analyser [s]
$\Delta t_{t,m}$	—	transformation time t of the exhaust mass flow meter [s]
ε	—	molar oxygen ratio (O/C)
ρ_e	—	density of the exhaust
ρ_{gas}	—	density of the exhaust component 'gas'
λ	—	excess air ratio
λ_i	—	instantaneous excess air ratio
A/F_{st}	—	stoichiometric air-to-fuel ratio [kg/kg]
°C	—	degrees centigrade
c_{CH_4}	—	concentration of methane
c_{CO}	—	dry CO concentration [%]
c_{CO_2}	—	dry CO ₂ concentration [%]
c_{dry}	—	dry concentration of a pollutant in ppm or per cent volume
$c_{\text{gas},i}$	—	instantaneous concentration of the exhaust component 'gas' [ppm]
c_{HCw}	—	wet HC concentration [ppm]
$c_{\text{HC(w/NMC)}}$	—	HC concentration with CH ₄ or C ₂ H ₆ flowing through the NMC [ppmC ₁]

▼ B

$c_{\text{HC(w/oNMC)}}$	— HC concentration with CH ₄ or C ₂ H ₆ bypassing the NMC [ppmC ₁]
$c_{i,c}$	— time-corrected concentration of component i [ppm]
$c_{i,r}$	— concentration of component i [ppm] in the exhaust
c_{NMHC}	— concentration of non-methane hydrocarbons
c_{wet}	— wet concentration of a pollutant in ppm or per cent volume
E_E	— ethane efficiency
E_M	— methane efficiency
g	— gramme
g/s	— gramme per second
H_a	— intake air humidity [g water per kg dry air]
i	— number of the measurement
kg	— kilogramme
kg/h	— kilogramme per hour
kg/s	— kilogramme per second
k_w	— dry-wet correction factor
m	— metre
$m_{\text{gas},i}$	— mass of the exhaust component ‘gas’ [g/s]
$q_{\text{maw},i}$	— instantaneous intake air mass flow rate [kg/s]
$q_{m,c}$	— time-corrected exhaust mass flow rate [kg/s]
$q_{\text{mew},i}$	— instantaneous exhaust mass flow rate [kg/s]
$q_{mf,i}$	— instantaneous fuel mass flow rate [kg/s]
$q_{m,r}$	— raw exhaust mass flow rate [kg/s]
r	— cross-correlation coefficient
r^2	— coefficient of determination
r_h	— hydrocarbon response factor
rpm	— revolutions per minute
s	— second
u_{gas}	— u value of the exhaust component ‘gas’

▼ B**3. TIME CORRECTION OF PARAMETERS**

For the correct calculation of distance-specific emissions, the recorded traces of component concentrations, exhaust mass flow rate, vehicle speed, and other vehicle data shall be time corrected. To facilitate the time correction, data which are subject to time alignment shall be recorded either in a single data recording device or with a synchronised timestamp following point 5.1 of Appendix 1. The time correction and alignment of parameters shall be carried out by following the sequence described in points 3.1 to 3.3.

3.1. Time correction of component concentrations

The recorded traces of all component concentrations shall be time corrected by reverse shifting according to the transformation times of the respective analysers. The transformation time of analysers shall be determined according to point 4.4 of Appendix 2:

$$c_{i,c}(t - \Delta t_{t,i}) = c_{i,r}(t)$$

where:

$c_{i,c}$ is the time-corrected concentration of component i as function of time t

$c_{i,r}$ is the raw concentration of component i as function of time t

$\Delta t_{t,i}$ is the transformation time t of the analyser measuring component i

3.2. Time correction of exhaust mass flow rate**▼ M3**

The exhaust mass flow rate measured with an exhaust flow meter shall be time corrected by reverse shifting according to the transformation time of the exhaust mass flow meter. The transformation time of the mass flow meter shall be determined according to point 4.4. of Appendix 2:

▼ B

$$q_{m,c}(t - \Delta t_{t,m}) = q_{m,r}(t)$$

where:

$q_{m,c}$ is the time-corrected exhaust mass flow rate as function of time t

$q_{m,r}$ is the raw exhaust mass flow rate as function of time t

$\Delta t_{t,m}$ is the transformation time t of the exhaust mass flow meter

In case the exhaust mass flow rate is determined by ECU data or a sensor, an additional transformation time shall be considered and obtained by cross-correlation between the calculated exhaust mass flow rate and the exhaust mass flow rate measured following point 4 of Appendix 3.

3.3. Time alignment of vehicle data

Other data obtained from a sensor or the ECU shall be time-aligned by cross-correlation with suitable emission data (e.g., component concentrations).

▼ B3.3.1. *Vehicle speed from different sources*

To time align vehicle speed with the exhaust mass flow rate, it is first necessary to establish one valid speed trace. In case vehicle speed is obtained from multiple sources (e.g., the GPS, a sensor or the ECU), the speed values shall be time aligned by cross-correlation.

3.3.2. *Vehicle speed with exhaust mass flow rate*

Vehicle speed shall be time aligned with the exhaust mass flow rate by cross-correlation between the exhaust mass flow rate and the product of vehicle speed and positive acceleration.

3.3.3. *Further signals*

The time alignment of signals whose values change slowly and within a small value range, e.g. ambient temperature, can be omitted.

▼ M3

4. COLD START

Cold start for the purposes of RDE is the period from the test start until the point when the vehicle has run for 5 minutes. If the coolant temperature is determined, the cold start period ends once the coolant is at least 70 °C for the first time but no later than 5 minutes after test start.

▼ M1

5. EMISSION MEASUREMENTS DURING STOP OF THE COMBUSTION ENGINE

Any instantaneous emissions or exhaust flow measurements obtained while the combustion engine is deactivated shall be recorded. In a separate step, the recorded values shall afterward be set to zero by the data post processing. The combustion engine shall be considered as deactivated if two of the following criteria apply: the recorded engine speed is < 50 rpm; the exhaust mass flow rate is measured at < 3 kg/h; the measured exhaust mass flow rate drops to < 15 % of the typical steady-state exhaust mass flow rate at idling.

▼ B

6. CONSISTENCY CHECK OF VEHICLE ALTITUDE

In case well-reasoned doubts exist that a trip has been conducted above of the permissible altitude as specified in point 5.2 of this Annex and in case altitude has only been measured with a GPS, the GPS altitude data shall be checked for consistency and, if necessary, corrected. The consistency of data shall be checked by comparing the latitude, longitude and altitude data obtained from the GPS with the altitude indicated by a digital terrain model or a topographic map of suitable scale. Measurements that deviate by more than 40 m from the altitude depicted in the topographic map shall be manually corrected and marked.

7. CONSISTENCY CHECK OF GPS VEHICLE SPEED

The vehicle speed as determined by the GPS shall be checked for consistency by calculating and comparing the total trip distance with reference measurements obtained from either a sensor, the validated ECU or, alternatively, from a digital road network or topographic map. It is mandatory to correct GPS data for obvious errors, e.g., by applying a dead reckoning sensor, prior to the consistency check. The original and uncorrected data file shall be retained and any corrected data shall be marked. The corrected data shall not exceed an uninterrupted time period of 120 s or a total of 300 s. The total trip distance as calculated from the

▼B

corrected GPS data shall deviate by no more than 4 % from the reference. If the GPS data do not meet these requirements and no other reliable speed source is available, the test results shall be voided.

8. CORRECTION OF EMISSIONS

8.1. **Dry-wet correction**

If the emissions are measured on a dry basis, the measured concentrations shall be converted to a wet basis as:

where:

$$c_{\text{wet}} = k_w \times c_{\text{dry}}$$

c_{wet} is the wet concentration of a pollutant in ppm or per cent volume

c_{dry} is the dry concentration of a pollutant in ppm or per cent volume

k_w is the dry-wet correction factor

The following equation shall be used to calculate k_w :

$$k_w = \left(\frac{1}{1 + \alpha \times 0,005 \times (c_{\text{CO}_2} + c_{\text{CO}})} - k_{w1} \right) \times 1,008$$

where:

$$k_{w1} = \frac{1,608 \times H_a}{1\,000 + (1,608 \times H_a)}$$

where:

H_a is the intake air humidity [g water per kg dry air]

c_{CO_2} is the dry CO₂ concentration [%]

c_{CO} is the dry CO concentration [%]

α is the molar hydrogen ratio

8.2. **Correction of NO_x for ambient humidity and temperature**

NO_x emissions shall not be corrected for ambient temperature and humidity.

▼M38.3. **Correction of negative emission results**

Negative intermediate results shall not be corrected. Negative final results shall be set to zero.

8.4. **Correction for extended conditions**

The second-by second emissions calculated in accordance with this Appendix may be divided by a value of 1,6 solely for the cases laid down in points 9.5 and 9.6.

The corrective factor of 1,6 shall be applied only once. The corrective factor of 1,6 applies to pollutant emissions but not to CO₂.

▼B

9. DETERMINATION OF THE INSTANTANEOUS GASEOUS EXHAUST COMPONENTS

9.1. **Introduction**

The components in the raw exhaust shall be measured with the measurement and sampling analysers described in Appendix 2. The raw concentrations of relevant components shall be measured in accordance with Appendix 1. The data shall be time corrected and aligned in accordance with point 3.

▼ B**9.2. Calculating NMHC and CH₄ concentrations**

For methane measurement using a NMC-FID, the calculation of NMHC depends on the calibration gas/method used for the zero/span calibration adjustment. When a FID is used for THC measurement without a NMC, it shall be calibrated with propane/air or propane/N₂ in the normal manner. For the calibration of the FID in series with a NMC, the following methods are permitted:

- (a) the calibration gas consisting of propane/air bypasses the NMC;
- (b) the calibration gas consisting of methane/air passes through the NMC.

It is strongly recommended to calibrate the methane FID with methane/air through the NMC.

In method (a), the concentrations of CH₄ and NMHC shall be calculated as follows:

$$c_{CH_4} = \frac{c_{HC(w/oNMC)} \times (1 - E_M) - c_{HC(w/NMC)}}{(E_E - E_M)}$$

$$c_{NMHC} = \frac{c_{HC(w/NMC)} - c_{HC(w/oNMC)} \times (1 - E_E)}{r_h \times (E_E - E_M)}$$

In method (b), the concentration of CH₄ and NMHC shall be calculated as follows:

$$c_{CH_4} = \frac{c_{HC(w/NMC)} \times r_h \times (1 - E_M) - c_{HC(w/oNMC)} \times (1 - E_E)}{r_h \times (E_E - E_M)}$$

$$c_{NMHC} = \frac{c_{HC(w/oNMC)} \times (1 - E_M) - c_{HC(w/NMC)} \times r_h \times (1 - E_M)}{(E_E - E_M)}$$

where:

$c_{HC(w/oNMC)}$	is the HC concentration with CH ₄ or C ₂ H ₆ bypassing the NMC [ppmC ₁]
$c_{HC(w/NMC)}$	is the HC concentration with CH ₄ or C ₂ H ₆ flowing through the NMC [ppmC ₁]
r_h	is the hydrocarbon response factor as determined in point 4.3.3.(b) of Appendix 2
E_M	is the methane efficiency as determined in point 4.3.4.(a) of Appendix 2
E_E	is the ethane efficiency as determined in point 4.3.4.(b) of Appendix 2

If the methane FID is calibrated through the cutter (method b), then the methane conversion efficiency as determined in point 4.3.4.(a) of Appendix 2 is zero. The density used for calculating the NMHC mass shall be equal to that of total hydrocarbons at 273,15 K and 101,325 kPa and is fuel-dependent.

10. DETERMINATION OF EXHAUST MASS FLOW RATE**10.1. Introduction**

The calculation of instantaneous mass emissions according to points 11 and 12 requires determining the exhaust mass flow rate. The exhaust mass

▼B

flow rate shall be determined by one of the direct measurement methods specified in point 7.2 of Appendix 2. Alternatively, it is permissible to calculate the exhaust mass flow rate as described in points 10.2 to 10.4.

10.2. Calculation method using air mass flow rate and fuel mass flow rate

The instantaneous exhaust mass flow rate can be calculated from the air mass flow rate and the fuel mass flow rate as follows:

$$q_{mew,i} = q_{maw,i} + q_{mf,i}$$

where:

$q_{mew,i}$ is the instantaneous exhaust mass flow rate [kg/s]

$q_{maw,i}$ is the instantaneous intake air mass flow rate [kg/s]

$q_{mf,i}$ is the instantaneous fuel mass flow rate [kg/s]

If the air mass flow rate and the fuel mass flow rate or the exhaust mass flow rate are determined from ECU recording, the calculated instantaneous exhaust mass flow rate shall meet the linearity requirements specified for the exhaust mass flow rate in point 3 of Appendix 2 and the validation requirements specified in point 4.3 of Appendix 3.

10.3. Calculation method using air mass flow and air-to-fuel ratio

The instantaneous exhaust mass flow rate can be calculated from the air mass flow rate and the air-to-fuel ratio as follows:

$$q_{mew,i} = q_{maw,i} \times \left(1 + \frac{1}{A/F_{st} \cdot \lambda_i} \right)$$

where:

$$A/F_{st} = \frac{138,0 \times \left(1 + \frac{\alpha}{4} - \frac{\varepsilon}{2} + \gamma \right)}{12,011 + 1,008 \times \alpha + 15,9994 \times \varepsilon + 14,0067 \times \delta + 32,0675 \times \gamma}$$

$$\lambda_i = \frac{\left(100 - \frac{c_{CO} \times 10^{-4}}{2} - c_{HCw} \times 10^{-4} \right) + \left(\frac{\alpha}{4} \times \frac{1 - \frac{2 \times c_{CO} \times 10^{-4}}{3,5 \times c_{CO_2}}}{1 + \frac{c_{CO} \times 10^{-4}}{3,5 \times c_{CO_2}}} - \frac{\varepsilon}{2} - \frac{\delta}{2} \right) \times (c_{CO_2} + c_{CO} \times 10^{-4})}{4,764 \times \left(1 + \frac{\alpha}{4} - \frac{\varepsilon}{2} + \gamma \right) \times (c_{CO_2} + c_{CO} \times 10^{-4} + c_{HCw} \times 10^{-4})}$$

where:

$q_{maw,i}$ is the instantaneous intake air mass flow rate [kg/s]

A/F_{st} is the stoichiometric air-to-fuel ratio [kg/kg]

λ_i is the instantaneous excess air ratio

c_{CO_2} is the dry CO₂ concentration [%]

c_{CO} is the dry CO concentration [ppm]

c_{HCw} is the wet HC concentration [ppm]

α is the molar hydrogen ratio (H/C)

▼ B

- β is the molar carbon ratio (C/C)
- γ is the molar sulphur ratio (S/C)
- δ is the molar nitrogen ratio (N/C)
- ε is the molar oxygen ratio (O/C)

Coefficients refer to a fuel $C_\beta H_\alpha O_\varepsilon N_\delta S_\gamma$ with $\beta = 1$ for carbon based fuels. The concentration of HC emissions is typically low and may be omitted when calculating λ_i .

If the air mass flow rate and air-to-fuel ratio are determined from ECU recording, the calculated instantaneous exhaust mass flow rate shall meet the linearity requirements specified for the exhaust mass flow rate in point 3 of Appendix 2 and the validation requirements specified in point 4.3 of Appendix 3.

10.4. Calculation method using fuel mass flow and air-to-fuel ratio

The instantaneous exhaust mass flow rate can be calculated from the fuel flow and the air-to-fuel ratio (calculated with A/F_{st} and λ_i according to point 10.3) as follows:

$$q_{mew,i} = q_{mf,i} \times (1 + A/F_{st} \times \lambda_i)$$

The calculated instantaneous exhaust mass flow rate shall meet the linearity requirements specified for the exhaust gas mass flow rate in point 3 of Appendix 2 and the validation requirements specified in point 4.3 of Appendix 3.

11. CALCULATING THE INSTANTANEOUS MASS EMISSIONS OF GASEOUS COMPONENTS

The instantaneous mass emissions [g/s] shall be determined by multiplying the instantaneous concentration of the pollutant under consideration [ppm] with the instantaneous exhaust mass flow rate [kg/s], both corrected and aligned for the transformation time, and the respective u value of Table 1. If measured on a dry basis, the dry-wet correction according to point 8.1 shall be applied to the instantaneous component concentrations before executing any further calculations. If occurring, negative instantaneous emission values shall enter all subsequent data evaluations. Parameter values shall enter the calculation of instantaneous emissions [g/s] as reported by the analyser, flow-measuring instrument, sensor or the ECU. The following equation shall be applied:

where:

$$m_{gas,i} = u_{gas} \cdot c_{gas,i} \cdot q_{mew,i}$$

$m_{gas,i}$ is the mass of the exhaust component 'gas' [g/s]

u_{gas} is the ratio of the density of the exhaust component 'gas' and the overall density of the exhaust as listed in Table 1

$c_{gas,i}$ is the measured concentration of the exhaust component 'gas' in the exhaust [ppm]

$q_{mew,i}$ is the measured exhaust mass flow rate [kg/s]

gas is the respective component

i number of the measurement

▼ **B**

Table 1

Raw exhaust gas u values depicting the ratio between the densities of exhaust component or pollutant i [kg/m^3] and the density of the exhaust gas [kg/m^3] ⁽⁶⁾

Fuel	ρ_e [kg/m^3]	Component or pollutant i					
		NO _x	CO	HC	CO ₂	O ₂	CH ₄
		ρ_{gas} [kg/m^3]					
		2,053	1,250	(¹)	1,9636	1,4277	0,716
u_{gas} (²), (⁶)							
Diesel (B7)	1,2943	0,001586	0,000966	0,000482	0,001517	0,001103	0,000553
Ethanol (ED95)	1,2768	0,001609	0,000980	0,000780	0,001539	0,001119	0,000561
CNG (³)	1,2661	0,001621	0,000987	0,000528 (⁴)	0,001551	0,001128	0,000565
Propane	1,2805	0,001603	0,000976	0,000512	0,001533	0,001115	0,000559
Butane	1,2832	0,001600	0,000974	0,000505	0,001530	0,001113	0,000558
LPG (⁵)	1,2811	0,001602	0,000976	0,000510	0,001533	0,001115	0,000559
Petrol (E10)	1,2931	0,001587	0,000966	0,000499	0,001518	0,001104	0,000553
Ethanol (E85)	1,2797	0,001604	0,000977	0,000730	0,001534	0,001116	0,000559

(¹) depending on fuel

(²) at $\lambda = 2$, dry air, 273 K, 101.3 kPa

(³) u values accurate within 0,2 % for mass composition of: C=66-76 %; H=22-25 %; N=0-12 %

(⁴) NMHC on the basis of CH_{2,93} (for THC the u_{gas} coefficient of CH₄ shall be used)

(⁵) u accurate within 0,2 % for mass composition of: C₃=70-90 %; C₄=10-30 %

(⁶) u_{gas} is a unitless parameter; the u_{gas} values include unit conversions to ensure that the instantaneous emissions are obtained in the specified physical unit, i.e., g/s

▼ **M1**

12. CALCULATING THE INSTANTANEOUS PARTICLE NUMBER EMISSIONS

The instantaneous particle number emissions [particles/s] shall be determined by multiplying the instantaneous concentration of the pollutant under consideration [particles/cm³] with the instantaneous exhaust mass flow rate [kg/s], both corrected and aligned for the transformation time. If applicable, negative instantaneous emission values shall enter all subsequent data evaluations. All significant digits of intermediate results shall enter the calculation of the instantaneous emissions. The following equation shall apply:

$$PN, i = c_{PN, i} q_{mew, i} / \rho_e$$

where:

PN, i is the particle number flux [particles/s]

$c_{PN, i}$ is the measured particle number concentration [#/ m^3] normalized at 0 °C

$q_{mew, i}$ is the measured exhaust mass flow rate [kg/s]

ρ_e is the density of the exhaust gas [kg/m^3] at 0 °C (Table 1)

▼B

13. DATA REPORTING AND EXCHANGE

The data shall be exchanged between the measurement systems and the data evaluation software by a standardised reporting file as specified in point 2 of Appendix 8. Any pre-processing of data (e.g. time correction according to point 3 or the correction of the GPS vehicle speed signal according to point 7) shall be done with the control software of the measurement systems and shall be completed before the data reporting file is generated. If data are corrected or processed prior to entering the data reporting file, the original raw data shall be kept for quality assurance and control. Rounding of intermediate values is not permitted.

▼ **M3***Appendix 5***Verification of overall trip dynamics using the moving averaging window method****1. Introduction**

The Moving Averaging Window method is used to verify the overall trip dynamics. The test is divided in sub-sections (windows) and the subsequent analysis aims at determining whether the trip is valid for RDE purposes. The ‘normality’ of the windows is conducted by comparing their CO₂ distance-specific emissions with a reference curve obtained from the vehicle CO₂ emissions measured in accordance with the WLTP procedure.

2. Symbols, parameters and units

Index (i) refers to the time step

Index (j) refers to the window

Index (k) refers to the category (t = total, u = urban, r = rural, m- = motorway) or to the CO₂ characteristic curve (cc)

Δ — difference

\geq — larger or equal

— number

% — per cent

\leq — smaller or equal

a_1, b_1 — coefficients of the CO₂ characteristic curve

a_2, b_2 — coefficients of the CO₂ characteristic curve

M_{CO_2} — CO₂ mass, [g]

$M_{CO_2,j}$ — CO₂ mass in window j, [g]

t_i — total time in step i, [s]

t_t — duration of a test, [s]

v_i — actual vehicle speed in time step i, [km/h]

\bar{v}_j — average vehicle speed in window j, [km/h]

tol_{1H} — upper tolerance for the vehicle CO₂ characteristic curve, [%]

tol_{1L} — lower tolerance for the vehicle CO₂ characteristic curve, [%]

3. Moving Averaging Windows**3.1. Definition of averaging windows**

The instantaneous emissions calculated in accordance with Appendix 4 shall be integrated using a moving averaging window method, based on the reference CO₂ mass.

▼ **M3**

The principle of the calculation is as follows: The RDE distance-specific CO₂ mass emissions are not calculated for the complete data set, but for sub-sets of the complete data set, the length of these sub-sets being determined so as to match always the same fraction of the CO₂ mass emitted by the vehicle over the WLTP cycle. The moving window calculations are conducted with a time increment Δt corresponding to the data sampling frequency. These sub-sets used to calculate the vehicle on-road CO₂ emissions and its average speed are referred to as 'averaging windows' in the following sections.

The calculation described in the present point shall be run from the first data point (forward).

The following data shall not be considered for the calculation of the CO₂ mass, the distance and the vehicle average speed in the averaging windows:

- The periodic verification of the instruments and/or after the zero drift verifications;
- Vehicle ground speed is smaller than 1 km/h.

The calculation shall start from when vehicle ground speed is higher than or equal to 1 km/h and include driving events during which no CO₂ is emitted and where the vehicle ground speed is higher than or equal to 1 km/h.

The mass emissions $M_{CO_2,j}$ shall be determined by integrating the instantaneous emissions in g/s as specified in Appendix 4 to this Annex.

Figure 1

Vehicle speed versus time - Vehicle averaged emissions versus time, starting from the first averaging window

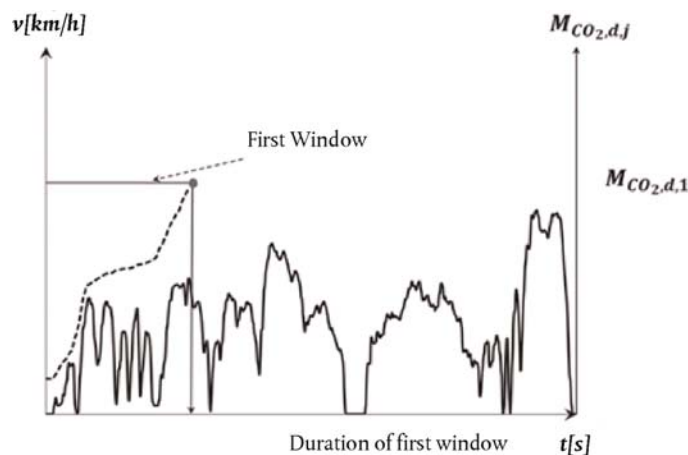

▼ M3

Figure 2

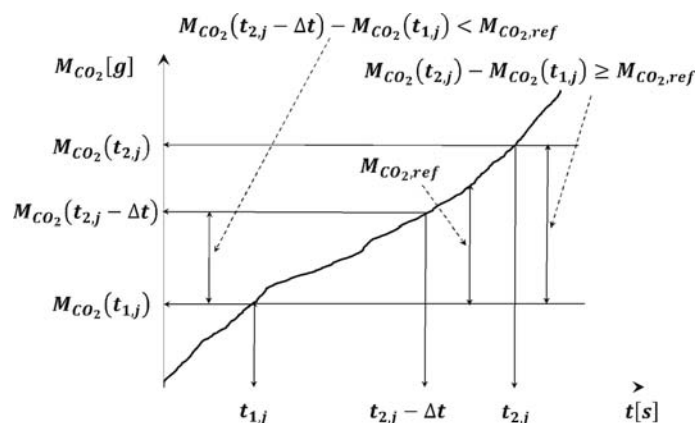
Definition of CO₂ mass based averaging windows

The duration ($t_{2,j} - t_{1,j}$) of the j^{th} averaging window is determined by:

$$M_{CO_2}(t_{2,j}) - M_{CO_2}(t_{1,j}) \geq M_{CO_2,ref}$$

Where:

$M_{CO_2}(t_{i,j})$ is the CO₂ mass measured between the test start and time $t_{i,j}$, [g];

$M_{CO_2,ref}$ is the half of the CO₂ mass emitted by the vehicle over the WLTP test conducted in accordance with Sub-Annex 6 to Annex XXI of this Regulation.

During type approval the CO₂ reference value shall be taken from the WLTP performed during type approval testing of the individual vehicle.

For ISC testing purposes, the reference CO₂ mass shall be obtained from point 12 of the Transparency list 1 of Appendix 5 of Annex II with interpolation between vehicle H and vehicle L (if relevant) as defined in Sub-Annex 7 of Annex XXI, using Test mass and Road load coefficients (f_0 , f_1 & f_2) obtained from the Certificate of Conformity for the individual vehicle as defined in Annex IX. The value for OVC-HEV vehicles is to be obtained from the WLTP test conducted using the Charge Sustaining mode.

$t_{2,j}$ shall be selected such as:

$$M_{CO_2}(t_{2,j} - \Delta t) - M_{CO_2}(t_{1,j}) < M_{CO_2,ref} \leq M_{CO_2}(t_{2,j}) - M_{CO_2}(t_{1,j})$$

Where Δt is the data sampling period.

The CO₂ masses $M_{CO_2,j}$ in the windows are calculated by integrating the instantaneous emissions calculated as specified in Appendix 4 to this Annex.

3.2. Calculation of window parameters

The following shall be calculated for each window determined in accordance with point 3.1.

▼ M3

- The distance-specific CO₂ emissions $M_{CO_2,d,j}$;
- The average vehicle speed \bar{v}_j .

4. Evaluation of windows**4.1. Introduction**

The reference dynamic conditions of the test vehicle are defined from the vehicle CO₂ emissions versus average speed measured at type approval on the Type 1 test and referred to as 'vehicle CO₂ characteristic curve'. To obtain the distance specific CO₂ emissions, the vehicle shall be tested on the WLTP cycle in accordance with Annex XXI to this Regulation.

4.2. CO₂ Characteristic curve reference points

The distance-specific CO₂ emissions to be considered in this paragraph for the definition of the reference curve shall be obtained from point 12 of the Transparency list 1 of Appendix 5 of Annex II with interpolation between vehicle H and vehicle L (if relevant) as defined in Sub-Annex 7 of Annex XXI, using Test mass and Road load coefficients (f₀, f₁ & f₂) obtained from the Certificate of Conformity for the individual vehicle as defined in Annex IX. The value for OVC-HEV vehicles is to be that obtained from the WLTP test conducted using the Charge Sustaining mode.

During type approval, the values shall be taken from the WLTP performed during type approval testing of the individual vehicle.

The reference points P_1 , P_2 and P_3 required to define the vehicle CO₂ characteristic curve shall be established as follows:

4.2.1. Point P_1

$\bar{v}_{P_1} = 18,882 \text{ km/h}$ (Average Speed of the Low Speed phase of the WLTP cycle)

M_{CO_2,d,P_1} = Vehicle CO₂ emissions over the Low Speed phase of the WLTP cycle [g/km]

4.2.2. Point P_2

$\bar{v}_{P_2} = 56,664 \text{ km/h}$ (Average Speed of the High Speed phase of the WLTP cycle)

M_{CO_2,d,P_2} = Vehicle CO₂ emissions over the High Speed phase of the WLTP cycle [g/km]

4.2.3. Point P_3

$\bar{v}_{P_3} = 91,997 \text{ km/h}$ (Average Speed of the Extra High Speed phase of the WLTP cycle)

M_{CO_2,d,P_3} = Vehicle CO₂ emissions over the Extra High Speed phase of the WLTP cycle [g/km]

4.3. CO₂ Characteristic curve definition

Using the reference points defined in point 4.2, the characteristic curve CO₂ emissions are calculated as a function of the average speed using two linear sections (P_1 , P_2) and (P_2 , P_3). The section (P_2 , P_3) is limited to 145 km/h on the vehicle speed axis. The characteristic curve is defined by equations as follows:

▼ **M3**

For the section (P_1, P_2):

$$M_{CO_2,d,CC}(\bar{v}) = a_1\bar{v} + b_1$$

with: $a_1 = (M_{CO_2,d,P_2} - M_{CO_2,d,P_1}) / (\bar{v}_{P_2} - \bar{v}_{P_1})$

and: $b_1 = M_{CO_2,d,P_1} - a_1\bar{v}_{P_1}$

For the section (P_2, P_3):

$$M_{CO_2,d,CC}(\bar{v}) = a_2\bar{v} + b_2$$

with: $a_2 = (M_{CO_2,d,P_3} - M_{CO_2,d,P_2}) / (\bar{v}_{P_3} - \bar{v}_{P_2})$

and: $b_2 = M_{CO_2,d,P_2} - a_2\bar{v}_{P_2}$

Figure 3

Vehicle CO₂ characteristic curve and tolerances for ICE and NOVC-HEV vehicles

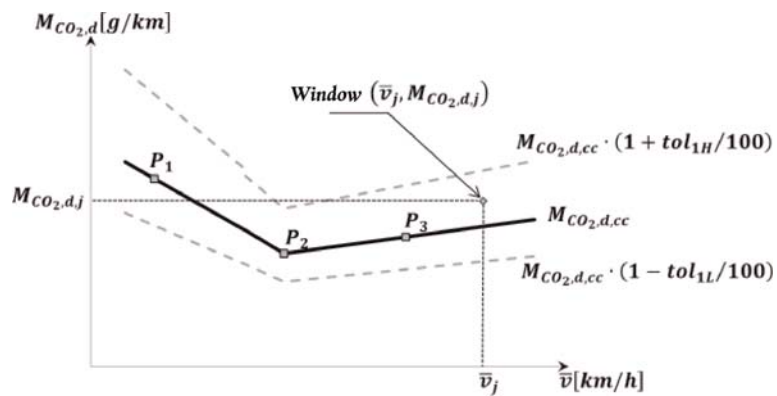
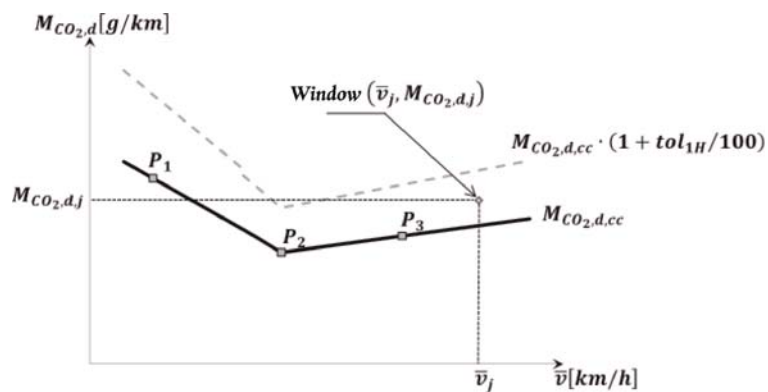

Figure 4

Vehicle CO₂ characteristic curve and tolerances for OVC-HEV vehicles



▼ **M3**4.4. *Urban, rural and motorway windows*4.4.1. **Urban windows**

Urban windows are characterized by average vehicle speeds \bar{v}_j lower than 45 km/h.

4.4.2. **Rural windows**

Rural windows are characterized by average vehicle speeds \bar{v}_j greater than or equal to 45 km/h and lower than 80 km/h.

For N2 category vehicles that are equipped in accordance with Directive 92/6/EEC with a device limiting vehicle speed to 90 km/h, rural windows are characterized by average vehicle speeds \bar{v}_j lower than 70 km/h.

4.4.3. **Motorway windows**

Motorway windows are characterized by average vehicle speeds \bar{v}_j greater than or equal to 80 km/h and lower than 145 km/h

For N2 category vehicles that are equipped in accordance with Directive 92/6/EEC with a device limiting vehicle speed to 90 km/h, motorway windows are characterized by average vehicle speeds \bar{v}_j greater than or equal to 70 km/h and lower than 90 km/h.

Figure 5

Vehicle CO₂ characteristic curve: urban, rural and motorway driving definitions (Illustrated for ICE and NOVC-HEV vehicles) except N2 category vehicles that are equipped in accordance with Directive 92/6/EEC with a device limiting vehicle speed to 90 km/h)

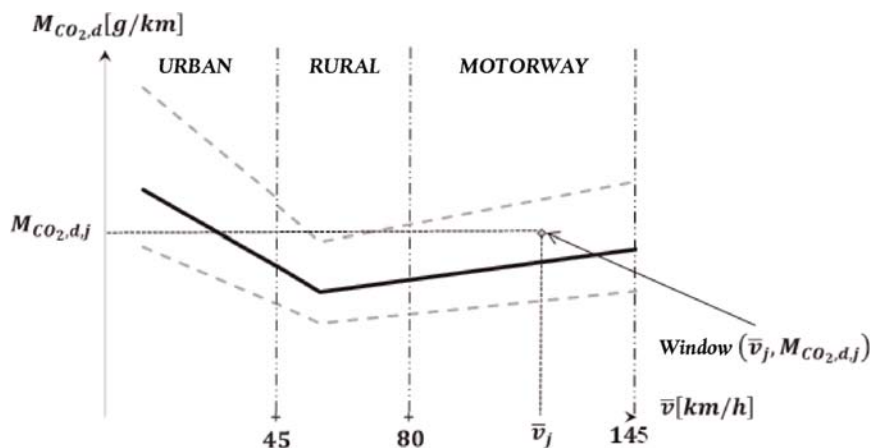

▼ M3

Figure 6

Vehicle CO₂ characteristic curve: urban, rural and motorway driving definitions (Illustrated for OVC-HEV vehicles) except N2 category vehicles that are equipped in accordance with Directive 92/6/EEC with a device limiting vehicle speed to 90 km/h)

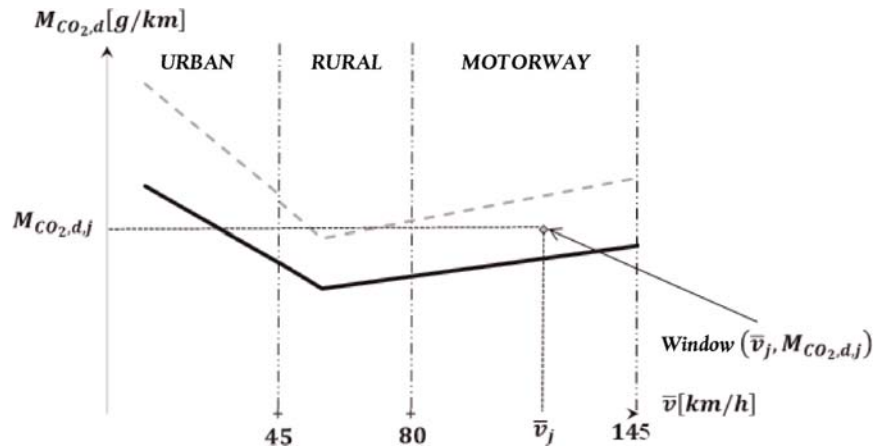

4.5. Verification of trip validity

4.5.1. Tolerances around the vehicle CO₂ characteristic curve

The upper tolerance of the vehicle CO₂ characteristic curve is $tol_{1H} = 45\%$ for urban driving and $tol_{1H} = 40\%$ for rural and motorway driving.

The lower tolerance of the vehicle CO₂ characteristic curve is $tol_{1L} = 25\%$ for ICE and NOVC-HEV vehicles and $tol_{1L} = 100\%$ for OVC-HEV vehicles.

4.5.2. Verification of test validity

The test is valid when it comprises at least 50% of the urban, rural and motorway windows that are within the tolerances defined for the CO₂ characteristic curve.

For NOVC-HEVs and OVC-HEVs, if the minimum requirement of 50% between tol_{1H} and tol_{1L} is not met, the upper positive tolerance tol_{1H} may be increased by steps of 1% until the 50% target is reached. When using this mechanism, the value of tol_{1H} shall never exceed 50%.

▼ **M3***Appendix 6***CALCULATION OF THE FINAL RDE EMISSIONS RESULTS****1. Symbols, Parameters and Units**

Index (k) refers to the category (t = total, u = urban, 1-2 = first two phases of the WLTP cycle)

IC_k is the distance share of usage of the internal combustion engine for an OVC-HEV over the RDE trip

$d_{ICE,k}$ is the distance driven [km], with the internal combustion engine on for an OVC-HEV over the RDE trip

$d_{EV,k}$ is the distance driven [km], with the internal combustion engine off for an OVC-HEV over the RDE trip

$M_{RDE,k}$ is the final RDE distance-specific mass of gaseous pollutants [mg/km] or particle number [# / km]

$m_{RDE,k}$ is the distance-specific mass of gaseous pollutant [mg/km] or particle number [# / km] emissions, emitted over the complete RDE trip and prior to any correction in accordance with this Appendix

$M_{CO_2,RDE,k}$ is the distance-specific mass of CO₂ [g/km], emitted over the RDE trip

$M_{CO_2,WLTC,k}$ is the distance-specific mass of CO₂ [g/km], emitted over the WLTC cycle

$M_{CO_2,WLTC_{CS},k}$ is the distance-specific mass of CO₂ [g/km], emitted over the WLTC cycle for an OVC-HEV vehicle tested on its charge sustaining mode

r_k ratio between the CO₂ emissions measured during the RDE test and the WLTP test

RF_k is the result evaluation factor calculated for the RDE trip

RF_{L1} is the first parameter of the function used to calculate the result evaluation factor

RF_{L2} is the second parameter of the function used to calculate the result evaluation factor

▼ **M3****2. Calculation of the Final RDE emissions results****2.1. Introduction**

The trip validity shall be verified in accordance with point 9.2. of Annex IIIA. For the valid trips, the final RDE results are calculated as follows for vehicles with ICE, NOVC-HEV and OVC-HEV.

For the complete RDE trip and for the urban part of the RDE trip (k = t = total, k = u = urban):

$$M_{RDE,k} = m_{RDE,k} \cdot RF_k$$

The values of the parameter RF_{L1} and RF_{L2} of the function used to calculate the result evaluation factor are as follows:

— Upon the request of the manufacturer and only for type approvals granted before 1 January 2020,

$$RF_{L1} = 1,20 \text{ and } RF_{L2} = 1,25;$$

in all other cases:

$$RF_{L1} = 1,30 \text{ and } RF_{L2} = 1,50;$$

The RDE result evaluation factors RF_k (k = t = total, k = u = urban) shall be obtained using the functions laid down in point 2.2. for vehicles with ICE and NOVC-HEV, and in point 2.3. for OVC-HEV. These evaluation factors shall be subject to review by the Commission and shall be revised as a result of technical progress. A graphical illustration of the method is provided in Figure App 6.1 below, while the mathematical formulas are found in Table App 6.1:

Figure App 6.1

Function to calculate the result evaluation factor

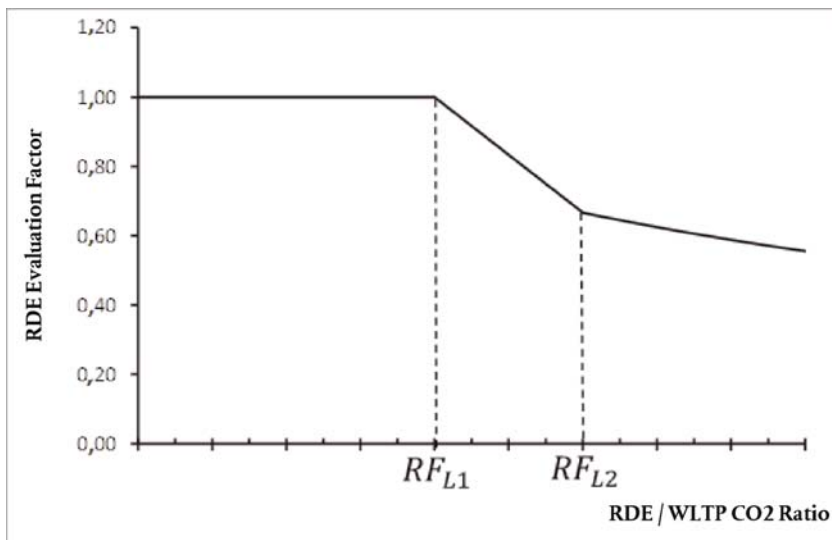

▼ **M3**

Table App 6.1

Result evaluation factors calculation

When:	Then the Result evaluation factor RF_k is:	Where:
$r_k \leq RF_{L1}$	$RF_k = 1$	
$RF_{L1} < r_k \leq RF_{L2}$	$RF_k = a_1 r_k + b_1$	$a_1 = \frac{RF_{L2} - 1}{[RF_{L2}(RF_{L1} - RF_{L2})]}$ $b_1 = 1 - a_1 RF_{L1}$
$r_k > RF_{L2}$	$RF_k = \frac{1}{r_k}$	

2.2. *RDE result evaluation factor for vehicles with ICE and NOVC-HEV*

The value of the RDE result evaluation factor depends on the ratio r_k between the distance specific CO₂ emissions measured during the RDE test and the distance-specific CO₂ emitted by the vehicle over the WLTP test conducted in accordance with Sub-Annex 6 to Annex XXI of this Regulation, obtained from point 12 of the Transparency list 1 of Appendix 5 of Annex II with interpolation between vehicle H and vehicle L (if relevant) as defined in Sub-Annex 7 of Annex XXI, using Test mass and Road load coefficients (F0, F1 & F2) obtained from the Certificate of Conformity for the individual vehicle as defined in Annex IX. For the urban emissions, the relevant phases of the WLTP driving cycle shall be:

- a) for ICE vehicles the first two WLTP phases, i.e. the Low and the Medium speed phases,
- b) for NOVC-HEVs the whole WLTP driving cycle.

$$r_k = \frac{M_{CO_2,RDE,k}}{M_{CO_2,WLTP,k}}$$

2.3. *RDE result evaluation factor for OVC-HEV*

The value of the RDE result evaluation factor depends on the ratio r_k between the distance-specific CO₂ emissions measured during the RDE test and the distance-specific CO₂ emitted by the vehicle over the WLTP test conducted using the Charge Sustaining mode in accordance with Sub-Annex 6 to Annex XXI of this Regulation, obtained from point 12 of the Transparency list 1 of Appendix 5 of Annex II with interpolation between vehicle H and vehicle L (if relevant) as defined in Sub-Annex 7 of Annex XXI, using Test mass and Road load coefficients (F0, F1 & F2) obtained from the Certificate of Conformity for the individual vehicle as defined in Annex IX. The ratio r_k is corrected by a ratio reflecting the respective usage of the internal combustion engine during the RDE trip and on the WLTP test, to be conducted using the charge sustaining mode. The formula below shall be subject to review by the Commission and shall be revised as a result of technical progress.

▼ M3

For either the urban or the total driving:

$$r_k = \frac{M_{CO_2,RDE,k}}{M_{CO_2,WLTP,k-CS,t}} \cdot \frac{0,85}{IC_k}$$

where IC_k is the ratio of the distance driven either in urban or total trip with the combustion engine on divided by the total urban or total trip distance:

$$IC_k = \frac{d_{ICE,k}}{d_{ICE,k} + d_{EV,k}}$$

With determination of combustion engine operation in accordance with Appendix 4 Paragraph 5.

▼ B*Appendix 7***Selection of vehicles for PEMS testing at initial type approval****▼ M3**

1. INTRODUCTION

Due to their particular characteristics, PEMS tests shall not be required for each vehicle type with regard to emissions and vehicle repair and maintenance information as defined in Article 2(1), hereinafter 'vehicle emission type'. Several vehicle emission types and several vehicles with different declared maximum RDE values in accordance with Part I of Annex IX to Directive 2007/46/EC may be put together by the vehicle manufacturer to form a PEMS test family in accordance with the requirements of point 3, which shall be validated in accordance with the requirements of point 4.

▼ B

2. SYMBOLS, PARAMETERS AND UNITS

N — Number of vehicle emission types

NT — Minimum number of vehicle emission types

PMR_H — highest power-to-mass-ratio of all vehicles in the PEMS test family

PMR_L — lowest power-to-mass-ratio of all vehicles in the PEMS test family

V_{eng_max} — maximum engine volume of all vehicles within the PEMS test family

▼ M1

3. PEMS TEST FAMILY BUILDING

A PEMS test family shall comprise finished vehicles with similar emission characteristics. Vehicle emission types may be included in a PEMS test family only as long as the completed vehicles within a PEMS test family are identical with respect to the characteristics in points 3.1 and 3.2.

3.1. **Administrative criteria**

3.1.1. The approval authority issuing the emission type approval in accordance with Regulation (EC) No 715/2007 ('authority')

3.1.2. The manufacturer having received the emission type approval in accordance with Regulation (EC) No 715/2007.

▼ B3.2. **Technical criteria**

3.2.1. Propulsion type (e.g. ICE, HEV, PHEV)

3.2.2. Type(s) of fuel(s) (e.g. petrol, diesel, LPG, NG, ...). Bi- or flex-fuelled vehicles may be grouped with other vehicles, with which they have one of the fuels in common.

3.2.3. Combustion process (e.g. two stroke, four stroke)

▼ B

- 3.2.4. Number of cylinders
- 3.2.5. Configuration of the cylinder block (e.g. in-line, V, radial, horizontally opposed)
- 3.2.6. Engine volume
The vehicle manufacturer shall specify a value V_{eng_max} (= maximum engine volume of all vehicles within the PEMS test family). The engine volumes of vehicles in the PEMS test family shall not deviate more than – 22 % from V_{eng_max} if $V_{eng_max} \geq 1\,500$ ccm and – 32 % from V_{eng_max} if $V_{eng_max} < 1\,500$ ccm.
- 3.2.7. Method of engine fuelling (e.g. indirect or direct or combined injection)
- 3.2.8. Type of cooling system (e.g. air, water, oil)
- 3.2.9. Method of aspiration such as naturally aspirated, pressure charged, type of pressure charger (e.g. externally driven, single or multiple turbo, variable geometries ...)
- 3.2.10. Types and sequence of exhaust after-treatment components (e.g. three-way catalyst, oxidation catalyst, lean NO_x trap, SCR, lean NO_x catalyst, particulate trap).
- 3.2.11. Exhaust gas recirculation (with or without, internal/external, cooled/non-cooled, low/high pressure)
- 3.3. **Extension of a PEMS test family**
An existing PEMS test family may be extended by adding new vehicle emission types to it. The extended PEMS test family and its validation must also fulfil the requirements of points 3 and 4. This may in particular require the PEMS testing of additional vehicles to validate the extended PEMS test family according to point 4.
- 3.4. **Alternative PEMS test family**
As an alternative to the provisions of points 3.1 to 3.2 the vehicle manufacturer may define a PEMS test family, which is identical to a single vehicle emission type. In this the requirement of point 4.1.2 for validating the PEMS test family shall not apply.
4. VALIDATION OF A PEMS TEST FAMILY
- 4.1. **General requirements for validating a PEMS test family**
- 4.1.1. The vehicle manufacturer presents a representative vehicle of the PEMS test family to the authority. The vehicle shall be subject to a PEMS test carried out by a Technical Service to demonstrate compliance of the representative vehicle with the requirements of this Annex.
- 4.1.2. The authority selects additional vehicles according to the requirements of point 4.2 of this Appendix for PEMS testing carried out by a Technical Service to demonstrate compliance of the selected vehicles with the requirements of this Annex. The technical criteria for selection of an additional vehicle according to point 4.2 of this Appendix. shall be recorded with the test results.

▼ B

4.1.3. With agreement of the authority, a PEMS test can also be driven by a different operator witnessed by a Technical Service, provided that at least the tests of the vehicles required by points 4.2.2 and 4.2.6 of this Appendix and in total at least 50 % of the PEMS tests required by this Appendix for validating the PEMS test family are driven by a Technical Service. In such case the Technical Service remains responsible for the proper execution of all PEMS tests pursuant to the requirements of this Annex.

4.1.4. A PEMS test results of a specific vehicle may be used for validating different PEMS test families according to the requirements of this Appendix under the following conditions:

— the vehicles included in all PEMS test families to be validated are approved by a single authority according to the requirements of Regulation (EC) 715/2007 and this authority agrees to the use of the specific vehicle's PEMS test results for validating different PEMS test families;

— each PEMS test family to be validated includes a vehicle emission type, which comprises the specific vehicle;

For each validation the applicable responsibilities are considered to be borne by the manufacturer of the vehicles in the respective family, regardless of whether this manufacturer was involved in the PEMS test of the specific vehicle emission type.

4.2. Selection of vehicles for PEMS testing when validating a PEMS test family

By selecting vehicles from a PEMS test family it should be ensured that the following technical characteristics relevant for pollutant emissions are covered by a PEMS test. One vehicle selected for testing can be representative for different technical characteristics. For the validation of a PEMS test family vehicles shall be selected for PEMS testing as follows:

4.2.1. For each combination of fuels (e.g. petrol-LPG, petrol-NG, petrol only), on which some vehicle of the PEMS test family can operate, at least one vehicle that can operate on this combination of fuels shall be selected for PEMS testing.

4.2.2. The manufacturer shall specify a value PMR_H (= highest power-to-mass-ratio of all vehicles in the PEMS test family) and a value PMR_L (= lowest power-to-mass-ratio of all vehicles in the PEMS test family). Here the 'power-to-mass-ratio' corresponds to the ratio of the maximum net power of the internal combustion engine as indicated in point 3.2.1.8 of Appendix 3 to Annex I of this Regulation and of the reference mass as defined in Article 3(3) of Regulation (EC) No 715/2007. At least one vehicle configuration representative for the specified PMR_H and one vehicle configuration representative for the specified PMR_L of a PEMS test family shall be selected for testing. If the power-to-mass ratio of a vehicle deviates by not more than 5 % from the specified value for PMR_H , or PMR_L , the vehicle should be considered as representative for this value.

4.2.3. At least one vehicle for each transmission type (e.g., manual, automatic, DCT) installed in vehicles of the PEMS test family shall be selected for testing.

▼ B

- 4.2.4. At least one four-wheel drive vehicle (4x4 vehicle) shall be selected for testing if such vehicles are part of the PEMS test family.
- 4.2.5. For each engine volume occurring on a vehicle in the PEMS family at least one representative vehicle shall be tested.

▼ M3**▼ M1**

- 4.2.7. At least one vehicle in the PEMS family shall be tested in hot start testing.
- 4.2.8. Notwithstanding the provisions in points 4.2.1 to 4.2.6, at least the following number of vehicle emission types of a given PEMS test family shall be selected for testing:

Number N of vehicle emission types in a PEMS test family	Minimum number NT of vehicle emission types selected for PEMS cold start testing	Minimum number NT of vehicle emission types selected for PEMS hot start testing
1	1	1 ⁽²⁾
From 2 to 4	2	1
from 5 to 7	3	1
from 8 to 10	4	1
from 11 to 49	$NT = 3 + 0,1 \times N$ ⁽¹⁾	2
more than 49	$NT = 0,15 \times N$ ⁽¹⁾	3

⁽¹⁾ NT shall be rounded to the next higher integer number.

⁽²⁾ ► **M3** When there is only one vehicle emission type in a PEMS test family, the type approval authority shall decide whether the vehicle shall be tested in hot or cold start condition. ◀

▼ B

5. REPORTING

- 5.1. The vehicle manufacturer provides a full description of the PEMS test family, which includes in particular the technical criteria described in point 3.2 and submits it to the authority.
- 5.2. The manufacturer attributes a unique identification number of the format *MS-OEM-X-Y* to the PEMS test family and communicates it to the authority. Here *MS* is the distinguishing number of the Member State issuing the EC type-approval ⁽¹⁾, *OEM* is the 3 character manufacturer, *X* is a sequential number identifying the original PEMS test family and *Y* is a counter for its extensions (starting with 0 for a PEMS test family not extended yet).

▼ M3

- 5.3. The authority and the vehicle manufacturer shall maintain a list of vehicle emission types being part of a given PEMS test family on the basis of emission type approval numbers. For each emission type all corresponding combinations of vehicle type approval numbers, types, variants and versions as defined in section 0.2 of the vehicle's EC certificate of conformity shall be provided as well.

⁽¹⁾ 1 for Germany; 2 for France; 3 for Italy; 4 for the Netherlands; 5 for Sweden; 6 for Belgium; 7 for Hungary; 8 for the Czech Republic; 9 for Spain; 11 for the United Kingdom; 12 for Austria; 13 for Luxembourg; 17 for Finland; 18 for Denmark; 19 for Romania; 20 for Poland; 21 for Portugal; 23 for Greece; 24 for Ireland. 25 for Croatia; 26 for Slovenia; 27 for Slovakia; 29 for Estonia; 32 for Latvia; 34 for Bulgaria; 36 for Lithuania; 49 for Cyprus; 50 for Malta

▼B

- 5.4. The authority and the vehicle manufacturer shall maintain a list of vehicle emission types selected for PEMS testing in order to validate a PEMS test family in accordance with point 4, which also provides the necessary information on how the selection criteria of point 4.2 are covered. This list shall also indicate whether the provisions of point 4.1.3 were applied for a particular PEMS test.

▼ M3*Appendix 7a***Verification of trip dynamics**

1. INTRODUCTION

This Appendix describes the calculation procedures to verify the trip dynamics by determining the excess or absence of dynamics during urban, rural and motorway driving.

▼ B

2. SYMBOLS, PARAMETERS AND UNITS

RPA Relative Positive Acceleration

Δ	— difference
$>$	— larger
\geq	— larger or equal
%	— per cent
$<$	— smaller
\leq	— smaller or equal
a	— acceleration [m/s^2]
a_i	— acceleration in time step i [m/s^2]
a_{pos}	— positive acceleration greater than $0,1 \text{ m/s}^2$ [m/s^2]
$a_{pos,i,k}$	— positive acceleration greater than $0,1 \text{ m/s}^2$ in time step i considering the urban, rural and motorway shares [m/s^2]
a_{res}	— acceleration resolution [m/s^2]
d_i	— distance covered in time step i [m]
$d_{i,k}$	— distance covered in time step i considering the urban, rural and motorway shares [m]
Index (i)	— discrete time step
Index (j)	— discrete time step of positive acceleration datasets
Index (k)	— refers to the respective category (t=total, u=urban, r=rural, m=motorway)
M_k	— number of samples for urban, rural and motorway shares with positive acceleration greater than $0,1 \text{ m/s}^2$
N_k	— total number of samples for the urban, rural and motorway shares and the complete trip

▼ B

RPA_k	— relative positive acceleration for urban, rural and motorway shares [m/s^2 or $kWs/(kg*km)$]
t_k	— duration of the urban, rural and motorway shares and the complete trip [s]
T4253H	— compound data smoother
v	— vehicle speed [km/h]
v_i	— actual vehicle speed in time step i [km/h]
$v_{i,k}$	— actual vehicle speed in time step i considering the urban, rural and motorway shares [km/h]
$(v \cdot a)_i$	— actual vehicle speed per acceleration in time step i [m^2/s^3 or W/kg]
$(v \cdot a_{pos})_{j,k}$	— actual vehicle speed per positive acceleration greater than $0,1 m/s^2$ in time step j considering the urban, rural and motorway shares [m^2/s^3 or W/kg].
$(v \cdot a_{pos})_{k-[95]}$	— 95 th percentile of the product of vehicle speed per positive acceleration greater than $0,1 m/s^2$ for urban, rural and motorway shares [m^2/s^3 or W/kg]
\bar{v}_k	— average vehicle speed for urban, rural and motorway shares [km/h]

3. TRIP INDICATORS

3.1. Calculations

▼ M33.1.1. *Data pre-processing*

Dynamic parameters like acceleration, $(v \cdot a_{pos})$ or RPA shall be determined with a speed signal of an accuracy of 0,1 % for all speed values above 3 km/h and a sampling frequency of 1 Hz. This accuracy requirement is generally fulfilled by distance calibrated signals obtained from a wheel (rotational) speed sensor. Otherwise, acceleration shall be determined with an accuracy of $0,01 m/s^2$ and a sampling frequency of 1 Hz. In this case the separate speed signal, in $(v \cdot a_{pos})$, shall have an accuracy of at least 0,1 km/h.

The correct speed trace builds the basis for further calculations and binning as described in paragraph 3.1.2 and 3.1.3.

▼ B3.1.2. *Calculation of distance, acceleration and $v \cdot a$*

The following calculations shall be performed over the whole time based speed trace (1 Hz resolution) from second 1 to second t_i (last second).

The distance increment per data sample shall be calculated as follows:

▼ C2

$$d_i = \frac{v_i}{3,6}, \quad i = 1 \text{ to } N_i$$

▼ B

where:

d_i is the distance covered in time step i [m]

v_i is the actual vehicle speed in time step i [km/h]

N_t is the total number of samples

The acceleration shall be calculated as follows:

$$a_i = (v_{i+1} - v_{i-1}) / (2 \cdot 3,6), \quad i = 1 \text{ to } N_t$$

where:

a_i is the acceleration in time step i [m/s^2]. For $i = 1$: $v_{i-1} = 0$, for $i = N_t$: $v_{i+1} = 0$.

The product of vehicle speed per acceleration shall be calculated as follows:

$$(v \cdot a)_i = v_i \cdot a_i / 3,6, \quad i = 1 \text{ to } N_t$$

where:

$(v \cdot a)_i$ is the product of the actual vehicle speed per acceleration in time step i [m^2/s^3 or W/kg].

▼ M33.1.3. *Binning of the results*

After the calculation of a_i and $(v \cdot a)_i$, the values v_i , d_i , a_i and $(v \cdot a)_i$ shall be ranked in ascending order of the vehicle speed.

All datasets with $v_i \leq 60$ km/h belong to the ‘urban’ speed bin, all datasets with $60 \text{ km/h} < v_i \leq 90$ km/h belong to the ‘rural’ speed bin and all datasets with $v_i > 90$ km/h belong to the ‘motorway’ speed bin.

For N2 category vehicles that are equipped with a device limiting vehicle speed to 90 km/h, all datasets with $v_i \leq 60$ km/h belong to the ‘urban’ speed bin, all datasets with $60 \text{ km/h} < v_i \leq 80$ km/h belong to the ‘rural’ speed bin and all datasets with $v_i > 80$ km/h belong to the ‘motorway’ speed bin.

The number of datasets with acceleration values $a_i > 0,1 \text{ m/s}^2$ shall be greater or equal to 100 in each speed bin.

For each speed bin the average vehicle speed \bar{v}_k shall be calculated as follows:

$$\bar{v}_k = (\sum_i v_{i,k}) / N_k, \quad i = 1 \text{ to } N_k, \quad k = u, r, m$$

Where:

N_k is the total number of samples of the urban, rural, and motorway shares.

▼ B3.1.4. *Calculation of $v \cdot a_{pos-95}$ per speed bin*

The 95th percentile of the $v \cdot a_{pos}$ values shall be calculated as follows:

The $(v \cdot a)_{i,k}$ values in each speed bin shall be ranked in ascending order for all datasets with $a_{i,k} > 0,1 \text{ m/s}^2$ $a_{i,k} \geq 0,1 \text{ m/s}^2$ and the total number of these samples M_k shall be determined.

▼ B

Percentile values are then assigned to the $(v \cdot a_{pos})_{i,k}$ values with $a_{i,k} \geq 0,1m/s^2$ as follows:

The lowest $v \cdot a_{pos}$ value gets the percentile $1/M_k$, the second lowest $2/M_k$, the third lowest $3/M_k$ and the highest value $M_k/M_k = 100\%$.

$(v \cdot a_{pos})_{k-}[95]$ is the $(v \cdot a_{pos})_{j,k}$ value, with $j/M_k = 95\%$. If $j/M_k = 95\%$ cannot be met, $(v \cdot a_{pos})_{k-}[95]$ shall be calculated by linear interpolation between consecutive samples j and $j+1$ with $j/M_k < 95\%$ and $(j+1)/M_k > 95\%$.

The relative positive acceleration per speed bin shall be calculated as follows:

$$RPA_k = \sum_j (\Delta t \cdot (v \cdot a_{pos})_{j,k}) / \sum_i d_{i,k}, \quad j = 1 \text{ to } M_k, \quad i = 1 \text{ to } N_k, \quad k = u, r, m$$

where:

RPA_k is the relative positive acceleration for urban, rural and motorway shares in $[m/s^2 \text{ or } kW/(kg \cdot km)]$

Δt is a time difference equal to 1 second

M_k is the sample number for urban, rural and motorway shares with positive acceleration

N_k is the total sample number for urban, rural and motorway shares

4. VERIFICATION OF TRIP VALIDITY

4.1.1. Verification of $v \times a_{pos-}[95]$ per speed bin (with v in $[km/h]$)

If $\bar{v}_k \leq 74,6 \text{ km/h}$

and

$$(v \cdot a_{pos})_{k-}[95] > (0,136 \cdot \bar{v}_k + 14,44)$$

is fulfilled, the trip is invalid.

If $\bar{v}_k > 74,6 \text{ km/h}$ and $(v \cdot a_{pos})_{k-}[95] > (0,0742 \cdot \bar{v}_k + 18,966)$ is fulfilled, the trip is invalid.

▼ M3

Upon the request of the manufacturer, and only for those N1 or N2 vehicles where the vehicle power-to-mass ratio is less than or equal to 44 W/kg then:

If $\bar{v}_k \leq 74,6 \text{ km/h}$

and

$$(v \cdot a_{pos})_{k-}[95] > (0,136 \cdot \bar{v}_k + 14,44)$$

is fulfilled, the trip is invalid.

If $\bar{v}_k > 74,6 \text{ km/h}$

▼ M3

and

$$(v \cdot a_{\text{pos}})_{k-}[95] > (-0,097 \cdot \bar{v}_k + 31,635)$$

is fulfilled, the trip is invalid.

To calculate the power-to-mass ratio, the following values shall be used:

- the mass which corresponds to the actual test mass of the vehicle including the drivers and the PEMS equipment (kg);
- the maximum rated engine power as declared by the manufacturer (W).

4.1.2. *Verification of RPA per speed bin*

If $\bar{v}_k \leq 94,05$ km/h and $RPA_k < (-0,0016 \cdot \bar{v}_k + 0,1755)$ is fulfilled, the trip is invalid.

If $\bar{v}_k > 94,05$ km/h and $RPA_k < 0,025$ is fulfilled, the trip is invalid.

▼B*Appendix 7b***Procedure to determine the cumulative positive elevation gain of a PEMS trip**

1. INTRODUCTION

This Appendix describes the procedure to determine the cumulative elevation gain of a PEMS trip.

2. SYMBOLS, PARAMETERS AND UNITS

$d(0)$	— distance at the start of a trip [m]
d	— cumulative distance travelled at the discrete way point under consideration [m]
d_0	— cumulative distance travelled until the measurement directly before the respective way point d [m]
d_1	— cumulative distance travelled until the measurement directly after the respective way point d [m]
d_a	— reference way point at $d(0)$ [m]
d_e	— cumulative distance travelled until the last discrete way point [m]
d_i	— instantaneous distance [m]
d_{tot}	— total test distance [m]
$h(0)$	— vehicle altitude after the screening and principle verification of data quality at the start of a trip [m above sea level]
$h(t)$	— vehicle altitude after the screening and principle verification of data quality at point t [m above sea level]
$h(d)$	— vehicle altitude at the way point d [m above sea level]
$h(t-1)$	— vehicle altitude after the screening and principle verification of data quality at point $t-1$ [m above sea level]
$h_{corr}(0)$	— corrected altitude directly before the respective way point d [m above sea level]
$h_{corr}(1)$	— corrected altitude directly after the respective way point d [m above sea level]
$h_{corr}(t)$	— corrected instantaneous vehicle altitude at data point t [m above sea level]

▼ B

$h_{corr}(t-1)$	— corrected instantaneous vehicle altitude at data point t-1 [m above sea level]
$h_{GPS,i}$	— instantaneous vehicle altitude measured with GPS [m above sea level]
$h_{GPS}(t)$	— vehicle altitude measured with GPS at data point t [m above sea level]
$h_{int}(d)$	— interpolated altitude at the discrete way point under consideration d [m above sea level]
$h_{int,sm,1}(d)$	— smoothed and interpolated altitude, after the first smoothing run at the discrete way point under consideration d [m above sea level]
$h_{map}(t)$	— vehicle altitude based on topographic map at data point t [m above sea level]
Hz	— hertz
km/h	— kilometer per hour
m	— meter
$road_{grade,1}(d)$	— smoothed road grade at the discrete way point under consideration d after the first smoothing run [m/m]
$road_{grade,2}(d)$	— smoothed road grade at the discrete way point under consideration d after the second smoothing run [m/m]
sin	— trigonometric sine function
t	— time passed since test start [s]
t_0	— time passed at the measurement directly located before the respective way point d [s]
v_i	— instantaneous vehicle speed [km/h]
$v(t)$	— vehicle speed at a data point t [km/h]

3. GENERAL REQUIREMENTS

The cumulative positive elevation gain of a RDE trip shall be determined based on three parameters: the instantaneous vehicle altitude $h_{GPS,i}$ [m above sea level] as measured with the GPS, the instantaneous vehicle speed v_i [km/h] recorded at a frequency of 1 Hz and the corresponding time t [s] that has passed since test start.

4. CALCULATION OF CUMULATIVE POSITIVE ELEVATION GAIN

4.1. General

The cumulative positive elevation gain of a RDE trip shall be calculated as a three-step procedure, consisting of (i) the screening and principle verification of data quality, (ii) the correction of instantaneous vehicle altitude data, and (iii) the calculation of the cumulative positive elevation gain.

▼ B**4.2. Screening and principle verification of data quality**

The instantaneous vehicle speed data shall be checked for completeness. Correcting for missing data is permitted if gaps remain within the requirements specified in Point 7 of Appendix 4; else, the test results shall be voided. The instantaneous altitude data shall be checked for completeness. Data gaps shall be completed by data interpolation. The correctness of interpolated data shall be verified by a topographic map. It is recommended to correct interpolated data if the following condition applies:

$$|h_{GPS}(t) - h_{map}(t)| > 40m$$

The altitude correction shall be applied so that:

$$h(t) = h_{map}(t)$$

where:

$h(t)$ — vehicle altitude after the screening and principle verification of data quality at data point t [m above sea level]

$h_{GPS}(t)$ — vehicle altitude measured with GPS at data point t [m above sea level]

$h_{map}(t)$ — vehicle altitude based on topographic map at data point t [m above sea level]

4.3. Correction of instantaneous vehicle altitude data

The altitude $h(0)$ at the start of a trip at $d(0)$ shall be obtained by GPS and verified for correctness with information from a topographic map. The deviation shall not be larger than 40 m. Any instantaneous altitude data $h(t)$ shall be corrected if the following condition applies:

$$|h(t) - h(t-1)| > (v(t)/3,6 \times \sin 45^\circ)$$

The altitude correction shall be applied so that:

$$h_{corr}(t) = h_{corr}(t-1)$$

where:

$h(t)$ — vehicle altitude after the screening and principle verification of data quality at data point t [m above sea level]

$h(t-1)$ — vehicle altitude after the screening and principle verification of data quality at data point t-1 [m above sea level]

$v(t)$ — vehicle speed of data point t [km/h]

$h_{corr}(t)$ — corrected instantaneous vehicle altitude at data point t [m above sea level]

$h_{corr}(t-1)$ — corrected instantaneous vehicle altitude at data point t-1 [m above sea level]

▼ B

Upon the completion of the correction procedure, a valid set of altitude data is established. This data set shall be used for the calculation of the cumulative positive elevation gain as described in Point 13.4.

4.4. Final calculation of the cumulative positive elevation gain

4.4.1. Establishment of a uniform spatial resolution

The total distance d_{tot} [m] covered by a trip shall be determined as sum of the instantaneous distances d_i . The instantaneous distance d_i shall be determined as:

$$d_i = \frac{v_i}{3,6}$$

Where:

d_i — instantaneous distance [m]

v_i — instantaneous vehicle speed [km/h]

The cumulative elevation gain shall be calculated from data of a constant spatial resolution of 1 m starting with the first measurement at the start of a trip $d(0)$. The discrete data points at a resolution of 1 m are referred to as way points, characterized by a specific distance value d (e.g., 0, 1, 2, 3 m...) and their corresponding altitude $h(d)$ [m above sea level].

The altitude of each discrete way point d shall be calculated through interpolation of the instantaneous altitude $h_{corr}(t)$ as:

$$h_{int}(d) = h_{corr}(0) + \frac{h_{corr}(1) - h_{corr}(0)}{d_1 - d_0} \times (d - d_0)$$

Where:

$h_{int}(d)$ — interpolated altitude at the discrete way point under consideration d [m above sea level]

$h_{corr}(0)$ — corrected altitude directly before the respective way point d [m above sea level]

$h_{corr}(1)$ — corrected altitude directly after the respective way point d [m above sea level]

d — cumulative distance traveled until the discrete way point under consideration d [m]

d_0 — cumulative distance travelled until the measurement located directly before the respective way point d [m]

d_1 — cumulative distance travelled until the measurement located directly after the respective way point d [m]

4.4.2. Additional data smoothing

The altitude data obtained for each discrete way point shall be smoothed by applying a two-step procedure; d_a and d_e denote the first and last data point respectively (Figure 1). The first smoothing run shall be applied as follows:

$$road_{grade,1}(d) = \frac{h_{int}(d + 200m) - h_{int}(d_a)}{(d + 200m)} \quad \text{for } d \leq 200m$$

▼ B

$$road_{grade,1}(d) = \frac{h_{int}(d+200m) - h_{int}(d-200m)}{(d+200m) - (d-200m)} \quad \text{for } 200m < d < (d_e - 200m)$$

$$road_{grade,1}(d) = \frac{h_{int}(d_e) - h_{int}(d-200m)}{d_e - (d-200m)} \quad \text{for } d \geq (d_e - 200m)$$

$$h_{int,sm,1}(d) = h_{int,sm,1}(d-1m) + road_{grade,1}(d), \quad d = d_a + 1 \text{ to } d_e$$

$$h_{int,sm,1}(d_a) = h_{int}(d_a) + road_{grade,1}(d_a)$$

Where:

$road_{grade,1}(d)$ — smoothed road grade at the discrete way point under consideration after the first smoothing run [m/m]

$h_{int}(d)$ — interpolated altitude at the discrete way point under consideration d [m above sea level]

$h_{int,sm,1}(d)$ — smoothed interpolated altitude, after the first smoothing run at the discrete way point under consideration d [m above sea level]

d — cumulative distance travelled at the discrete way point under consideration [m]

d_a — reference way point at a distance of zero meters [m]

d_e — cumulative distance travelled until the last discrete way point [m]

The second smoothing run shall be applied as follows:

$$road_{grade,2}(d) = \frac{h_{int,sm,1}(d+200m) - h_{int,sm,1}(d_a)}{(d+200m)} \quad \text{for } d \leq 200m$$

$$road_{grade,2}(d) = \frac{h_{int,sm,1}(d+200m) - h_{int,sm,1}(d-200m)}{(d+200m) - (d-200m)} \quad \text{for } 200m < d < (d_e - 200m)$$

$$road_{grade,2}(d) = \frac{h_{int,sm,1}(d_e) - h_{int,sm,1}(d-200m)}{d_e - (d-200m)} \quad \text{for } d \geq (d_e - 200m)$$

Where:

$road_{grade,2}(d)$ — smoothed road grade at the discrete way point under consideration after the second smoothing run [m/m]

$h_{int,sm,1}(d)$ — smoothed interpolated altitude, after the first smoothing run at the discrete way point under consideration d [m above sea level]

▼ **B**

- d — cumulative distance travelled at the discrete way point under consideration [m]
- d_a — reference way point at a distance of zero meters [m]
- d_e — cumulative distance travelled until the last discrete way point [m]

Figure 1

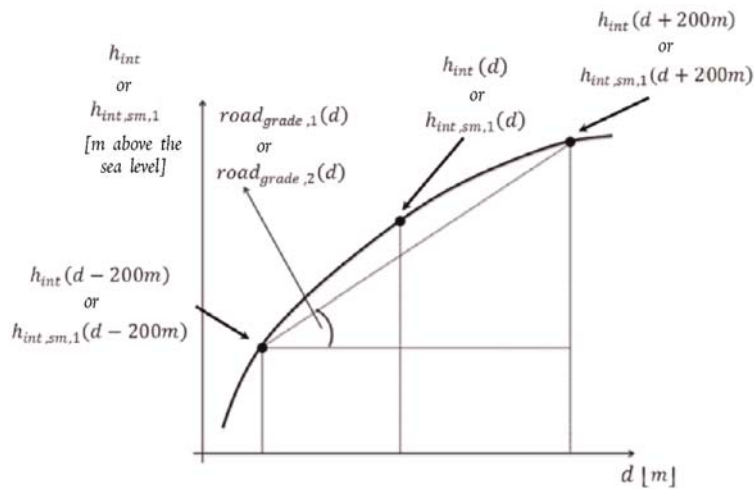
Illustration of the procedure to smooth the interpolated altitude signals▼ **M3**

4.4.3. Calculation of the final result

The positive cumulative elevation gain of a total trip shall be calculated by integrating all positive interpolated and smoothed road grades, i.e. *road_{grade,2}(d)*. The result should be normalized by the total test distance *dot* and expressed in metres of cumulative elevation gain per one hundred kilometres of distance.

The positive cumulative elevation gain of the urban part of a trip shall then be calculated based on the vehicle speed over each discrete way point:

$$v_w = 1 / (t_{w,i} - t_{w,i-1}) \cdot 60^2 / 1000$$

Where:

v_w - waypoint vehicle speed [km/h]

All datasets with $v_w \leq 60$ km/h belong to the urban part of the trip.

Integrate all of the positive interpolated and smoothed road grades that correspond to urban datasets.

Integrate the number of 1m waypoints which correspond to urban datasets and divide by 1 000 to calculate urban test distance d_{urban} [km].

▼ M3

The positive cumulative elevation gain of the urban part of trip shall then be calculated by dividing the urban elevation gain by the urban test distance, and expressed in metres of cumulative elevation gain per one hundred kilometres of distance.

▼ B

5. NUMERICAL EXAMPLE

Tables 1 and 2 show how to calculate the positive elevation gain on the basis of data recorded during an on-road test performed with PEMS. For the sake of brevity an extract of 800m and 160s is presented here.

5.1. Screening and principle verification of data quality

The screening and principle verification of data quality consists of two steps. First, the completeness of vehicle speed data is checked. No data gaps related to vehicle speed are detected in the present data sample (see Table 1). Second, the altitude data are checked for completeness; in the data sample, altitude data related to seconds 2 and 3 are missing. The gaps are filled by interpolating the GPS signal. In addition, the GPS altitude is verified by a topographic map; this verification includes the altitude $h(0)$ at the start of the trip. Altitude data related to seconds 112-114 are corrected on the basis of the topographic map to satisfy the following condition:

$$h_{GPS}(t) - h_{map}(t) < -40m$$

As result of the applied data verification, the data in the fifth column $h(t)$ are obtained.

5.2. Correction of instantaneous vehicle altitude data

As a next step, the altitude data $h(t)$ of seconds 1 to 4, 111 to 112 and 159 to 160 are corrected assuming the altitude values of seconds 0, 110 and 158 respectively since for the altitude data in these time periods the following condition applies:

$$|h(t) - h(t-1)| > (v(t)/3,6 \times \sin 45^\circ)$$

As result of the applied data correction, the data in the sixth column $h_{corr}(t)$ are obtained. The effect of the applied verification and correction steps on the altitude data is depicted in Figure 2.

5.3. Calculation of the cumulative positive elevation gain

5.3.1. Establishment of a uniform spatial resolution

The instantaneous distance d_i is calculated by dividing the instantaneous vehicle speed measured in km/h by 3.6 (Column 7 in Table 1). Recalculating the altitude data to obtain a uniform spatial resolution of 1 m yields the discrete way points d (Column 1 in Table 2) and their corresponding altitude values $h_{int}(d)$ (Column 7 in Table 2). The altitude of each discrete way point d is calculated through interpolation of the measured instantaneous altitude h_{corr} as:

$$h_{int}(0) = 120,3 + \frac{120,3 - 120,3}{0,1 - 0,0} \times (0 - 0) = 120,3000$$

$$h_{int}(520) = 132,5 + \frac{132,6 - 132,5}{523,6 - 519,9} \times (520 - 519,9) = 132,5027$$

▼ B5.3.2. *Additional data smoothing*

In Table 2, the first and last discrete way points are: $d_a=0m$ and $d_e=799m$, respectively. The altitude data of each discrete way point is smoothed by applying a two steps procedure. The first smoothing run consists of:

$$road_{grade,1}(0) = \frac{h_{int}(200m) - h_{int}(0)}{(0 + 200m)} = \frac{120,9682 - 120,3000}{200} = 0,0033$$

chosen to demonstrate the smoothing for $d \leq 200m$

$$road_{grade,1}(320) = \frac{h_{int}(520) - h_{int}(120)}{(520) - (120)} = \frac{132,5027 - 121,0}{400} = 0,0288$$

chosen to demonstrate the smoothing for $200m < d < (599m)$

$$road_{grade,1}(720) = \frac{h_{int}(799) - h_{int}(520)}{799 - (520)} = \frac{121,2000 - 132,5027}{279} = -0,0405$$

chosen to demonstrate the smoothing for $d \geq (599m)$

The smoothed and interpolated altitude is calculated as:

$$h_{int,sm,1}(0) = h_{int}(0) + road_{grade,1}(0) = 120,3 + 0,0033 \approx 120,3033m$$

$$h_{int,sm,1}(799) = h_{int,sm,1}(798) + road_{grade,1}(799) = 121,2550 - 0,0220 = 121,2330m$$

Second smoothing run:

$$road_{grade,2}(0) = \frac{h_{int,sm,1}(200) - h_{int,sm,1}(0)}{(200)} = \frac{119,9618 - 120,3033}{(200)} = -0,0017$$

chosen to demonstrate the smoothing for $d \leq 200m$

$$road_{grade,2}(320) = \frac{h_{int,sm,1}(520) - h_{int,sm,1}(120)}{(520) - (120)} = \frac{123,6809 - 120,1843}{400} = 0,0087$$

chosen to demonstrate the smoothing for $200m < d < (599)$

$$road_{grade,2}(720) = \frac{h_{int,sm,1}(799) - h_{int,sm,1}(520)}{799 - (520)} = \frac{121,2330 - 123,6809}{279} = -0,0088$$

chosen to demonstrate the smoothing for $d \geq (599m)$

▼B

5.3.3. Calculation of the final result

The positive cumulative elevation gain of a trip is calculated by integrating all positive interpolated and smoothed road grades, i.e. values in the column $road_{grade,2}(d)$ in Table 2. For the entire data set the total covered distance was $d_{tot} = 139,7\text{km}$ and all positive interpolated and smoothed road grades were of 516m . Therefore the positive cumulative elevation gain reached $516 \cdot 100 / 139,7 = 370\text{m}/100\text{km}$.

Table 1

Correction of instantaneous vehicle altitude data

Time t [s]	$v(t)$ [km/h]	$h_{GPS}(t)$ [m]	$h_{map}(t)$ [m]	$h(t)$ [m]	$h_{corr}(t)$ [m]	d_i [m]	Cum. d [m]
0	0,00	122,7	129,0	122,7	122,7	0,0	0,0
1	0,00	122,8	129,0	122,8	122,7	0,0	0,0
2	0,00	—	129,1	123,6	122,7	0,0	0,0
3	0,00	—	129,2	124,3	122,7	0,0	0,0
4	0,00	125,1	129,0	125,1	122,7	0,0	0,0
...
18	0,00	120,2	129,4	120,2	120,2	0,0	0,0
19	0,32	120,2	129,4	120,2	120,2	0,1	0,1
...
37	24,31	120,9	132,7	120,9	120,9	6,8	117,9
38	28,18	121,2	133,0	121,2	121,2	7,8	125,7
...
46	13,52	121,4	131,9	121,4	121,4	3,8	193,4
47	38,48	120,7	131,5	120,7	120,7	10,7	204,1
...
56	42,67	119,8	125,2	119,8	119,8	11,9	308,4
57	41,70	119,7	124,8	119,7	119,7	11,6	320,0
...
110	10,95	125,2	132,2	125,2	125,2	3,0	509,0
111	11,75	100,8	132,3	100,8	125,2	3,3	512,2
112	13,52	0,0	132,4	132,4	125,2	3,8	516,0
113	14,01	0,0	132,5	132,5	132,5	3,9	519,9
114	13,36	24,30	132,6	132,6	132,6	3,7	523,6
...
149	39,93	123,6	129,6	123,6	123,6	11,1	719,2
150	39,61	123,4	129,5	123,4	123,4	11,0	730,2
...
157	14,81	121,3	126,1	121,3	121,3	4,1	792,1
158	14,19	121,2	126,2	121,2	121,2	3,9	796,1
159	10,00	128,5	126,1	128,5	121,2	2,8	798,8
160	4,10	130,6	126,0	130,6	121,2	1,2	800,0

— denotes data gaps

▼B

Table 2
Calculation of road grade

d [m]	t_0 [s]	d_0 [m]	d_1 [m]	h_0 [m]	h_1 [m]	$h_{int}(d)$ [m]	$road_{grade,1}(d)$ [m/m]	$h_{int,sm,1}(d)$ [m]	$road_{grade,2}(d)$ [m/m]
0	18	0,0	0,1	120,3	120,4	120,3	0,0035	120,3	- 0,0015
...
120	37	117,9	125,7	120,9	121,2	121,0	- 0,0019	120,2	0,0035
...
200	46	193,4	204,1	121,4	120,7	121,0	- 0,0040	120,0	0,0051
...
320	56	308,4	320,0	119,8	119,7	119,7	0,0288	121,4	0,0088
...
520	113	519,9	523,6	132,5	132,6	132,5	0,0097	123,7	0,0037
...
720	149	719,2	730,2	123,6	123,4	123,6	- 0,0405	122,9	- 0,0086
...
798	158	796,1	798,8	121,2	121,2	121,2	- 0,0219	121,3	- 0,0151
799	159	798,8	800,0	121,2	121,2	121,2	- 0,0220	121,3	- 0,0152

Figure 2

The effect of data verification and correction - The altitude profile measured by GPS $h_{GPS}(t)$, the altitude profile provided by the topographic map $h_{map}(t)$, the altitude profile obtained after the screening and principle verification of data quality $h(t)$ and the correction $h_{corr}(t)$ of data listed in Table 1

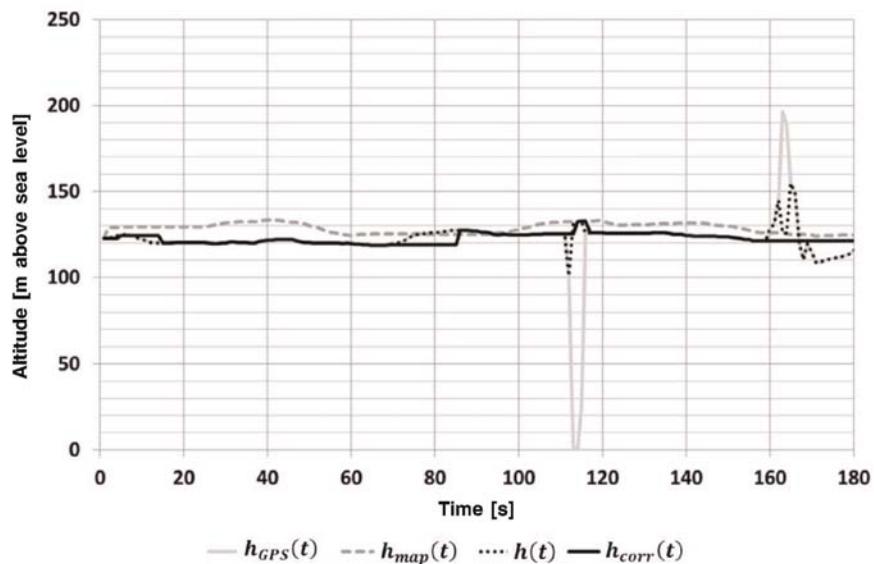

▼B

Figure 3

Comparison between the corrected altitude profile $h_{corr}(t)$ and the smoothed and interpolated altitude $h_{int,sm,1}$

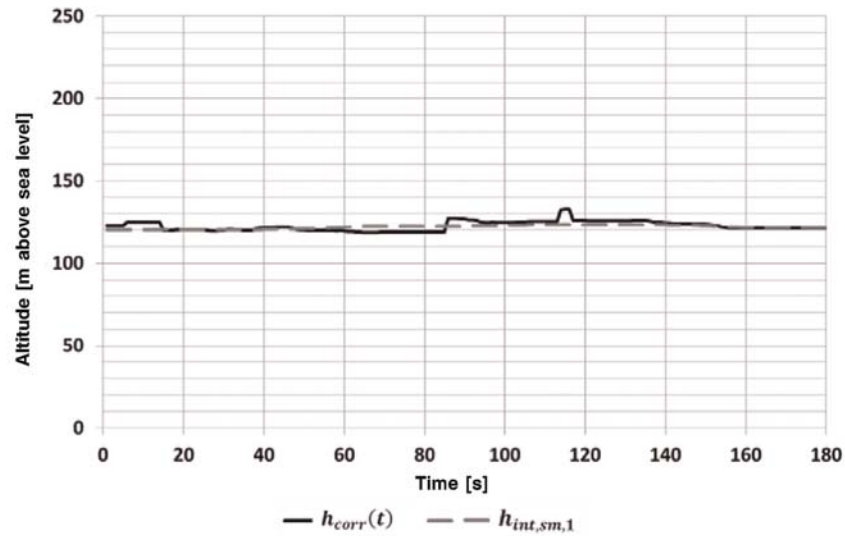

Table 3

Calculation of the positive elevation gain

d [m]	t_0 [s]	d_0 [m]	d_1 [m]	h_0 [m]	h_1 [m]	$h_{int}(d)$ [m]	$road_{grade,1}(d)$ [m/m]	$h_{int,sm,1}(d)$ [m]	$road_{grade,2}(d)$ [m/m]
0	18	0,0	0,1	120,3	120,4	120,3	0,0035	120,3	- 0,0015
...
120	37	117,9	125,7	120,9	121,2	121,0	- 0,0019	120,2	0,0035
...
200	46	193,4	204,1	121,4	120,7	121,0	- 0,0040	120,0	0,0051
...
320	56	308,4	320,0	119,8	119,7	119,7	0,0288	121,4	0,0088
...
520	113	519,9	523,6	132,5	132,6	132,5	0,0097	123,7	0,0037
...
720	149	719,2	730,2	123,6	123,4	123,6	- 0,0405	122,9	- 0,0086
...
798	158	796,1	798,8	121,2	121,2	121,2	- 0,0219	121,3	- 0,0151
799	159	798,8	800,0	121,2	121,2	121,2	- 0,0220	121,3	- 0,0152

▼ M3▼ B*Appendix 8***Data exchange and reporting requirements**▼ M3

1. INTRODUCTION

This Appendix describes the requirements for the data exchange between the measurement systems and the data evaluation software and for the reporting and exchange of intermediate and final RDE results after the completion of the data evaluation.

The exchange and reporting of mandatory and optional parameters shall follow the requirements of point 3.2 of Appendix 1. The technical report is composed of 5 items:

- (i) the Data Exchange file as described in point 4.1;
- (ii) the Reporting file #1 as described in point 4.2.1;
- (iii) the Reporting file #2 as described in point 4.2.2;
- (iv) the Vehicle and engine description as described in point 4.3;
- (v) the visual supporting material of the PEMS installation as described in point 4.4.

2. SYMBOLS, PARAMETERS AND UNITS

a_1	coefficient of the CO ₂ characteristic curve
b_1	coefficient of the CO ₂ characteristic curve
a_2	coefficient of the CO ₂ characteristic curve
b_2	coefficient of the CO ₂ characteristic curve
tol_{1-}	primary lower tolerance
tol_{1+}	primary upper tolerance
$(v \cdot a_{pos})_{95_k}$	95th percentile of the product of vehicle speed and positive acceleration greater than 0,1 m/s ² for urban, rural and motorway driving [m ² /s ³ or W/kg]
RPA_k	relative positive acceleration for urban, rural and motorway driving [m/s ² or kW/(kg*km)]
IC_k	is the distance share of usage of the internal combustion engine for an OVC-HEV over the RDE trip
$d_{ICE,k}$	is the distance driven [km], with the internal combustion engine on for an OVC-HEV over the RDE trip
$d_{EV,k}$	is the distance driven [km], with the internal combustion engine off for an OVC-HEV over the RDE trip

▼ M3

$M_{\text{CO}_2, \text{RDE}, k}$	is the distance-specific mass of CO ₂ [g/km], emitted over the RDE trip
$M_{\text{CO}_2, \text{WLTP}, k}$	is the distance-specific mass of CO ₂ [g/km], emitted over the WLTP
$M_{\text{CO}_2, \text{WLTP}_c, \text{S}, k}$	is the distance-specific mass of CO ₂ [g/km], emitted over the WLTP for an OVC-HEV vehicle tested on its charge sustaining mode
r_k	ratio between the CO ₂ emissions measured during the RDE test and the WLTP test
RF_k	is the result evaluation factor calculated for the RDE trip
RF_{L1}	is the first parameter of the function used to calculate the result evaluation factor
RF_{L2}	is the second parameter of the function used to calculate the result evaluation factor

▼ B

3. DATA EXCHANGE AND REPORTING FORMAT

▼ M3

3.1. General

Emission values as well as any other relevant parameters shall be reported and exchanged as csv-formatted data file. Parameter values shall be separated by a comma, ASCII-Code #h2C. Sub-parameter values shall be separated by a colon, ASCII-Code #h3B. The decimal marker of numerical values shall be a point, ASCII-Code #h2E. Lines shall be terminated by carriage return-linefeed, ASCII-Code #h0D #h0A. No thousands separators shall be used.

▼ B

3.2. Data exchange

Data shall be exchanged between the measurement systems and the data evaluation software by means of a standardised reporting file that contains a minimum set of mandatory and optional parameters. The data exchange file shall be structured as follows: The first 195 lines shall be reserved for a header that provides specific information about, e.g., the test conditions, the identity and calibration of the PEMS equipment (Table 1). Lines 198-200 shall contain the labels and units of parameters. Lines 201 and all consecutive data lines shall comprise the body of the data exchange file and report parameter values (Table 2). The body of the data exchange file shall contain at least as many data lines as the test duration in seconds multiplied by the recording frequency in hertz.

▼ M3

3.3. Intermediate and final results

Summary parameters of intermediate results shall be recorded and structured as indicated in Table 3. The information in Table 3 shall be obtained prior to the application of the data evaluation and emission calculation methods laid down in Appendices 5 and 6.

▼ M3

The vehicle manufacturer shall record the available results of the data evaluation methods in separate files. The results of the data evaluation with the method described in Appendix 5 and emissions calculation described in Appendix 6 shall be reported in accordance with Tables 4, 5 and 6. The header of the data reporting file shall be composed of three parts. The first 95 lines shall be reserved for specific information about the settings of the data evaluation method. Lines 101-195 shall report the results of the data evaluation method. Lines 201-490 shall be reserved for reporting the final emission results. Line 501 and all consecutive data lines comprise the body of the data reporting file and shall contain the detailed results of the data evaluation.

▼ B

4. TECHNICAL REPORTING TABLES

▼ M3

4.1. Data exchange

Left column in Table 1 is the parameter to be reported (fixed format and content). Central column in Table 1 is the description and or unit (fixed format and content). If a parameter can be described with an element of a pre-defined list from the central column, then the parameter shall be described using the predefined nomenclature (e.g. In the Data Exchange file line 19, a manual transmission vehicle should be described as manual and not MT or Man, or any other nomenclature). Right column in Table 1 is where the actual data should be inserted. In the tables, dummy data has been inserted to show the proper way to fill in the reported content. The order of the columns and lines (including blanks) must be respected.

Table 1

Header of the data exchange file

TEST ID	[code]	TEST_01_Veh01
Test date	[dd.mm.yyyy]	13.10.2016
Organisation supervising the test	[name of the organization]	Dummy
Test location	[City (Country)]	Ispra (Italy)
Organisation commissioning the test	[name of the organization]	Dummy
Vehicle driver	[TS/Lab/OEM]	VELA lab
Vehicle type	[vehicle commercial name]	Commercial name
Vehicle manufacturer	[name]	Dummy
Vehicle model year	[year]	2017
Vehicle ID	[VIN code as defined in ISO 3779:2009]	ZA1JRC2U912345678

▼ M3

TEST ID	[code]	TEST_01_Veh01
Odometer value at test start	[km]	5 252
Odometer value at test end	[km]	5 341
Vehicle category	[category as defined in Annex II to Directive 70/156/EEC]	M1
Type approval emissions limit	[Euro X]	Euro 6c
Ignition type	[PI/CI]	PI
Engine rated power	[kW]	85
Peak torque	[Nm]	190
Engine displacement	[ccm]	1 197
Transmission	[manual/automatic/CVT]	CVT
Number of forward gears	[#]	6
Fuel type. If flexifuel indicate fuel used in the test	[gasoline/diesel/LPG/NG/biomethane/ethanol/biodiesel]	Diesel
Lubricant	[product label]	5W30
Front and rear tyre size	[width.height.rim diameter/ width.height.rim diameter]	195.55.20/195.55.20
Front and rear axle tyre pressure	[bar/bar]	2,5/2,6
Road load parameters	[F ₀ /F ₁ /F ₂]	60,1/0,704/0,03122
Type-approval test cycle	[NEDC/WLTC]	WLTC
Type-approval CO ₂ emissions	[g/km]	139,1
CO ₂ emissions in WLTC mode Low	[g/km]	155,1
CO ₂ emissions in WLTC mode Mid	[g/km]	124,5
CO ₂ emissions in WLTC mode High	[g/km]	133,8
CO ₂ emissions in WLTC mode Extra High	[g/km]	146,2

▼ M3

TEST ID	[code]	TEST_01_Veh01
Vehicle test mass ⁽¹⁾	[kg]	1 743,1
PEMS manufacturer	[name]	MANUF 01
PEMS type	[PEMS commercial name]	PEMS X56
PEMS serial number	[number]	C9658
PEMS power supply	[battery type Li-ion/Ni-Fe/Mg-ion]	Li-ion
Gas analyser manufacturer	[name]	MANUF 22
Gas analyser type	[type]	IR
Gas analyser serial number	[number]	556
Propulsion type	[ICE/NOVC-HEV/ OVC-HEV]	ICE
Electric motor power	[kW. 0 if vehicle with ICE only]	0
Engine condition at test start	[cold/warm]	Cold
Wheel drive mode	[2WD/4WD]	2WD
Artificial payload	[% deviation from the payload]	28
Fuel used	[reference/market/EN228]	market
Tyre tread depth	[mm]	5
Vehicle age	[months]	26
Fuel supply system	[Direct injection/Indirect injection/Direct and indirect injection]	Direct injection
Type of bodywork	[saloon/hatchback/station wagon/coupé/convertible/lorry/van]	saloon
CO ₂ emission on charge sustaining (OVC-HEVs)	[g/km]	—
EFM manufacturer ⁽³⁾	[name]	EFMman 2
EFM sensor type ⁽³⁾	[functional principle]	Pitot
EFM serial number ⁽³⁾	[number]	556
Source of exhaust mass flow rate	[EFM/ECU/sensor]	EFM

▼ M3

TEST ID	[code]	TEST_01_Veh01
Air pressure sensor	[type/ manufacturer]	Piezoresistor/AAA
Test date	[dd.mm.yyyy]	13.10.2016
Start time of pre-test procedure	[h:min]	15:25
Start time of trip	[h:min]	15:42
Start time of post-test procedure	[h:min]	17:28
End time of pre-test procedure	[h:min]	15:32
End time of trip	[h:min]	17:25
End time of post-test procedure	[h:min]	17:38
Soaking maximum temperature	[K]	291,2
Soaking minimum temperature	[K]	290,7
Soaking done totally or partially in ambient temperature extended conditions	[yes/no]	No
Drive mode for ICE if any	[normal/sport/eco]	Eco
Drive mode for PHEV	[charge sustaining/charge depleting/battery charge/mild operation]	
Any active safety system disabled during the test?	[No/ESP/ABS/AEB]	No
Start-stop system active	[yes/no/no SS]	no SS
Air conditioning	[off/on]	off
Time correction: Shift THC	[s]	
Time correction: Shift CH4	[s]	
Time correction: Shift NMHC	[s]	
Time correction: Shift O ₂	[s]	- 2

▼ **M3**

TEST ID	[code]	TEST_01_Veh01
Time correction: Shift PN	[s]	3,1
Time correction: Shift CO	[s]	2,1
Time correction: Shift CO ₂	[s]	2,1
Time correction: Shift NO	[s]	- 1,1
Time correction: Shift NO ₂	[s]	- 1,1
Time correction: Shift exhaust mass flow rate	[s]	3,2
Span reference value THC	[ppm]	
Span reference value CH ₄	[ppm]	
Span reference value NMHC	[ppm]	
Span reference value O ₂	[%]	
Span reference value PN	[#]	
Span reference value CO	[ppm]	18 000
Span reference value CO ₂	[%]	15
Span reference value NO	[ppm]	4 000
Span Reference Value NO ₂	[ppm]	550
(⁴)		
(⁴)		
(⁴)		
(⁴)		
(⁴)		
(⁴)		
(⁴)		
Pre-test zero response THC	[ppm]	

▼ M3

TEST ID	[code]	TEST_01_Veh01
Pre-test zero response CH ₄	[ppm]	
Pre-test zero response NMHC	[ppm]	
Pre-test zero response O ₂	[%]	
Pre-test zero response PN	[#]	
Pre-test zero response CO	[ppm]	0
Pre-test zero response CO ₂	[%]	0
Pre-test zero response NO	[ppm]	0,03
Pre-test zero response NO ₂	[ppm]	- 0,06
Pre-test span response THC	[ppm]	
Pre-test span response CH ₄	[ppm]	
Pre-test span response NMHC	[ppm]	
Pre-test span response O ₂	[%]	
Pre-test span response PN	[#]	
Pre-test span response CO	[ppm]	18 008
Pre-test span response CO ₂	[%]	14,8
Pre-test span response NO	[ppm]	4 000
Pre-test span response NO ₂	[ppm]	549

▼ M3

TEST ID	[code]	TEST_01_Veh01
Post-test zero response THC	[ppm]	
Post-test zero response CH ₄	[ppm]	
Post-test zero response NMHC	[ppm]	
Post-test zero response O ₂	[%]	
Post-test zero response PN	[#]	
Post-test zero response CO	[ppm]	0
Post-test zero response CO ₂	[%]	0
Post-test zero response NO	[ppm]	0,11
Post-test zero response NO ₂	[ppm]	0,12
Post-test span response THC	[ppm]	
Post-test span response CH ₄	[ppm]	
Post-test span response NMHC	[ppm]	
Post-test span response O ₂	[%]	
Post-test span response PN	[#]	
Post-test span response CO	[ppm]	18 010
Post-test span response CO ₂	[%]	14,55
Post-test span response NO	[ppm]	4 505
Post-test span response NO ₂	[ppm]	544

▼ **M3**

TEST ID	[code]	TEST_01_Veh01
PEMS validation - results THC	[mg/km]	
PEMS validation - results CH ₄	[mg/km]	
PEMS validation - results NMHC	[mg/km]	
PEMS validation - results PN	[#/km]	
PEMS validation - results CO	[mg/km]	56,0
PEMS validation - results CO ₂	[g/km]	2,2
PEMS validation - results NO _x	[mg/km]	11,5
PEMS validation - results THC	[% of the laboratory reference]	
PEMS validation - results CH ₄	[% of the laboratory reference]	
PEMS validation - results NMHC	[% of the laboratory reference]	
PEMS validation - results PN	[% of the PMP system]	
PEMS validation - results CO	[% of the laboratory reference]	2,0
PEMS validation - results CO ₂	[% of the laboratory reference]	3,5
PEMS validation - results NO _x	[% of the laboratory reference]	4,2
PEMS validation - results NO	[mg/km]	
PEMS validation - results NO ₂	[mg/km]	
PEMS validation - results NO	[% of the laboratory reference]	
PEMS validation - results NO ₂	[% of the laboratory reference]	
NO _x margin	[value]	0,43
PN margin	[value]	0,5

▼ **M3**

TEST ID	[code]	TEST_01_Veh01
CO margin	[value]	
K _i used	[none/additive/multiplicative]	none
K _i factor/ K _i offset	[value]	
(⁵)		

(¹) Mass of the vehicle as tested on the road, including the mass of the driver and all PEMS components including any artificial payload.

(²) Placeholders for additional information about analyser manufacturer and serial number in case multiple analysers are used.

(³) Mandatory if the exhaust mass flow rate is determined by an EFM.

(⁴) If required, additional information may be added here.

(⁵) Additional parameters may be added to characterise and label the test.

The body of the data exchange file is composed of a 3-line header corresponding to lines 198, 199, and 200 (Table 2, transposed) and the actual values recorded during the trip, to be included from line 201 onward until the end of data. Left column of Table 2 corresponds to line 198 of the data exchange file (fixed format). Central column of Table 2 corresponds to line 199 of the data exchange file (fixed format). Right column of Table 2 corresponds to line 200 of the data exchange file (fixed format).

Table 2

Body of the data exchange file; the rows and columns of this table shall be transposed in the body of the data exchange file

Time	trip	[s]
Vehicle speed (¹)	Sensor	[km/h]
Vehicle speed (¹)	GPS	[km/h]
Vehicle speed (¹)	ECU	[km/h]
Latitude	GPS	[deg:min:s]
Longitude	GPS	[deg:min:s]
Altitude (¹)	GPS	[m]
Altitude (¹)	Sensor	[m]
Ambient pressure	Sensor	[kPa]
Ambient temperature	Sensor	[K]
Ambient humidity	Sensor	[g/kg]
THC concentration	Analyser	[ppm]
CH ₄ concentration	Analyser	[ppm]
NMHC concentration	Analyser	[ppm]
CO concentration	Analyser	[ppm]

▼ M3

CO ₂ concentration	Analyser	[ppm]
NO _x concentration	Analyser	[ppm]
NO concentration	Analyser	[ppm]
NO ₂ concentration	Analyser	[ppm]
O ₂ concentration	Analyser	[ppm]
PN concentration	Analyser	[#/m ³]
Exhaust mass flow rate	EFM	[kg/s]
Exhaust temperature in the EFM	EFM	[K]
Exhaust mass flow rate	Sensor	[kg/s]
Exhaust mass flow rate	ECU	[kg/s]
THC mass	Analyser	[g/s]
CH ₄ mass	Analyser	[g/s]
NMHC mass	Analyser	[g/s]
CO mass	Analyser	[g/s]
CO ₂ mass	Analyser	[g/s]
NO _x mass	Analyser	[g/s]
NO mass	Analyser	[g/s]
NO ₂ mass	Analyser	[g/s]
O ₂ mass	Analyser	[g/s]
PN	Analyser	[#/s]
Gas measurement active	PEMS	[active (1); inactive (0); error (> 1)]
Engine speed	ECU	[rpm]
Engine torque	ECU	[Nm]
Torque at driven axle	Sensor	[Nm]
Wheel rotational speed	Sensor	[rad/s]
Fuel rate	ECU	[g/s]
Engine fuel flow	ECU	[g/s]
Engine intake air flow	ECU	[g/s]
Engine Coolant temperature	ECU	[K]
Engine Oil temperature	ECU	[K]

▼ **M3**

Regeneration status	ECU	—
Pedal position	ECU	[%]
Vehicle status	ECU	[error (1); normal (0)]
Percent torque	ECU	[%]
Per cent friction torque	ECU	[%]
State of charge	ECU	[%]
Relative ambient humidity	Sensor	[%]
(²)		

(¹) To be determined by at least one method

(²) Additional parameters may be added to characterise vehicle and test conditions.

Left column in Table 3 is the parameter to be reported (fixed format). Central column in Table 3 is the description and or unit (fixed format). If a parameter can be described with an element of a pre-defined list from the central column, then the parameter shall be described using the predefined nomenclature. Right column in Table 3 is where the actual data should be inserted. In the table, dummy data has been inserted to show the proper way to fill in the reported content. The order of the columns and lines must be respected.

4.2. Intermediate and final results

4.2.1. Intermediate results

Table 3

Reporting file #1 - Summary parameters of intermediate results

Total trip distance	[km]	90,9
Total trip duration	[h:min:s]	01:37:03
Total stop time	[min:s]	09:02
Trip average speed	[km/h]	56,2
Trip maximum speed	[km/h]	142,8
Average THC emissions	[ppm]	
Average CH ₄ emissions	[ppm]	
Average NMHC emissions	[ppm]	
Average CO emissions	[ppm]	15,6
Average CO ₂ emissions	[ppm]	119 969,1
Average NO _x emissions	[ppm]	6,3

▼ M3

Average PN emissions	[#/m ³]	
Average exhaust mass flow rate	[kg/s]	0,010
Average exhaust temperature	[K]	368,6
Maximum exhaust temperature	[K]	486,7
Cumulated THC mass	[g]	
Cumulated CH ₄ mass	[g]	
Cumulated NMHC mass	[g]	
Cumulated CO mass	[g]	0,69
Cumulated CO ₂ mass	[g]	12 029,53
Cumulated NO _x mass	[g]	0,71
Cumulated PN	[#]	
Total trip THC emissions	[mg/km]	
Total trip CH ₄ emissions	[mg/km]	
Total trip NMHC emissions	[mg/km]	
Total trip CO emissions	[mg/km]	7,68
Total trip CO ₂ emissions	[g/km]	132,39
Total trip NO _x emissions	[mg/km]	7,98
Total trip PN emissions	[#/km]	
Distance urban part	[km]	34,7
Duration urban part	[h:min:s]	01:01:42
Stop time urban part	[min:s]	09:02
Average speed urban part	[km/h]	33,8
Maximum speed urban part	[km/h]	59,9
Average urban THC concentration	[ppm]	
Average urban CH ₄ concentration	[ppm]	

▼ M3

Average urban NMHC concentration	[ppm]	
Average urban CO concentration	[ppm]	23,8
Average urban CO ₂ concentration	[ppm]	115 968,4
Average urban NO _x concentration	[ppm]	7,5
Average urban PN concentration	[#/m ³]	
Average urban exhaust mass flow rate	[kg/s]	0,007
Average urban exhaust temperature	[K]	348,6
Maximum urban exhaust temperature	[K]	435,4
Cumulated urban THC mass	[g]	
Cumulated urban CH ₄ mass	[g]	
Cumulated urban NMHC mass	[g]	
Cumulated urban CO mass	[g]	0,64
Cumulated urban CO ₂ mass	[g]	5 241,29
Cumulated urban NO _x mass	[g]	0,45
Cumulated urban PN	[#]	
Urban THC emissions	[mg/km]	
Urban CH ₄ emissions	[mg/km]	
Urban NMHC emissions	[mg/km]	
Urban CO emissions	[mg/km]	18,54
Urban CO ₂ emissions	[g/km]	150,64
Urban NO _x emissions	[mg/km]	13,18
Urban PN emissions	[#/km]	
Distance rural part	[km]	30,0

▼ M3

Duration rural part	[h:min:s]	00:22:28
Stop time rural part	[min:s]	00:00
Average speed rural part	[km/h]	80,2
Maximum speed rural part	[km/h]	89,8
Average rural THC concentration	[ppm]	
Average rural CH ₄ concentration	[ppm]	
Average rural NMHC concentration	[ppm]	
Average rural CO concentration	[ppm]	0,8
Average rural CO ₂ concentration	[ppm]	126 868,9
Average rural NO _x concentration	[ppm]	4,8
Average rural PN concentration	[#/m ³]	
Average rural exhaust mass flow rate	[kg/s]	0,013
Average rural exhaust temperature	[K]	383,8
Maximum rural exhaust temperature	[K]	450,2
Cumulated rural THC mass	[g]	
Cumulated rural CH ₄ mass	[g]	
Cumulated rural NMHC mass	[g]	
Cumulated rural CO mass	[g]	0,01
Cumulated rural CO ₂ mass	[g]	3 500,77
Cumulated rural NO _x mass	[g]	0,17

▼ M3

Cumulated rural PN	[#]	
Rural THC emissions	[mg/km]	
Rural CH ₄ emissions	[mg/km]	
Rural NMHC emissions	[mg/km]	
Rural CO emissions	[mg/km]	0,25
Rural CO ₂ emissions	[g/km]	116,44
Rural NO _x emissions	[mg/km]	5,78
Rural PN emissions	[#/km]	
Distance motorway part	[km]	26,1
Duration motorway part	[h:min:s]	00:12:53
Stop time motorway part	[min:s]	00:00
Average speed motorway part	[km/h]	121,3
Maximum speed motorway part	[km/h]	142,8
Average motorway THC concentration	[ppm]	
Average motorway CH ₄ concentration	[ppm]	
Average motorway NMHC concentration	[ppm]	
Average motorway CO concentration	[ppm]	2,45
Average motorway CO ₂ concentration	[ppm]	127 096,5
Average motorway NO _x concentration	[ppm]	2,48
Average motorway PN concentration	[#/m ³]	
Average motorway exhaust mass flow rate	[kg/s]	0,022
Average motorway exhaust temperature	[K]	437,9
Maximum motorway exhaust temperature	[K]	486,7

▼ M3

Cumulated motorway THC mass	[g]	
Cumulated motorway CH ₄ mass	[g]	
Cumulated motorway NMHC mass	[g]	
Cumulated motorway CO mass	[g]	0,04
Cumulated motorway CO ₂ mass	[g]	3 287,47
Cumulated motorway NO _x mass	[g]	0,09
Cumulated motorway PN	[#]	
Motorway THC emissions	[mg/km]	
Motorway CH ₄ emissions	[mg/km]	
Motorway NMHC emissions	[mg/km]	
Motorway CO emissions	[mg/km]	1,76
Motorway CO ₂ emissions	[g/km]	126,20
Motorway NO _x emissions	[mg/km]	3,29
Motorway PN emissions	[#/km]	
Altitude at start point of the trip	[m above sea level]	123,0
Altitude at end point of the trip	[m above sea level]	154,1
Cumulative elevation gain during the trip	[m/100 km]	834,1
Cumulative urban elevation gain	[m/100 km]	760,9
Urban datasets with acceleration values > 0,1 m/s ²	[number]	845
(v · a _{pos}) ⁹⁵ urban	[m ² /s ³]	9,03
RPA _{urban}	[m/s ²]	0,18
Rural datasets with acceleration values > 0,1 m/s ²	[number]	543

▼ **M3**

($v \cdot a_{pos}$)95 rural	[m ² /s ³]	9,60
RPArural	[m/s ²]	0,07
Motorway datasets with acceleration values > 0,1 m/s ²	[number]	268
($v \cdot a_{pos}$)95 motorway	[m ² /s ³]	5,32
RPAmotorway	[m/s ²]	0,03
Cold start distance	[km]	2,3
Cold start duration	[h:min:s]	00:05:00
Cold start stop time	[min:s]	60
Cold start average speed	[km/h]	28,5
Cold start maximum speed	[km/h]	55,0
Urban distance driven with ICE on	[km]	34,8
Speed signal used	[GPS/ECU/sensor]	GPS
T4253H-Filter used	[yes/no]	no
Duration of longest stop period	[s]	54
urban stops > 10 seconds	[number]	12
Idling time after 1st ignition	[s]	7
Motorway speed share > 145 km/h	[%]	0,1
Maximum altitude during the trip	[m]	215
Maximum ambient temperature	[K]	293,2
Minimum ambient temperature	[K]	285,7
Trip done totally or partially in altitude extended conditions	[yes/no]	no
Trip done totally or partially in ambient temperature extended conditions	[yes/no]	no
Average NO emissions	[ppm]	3,2
Average NO ₂ emissions	[ppm]	2,1
Cumulated NO mass	[g]	0,23
Cumulated NO ₂ mass	[g]	0,09
Total trip NO emissions	[mg/km]	5,90
Total trip NO ₂ emissions	[mg/km]	2,01
Average urban NO concentration	[ppm]	7,6

▼ **M3**

Average urban NO ₂ concentration	[ppm]	1,2
Cumulated urban NO mass	[g]	0,33
Cumulated urban NO ₂ mass	[g]	0,12
Urban NO emissions	[mg/km]	11,12
Urban NO ₂ emissions	[mg/km]	2,12
Average rural NO concentration	[ppm]	3,8
Average rural NO ₂ concentration	[ppm]	1,8
Cumulated rural NO mass	[g]	0,33
Cumulated rural NO ₂ mass	[g]	0,12
Rural NO emissions	[mg/km]	11,12
Rural NO ₂ emissions	[mg/km]	2,12
Average motorway NO concentration	[ppm]	2,2
Average motorway NO ₂ concentration	[ppm]	0,4
Cumulated motorway NO mass	[g]	0,33
Cumulated motorway NO ₂ mass	[g]	0,12
Motorway NO emissions	[mg/km]	11,12
Motorway NO ₂ emissions	[mg/km]	2,21
TEST ID	[code]	TEST_01_Veh01
Test date	[dd.mm.yyyy]	13.10.2016
Organisation supervising the test	[name of the organization]	Dummy
(¹)		

(¹) Parameters may be added to characterize additional elements of the trip.

4.2.2. Results of the data evaluation

In Table 4, from lines 1 to 497, the left column is the parameter to be reported (fixed format), the central column is the description and or unit (fixed format), and the right column is where the actual data should be inserted. In the table, dummy data has been inserted to show the proper way to fill in the reported content. The order of the columns and lines must be respected.

▼ M3

Table 4

Header of reporting file #2 - Calculation settings of the data evaluation method in accordance with Appendix 5 and Appendix 6

Reference CO ₂ mass	[g]	1 529,48
Coefficient a ₁ of the CO ₂ characteristic curve	—	- 1,99
Coefficient b ₁ of the CO ₂ characteristic curve	—	238,07
Coefficient a ₂ of the CO ₂ characteristic curve	—	0,49
Coefficient b ₂ of the CO ₂ characteristic curve	—	97,02
[reserved]	—	
[reserved]	—	
[reserved]	—	
[reserved]	—	
[reserved]	—	
Calculation software and version	—	EMROAD V.5.90 B5
Primary upper tolerance tol ₁₊	[%][% URB/ % RUR/ % MOT]	45/40/40
Primary lower tolerance tol ₁₋	[%]	25
IC(t)	[ICE ratio on total trip]	1
dICE(t)	[km on ICE on total trip]	88
dEV(t)	[km on electric on total trip]	0
mCO ₂ _WLTP_CS(t)	[kg of CO ₂ emitted over the WLTP for an OVC-HEV tested on its charge sustaining mode]	
MCO ₂ _WLTP(t)	[distance-specific CO ₂ emitted over the WLTP g/km]	154
MCO ₂ _WLTP_CS(t)	[distance-specific CO ₂ for an OVC-HEV emitted over the WLTP tested on its charge sustaining mode g/km]	
MCO ₂ _RDE(t)	[distance-specific mass of CO ₂ [g/km], emitted over the total RDE trip]	122,4

▼ M3

MCO2_RDE(u)	[distance-specific mass of CO ₂ [g/km], emitted over the urban RDE trip]	135,8
r(t)	[ratio between the CO ₂ emissions measured during the RDE test and the WLTP test]	1,15
r _{OVC-HEV} (t)	[ratio between the CO ₂ emissions measured during the total RDE test and the total WLTP for an OVC-HEV]	
RF(t)	[result evaluation factor calculated for the total RDE trip]	1
RFL1	[first parameter of the function used to calculate the result evaluation factor]	1,2
RFL2	[second parameter of the function used to calculate the result evaluation factor]	1,25
IC(u)	[ICE ratio on urban trip]	1
dICE(u)	[km on ICE on urban trip]	25
dEV(u)	[km on electric on urban trip]	0
r(u)	[ratio between the CO ₂ emissions measured during the urban part of the RDE test and the WLTP test phases 1 + 2]	1,26
r _{OVC-HEV} (u)	[ratio between the CO ₂ emissions measured during the urban part of the RDE test and the total WLTP for an OVC-HEV]	
RF(u)	[result evaluation factor calculated for the urban RDE trip]	0,793651
TEST ID	[code]	TEST_01_Veh01
Test date	[dd.mm.yyyy]	13.10.2016
Organisation supervising the test	[name of the organization]	Dummy
(¹)		

(¹) Parameters may be added until line 95 to characterize additional calculation settings.

Table 5a starts from lines 101 of the data reporting file #2. The left column is the parameter to be reported (fixed format), the central column is the description and or unit (fixed format), and the right column is where the actual data should be inserted. In the table, dummy data has been inserted to show the proper way to fill in the reported content. The order of the columns and lines must be respected.

▼ M3

Table 5a

Header of reporting file #2 – Results of the data evaluation method in accordance with Appendix 5

Number of windows	—	4 265
Number of urban windows	—	1 551
Number of rural windows	—	1 803
Number of motorway windows	—	910
[reserved]	—	—
[reserved]	—	—
[reserved]	—	—
[reserved]	—	—
[reserved]	—	—
[reserved]	—	—
Number of windows within tol ₁	—	4 219
Number of urban windows within tol ₁	—	1 535
Number of rural windows within tol ₁	—	1 774
Number of motorway windows within tol ₁	—	910
[reserved]	—	—
[reserved]	—	—
[reserved]	—	—
[reserved]	—	—
Share of urban windows within tol ₁	[%]	99,0
Share of rural windows within tol ₁	[%]	98,4
Share of motorway windows within tol ₁	[%]	100,0
Share of urban windows within tol ₁ greater than 50 %	[1 = Yes; 0 = No]	1
Share of rural windows within tol ₁ greater than 50 %	[1 = Yes; 0 = No]	1
Share of motorway windows within tol ₁ greater than 50 %	[1 = Yes; 0 = No]	1

▼ M3

[reserved]	—	—
[reserved]	—	—
[reserved]	—	—
[reserved]	—	—
[reserved]	—	—
[reserved]	—	—
[reserved]	—	—
[reserved]	—	—
[reserved]	—	—
[reserved]	—	—
[reserved]	—	—
[reserved]	—	—
[reserved]	—	—
[reserved]	—	—
[reserved]	—	—
[reserved]	—	—
[reserved]	—	—
[reserved]	—	—
[reserved]	—	—
[reserved]	—	—
[reserved]	—	—
[reserved]	—	—
[reserved]	—	—
[reserved]	—	—
[reserved]	—	—
[reserved]	—	—
[reserved]	—	—
[reserved]	—	—
[reserved]	—	—
[reserved]	—	—
[reserved]	—	—
[reserved]	—	—
[reserved]	—	—
[reserved]	—	—
[reserved]	—	—
[reserved]	—	—
[reserved]	—	—
[reserved]	—	—
[reserved]	—	—
[reserved]	—	—
[reserved]	—	—
[reserved]	—	—
[reserved]	—	—
[reserved]	—	—
(1)		

(1) Additional parameters may be added until line 195.

Table 5b starts from lines 201 of the data reporting file #2. The left column is the parameter to be reported (fixed format), the central column is the description and or unit (fixed format), and the right column is where the actual data should be inserted. In the table, dummy data has been inserted to show the proper way to fill in the reported content. The order of the columns and lines must be respected.

▼ **M3**

Table 5b

Header of reporting file #2 – Final emission results in accordance with Appendix 6

Total trip - THC emissions	[mg/km]	
Total trip - CH ₄ emissions	[mg/km]	
Total trip - NMHC emissions	[mg/km]	
Total trip - CO emissions	[mg/km]	
Total trip - NO _x emissions	[mg/km]	6,73
Total trip - PN emissions	[#/km]	$1,15 \times 10^{11}$
Total trip - CO ₂ emissions	[g/km]	
Total trip - NO emissions	[mg/km]	4,73
Total trip - NO ₂ emissions	[mg/km]	2
Urban trip - THC emissions	[mg/km]	
Urban trip - CH ₄ emissions	[mg/km]	
Urban trip - NMHC emissions	[mg/km]	
Urban trip - CO emissions	[mg/km]	
Urban trip - NO _x emissions	[mg/km]	8,13
Urban trip - PN emissions	[#/km]	$0,85 \times 10^{11}$
Urban trip - CO ₂ emissions	[g/km]	
Urban trip - NO emissions	[mg/km]	6,41
Urban trip - NO ₂ emissions	[mg/km]	2,5
(¹)		

(¹) Additional parameters may be added.

The body of the reporting file #2 is composed by a 3-line header corresponding to lines 498, 499, and 500 (Table 6, transposed) and the actual values describing the Moving Average Windows as calculated in accordance with Appendix 5 shall be included from line 501 onward until the end of data. Left column of Table 6 corresponds to line 498 of the reporting file #2 (fixed format). Central column of Table 6 corresponds to line 499 of the reporting file #2 (fixed format). Right column of Table 6 corresponds to line 500 of the reporting file #2 (fixed format).

Table 6

Body of reporting file #2 - Detailed results of the data evaluation method in accordance with Appendix 5; the rows and columns of this table shall be transposed in the body of the data reporting file

Window Start Time		[s]
Window End Time		[s]
Window Duration		[s]
Window Distance	Source (1 = GPS; 2 = ECU; 3 = Sensor)	[km]
[reserved]	—	—
[reserved]	—	—

▼ **M3**

[reserved]	—	—
[reserved]	—	—
Window CO ₂ emissions		[g]
[reserved]	—	—
[reserved]	—	—
[reserved]	—	—
[reserved]	—	—
[reserved]	—	—
[reserved]	—	—
[reserved]	—	—
[reserved]	—	—
[reserved]	—	—
Window CO ₂ emissions		[g/km]
[reserved]	—	—
[reserved]	—	—
[reserved]	—	—
[reserved]	—	—
[reserved]	—	—
Window distance to CO ₂ characteristic curve h _j		[%]
[reserved]		[-]
Window Average Vehicle Speed	Source (1 = GPS; 2 = ECU; 3 = Sensor)	[km/h]
(¹)		

(¹) Additional parameters may be added to characterise window characteristics.

▼ **B**4.3. **Vehicle and engine description**

The manufacturer shall provide the vehicle and engine description in accordance with Appendix 4 of Annex I.

▼ **M3**4.4. **Visual supporting material of the PEMS installation**

It is necessary to document with visual material (photographs and/or videos) the installation of the PEMS on every tested vehicle. The pictures should be in quantity and quality enough to identify the vehicle and to assess if the installation of the PEMS main unit, the EFM, the GPS antenna, and the weather station follow the instrument manufacturers recommendations and the general good practices of PEMS testing.

▼ **M3**

Appendix 9

Manufacturer's certificate of compliance

Manufacturer's certificate of compliance with the Real Driving Emissions requirements

(Manufacturer):

(Address of the Manufacturer):

Certifies that

The vehicle types listed in the attachment to this Certificate comply with the requirements laid down in point 2.1 of Annex IIIA to Regulation (EU) 2017/1151 relating to real driving emissions for all possible RDE tests, which are in accordance to the requirements of this Annex.

Done at [..... (Place)]

On [..... (Date)]

.....

(Stamp and signature of the manufacturer's representative)

Annex:

- List of vehicle types to which this certificate applies
- List of the declared maximum RDE values for each vehicle type expressed as mg/km or particle numbers/km as appropriate, without the inclusion of the margin specified in point 2.1.1 of Annex IIIA.

▼B

ANNEX IV

**EMISSIONS DATA REQUIRED AT TYPE-APPROVAL FOR
ROADWORTHINESS PURPOSES**

*Appendix 1***MEASURING CARBON MONOXIDE EMISSION AT ENGINE IDLING SPEEDS****(TYPE 2 TEST)****1. INTRODUCTION**

- 1.1. This appendix describes the procedure for the type 2 test, measuring carbon monoxide emissions at engine idling speeds (normal and high).

2. GENERAL REQUIREMENTS

- 2.1. The general requirements shall be those specified in section 5.3.2 and paragraphs 5.3.7.1 to 5.3.7.6 of UN/ECE Regulation No 83, with the exception set out in section 2.2.
- 2.2. The table referred to in paragraph 5.3.7.5. of UN/ECE Regulation No 83 shall be understood as the table for the Type 2 test in section 2.1 the Addendum to Appendix 4 to Annex I to this Regulation.

3. TECHNICAL REQUIREMENTS

- 3.1. The technical requirements shall be those set out in Annex 5 to UN/ECE Regulation No 83, with the exceptions set out in sections 3.2. and 3.3.
- 3.2. The reference fuel specifications referred to in paragraph 2.1 of Annex 5 to UN/ECE Regulation No 83 shall be understood as referring to the appropriate reference fuel specifications in Annex IX to this Regulation.
- 3.3. Reference to the Type I test in paragraph 2.2.1. of Annex 5 to UN/ECE Regulation No 83 shall be understood as referring to the Type 1 test in Annex XXI to this Regulation.

▼B*Appendix 2***MEASUREMENT OF SMOKE OPACITY****1. INTRODUCTION**

1.1. This Appendix describes the requirements for measuring the opacity of exhaust emissions.

2. SYMBOL OF THE CORRECTED ABSORPTION COEFFICIENT

2.1. A symbol of the corrected absorption coefficient shall be affixed to every vehicle conforming to a vehicle type to which this test applies. The symbol shall be a rectangle surrounding a figure expressing in m^{-1} the corrected absorption coefficient obtained, at the time of approval, from the test under free acceleration. The test method is described in section 4.

2.2. The symbol shall be clearly legible and indelible. It shall be fixed in a conspicuous and readily accessible place, the location of which shall be specified in the Addendum to the type-approval certificate shown in Appendix 4 to Annex I.

2.3. Figure IV.2.1 gives an example of the symbol.

Figure IV.2.1

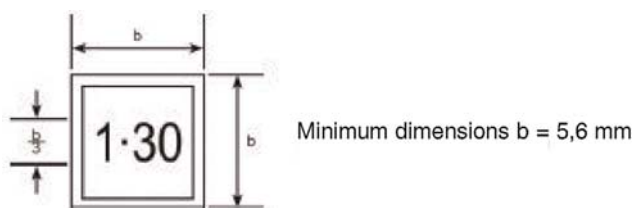

The above symbol shows that the corrected absorption coefficient is $1,30 m^{-1}$.

3. SPECIFICATIONS AND TESTS

3.1. The specifications and tests shall be those set out in Part III, section 24, of UN/ECE Regulation No 24 ⁽¹⁾, with the exception to these procedures set out in section 3.2.

3.2. The reference to Annex 2 in paragraph 24.1 of UN/ECE Regulation No 24 shall be understood as a reference to Appendix 4 to Annex I to this Regulation.

4. TECHNICAL REQUIREMENTS

4.1. The technical requirements shall be those set out in Annexes 4, 5, 7, 8, 9 and 10 to UN/ECE Regulation No 24, with the exceptions set out in sections 4.2., 4.3 and 4.4.

4.2. Test at steady engine speeds over the full load curve

4.2.1. The references to Annex 1 in paragraph 3.1. of Annex 4 of UN/ECE Regulation No 24 shall be understood as references to Appendix 3 to Annex I to this Regulation.

4.2.2. The reference fuel specified in paragraph 3.2 of Annex 4 of UN/ECE Regulation No 24 shall be understood as reference to the reference fuel in Annex IX to this Regulation appropriate to the emission limits against which the vehicle is being type approved.

⁽¹⁾ OJ L 326, 24.11.2006

▼B**4.3. Test under free acceleration**

4.3.1. The references to Table 2, Annex 2 in paragraph 2.2 of Annex 5 to UN/ECE Regulation No 24 shall be understood as references to the table under point 2.4.2.1 of Appendix 4 to Annex I to this Regulation.

4.3.2. The references to paragraph 7.3 of Annex 1 in paragraph 2.3 of Annex 5 to UN/ECE Regulation No 24 shall be understood as references to Appendix 3 to Annex I to this Regulation.

4.4. 'ECE' method of measuring the net power of C.I. engines

4.4.1. The references in paragraph 7 of Annex 10 to UN/ECE Regulation No 24 to the 'Appendix to this Annex' and in paragraphs 7 and 8 of Annex 10 to UN/ECE Regulation No 24 to 'Annex 1' shall be understood as references to Appendix 3 to Annex I to this Regulation.

▼B*ANNEX V***VERIFYING EMISSIONS OF CRANKCASE GASES
(TYPE 3 TEST)****1. INTRODUCTION**

1.1. This Annex describes the procedure for the type 3 test verifying emissions of crankcase gases as described in section 5.3.3. of UN/ECE Regulation No 83.

2. GENERAL REQUIREMENTS

2.1. The general requirements for conducting the type 3 test shall be those set out in sections 1 and 2 of Annex 6 to UN/ECE Regulation No 83, with the exceptions set out in points 2.2 and 2.3 below.

2.2. Reference to the Type I test in paragraph 2.1. of Annex 6 to UN/ECE Regulation No 83 shall be understood as referring to the Type 1 test in Annex XXI to this Regulation.

▼M3

2.3. The road load coefficients to be used shall be those for vehicle low (VL). If VL does not exist, then the VH road load shall be used. VL and VH are defined in point 4.2.1.1.2 of Sub-Annex 4 to Annex XXI. Alternatively, the manufacturer may choose to use road loads that have been determined in accordance with the provisions of Appendix 7 to Annex 4a of UN/ECE Regulation No 83 for a vehicle included in the interpolation family.

▼B**3. TECHNICAL REQUIREMENTS**

3.1. The technical requirements shall be those set out in section 3 to 6 of Annex 6 to UN/ECE Regulation No 83, with the exception set out in point 3.2 below.

3.2. References to the Type I test in paragraph 3.2. of Annex 6 to UN/ECE Regulation No 83 shall be understood as referring to the Type 1 test in Annex XXI to this Regulation.

▼ **M3***ANNEX VI***DETERMINATION OF EVAPORATIVE EMISSIONS**

(TYPE 4 TEST)

1. Introduction

This Annex provides the method to determine the levels of evaporative emission from light-duty vehicles in a repeatable and reproducible manner designed to be representative of real world vehicle operation.

2. Reserved**3. Definitions**

For the purposes of this Annex, the following definitions shall apply:

3.1. Test equipment

3.1.1. ‘*Accuracy*’ means the difference between a measured value and a reference value, traceable to a national standard and describes the correctness of a result.

3.1.2. ‘*Calibration*’ means the process of setting a measurement system’s response so that its output agrees with a range of reference signals.

3.2. Hybrid electric vehicles

3.2.1. ‘*Charge-depleting operating condition*’ means an operating condition in which the energy stored in the Rechargeable Electric Energy Storage System (REESS) may fluctuate but decreases on average while the vehicle is driven until transition to charge-sustaining operation.

3.2.2. ‘*Charge-sustaining operating condition*’ means an operating condition in which the energy stored in the REESS may fluctuate but, on average, is maintained at a neutral charging balance level while the vehicle is driven.

3.2.3. ‘*Not off-vehicle charging hybrid electric vehicle*’ (NOVC-HEV) means a hybrid electric vehicle that cannot be charged from an external source.

3.2.4. ‘*Off-vehicle charging hybrid electric vehicle*’ (OVC-HEV) means a hybrid electric vehicle that can be charged from an external source.

3.2.5. ‘*Hybrid electric vehicle*’ (HEV) means a hybrid vehicle where one of the propulsion energy converters is an electric machine.

3.2.6. ‘*Hybrid vehicle*’ (HV) means a vehicle equipped with a powertrain containing at least two different categories of propulsion energy converters and at least two different categories of propulsion energy storage systems.

▼ M3

- 3.3. Evaporative emission
- 3.3.1. ‘*Fuel tank system*’ means the devices which allow storing the fuel, comprising the fuel tank, the fuel filler, the filler cap and the fuel pump when it is fitted in or on the fuel tank.
- 3.3.2. ‘*Fuel system*’ means the components which store or transport fuel on board the vehicle and comprise the fuel tank system, all fuel and vapour lines, any non-tank mounted fuel pumps and the activated carbon canister.
- 3.3.3. ‘*Butane working capacity*’ (BWC) means the mass of butane which a canister can adsorb.
- 3.3.4. ‘*BWC300*’ means the butane working capacity after 300 cycles of fuel ageing cycles experienced.
- 3.3.5. ‘*Permeability Factor*’ (PF) means the factor determined from hydrocarbon losses over a period of time and used to determine the final evaporative emissions.
- 3.3.6. ‘*Monolayer non-metal tank*’ means a fuel tank constructed with a single layer of non-metal material including fluorinated/sulfonated materials.
- 3.3.7. ‘*Multilayer tank*’ means a fuel tank constructed with at least two different layered materials, one of which is a hydrocarbon barrier material.
- 3.3.8. ‘*Sealed fuel tank system*’ means a fuel tank system where the fuel vapours do not vent during parking over the 24-hour diurnal cycle defined in Appendix 2 to Annex 7 of UN/ECE Regulation No 83 when performed with a reference fuel defined in Section A.1 of Annex IX to this Regulation.
- 3.3.9. ‘*Evaporative emissions*’ means in the context of this Regulation the hydrocarbon vapours lost from the fuel system of a motor vehicle during parking and immediately before refuelling of a sealed fuel tank.
- 3.3.10. ‘*Mono-fuel gas vehicle*’ means a mono-fuel vehicle that runs primarily on liquefied petroleum gas, natural gas/biomethane, or hydrogen but may also have a petrol system for emergency purposes or starting only, where the petrol tank does not contain more than 15 litres of petrol.
- 3.3.11. ‘*Depressurisation puff loss*’ means hydrocarbons venting from a sealed fuel tank system pressure relief exclusively through the vapour storage unit allowed by the system.
- 3.3.12. ‘*Depressurisation puff loss overflow*’ are the depressurisation puff loss hydrocarbons that pass through the vapour storage unit during depressurisation.

▼ M3

- 3.3.13. ‘*Fuel tank relief pressure*’ is the minimum pressure value at which the sealed fuel tank system starts venting in response only to pressure inside the tank.
- 3.3.14. ‘*Auxiliary canister*’ is the canister used to measure depressurisation puff loss overflow.
- 3.3.15. ‘*2 gram breakthrough*’ shall be considered accomplished when the cumulative quantity of hydrocarbons emitted from the activated carbon canister equals 2 grams.

4. Abbreviations

General abbreviations

BWC	Butane working capacity
PF	Permeability factor
APF	Assigned permeability factor
OVC-HEV	Off-vehicle charging hybrid electric vehicle
NOVC-HEV	Not off-vehicle charging hybrid electric vehicle
WLTC	Worldwide light-duty test cycle
REESS	Rechargeable electric energy storage system

5. General requirements

- 5.1. The vehicle and its components liable to affect the evaporative emissions shall be designed, constructed and assembled so as to enable the vehicle in normal use and under normal conditions of use such as humidity, rain, snow, heat, cold, sand, dirt, vibrations, wear, etc. to comply with the provisions of this Regulation during its useful life.
- 5.1.1. This shall include the security of all hoses, joints and connections used within the evaporative emission control systems.
- 5.1.2. For vehicles with a sealed fuel tank system, this shall also include having a system which, just before refuelling, releases the tank pressure exclusively through a vapour storage unit which has the sole function of storing fuel vapour. This ventilation route shall also be the only one used when the tank pressure exceeds its safe working pressure.
- 5.2. The test vehicle shall be selected in accordance with paragraph 5.5.2.
- 5.3. Vehicle testing condition
- 5.3.1. The types and amounts of lubricants and coolant for emissions testing shall be as specified for normal vehicle operation by the manufacturer.
- 5.3.2. The type of fuel for testing shall be as specified in Section A.1 of Annex IX.

▼ **M3**

5.3.3. All evaporative emissions controlling systems shall be in working order.

5.3.4. The use of any defeat device is prohibited in accordance with the provisions of Article 5(2) of Regulation (EC) No 715/2007.

5.4. Provisions for electronic system security

5.4.1. The provisions for electronic system security shall be those specified in paragraph 2.3. of Annex I.

5.5. Evaporative emission family

5.5.1. Only vehicles that are identical with respect to the characteristics listed in (a), (c) and (d), technically equivalent with respect to the characteristics listed in (b) and similar or, where applicable, within the stated tolerance regarding the characteristics listed in (e) and (f) may be part of the same evaporative emission family:

(a) Fuel tank system material and construction;

(b) Vapour hose material, fuel line material and connection technique;

(c) Sealed tank or non-sealed tank system;

(d) Fuel tank relief valve setting (air ingestion and relief);

(e) Canister butane working capacity (BWC300) within a 10 per cent range of the highest value (for canisters with the same type of charcoal, the volume of charcoal shall be within 10 per cent of that for which the BWC300 was determined);

(f) Purge control system (for example, type of valve, purge control strategy).

5.5.2. The vehicle shall be considered to produce worst-case evaporative emissions and shall be used for testing if it has the largest ratio of fuel tank capacity to canister butane working capacity within the family. The vehicle selection shall be agreed in advance with the approval authority.

5.5.3. The use of any innovative system calibration, configuration, or hardware related to the evaporative control system shall place the vehicle model in a different family.

5.5.4. Evaporative Emissions Family Identifier

Each of the evaporative emission families defined in paragraph 5.5.1. shall be attributed a unique identifier of the following format:

EV-nnnnnnnnnnnnnnn-WMI-x

Where:

nnnnnnnnnnnnnnnn is a string with a maximum of fifteen characters, restricted to using the characters 0-9, A-Z and the underscore character ‘_’.

▼ M3

WMI (world manufacturer identifier) is a code that identifies the manufacturer in a unique manner defined in ISO 3780:2009.

x shall be set to '1' or '0' in accordance with the following provisions:

- (a) With the agreement of the approval authority and the owner of the WMI, the number shall be set to '1' where a vehicle family is defined for the purpose of covering vehicles of:
 - (i) a single manufacturer with one single WMI code;
 - (ii) a manufacturer with several WMI codes, but only in cases when one WMI code is to be used;
 - (iii) more than one manufacturer, but only in cases when one WMI code is to be used.

In the cases (i), (ii) and (iii), the family identifier code shall consist of one unique string of n-characters and one unique WMI code followed by '1'.

- (b) With the agreement of the approval authority, the number shall be set to '0' in the case that a vehicle family is defined based on the same criteria as the corresponding vehicle family defined in accordance with point (a), but the manufacturer chooses to use a different WMI. In this case the family identifier code shall consist of the same string of n-characters as the one determined for the vehicle family defined in accordance with point (a) and a unique WMI code which shall be different from any of the WMI codes used under case (a), followed by '0'.

- 5.6. The approval authority shall not grant type approval if the information provided is insufficient to demonstrate that the evaporative emissions are effectively limited during the normal use of the vehicle.

6. Performance requirements

6.1. Limit values

The limit value shall be that specified in Table 3 of Annex I to Regulation (EC) No 715/2007.

▼ M3*Appendix 1***Type 4 test procedures and test conditions****1. Introduction**

This Annex describes the procedure for the Type 4 test which determines the evaporative emission of vehicles.

2. Technical requirements

2.1. The procedure includes the evaporative emissions test and two additional tests, one for the ageing of carbon canisters, as described in paragraph 5.1. of this Appendix, and one for the permeability of the fuel tank system, as described in paragraph 5.2. of this Appendix. The evaporative emissions test (Figure VI.4) determines hydrocarbon evaporative emissions as a consequence of diurnal temperature fluctuations and hot soaks during parking.

2.2. In the case that the fuel system contains more than one carbon canister, all references to the term 'canister' in this Annex shall apply to each canister.

3. Vehicle

The vehicle shall be in good mechanical condition and have been run-in and driven at least 3 000 km before the test. For the purpose of the determination of evaporative emissions, the mileage and the age of the vehicle used for certification shall be included in all relevant test reports. The evaporative emission control system shall be connected and functioning correctly during the run-in period. A carbon canister aged in accordance with the procedure described in paragraph 5.1. of this Appendix shall be used.

4. Test equipment**4.1. Chassis dynamometer**

The chassis dynamometer shall meet the requirements of paragraph 2. of Sub-Annex 5 of Annex XXI.

4.2. Evaporative emission measurement enclosure

The evaporative emission measurement enclosure shall meet the requirements of paragraph 4.2. of Annex 7 of UN/ECE Regulation No 83.

4.3. Analytical systems

The analytical systems shall meet the requirements of paragraph 4.3. of Annex 7 of UN/ECE Regulation No 83. Continuous measuring of hydrocarbons is not mandatory unless the fixed volume type enclosure is used.

4.4. Temperature recording system

The temperature recording shall meet the requirements of paragraph 4.5. of Annex 7 of UN/ECE Regulation No 83.

▼ M3

4.5. Pressure recording system

The pressure recording shall meet the requirements of paragraph 4.6. of Annex 7 of UN/ECE Regulation No 83, except that the accuracy and resolution of the pressure recording system defined in paragraph 4.6.2. of Annex 7 of UN/ECE Regulation No 83 shall be:

(a) Accuracy: $\pm 0,3$ kPa

(b) Resolution: 0,025 kPa

4.6. Fans

The fans shall meet the requirements of paragraph 4.7. of Annex 7 of UN/ECE Regulation No 83, except that the capacity of the blowers shall be 0,1 to 0,5 m³/sec instead of 0,1 to 0,5 m³/min.

4.7. Calibration gases

The gases shall meet the requirements of paragraph 4.8. of Annex 7 of UN/ECE Regulation No 83.

4.8. Additional Equipment

The additional equipment shall meet the requirements of paragraph 4.9. of Annex 7 of UN/ECE Regulation No 83.

4.9. Auxiliary canister

The auxiliary canister should be identical to the main canister but not necessarily aged. The connection tube to the vehicle canister shall be as short as possible. The auxiliary canister shall be fully-purged with dry air prior to loading.

4.10. Canister weighing scale

The canister weighing scale shall have an accuracy of $\pm 0,02$ g.

5. Procedure for canister bench ageing and PF determination

5.1. Canister bench ageing

Before performing the hot soak and diurnal losses sequences, the canister shall be aged in accordance with the procedure described in Figure VI.1.

▼ M3

Figure VI.1

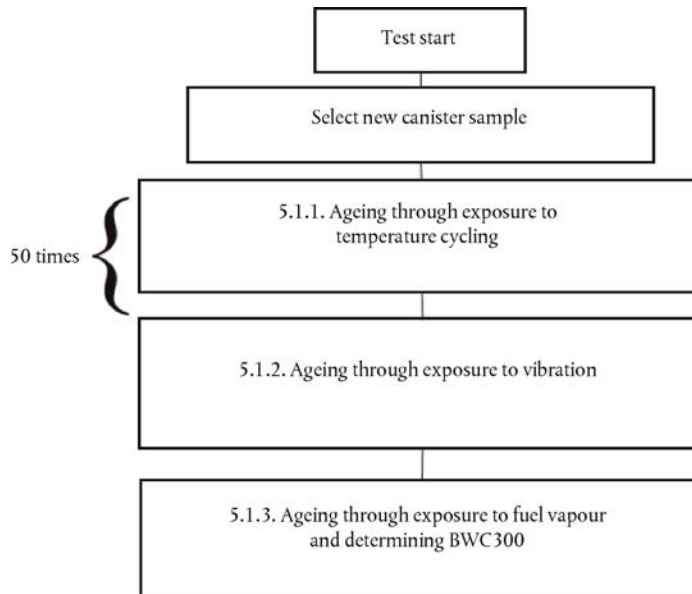
Canister bench ageing procedure

5.1.1. Ageing through exposure to temperature cycling

The canister shall be cycled between temperatures from -15 °C to 60 °C in a dedicated temperature enclosure with 30 minutes of stabilisation at -15 °C and 60 °C . Each cycle shall last 210 minutes (see Figure VI.2).

The temperature gradient shall be as close as possible to 1 °C/min . No forced air flow should pass through the canister.

The cycle shall be repeated 50 times consecutively. In total, this procedure lasts 175 hours.

Figure VI.2

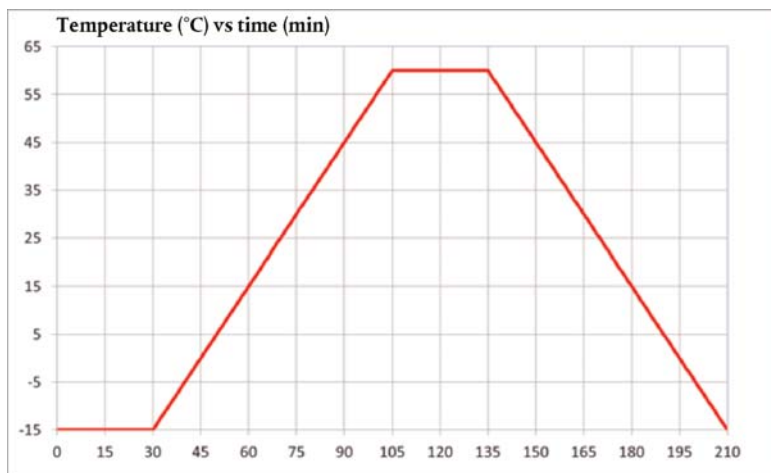
Temperature conditioning cycle

▼ M3

5.1.2. Ageing through exposure to vibration
Following the temperature ageing procedure, the canister shall be shaken vertically with the canister mounted as per its orientation in the vehicle with an overall Grms $> 1,5 \text{ m/sec}^2$ with a frequency of $30 \pm 10 \text{ Hz}$. The test shall last 12 hours.

5.1.3. Ageing through exposure to fuel vapour and determining BWC300

5.1.3.1. Ageing shall consist of repeatedly loading with fuel vapour and purging with laboratory air.

5.1.3.1.1. After temperature and vibration ageing, the canister shall be further aged with a mixture of market fuel as specified in paragraph 5.1.3.1.1.1. of this Appendix and nitrogen or air with a 50 ± 15 per cent fuel vapour volume. The fuel vapour fill rate shall be $60 \pm 20 \text{ g/h}$.

The canister shall be loaded to 2 gram breakthrough. As an alternative, loading shall be deemed to be completed when the hydrocarbon concentration level at the vent outlet reaches 3 000 ppm.

5.1.3.1.1.1. The market fuel used for this test shall fulfil the same requirements as a reference fuel with respect to:

- (a) Density at $15 \text{ }^\circ\text{C}$;
- (b) Vapour pressure;
- (c) Distillation ($70 \text{ }^\circ\text{C}$, $100 \text{ }^\circ\text{C}$, $150 \text{ }^\circ\text{C}$);
- (d) Hydrocarbon analysis (olefins, aromatics, benzene only);
- (e) Oxygen content;
- (f) Ethanol content.

5.1.3.1.2. The canister shall be purged between 5 and 60 minutes after loading with 25 ± 5 litres per minute of emission laboratory air until 300 bed volume exchanges are reached.

5.1.3.1.3. The procedures set out in paragraphs 5.1.3.1.1. and 5.1.3.1.2. of this Appendix shall be repeated 300 times after which the canister shall be considered to be stabilised.

5.1.3.1.4. The procedure to measure the butane working capacity (BWC) with respect to the evaporative emission family in paragraph 5.5. shall consist of the following.

- (a) The stabilised canister shall be loaded to 2 gram breakthrough and subsequently purged a minimum of 5 times. Loading shall be performed with a mixture composed of 50 per cent butane and 50 per cent nitrogen by volume at a rate of 40 grams butane per hour.
- (b) Purging shall be performed in accordance with paragraph 5.1.3.1.2. of this Appendix.
- (c) The BWC shall be included in all relevant test reports after each loading.

▼ **M3**

(d) BWC300 shall be calculated as the average of the last 5 BWCs.

5.1.3.2. If an aged canister is provided by a supplier, the manufacturer shall inform the approval authority in advance of the ageing process to enable the witnessing of any part of that process in the supplier's facilities.

5.1.3.3. The manufacturer shall provide the approval authority a test report including at least the following elements:

(a) Type of activated carbon;

(b) Loading rate;

(c) Fuel specifications.

5.2. Determination of the PF of the fuel tank system (see Figure VI.3)

Figure VI.3

Determination of the PF

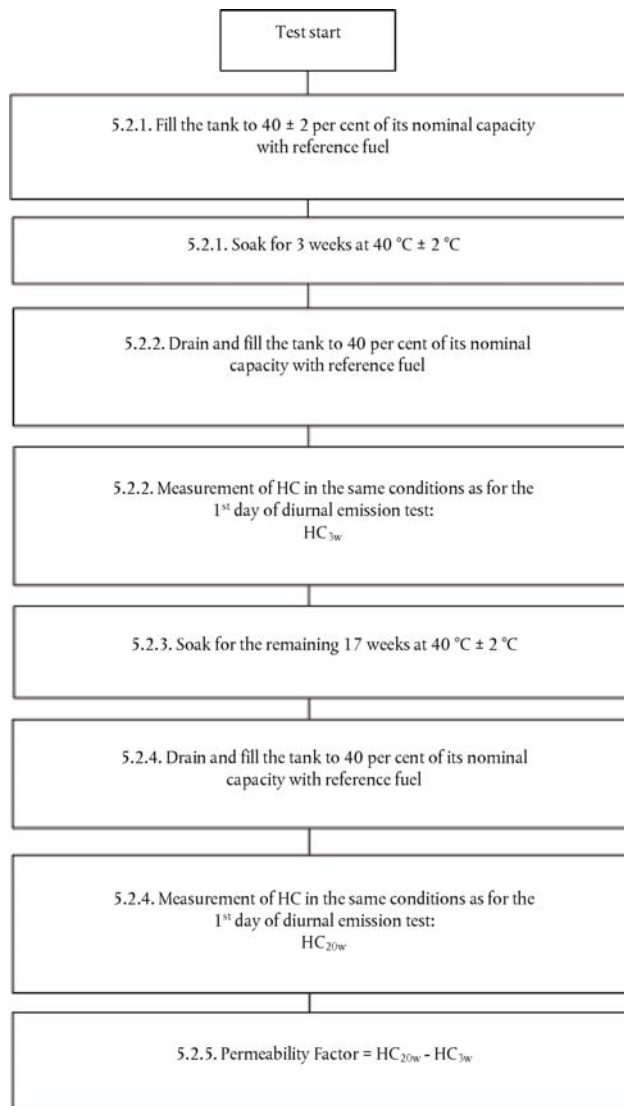

▼ M3

5.2.1. The fuel tank system representative of a family shall be selected and mounted on a rig in a similar orientation as in the vehicle. The tank shall be filled to 40 ± 2 per cent of its nominal capacity with reference fuel at a temperature of $18 \text{ °C} \pm 2 \text{ °C}$. The rig with the fuel tank system shall be placed in a room with a controlled temperature of $40 \text{ °C} \pm 2 \text{ °C}$ for 3 weeks.

5.2.2. At the end of the third week, the tank shall be drained and refilled with reference fuel at a temperature of $18 \text{ °C} \pm 2 \text{ °C}$ to 40 ± 2 per cent of its nominal tank capacity.

Within 6 to 36 hours, the rig with the fuel tank system shall be placed in an enclosure. The last 6 hours of this period shall be at an ambient temperature of $20 \text{ °C} \pm 2 \text{ °C}$. In the enclosure, a diurnal procedure shall be performed over the first 24-hour period of the procedure described in paragraph 6.5.9. of this Appendix. The fuel vapour in the tank shall be vented to the outside of the enclosure to eliminate the possibility of the tank venting emissions being counted as permeation. The HC emissions shall be measured and the value shall be included in all relevant test reports as $\text{HC}_{3\text{w}}$.

5.2.3. The rig with the fuel tank system shall be placed again in a room with a controlled temperature of $40 \text{ °C} \pm 2 \text{ °C}$ for the remaining 17 weeks.

5.2.4. At the end of the seventeenth week, the tank shall be drained and refilled with reference fuel at a temperature of $18 \text{ °C} \pm 2 \text{ °C}$ to 40 ± 2 per cent of its nominal tank capacity.

Within 6 to 36 hours, the rig with the fuel tank system shall be placed in an enclosure. The last 6 hours of this period shall be at an ambient temperature of $20 \text{ °C} \pm 2 \text{ °C}$. In the enclosure, a diurnal procedure shall be performed over a first period of 24 hours of the procedure described in accordance with paragraph 6.5.9. of this Appendix. The fuel tank system shall be vented to the outside of the enclosure to eliminate the possibility of the tank venting emissions being counted as permeation. The HC emissions shall be measured and the value shall be included in all relevant test reports in this case as $\text{HC}_{20\text{w}}$.

5.2.5. The PF is the difference between $\text{HC}_{20\text{w}}$ and $\text{HC}_{3\text{w}}$ in g/24h calculated to 3 significant digits using the following equation:

$$\text{PF} = \text{HC}_{20\text{w}} - \text{HC}_{3\text{w}}$$

5.2.6. If the PF is determined by a supplier, the vehicle manufacturer shall inform the approval authority in advance of the determination to allow witness check in the supplier's facility.

5.2.7. The manufacturer shall provide the approval authority with a test report containing at least the following:

- (a) A full description of the fuel tank system tested, including information on the type of tank tested, whether the tank is metal, monolayer non-metal or multilayer, and which types of materials are used for the tank and other parts of the fuel tank system;

▼ M3

- (b) The weekly mean temperatures at which the ageing was performed;
- (c) The HC measured at week 3 (HC_{3w});
- (d) The HC measured at week 20 (HC_{20w});
- (e) The resulting permeability factor (PF).

5.2.8. As an alternative to paragraphs 5.2.1. to 5.2.7. of this Appendix, a manufacturer using multilayer tanks or metal tanks may choose to use an Assigned Permeability Factor (APF) instead of performing the complete measurement procedure mentioned above:

$$\text{APF multilayer/metal tank} = 120 \text{ mg /24 h}$$

Where the manufacturer chooses to use an APF, the manufacturer shall provide the approval authority with a declaration in which the type of tank is clearly specified as well as a declaration of the type of materials used.

6. **Test procedure for the measurement of hot soak and diurnal losses**

6.1. Vehicle preparation

The vehicle shall be prepared in accordance to paragraphs 5.1.1. and 5.1.2. of Annex 7 of UN/ECE Regulation No 83. At the request of the manufacturer and with approval of the approval authority, non-fuel background emission sources (e.g. paint, adhesives, plastics, fuel/vapour lines, tyres, and other rubber or polymer components) may be reduced to typical vehicle background levels before testing (e.g. baking of tyres at temperatures of 50 °C or higher for appropriate periods, baking of the vehicle, draining washer fluid).

For a sealed fuel tank system, the vehicle canisters shall be installed so that access to canisters and connection/disconnection of canisters can be done easily.

6.2. Mode selections and gear shift prescriptions

6.2.1. For vehicles with manual shift transmissions, the gear shift prescriptions specified in Sub-Annex 2 of Annex XXI shall apply.

6.2.2. In the case of pure ICE vehicles, the mode shall be selected in accordance with Sub-Annex 6 of Annex XXI.

6.2.3. In the case of NOVC-HEVs and OVC-HEVs, the mode shall be selected in accordance with Appendix 6 to Sub-Annex 8 of Annex XXI.

6.2.4. Upon request of the approval authority, the selected mode may be different from that described in paragraphs 6.2.2. and 6.2.3. of this Appendix.

▼ M3

6.3. Test conditions

The tests included in this Annex shall be performed using the test conditions specific to interpolation family vehicle H with the highest cycle energy demand of all the interpolation families included in the evaporative emission family being considered.

Alternatively, at the request of the approval authority, any cycle energy representative of a vehicle in the family may be used for the test.

6.4. Flow of the test procedure

The test procedure for non-sealed and sealed tank systems shall be followed in accordance with the flow chart described in Figure VI.4.

The sealed fuel tank systems shall be tested with one of 2 options. One option is to test the vehicle with one continuous procedure. Another option, called the stand-alone procedure, is to test the vehicle with two separate procedures which will allow repeating the dynamometer test and the diurnal tests without repeating the tank depressurisation puff loss overflow test and the depressurisation puff loss measurement.

▼ M3

Figure VI.4
Test procedure flow charts

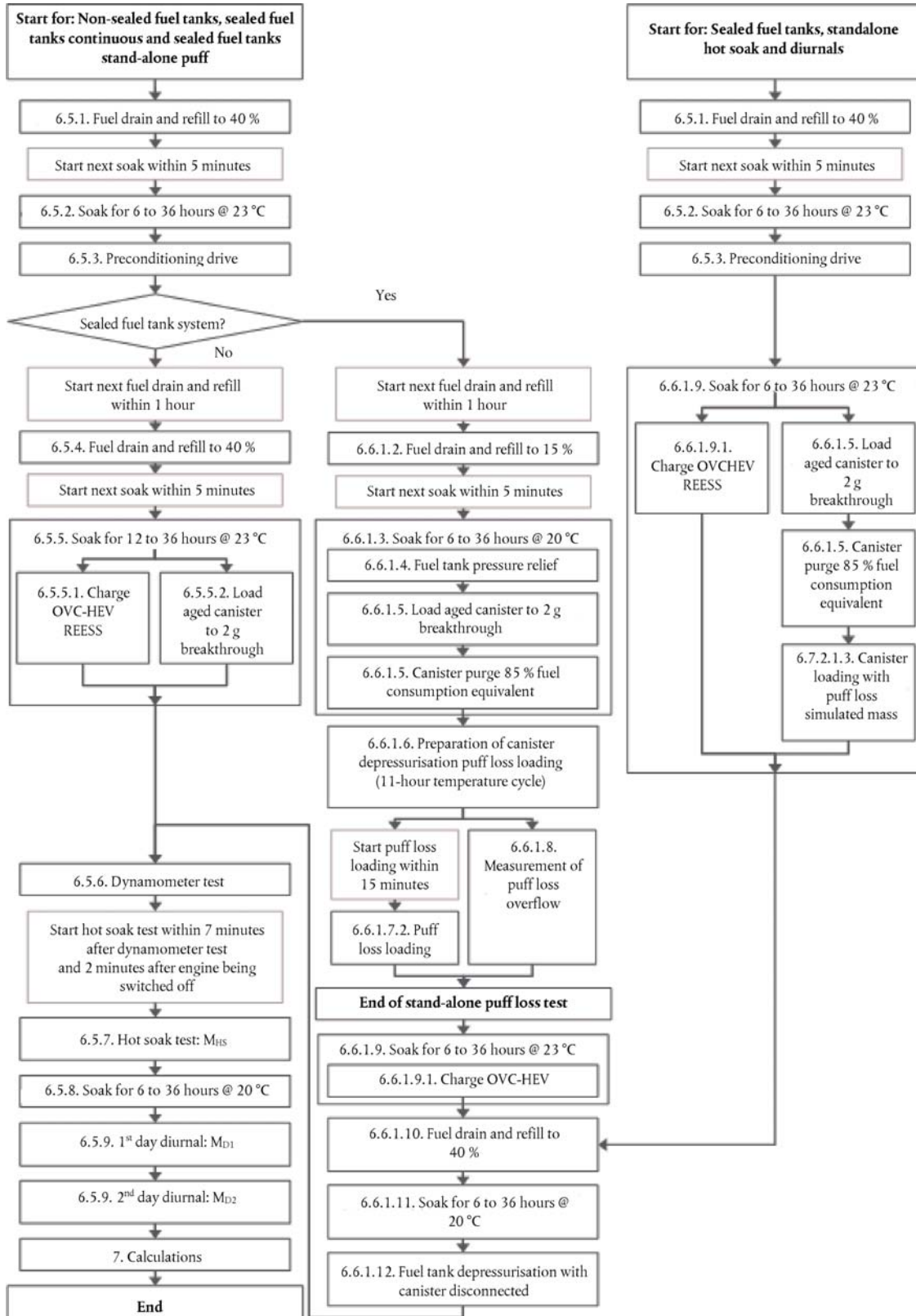

▼ M3

6.5. Continuous test procedure for non-sealed fuel tank systems

6.5.1. Fuel drain and refill

The fuel tank of the vehicle shall be emptied. This shall be done so as not to abnormally purge or abnormally load the evaporative control devices fitted to the vehicle. Removal of the fuel cap is normally sufficient to achieve this. The fuel tank shall be refilled with reference fuel at a temperature of $18\text{ °C} \pm 2\text{ °C}$ to 40 ± 2 per cent of its nominal capacity.

6.5.2. Soak

Within 5 minutes after completing fuel drain and refill, the vehicle shall be soaked for a minimum of 6 hours and a maximum of 36 hours at $23\text{ °C} \pm 3\text{ °C}$.

6.5.3. Preconditioning drive

The vehicle shall be placed on a chassis dynamometer and driven over the following phases of the cycle described in Sub-Annex 1 of Annex XXI:

(a) For Class 1 vehicles: low, medium, low, low, medium, low

(b) For Class 2 and 3 vehicles: low, medium, high, medium.

For OVC-HEVs, the preconditioning drive shall be performed under the charge-sustaining operating condition as defined in paragraph 3.3.6. of Annex XXI. Upon the request of approval authority, any other mode may be used.

6.5.4. Fuel drain and refill

Within one hour after the preconditioning drive, the fuel tank of the vehicle shall be emptied. This shall be done so as not to abnormally purge or abnormally load the evaporative control devices fitted to the vehicle. Removal of the fuel cap is normally sufficient to achieve this. The fuel tank shall be refilled with test fuel at a temperature of $18\text{ °C} \pm 2\text{ °C}$ to 40 ± 2 per cent of its nominal capacity.

6.5.5. Soak

Within five minutes of completing fuel drain and refill, the vehicle shall be parked for a minimum of 12 hours and a maximum of 36 hours at $23\text{ °C} \pm 3\text{ °C}$.

During soaking, the procedures described in paragraphs 6.5.5.1. and 6.5.5.2. may be performed either in the order of first paragraph 6.5.5.1. followed by paragraph 6.5.5.2. or in the order paragraph 6.5.5.2. followed by paragraph 6.5.5.1. The procedures described in paragraphs 6.5.5.1. and 6.5.5.2. may also be performed simultaneously.

6.5.5.1. REESS charge

For OVC-HEVs, the REESS shall be fully charged in accordance with the charging requirements described in paragraph 2.2.3. of Appendix 4 to Sub-Annex 8 of Annex XXI.

▼ M3

6.5.5.2. Canister loading

The canister aged in accordance with the sequence described in paragraph 5.1. of this Appendix shall be loaded to 2 gram breakthrough in accordance with the procedure described in paragraph 5.1.4. of Annex 7 of UN/ECE Regulation No 83.

6.5.6. Dynamometer test

The test vehicle shall be pushed onto a dynamometer and shall be driven over the cycles described in paragraph 6.5.3.(a) or paragraph 6.5.3.(b) of this Appendix. OVC-HEVs shall be operated in charge-depleting operating condition. The engine shall be subsequently shut off. Exhaust emissions may be sampled during this operation and the results may be used for the purpose of exhaust emission and fuel consumption type approval if this operation meets the requirement described in Sub-Annex 6 or Sub-Annex 8 of Annex XXI.

6.5.7. Hot soak evaporative emissions test

Within 7 minutes after the dynamometer test and within 2 minutes of the engine being switched off, the hot soak evaporative emissions test shall be performed in accordance with paragraph 5.5. of Annex 7 of UN/ECE Regulation No 83. The hot soak losses shall be calculated in accordance with paragraph 7.1. of this Appendix and included in all relevant test reports as M_{HS} .

6.5.8. Soak

After the hot soak evaporative emissions test, the test vehicle shall be soaked for not less than 6 hours and not more than 36 hours between the end of the hot soak test and the start of the diurnal emission test. For at least the last 6 hours of this period the vehicle shall be soaked at $20\text{ °C} \pm 2\text{ °C}$.

6.5.9. Diurnal testing

6.5.9.1. The test vehicle shall be exposed to two cycles of ambient temperature pursuant to the profile specified for the diurnal emission test in Appendix 2 to Annex 7 of UN/ECE Regulation No 83 with a maximum deviation of $\pm 2\text{ °C}$ at any time. The average temperature deviation from the profile, calculated using the absolute value of each measured deviation, shall not exceed $\pm 1\text{ °C}$. Ambient temperature shall be measured at least every minute and included in all relevant test sheets. Temperature cycling shall begin at time $T_{\text{start}} = 0$, as specified in paragraph 6.5.9.6. of this Appendix.

6.5.9.2. The enclosure shall be purged for several minutes immediately before the test until a stable background is obtained. The chamber mixing fan(s) shall also be switched on at this time.

6.5.9.3. The test vehicle, with the powertrain shut off and the test vehicle windows and luggage compartment(s) opened, shall be moved into the measuring chamber. The mixing fan(s) shall be adjusted in such a way as to maintain a minimum air circulation speed of 8 km/h under the fuel tank of the test vehicle.

▼ **M3**

- 6.5.9.4. The hydrocarbon analyser shall be zeroed and spanned immediately before the test.
- 6.5.9.5. The enclosure doors shall be closed and sealed gas-tight.
- 6.5.9.6. Within 10 minutes of closing and sealing the doors, the hydrocarbon concentration, temperature and barometric pressure shall be measured to give initial readings of hydrocarbon concentration in the enclosure C_{HCi} , barometric pressure P_i and ambient chamber temperature T_i for the diurnal testing. $T_{\text{start}} = 0$ starts at this time.
- 6.5.9.7. The hydrocarbon analyser shall be zeroed and spanned immediately before the end of each emission sampling period.
- 6.5.9.8. The end of the first and second emission sampling period shall occur at 24 hours ± 6 minutes and 48 hours ± 6 minutes, respectively, after the beginning of the initial sampling, as specified in paragraph 6.5.9.6. of this Appendix. The elapsed time shall be included in all relevant test reports.

At the end of each emission sampling period, the hydrocarbon concentration, temperature and barometric pressure shall be measured and used to calculate the diurnal test results using the equation in paragraph 7.1. of this Appendix. The result obtained from the first 24 hours shall be included in all relevant test reports as M_{D1} . The result obtained from the second 24 hours shall be included in all relevant test reports as M_{D2} .

- 6.6. Continuous test procedure for sealed fuel tank systems
- 6.6.1. In the case that the fuel tank relief pressure is greater than or equal to 30 kPa.
- 6.6.1.1. The test shall be performed as described in paragraphs 6.5.1. to 6.5.3. of this Appendix.
- 6.6.1.2. Fuel drain and refill
 Within one hour after the preconditioning drive, the fuel tank of the vehicle shall be emptied. This shall be done so as not to abnormally purge or abnormally load the evaporative control devices fitted to the vehicle. Removal of the fuel cap is normally sufficient to achieve this, otherwise the canister shall be disconnected. The fuel tank shall be refilled with reference fuel at a temperature of $18\text{ °C} \pm 2\text{ °C}$ to 15 ± 2 per cent of the tank's nominal capacity.
- 6.6.1.3. Soak
 Within 5 minutes after completing fuel drain and refill, the vehicle shall be soaked for stabilization for 6 to 36 hours at an ambient temperature of $20\text{ °C} \pm 2\text{ °C}$.
- 6.6.1.4. Fuel tank depressurisation
 The tank pressure shall be subsequently released so as not to abnormally raise the inside pressure of the fuel tank. This may be done by opening the fuel cap of the vehicle. Regardless of the method of depressurisation, the vehicle shall be returned to its original condition within 1 minute.

▼ **M3**

6.6.1.5. Canister loading and purge

The canister aged in accordance with the sequence described in paragraph 5.1. of this Appendix shall be loaded to 2 gram breakthrough in accordance with the procedure described in paragraph 5.1.6. of Annex 7 of UN/ECE Regulation No 83, and shall be subsequently purged with 25 ± 5 litres per minute with emission laboratory air. The volume of purge air shall not exceed the volume determined in paragraph 6.6.1.5.1. This loading and purging can be done either (a) using an on-board canister at a temperature of 20 °C or optionally 23 °C, or (b) by disconnecting the canister. In both cases, no further relief of the tank pressure is allowed.

6.6.1.5.1. Determination of maximum purge volume

The maximum purge amount Vol_{max} shall be determined by the following equation. In the case of OVC-HEVs, the vehicle shall be operated in charge-sustaining operating condition. This determination can also be done at a separate test or during the preconditioning drive.

$$Vol_{max} = Vol_{Pcycle} \times \frac{Vol_{tank} \times 0,85 \times \frac{100}{FC_{Pcycle}}}{Dist_{Pcycle}}$$

where:

Vol_{Pcycle} is the cumulative purge volume rounded to the nearest 0,1 litres measured using a suitable device (e.g. flowmeter connected to the vent of the carbon canister or equivalent) over the cold start preconditioning drive described in the paragraph 6.5.3. of this Appendix, l;

Vol_{tank} is the manufacturer's nominal fuel tank capacity, l;

FC_{Pcycle} is the fuel consumption over the single purge cycle described in paragraph 6.5.3. of this Appendix which may be measured in either warm or cold start condition, l/100 km. For OVC-HEVs and NOVC-HEVs, fuel consumption shall be calculated in accordance with paragraph 4.2.1. of Sub-Annex 8 of Annex XXI;

$Dist_{Pcycle}$ is the theoretical distance to the nearest 0,1 km of a single purge cycle described in paragraph 6.5.3. of this Appendix, km.

6.6.1.6. Preparation of canister depressurisation puff loss loading

After completing canister loading and purging, the test vehicle shall be moved into an enclosure, either a SHED or an appropriate climatic chamber. It shall be demonstrated that the system is leak-free and the pressurisation is performed in a normal way during the test or by separate test (e.g. by means of pressure sensor on the vehicle). The test vehicle shall be subsequently exposed to the first 11 hours of the ambient temperature profile specified for the diurnal emission test in

▼ **M3**

Appendix 2 to Annex 7 of UN/ECE Regulation No 83 with a maximum deviation of ± 2 °C at any time. The average temperature deviation from the profile, calculated using the absolute value of each measured deviation, shall not exceed ± 1 °C. The ambient temperature shall be measured at least every 10 minutes and included in all relevant test sheets.

6.6.1.7. Canister puff loss loading

6.6.1.7.1. Fuel tank depressurisation before refuelling

The manufacturer shall ensure that the refuelling operation cannot be initiated before the sealed fuel tank system is fully depressurised to a pressure less than 2,5 kPa above ambient pressure in normal vehicle operation and use. At the request of the approval authority, the manufacturer shall provide detailed information or demonstrate proof of operation (e.g. by means of pressure sensor on the vehicle). Any other technical solution may be allowed provided that a safe refuelling operation is ensured and that no excessive emissions are released to the atmosphere before the refuelling device is connected to the vehicle.

6.6.1.7.2. Within 15 minutes after the ambient temperature has reached 35 °C, the tank relief valve shall be opened to load the canister. This loading procedure may be executed either inside or outside an enclosure. The canister loaded in accordance with this paragraph shall be disconnected and shall be kept in the soak area. A dummy canister shall be installed to the vehicle when undertaking the procedure specified in paragraphs 6.6.1.9. to 6.6.1.12. of this Appendix.

6.6.1.8. Measurement of depressurisation puff loss overflow

6.6.1.8.1. Any depressurisation puff loss overflow from the vehicle canister shall be measured by using an auxiliary carbon canister connected directly at the outlet of the vehicle vapour storage unit. It shall be weighed before and after the procedure described in paragraph 6.6.1.7. of this Appendix.

6.6.1.8.2. Alternatively, the depressurisation puff loss overflow from the vehicle canister during its depressurisation may be measured using a SHED.

Within 15 minutes after the ambient temperature has reached 35 °C as described in paragraph 6.6.1.6. of this Appendix, the chamber shall be sealed and the measurement procedure shall be started.

The hydrocarbon analyser shall be zeroed and spanned, after which the hydrocarbon concentration, temperature and barometric pressure shall be measured to give the initial readings C_{HCi} , P_i and T_i for the sealed tank depressurisation puff loss overflow determination.

The ambient temperature T of the enclosure shall not be less than 25 °C during the measurement procedure.

▼ M3

At the end of the procedure described in paragraph 6.6.1.7.2. of this Appendix, the hydrocarbon concentration in the chamber shall be measured after 60 ± 5 seconds. The temperature and the barometric pressure shall also be measured. These are the final readings C_{HCf} , P_f and T_f for the sealed tank depressurisation puff loss overflow.

The sealed tank puff loss overflow result shall be calculated in accordance with paragraph 7.1. of this Appendix and included in all relevant test reports.

6.6.1.8.3. There shall be no change in weight of the auxiliary canister or the result of the SHED measurement, within the tolerance of $\pm 0,5$ gram.

6.6.1.9. Soak

After completing puff loss loading, the vehicle shall be soaked at 23 ± 2 °C for 6 to 36 hours to stabilise the vehicle temperature.

6.6.1.9.1. REESS charge

For OVC-HEVs, the REESS shall be fully charged in accordance with the charging requirements described in paragraph 2.2.3. of Appendix 4 to Annex 8 of Annex XXI during the soaking described in paragraph 6.6.1.9. of this Appendix.

6.6.1.10. Fuel drain and refill

The fuel tank of the vehicle shall be drained and filled up to 40 ± 2 per cent of the tank's nominal capacity with reference fuel at a temperature of 18 °C ± 2 °C.

6.6.1.11. Soak

The vehicle shall be subsequently parked for a minimum of 6 hours to a maximum of 36 hours in the soak area at 20 °C ± 2 °C to stabilise the fuel temperature.

6.6.1.12. Fuel tank depressurisation

The tank pressure shall be subsequently released so as not to abnormally raise the inside pressure of the fuel tank. This may be done by opening the fuel cap of the vehicle. Regardless of the method of depressurisation, the vehicle shall be returned to its original condition within 1 minute. After this action, the vapour storage unit shall be connected again.

6.6.1.13. The procedures in paragraphs 6.5.6. to 6.5.9.8. of this Appendix shall be followed.

6.6.2. In the case that the fuel tank relief pressure is lower than 30 kPa

The test shall be performed as described in paragraphs 6.6.1.1. to 6.6.1.13. of this Appendix. However, in this case, the ambient temperature described in paragraph 6.5.9.1. of this Appendix shall be replaced by the profile specified in Table VI.1 of this Appendix for the diurnal emission test.

▼ **M3***Table VI.1***Ambient temperature profile of the alternative sequence for sealed fuel tank system**

Time (hours)	Temperature (°C)
0/24	20,0
1	20,4
2	20,8
3	21,7
4	23,9
5	26,1
6	28,5
7	31,4
8	33,8
9	35,6
10	37,1
11	38,0
12	37,7
13	36,4
14	34,2
15	31,9
16	29,9
17	28,2
18	26,2
19	24,7
20	23,5
21	22,3
22	21,0
23	20,2

- 6.7. Stand-alone test procedure for sealed fuel tank systems
- 6.7.1 Measurement of depressurisation puff loss loading mass
- 6.7.1.1. The procedures in paragraphs 6.6.1.1. to 6.6.1.7.2. of this Appendix shall be performed. The depressurisation puff loss loading mass is defined as the difference in weight of the vehicle canister before paragraph 6.6.1.6. of this Appendix is applied and after paragraph 6.6.1.7.2. of this Appendix is applied.
- 6.7.1.2. The depressurisation puff loss overflow from the vehicle canister shall be measured in accordance with paragraphs 6.6.1.8.1. and 6.6.1.8.2. of this Appendix and fulfil the requirements of paragraph 6.6.1.8.3. in this Appendix.

▼ M3

- 6.7.2. Hot soak and diurnal breathing evaporative emissions test
- 6.7.2.1. In the case that the fuel tank relief pressure is greater than or equal to 30 kPa
- 6.7.2.1.1. The test shall be performed as described in paragraphs 6.5.1. to 6.5.3. and paragraphs 6.6.1.9. to 6.6.1.9.1. of this Appendix.
- 6.7.2.1.2. The canister shall be aged in accordance with the sequence described in paragraph 5.1. of this Appendix and shall be loaded and purged in accordance with paragraph 6.6.1.5. of this Appendix.
- 6.7.2.1.3. The aged canister shall subsequently be loaded in accordance with the procedure described in paragraph 5.1.6. of Annex 7 of UN/ECE Regulation No 83 with the exemption of loading mass. Total loading mass shall be determined in accordance with paragraph 6.7.1.1. of this Appendix. At the request of the manufacturer, the reference fuel may alternatively be used instead of butane. The canister shall be disconnected.
- 6.7.2.1.4. The procedures in paragraphs 6.6.1.10. to 6.6.1.13. of this Appendix shall be followed.
- 6.7.2.2. In the case that the fuel tank relief pressure is lower than 30 kPa
The test shall be performed as described in paragraphs 6.7.2.1.1. to 6.7.2.1.4. of this Appendix. However, in this case, the ambient temperature described in 6.5.9.1. of this Appendix shall be modified pursuant to the profile specified in Table VI.1 of this Appendix for the diurnal emission test.

7. Calculation of evaporative test results

- 7.1. The evaporative emission tests described in this Annex allow the hydrocarbon emissions from the puff loss overflow, diurnal and hot soak tests to be calculated. Evaporative losses from each of these tests shall be calculated using the initial and final hydrocarbon concentrations, temperatures and pressures in the enclosure, together with the net enclosure volume.

The following equation shall be used:

$$M_{\text{HC}} = k \times V \times \left(\frac{C_{\text{HCf}} \times P_{\text{f}}}{T_{\text{f}}} - \frac{C_{\text{HCi}} \times P_{\text{i}}}{T_{\text{i}}} \right) + M_{\text{HC,out}} - M_{\text{HC,in}}$$

where:

M_{HC} is the mass of hydrocarbons, grams;

$M_{\text{HC,out}}$ is the mass of hydrocarbons exiting the enclosure in the case of fixed volume enclosures for diurnal emission testing, grams;

$M_{\text{HC,in}}$ is the mass of hydrocarbon entering the enclosure in the case of fixed volume enclosures for diurnal emission testing, grams;

▼ **M3**

C_{HC}	is the measured hydrocarbon concentration in the enclosure, ppm volume in C_1 equivalent;
V	is the net enclosure volume corrected for the volume of the vehicle with the windows and the luggage compartment open, m^3 . If the volume of the vehicle is not known, a volume of $1,42 m^3$ shall be subtracted;
T	is the ambient chamber temperature, K;
P	is the barometric pressure, kPa;
H/C	is the hydrogen to carbon ratio

where:

H/C is taken to be 2,33 for puff loss overflow measurement in SHED and diurnal test losses;

H/C is taken to be 2,20 for hot soak losses;

k is $1,2 \times 10^{-4} \times (12 + H/C)$, in $(g \times K/(m^3 \times kPa))$;

i is the initial reading;

f is the final reading;

7.2. The result of $(M_{HS} + M_{D1} + M_{D2} + (2 \times PF))$ shall be below the limit defined in paragraph 6.1.

8. **Test report**

The test report shall contain at least the following:

- (a) Description of the soak periods, including time and mean temperatures;
- (b) Description of aged canister used and reference to exact ageing report;
- (c) Mean temperature during the hot soak test;
- (d) Measurement during hot soak test, HSL;
- (e) Measurement of first diurnal, DL1st day;
- (f) Measurement of second diurnal, DL2nd day;
- (g) Final evaporative test result, calculated in accordance with paragraph 7. of this Appendix;
- (h) Declared fuel tank relief pressure of the system (for sealed tank systems);
- (i) Puff loss loading value (in the case of using the stand-alone test described in paragraph 6.7. of this Appendix).



ANNEX VII

**VERIFYING THE DURABILITY OF POLLUTION CONTROL DEVICES
(TYPE 5 TEST)**

1. INTRODUCTION

1.1. This Annex describes the tests for verifying the durability of pollution control devices.

2. GENERAL REQUIREMENTS

2.1. The general requirements for conducting the type 5 test shall be those set out in Section 5.3.6. of UN/ECE Regulation No 83 with exceptions provided in sections 2.2. and 2.3 below.

2.2. The table in paragraph 5.3.6.2. and the text in paragraph 5.3.6.4. of UN/ECE Regulation No 83 shall be understood to be as follows:

Engine Category	Assigned deterioration factors						
	CO	THC	NMHC	NO _x	HC + NO _x	PM	►M3 PN◀
Positive-ignition	1,5	1,3	1,3	1,6	—	1,0	1,0
Compression-ignition	As there are no assigned deterioration factors for compression ignition vehicles, manufacturers shall use the whole vehicle or bench ageing durability test procedures to establish deterioration factors.						

2.3. The reference to the requirements of paragraphs 5.3.1 and 8.2 in paragraph 5.3.6.5 of UN/ECE Regulation No 83 shall be understood as reference to the requirements of Annex XXI and Section 4.2 of Annex I to this Regulation during the useful life of the vehicle.

2.4. Before emission limits set out in Table 2 of Annex I to Regulation (EC) No 715/2007 are used for assessing compliance with the requirements referred to in paragraph 5.3.6.5 of UN/ECE Regulation No 83 the deterioration factors shall be calculated and applied, as described in Table A7/1 of Sub-Annex 7 and Table A8/5 of Sub-Annex 8 to Annex XXI.

3. TECHNICAL REQUIREMENTS

3.1. The technical requirements and specifications shall be those set out in sections 1 to 7 and Appendices 1, 2 and 3 of Annex 9 to UN/ECE Regulation No 83, with the exceptions set out in sections 3.2. to 3.10.

3.2. Reference to Annex 2 in paragraph 1.5. of Annex 9 to UN/ECE Regulation No 83 shall be understood as referring to Appendix 4 to Annex I to this Regulation.

3.3. Reference to the emissions limits set out in Table 1 in paragraph 1.6. of Annex 9 to UN/ECE Regulation No 83 shall be understood as referring to the emissions limits set out in Table 2 of Annex I to Regulation (EC) No 715/2007.

3.4. The references to the Type I test in paragraph 2.3.1.7 of Annex 9 of UN/ECE Regulation No 83 shall be understood as reference to the Type 1 test in Annex XXI to this Regulation.

▼B

- 3.5. The references to the Type I test in paragraph 2.3.2.6 of Annex 9 of UN/ECE Regulation No 83 shall be understood as reference to the Type 1 test in Annex XXI to this Regulation.
- 3.6. The references to the Type I test in paragraph 3.1 of Annex 9 of UN/ECE Regulation No 83 shall be understood as reference to the Type 1 test in Annex XXI to this Regulation.
- 3.7. The reference to paragraph 5.3.1.4. in the first section of paragraph 7 of Annex 9 of UN/ECE Regulation No 83 shall be understood as reference to Table 2 of Annex I of the Regulation (EC) No 715/2007.
- 3.8. The reference in paragraph 6.3.1.2 of Annex 9 to UN/ECE Regulation No 83 to the methods in Appendix 7 to Annex 4a shall be understood as being a reference to Sub-Annex 4 to Annex XXI to this Regulation.
- 3.9. The reference in paragraph 6.3.1.4 of Annex 9 to UN/ECE Regulation No 83 to Annex 4a shall be understood as being a reference to Sub-Annex 4 to Annex XXI to this Regulation.

▼M3

- 3.10. The road load coefficients to be used shall be those for vehicle low (VL). If VL does not exist or the total load of vehicle (VH) at 80 km/h is higher than the total load of VL at 80 km/h + 5 %, then the VH road load shall be used. VL and VH are defined in point 4.2.1.1.2 of Sub-Annex 4 to Annex XXI.

▼B*ANNEX VIII***VERIFYING THE AVERAGE EMISSIONS AT LOW AMBIENT TEMPERATURES****(TYPE 6 TEST)****1. INTRODUCTION**

- 1.1. This Annex describes the equipment required and the procedure for the Type 6 test in order to verify the emissions at cold temperatures.

2. GENERAL REQUIREMENTS

- 2.1. The general requirements for the Type 6 test are those set out in section 5.3.5 of UN/ECE Regulation No 83 with the exception specified in section 2.2 below.
- 2.2. The limit values referred to in paragraph 5.3.5.2 of UN/ECE Regulation No 83 relate to the limit values set out in Annex 1, Table 4, to Regulation (EC) No 715/2007.

3. TECHNICAL REQUIREMENTS

- 3.1. The technical requirements and specifications are those set out in section 2 to 6 of Annex 8 to UN/ECE Regulation No 83 with the exception specified in section 3.2 below.
- 3.2. The reference to paragraph 2 of Annex 10 in paragraph 3.4.1 of Annex 8 to UN/ECE Regulation No 83 shall be understood as reference to Section B of Annex IX to this Regulation.

▼M3

- 3.3. The road load coefficients to be used shall be those for vehicle low (VL). If VL does not exist then the VH road load shall be used. VL and VH are defined in point 4.2.1.1.2 of Sub-Annex 4 to Annex XXI. Alternatively the manufacturer may choose to use road loads that have been determined in accordance with the provisions of Appendix 7 of Annex 4a of UN/ECE Regulation No 83 for a vehicle included in the interpolation family. In both cases, the dynamometer shall be adjusted to simulate the operation of a vehicle on the road at -7°C . Such adjustment may be based on a determination of the road load force profile at -7°C . Alternatively, the driving resistance determined may be adjusted for a 10 % decrease of the coast-down time. The technical service may approve the use of other methods for determining the driving resistance.



ANNEX IX

SPECIFICATIONS OF REFERENCE FUELS

A. REFERENCE FUELS

1. Technical data on fuels for testing vehicles with positive-ignition engines

Type: Petrol (E10):

Parameter	Unit	Limits ⁽¹⁾		Test method
		Minimum	Maximum	
Research octane number, RON ⁽²⁾		95,0	98,0	EN ISO 5164
Motor octane number, MON ⁽³⁾		85,0	89,0	EN ISO 5163
Density at 15 C	kg/m ³	743,0	756,0	EN ISO 12185
Vapour pressure (DVPE)	kPa	56,0	60,0	EN 13016-1
Water content	% v/v		0,05	EN 12937
Appearance at – 7 C		Clear and bright		
Distillation:				
— evaporated at 70 C	% v/v	34,0	46,0	EN ISO 3405
— evaporated at 100 C	% v/v	54,0	62,0	EN ISO 3405
— evaporated at 150 C	% v/v	86,0	94,0	EN ISO 3405
— final boiling point	°C	170	195	EN ISO 3405
Residue	% v/v	—	2,0	EN ISO 3405
Hydrocarbon analysis:				
— olefins	% v/v	6,0	13,0	EN 22854
— aromatics	% v/v	25,0	32,0	EN 22854
— benzene	% v/v	—	1,00	EN 22854 EN 238
— saturates	% v/v	report		EN 22854
Carbon/hydrogen ratio		report		
Carbon/oxygen ratio		report		
Induction Period ⁽⁴⁾	minutes	480	—	EN ISO 7536
Oxygen content ⁽⁵⁾	% m/m	3,3	3,7	EN 22854
Solvent washed gum (Existent gum content)	mg/100 ml	—	4	EN ISO 6246

▼B

Parameter	Unit	Limits ⁽¹⁾		Test method
		Minimum	Maximum	
Sulphur content ⁽⁶⁾	mg/kg	—	10	EN ISO 20846 EN ISO 20884
Copper corrosion 3 hrs, 50 C		—	class 1	EN ISO 2160
Lead content	mg/l	—	5	EN 237
Phosphorus content ⁽⁷⁾	mg/l	—	1,3	ASTM D 3231
Ethanol ⁽⁸⁾	% v/v	9,0	10,0	EN 22854

⁽¹⁾ The values quoted in the specifications are 'true values'. In establishment of their limit values the terms of ISO 4259 Petroleum products - Determination and application of precision data in relation to methods of test have been applied and in fixing a minimum value, a minimum difference of 2R above zero has been taken into account; in fixing a maximum and minimum value, the minimum difference is 4R (R = reproducibility). Notwithstanding this measure, which is necessary for technical reasons, the manufacturer of fuels shall nevertheless aim at a zero value where the stipulated maximum value is 2R and at the mean value in the case of quotations of maximum and minimum limits. Should it be necessary to clarify whether a fuel meets the requirements of the specifications, the terms of ISO 4259 shall be applied.

⁽²⁾ A correction factor of 0,2 for MON and RON shall be subtracted for the calculation of the final result in accordance with EN 228:2008.

⁽³⁾ A correction factor of 0,2 for MON and RON shall be subtracted for the calculation of the final result in accordance with EN 228:2008.

⁽⁴⁾ The fuel may contain oxidation inhibitors and metal deactivators normally used to stabilise refinery gasoline streams, but detergent/dispersive additives and solvent oils shall not be added.

⁽⁵⁾ Ethanol is the only oxygenate that shall be intentionally added to the reference fuel. The Ethanol used shall conform to EN 15376.

⁽⁶⁾ The actual sulphur content of the fuel used for the Type 1 test shall be reported.

⁽⁷⁾ There shall be no intentional addition of compounds containing phosphorus, iron, manganese, or lead to this reference fuel.

⁽⁸⁾ Ethanol is the only oxygenate that shall be intentionally added to the reference fuel. The Ethanol used shall conform to EN 15376.

⁽²⁾ Equivalent EN/ISO methods will be adopted when issued for properties listed above.

Type: Ethanol (E85)

Parameter	Unit	Limits ⁽¹⁾		Test method ⁽²⁾
		Minimum	Maximum	
Research octane number, RON		95	—	EN ISO 5164
Motor octane number, MON		85	—	EN ISO 5163
Density at 15 C	kg/m ³	Report		ISO 3675
Vapour pressure	kPa	40	60	EN ISO 13016-1 (DVPE)
Sulphur content ⁽³⁾ ⁽⁴⁾	mg/kg	—	10	EN ISO 20846 EN ISO 20884
Oxidation stability	minutes	360		EN ISO 7536
Existent gum content (solvent washed)	mg/100ml	—	5	EN-ISO 6246
Appearance This shall be determined at ambient temperature or 15 C whichever is higher.		Clear and bright, visibly free of suspended or precipitated contaminants		Visual inspection
Ethanol and higher alcohols ⁽⁵⁾	% (V/V)	83	85	EN 1601 EN 13132 EN 14517

▼B

Parameter	Unit	Limits ⁽¹⁾		Test method ⁽²⁾
		Minimum	Maximum	
Higher alcohols (C ₃ -C ₈)	% (V/V)	—	2	
Methanol	% (V/V)		0,5	
Petrol ⁽⁶⁾	% (V/V)	Balance		EN 228
Phosphorus	mg/l	0,3 ⁽⁷⁾		ASTM D 3231
Water content	% (V/V)		0,3	ASTM E 1064
Inorganic chloride content	mg/l		1	ISO 6227
pHe		6,5	9	ASTM D 6423
Copper strip corrosion (3h at 50 C)	Rating	Class 1		EN ISO 2160
Acidity, (as acetic acid CH ₃ COOH)	% (m/m)	—	0,005	ASTM D 1613
	(mg/l)	—	40	
Carbon/hydrogen ratio		report		
Carbon/oxygen ration		report		

⁽¹⁾ The values quoted in the specifications are 'true values'. In establishment of their limit values the terms of ISO 4259 Petroleum products — Determination and application of precision data in relation to methods of test have been applied and in fixing a minimum value, a minimum difference of 2R above zero has been taken into account; in fixing a maximum and minimum value, the minimum difference is 4R (R = reproducibility). Notwithstanding this measure, which is necessary for technical reasons, the manufacturer of fuels shall nevertheless aim at a zero value where the stipulated maximum value is 2R and at the mean value in the case of quotations of maximum and minimum limits. Should it be necessary to clarify whether a fuel meets the requirements of the specifications, the terms of ISO 4259 shall be applied.

⁽²⁾ In cases of dispute, the procedures for resolving the dispute and interpretation of the results based on test method precision, described in EN ISO 4259 shall be used.

⁽³⁾ In cases of national dispute concerning sulphur content, either EN ISO 20846 or EN ISO 20884 shall be called up similar to the reference in the national annex of EN 228.

⁽⁴⁾ The actual sulphur content of the fuel used for the Type 1 test shall be reported.

⁽⁵⁾ Ethanol to meet specification of EN 15376 is the only oxygenate that shall be intentionally added to this reference fuel.

⁽⁶⁾ The unleaded petrol content can be determined as 100 minus the sum of the percentage content of water and alcohols

⁽⁷⁾ There shall be no intentional addition of compounds containing phosphorus, iron, manganese, or lead to this reference fuel.

Type: LPG

Parameter	Unit	Fuel A	Fuel B	Test method
Composition:				ISO 7941
C ₃ -content	% vol	30 ± 2	85 ± 2	
C ₄ -content	% vol	Balance	Balance	
< C ₃ , > C ₄	% vol	Maximum 2	Maximum 2	
Olefins	% vol	Maximum 12	Maximum 15	
Evaporation residue	mg/kg	Maximum 50	Maximum 50	prEN 15470
Water at 0 C		Free	Free	prEN 15469
Total sulphur content	mg/kg	Maximum 10	Maximum 10	ASTM 6667

▼ B

Parameter	Unit	Fuel A	Fuel B	Test method
Hydrogen sulphide		None	None	ISO 8819
Copper strip corrosion	Rating	Class 1	Class 1	ISO 6251 ⁽¹⁾
Odour		Characteristic	Characteristic	
Motor octane number		Minimum 89	Minimum 89	EN 589 Annex B

⁽¹⁾ This method may not accurately determine the presence of corrosive materials if the sample contains corrosion inhibitors or other chemicals which diminish the corrosivity of the sample to the copper strip. Therefore, the addition of such compounds for the sole purpose of biasing the test method is prohibited.

Type: NG/Biomethane

Characteristics	Units	Basis	Limits		Test method
			minimum	maximum	
<i>Reference fuel G20</i>					
Composition:					
Methane	% mole	100	99	100	ISO 6974
Balance ⁽¹⁾	% mole	—	—	1	ISO 6974
N ₂	% mole				ISO 6974
Sulphur content	mg/m ³ ⁽²⁾	—	—	10	ISO 6326-5
Wobbe Index (net)	MJ/m ³ ⁽³⁾	48,2	47,2	49,2	
<i>Reference fuel G25</i>					
Composition:					
Methane	% mole	86	84	88	ISO 6974
Balance ⁽⁴⁾	% mole	—	—	1	ISO 6974
N ₂	% mole	14	12	16	ISO 6974
Sulphur content	mg/m ³ ⁽⁵⁾	—	—	10	ISO 6326-5
Wobbe Index (net)	MJ/m ³ ⁽⁶⁾	39,4	38,2	40,6	

⁽¹⁾ Inerts (different from N₂) + C₂ + C₂₊.

⁽²⁾ Value to be determined at 293,2 K (20 C) and 101,3 kPa.

⁽³⁾ Value to be determined at 273,2 K (0 C) and 101,3 kPa.

⁽⁴⁾ Inerts (different from N₂) + C₂; + C₂₊.

⁽⁵⁾ Value to be determined at 293,2 K (20 C) and 101,3 kPa.

⁽⁶⁾ Value to be determined at 273,2 K (0 C) and 101,3 kPa.

Type: Hydrogen for internal combustion engines

Characteristics	Units	Limits		Test method
		minimum	maximum	
Hydrogen purity	% mole	98	100	ISO 14687-1
Total hydrocarbon	µmol/mol	0	100	ISO 14687-1

▼B

Characteristics	Units	Limits		Test method
		minimum	maximum	
Water ⁽¹⁾	µmol/mol	0	⁽²⁾	ISO 14687-1
Oxygen	µmol/mol	0	⁽³⁾	ISO 14687-1
Argon	µmol/mol	0	⁽⁴⁾	ISO 14687-1
Nitrogen	µmol/mol	0	⁽⁵⁾	ISO 14687-1
CO	µmol/mol	0	1	ISO 14687-1
Sulphur	µmol/mol	0	2	ISO 14687-1
Permanent particulates ⁽⁶⁾				ISO 14687-1

⁽¹⁾ Not to be condensed.

⁽²⁾ Combined water, oxygen, nitrogen and argon: 1,900 µmol/mol.

⁽³⁾ Combined water, oxygen, nitrogen and argon: 1,900 µmol/mol.

⁽⁴⁾ Combined water, oxygen, nitrogen and argon: 1,900 µmol/mol.

⁽⁵⁾ Combined water, oxygen, nitrogen and argon: 1,900 µmol/mol.

⁽⁶⁾ The hydrogen shall not contain dust, sand, dirt, gums, oils, or other substances in an amount sufficient to damage the fuelling station equipment or the vehicle (engine) being fuelled.

2. Technical data on fuels for testing vehicles with compression ignition engines

Type: Diesel (B7):

Parameter	Unit	Limits ⁽¹⁾		Test method
		Minimum	Maximum	
Cetane Index		46,0		EN ISO 4264
Cetane number ⁽²⁾		52,0	56,0	EN ISO 5165
Density at 15 C	kg/m ³	833,0	837,0	EN ISO 12185
Distillation:				
— 50 % point	°C	245,0	—	EN ISO 3405
— 95 % point	°C	345,0	360,0	EN ISO 3405
— final boiling point	°C	—	370,0	EN ISO 3405
Flash point	°C	55	—	EN ISO 2719
Cloud point	°C	—	- 10	EN 23015
Viscosity at 40 C	mm ² /s	2,30	3,30	EN ISO 3104
Polycyclic aromatic hydrocarbons	% m/m	2,0	4,0	EN 12916
Sulphur content	mg/kg	—	10,0	EN ISO 20846 EN ISO 20884
Copper corrosion 3 hrs, 50 C		—	Class 1	EN ISO 2160
Conradson carbon residue (10 % DR)	% m/m	—	0,20	EN ISO 10370
Ash content	% m/m	—	0,010	EN ISO 6245

▼ B

Parameter	Unit	Limits ⁽¹⁾		Test method
		Minimum	Maximum	
Total contamination	mg/kg	—	24	EN 12662
Water content	mg/kg	—	200	EN ISO 12937
Acid number	mg KOH/g	—	0,10	EN ISO 6618
Lubricity (HFRR wear scan diameter at 60 C)	µm	—	400	EN ISO 12156
Oxidation stability at 110 C ⁽²⁾	h	20,0		EN 15751
FAME ⁽⁴⁾	% v/v	6,0	7,0	EN 14078

⁽¹⁾ The values quoted in the specifications are 'true values'. In establishment of their limit values the terms of ISO 4259 Petroleum products – Determination and application of precision data in relation to methods of test have been applied and in fixing a minimum value, a minimum difference of 2R above zero has been taken into account; in fixing a maximum and minimum value, the minimum difference is 4R (R = reproducibility). Notwithstanding this measure, which is necessary for technical reasons, the manufacturer of fuels shall nevertheless aim at a zero value where the stipulated maximum value is 2R and at the mean value in the case of quotations of maximum and minimum limits. Should it be necessary to clarify whether a fuel meets the requirements of the specifications, the terms of ISO 4259 shall be applied.

⁽²⁾ The range for cetane number is not in accordance with the requirements of a minimum range of 4R. However, in the case of a dispute between fuel supplier and fuel user, the terms of ISO 4259 may be used to resolve such disputes provided replicate measurements, of sufficient number to archive the necessary precision, are made in preference to single determinations.

⁽³⁾ Even though oxidation stability is controlled, it is likely that shelf life will be limited. Advice shall be sought from the supplier as to storage conditions and life.

⁽⁴⁾ FAME content to meet the specification of EN 14214.

▼ M3**3. Technical data on fuels for testing fuel cell vehicles**

Type: Hydrogen for fuel cell vehicles

Characteristics	Units	Limits		Test Method
		minimum	maximum	
Hydrogen fuel index ^(a)	% mole	99,97		
Total non-hydrogen gases	µmol/mol		300	
Maximum concentration of individual contaminants				
Water (H ₂ O)	µmol/mol		5	^(e)
Total hydrocarbons ^(b) (Methane basis)	µmol/mol		2	^(e)
Oxygen (O ₂)	µmol/mol		5	^(e)
Helium (He)	µmol/mol		300	^(e)
Total Nitrogen (N ₂) and Argon (Ar) ^(b)	µmol/mol		100	^(e)
Carbon dioxide (CO ₂)	µmol/mol		2	^(e)
Carbon monoxide (CO)	µmol/mol		0,2	^(e)
Total sulfur compounds ^(c) (H ₂ S basis)	µmol/mol		0,004	^(e)
Formaldehyde (HCHO)	µmol/mol		0,01	^(e)
Formic acid (HCOOH)	µmol/mol		0,2	^(e)

▼M3

Characteristics	Units	Limits		Test Method
		minimum	maximum	
Ammonia (NH ₃)	µmol/mol		0,1	(^d)
Total halogenated compounds (^d) (Halogenate ion basis)	µmol/mol		0,05	(^d)

For the constituents that are additive, such as total hydrocarbons and total sulfur compounds, the sum of the constituents are to be less than or equal to the acceptable limit.

(^a) The hydrogen fuel index is determined by subtracting the 'total non-hydrogen gases' in this table, expressed in mole per cent, from 100 mole per cent.

(^b) Total hydrocarbons include oxygenated organic species. Total hydrocarbons shall be measured on a carbon basis (µmolC/mol). Total hydrocarbons may exceed 2 µmol/mol due only to the presence of methane, in which case the summation of methane, nitrogen and argon shall not exceed 100 µmol/mol.

(^c) As a minimum, total sulphur compounds include H₂S, COS, CS₂ and mercaptans, which are typically found in natural gas.

(^d) Total halogenated compounds include, for example, hydrogen bromide (HBr), hydrogen chloride (HCl), chlorine (Cl₂), and organic halides (R-X).

(^e) Test method shall be documented.

▼B

B. REFERENCE FUELS FOR TESTING EMISSIONS AT LOW AMBIENT TEMPERATURES — TYPE 6 TEST

Type: Petrol (E10):

Parameter	Unit	Limits (¹)		Test method
		Minimum	Maximum	
Research octane number, RON (²)		95,0	98,0	EN ISO 5164
Motor octane number, MON (³)		85,0	89,0	EN ISO 5163
Density at 15 C	kg/m ³	743,0	756,0	EN ISO 12185
Vapour pressure (DVPE)	kPa	56,0	95,0	EN 13016-1
Water content		max 0,05 % v/v Appearance at - 7 C: clear and bright		EN 12937
Distillation:				
— evaporated at 70 C	% v/v	34,0	46,0	EN ISO 3405
— evaporated at 100 C	% v/v	54,0	62,0	EN ISO 3405
— evaporated at 150 C	% v/v	86,0	94,0	EN ISO 3405
— final boiling point	°C	170	195	EN ISO 3405
Residue	% v/v	—	2,0	EN ISO 3405
Hydrocarbon analysis:				
— olefins	% v/v	6,0	13,0	EN 22854
— aromatics	% v/v	25,0	32,0	EN 22854
— benzene	% v/v	—	1,00	EN 22854 EN 238
— saturates	% v/v	report		EN 22854
Carbon/hydrogen ratio		report		
Carbon/oxygen ratio		report		
Induction Period (⁴)	minutes	480	—	EN ISO 7536
Oxygen content (⁵)	% m/m	3,3	3,7	EN 22854

▼ B

Parameter	Unit	Limits ⁽¹⁾		Test method
		Minimum	Maximum	
Solvent washed gum (Existent gum content)	mg/100 ml	—	4	EN ISO 6246
Sulphur content ⁽⁶⁾	mg/kg	—	10	EN ISO 20846 EN ISO 20884
Copper corrosion 3 hrs, 50 C		—	class 1	EN ISO 2160
Lead content	mg/l	—	5	EN 237
Phosphorus content ⁽⁷⁾	mg/l	—	1,3	ASTM D 3231
Ethanol ⁽⁸⁾	% v/v	9,0	10,0	EN 22854

⁽¹⁾ The values quoted in the specifications are 'true values'. In establishment of their limit values the terms of ISO 4259 Petroleum products - Determination and application of precision data in relation to methods of test have been applied and in fixing a minimum value, a minimum difference of 2R above zero has been taken into account; in fixing a maximum and minimum value, the minimum difference is 4R (R = reproducibility). Notwithstanding this measure, which is necessary for technical reasons, the manufacturer of fuels shall nevertheless aim at a zero value where the stipulated maximum value is 2R and at the mean value in the case of quotations of maximum and minimum limits. Should it be necessary to clarify whether a fuel meets the requirements of the specifications, the terms of ISO 4259 shall be applied.

⁽²⁾ A correction factor of 0,2 for MON and RON shall be subtracted for the calculation of the final result in accordance with EN 228:2008.

⁽³⁾ A correction factor of 0,2 for MON and RON shall be subtracted for the calculation of the final result in accordance with EN 228:2008.

⁽⁴⁾ The fuel may contain oxidation inhibitors and metal deactivators normally used to stabilise refinery gasoline streams, but detergent/dispersive additives and solvent oils shall not be added.

⁽⁵⁾ Ethanol is the only oxygenate that shall be intentionally added to the reference fuel. The ethanol used shall conform to EN 15376.

⁽⁶⁾ The actual sulphur content of the fuel used for the Type 6 test shall be reported.

⁽⁷⁾ There shall be no intentional addition of compounds containing phosphorus, iron, manganese, or lead to this reference fuel.

⁽⁸⁾ Ethanol is the only oxygenate that shall be intentionally added to the reference fuel. The ethanol used shall conform to EN 15376.

⁽²⁾ Equivalent EN/ISO methods will be adopted when issued for properties listed above.

Type: Ethanol (E75)

Parameter	Unit	Limits ⁽¹⁾		Test method ⁽²⁾
		Minimum	Maximum	
Research octane number, RON		95	—	EN ISO 5164
Motor octane number, MON		85	—	EN ISO 5163
Density at 15 C	kg/m ³	report		EN ISO 12185
Vapour pressure	kPa	50	60	EN ISO 13016-1 (DVPE)
Sulphur content ⁽³⁾ ⁽⁴⁾	mg/kg	—	10	EN ISO 20846 EN ISO 20884
Oxidation stability	minutes	360	—	EN ISO 7536
Existent gum content (solvent washed)	mg/100ml	—	4	EN ISO 6246

▼B

Parameter	Unit	Limits ⁽¹⁾		Test method ⁽²⁾
		Minimum	Maximum	
Appearance shall be determined at ambient temperature or 15 C whichever is higher		Clear and bright, visibly free of suspended or precipitated contaminants		Visual inspection
Ethanol and higher alcohols ⁽³⁾	% (V/V)	70	80	EN 1601 EN 13132 EN 14517
Higher alcohols (C ₃ – C ₈)	% (V/V)	—	2	
Methanol		—	0,5	
Petrol ⁽⁶⁾	% (V/V)	Balance		EN 228
Phosphorus	mg/l	0,30 ⁽⁷⁾		EN 15487 ASTM D 3231
Water content	% (V/V)	—	0,3	ASTM E 1064 EN 15489
Inorganic chloride content	mg/l	—	1	ISO 6227 — EN 15492
pHe		6,50	9	ASTM D 6423 EN 15490
Copper strip corrosion (3h at 50 C)	Rating	Class 1		EN ISO 2160
Acidity (as acetic acid CH ₃ COOH)	% (m/m)		0,005	ASTM D1613 EN 15491
	mg/l		40	
Carbon/hydrogen ration		report		
Carbon/oxygen ration		report		

⁽¹⁾ The values referred to in the specifications are 'true values'. When establishing the value limits, the terms of ISO 4259 Petroleum products — Determination and application of precision data in relation to methods of test were applied. When fixing a minimum value, a minimum difference of 2R above zero was taken into account. When fixing a maximum and minimum value, the minimum difference used was 4R (R = reproducibility). Notwithstanding this procedure, which is necessary for technical reasons, fuel manufacturers shall aim for a zero value where the stipulated maximum value is 2R and for the mean value for quotations of maximum and minimum limits. Where it is necessary to clarify whether fuel meets the requirements of the specifications, the ISO 4259 terms shall be applied.

⁽²⁾ In cases of dispute, the procedures for resolving the dispute and interpretation of the results based on test method precision, described in EN ISO 4259 shall be used.

⁽³⁾ In cases of national dispute concerning sulphur content, either EN ISO 20846 or EN ISO 20884 shall be called up similar to the reference in the national annex of EN 228.

⁽⁴⁾ The actual sulphur content of the fuel used for the Type 6 test shall be reported.

⁽⁵⁾ Ethanol to meet specification of EN 15376 is the only oxygenate that shall be intentionally added to this reference fuel.

⁽⁶⁾ The unleaded petrol content may be determined as 100 minus the sum of the percentage content of water and alcohols.

⁽⁷⁾ There shall be no intentional addition of compounds containing phosphorus, iron, manganese, or lead to this reference fuel.

▼B

ANNEX X

Reserved

▼ **M3***ANNEX XI***ON-BOARD DIAGNOSTICS (OBD) FOR MOTOR VEHICLES**

1. INTRODUCTION

- 1.1. This Annex sets out the functional aspects of on-board diagnostic (OBD) systems for the control of emissions from motor vehicles.

2. DEFINITIONS, REQUIREMENTS AND TESTS

- 2.1. The definitions, requirements and tests for OBD systems set out in Sections 2 and 3 of Annex 11 to UN/ECE Regulation No 83 shall apply for the purposes of this Annex, with the exceptions set out in this Annex.

- 2.1.1. The introductory text to paragraph 2. of Annex 11 to UN/ECE Regulation No 83 shall be understood as follows:

‘For the purposes of this Annex only:’

- 2.1.2. Paragraph 2.10. of Annex 11 to UN/ECE Regulation No 83 shall be understood as follows:

‘A ‘*driving cycle*’ consists of engine key on, a driving mode where a malfunction would be detected if present, and engine key-off’.

- 2.1.3. In addition to the requirements of paragraph 3.2.2. of Annex 11 of UN/ECE Regulation No 83, identification of deterioration or malfunctions may be also be done outside a driving cycle (e.g. after engine shutdown).

- 2.1.4. Paragraph 3.3.3.1. of Annex 11 of UN/ECE Regulation No 83 shall be understood as follows:

‘3.3.3.1. The reduction in the efficiency of the catalytic converter with respect to emissions of NMHC and NO_x. Manufacturers may monitor the front catalyst alone or in combination with the next catalyst(s) downstream. Each monitored catalyst or catalyst combination shall be considered malfunctioning when the emissions exceed the NMHC or NO_x threshold limits provided for by paragraph 3.3.2. of this Annex.’

- 2.1.5. The reference to ‘the threshold limits’ in Section 3.3.3.1 of Annex 11 to UNECE Regulation No 83 shall be understood as reference to the threshold limits in Section 2.3 of this Annex.

- 2.1.6. Reserved.

- 2.1.7. Paragraphs 3.3.4.9. and 3.3.4.10. of Annex 11 of UN/ECE Regulation No 83 shall not apply.

- 2.1.8. Paragraphs 3.3.5. to 3.3.5.2. of Annex 11 of UN/ECE Regulation No 83 shall be understood as follows:

‘3.3.5. Manufacturers may demonstrate to the Type Approval Authority that certain components or systems need not be monitored if, in the event of their total failure or removal, emissions do not exceed the OBD threshold limits given in paragraph 3.3.2. of this Annex.

3.3.5.1. The following devices should however be monitored for total failure or removal (if removal would cause the applicable emission limits in paragraph 5.3.1.4. of this Regulation to be exceeded):

▼ M3

- (a) A particulate trap fitted to compression ignition engines as a separate unit or integrated into a combined emission control device;
- (b) A NO_x after treatment system fitted to compression ignition engines as a separate unit or integrated into a combined emission control device;
- (c) A Diesel Oxidation Catalyst (DOC) fitted to compression ignition engines as a separate unit or integrated into a combined emission control device.

3.3.5.2. The devices referred to in paragraph 3.3.5.1. of this Annex shall also be monitored for any failure that would result in exceeding the applicable OBD threshold limits.'

2.1.9. Paragraph 3.8.1. of Annex 11 to UN/ECE Regulation No 83 shall be understood as follows:

'The OBD system may erase a fault code and the distance travelled and freeze-frame information if the same fault is not re-registered in at least 40 engine warm-up cycles or 40 driving cycles with vehicle operation in which the criteria specified in sections 7.5.1.(a)–(c) of Annex 11, Appendix 1 are met.'

2.1.10. The reference to 'ISO DIS 15031 5' in paragraph 3.9.3.1. of Annex 11 to UN/ECE Regulation No 83 shall be understood as follows:

'... the standard listed in paragraph 6.5.3.2.(a) of Annex 11, Appendix 1 of this Regulation.'

2.1.11. In addition to the requirements of paragraph 3. of Annex 11 of UN/ECE Regulation No 83 the following shall apply:

'Additional provisions for vehicles employing engine shut - off strategies

Driving cycle

Autonomous engine restarts commanded by the engine control system following an engine stall may be considered a new driving cycle or a continuation of the existing driving cycle.'

2.2. The 'Type V durability distance' and 'Type V durability test' mentioned in section 3.1 and 3.3.1 of Annex 11 to UN/ECE Regulation No 83 respectively shall be understood as reference to the requirements of Annex VII to this Regulation.

2.3. The 'OBD threshold limits' specified in section 3.3.2 of Annex 11 to UN/ECE Regulation 83 shall be understood as reference to the requirements specified in points 2.3.1. and 2.3.2. below:

2.3.1. The OBD thresholds limits for vehicles that are type approved in accordance with the Euro 6 emission limits set out in Table 2 of Annex I to Regulation (EC) No 715/2007 from three years after the dates given in Article 10(4) and 10(5) of that Regulation are given in the following table:

▼ M3

Final Euro 6 OBD threshold limits

Category	Class	Reference mass (RM) (kg)	Mass of carbon monoxide		Mass of non-methane hydrocarbons		Mass of oxides of nitrogen		Mass of particulate matter ⁽¹⁾		Number of particles ⁽²⁾	
			(CO) (mg/km)		(NMHC) (mg/km)		(NO _x) (mg/km)		(PM) (mg/km)		(PN) (#/km)	
			PI	CI	PI	CI	PI	CI	CI	PI	CI	PI
M	—	All	1 900	1 750	170	290	90	140	12	12		
N ₁	I	RM ≤ 1 305	1 900	1 750	170	290	90	140	12	12		
	II	1 305 < RM ≤ 1 760	3 400	2 200	225	320	110	180	12	12		
	III	1 760 < RM	4 300	2 500	270	350	120	220	12	12		
N ₂	—	All	4 300	2 500	270	350	120	220	12	12		

Key: PI = Positive Ignition, CI = Compression Ignition.

⁽¹⁾ Positive ignition particulate mass and particle number limits apply only to vehicles with direct injection engines.

⁽²⁾ Particle number limits may be introduced at a later date.

2.3.2. Until three years after the dates specified in Article 10(4) and (5) of Regulation (EC) No 715/2007 for new type approvals and new vehicles respectively, the following OBD threshold limits shall be applied to vehicles that are type approved in accordance with the Euro 6 emission limits set out in Table 2 of Annex I to Regulation (EC) No 715/2007, upon the choice of the manufacturer:

Preliminary Euro 6 OBD threshold limits

Category	Class	Reference mass (RM) (kg)	Mass of carbon monoxide		Mass of non-methane hydrocarbons		Mass of oxides of nitrogen		Mass of particulate matter ⁽¹⁾	
			(CO) (mg/km)		(NMHC) (mg/km)		(NO _x) (mg/km)		(PM) (mg/km)	
			PI	CI	PI	CI	PI	CI	CI	PI
M	—	All	1 900	1 750	170	290	150	180	25	25
N ₁	I	RM ≤ 1 305	1 900	1 750	170	290	150	180	25	25
	II	1 305 < RM ≤ 1 760	3 400	2 200	225	320	190	220	25	25
	III	1 760 < RM	4 300	2 500	270	350	210	280	30	30
N ₂	—	All	4 300	2 500	270	350	210	280	30	30

Key: PI = Positive Ignition, CI = Compression Ignition

⁽¹⁾ Positive ignition particulate mass limits apply only to vehicles with direct injection engines.

2.4.

2.5. Reserved.

▼ M3

2.6. The ‘Type I test cycle’ referred to in paragraph 3.3.3.2. of Annex 11 to UN/ECE Regulation No 83 shall be understood as being the same as the Type I cycle that was used for at least two consecutive cycles after introduction of the misfire faults in accordance with paragraph 6.3.1.2. of Appendix 1 to Annex 11 to UN/ECE Regulation No 83.

2.7. The reference to ‘the particulate threshold limits provided for by paragraph 3.3.2.’ in paragraph 3.3.3.7. of Annex 11 to UN/ECE Regulation No 83 shall be understood as being reference to the particulate threshold limits provided in Section 2.3 of this Annex.

2.8. Paragraph 3.3.3.4. of Annex 11 of UN/ECE Regulation No 83 shall be understood as follows:

‘3.3.3.4. If active on the selected fuel, other emission control system components or systems, or emission related power train components or systems which are connected to a computer, the failure of which may result in tailpipe emissions exceeding the OBD threshold limits given in paragraph 3.3.2. of this Annex.’

2.9. Paragraph 3.3.4.4. of Annex 11 of UN/ECE Regulation No 83 shall be understood as follows:

‘3.3.4.4. Other emission control system components or systems, or emission-related power-train components or systems, which are connected to a computer, the failure of which may result in exhaust emissions exceeding the OBD threshold limits given in paragraph 3.3.2. of this Annex. Examples of such systems or components are those for monitoring and control of air mass-flow, air volumetric flow (and temperature), boost pressure and inlet manifold pressure (and relevant sensors to enable these functions to be carried out).’

3. ADMINISTRATIVE PROVISIONS FOR DEFICIENCIES OF OBD SYSTEMS

3.1. The administrative provisions for deficiencies of OBD systems as set out in Article 6(2) shall be those specified in Section 4 of Annex 11 of UN/ECE Regulation No 83 with the following exceptions.

3.2. Reference to ‘OBD threshold limits’ in paragraph 4.2.2. of Annex 11 to UN/ECE Regulation No 83 shall be understood as being reference to the OBD threshold limits in Section 2.3 of this Annex.

3.3. Paragraph 4.6 of Annex 11 to UN/ECE Regulation No 83 shall be understood as being as follows:

‘The approval authority shall notify its decision in granting a deficiency request in accordance with Article 6(2).’

4. ACCESS TO OBD INFORMATION

4.1. Requirements for access to OBD information are specified in section 5 of Annex 11 to UN/ECE Regulation 83. The exceptions to these requirements are described in the following sections.

4.2. References to Appendix 1 of Annex 2 to UN/ECE Regulation No 83 shall be understood as references to Appendix 5 to Annex I to this Regulation.

▼M3

- 4.3. References to section 3.2.12.2.7.6. of Annex 1 to UN/ECE Regulation No 83 shall be understood as references to 3.2.12.2.7.6 of Appendix 3 to Annex I to this Regulation.
- 4.4. References to ‘contracting parties’ shall be understood as references to ‘member states’.
- 4.5. References to ‘approval granted under Regulation 83’ shall be understood as references to type-approval granted under this Regulation and Regulation (EC) No 715/2007.
- 4.6. UN/ECE type-approval shall be understood as EC type-approval.

▼ **M3***Appendix 1***FUNCTIONAL ASPECTS OF ON-BOARD DIAGNOSTIC (OBD) SYSTEMS**

1. INTRODUCTION

- 1.1. This Appendix describes the procedure of the test in accordance with section 2 of this Annex.

2. TECHNICAL REQUIREMENTS

- 2.1. The technical requirements and specifications shall be those set out in Appendix 1 to Annex 11 to UN/ECE Regulation No 83 with the exceptions and additional requirements as described in the following sections.

- 2.2. The references in Appendix 1 to Annex 11 to UN/ECE Regulation No 83 to the OBD threshold limits set out in paragraph 3.3.2. to Annex 11 of UN/ECE Regulation No 83 shall be understood as references to the OBD threshold limits set out in section 2.3 of this Annex.

- 2.3. The reference to ‘the Type I test cycle’ in section 2.1.3 of Appendix 1 to Annex 11 of UN/ECE Regulation No 83 shall be understood as a reference to the Type 1 test in accordance with Regulation (EC) No 692/2008 or Annex XXI of this Regulation, upon the choice of the manufacturer for each individual malfunction to be demonstrated.

- 2.4. The reference fuels specified in paragraph 3.2. of Appendix 1 of Annex 11 of UN/ECE Regulation No 83 shall be understood as reference to the appropriate reference fuel specifications in Annex IX to this Regulation.

- 2.5. Paragraph 6.4.1.1. of Appendix 1 to Annex 11 of UN/ECE Regulation No 83 shall be understood as follows:

‘6.4.1.1. After vehicle preconditioning in accordance with paragraph 6.2. of this Appendix, the test vehicle is driven over a Type I test (Parts One and Two).

The MI shall be activated at the latest before the end of this test under any of the conditions given in paragraphs 6.4.1.2. to 6.4.1.5. of this Appendix. The MI may also be activated during preconditioning. The Technical Service may substitute those conditions with others in accordance with paragraph 6.4.1.6. of this Appendix. However, the total number of failures simulated shall not exceed four (4) for the purpose of type approval.

In the case of testing a bi-fuel gas vehicle, both fuel types shall be used within the maximum of four (4) simulated failures at the discretion of the Type Approval Authority.’

- 2.6. The reference to ‘Annex 11’ in paragraph 6.5.1.4. of Appendix 1 of Annex 11 of UN/ECE Regulation No 83 shall be understood as reference to Annex XI to this Regulation.

- 2.7. In addition to the requirements of the second paragraph of Section 1 of Appendix 1 to Annex 11 of UN/ECE Regulation No 83 the following shall apply:

‘For electrical failures (short/open circuit), the emissions may exceed the limits of paragraph 3.3.2. by more than twenty per cent.’

- 2.8. Paragraph 6.5.3. of Appendix 1 to Annex 11 of UN/ECE Regulation No 83 shall be understood as follows:

▼ M3

‘6.5.3. The emission control diagnostic system shall provide for standardised and unrestricted access and conform with the following ISO standards and/or SAE specification. Later versions may be used if any of the following standards have been withdrawn and replaced by the relevant standardisation organisation.

6.5.3.1. The following standard shall be used as the on board to off-board communications link:

- (a) ISO 15765-4:2011 ‘Road vehicles – Diagnostics on Controller Area Network (CAN) – Part 4: Requirements for emissions-related systems’, dated April 2016;

6.5.3.2. Standards used for the transmission of OBD relevant information:

- (a) ISO 15031-5 ‘Road vehicles - communication between vehicles and external test equipment for emissions-related diagnostics – Part 5: Emissions-related diagnostic services’, dated August 2015 or SAE J1979 dated February 2017;
- (b) ISO 15031-4 ‘Road vehicles – Communication between vehicle and external test equipment for emissions related diagnostics – Part 4: External test equipment’, dated February 2014 or SAE J1978 dated 30 April 2002;
- (c) ISO 15031-3 ‘Road vehicles – Communication between vehicle and external test equipment for emissions related diagnostics Part 3: Diagnostic connector and related electrical circuits: specification and use’, dated April 2016 or SAE J1962 dated 26 July 2012;
- (d) ISO 15031-6 ‘Road vehicles – Communication between vehicle and external test equipment for emissions related diagnostics – Part 6: Diagnostic trouble code definitions’, dated August 2015 or SAE J2012 dated 7 March 2013;
- (e) ISO 27145 ‘Road vehicles – Implementation of World-Wide Harmonized On-Board Diagnostics (WWH-OBD)’ dated 2012-08-15 with the restriction, that only paragraph 6.5.3.1.(a) may be used as a data link;
- (f) ISO 14229:2013 ‘Road vehicles – Unified diagnostic services (UDS) with the restriction, that only 6.5.3.1.(a) may be used as a data link’.

The standards (e) and (f) may be used as an option instead of (a) not earlier than 1 January 2019.

▼ **M3**

- 6.5.3.3. Test equipment and diagnostic tools needed to communicate with OBD systems shall meet or exceed the functional specification given in the standard listed in paragraph 6.5.3.2.(b) of this Appendix.
- 6.5.3.4. Basic diagnostic data, (as specified in paragraph 6.5.1.) and bi-directional control information shall be provided using the format and units described in the standard listed in paragraph 6.5.3.2.(a) of this Appendix, and must be available using a diagnostic tool meeting the requirements of the standard listed in paragraph 6.5.3.2.(b) of this Appendix.

The vehicle manufacturer shall provide to a national standardisation body the details of any emission-related diagnostic data, e.g. PID's, OBD monitor Id's, Test Id's not specified in the standard listed in paragraph 6.5.3.2.(a) of this Regulation but related to this Regulation.

- 6.5.3.5. When a fault is registered, the manufacturer shall identify the fault using an appropriate ISO/SAE controlled fault code specified in one of the standards listed in paragraph 6.5.3.2.(d) of this Appendix, relating to 'emission related system diagnostic trouble codes'. If such identification is not possible, the manufacturer may use manufacturer controlled diagnostic trouble codes in accordance with the same standard. The fault codes shall be fully accessible by standardised diagnostic equipment complying with the provisions of paragraph 6.5.3.3. of this Appendix.

The vehicle manufacturer shall provide to a national standardisation body the details of any emission-related diagnostic data, e.g. PID's, OBD monitor Id's, Test Id's not specified in the standards listed in paragraph 6.5.3.2.(a) of this Appendix but related to this Regulation.

- 6.5.3.6. The connection interface between the vehicle and the diagnostic tester shall be standardised and shall meet all the requirements of the standard listed in paragraph 6.5.3.2.(c) of this Appendix. The installation position shall be subject to agreement of the administrative department such that it is readily accessible by service personnel but protected from tampering by non-qualified personnel.
- 6.5.3.7. The manufacturer shall also make accessible, where appropriate on payment, the technical information required for the repair or maintenance of motor vehicles unless that information is covered by an intellectual property right or constitutes essential, secret know-how which is identified in an appropriate form; in such case, the necessary technical information shall not be withheld improperly.

Entitled to such information is any person engaged in commercially servicing or repairing, road-side rescuing, inspecting or testing of vehicles or in the manufacturing or selling replacement or retro-fit components, diagnostic tools and test equipment.'

- 2.9. In addition to the requirements of paragraph 6.1. of Appendix 1 to Annex 11 of UN/ECE Regulation No 83 the following shall apply:

▼ **M3**

‘The Type I Test need not be performed for the demonstration of electrical failures (short/open circuit). The manufacturer may demonstrate these failure modes using driving conditions in which the component is used and the monitoring conditions are encountered. These conditions shall be documented in the type approval documentation.’

- 2.10 Paragraph 6.2.2. of Appendix 1 of Annex 11 of UN/ECE Regulation No 83 shall be understood as follows:

‘At the request of the manufacturer, alternative and/or additional preconditioning methods may be used.’

- 2.11 In addition to the requirements of paragraph 6.2. of Appendix 1 to Annex 11 of UN/ECE Regulation No 83 the following shall apply:

‘The use of additional preconditioning cycles or alternative preconditioning methods shall be documented in the type approval documentation.’

- 2.12. Paragraph 6.3.1.5. of Appendix 1 to Annex 11 of UN/ECE Regulation No 83 shall be understood as follows:

‘Electrical disconnection of the electronic evaporative purge control device (if equipped and if active on the selected fuel type).’

- 2.13. Reserved.

- 2.14. Paragraph 6.4.2.1. of Appendix 1 to Annex 11 of UN/ECE Regulation No 83 shall be understood as follows:

‘After vehicle preconditioning in accordance with paragraph 6.2. of this Appendix, the test vehicle is driven over a Type I test (Parts One and Two).

The MI shall be activated at the latest before the end of this test under any of the conditions given in paragraphs 6.4.2.2. to 6.4.2.5. The MI may also be activated during preconditioning. The Technical Service may substitute those conditions by others in accordance with paragraph 6.4.2.5. of this appendix. However, the total number of failures simulated shall not exceed four (4) for the purposes of type approval.’

- 2.15. The information listed in point 3 of Annex XXII shall be made available as signals through the serial port connector referred to in paragraph 6.5.3.2 (c) of Appendix 1 to Annex 11 to UN/ECE Regulation No 83, understood as set out in point 2.8 of Appendix 1 to this Annex.

3. IN-USE PERFORMANCE

3.1. General Requirements

The technical requirements and specifications shall be those set out in Appendix 1 to Annex 11 to UN/ECE Regulation No 83 with the exceptions and additional requirements as described in the following sections.

- 3.1.1. The requirements of paragraph 7.1.5. of Appendix 1 to Annex 11 to UN/ECE Regulation No 83 shall be understood as being as follows.

For new type approvals and new vehicles the monitor required by paragraph 3.3.4.7. of Annex 11 to UN/ECE Regulation No 83 shall have an IUPR greater or equal to 0,1 until three years after the dates specified in Article 10(4) and (5) of Regulation (EC) No 715/2007 respectively.

- 3.1.2. The requirements of paragraph 7.1.7. of Appendix 1 to Annex 11 to UN/ECE Regulation No 83 shall be understood as being as follows.

▼ M3

The manufacturer shall demonstrate to the approval authority and, upon request, to the Commission that these statistical conditions are satisfied for all monitors required to be reported by the OBD system in accordance with paragraph 7.6. of Appendix 1 to Annex 11 to Regulation No 83 not later than 18 months after the entry onto the market of the first vehicle type with IUPR in an OBD family and every 18 months thereafter. For this purpose, for OBD families consisting of more than 1 000 registrations in the Union, that are subject to sampling within the sampling period, the process described in Annex II shall be used without prejudice to the provisions of paragraph 7.1.9. of Appendix 1 to Annex 11 to Regulation No 83.

In addition to the requirements set out in Annex II and regardless of the result of the audit described in Section 2 of Annex II, the authority granting the approval shall apply the in-service conformity check for IUPR described in Appendix 1 to Annex II in an appropriate number of randomly determined cases. ‘In an appropriate number of randomly determined cases’ means, that this measure has a dissuasive effect on non-compliance with the requirements of Section 3 of this Annex or the provision of manipulated, false or non-representative data for the audit. If no special circumstances apply and can be demonstrated by the type-approval authorities, random application of the in-service conformity check to 5 % of the type approved OBD families shall be considered as sufficient for compliance with this requirement. For this purpose, type-approval authorities may find arrangements with the manufacturer for the reduction of double testing of a given OBD family as long as these arrangements do not harm the dissuasive effect of the type-approval authority’s own in-service conformity check on non-compliance with the requirements of Section 3 of this Annex. Data collected by Member States during surveillance testing programmes may be used for in-service conformity checks. Upon request, type-approval authorities shall provide data on the audits and random in-service conformity checks performed, including the methodology used for identifying those cases, which are made subject to the random in-service conformity check, to the Commission and other type-approval authorities.

3.1.3. Non-compliance with the requirements of paragraph 7.1.6. of Appendix 1 to Annex 11 to Regulation No 83 established by tests described in point 3.1.2 of this Appendix or paragraph 7.1.9 of Appendix 1 to Annex 11 to Regulation No 83 shall be considered as an infringement subject to the penalties set out in Article 13 of Regulation (EC) No 715/2007. This reference does not limit the application of such penalties to other infringements of other provisions of Regulation (EC) No 715/2007 or this Regulation, which do not explicitly refer to Article 13 of Regulation (EC) No 715/2007.

3.1.4. Paragraph 7.6.1. of Appendix 1 to Annex 11 of UN/ECE Regulation No 83 shall be replaced with the following:

‘7.6.1. The OBD system shall report, in accordance with the standard listed in paragraph 6.5.3.2.(a) of this Appendix, the ignition cycle counter and general denominator as well as separate numerators and denominators for the following monitors, if their presence on the vehicle is required by this Annex:

(a) Catalysts (each bank to be reported separately);

(b) Oxygen/exhaust gas sensors, including secondary oxygen sensors

(each sensor to be reported separately);

▼ M3

- (c) Evaporative system;
- (d) EGR system;
- (e) VVT system;
- (f) Secondary air system;
- (g) Particulate trap/filter;
- (h) NO_x after-treatment system (e.g. NO_x absorber, NO_x reagent/catalyst system);
- (i) Boost pressure control system.’

3.1.5. Paragraph 7.6.2. of Appendix 1 to Annex 11 of UN/ECE Regulation No 83 shall be understood as follows:

‘7.6.2. For specific components or systems that have multiple monitors, which are required to be reported by this point (e.g. oxygen sensor bank 1 may have multiple monitors for sensor response or other sensor characteristics), the OBD system shall separately track numerators and denominators for each of the specific monitors and report only the corresponding numerator and denominator for the specific monitor that has the lowest numerical ratio. If two or more specific monitors have identical ratios, the corresponding numerator and denominator for the specific monitor that has the highest denominator shall be reported for the specific component.’

3.1.6. In addition to the requirements of paragraph 7.6.2. of Appendix 1 to Annex 11 of UN/ECE Regulation No 83 the following shall apply:

‘Numerators and denominators for specific monitors of components or systems, that are monitoring continuously for short circuit or open circuit failures are exempted from reporting.

‘Continuously,’ if used in this context means monitoring is always enabled and sampling of the signal used for monitoring occurs at a rate no less than two samples per second and the presence or the absence of the failure relevant to that monitor has to be concluded within 15 seconds.

If for control purposes, a computer input component is sampled less frequently, the signal of the component may instead be evaluated each time sampling occurs.

It is not required to activate an output component/system for the sole purpose of monitoring that output component/system.’

▼ **M3**

Appendix 2

ESSENTIAL CHARACTERISTICS OF THE VEHICLE FAMILY

The essential characteristics of the vehicle family shall be those specified in Appendix 2 to Annex 11 to UN/ECE Regulation No 83.

▼B*ANNEX XII***▼M3****TYPE-APPROVAL OF VEHICLES FITTED WITH ECO-INNOVATIONS AND DETERMINATION OF CO₂ EMISSIONS AND FUEL CONSUMPTION FROM VEHICLES SUBMITTED TO MULTI-STAGE TYPE-APPROVAL OR INDIVIDUAL VEHICLE APPROVAL****▼B****1. TYPE-APPROVAL OF VEHICLES FITTED WITH ECO-INNOVATIONS**

- 1.1. According to Article 11(1) of Regulation (EU) No 725/2011 for M1 vehicles and Article 11(1) of Regulation (EU) No 427/2014 for N1 vehicles, a manufacturer wishing to benefit from a reduction of its average specific CO₂ emissions, as result of the savings achieved by one or more eco-innovations fitted in a vehicle, shall apply to an approval authority for an EC type-approval certificate of the vehicle fitted with the eco-innovation.
- 1.2. The CO₂ emissions savings from the vehicle fitted with an eco-innovation shall, for the purpose of type approval, be determined using the procedure and testing methodology specified in the Commission Decision approving the eco-innovation, in accordance with Article 10 of Regulation (EU) No 725/2011 for M1 vehicles, or Article 10 of Regulation (EU) No 427/2014 for N1 vehicles.
- 1.3. The performance of the necessary tests for the determination of the CO₂ emissions savings achieved by the eco-innovations shall be considered without prejudice to the demonstration of compliance of the eco-innovations with the technical prescriptions laid down in Directive 2007/46/EC, if applicable.

▼M3**2. DETERMINATION OF CO₂ EMISSIONS AND FUEL CONSUMPTION FROM VEHICLES SUBMITTED TO MULTI-STAGE TYPE-APPROVAL OR INDIVIDUAL VEHICLE APPROVAL**

- 2.1. For the purpose of determining the CO₂ emissions and fuel consumption of a vehicle submitted to multi-stage type-approval, as defined in Article 3(7) of Directive 2007/46/EC, the procedures of Annex XXI apply. However, at the choice of the manufacturer and irrespective of the technically permissible maximum laden mass, the alternative described in paragraphs 2.2. to 2.6. may be used where the base vehicle is incomplete.
- 2.2. A road load matrix family, as defined in paragraph 5.8. of Annex XXI, shall be established based on the parameters of a representative multi-stage vehicle in accordance with paragraph 4.2.1.4. of Sub-Annex 4 to Annex XXI.
- 2.3. The manufacturer of the base vehicle shall calculate the road load coefficients of vehicle H_M and L_M of a road load matrix family as set out in paragraph 5. of Sub-Annex 4 to Annex XXI and shall determine the CO₂ emission and fuel consumption in a Type 1 test of both vehicles. The manufacturer of the base vehicle shall make available a calculation tool to establish, on the basis of the parameters of completed vehicles, the final fuel consumption and CO₂ values as specified in Sub-Annex 7 to Annex XXI.

▼ M3

- 2.4. The calculation of road load and running resistance for an individual multi stage vehicle shall be performed in accordance with paragraph 5.1. of Sub-Annex 4 of Annex XXI.
- 2.5. The final fuel consumption and CO₂ values shall be calculated by the final-stage manufacturer on the basis of the parameters of the completed vehicle as specified in paragraph 3.2.4. of Sub-Annex 7 of Annex XXI and using the tool supplied by the manufacturer of the base vehicle.
- 2.6. The manufacturer of the completed vehicle shall include, in the certificate of conformity, the information of the completed vehicles and add the information of the base vehicles in accordance with Annex IX to Directive 2007/46/EC.
- 2.7. In the case of multi stage vehicles submitted to individual vehicle approval, the individual approval certificate shall include the following information:
 - (a) the CO₂ emissions measured in accordance with the methodology set out in points 2.1 to 2.6.;
 - (b) the mass of the completed vehicle in running order;
 - (c) the identification code corresponding to the type, variant and version of the base vehicle;
 - (d) the type-approval number of the base vehicle, including the extension number;
 - (e) the name and address of the manufacturer of the base vehicle;
 - (f) the mass of the base vehicle in running order.
- 2.8. In the case of multi stage type approvals or individual vehicle approval where the base vehicle is a complete vehicle with a valid certificate of conformity, the final stage manufacturer shall consult the base vehicle manufacturer to set the new CO₂ value in accordance with the CO₂ interpolation using the appropriate data from the completed vehicle or calculate the new CO₂ value on the basis of the parameters of the completed vehicle as specified in paragraph 3.2.4. of Sub-Annex 7 of Annex XXI and using the tool supplied by the manufacturer of the base vehicle as mentioned in paragraph 2.3. above. If the tool is not available or the CO₂ interpolation is not possible, the CO₂ value of Vehicle High from the base vehicle shall be used with the agreement of the approval authority.



ANNEX XIII

EC TYPE-APPROVAL OF REPLACEMENT POLLUTION CONTROL DEVICES AS SEPARATE TECHNICAL UNIT

1. INTRODUCTION

- 1.1. This Annex contains additional requirement for the type-approval as separate technical units of pollution control devices.

2. GENERAL REQUIREMENTS

2.1. **Marking**

Original replacement pollution control devices shall bear at least the following identifications:

- (a) the vehicle manufacturer's name or trade mark;
- (b) the make and identifying part number of the original replacement pollution control device as recorded in the information mentioned in point 2.3.

2.2. **Documentation**

Original replacement pollution control devices shall be accompanied by the following information:

- (a) the vehicle manufacturer's name or trade mark;
- (b) the make and identifying part number of the original replacement pollution control device as recorded in the information mentioned in point 2.3;
- (c) the vehicles for which the original replacement pollution control device is of a type covered by point 2.3 of the Addendum to Appendix 4 to Annex I, including, where applicable, a marking to identify if the original replacement pollution control device is suitable for fitting to a vehicle that is equipped with an on-board diagnostic (OBD) system;
- (d) installation instructions, where necessary.

This information shall be available in the product catalogue distributed to points of sale by the vehicle manufacturer.

- 2.3. The vehicle manufacturer shall provide to the technical service and/or approval authority the necessary information in electronic format which makes the link between the relevant part numbers and the type-approval documentation.

This information shall contain the following:

- (a) make(s) and type(s) of vehicle,
- (b) make(s) and type(s) of original replacement pollution control device,
- (c) part number(s) of original replacement pollution control device,

▼B

(d) type-approval number of the relevant vehicle type(s).

3. EC SEPARATE TECHNICAL UNIT TYPE-APPROVAL MARK

- 3.1. Every replacement pollution control device conforming to the type approved under this Regulation as a separate technical unit shall bear an EC type-approval mark.
- 3.2. This mark shall consist of a rectangle surrounding the lower-case letter 'e' followed by the distinguishing number of the Member State which has granted the EC type-approval in accordance with the numbering system set out in Annex VII to Directive 2007/46/EC.

The EC type- approval mark shall also include in the vicinity of the rectangle the 'base approval number' contained in section 4 of the type-approval number referred to in Annex VII to Directive 2007/46/EC, preceded by the two figures indicating the sequence number assigned to the latest major technical amendment to Regulation (EC) No 715/2007 or this Regulation on the date EC type-approval for a separate technical unit was granted. For this Regulation, the sequence number is 00.

- 3.3. The EC type-approval mark shall be affixed to the replacement pollution control device in such a way as to be clearly legible and indelible. It shall, wherever possible, be visible when the replacement pollution control device is installed on the vehicle.
- 3.4. Appendix 3 to this Annex gives example of the EC type- approval mark.

4. TECHNICAL REQUIREMENTS

- 4.1. The requirements for the type-approval of replacement pollution control devices shall be those of Section 5 of UN/ECE Regulation No 103 with the exceptions set out in sections 4.1.1 to 4.1.5.
- 4.1.1. Reference to the 'test cycle' in Section 5 of UN/ECE Regulation No 103 shall be understood as being the same Type I / Type 1 test and Type I / Type 1 test cycle as used for the original type approval of the vehicle.
- 4.1.2. The terms 'catalytic converter' and 'converter' used in section 5 of UN/ECE Regulation No 103 shall be understood to mean 'pollution control device'
- 4.1.3. The regulated pollutants referred to throughout section 5.2.3 of UN/ECE Regulation No 103 shall be replaced by all the pollutants specified in Annex 1, Table 2 of Regulation (EC) No 715/2007 for replacement pollution control devices intended to be fitted to vehicles type approved to Regulation (EC) No 715/2007.
- 4.1.4. For replacement pollution control devices standards intended to be fitted to vehicles type approved to Regulation (EC) No 715/2007, the durability requirements and associated deterioration factors specified in section 5 of UN/ECE Regulation No 103, shall refer to those specified in Annex VII of this Regulation.

▼B

- 4.1.5. Reference to Appendix 1 of the type-approval communication in section 5.5.3 of UN/ECE Regulation No 103 shall be understood as reference to the addendum to the EC type-approval certificate on vehicle OBD information (Appendix 5 to Annex I).
- 4.2. For vehicles with positive-ignition engines, if the NMHC emissions measured during the demonstration test of a new original equipment catalytic converter, under paragraph 5.2.1 of UN/ECE Regulation No 103, are higher than the values measured during the type-approval of the vehicle, the difference shall be added to the OBD threshold limits. The OBD threshold limits are specified in point 2.3 of Annex XI of this Regulation.
- 4.3. The revised OBD threshold limits will apply during the tests of OBD compatibility set out in paragraphs 5.5 to 5.5.5 of UN/ECE Regulation No 103. In particular, when the exceedance allowed in paragraph 1 of Appendix 1 to Annex 11 to UN/ECE Regulation No 83 is applied.
- 4.4. Requirements for replacement periodically regenerating systems**
- 4.4.1. *Requirements regarding emissions*
- 4.4.1.1. The vehicle(s) indicated in Article 11(3), equipped with a replacement periodically regenerating system of the type for which approval is requested, shall be subject to the tests described in paragraph 3 of Annex 13 of UN/ECE Regulation No 83, in order to compare its performance with the same vehicle equipped with the original periodically regenerating system.
- 4.4.1.2. Reference to the ‘Type I test’ and ‘Type I test cycle’ in paragraph 3. of Annex 13 of UN/ECE Regulation No 83 and the ‘test cycle’ in Section 5 of UN/ECE Regulation No 103 shall be understood as being the same Type I / Type 1 test and Type I / Type 1 test cycle as used for the original type approval of the vehicle.
- 4.4.2. *Determination of the basis for comparison*
- 4.4.2.1. The vehicle shall be fitted with a new original periodically regenerating system. The emissions performance of this system shall be determined following the test procedure set out in paragraph 3 of Annex 13 of UN/ECE Regulation No 83.
- 4.4.2.1.1. Reference to the ‘Type I test’ and ‘Type I test cycle’ in paragraph 3. of Annex 13 of UN/ECE Regulation No 83 and the ‘test cycle’ in Section 5 of UN/ECE Regulation No 103 shall be understood as being the same Type I / Type 1 test and Type I / Type 1 test cycle as used for the original type approval of the vehicle.
- 4.4.2.2. Upon request of the applicant for the approval of the replacement component, the approval authority shall make available on a non-discriminatory basis, the information referred to in points 3.2.12.2.1.11.1 and 3.2.12.2.6.4.1 of the information document contained in Appendix 3 to Annex I to this Regulation for each vehicle tested.
- 4.4.3. *Exhaust gas test with a replacement periodically regeneration system*
- 4.4.3.1. The original equipment periodically regenerating system of the test vehicle(s) shall be replaced by the replacement periodically regenerating system. The emissions performance of this system shall be determined following the test procedure set out in paragraph 3 Annex 13 of UN/ECE Regulation No 83.

▼B

4.4.3.1.1. Reference to the ‘Type I test’ and ‘Type I test cycle’ in paragraph 3. of Annex 13 of UN/ECE Regulation No 83 and the ‘test cycle’ in Section 5 of UN/ECE Regulation No 103 shall be understood as being the same Type I / Type 1 test and Type I / Type 1 test cycle as used for the original type approval of the vehicle.

4.4.3.2. To determine the D-factor of the replacement periodically regenerating system, any of the engine test bench methods referred to in paragraph 3 of Annex 13 of UN/ECE Regulation No 83 may be used.

4.4.4. *Other requirements*

The requirements of paragraphs 5.2.3, 5.3, 5.4 and 5.5 of UN/ECE Regulation No 103 shall apply to replacement periodically regenerating systems. In these paragraphs the words ‘catalytic converter’ shall be understood to mean ‘periodically regenerating system’. In addition the exceptions made to these paragraphs in section 4.1 of this annex shall also apply to periodically regenerating systems.

5. DOCUMENTATION

5.1. Each replacement pollution control device shall be clearly and indelibly marked with the manufacturer’s name or trade mark and accompanied by the following information:

(a) the vehicles (including year of manufacture) for which the replacement pollution control device is approved, including, where applicable, a marking to identify if the replacement pollution control device is suitable for fitting to a vehicle that is equipped with an on-board diagnostic (OBD) system;

(b) installation instructions, where necessary.

The information shall be available in the product catalogue distributed to points of sale by the manufacturer of replacement pollution control devices.

6. CONFORMITY OF PRODUCTION

6.1. Measures to ensure the conformity of production shall be taken in accordance with the provisions laid down in Article 12 of Directive 2007/46/EC.

6.2. **Special provisions**

6.2.1. The checks referred to in point 2.2 of Annex X to Directive 2007/46/EC shall include compliance with the characteristics as defined under point 8 of Article 2 of this Regulation.

6.2.2. For the application of Article 12(2) of Directive 2007/46/EC, the tests described in section 4.4.1 of this Annex and section 5.2 of UN/ECE Regulation No 103 (requirements regarding emissions) may be carried out. In this case, the holder of the approval may request, as an alternative, to use as a basis for comparison not the original equipment pollution control device, but the replacement pollution control device which was used during the type-approval tests (or another sample that has been proven to conform to the approved type). Emissions values measured with the sample under verification shall then on average not exceed by more than 15 % the mean values measured with the sample used for reference.

*Appendix 1***MODEL****Information document No ...****relating to the EC type-approval of replacement pollution control devices**

The following information, if applicable, must be supplied in triplicate and include a list of contents. Any drawings must be supplied in appropriate scale and sufficient detail on size A4 or on a folder of A4 format. Photographs, if any, must show sufficient detail.

If the systems, components or separate technical units have electronic controls, information concerning their performance must be supplied.

0. GENERAL
 - 0.1. Make (trade name of manufacturer): ...
 - 0.2. Type: ...
 - 0.2.1. Commercial name(s), if available: ...
 - 0.5. Name and address of manufacturer: ...
Name and address of authorised representative, if any: ...
 - 0.7. In the case of components and separate technical units, location and method of affixing of the EC approval mark: ...
 - 0.8. Address(es) of assembly plant(s): ...
1. DESCRIPTION OF THE DEVICE
 - 1.1. Make and type of the replacement pollution control device: ...
 - 1.2. Drawings of the replacement pollution control device, identifying in particular all the characteristics referred to under point 8 of Article 2 of this Regulation: ...
 - 1.3. Description of the vehicle type or types for which the replacement pollution control device is intended: ...
 - 1.3.1. Number(s) and/or symbol(s) characterising the engine and vehicle type(s): ...
 - 1.3.2. Is the replacement pollution control device intended to be compatible with OBD requirements (Yes/No) ⁽¹⁾
 - 1.4. Description and drawings showing the position of the replacement pollution control device relative to the engine exhaust manifold(s): ...

⁽¹⁾ Delete where not applicable.



Appendix 2

MODEL EC TYPE-APPROVAL CERTIFICATE

(Maximum format: A4 (210 mm × 297 mm))

EC TYPE-APPROVAL CERTIFICATE

Stamp of administration

Communication concerning the:

- EC type-approval ⁽¹⁾, ...,
- extension of EC type-approval ⁽²⁾, ...,
- refusal of EC type-approval ⁽³⁾, ...,
- withdrawal of EC type-approval ⁽⁴⁾, ...,

of a type of component/separate technical unit ⁽⁵⁾

with regard to Regulation (EC) No 715/2007, as implemented by Regulation (EU) 2017/1151.

Regulation (EC) No 715/2007 or Regulation (EU) 2017/1151 as last amended by ...

EC type-approval number: ...

Reason for extension: ...

SECTION I

- 0.1. Make (trade name of manufacturer): ...
- 0.2. Type: ...
- 0.3. Means of identification of type if marked on the component/separate technical unit ⁽⁶⁾: ...
 - 0.3.1. Location of that marking: ...
- 0.5. Name and address of manufacturer: ...
- 0.7. In the case of components and separate technical units, location and method of affixing of the EC approval mark: ...
- 0.8. Name and address(es) of assembly plant(s): ...
- 0.9. Name and address of manufacturer's representative (if any): ...

⁽¹⁾ Delete where not applicable

⁽²⁾ Delete where not applicable

⁽³⁾ Delete where not applicable

⁽⁴⁾ Delete where not applicable

⁽⁵⁾ Delete where not applicable

⁽⁶⁾ If the means of identification of type contains characters not relevant to describe the vehicle, component or separate technical unit types covered by this type-approval certificate such characters shall be represented in the document by the symbol: '?' (e.g. ABC??123??).

▼B*SECTION II*

1. Additional information
 - 1.1. Make and type of the replacement pollution control device: ...
 - 1.2. Vehicle type(s) for which the pollution control device type qualifies as replacement part: ...
 - 1.3. Type(s) of vehicle(s) on which the replacement pollution control device has been tested: ...
 - 1.3.1. Has the replacement pollution control device demonstrated compatibility with OBD requirements (yes/no) ⁽¹⁾: ...
2. Technical service responsible for carrying out the tests: ...
3. Date of test report: ...
4. Number of test report: ...
5. Remarks: ...
6. Place: ...
7. Date: ...
8. Signature: ...

<i>Attachments:</i>	Information package.
---------------------	----------------------

⁽¹⁾ Delete where not applicable

▼B

Appendix 3

Example of the EC type-approval marks

(see point 3.2 of this Annex)

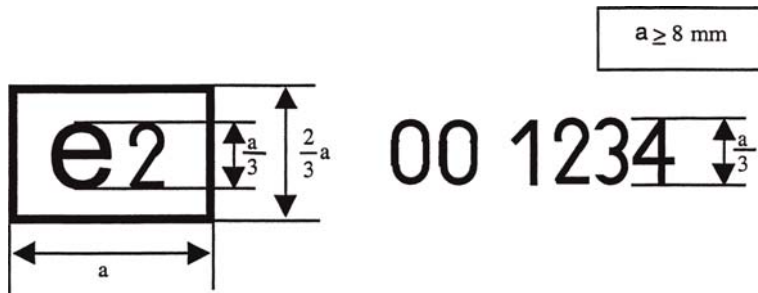

The above approval mark affixed to a component of a replacement pollution control device shows that the type concerned has been approved in France (e 2), pursuant to this Regulation. The first two digits of the approval number (00) indicate that this part was approved according to this Regulation. The following four digits (1234) are those allocated by the approval authority to the replacement pollution control device as the base approval number.

*ANNEX XIV***Access to vehicle OBD and vehicle repair and maintenance information**

1. INTRODUCTION

- 1.1. This Annex lays down technical requirements for the accessibility of vehicle OBD and vehicle repair and maintenance information.

2. REQUIREMENTS

- 2.1. Vehicle OBD and vehicle repair and maintenance information available through websites shall follow the technical specifications of OASIS Document SC2-D5, Format of Automotive Repair Information, version 1.0, 28 May 2003 ⁽¹⁾ and of Sections 3.2, 3.5, (excluding 3.5.2), 3.6, 3.7 and 3.8 of OASIS Document SC1-D2, Autorepair Requirements Specification, version 6.1, dated 10.1.2003 ⁽²⁾, using only open text and graphic formats or formats which can be viewed and printed using only standard software plug-ins that are freely available, easy to install, and which run under computer operating systems commonly in use. Where possible, keywords in the meta data shall conform to ISO 15031-2. Such information shall be always available, except as required for web-site maintenance purposes. Those requiring the right to duplicate or re-publish the information should negotiate directly with the manufacturer concerned. Information for training material shall also be available, but may be presented through other media than web-sites.

Information on all parts of the vehicle, with which the vehicle, as identified by the vehicle identification number (VIN) and any additional criteria such as wheelbase, engine output, trim level or options, is equipped by the vehicle manufacturer and which can be replaced by spare parts offered by the vehicle manufacturer to its authorised repairers or dealers or third parties by means of reference to original equipment (OE) parts number, shall be made available in a database easily accessible to independent operators.

This database shall comprise the VIN, OE parts numbers, OE naming of the parts, validity attributes (valid-from and valid-to dates), fitting attributes and where applicable structuring characteristics.

The information on the database shall be regularly updated. The updates shall include in particular all modifications to individual vehicles after their production if this information is available to authorised dealers.

- 2.2. Access to vehicle security features used by authorised dealers and repair shops shall be made available to independent operators under protection of security technology according to the following requirements:

(i) data shall be exchanged ensuring confidentiality, integrity and protection against replay;

(ii) the standard [https/ssl-tls](https://ssl-tls) (RFC4346) shall be used;

⁽¹⁾ Available at: <http://www.oasis-open.org/committees/download.php/2412/Draft%20Committee%20Specification.pdf>

⁽²⁾ Available at: <http://lists.oasis-open.org/archives/autorepair/200302/pdf00005.pdf>

▼B

- (iii) security certificates in accordance with ISO 20828 shall be used for mutual authentication of independent operators and manufacturers;
- (iv) the independent operator's private key shall be protected by secure hardware.

The Forum on Access to Vehicle Information provided for by paragraph 9 of Article 13 will specify the parameters for fulfilling these requirements according to the state-of-the-art.

The independent operator shall be approved and authorised for this purpose on the basis of documents demonstrating that they pursue a legitimate business activity and have not been convicted of relevant criminal activity.

- 2.3. Reprogramming of control units shall be conducted in accordance with either ISO 22900 or SAE J2534, regardless of the date of type approval. For the validation of the compatibility of the manufacturer-specific application and the vehicle communication interfaces (VCI) complying to ISO 22900 or SAE J2534, the manufacturer shall offer either a validation of independently developed VCIs or the information, and loan of any special hardware, required for a VCI manufacturer to conduct such validation himself. The conditions of Article 7(1) of Regulation (EC) No 715/2007 apply to fees for such validation or information and hardware.
- 2.4. All emission-related fault codes shall be consistent with Appendix 1 to Annex XI.
- 2.5. For access to any vehicle OBD and vehicle repair and maintenance information other than that relating to secure areas of the vehicle, registration requirements for use of the manufacturer's web site by an independent operator shall require only such information as is necessary to confirm how payment for the information is to be made. For information concerning access to secure areas of the vehicle, the independent operator shall present a certificate in accordance with ISO 20828 to identify himself and the organisation to which he belongs and the manufacturer shall respond with his own certificate in accordance with ISO 20828 to confirm to the independent operator that he is accessing a legitimate site of the intended manufacturer. Both parties shall keep a log of any such transactions indicating the vehicles and changes made to them under this provision.
- 2.6. In the event that vehicle OBD and vehicle repair and maintenance information available on a manufacturer's website does not contain specific relevant information to permit the proper design and manufacture of alternative fuels retrofit systems, then any interested alternative fuels retrofit system manufacturer shall be able to access the information required in paragraphs 0, 2, and 3 of Appendix 3 to Annex I by contacting the manufacturer directly with such a request. Contact details for that purpose shall be clearly indicated on the manufacturer's website and the information shall be provided within 30 days. Such information need only be provided for alternative fuels retrofit systems that are subject to UN/ECE Regulation No 115 ⁽¹⁾ or for alternative fuels retrofit components that form part of systems subject to UN/ECE Regulation No 115, and need only be provided in response to a request that clearly specifies the exact specification of the vehicle model for which the information is required and that

⁽¹⁾ OJ L 323, 7.11.2014, p. 91.

▼B

specifically confirms that the information is required for the development of alternative fuels retrofit systems or components subject to UN/ECE Regulation No 115.

- 2.7. Manufacturers shall indicate in their repair information websites the type-approval number by model.
- 2.8. Manufacturers shall establish fees for hourly, daily, monthly, annual and per-transaction access to their repair and maintenance information websites, which are reasonable and proportionate.



Appendix 1

Manufacturer's Certificate on Access to Vehicle OBD and Vehicle Repair and Maintenance Information

(Manufacturer) :

(Address of the manufacturer) :

Certifies that

it provides access to vehicle OBD and vehicle repair and maintenance information in compliance with the provisions of:

- Article 6 of Regulation (EC) No 715/2007;
- Articles 4(6) and 13 of Implementing Regulation (EU) 2017/1151;
- ►⁽¹⁾ Annex I, section 2.3.1 and 2.3.4 of Regulation (EU) 2017/1151 ◄;
- Annex I, Appendix 3, section 16 of Implementing Regulation (EU) 2017/1151;
- Annex I, Appendix 5 of Implementing Regulation (EU) 2017/1151;
- Annex XI, section 4 of Implementing Regulation (EU) 2017/1151; and
- Annex XIV of Implementing Regulation (EU) 2017/1151

with respect to the vehicle types listed in attachment to this Certificate.

The principal website address through which the relevant information may be accessed and which are hereby certified to be in compliance with the above provisions are listed in an attachment to this Certificate along with the contact details of the responsible manufacturer's representative whose signature is below.

Where applicable: The manufacturer hereby also certifies that it has complied with the obligation in Article 13(5) of this Regulation to provide the relevant information for previous approvals of these vehicle types no later than 6 months after the date of type-approval.

Done at [..... Place]

On [..... Date]

[Signature of the Manufacturer's Representative]

Annexes: Website Addresses

Contact Details

► ⁽¹⁾ **M3**

▼B

Annex I

to

Manufacturer's Certificate on Access to Vehicle OBD and Vehicle Repair and Maintenance Information

Website addresses referred to by this Certificate:

.....

.....

.....

.....

Annex II

to

Manufacturer's Certificate on Access to Vehicle OBD and Vehicle Repair and Maintenance Information

Contact details of the manufacturer's representative referred to by this Certificate:

.....

.....

.....

.....

▼B

ANNEX XV

Reserved

▼ **M3***ANNEX XVI***REQUIREMENTS FOR VEHICLES THAT USE A REAGENT FOR THE EXHAUST AFTER-TREATMENT SYSTEM**

1. Introduction

This Annex sets out the requirements for vehicles that rely on the use of a reagent for the after-treatment system in order to reduce emissions. Every reference in this Annex to 'reagent tank' shall be understood as also applying to other containers in which a reagent is stored.

- 1.1. The capacity of the reagent tank shall be such that a full reagent tank does not need to be replenished over an average driving range of 5 full fuel tanks providing the reagent tank can be easily replenished (e.g. without the use of tools and without removing vehicle interior trim. The opening of an interior flap, in order to gain access for the purpose of reagent replenishment, shall not be understood as the removal of interior trim). If the reagent tank is not considered to be easy to replenish as described above, the minimum reagent tank capacity shall be at least equivalent to an average driving distance of 15 full fuel tanks. However, in the case of the option in paragraph 3.5., where the manufacturer chooses to start the warning system at a distance which may not be less than 2 400 km before the reagent tank becomes empty, the above restrictions on a minimum reagent tank capacity shall not apply.

- 1.2. In the context of this Annex, the term 'average driving distance' shall be taken to be derived from the fuel or reagent consumption during a Type 1 test for the driving distance of a fuel tank and the driving distance of a reagent tank respectively.

2. Reagent indication

- 2.1. The vehicle shall include a specific indicator on the dashboard that informs the driver when reagent levels are below the threshold values specified in paragraph 3.5.

3. Driver warning system

- 3.1. The vehicle shall include a warning system consisting of visual alarms that informs the driver when an abnormality is detected in the reagent dosing, e.g. when emissions are too high, the reagent level is low, reagent dosing is interrupted, or the reagent is not of a quality specified by the manufacturer. The warning system may also include an audible component to alert the driver.

- 3.2. The warning system shall escalate in intensity as the reagent approaches empty. It shall culminate in a driver notification that cannot be easily defeated or ignored. It shall not be possible to turn off the system until the reagent has been replenished.

- 3.3. The visual warning shall display a message indicating a low level of reagent. The warning shall not be the same as the warning used for the purposes of OBD or other engine maintenance. The warning shall be sufficiently clear for the driver to understand that the reagent level is low (e.g. 'urea level low', 'AdBlue level low', or 'reagent low').

- 3.4. The warning system does not initially need to be continuously activated, however the warning shall escalate so that it becomes continuous as the level of the reagent approaches the point where the driver inducement system in paragraph 8. comes into effect. An explicit warning shall be

▼ M3

displayed (e.g. 'fill up urea', 'fill up AdBlue', or 'fill up reagent'). The continuous warning system may be temporarily interrupted by other warning signals providing that they are important safety related messages.

3.5. The warning system shall activate at a distance equivalent to a driving range of at least 2 400 km in advance of the reagent tank becoming empty, or at the choice of the manufacturer at the latest when the level of reagent in the tank reaches one of the following levels:

(a) a level expected to be sufficient for driving 150 % of an average driving range with a complete tank of fuel; or

(b) 10 % of the capacity of the reagent tank,

whichever occurs earlier.

4. Identification of incorrect reagent

4.1. The vehicle shall include a means of determining that a reagent corresponding to the characteristics declared by the manufacturer and recorded in Appendix 3 to Annex 1 is present on the vehicle.

4.2. If the reagent in the storage tank does not correspond to the minimum requirements declared by the manufacturer the driver warning system in paragraph 3. shall be activated and shall display a message indicating an appropriate warning (e.g. 'incorrect urea detected', 'incorrect AdBlue detected', or 'incorrect reagent detected'). If the reagent quality is not rectified within 50 km of the activation of the warning system then the driver inducement requirements of paragraph 8. shall apply.

5. Reagent consumption monitoring

5.1. The vehicle shall include a means of determining reagent consumption and providing off-board access to consumption information.

5.2. Average reagent consumption and average demanded reagent consumption by the engine system shall be available via the serial port of the standard diagnostic connector. Data shall be available over the previous complete 2 400 km period of vehicle operation.

5.3. In order to monitor reagent consumption, at least the following parameters within the vehicle shall be monitored:

(a) The level of reagent in the on-vehicle storage tank; and

(b) The flow of reagent or injection of reagent as close as technically possible to the point of injection into an exhaust after-treatment system.

5.4. A deviation of more than 50 % between the average reagent consumption and the average demanded reagent consumption by the engine system over a period of 30 minutes of vehicle operation, shall result in the activation of the driver warning system in paragraph 3., which shall display a message indicating an appropriate warning (e.g. 'urea dosing malfunction', 'AdBlue dosing malfunction', or 'reagent dosing malfunction'). If the reagent consumption is not rectified within 50 km of the activation of the warning system then the driver inducement requirements of paragraph 8. shall apply.

▼ **M3**

- 5.5. In the case of interruption in reagent dosing activity the driver warning system as referred to in paragraph 3. shall be activated, which shall display a message indicating an appropriate warning. Where the reagent dosing interruption is initiated by the engine system because the vehicle operating conditions are such that the vehicle's emission performance does not require reagent dosing, the activation of the driver warning system as referred to in paragraph 3. may be omitted, provided that the manufacturer has clearly informed the approval authority when such operating conditions apply. If the reagent dosing is not rectified within 50 km of the activation of the warning system then the driver inducement requirements of paragraph 8. shall apply.
6. Monitoring NO_x emissions
- 6.1. As an alternative to the monitoring requirements referred to in paragraphs 4. and 5., manufacturers may use exhaust gas sensors directly to sense excess NO_x levels in the exhaust.
- 6.2. The manufacturer shall demonstrate that use of the sensors referred to in paragraph 6.1. above and any other sensors on the vehicle, results in the activation of the driver warning system as referred to in paragraph 3. above, the display of a message indicating an appropriate warning (e.g. 'emissions too high — check urea', 'emissions too high — check AdBlue', 'emissions too high — check reagent'), and the activation of the driver inducement system as referred to in paragraph 8.3., when the situations referred to in paragraphs 4.2., 5.4., or 5.5. occur.

For the purposes of this paragraph these situations are presumed to occur if the applicable NO_x OBD threshold limit of the tables set out in paragraph 2.3. of Annex XI is exceeded.

NO_x emissions during the test to demonstrate compliance with these requirements shall be no more than 20 % higher than the OBD threshold limits.

7. Storage of failure information
- 7.1. Where reference is made to this paragraph, non-erasable Parameter Identifiers (PID) shall be stored identifying the reason for and the distance travelled by the vehicle during the inducement system activation. The vehicle shall retain a record of the PID for at least 800 days or 30 000 km of vehicle operation. The PID shall be made available via the serial port of a standard diagnostic connector upon request of a generic scan tool in accordance with the provisions of paragraph 2.3. of Appendix 1 to Annex XI. The information stored in the PID shall be linked to the period of cumulated vehicle operation, during which it has occurred, with an accuracy of not less than 300 days or 10 000 km.
- 7.2. Malfunctions in the reagent dosing system attributed to technical failures (e.g. mechanical or electrical faults) shall also be subject to the OBD requirements in Annex XI.
8. Driver inducement system
- 8.1. The vehicle shall include a driver inducement system to ensure that the vehicle operates with a functioning emissions control system at all times. The inducement system shall be designed so as to ensure that the vehicle cannot operate with an empty reagent tank.
- 8.2. The inducement system shall activate at the latest when the level of reagent in the tank reaches:
- (a) In the case that the warning system was activated at least 2 400 km before the reagent tank was expected to become empty, a level expected to be sufficient for driving the average driving range of the vehicle with a complete tank of fuel.

▼ **M3**

- (b) In the case that the warning system was activated at the level described in paragraph 3.5.(a), a level expected to be sufficient for driving 75 % of the average driving range of the vehicle with a complete tank of fuel; or
- (c) In the case that the warning system was activated at the level described in paragraph 3.5.(b), 5 % of the capacity of the reagent tank.
- (d) In the case that the warning system was activated ahead of the levels described in both paragraph 3.5.(a) and 3.5.(b) but less than 2 400 km in advance of the reagent tank becoming empty, whichever level described in (b) or (c) of this paragraph occurs earlier.

Where the alternative described in paragraph 6.1. is utilised, the system shall activate when the irregularities described in paragraphs 4. or 5. or the NO_x levels described in paragraph 6.2. have occurred.

The detection of an empty reagent tank and the irregularities mentioned in paragraphs 4., 5., or 6. shall result in the failure information storage requirements of paragraph 7. taking effect.

- 8.3. The manufacturer shall select which type of inducement system to install. The options for a system are described in paragraphs 8.3.1., 8.3.2., 8.3.3. and 8.3.4.
- 8.3.1. A ‘no engine restart after countdown’ approach allows a countdown of restarts or distance remaining once the inducement system activates. Engine starts initiated by the vehicle control system, such as start-stop systems, are not included in this countdown.
 - 8.3.1.1. In the case that the warning system was activated at least 2 400 km before the reagent tank was expected to become empty, or the irregularities described in paragraphs 4. or 5. or the NO_x levels described in paragraph 6.2. have occurred, engine restarts shall be prevented immediately after the vehicle has travelled a distance expected to be sufficient for driving the average driving range of the vehicle with a complete tank of fuel since the activation of the inducement system.
 - 8.3.1.2. In the case that the inducement system was activated at the level described in paragraph 8.2.(b), engine restarts shall be prevented immediately after the vehicle has travelled a distance expected to be sufficient for driving 75 % of the average driving range of the vehicle with a complete tank of fuel since the activation of the inducement system.
 - 8.3.1.3. In the case that the inducement system was activated at the level described in paragraph 8.2.(c), engine restarts shall be prevented immediately after the vehicle has travelled a distance expected to be sufficient for driving the average driving range of the vehicle with 5 % of the capacity of the reagent tank, since the activation of the inducement system.
 - 8.3.1.4. In addition, engine restarts shall be prevented immediately after the reagent tank becomes empty, should this situation occur earlier than the situations specified in paragraphs 8.3.1.1, 8.3.1.2., or 8.3.1.3.
- 8.3.2. A ‘no start after refuelling’ system results in a vehicle being unable to start after re-fuelling if the inducement system has activated.

▼ **M3**

- 8.3.3. A ‘fuel-lockout’ approach prevents the vehicle from being refuelled by locking the fuel filler system after the inducement system activates. The lockout system shall be robust to prevent it being tampered with.
- 8.3.4. A ‘performance restriction’ approach restricts the speed of the vehicle after the inducement system activates. The level of speed limitation shall be noticeable to the driver and significantly reduce the maximum speed of the vehicle. Such limitation shall enter into operation gradually or after an engine start. Shortly before engine restarts are prevented, the speed of the vehicle shall not exceed 50 km/h.
- 8.3.4.1. In the case that the warning system was activated at least 2 400 km before the reagent tank was expected to become empty, or the irregularities described in paragraphs 4. or 5. or the NO_x levels described in paragraph 6.2. have occurred, engine restarts shall be prevented immediately after the vehicle has travelled a distance expected to be sufficient for driving the average driving range of the vehicle with a complete tank of fuel since the activation of the inducement system.
- 8.3.4.2. In the case that the inducement system was activated at the level described in paragraph 8.2.(b), engine restarts shall be prevented immediately after the vehicle has travelled a distance expected to be sufficient for driving 75 % of the average driving range of the vehicle with a complete tank of fuel since the activation of the inducement system.
- 8.3.4.3. In the case that the inducement system was activated at the level described in paragraph 8.2.(c), engine restarts shall be prevented immediately after the vehicle has travelled a distance expected to be sufficient for driving the average driving range of the vehicle with 5 % of the capacity of the reagent tank, since the activation of the inducement system.
- 8.3.4.4. In addition, engine restarts shall be prevented immediately after the reagent tank becomes empty, should this situation occur earlier than the situations specified in paragraphs 8.3.4.1, 8.3.4.2. or 8.3.4.3.
- 8.4. Once the inducement system has prevented engine restarts, the inducement system shall only be deactivated if the irregularities specified in paragraphs 4., 5., or 6. have been rectified or if the quantity of reagent added to the vehicle meets at least one of the following criteria:
- (a) expected to be sufficient for driving 150 % of an average driving range with a complete tank of fuel; or
 - (b) at least 10 % of the capacity of the reagent tank.

After a repair has been carried out to correct a fault where the OBD system has been triggered under paragraph 7.2., the inducement system may be reinitialised via the OBD serial port (e.g. by a generic scan tool) to enable the vehicle to be restarted for self-diagnosis purposes. The vehicle shall operate for a maximum of 50 km to enable the success of the repair to be validated. The inducement system shall be fully reactivated if the fault persists after this validation.

- 8.5. The driver warning system referred to in paragraph 3. shall display a message indicating clearly:
- (a) The number of remaining restarts and/or the remaining distance; and

▼ M3

- (b) The conditions under which the vehicle can be restarted.
- 8.6. The driver inducement system shall be deactivated when the conditions for its activation have ceased to exist. The driver inducement system shall not be automatically deactivated without the reason for its activation having been remedied.
- 8.7. Detailed written information fully describing the functional operation characteristics of the driver inducement system shall be provided to the Type Approval Authority at the time of approval.
- 8.8. As part of the application for type approval under this Regulation, the manufacturer shall demonstrate the operation of the driver warning and inducement systems.
9. Information requirements
- 9.1. The manufacturer shall provide all owners of new vehicles with clear written information about the emission control system. This information shall state that if the vehicle emission control system is not functioning correctly, the driver shall be informed of a problem by the driver warning system and that the driver inducement system shall consequently result in the vehicle being unable to start.
- 9.2. The instructions shall indicate requirements for the proper use and maintenance of vehicles, including the proper use of consumable reagents.
- 9.3. The instructions shall specify if consumable reagents have to be replenished by the vehicle driver between normal maintenance intervals. They shall indicate how the vehicle driver should replenish the reagent tank. The information shall also indicate a likely rate of reagent consumption for that type of vehicle and how often it should be replenished.
- 9.4. The instructions shall specify that use of, and replenishing of, a required reagent of the correct specifications is mandatory for the vehicle to comply with the certificate of conformity issued for that vehicle type.
- 9.5. The instructions shall state that it may be a criminal offence to use a vehicle that does not consume any reagent if it is required for the reduction of emissions.
- 9.6. The instructions shall explain how the warning system and driver inducement systems work. In addition, the consequences of ignoring the warning system and not replenishing the reagent shall be explained.
10. Operating conditions of the after-treatment system
- Manufacturers shall ensure that the emission control system retains its emission control function during all ambient conditions, especially at low ambient temperatures. This includes taking measures to prevent the complete freezing of the reagent during parking times of up to 7 days at 258 K (– 15 °C) with the reagent tank 50 % full. If the reagent is frozen, the manufacturer shall ensure that the reagent shall be liquefied and ready for use within 20 minutes of the vehicle being started at 258 K (– 15 °C) measured inside the reagent tank.



ANNEX XVII

AMENDMENTS TO REGULATION (EC) No 692/2008

1. Appendix 3 to Annex I of Regulation (EC) No 692/2008 is hereby amended as follows:
 - (a) Points 3. to 3.1.1. shall be amended to read:

‘3. PROPULSION ENERGY CONVERTER (k)

3.1. Manufacturer of the propulsion energy converter(s):

3.1.1. Manufacturer's code (as marked on the propulsion energy converter or other means of identification):
 - (b) Point 3.2.1.8. shall be amended to read:

‘3.2.1.8. Rated engine power (n): kW at min⁻¹ (manufacturer's declared value)’
 - (c) Point 3.2.2.2. shall be renumbered 3.2.2.1.1. and shall read as follows:

‘3.2.2.1.1. RON, unleaded:
 - (d) Point 3.2.4.2.1. shall be amended to read:

‘3.2.4.2.1. System description (common rail/unit injectors/distribution pump etc.):
 - (e) Point 3.2.4.2.3. shall be amended to read:

‘3.2.4.2.3. Injection/Delivery pump’
 - (f) Point 3.2.4.2.4. shall be amended to read:

‘3.2.4.2.4. Engine speed limitation control’
 - (g) Point 3.2.4.2.9.3. shall be amended to read:

‘3.2.4.2.9.3. Description of the system’
 - (h) Points 3.2.4.2.9.3.6. to 3.2.4.2.9.3.8. shall be amended to read:

‘3.2.4.2.9.3.6. Make and type or working principle of water temperature sensor:

3.2.4.2.9.3.7. Make and type or working principle of air temperature sensor:

3.2.4.2.9.3.8. Make and type or working principle of air pressure sensor:
 - (i) Point 3.2.4.3.4.3. shall be amended to read:

‘3.2.4.3.4.3. Make and type or working principle of air-flow sensor:
 - (j) Points 3.2.4.3.4.9. to 3.2.4.3.4.11. shall be amended to read:

‘3.2.4.3.4.9. Make and type or working principle of water temperature sensor:

▼B

- 3.2.4.3.4.10. Make and type or working principle of air temperature sensor:
- 3.2.4.3.4.11. Make and type or working principle of air pressure sensor:
- (k) Point 3.2.4.3.5. shall be amended to read:
- ‘3.2.4.3.5. Injectors’
- (l) Points 3.2.12.2. to 3.2.12.2.1. shall be amended to read:
- ‘3.2.12.2. Pollution control devices (if not covered by another heading)
- 3.2.12.2.1. Catalytic converter’
- (m) Points 3.2.12.2.1.11. to 3.2.12.2.1.11.10 shall be deleted
- (n) Points 3.2.12.2.2. to 3.2.12.2.2.5. shall be deleted and replaced with the following:
- ‘3.2.12.2.2. Sensors
- 3.2.12.2.2.1. Oxygen sensor: yes/no ⁽¹⁾
- 3.2.12.2.2.1.1. Make:
- 3.2.12.2.2.1.2. Location:
- 3.2.12.2.2.1.3. Control range:
- 3.2.12.2.2.1.4. Type or working principle:
- 3.2.12.2.2.1.5. Identifying part number:
- (o) Points 3.2.12.2.4.1. to 3.2.12.2.4.2. shall be amended to read:
- ‘3.2.12.2.4.1. Characteristics (make, type, flow, high pressure / low pressure / combined pressure, etc.):
- 3.2.12.2.4.2. Water-cooled system (to be specified for each EGR system e.g. low pressure / high pressure / combined pressure: yes/no ⁽¹⁾)’
- (p) Points 3.2.12.2.5. to 3.2.12.2.5.6. shall be amended to read:
- ‘3.2.12.2.5. Evaporative emissions control system (petrol and ethanol engines only): yes/no ⁽¹⁾
- 3.2.12.2.5.1. Detailed description of the devices:
- 3.2.12.2.5.2. Drawing of the evaporative emissions control system:
- 3.2.12.2.5.3. Drawing of the carbon canister:
- 3.2.12.2.5.4. Mass of dry charcoal: g
- 3.2.12.2.5.5. Schematic drawing of the fuel tank with indication of capacity and material (petrol and ethanol engines only):
- 3.2.12.2.5.6. Description and schematic of the heat shield between tank and exhaust system:

▼B

- (q) Points 3.2.12.2.6.4. to 3.2.12.2.6.4.4. shall be deleted
- (r) Points 3.2.12.2.6.5. and 3.2.12.2.6.6. shall be renumbered to read:
- ‘3.2.12.2.6.4. Make of particulate trap:’
- 3.2.12.2.6.5. Identifying part number:’
- (s) Points 3.2.12.2.8. shall be amended to read:
- ‘3.2.12.2.8. Other system:’
- (t) New points 3.2.12.2.10. to 3.2.12.2.11.8. shall be added as follows:
- ‘3.2.12.2.10. Periodically regenerating system: (provide the information below for each separate unit)
- 3.2.12.2.10.1. Method or system of regeneration, description and/or drawing:
- 3.2.12.2.10.2. The number of Type 1 operating cycles, or equivalent engine test bench cycles, between two cycles where regenerative phases occur under the conditions equivalent to Type 1 test (Distance “D” in Figure A6.App1/1 in Appendix 1 to Sub-Annex 6 of Annex XXI to Regulation (EU) 2017/1151 or figure A13/1 in Annex 13 to UN/ECE Regulation 83 (as applicable)):
- 3.2.12.2.10.2.1. Applicable Type 1 cycle: (indicate the applicable procedure: Annex XXI, Sub-Annex 4 or UN/ECE Regulation 83): ...
- 3.2.12.2.10.3. Description of method employed to determine the number of cycles between two cycles where regenerative phases occur:
- 3.2.12.2.10.4. Parameters to determine the level of loading required before regeneration occurs (i.e. temperature, pressure etc.):
- 3.2.12.2.10.5. Description of method used to load system in the test procedure described in paragraph 3.1., Annex 13 to UN/ECE Regulation 83:
- 3.2.12.2.11. Catalytic converter systems using consumable reagents (provide the information below for each separate unit) yes/no ⁽¹⁾
- 3.2.12.2.11.1. Type and concentration of reagent needed:
- 3.2.12.2.11.2. Normal operational temperature range of reagent: ...
- 3.2.12.2.11.3. International standard:
- 3.2.12.2.11.4. Frequency of reagent refill: continuous/maintenance (where appropriate):

▼B

3.2.12.2.11.5. Reagent indicator: (description and location)

3.2.12.2.11.6. Reagent tank

3.2.12.2.11.6.1. Capacity: ...

3.2.12.2.11.6.2. Heating system: yes/no ⁽¹⁾

3.2.12.2.11.6.2.1. Description or drawing

3.2.12.2.11.7. Reagent control unit: yes/no ⁽¹⁾

3.2.12.2.11.7.1. Make: ...

3.2.12.2.11.7.2. Type: ...

3.2.12.2.11.8. Reagent injector (make, type and location): ...'

(u) Point 3.2.15.1. shall be amended to read:

'3.2.15.1. Type-approval number according to Regulation (EC) No 661/2009 (OJ L 200, 31.7.2009, p. 1)'

(v) Point 3.2.16.1. shall be amended to read:

'3.2.16.1. Type-approval number according to Regulation (EC) No 661/2009 (OJ L 200, 31.7.2009, p. 1)'

(w) Point 3.3. shall be amended to read:

'3.3. Electric machine'

(x) Point 3.3.2. shall be amended to read:

'3.3.2. REESS'

(y) Point 3.4. shall be amended to read:

'3.4. Combinations of propulsion energy converters'

(z) Point 3.4.4. shall be amended to read:

'3.4.4. Description of the energy storage device: (REESS, capacitor, flywheel/generator)'

(aa) Point 3.4.4.5. shall be amended to read:

'3.4.4.5. Energy: (for REESS: voltage and capacity Ah in 2 h, for capacitor: J,)'

(bb) Point 3.4.5. shall be amended to read:

'3.4.5. Electric machine (describe each type of electric machine separately)'

(cc) Point 3.5. shall be amended to read:

'3.5. Manufacturer's declared values for determination of CO₂ emissions/fuel consumption/electric consumption/electric range and details of eco-innovations (where applicable)^(o)'

(dd) Point 4.4. shall be amended to read:

'4.4. Clutch(es)'

▼B

(ee) Point 4.6. shall be amended to read:

‘4.6. Gear ratios

Gear	Internal gearbox ratios (ratios of engine to gearbox output shaft revolutions)	Final drive ratio(s) (ratio of gearbox output shaft to driven wheel revolutions)	Total gear ratios
Maximum for CVT			
1			
2			
3			
...			
Minimum for CVT’			

(ff) Point 6.6. to 6.6.3. shall be replaced as follows:

‘6.6. Tyres and wheels

6.6.1. Tyre/wheel combination(s)

6.6.1.1. Axles

6.6.1.1.1. Axle 1:

6.6.1.1.1.1. Tyre size designation

6.6.1.1.2. Axle 2:

6.6.1.1.2.1. Tyre size designation

etc.

6.6.2. Upper and lower limits of rolling radii

6.6.2.1. Axle 1:

6.6.2.2. Axle 2:

etc.

6.6.3. Tyre pressure(s) as recommended by the vehicle manufacturer: kPa’

(gg) Point 9.1. shall be amended to read:

‘9.1. Type of bodywork using the codes defined in Part C of Annex II of Directive 2007/46/EC:

2. In table 1 of Appendix 6 to Annex I of Regulation (EC) No 692/2008 the rows ZD to ZL and ZX, ZY are amended as follows:

‘ZD	Euro 6c	Euro 6-2	M, N1 class I	PI, CI			31.8.2018
ZE	Euro 6c	Euro 6-2	N1 class II	PI, CI			31.8.2019

▼B

ZF	Euro 6c	Euro 6-2	N1 class III, N2	PI, CI			31.8.2019
ZG	Euro 6d-TEMP	Euro 6-2	M, N1 class I	PI, CI			31.8.2018
ZH	Euro 6d-TEMP	Euro 6-2	N1 class II	PI, CI			31.8.2019
ZI	Euro 6d-TEMP	Euro 6-2	N1 class III, N2	PI, CI			31.8.2019
ZJ	Euro 6d	Euro 6-2	M, N1 class I	PI, CI			31.8.2018
ZK	Euro 6d	Euro 6-2	N1 class II	PI, CI			31.8.2019
ZL	Euro 6d	Euro 6-2	N1 class III, N2	PI, CI			31.8.2019
ZX	n.a.	n.a.	All vehicles	Battery full electric	1.9.2009	1.1.2011	31.8.2019
ZY	n.a.	n.a.	All vehicles	Battery full electric	1.9.2009	1.1.2011	31.8.2019
ZZ	n.a.	n.a.	All vehicles using certificates according to point 2.1.1 of Annex I	PI, CI	1.9.2009	1.1.2011	31.8.2019'



ANNEX XVIII

**SPECIAL PROVISIONS REGARDING ANNEXES I, II, III, VIII AND IX
TO DIRECTIVE 2007/46/EC**

Amendments to Annex I of Directive 2007/46/EC

- (1) Annex I of Directive 2007/46/EC is hereby amended as follows:
- (a) Point 2.6.1. shall be amended to read:
- ‘2.6.1. Distribution of this mass among the axles and, in the case of a semi-trailer, a rigid drawbar trailer or a centre-axle trailer, the mass on the coupling:
- (a) minimum and maximum for each variant:
- (b) mass of each version (a matrix must be provided):
- (b) Points 3. to 3.1.1. shall be amended to read:
- ‘3. PROPULSION ENERGY CONVERTER (k)
- 3.1. Manufacturer of the propulsion energy converter(s):
- 3.1.1. Manufacturer's code (as marked on the propulsion energy converter or other means of identification):
- (c) Point 3.2.1.8. shall be amended to read:
- ‘3.2.1.8. Rated engine power (n): kW at min⁻¹
(manufacturer's declared value)’
- (d) A new point 3.2.2.1.1. shall be added as follows:
- ‘3.2.2.1.1. RON, unleaded:
- (e) Point 3.2.4.2.1. shall be amended to read:
- ‘3.2.4.2.1. System description (common rail/unit injectors/distribution pump etc.):
- (f) Point 3.2.4.2.3. shall be amended to read:
- ‘3.2.4.2.3. Injection/Delivery pump’
- (g) Point 3.2.4.2.4. shall be amended to read:
- ‘3.2.4.2.4. Engine speed limitation control’
- (h) Point 3.2.4.2.9.3. shall be amended to read:
- ‘3.2.4.2.9.3. Description of the system’
- (i) A new point 3.2.4.2.9.3.1.1. shall be added as follows:
- ‘3.2.4.2.9.3.1.1. Software version of the ECU:
- (j) Points 3.2.4.2.9.3.6. to 3.2.4.2.9.3.8. shall be amended to read:

▼B

- ‘3.2.4.2.9.3.6. Make and type or working principle of water temperature sensor:’
- 3.2.4.2.9.3.7. Make and type or working principle of air temperature sensor:’
- 3.2.4.2.9.3.8. Make and type or working principle of air pressure sensor:’
- (k) A new point 3.2.4.3.4.1.1. shall be added as follows:
- ‘3.2.4.3.4.1.1. Software version of the ECU:’
- (l) Point 3.2.4.3.4.3. shall be amended to read:
- ‘3.2.4.3.4.3. Make and type or working principle of air-flow sensor:’
- (m) Points 3.2.4.3.4.9. to 3.2.4.3.4.11. shall be amended to read:
- ‘3.2.4.3.4.9. Make and type or working principle of water temperature sensor:’
- 3.2.4.3.4.10. Make and type or working principle of air temperature sensor:’
- 3.2.4.3.4.11. Make and type or working principle of air pressure sensor:’
- (n) Point 3.2.4.3.5. shall be amended to read:
- ‘3.2.4.3.5. Injectors’
- (o) New points 3.2.4.4.2. and 3.2.4.4.3. shall be added as follows:
- ‘3.2.4.4.2. Make(s):’
- 3.2.4.4.3. Type(s):’
- (p) Points 3.2.12.2. to 3.2.12.2.1. shall be amended to read:
- ‘3.2.12.2. Pollution control devices (if not covered by another heading)
- 3.2.12.2.1. Catalytic converter’
- (q) Points 3.2.12.2.1.11. to 3.2.12.2.1.11.10 shall be deleted and replaced with the following new point:
- ‘3.2.12.2.1.11. Normal operating temperature range: °C’
- (r) Points 3.2.12.2.2. to 3.2.12.2.2.5. shall be deleted and replaced with the following:
- ‘3.2.12.2.2. Sensors
- 3.2.12.2.2.1. Oxygen sensor: yes/no ⁽¹⁾
- 3.2.12.2.2.1.1. Make:’
- 3.2.12.2.2.1.2. Location:’
- 3.2.12.2.2.1.3. Control range:’

▼B

- 3.2.12.2.2.1.4. Type or working principle:
- 3.2.12.2.2.1.5. Identifying part number:
- 3.2.12.2.2.2. NOx sensor: yes/no ⁽¹⁾
- 3.2.12.2.2.2.1. Make:
- 3.2.12.2.2.2.2. Type:
- 3.2.12.2.2.2.3. Location:
- 3.2.12.2.2.3. Particulate sensor: yes/no ⁽¹⁾
- 3.2.12.2.2.3.1. Make:
- 3.2.12.2.2.3.2. Type:
- 3.2.12.2.2.3.3. Location:
- (s) Points 3.2.12.2.4.1. to 3.2.12.2.4.2. shall be amended to read:
- ‘3.2.12.2.4.1. Characteristics (make, type, flow, high pressure / low pressure / combined pressure, etc.):
- 3.2.12.2.4.2. Water-cooled system (to be specified for each EGR system e.g. low pressure / high pressure / combined pressure: yes/no ⁽¹⁾’
- (t) Points 3.2.12.2.5. to 3.2.12.2.5.6. shall be amended to read:
- ‘3.2.12.2.5. Evaporative emissions control system (petrol and ethanol engines only): yes/no ⁽¹⁾
- 3.2.12.2.5.1. Detailed description of the devices:
- 3.2.12.2.5.2. Drawing of the evaporative control system:
- 3.2.12.2.5.3. Drawing of the carbon canister:
- 3.2.12.2.5.4. Mass of dry charcoal: g
- 3.2.12.2.5.5. Schematic drawing of the fuel tank with indication of capacity and material (petrol and ethanol engines only):
- 3.2.12.2.5.6. Description and schematic of the heat shield between tank and exhaust system:
- (u) Points 3.2.12.2.6.4. to 3.2.12.2.6.4.4. shall be deleted
- (v) Points 3.2.12.2.6.5. and 3.2.12.2.6.6. shall be renumbered to read:
- ‘3.2.12.2.6.4. Make of particulate trap:
- 3.2.12.2.6.5. Identifying part number:
- (w) Points 3.2.12.2.7. to 3.2.12.2.7.0.6. shall be amended to read:
- ‘3.2.12.2.7. On-board-diagnostic (OBD) system: yes/no ⁽¹⁾:
- 3.2.12.2.7.0.1. (Euro VI only) Number of OBD engine families within the engine family

▼B

- 3.2.12.2.7.0.2. (Euro VI only) List of the OBD engine families (when applicable)
- 3.2.12.2.7.0.3. (Euro VI only) Number of the OBD engine family the parent engine / the engine member belongs to:
- 3.2.12.2.7.0.4. (Euro VI only) Manufacturer references of the OBD-Documentation required by Article 5(4)(c) and Article 9(4) of Regulation (EU) No 582/2011 and specified in Annex X to that Regulation for the purpose of approving the OBD system
- 3.2.12.2.7.0.5. (Euro VI only) When appropriate, manufacturer reference of the Documentation for installing in a vehicle an OBD equipped engine system
- 3.2.12.2.7.0.6. (Euro VI only) When appropriate, manufacturer reference of the documentation package related to the installation on the vehicle of the OBD system of an approved engine'
- (x) In point 3.2.12.2.7.6.4.1. the heading 'Low-duty vehicles' shall be replaced with 'Light-duty vehicles'
- (y) Points 3.2.12.2.8. shall be amended to read:
- '3.2.12.2.8. Other system:
- (z) New points 3.2.12.2.8.2.3. to 3.2.12.2.8.2.5. are added as follows:
- '3.2.12.2.8.2.3. Type of inducement system: no engine restart after countdown/no start after refuelling/fuel-lockout/performance restriction
- 3.2.12.2.8.2.4. Description of the inducement system
- 3.2.12.2.8.2.5. Equivalent to the average driving range of the vehicle with a complete tank of fuel: km'
- (aa) A new point 3.2.12.2.8.4. shall be added as follows:
- '3.2.12.2.8.4. (Euro VI only) List of the OBD engine families (when applicable): ...'
- (bb) New points 3.2.12.2.10. to 3.2.12.2.11.8. shall be added as follows:
- '3.2.12.2.10. Periodically regenerating system: (provide the information below for each separate unit)
- 3.2.12.2.10.1. Method or system of regeneration, description and/or drawing:
- 3.2.12.2.10.2. The number of Type 1 operating cycles, or equivalent engine test bench cycles, between two cycles where regenerative phases occur under the conditions equivalent to Type 1 test (Distance "D" in Figure A6.App1/1 in Appendix 1 to Sub-Annex 6 of Annex XXI to Regulation (EU) 2017/1151 or figure A13/1 in Annex 13 to UN/ECE Regulation 83 (as applicable)): ...

▼B

- 3.2.12.2.10.2.1. Applicable Type 1 cycle (indicate the applicable procedure: Annex XXI, Sub-Annex 4 or UN/ECE Regulation 83):
- 3.2.12.2.10.3. Description of method employed to determine the number of cycles between two cycles where regenerative phases occur:
- 3.2.12.2.10.4. Parameters to determine the level of loading required before regeneration occurs (i.e. temperature, pressure etc.):
- 3.2.12.2.10.5. Description of method used to load system in the test procedure described in paragraph 3.1., Annex 13 to UN/ECE Regulation 83:
- 3.2.12.2.11. Catalytic converter systems using consumable reagents (provide the information below for each separate unit) yes/no ⁽¹⁾
- 3.2.12.2.11.1. Type and concentration of reagent needed: ...
- 3.2.12.2.11.2. Normal operational temperature range of reagent: ...
- 3.2.12.2.11.3. International standard: ...
- 3.2.12.2.11.4. Frequency of reagent refill: continuous/maintenance (where appropriate):
- 3.2.12.2.11.5. Reagent indicator (description and location): ...
- 3.2.12.2.11.6. Reagent tank
- 3.2.12.2.11.6.1. Capacity: ...
- 3.2.12.2.11.6.2. Heating system: yes/no
- 3.2.12.2.11.6.2.1. Description or drawing: ...
- 3.2.12.2.11.7. Reagent control unit: yes/no ⁽¹⁾
- 3.2.12.2.11.7.1. Make: ...
- 3.2.12.2.11.7.2. Type: ...
- 3.2.12.2.11.8. Reagent injector (make type and location): ...'

(cc) Point 3.2.15.1. shall be amended to read:

'3.2.15.1. Type-approval number according to Regulation (EC) No 661/2009 (OJ L 200, 31.7.2009, p. 1):

(dd) Point 3.2.16.1. shall be amended to read:

'3.2.16.1. Type-approval number according to Regulation (EC) No 661/2009 (OJ L 200, 31.7.2009, p. 1):

▼B

- (ee) New points 3.2.20. to 3.2.20.2.4. shall be added as follows:
- ‘3.2.20. Heat storage information
 - 3.2.20.1. Active heat storage device: yes/no
 - 3.2.20.1.1. Enthalpy: ... (J)
 - 3.2.20.2. Insulation materials
 - 3.2.20.2.1. Insulation material: ...
 - 3.2.20.2.2. Insulation volume: ...
 - 3.2.20.2.3. Insulation weight: ...
 - 3.2.20.2.4. Insulation location: ...’
- (ff) Point 3.3. shall be amended to read:
- ‘3.3. Electric machine’
- (gg) Point 3.3.2. shall be amended to read:
- ‘3.3.2. REESS’
- (hh) Point 3.4. shall be amended to read:
- ‘3.4. Combinations of propulsion energy converters’
- (ii) Point 3.4.4. shall be amended to read:
- ‘3.4.4. Description of the energy storage device: (REESS, capacitor, flywheel/generator)’
- (jj) Point 3.4.4.5. shall be amended to read:
- ‘3.4.4.5. Energy: (for REESS: voltage and capacity Ah in 2 h, for capacitor: J,)’
- (kk) Point 3.4.5. shall be amended to read:
- ‘3.4.5. Electric machine (describe each type of electric machine separately)’
- (ll) Point 3.5. shall be amended to read:
- ‘3.5. Manufacturer's declared values for determination of CO₂ emissions/fuel consumption/electric consumption/electric range and details of eco-innovations (where applicable)(°)’
- (mm) New points 3.5.7. to 3.5.8.3. are added as follows:
- ‘3.5.7. Manufacturer's declared values
 - 3.5.7.1. Test vehicle parameters
 - 3.5.7.1.1. Vehicle high
 - 3.5.7.1.1.1. Cycle Energy Demand: ... J

▼B

- 3.5.7.1.1.2. Road load coefficients
 - 3.5.7.1.1.2.1. f_0 : N
 - 3.5.7.1.1.2.2. f_1 : N/(km/h)
 - 3.5.7.1.1.2.3. f_2 : N/(km/h)²
- 3.5.7.1.2. Vehicle Low (if applicable)
 - 3.5.7.1.2.1. Cycle Energy Demand: ... J
 - 3.5.7.1.2.2. Road load coefficients
 - 3.5.7.1.2.2.1. f_0 : N
 - 3.5.7.1.2.2.2. f_1 : N/(km/h)
 - 3.5.7.1.2.2.3. f_2 : N/(km/h)²
 - 3.5.7.1.3. Vehicle M (if applicable)
 - 3.5.7.1.3.1. Cycle Energy Demand: ... J
 - 3.5.7.1.3.2. Road load coefficients
 - 3.5.7.1.3.2.1. f_0 : N
 - 3.5.7.1.3.2.2. f_1 : N/(km/h)
 - 3.5.7.1.3.2.3. f_2 : N/(km/h)²
- 3.5.7.2. Combined CO₂ mass emissions
 - 3.5.7.2.1. CO₂ mass emission for ICE
 - 3.5.7.2.1.1. Vehicle High: g/km
 - 3.5.7.2.1.2. Vehicle low (if applicable): g/km
 - 3.5.7.2.2. Charge Sustaining CO₂ mass emission for OVC-HEVs and NOVC-HEVs
 - 3.5.7.2.2.1. Vehicle high: g/km
 - 3.5.7.2.2.2. Vehicle low (if applicable): g/km
 - 3.5.7.2.2.3. Vehicle M (if applicable): g/km
 - 3.5.7.2.3. Charge Depleting CO₂ mass emission for OVC-HEVs
 - 3.5.7.2.3.1. Vehicle high: g/km
 - 3.5.7.2.3.2. Vehicle low (if applicable): g/km
 - 3.5.7.2.3.3. Vehicle M (if applicable): g/km
- 3.5.7.3. Electric range for electrified vehicles

▼B

- 3.5.7.3.1. Pure Electric Range (PER) for PEVs
 - 3.5.7.3.1.1. Vehicle high: km
 - 3.5.7.3.1.2. Vehicle low (if applicable): km
- 3.5.7.3.2. All Electric Range AER for OVC-HEVs
 - 3.5.7.3.2.1. Vehicle high: km
 - 3.5.7.3.2.2. Vehicle low (if applicable): km
 - 3.5.7.3.2.3. Vehicle M (if applicable): km
- 3.5.7.4. Charge Sustaining fuel consumption (FCCS) for FCHVs
 - 3.5.7.4.1. Vehicle high: kg/100 km
 - 3.5.7.4.2. Vehicle low (if applicable): kg/100 km
 - 3.5.7.4.3. Vehicle M (if applicable): kg/100 km
- 3.5.7.5. Electric energy consumption for electrified vehicles
 - 3.5.7.5.1. Combined electric energy consumption (ECWLTC) for Pure electric vehicles
 - 3.5.7.5.1.1. Vehicle high: Wh/km
 - 3.5.7.5.1.2. Vehicle low (if applicable): Wh/km
 - 3.5.7.5.2. Utility factor weighted charge-depleting electric consumption ECAC,CD (combined)
 - 3.5.7.5.2.1. Vehicle high: Wh/km
 - 3.5.7.5.2.2. Vehicle low (if applicable): Wh/km
 - 3.5.7.5.2.3. Vehicle M (if applicable): Wh/km
- 3.5.8. Vehicle fitted with an eco-innovation within the meaning of Article 12 of Regulation (EC) No 443/2009 for M1 vehicles or Article 12 of Regulation (EU) No 510/2011 for N1 vehicles: yes/no ⁽¹⁾
 - 3.5.8.1. Type/Variant/Version of the baseline vehicle as referred to in Article 5 of Regulation (EU) No 725/2011 for M1 vehicles or Article 5 of Regulation (EU) No 427/2014 for N1 vehicles (if applicable):
 - 3.5.8.2. Existence of interactions between different eco-innovations: yes/no ⁽¹⁾



3.5.8.3. Emissions data related to the use of eco-innovations
(repeat the table for each reference fuel tested) (w1)

Decision approving the eco-innovation (w2)	Code of the eco-innovation (w3)	1. CO ₂ emissions of the baseline vehicle (g/km)	2. CO ₂ emissions of the eco-innovation vehicle (g/km)	3. CO ₂ emissions of the baseline vehicle under type 1 test-cycle (w4)	4. CO ₂ emissions of the eco-innovation vehicle under type 1 test-cycle	5. Usage factor (UF), i.e. temporal share of technology usage in normal operation conditions	CO ₂ emissions savings ((1 - 2) - (3 - 4))*5
xxxx/201x							
Total CO ₂ emissions saving (g/km)(w5),							

(nn) Point 4.4. shall be amended to read:

‘4.4. Clutch(es):?’

(oo) New points 4.5.1.1. to 4.5.1.5. shall be added as follows:

‘4.5.1.1. Predominant mode: yes/no (1)

4.5.1.2. Best mode (if no predominant mode): ...

4.5.1.3. Worst mode (if no predominant mode): ...

4.5.1.4. Torque rating:

4.5.1.5. Number of clutches:’

(pp) Point 4.6. shall be amended to read:

‘4.6. Gear ratios

Gear	Internal gearbox ratios (ratios of engine to gearbox output shaft revolutions)	Final drive ratio(s) (ratio of gearbox output shaft to driven wheel revolutions)	Total gear ratios
Maximum for CVT			
1			
2			
3			
...			
Minimum for CVT Reverse’			

▼B

(qq) Point 6.6. to 6.6.5. shall be replaced as follows:

- ‘6.6. Tyres and wheels
 - 6.6.1. Tyre/wheel combination(s)
 - 6.6.1.1. Axles
 - 6.6.1.1.1. Axle 1:
 - 6.6.1.1.1.1. Tyre size designation:
 - 6.6.1.1.1.2. Load-capacity index:
 - 6.6.1.1.1.3. Speed category symbol (‘)
 - 6.6.1.1.1.4. Wheel rim size(s):
 - 6.6.1.1.1.5. Wheel off-set(s):
 - 6.6.1.1.2. Axle 2:
 - 6.6.1.1.2.1. Tyre size designation:
 - 6.6.1.1.2.2. Load-capacity index:
 - 6.6.1.1.2.3. Speed category symbol:
 - 6.6.1.1.2.4. Wheel rim size(s):
 - 6.6.1.1.2.5. Wheel off-set(s):
 - etc.
 - 6.6.1.2. Spare wheel, if any:
 - 6.6.2. Upper and lower limits of rolling radii
 - 6.6.2.1. Axle 1: mm
 - 6.6.2.2. Axle 2: mm
 - 6.6.2.3. Axle 3: mm
 - 6.6.2.4. Axle 4: mm
 - etc.
 - 6.6.3. Tyre pressure(s) as recommended by the vehicle manufacturer: kPa
 - 6.6.4. Chain/tyre/wheel combination on the front and/or rear axle that is suitable for the type of vehicle, as recommended by the manufacturer:
 - 6.6.5. Brief description of temporary use spare unit (if any): ...’

(rr) Point 9.1. shall be amended to read:

- ‘9.1. Type of bodywork using the codes defined in Part C of Annex II of Directive 2007/46/EC:

(ss) Point 9.9.2.1. shall be amended to read:

- ‘9.9.2.1. Type and description of the device: ...’

▼B**Amendments to Annex II of Directive 2007/46/EC**

(2) Annex II is hereby amended as follows:

- (a) At the end of the two points 1.3.1 and 3.3.1 of part B of Annex II defining the criteria for 'vehicle versions' for M1 and N1 vehicles each, the following text should be added:

'As an alternative to the criteria (h), (i) and (j), the vehicles grouped into a version shall have all tests performed for the calculation of their CO₂ emissions, electric energy consumption and fuel consumptions according to the provisions of sub-Annex 6 to Annex XXI of Regulation (EU) 2017/1151 in common.'

- (b) The following text shall be added at the end of point 3.3.1 of part B of Annex II

'(k) the existence of a unique set of innovative technologies, as specified in Article 12 of Regulation (EU) No 510/2011 (*).

(*) OJ L 145 31.5.2011, p. 1.'

Amendments to Annex III of Directive 2007/46/EC

(3) Annex III of Directive 2007/46/EC is hereby amended as follows:

- (a) Points 3. to 3.1.1. shall be amended to read:

'3. PROPULSION ENERGY CONVERTER (k)

3.1. Manufacturer of the propulsion energy converter(s):

3.1.1. Manufacturer's code (as marked on the propulsion energy converter or other means of identification):

- (b) Point 3.2.1.8. shall be amended to read:

'3.2.1.8. Rated engine power (n): kW at min⁻¹
(manufacturer's declared value)'

- (c) Points 3.2.12.2. to 3.2.12.2.1. shall be amended to read:

'3.2.12.2. Pollution control devices (if not covered by another heading)

3.2.12.2.1. Catalytic converter'

- (d) Point 3.2.12.2.1.11. shall be deleted

- (e) Points 3.2.12.2.1.11.6. and 3.2.12.2.1.11.7. shall be deleted

- (f) Point 3.2.12.2.2. shall be deleted and replaced with the following new point:

'3.2.12.2.2.1. Oxygen sensor: yes/no ⁽¹⁾'

- (g) Point 3.2.12.2.5. shall be amended to read:

'3.2.12.2.5. Evaporative emissions control system (petrol and ethanol engines only): yes/no ⁽¹⁾'

▼B

(h) Point 3.2.12.2.8. shall be amended to read:

‘3.2.12.2.8. Other system’

(i) New points 3.2.12.2.10. to 3.2.12.2.10.1. shall be added as follows:

‘3.2.12.2.10. Periodically regenerating system: (provide the information below for each separate unit)

3.2.12.2.10.1. Method or system of regeneration, description and/or drawing:

(j) A new point 3.2.12.2.11.1. shall be added as follows:

‘3.2.12.2.11.1. Type and concentration of reagent needed:

(k) Point 3.3. shall be amended to read:

‘3.3. Electric machine’

(l) Point 3.3.2. shall be amended to read:

‘3.3.2. REESS’

(m) Point 3.4. shall be amended to read:

‘3.4. Combinations of propulsion energy converters’

(n) Points 3.5.4 to 3.5.5.6. shall be deleted.

(o) Point 4.6. shall be amended to read:

‘4.6. Gear ratios

Gear	Internal gearbox ratios (ratios of engine to gearbox output shaft revolutions)	Final drive ratio(s) (ratio of gearbox output shaft to driven wheel revolutions)	Total gear ratios
Maximum for CVT			
1			
2			
3			
...			
Minimum for CVT Reverse’			

(p) Point 6.6.1. shall be amended to read:

‘6.6.1. Tyre/wheel combination(s)’

(q) Point 9.1. shall be amended to read:

‘9.1. Type of bodywork using the codes defined in Part C of Annex II of Directive 2007/46/EC:



Amendments to Annex VIII of Directive 2007/46/EC

- (4) Annex VIII of Directive 2007/46/EC is hereby amended as follows:

'ANNEX VIII

TEST RESULTS

(To be completed by the type-approval authority and attached to the vehicle EC type-approval certificate)

In each case, the information must make clear to which variant and version it is applicable. One version may not have more than one result. However, a combination of several results per version indicating the worst case is permissible. In the latter case, a note shall state that for items marked (*) only worst case results are given.

1. Results of the sound level tests

Number of the base regulatory act and latest amending regulatory act applicable to the approval. In case of a regulatory act with two or more implementation stages, indicate also the implementation stage:

Variant/Version:
Moving (dB(A)/E):
Stationary (dB(A)/E):
at (min ⁻¹):

2. Results of the exhaust emission tests

2.1. Emissions from motor vehicles tested under the test procedure for light-duty vehicles

Indicate the latest amending regulatory act applicable to the approval. In case the regulatory act has two or more implementation stages, indicate also the implementation stage:

Fuel(s) ⁽¹⁾ ... (diesel, petrol, LPG, NG, Bi-fuel: petrol/NG, LPG, NG/biomethane, Flex-fuel: petrol/ethanol...)

2.1.1. Type 1 test ⁽²⁾, ⁽³⁾ (vehicle emissions in the test cycle after a cold start)

NEDC average values, WLTP highest values

Variant/Version:
CO (mg/km)
THC (mg/km)

⁽¹⁾ When restrictions for the fuel are applicable, indicate these restrictions (e.g. for natural gas the L range or the H range).

⁽²⁾ For bi fuel vehicles, the table shall be repeated for both fuels.

⁽³⁾ For flex fuel vehicles, when the test is to be performed on both fuels, according to Figure I.2.4 of Annex I to Regulation (EU) 2017/1151, and for vehicles running on LPG or NG/Biomethane, either bi-fuel or mono-fuel, the table shall be repeated for the different reference gases used in the test, and an additional table shall display the worst results obtained. When applicable, in accordance with paragraph 3.1.4. of Annex 12 to UN/ECE Regulation No 83, it shall be shown if the results are measured or calculated.

▼B

NMHC (mg/km)
NO _x (mg/km)
THC + NO _x (mg/km)
Mass of particulate matter (PM) (mg/km)
Number of particles (PN) (#/km) ⁽¹⁾

Ambient Temperature Correction Test (ATCT)

ATCT Family	Interpolation family	Road Load Matrix family
...
...

Family correction factors

ATCT Family	FCF
...	...
...	...

2.1.2. Type 2 test ⁽¹⁾, ⁽²⁾ (emissions data required at type-approval for road-worthiness purposes)

Type 2, low idle test:

Variant/Version:
CO (% vol.)
Engine speed (min ⁻¹)
Engine oil temperature (°C)

Type 2, high idle test:

Variant/Version:
CO (% vol.)
Lambda Value
Engine speed (min ⁻¹)
Engine oil temperature (°C)

⁽¹⁾ For bi fuel vehicles, the table shall be repeated for both fuels.

⁽²⁾ For flex fuel vehicles, when the test is to be performed on both fuels, according to Figure I.2.4 of Annex I to Regulation (EU) 2017/1151, and for vehicles running on LPG or NG/Biomethane, either bi-fuel or mono-fuel, the table shall be repeated for the different reference gases used in the test, and an additional table shall display the worst results obtained. When applicable, in accordance with paragraph 3.1.4. of Annex 12 to UN/ECE Regulation No 83, it shall be shown if the results are measured or calculated.

▼B

2.1.3. Type 3 test (emissions of crankcase gases): ...

2.1.4. Type 4 test (evaporative emissions): ... g/test

2.1.5. Type 5 test (durability of anti-pollution control devices):

— Ageing distance covered (km)(e.g. 160 000 km): ...

— Deterioration factor DF: calculated/fixed ⁽¹⁾

— Values:

Variant/Version:
CO
THC
NMHC
NO _x
THC + NO _x
Mass of particulate matter (PM)
Number of particles (PN) ⁽¹⁾

2.1.6. Type 6 test (average emissions at low ambient temperatures):

Variant/Version:
CO (g/km)
THC (g/km)

2.1.7. OBD: yes/no ⁽²⁾

2.2. *Emissions from engines tested under the test procedure for heavy-duty vehicles.*

Indicate the latest amending regulatory act applicable to the approval. In case the regulatory act has two or more implementation stages, indicate also the implementation stage: ...

Fuel(s) ⁽³⁾ ... (diesel, petrol, LPG, NG, ethanol ...)

2.2.1. Results of the ESC test ⁽⁴⁾, ⁽⁵⁾, ⁽⁶⁾

Variant/Version:
CO (mg/kWh)
THC (mg/kWh)
NO _x (mg/kWh)
NH ₃ (ppm) ⁽¹⁾

⁽¹⁾ Delete where not applicable.

⁽²⁾ Delete where not applicable.

⁽³⁾ When restrictions for the fuel are applicable, indicate these restrictions (e.g. for natural gas the L range or the H range).

⁽⁴⁾ If applicable.

⁽⁵⁾ For Euro VI, ESC shall be understood as WHSC and ETC as WHTC.

⁽⁶⁾ For Euro VI, if CNG and LPG fuelled engines are tested on different reference fuels, the table shall be reproduced for each reference fuel tested.

▼ B

PM mass (mg/kWh)
PM number (#/kWh) ⁽¹⁾

2.2.2. Result of the ELR test ⁽¹⁾

Variant/Version:
Smoke value: ... m ⁻¹

2.2.3. Result of the ETC test ⁽²⁾, ⁽³⁾

Variant/Version:
CO (mg/kWh)
THC (mg/kWh)
NMHC (mg/kWh) ⁽¹⁾
CH ₄ (mg/kWh) ⁽¹⁾
NO _x (mg/kWh)
NH ₃ (ppm) ⁽¹⁾
PM mass (mg/kWh)
PM number (#/kWh) ⁽¹⁾

2.2.4. Idle test ⁽⁴⁾

Variant/Version:
CO (% vol.)
Lambda Value ⁽¹⁾
Engine speed (min ⁻¹)
Engine oil temperature (K)

2.3. Diesel smoke

Indicate the latest amending regulatory act applicable to the approval. In case the regulatory act has two or more implementation stages, indicate also the implementation stage:

2.3.1. Results of the test under free acceleration

Variant/Version:
Corrected value of the absorption coefficient (m ⁻¹)
Normal engine idling speed
Maximum engine speed
Oil temperature (min./max.)

⁽¹⁾ If applicable.⁽²⁾ For Euro VI, ESC shall be understood as WHSC and ETC as WHTC.⁽³⁾ For Euro VI, if CNG and LPG fuelled engines are tested on different reference fuels, the table shall be reproduced for each reference fuel tested.⁽⁴⁾ If applicable.

▼B

3. Results of the CO₂ emission, fuel/electric energy consumption, and electric range tests

Number of the base regulatory act and the latest amending regulatory act applicable to the approval:

3.1. Internal combustion engines, including not externally chargeable hybrid electric vehicles (NOVC) ⁽¹⁾ ⁽²⁾

Variant/Version:
CO ₂ mass emission (urban conditions) (g/km)
CO ₂ mass emission (extra-urban conditions) (g/km)
CO ₂ mass emission (combined) (g/km)
Fuel consumption (urban conditions) (l/100 km) ⁽¹⁾
Fuel consumption (extra-urban conditions) (l/100 km) ⁽²⁾
Fuel consumption (combined) (l/100 km) ⁽³⁾

⁽¹⁾ The unit “l/100 km” is replaced by “m³/100 km” for vehicles fuelled with NG and H2NG, and by “kg/100 km” for vehicles fuelled with hydrogen.

⁽²⁾ The unit “l/100 km” is replaced by “m³/100 km” for vehicles fuelled with NG and H2NG, and by “kg/100 km” for vehicles fuelled with hydrogen.

⁽³⁾ The unit “l/100 km” is replaced by “m³/100 km” for vehicles fuelled with NG and H2NG, and by “kg/100 km” for vehicles fuelled with hydrogen.

Interpolation family identifier ⁽¹⁾	Variant/versions
...	...
...	...
...	...

⁽¹⁾ The format for the Interpolation Family Identifier is provided in paragraph 5.0 of Annex XXI to Commission Regulation (EU) 2017/1151 of 1 June 2017 supplementing Regulation (EC) No 715/2007 of the European Parliament and of the Council on type-approval of motor vehicles with respect to emissions from light passenger and commercial vehicles (Euro 5 and Euro 6) and on access to vehicle repair and maintenance information, amending Directive 2007/46/EC of the European Parliament and of the Council, Commission Regulation (EC) No 692/2008 and Commission Regulation (EU) No 1230/2012 and repealing Regulation (EC) No 692/2008 (OJ L 175, 7.7.2017, p. 1).

Road Load Matrix family identifier ⁽¹⁾	Variant/versions
...	...
...	...
...	...

⁽¹⁾ The format for the Road Load Matrix Family Identifier is provided in paragraph 5.0 of Annex XXI to Regulation (EU) 2017/1151.

⁽¹⁾ If applicable.

⁽²⁾ Repeat the table for each reference fuel tested.

▼B

Results:	Interpolation family identifier			Road Load Matrix family identifier
	VH	VM (if applicable)	VL (if applicable)	V representative
CO ₂ mass emission LOW phase (g/km)	
CO ₂ mass emission MID phase (g/km)	
CO ₂ mass emission HIGH phase (g/km)	
CO ₂ mass emission EXTRA-HIGH phase (g/km)	
CO ₂ mass emission (combined) (g/km)	
Fuel consumption LOW phase (l/100 km m ³ /100 km kg/100 km)	
Fuel consumption MID phase (l/100 km m ³ /100 km kg/100 km)	
Fuel consumption HIGH phase (l/100 km m ³ /100 km kg/100 km)	
Fuel consumption EXTRA-HIGH phase (l/100 km m ³ /100 km kg/100 km)	
Fuel consumption (combined) (l/100 km m ³ /100 km kg/100 km)	
f0	
f1	
f2	
RR	
Delta Cd*A (for VL if applicable compared to VH)	
Test Mass	

Repeat for each interpolation or road load matrix family.

3.2. Externally chargeable hybrid electric vehicles (OVC) ⁽¹⁾

Variant/Version:
CO ₂ mass emission (Condition A, combined) (g/km)
CO ₂ mass emission (Condition B, combined) (g/km)

⁽¹⁾ If applicable.

▼ B

CO ₂ mass emission (weighted, combined) (g/km)
Fuel consumption (Condition A, combined) (l/100 km) ^(g)
Fuel consumption (Condition B, combined) (l/100 km) ^(g)
Fuel consumption (weighted, combined) (l/100 km) ^(g)
Electric energy consumption (Condition A, combined) (Wh/km)
Electric energy consumption (Condition B, combined) (Wh/km)
Electric energy consumption (weighted and combined) (Wh/km)
Pure electric range (km)

Interpolation family number	Variant/versions
...	...
...	...
...	...

Road Load Matrix family identifier	Variant/versions
...	...
...	...
...	...

Results:	Interpolation family identifier			Road Load Matrix family identifier
	VH	VM (if applicable)	VL (if applicable)	V representative
CS CO ₂ mass emission LOW phase (g/km)	
CS CO ₂ mass emission MID phase (g/km)	
CS CO ₂ mass emission HIGH phase (g/km)	
CS CO ₂ mass emission EXTRA-HIGH phase (g/km)	
CS CO ₂ mass emission (combined) (g/km)	

▼ B

Results:	Interpolation family identifier			Road Load Matrix family identifier
	VH	VM (if applicable)	VL (if applicable)	V representative
CD CO ₂ mass emission (combined) (g/km)				
CO ₂ mass emission (weighted, combined) (g/km)				
CS Fuel consumption LOW phase (l/100 km)	
CS Fuel consumption MID phase (l/100 km)	
CS Fuel consumption HIGH phase (l/100 km)	
CS Fuel consumption EXTRA-HIGH phase (l/100 km)	
CS Fuel consumption (combined) (l/100 km)	
CD Fuel consumption (combined) (l/100 km)	
Fuel consumption (weighted, combined) (l/100 km)	
EC _{AC,weighted}	
EAER (combined)	
EAER _{city}	
f0	
f1	
f2	
RR	
Delta Cd*A (for VL or VM compared to VH)	
Test Mass	
Frontal area of the representative vehicle (m ²)				

Repeat for each interpolation family.

3.3. Pure electric vehicles ⁽¹⁾

Variant/Version:
Electric energy consumption (Wh/km)
Range (km)

⁽¹⁾ If applicable.

▼ B

Interpolation family number	Variant/versions
...	...
...	...
...	...

Road Load Matrix family identifier	Variant/versions
...	...
...	...
...	...

Results:	Interpolation family identifier		Matrix family identifier
	VH	VL	V representative
Electric Consumption (Combined) (Wh/km)	
Pure Electric Range (Combined) (km)	
Pure Electric Range (City) (km)	
f0	
f1	
f2	
RR	
Delta Cd*A (for VL compared to VH)	
Test Mass	
Frontal area of the representative vehicle (m ²)			

3.4. *Hydrogen fuel cell vehicles* ⁽¹⁾

Variant/Version:
Fuel consumption (kg/100 km)

	Variant/Version:	Variant/Version:
Fuel Consumption (Combined) (kg/100 km)
f0
f1
f2
RR
Test Mass	...	

⁽¹⁾ If applicable.

▼ B3.5. *Output report(s) from the correlation tool in accordance with Implementing Regulation (EU) 2017/1152*

Repeat for each interpolation or road load matrix family:

Interpolation family identifier or road load matrix family [Footnote: “Type Approval Number + Interpolation Family Sequence number”]:
...

...

VH report: ...

VL report (if applicable): ...

V representative: ...

4. **Results of the tests for vehicles fitted with eco-innovation(s) ⁽¹⁾ ⁽²⁾ ⁽³⁾**

According to Regulation 83 (if applicable)

Decision approving the eco-innovation ⁽¹⁾	Variant/Version ...							
	Code of the eco-innovation ⁽²⁾	Type 1/I cycle (NEDC/WLTP)	1. CO ₂ emissions of the baseline vehicle (g/km)	2. CO ₂ emissions of the eco-innovation vehicle (g/km)	3. CO ₂ emissions of the baseline vehicle under Type 1 test-cycle ⁽³⁾	4. CO ₂ emissions of the eco-innovation vehicle under Type 1 test-cycle (= 3.5.1.3 of Annex I)	5. Usage factor (UF) i.e. temporal share of technology usage in normal operation conditions	CO ₂ emissions savings ((1 - 2) - (3 - 4)) * 5
xxx/201x
...
...
Total CO ₂ emissions savings on NEDC(g/km) ⁽⁴⁾								...

⁽¹⁾ ^(h4) Number of the Commission Decision approving the eco-innovation.

⁽²⁾ ^(h5) Assigned in the Commission Decision approving the eco-innovation.

⁽³⁾ ^(h6) If a modelling methodology is applied instead of the type 1 test cycle, this value shall be the one provided by the modelling methodology.

⁽⁴⁾ ^(h7) Sum of the CO₂ emissions savings of each individual eco-innovation on Type I according UN/ECE Regulation No 83.

According to Annex XXI of Regulation (EU) 2017/1151 (if applicable)

Decision approving the eco-innovation ⁽¹⁾	Variant/Version ...							
	Code of the eco-innovation ⁽²⁾	Type 1/I cycle (NEDC/WLTP)	1. CO ₂ emissions of the baseline vehicle (g/km)	2. CO ₂ emissions of the eco-innovation vehicle (g/km)	3. CO ₂ emissions of the baseline vehicle under Type 1 test-cycle ⁽³⁾	4. CO ₂ emissions of the eco-innovation vehicle under Type 1 test-cycle	5. Usage factor (UF) i.e. temporal share of technology usage in normal operation conditions	CO ₂ emissions savings ((1 - 2) - (3 - 4)) * 5
xxx/201x

⁽¹⁾ ^(h1) Repeat the table for each variant/version.

⁽²⁾ ^(h2) Repeat the table for each reference fuel tested

⁽³⁾ ^(h3) Expand the table if necessary, using one extra row per eco-innovation.

▼B

Decision approving the eco-innovation (1)	Variant/Version ...							
	Code of the eco-innovation (2)	Type 1/I cycle (NEDC/WLTP)	1. CO ₂ emissions of the baseline vehicle (g/km)	2. CO ₂ emissions of the eco-innovation vehicle (g/km)	3. CO ₂ emissions of the baseline vehicle under Type 1 test-cycle (3)	4. CO ₂ emissions of the eco-innovation vehicle under Type 1 test-cycle	5. Usage factor (UF) i.e. temporal share of technology usage in normal operation conditions	CO ₂ emissions savings ((1 - 2) - (3 - 4)) * 5
...
...
Total CO ₂ emissions savings on WLTP(g/km) (4)								

(1) ^(h4) Number of the Commission Decision approving the eco-innovation.

(2) ^(h5) Assigned in the Commission Decision approving the eco-innovation.

(3) ^(h6) If a modelling methodology is applied instead of the type 1 test cycle, this value shall be the one provided by the modelling methodology.

(4) ^(h7) Sum of the CO₂ emissions savings of each individual eco-innovation on Type 1 according to Annex XXI, Sub-Annex 4 of Regulation (EU) 2017/1151.

4.1. *General code of the eco-innovation(s) (1):*

Explanatory notes

(^h) Eco-innovations.

(1) ^(h8) The general code of the eco-innovation(s) shall consist of the following elements each separated by a blank space:

- Code of the approval authority as set out in Annex VII;
- Individual code of each eco-innovation fitted in the vehicle, indicated in chronological order of the Commission approval decisions.

(E.g. the general code of three eco-innovations approved chronologically as 10, 15 and 16 and fitted to a vehicle certified by the German type-approval authority should be: "e1 10 15 16").

Amendments to Annex IX of Directive 2007/46/EC

(5) Annex IX of Directive 2007/46/EC is hereby replaced by the following text:

ANNEX IX

EC CERTIFICATE OF CONFORMITY

0. OBJECTIVES

The certificate of conformity is a statement delivered by the vehicle manufacturer to the buyer in order to assure him that the vehicle he has acquired complies with the legislation in force in the European Union at the time it was produced.

The certificate of conformity also serves the purpose to enable the competent authorities of the Member States to register vehicles without having to require the applicant to supply additional technical documentation.

For these purposes, the certificate of conformity has to include:

(a) the Vehicle Identification Number;

▼B

- (b) the exact technical characteristics of the vehicle (i.e. it is not permitted to mention any range of value in the various entries).

1. GENERAL DESCRIPTION

1.1. The certificate of conformity shall consist of two parts.

- (a) SIDE 1, which consists of a statement of compliance by the manufacturer. The same template is common to all vehicle categories.
- (b) SIDE 2, which is a technical description of the main characteristics of the vehicle. The template of side 2 is adapted to each specific vehicle category.

1.2. The certificate of conformity shall be established in a maximum format A4 (210 × 297 mm) or a folder of maximum format A4.

1.3. Without prejudice to the provisions in Section O(b), the values and units indicated in the second part shall be those given in the type-approval documentation of the relevant regulatory acts. In case of conformity of production checks the values shall be verified according to the methods laid down in the relevant regulatory acts. The tolerances allowed in those regulatory acts shall be taken into account.

2. SPECIAL PROVISIONS

- 2.1. Model A of the certificate of conformity (complete vehicle) shall cover vehicles which can be used on the road without requiring any further stage for their approval.
- 2.2. Model B of the certificate of conformity (completed vehicles) shall cover vehicles which have undergone a further stage for their approval.

This is the normal result of the multi-stage approval process (e.g. a bus built by a second stage manufacturer on a chassis built by a vehicle manufacturer).

The additional features added during the multi-stage process shall be described briefly.

- 2.3. Model C of the certificate of conformity (incomplete vehicles) shall cover vehicles which need a further stage for their approval (e.g. truck chassis).

Except for tractors for semi-trailers, certificates of conformity covering chassis-cab vehicles belonging to category N shall be of Model C.

PART I

COMPLETE AND COMPLETED VEHICLES*MODEL A1 — SIDE 1**COMPLETE VEHICLES***EC CERTIFICATE OF CONFORMITY***Side 1*

The undersigned [... (*Full name and position*)] hereby certifies that the vehicle:

- 0.1. Make (Trade name of manufacturer): ...

▼B

- 0.2. Type: ...
- Variant ^(a): ...
- Version ^(a): ...
- 0.2.1. Commercial name: ...
- 0.4. Vehicle category: ...
- 0.5. Company name and address of manufacturer: ...
- 0.6. Location and method of attachment of the statutory plates: ...
- Location of the vehicle identification number: ...
- 0.9. Name and address of the manufacturer's representative (if any): ...
- 0.10. Vehicle identification number: ...

conforms in all respects to the type described in approval (... *type-approval number including extension number*) issued on (... *date of issue*) and

can be permanently registered in Member States having right/left ^(b) hand traffic and using metric/imperial ^(c) units for the speedometer and metric/imperial ^(c) units for the odometer (if applicable) ^(d).

(Place) (Date): ...	(Signature): ...
---------------------	------------------

*MODEL A2 — SIDE 1**COMPLETE VEHICLES TYPE-APPROVED IN SMALL SERIES*

[Year]	[Sequential number]
--------	---------------------

EC CERTIFICATE OF CONFORMITY*Side 1*

The undersigned [... (*Full name and position*)] hereby certifies that the vehicle:

- 0.1. Make (Trade name of manufacturer): ...
- 0.2. Type: ...
- Variant ^(a): ...
- Version ^(a): ...
- 0.2.1. Commercial name: ...
- 0.4. Vehicle category: ...
- 0.5. Company name and address of manufacturer: ...
- 0.6. Location and method of attachment of the statutory plates: ...
- Location of the vehicle identification number: ...

▼B

0.9. Name and address of the manufacturer's representative (if any): ...

0.10. Vehicle identification number: ...

conforms in all respects to the type described in approval (... *type-approval number including extension number*) issued on (... *date of issue*) and

can be permanently registered in Member States having right/left (b) hand traffic and using metric/imperial (°) units for the speedometer and metric/imperial (°) units for the odometer (if applicable) (d).

(Place) (Date): ...	(Signature): ...
---------------------	------------------

MODEL B — SIDE 1

COMPLETED VEHICLES

EC CERTIFICATE OF CONFORMITY

Side 1

The undersigned [... (*Full name and position*)] hereby certifies that the vehicle:

0.1. Make (Trade name of the manufacturer): ...

0.2. Type: ...

— Variant (a): ...

— Version (a): ...

0.2.1. Commercial name: ...

0.2.2. For multi-stage approved vehicles, type-approval information of the base/previous stages vehicle (list the information for each stage):

— Type: ...

— Variant (a): ...

— Version (a): ...

Type-approval number, extension number ...

0.4. Vehicle category: ...

0.5. Company name and address of manufacturer: ...

0.5.1. For multi-stage approved vehicles, company name and address of the manufacturer of the base/previous stage(s) vehicle...

0.6. Location and method of attachment of the statutory plates: ...

Location of the vehicle identification number: ...

0.9. Name and address of the manufacturer's representative (if any): ...

▼B

- 0.10. Vehicle identification number: ...
- (a) has been completed and altered ⁽¹⁾ as follows: ... and
- (b) conforms in all respects to the type described in approval (... *type-approval number including extension number*) issued on (... *date of issue*) and
- (c) can be permanently registered in Member States having right/left ^(b) hand traffic and using metric/imperial ^(c) units for the speedometer and metric/imperial ^(c) units for the odometer (if applicable) ^(d).

(Place) (Date): ...	(Signature): ...
---------------------	------------------

Attachments: Certificate of conformity delivered at each previous stage.

*SIDE 2**VEHICLE CATEGORY M1*

(complete and completed vehicles)

*Side 2**General construction characteristics*

1. Number of axles: ... and wheels: ...
3. Powered axles (number, position, interconnection):

Main dimensions

4. Wheelbase ^(e): ... mm
- 4.1. Axle spacing:
- 1-2: ... mm
- 2-3: ... mm
- 3-4: ... mm
5. Length: ... mm
6. Width: ... mm
7. Height: ... mm

Masses

13. Mass in running order: ... kg
- 13.2. Actual mass of the vehicle: ... kg
16. Technically permissible maximum masses
- 16.1. Technically permissible maximum laden mass: ... kg
- 16.2. Technically permissible mass on each axle:
1. ... kg
2. ... kg
3. ... kg etc.

▼B

- 16.4. Technically permissible maximum mass of the combination: ... kg
- 18. Technically permissible maximum towable mass in case of:
 - 18.1. Drawbar trailer: ... kg
 - 18.3. Centre-axle trailer: ... kg
 - 18.4. Unbraked trailer: ... kg
- 19. Technically permissible maximum static vertical mass at the coupling point: ... kg

Power plant

- 20. Manufacturer of the engine: ...
- 21. Engine code as marked on the engine: ...
- 22. Working principle: ...
- 23. Pure electric: yes/no ⁽¹⁾
- 23.1. Class of Hybrid [electric] vehicle: OVC-HEV/NOVC-HEV/OVC-FCHV/ NOVC-FCHV ⁽¹⁾
- 24. Number and arrangement of cylinders: ...
- 25. Engine capacity: ... cm³
- 26. Fuel: Diesel/petrol/LPG/CNG-Biomethane/LNG/Ethanol/Biodiesel/Hydrogen ⁽¹⁾
 - 26.1. Mono fuel/Bi fuel/Flex fuel/Dual-fuel ⁽¹⁾
 - 26.2. (Dual-fuel only) Type 1A/Type 1B/Type 2A/Type 2B/Type 3B ⁽¹⁾
- 27. Maximum power
 - 27.1. Maximum net power ^(§): ... kW at ... min⁻¹ (internal combustion engine) ⁽¹⁾
 - 27.2. Maximum hourly output: ... kW (electric motor) ⁽¹⁾ ^(§)
 - 27.3. Maximum net power: ... kW (electric motor) ⁽¹⁾ ^(§)
 - 27.4. Maximum 30 minutes power: ... kW (electric motor) ⁽¹⁾ ^(§)

Maximum speed

- 29. Maximum speed: ... km/h

Axles and suspension

- 30. Axle(s) track:
 - 1. ... mm
 - 2. ... mm
 - 3. ... mm
- 35. Tyre/wheel combination/Rolling Resistance Class (if applicable) ^(h): ...

Brakes

- 36. Trailer brake connections mechanical/electric/pneumatic/hydraulic ⁽¹⁾

▼ B*Bodywork*

- 38. Code for bodywork ⁽ⁱ⁾: ...
- 40. Colour of vehicle ⁽ⁱ⁾: ...
- 41. Number and configuration of doors: ...
- 42. Number of seating positions (including the driver) ^(k): ...
- 42.1. Seat(s) designated for use only when the vehicle is stationary: ...
- 42.3. Number of wheelchair user accessible position: ...

Environmental performances

- 46. Sound level
 - Stationary: ... dB(A) at engine speed: ... min⁻¹
 - Drive-by: ... dB(A)
- 47. Exhaust emission level ^(l): Euro ...
 - 47.1. Parameters for emission testing
 - 47.1.1. Test mass, kg: ...
 - 47.1.2. Frontal area, m²: ...
 - 47.1.3. Road load coefficients
 - 47.1.3.0. f_0 , N:
 - 47.1.3.1. f_1 , N/(km/h):
 - 47.1.3.2. f_2 , N/(km/h)²
 - 48. Exhaust emissions ^(m) ^(m¹) ^(m²):
 - Number of the base regulatory act and latest amending regulatory act applicable: ...
 - 1.1. test procedure: Type I or ESC ^(l)
 - CO: HC: NO_x: HC + NO_x: Particulates:
 - Smoke opacity (ELR): ... (m⁻¹)
 - 1.2. test procedure: Type 1 (NEDC average values, WLTP highest values) or WHSC (EURO VI) ^(l)
 - CO: ... THC: ... NMHC: ... NO_x: ... THC + NO_x: ... NH₃: ... Particulates (mass): ...
 - Particles (number): ...
 - 2.1. test procedure: ETC (if applicable)
 - CO: ... NO_x: ... NMHC: ... THC: ... CH₄: ... Particulates: ...

▼B

2.2. test procedure: WHTC (EURO VI)

CO: ... NO_x: ... NMHC: ... THC: ... CH₄: ... NH₃: ...
 Particulates (mass): ... Particles (number): ...

48.1. Smoke corrected absorption coefficient: ... (m⁻¹)49. CO₂ emissions/fuel consumption/electric energy consumption^(m) (°):

1. all power trains, except pure electric vehicles (if applicable)

NEDC values	CO ₂ emissions	Fuel consumption in case of emission testing according to Regulation (EC) No 692/2008
Urban conditions ⁽¹⁾ :	... g/km	... l/100 km or m ³ /100 km or kg/100 km ⁽¹⁾
Extra-urban conditions ⁽¹⁾ :	... g/km	l/100 km or m ³ /100 km or kg/100 km ⁽¹⁾
Combined ⁽¹⁾ :	... g/km	... l/100 km or m ³ /100 km or kg/100 km ⁽¹⁾
Weighted ⁽¹⁾ , combined	... g/km	... l/100 km or m ³ /100 km or kg/100 km
Deviation factor (if applicable)		
Verification factor (if applicable)	“1” or “0”	

2. pure electric vehicles and OVC hybrid electric vehicles (if applicable)

Electric energy consumption (weighted, combined ⁽¹⁾)	... Wh/km
Electric range	... km

3. Vehicle fitted with eco-innovation(s): yes/no⁽¹⁾3.1. General code of the eco-innovation(s)^(p1): ...3.2. Total CO₂ emissions savings due to the eco-innovation(s)^(p2) (repeat for each reference fuel tested):

3.2.1. NEDC savings: ...g/km (if applicable)

3.2.2. WLTP savings: ...g/km (if applicable)

4. all power trains, except pure electric vehicle, under Regulation (EU) 2017/1151 (if applicable)

WLTP values	CO ₂ emissions	Fuel consumption
Low ⁽¹⁾ :	... g/km	... l/100 km or m ³ /100 km or kg/100 km ⁽¹⁾
Medium ⁽¹⁾ :	... g/km	... l/100 km or m ³ /100 km or kg/100 km ⁽¹⁾
High ⁽¹⁾ :	... g/km	... l/100 km or m ³ /100 km or kg/100 km ⁽¹⁾
Extra High ⁽¹⁾ :	... g/km	... l/100 km or m ³ /100 km or kg/100 km ⁽¹⁾

▼ B

WLTP values	CO ₂ emissions	Fuel consumption
Combined:	... g/km	... l/100 km or m ³ /100 km or kg/100 km ⁽¹⁾
Weighted, combined ⁽¹⁾	... g/km	... l/100 km or m ³ /100 km or kg/100 km ⁽¹⁾

5. Pure electric vehicles and OVC hybrid electric vehicles, under Regulation (EU) 2017/1151 (if applicable)

5.1. Pure electric vehicles

Electric energy consumption		... Wh/km
Electric range		... km
Electric range city		... km

5.2 OVC hybrid electric vehicles

Electric energy consumption (EC _{AC,weighted})		... Wh/km
Electric range (EAER)		... km
Electric range city (EAER city)		... km

Miscellaneous

51. For special purpose vehicles: designation in accordance with Annex II Section 5: ...

52. Remarks ⁽ⁿ⁾: ...

Additional tyre/wheel combinations: technical parameters (no reference to RR)

SIDE 2

VEHICLE CATEGORY M2

(complete and completed vehicles)

Side 2

General construction characteristics

1. Number of axles: ... and wheels: ...

1.1. Number and position of axles with twin wheels: ...

2. Steered axles (number, position): ...

3. Powered axles (number, position, interconnection):

Main dimensions

4. Wheelbase (°): ... mm

4.1. Axle spacing:

1-2: ... mm

2-3: ... mm

3-4: ... mm

▼B

5. Length: ... mm
6. Width: ... mm
7. Height: ... mm
9. Distance between the front end of the vehicle and the centre of the coupling device: ... mm
12. Rear overhang: ... mm

Masses

13. Mass in running order: ... kg
 - 13.1. Distribution of this mass amongst the axles:
 1. ... kg
 2. ... kg
 3. ... kg etc.
 - 13.2. Actual mass of the vehicle: ... kg
16. Technically permissible maximum masses
 - 16.1. Technically permissible maximum laden mass: ... kg
 - 16.2. Technically permissible mass on each axle:
 1. ... kg
 2. ... kg
 3. ... kg etc.
 - 16.3. Technically permissible mass on each axle group:
 1. ... kg
 2. ... kg
 3. ... kg etc.
 - 16.4. Technically permissible maximum mass of the combination: ... kg
17. Intended registration/in service maximum permissible masses in national/international traffic⁽¹⁾ (°)
 - 17.1. Intended registration/in service maximum permissible laden mass: ... kg
 - 17.2. Intended registration/in service maximum permissible laden mass on each axle:
 1. ... kg
 2. ... kg
 3. ... kg etc.

▼B

- 17.3. Intended registration/in service maximum permissible laden mass on each axle group:
1. ... kg
 2. ... kg
 3. ... kg etc.
- 17.4. Intended registration/in service maximum permissible mass of the combination: ... kg
18. Technically permissible maximum towable mass in case of:
- 18.1. Drawbar trailer: ... kg
- 18.3. Centre-axle trailer: ... kg
- 18.4. Unbraked trailer: ... kg
19. Technically permissible maximum static mass at the coupling point: ... kg

Power plant

20. Manufacturer of the engine: ...
21. Engine code as marked on the engine: ...
22. Working principle: ...
23. Pure electric: yes/no ⁽¹⁾
- 23.1. Class of Hybrid [electric] vehicle: OVC-HEV/NOVC-HEV/OVC-FCHV/ NOVC-FCHV ⁽¹⁾
24. Number and arrangement of cylinders: ...
25. Engine capacity: ... cm³
26. Fuel: Diesel/petrol/LPG/CNG-Biomethane/LNG/Ethanol/Biodiesel/Hydrogen ⁽¹⁾
- 26.1. Mono fuel/Bi fuel/Flex fuel/Dual-fuel ⁽¹⁾
- 26.2. (Dual-fuel only) Type 1A/Type 1B/Type 2A/Type 2B/Type 3B ⁽¹⁾
27. Maximum power
- 27.1. Maximum net power ^(§): ... kW at ... min⁻¹ (internal combustion engine) ⁽¹⁾
- 27.2. Maximum hourly output: ... kW (electric motor) ⁽¹⁾ ^(§)
- 27.3. Maximum net power: ... kW (electric motor) ⁽¹⁾ ^(§)
- 27.4. Maximum 30 minutes power: ... kW (electric motor) ⁽¹⁾ ^(§)
28. Gearbox (type): ...

Maximum speed

29. Maximum speed: ... km/h

▼ B*Axles and suspension*

30. Axle(s) track:
1. ... mm
 2. ... mm
 3. ... mm etc.
33. Drive axle(s) fitted with air suspension or equivalent: yes/no ⁽¹⁾
35. Tyre/wheel combination/Rolling Resistance Class (if applicable) ^(h): ...

Brakes

36. Trailer brake connections mechanical/electric/pneumatic/hydraulic ⁽¹⁾
37. Pressure in feed line for trailer braking system: ... bar

Bodywork

38. Code for bodywork ⁽ⁱ⁾: ...
39. Class of vehicle: class I/Class II/Class III/Class A/Class B ⁽¹⁾
41. Number and configuration of doors: ...
42. Number of seating positions (including the driver) ^(k): ...
- 42.1. Seat(s) designated for use only when the vehicle is stationary: ...
- 42.3. Number of wheelchair user accessible position: ...
43. Number of standing places: ...

Coupling device

44. Approval number or approval mark of coupling device (if fitted): ...
- 45.1. Characteristics values ⁽¹⁾: D: .../ V: .../ S: .../ U: ...

Environmental performances

46. Sound level
- Stationary: ... dB(A) at engine speed: ... min⁻¹
- Drive-by: ... dB(A)
47. Exhaust emission level ^(l): Euro ...
- 47.1. Parameters for emission testing
- 47.1.1. Test mass, kg: ...
- 47.1.2. Frontal area, m²: ...
- 47.1.3. Road load coefficients
- 47.1.3.0. f_0 , N:
- 47.1.3.1. f_1 , N/(km/h):
- 47.1.3.2. f_2 , N/(km/h)²

▼ B48. Exhaust emissions ^(m) ^(m¹) ^(m²):

Number of the base regulatory act and latest amending regulatory act applicable: ...

1.1. test procedure: Type I or ESC ⁽¹⁾

CO: ... HC: ... NO_x: ... HC + NO_x: ... Particulates: ...

Smoke opacity (ELR): ... (m⁻¹)

1.2. test procedure: Type 1 (NEDC average values, WLTP highest values) or WHSC (EURO VI) ⁽¹⁾

CO: ... THC: ... NMHC: ... NO_x: ... THC + NO_x: ... NH₃: ... Particulates (mass): ...

Particles (number): ...

2.1. test procedure: ETC (if applicable)

CO: ... NO_x: ... NMHC: ... THC: ... CH₄: ... Particulates: ...

2.2. test procedure: WHTC (EURO VI)

CO: ... NO_x: ... NMHC: ... THC: ... CH₄: ... NH₃: ... Particulates (mass): ... Particles (number): ...

48.1. Smoke corrected absorption coefficient: ... (m⁻¹)49. CO₂ emissions/fuel consumption/electric energy consumption ^(m) ⁽¹⁾:

1. all power trains, except pure electric vehicles (if applicable)

NEDC values	CO ₂ emissions	Fuel consumption in case of emission testing under NEDC according to Regulation (EC) No 692/2008
Urban conditions ⁽¹⁾ :	... g/km	... l/100 km or m ³ /100 km or kg/100 km ⁽¹⁾
Extra-urban conditions ⁽¹⁾ :	... g/km	l/100 km or m ³ /100 km or kg/100 km ⁽¹⁾
Combined ⁽¹⁾ :	... g/km	... l/100 km or m ³ /100 km or kg/100 km ⁽¹⁾
Weighted ⁽¹⁾ , combined	... g/km	... l/100 km or m ³ /100 km or kg/100 km
Deviation factor (if applicable)		
Verification factor (if applicable)	"1" or "0"	

2. pure electric vehicles and OVC hybrid electric vehicles (if applicable)

Electric energy consumption (weighted, combined ⁽¹⁾)		... Wh/km
Electric range		... km

▼B

3. Vehicle fitted with eco-innovation(s): yes/no ⁽¹⁾
- 3.1. General code of the eco-innovation(s) ^(p1): ...
- 3.2. Total CO₂ emissions savings due to the eco-innovation(s) ^(p2) (repeat for each reference fuel tested):
- 3.2.1. NEDC savings: ...g/km (if applicable)
- 3.2.2. WLTP savings: ...g/km (if applicable)
4. all power trains, except pure electric vehicle, under Regulation (EU) 2017/1151 (if applicable)

WLTP values	CO ₂ emissions	Fuel consumption
Low ⁽¹⁾ :	... g/km	... l/100 km or m ³ /100 km or kg/100 km ⁽¹⁾
Medium ⁽¹⁾ :	... g/km	... l/100 km or m ³ /100 km or kg/100 km ⁽¹⁾
High ⁽¹⁾ :	... g/km	... l/100 km or m ³ /100 km or kg/100 km ⁽¹⁾
Extra High ⁽¹⁾ :	... g/km	... l/100 km or m ³ /100 km or kg/100 km ⁽¹⁾
Combined:	... g/km	... l/100 km or m ³ /100 km or kg/100 km ⁽¹⁾
Weighted, combined ⁽¹⁾	... g/km	... l/100 km or m ³ /100 km or kg/100 km ⁽¹⁾

5. Pure electric vehicles and OVC hybrid electric vehicles, under Regulation (EU) 2017/1151 (if applicable)
- 5.1. Pure electric vehicles

Electric energy consumption		... Wh/km
Electric range		... km
Electric range city		... km

- 5.2. OVC hybrid electric vehicles

Electric energy consumption (EC _{AC,weighted})		... Wh/km
Electric range (EAER)		... km
Electric range city (EAER city)		... km

Miscellaneous

51. For special purpose vehicles: designation in accordance with Annex II Section 5: ...
52. Remarks ⁽ⁿ⁾: ...



SIDE 2
VEHICLE CATEGORY M3
(complete and completed vehicles)

Side 2

General construction characteristics

1. Number of axles: ... and wheels: ...
 - 1.1. Number and position of axles with twin wheels: ...
2. Steered axles (number, position): ...
3. Powered axles (number, position, interconnection):

Main dimensions

4. Wheelbase (°): ... mm
 - 4.1. Axle spacing:
 - 1-2: ... mm
 - 2-3: ... mm
 - 3-4: ... mm
5. Length: ... mm
6. Width: ... mm
7. Height: ... mm
9. Distance between the front end of the vehicle and the centre of the coupling device: ... mm
12. Rear overhang: ... mm

Masses

13. Mass in running order: ... kg
 - 13.1. Distribution of this mass amongst the axles:
 1. ... kg
 2. ... kg
 3. ... kg etc.
 - 13.2. Actual mass of the vehicle: ... kg
16. Technically permissible maximum masses
 - 16.1. Technically permissible maximum laden mass: ... kg
 - 16.2. Technically permissible mass on each axle:
 1. ... kg
 2. ... kg
 3. ... kg etc.

▼B

- 16.3. Technically permissible mass on each axle group:
1. ... kg
 2. ... kg
 3. ... kg etc.
- 16.4. Technically permissible maximum mass of the combination: ... kg
17. Intended registration/in service maximum permissible masses in national/international traffic ⁽¹⁾ (°)
- 17.1. Intended registration/in service maximum permissible laden mass: ... kg
- 17.2. Intended registration/in service maximum permissible laden mass on each axle:
1. ... kg
 2. ... kg
 3. ... kg
- 17.3. Intended registration/in service maximum permissible laden mass on each axle group:
1. ... kg
 2. ... kg
 3. ... kg
- 17.4. Intended registration/in service maximum permissible mass of the combination: ... kg
18. Technically permissible maximum towable mass in case of:
- 18.1. Drawbar trailer: ... kg
- 18.3. Centre-axle trailer: ... kg
- 18.4. Unbraked trailer: ... kg
19. Technically permissible maximum static mass at the coupling point: ... kg

Power plant

20. Manufacturer of the engine: ...
21. Engine code as marked on the engine: ...
22. Working principle: ...
23. Pure electric: yes/no ⁽¹⁾
- 23.1. Hybrid [electric] vehicle: yes/no ⁽¹⁾
24. Number and arrangement of cylinders: ...
25. Engine capacity: ... cm³
26. Fuel: Diesel/petrol/LPG/CNG-Biomethane/LNG/Ethanol/Biodiesel/Hydrogen ⁽¹⁾

▼ B

- 26.1. Mono fuel/Bi fuel/Flex fuel/Dual-fuel ⁽¹⁾
- 26.2. (Dual-fuel only) Type 1A/Type 1B/Type 2A/Type 2B/Type 3B ⁽¹⁾
- 27. Maximum power
- 27.1. Maximum net power ^(§): ... kW at ... min⁻¹ (internal combustion engine) ⁽¹⁾
- 27.2. Maximum hourly output: ... kW (electric motor) ⁽¹⁾ ^(§)
- 27.3. Maximum net power: ... kW (electric motor) ⁽¹⁾ ^(§)
- 27.4. Maximum 30 minutes power: ... kW (electric motor) ⁽¹⁾ ^(§)
- 28. Gearbox (type): ...

Maximum speed

- 29. Maximum speed: ... km/h

Axles and suspension

- 30.1. Track of each steered axle: ... mm
- 30.2. Track of all other axles: ... mm
- 32. Position of loadable axle(s): ...
- 33. Drive axle(s) fitted with air suspension or equivalent: yes/no ⁽¹⁾
- 35. Tyre/wheel combination ^(h): ...

Brakes

- 36. Trailer brake connections mechanical/electric/pneumatic/hydraulic ⁽¹⁾
- 37. Pressure in feed line for trailer braking system: ... bar

Bodywork

- 38. Code for bodywork ⁽ⁱ⁾: ...
- 39. Class of vehicle: class I/Class II/Class III/Class A/Class B ⁽¹⁾
- 41. Number and configuration of doors: ...
- 42. Number of seating positions (including the driver) ^(k): ...
- 42.1. Seat(s) designated for use only when the vehicle is stationary: ...
- 42.2. Number of passenger seating positions: ... (lower deck) ... (upper deck) (including the driver)
- 42.3. Number of wheelchair user accessible position: ...
- 43. Number of standing places: ...

Coupling device

- 44. Approval number or approval mark of coupling device (if fitted): ...

▼B

45.1. Characteristics values ⁽¹⁾: D: .../ V: .../ S: .../ U: ...

Environmental performances

46. Sound level

Stationary: ... dB(A) at engine speed: ... min⁻¹

Drive-by: ... dB(A)

47. Exhaust emission level ⁽¹⁾: Euro ...

47.1. Parameters for emission testing

47.1.1. Test mass, kg: ...

47.1.2. Frontal area, m²: ...

47.1.3. Road load coefficients

47.1.3.0. f_0 , N:

47.1.3.1. f_1 , N/(km/h):

47.1.3.2. f_2 , N/(km/h)²

48. Exhaust emissions ^(m) ^(m¹) ^(m²):

Number of the base regulatory act and latest amending regulatory act applicable: ...

1.1. test procedure: ESC

CO: ... HC: ... NO_x: ... HC + NO_x: ... Particulates: ...

Smoke opacity (ELR): ... (m⁻¹)

1.2. test procedure: WHSC (EURO VI)

CO: ... THC: ... NMHC: ... NO_x: ... THC + NO_x: ...
NH₃: ... Particulates (mass): ... Particles (number): ...

2.1. test procedure: ETC (if applicable)

CO: ... NO_x: ... NMHC: ... THC: ... CH₄: ... Particulates: ...

2.2. test procedure: WHTC (EURO VI)

CO: ... NO_x: ... NMHC: ... THC: ... CH₄: ... NH₃: ...
Particulates (mass): ... Particles (number): ...

48.1. Smoke corrected absorption coefficient: ... (m⁻¹)

Miscellaneous

51. For special purpose vehicles: designation in accordance with Annex II Section 5: ...

52. Remarks ⁽ⁿ⁾: ...



SIDE 2
VEHICLE CATEGORY N1
(complete and completed vehicles)

Side 2

General construction characteristics

1. Number of axles: ... and wheels: ...
- 1.1. Number and position of axles with twin wheels: ...
3. Powered axles (number, position, interconnection):

Main dimensions

4. Wheelbase (°): ... mm
- 4.1. Axle spacing:
 - 1-2: ... mm
 - 2-3: ... mm
 - 3-4: ... mm
5. Length: ... mm
6. Width: ... mm
7. Height: ... mm.
8. Fifth wheel lead for semi-trailer towing vehicle (maximum and minimum): ... mm
9. Distance between the front end of the vehicle and the centre of the coupling device: ... mm
11. Length of the loading area: ... mm

Masses

13. Mass in running order: ... kg
- 13.1. Distribution of this mass amongst the axles:
 1. ... kg
 2. ... kg
 3. ... kg
- 13.2. Actual mass of the vehicle: ... kg
14. Mass of the base vehicle in running order: ... kg ⁽¹⁾ ⁽⁹⁾
16. Technically permissible maximum masses
- 16.1. Technically permissible maximum laden mass: ... kg
- 16.2. Technically permissible mass on each axle:
 1. ... kg
 2. ... kg
 3. ... kg etc.

▼B

16.4. Technically permissible maximum mass of the combination: ... kg

18. Technically permissible maximum towable mass in case of:

18.1. Drawbar trailer: ... kg

18.2. Semi-trailer: ... kg

18.3. Centre-axle trailer: ... kg

18.4. Unbraked trailer: ... kg

19. Technically permissible maximum static mass at the coupling point:
... kg

Power plant

20. Manufacturer of the engine: ...

21. Engine code as marked on the engine: ...

22. Working principle: ...

23. Pure electric: yes/no ⁽¹⁾

23.1. Class of Hybrid [electric] vehicle: OVC-HEV/NOVC-HEV/OVC-FCHV/ NOVC-FCHV ⁽¹⁾

24. Number and arrangement of cylinders: ...

25. Engine capacity: ... cm³

26. Fuel: Diesel/petrol/LPG/CNG-Biomethane/LNG/Ethanol/Biodiesel/
Hydrogen ⁽¹⁾

26.1. Mono fuel/Bi fuel/Flex fuel/Dual-fuel ⁽¹⁾

26.2. (Dual-fuel only) Type 1A/Type 1B/Type 2A/Type 2B/Type 3B ⁽¹⁾

27. Maximum power

27.1. Maximum net power ⁽⁸⁾: ... kW at ... min⁻¹ (internal combustion engine) ⁽¹⁾

27.2. Maximum hourly output: ... kW (electric motor) ⁽¹⁾ ⁽⁸⁾

27.3. Maximum net power: ... kW (electric motor) ⁽¹⁾ ⁽⁸⁾

27.4. Maximum 30 minutes power: ... kW (electric motor) ⁽¹⁾ ⁽⁸⁾

28. Gearbox (type): ...

Maximum speed

29. Maximum speed: ... km/h

Axles and suspension

30. Axle(s) track:

1. ... mm

2. ... mm

3. ... mm

▼B

35. Tyre/wheel combination/Rolling Resistance Class (if applicable) ^(h): ...

Brakes

36. Trailer brake connections mechanical/electric/pneumatic/hydraulic ^(l)

37. Pressure in feed line for trailer braking system: ... bar

Bodywork

38. Code for bodywork ⁽ⁱ⁾: ...

40. Colour of vehicle ⁽ⁱ⁾: ...

41. Number and configuration of doors: ...

42. Number of seating positions (including the driver) ^(k): ...

Coupling device

44. Approval number or approval mark of coupling device (if fitted): ...

45.1. Characteristics values ^(l): D: .../ V: .../ S: .../ U: ...

Environmental performances

46. Sound level

Stationary: ... dB(A) at engine speed: ... min⁻¹

Drive-by: ... dB(A)

47. Exhaust emission level ^(l): Euro ...

47.1. Parameters for emission testing

47.1.1. Test mass, kg: ...

47.1.2. Frontal area, m²: ...

47.1.3. Road load coefficients

47.1.3.0. f_0 , N:

47.1.3.1. f_1 , N/(km/h):

47.1.3.2. f_2 , N/(km/h)²

48. Exhaust emissions ^(m) ^(m¹) ^(m²):

Number of the base regulatory act and latest amending regulatory act applicable: ...

1.1. test procedure: Type 1 or ESC ^(l)

CO: ... HC: ... NO_x: ... HC + NO_x: ... Particulates: ...

Smoke opacity (ELR): ... (m⁻¹)

1.2. test procedure: Type 1 (NEDC average values, WLTP highest values) or WHSC (EURO VI) ^(l)

CO: ... THC: ... NMHC: ... NO_x: ... THC + NO_x: ... NH₃: ... Particulates (mass): ... Particles (number): ...

▼ **B**

2.1. test procedure: ETC (if applicable)

CO: ... NO_x: ... NMHC: ... THC: ... CH₄: ... Particulates: ...

2.2. test procedure: WHTC (EURO VI)

CO: ... NO_x: ... NMHC: ... THC: ... CH₄: ... NH₃: ...
Particulates (mass): ... Particles (number): ...

48.1. Smoke corrected absorption coefficient: ... (m⁻¹)

49. CO₂ emissions/fuel consumption/electric energy consumption (m) (°):

1. all power trains, except pure electric vehicles (if applicable)

NEDC values	CO ₂ emissions	Fuel consumption in case of emission testing according to Regulation (EC) No 692/2008
Urban conditions (°):	... g/km	... l/100 km or m ³ /100 km or kg/100 km (°)
Extra-urban conditions (°):	... g/km	l/100 km or m ³ /100 km or kg/100 km (°)
Combined (°):	... g/km	... l/100 km or m ³ /100 km or kg/100 km (°)
Weighted (°), combined	... g/km	... l/100 km or m ³ /100 km or kg/100 km
Deviation factor (if applicable)		

2. pure electric vehicles and OVC hybrid electric vehicles (if applicable)

Electric energy consumption (weighted, combined (°))		... Wh/km
Electric range		... km

3. Vehicle fitted with eco-innovation(s): yes/no (°)

3.1. General code of the eco-innovation(s) (p¹): ...

3.2. Total CO₂ emissions saving due to the eco-innovation(s) (p²) (repeat for each reference fuel tested):

3.2.1. NEDC savings: ...g/km (if applicable)

3.2.2. WLTP savings: ...g/km (if applicable)

4. all power trains except pure electric vehicles under Regulation (EU) 2017/1151

WLTP values	CO ₂ emissions	Fuel consumption
Low (°):	... g/km	... l/100 km or m ³ /100 km or kg/100 km (°)
Medium (°):	... g/km	... l/100 km or m ³ /100 km or kg/100 km (°)
High (°):	... g/km	... l/100 km or m ³ /100 km or kg/100 km (°)
Extra High (°):	... g/km	... l/100 km or m ³ /100 km or kg/100 km (°)

▼ B

WLTP values	CO ₂ emissions	Fuel consumption
Combined:	... g/km	... l/100 km or m ³ /100 km or kg/100 km ⁽¹⁾
Weighted, combined ⁽¹⁾	... g/km	... l/100 km or m ³ /100 km or kg/100 km ⁽¹⁾

5. Pure electric vehicles and OVC hybrid electric vehicles, under Regulation (EU) 2017/1151 (if applicable)

5.1. Pure electric vehicles ⁽¹⁾ or (if applicable)

Electric energy consumption		... Wh/km
Electric range		... km
Electric range city		... km

5.2 OVC hybrid electric vehicles ⁽¹⁾ or (if applicable)

Electric energy consumption (EC _{AC,weighted})		... Wh/km
Electric range (EAER)		... km
Electric range city (EAER city)		... km

Miscellaneous

50. Type-approved according to the design requirements for transporting dangerous goods: yes/class(es): .../no ⁽¹⁾:

51. For special purpose vehicles: designation in accordance with Annex II Section 5: ...

52. Remarks ⁽ⁿ⁾: ...

List of tyres: technical parameters (no reference to RR)

*SIDE 2**VEHICLE CATEGORY N2*

(complete and completed vehicles)

*Side 2**General construction characteristics*

1. Number of axles: ... and wheels: ...

1.1. Number and position of axles with twin wheels: ...

2. Steered axles (number, position): ...

3. Powered axles (number, position, interconnection):

Main dimensions

4. Wheelbase ^(e): ... mm

▼B

- 4.1. Axle spacing:
 - 1-2: ... mm
 - 2-3: ... mm
 - 3-4: ... mm
5. Length: ... mm
6. Width: ... mm
7. Height: ... mm
8. Fifth wheel lead for semi-trailer towing vehicle (maximum and minimum): ... mm
9. Distance between the front end of the vehicle and the centre of the coupling device: ... mm
11. Length of the loading area: ... mm
12. Rear overhang: ... mm

Masses

13. Mass in running order: ... kg
 - 13.1. Distribution of this mass amongst the axles:
 1. ... kg
 2. ... kg
 3. ... kg
 - 13.2. Actual mass of the vehicle: ... kg
16. Technically permissible maximum masses
 - 16.1. Technically permissible maximum laden mass: ... kg
 - 16.2. Technically permissible mass on each axle:
 1. ... kg
 2. ... kg
 3. ... kg etc.
 - 16.3. Technically permissible mass on each axle group:
 1. ... kg
 2. ... kg
 3. ... kg etc.
 - 16.4. Technically permissible maximum mass of the combination: ... kg
17. Intended registration/in service maximum permissible masses in national/international traffic ⁽¹⁾ ⁽⁹⁾
 - 17.1. Intended registration/in service maximum permissible laden mass: ... kg

▼ B

- 17.2. Intended registration/in service maximum permissible laden mass on each axle:
1. ... kg
 2. ... kg
 3. ... kg
- 17.3. Intended registration/in service maximum permissible laden mass on each axle group:
1. ... kg
 2. ... kg
 3. ... kg
- 17.4. Intended registration/in service maximum permissible mass of the combination: ... kg
18. Technically permissible maximum towable mass in case of:
- 18.1. Drawbar trailer: ... kg
 - 18.2. Semi-trailer: ... kg
 - 18.3. Centre-axle trailer: ... kg
 - 18.4. Unbraked trailer: ... kg
19. Technically permissible maximum static mass at the coupling point: ... kg
- Power plant*
20. Manufacturer of the engine: ...
21. Engine code as marked on the engine: ...
22. Working principle: ...
23. Pure electric: yes/no ⁽¹⁾
- 23.1. Class of Hybrid [electric] vehicle: OVC-HEV/NOVC-HEV/OVC-FCHV/ NOVC-FCHV ⁽¹⁾
24. Number and arrangement of cylinders: ...
25. Engine capacity: ... cm³
26. Fuel: Diesel/petrol/LPG/CNG-Biomethane/LNG/Ethanol/Biodiesel/Hydrogen ⁽¹⁾
- 26.1. Mono fuel/Bi fuel/Flex fuel/Dual-fuel ⁽¹⁾
 - 26.2. (Dual-fuel only) Type 1A/Type 1B/Type 2A/Type 2B/Type 3B ⁽¹⁾
27. Maximum power
- 27.1. Maximum net power ⁽⁸⁾: ... kW at ... min⁻¹ (internal combustion engine) ⁽¹⁾
 - 27.2. Maximum hourly output: ... kW (electric motor) ⁽¹⁾ ⁽⁸⁾
 - 27.3. Maximum net power: ... kW (electric motor) ⁽¹⁾ ⁽⁸⁾

▼ B

27.4. Maximum 30 minutes power: ... kW (electric motor) ⁽¹⁾ ⁽⁶⁾

28. Gearbox (type): ...

Maximum speed

29. Maximum speed: ... km/h

Axles and suspension

31. Position of lift axle(s): ...

32. Position of loadable axle(s): ...

33. Drive axle(s) fitted with air suspension or equivalent: yes/no ⁽¹⁾

35. Tyre/wheel combination/Rolling Resistance Class (if applicable) ^(h): ...

Brakes

36. Trailer brake connections mechanical/electric/pneumatic/hydraulic ⁽¹⁾

37. Pressure in feed line for trailer braking system: ... bar

Bodywork

38. Code for bodywork ⁽ⁱ⁾: ...

41. Number and configuration of doors: ...

42. Number of seating positions (including the driver) ^(k): ...

Coupling device

44. Approval number or approval mark of coupling device (if fitted): ...

45.1. Characteristics values ^(l): D: .../ V: .../ S: .../ U: ...

Environmental performances

46. Sound level

Stationary: ... dB(A) at engine speed: ... min⁻¹

Drive-by: ... dB(A)

47. Exhaust emission level ⁽¹⁾: Euro ...

47.1. Parameters for emission testing

47.1.1. Test mass, kg: ...

47.1.2. Frontal area, m²: ...

47.1.3. Road load coefficients

47.1.3.0. f₀, N:

47.1.3.1. f₁, N/(km/h):

47.1.3.2. f₂, N/(km/h)²

48. Exhaust emissions ^(m) ^(m¹) ^(m²):

▼B

Number of the base regulatory act and latest amending regulatory act applicable: ...

1.1. test procedure: Type 1 or ESC ⁽¹⁾

CO: ... HC: ... NO_x: ... HC + NO_x: ... Particulates: ...

Smoke opacity (ELR): ... (m⁻¹)

1.2. test procedure: Type 1 (NEDC average values, WLTP highest values) or WHSC (EURO VI) ⁽¹⁾

CO: ... THC: ... NMHC: ... NO_x: ... THC + NO_x: ... NH₃:
... Particulates (mass): ... Particles (number): ...

2.1. test procedure: ETC (if applicable)

CO: ... NO_x: ... NMHC: ... THC: ... CH₄: ... Particulates: ...

2.2. test procedure: WHTC (EURO VI)

CO: ... NO_x: ... NMHC: ... THC: ... CH₄: ... NH₃: ...
Particulates (mass): ... Particles (number): ...

48.1. Smoke corrected absorption coefficient: ... (m⁻¹)

49. CO₂ emissions/fuel consumption/electric energy consumption ^(m) ⁽¹⁾:

1. all power trains, except pure electric vehicles (if applicable)

NEDC values	CO ₂ emissions	Fuel consumption in case of emission testing according to Regulation (EC) No 692/2008
Urban conditions ⁽¹⁾ :	... g/km	... l/100 km or m ³ /100 km or kg/100 km ⁽¹⁾
Extra-urban conditions ⁽¹⁾ :	... g/km	l/100 km or m ³ /100 km or kg/100 km ⁽¹⁾
Combined ⁽¹⁾ :	... g/km	... l 1/100 km or m ³ /100 km or kg/100 km ⁽¹⁾
Weighted ⁽¹⁾ , combined	... g/km	... l/100 km or m ³ /100 km or kg/100 km
Deviation factor (if applicable)		

2. pure electric vehicles and OVC hybrid electric vehicles (if applicable)

Electric energy consumption (weighted, combined ⁽¹⁾)		... Wh/km
Electric range		... km

3. Vehicle fitted with eco-innovation(s): yes/no ⁽¹⁾

3.1. General code of the eco-innovation(s) ^(p1): ...

▼B

3.2. Total CO₂ emissions saving due to the eco-innovation(s) (p²) (repeat for each reference fuel tested):

3.2.1. NEDC savings: ...g/km (if applicable)

3.2.2. WLTP savings: ...g/km (if applicable)

4. all power trains except pure electric vehicles under Regulation (EU) 2017/1151

WLTP values	CO ₂ emissions	Fuel consumption
Low ⁽¹⁾ :	... g/km	... l/100 km or m ³ /100 km or kg/100 km ⁽¹⁾
Medium ⁽¹⁾ :	... g/km	... l/100 km or m ³ /100 km or kg/100 km ⁽¹⁾
High ⁽¹⁾ :	... g/km	... l/100 km or m ³ /100 km or kg/100 km ⁽¹⁾
Extra High ⁽¹⁾ :	... g/km	... l/100 km or m ³ /100 km or kg/100 km ⁽¹⁾
Combined:	... g/km	... l/100 km or m ³ /100 km or kg/100 km ⁽¹⁾
Weighted, combined ⁽¹⁾	... g/km	... l/100 km or m ³ /100 km or kg/100 km ⁽¹⁾

5. Pure electric vehicles and OVC hybrid electric vehicles, under Regulation (EU) 2017/1151 (if applicable)

5.1. Pure electric vehicles ⁽¹⁾ or (if applicable)

Electric energy consumption		... Wh/km
Electric range		... km
Electric range city		... km

5.2. OVC hybrid electric vehicles ⁽¹⁾ or (if applicable)

Electric energy consumption (EC _{AC,weighted})		... Wh/km
Electric range (EAER)		... km
Electric range city (EAER city)		... km

Miscellaneous

50. Type-approved according to the design requirements for transporting dangerous goods: yes/class(es): .../no ⁽¹⁾:

51. For special purpose vehicles: designation in accordance with Annex II Section 5: ...

52. Remarks ⁽ⁿ⁾: ...



SIDE 2
VEHICLE CATEGORY N3
(complete and completed vehicles)

Side 2

General construction characteristics

1. Number of axles: ... and wheels: ...
 - 1.1. Number and position of axles with twin wheels: ...
2. Steered axles (number, position): ...
3. Powered axles (number, position, interconnection):

Main dimensions

4. Wheelbase (°): ... mm
 - 4.1. Axle spacing:
 - 1-2: ... mm
 - 2-3: ... mm
 - 3-4: ... mm
5. Length: ... mm
6. Width: ... mm
7. Height: ... mm
8. Fifth wheel lead for semi-trailer towing vehicle (maximum and minimum): ... mm
9. Distance between the front end of the vehicle and the centre of the coupling device: ... mm
11. Length of the loading area: ... mm
12. Rear overhang: ... mm

Masses

13. Mass in running order: ... kg
 - 13.1. Distribution of this mass amongst the axles:
 1. ... kg
 2. ... kg
 3. ... kg
 - 13.2. Actual mass of the vehicle: ... kg
16. Technically permissible maximum masses
 - 16.1. Technically permissible maximum laden mass: ... kg
 - 16.2. Technically permissible mass on each axle:
 1. ... kg
 2. ... kg
 3. ... kg etc.

▼B

- 16.3. Technically permissible mass on each axle group:
1. ... kg
 2. ... kg
 3. ... kg etc.
- 16.4. Technically permissible maximum mass of the combination: ... kg
17. Intended registration/in service maximum permissible masses in national/international traffic ⁽¹⁾ ^(°)
- 17.1. Intended registration/in service maximum permissible laden mass: ... kg
- 17.2. Intended registration/in service maximum permissible laden mass on each axle:
1. ... kg
 2. ... kg
 3. ... kg
- 17.3. Intended registration/in service maximum permissible laden mass on each axle group:
1. ... kg
 2. ... kg
 3. ... kg
- 17.4. Intended registration/in service maximum permissible mass of the combination: ... kg
18. Technically permissible maximum towable mass in case of:
- 18.1. Drawbar trailer: ... kg
- 18.2. Semi-trailer: ... kg
- 18.3. Centre-axle trailer: ... kg
- 18.4. Unbraked trailer: ... kg
19. Technically permissible maximum static mass at the coupling point: ... kg

Power plant

20. Manufacturer of the engine: ...
21. Engine code as marked on the engine: ...
22. Working principle: ...
23. Pure electric: yes/no ⁽¹⁾
- 23.1. Hybrid [electric] vehicle: yes/no ⁽¹⁾
24. Number and arrangement of cylinders: ...
25. Engine capacity: ... cm³

▼ B

26. Fuel: Diesel/petrol/LPG/CNG-Biomethane/LNG/Ethanol/Biodiesel/
Hydrogen ⁽¹⁾

26.1. Mono fuel/Bi fuel/Flex fuel/Dual-fuel ⁽¹⁾

26.2. (Dual-fuel only) Type 1A/Type 1B/Type 2A/Type 2B/Type 3B ⁽¹⁾

27. Maximum power

27.1. Maximum net power ^(g): ... kW at ... min⁻¹ (internal combustion engine) ⁽¹⁾

27.2. Maximum hourly output: ... kW (electric motor) ⁽¹⁾ ^(s)

27.3. Maximum net power: ... kW (electric motor) ⁽¹⁾ ^(s)

27.4. Maximum 30 minutes power: ... kW (electric motor) ⁽¹⁾ ^(s)

28. Gearbox (type): ...

Maximum speed

29. Maximum speed: ... km/h

Axles and suspension

31. Position of lift axle(s): ...

32. Position of loadable axle(s): ...

33. Drive axle(s) fitted with air suspension or equivalent: yes/no ⁽¹⁾

35. Tyre/wheel combination ^(h): ...

Brakes

36. Trailer brake connections mechanical/electric/pneumatic/hydraulic ⁽¹⁾

37. Pressure in feed line for trailer braking system: ... bar

Bodywork

38. Code for bodywork ⁽ⁱ⁾: ...

41. Number and configuration of doors: ...

42. Number of seating positions (including the driver) ^(k): ...

Coupling device

44. Approval number or approval mark of coupling device (if fitted): ...

45.1. Characteristics values ^(l): D: .../ V: .../ S: .../ U: ...

Environmental performances

46. Sound level

Stationary: ... dB(A) at engine speed: ... min⁻¹

Drive-by: ... dB(A)

47. Exhaust emission level ^(l): Euro ...

▼ B

- 47.1. Parameters for emission testing
- 47.1.1. Test mass, kg: ...
- 47.1.2. Frontal area, m²: ...
- 47.1.3. Road load coefficients
- 47.1.3.0. f_0 , N:
- 47.1.3.1. f_1 , N/(km/h):
- 47.1.3.2. f_2 , N/(km/h)²
48. Exhaust emissions (m) (m¹) (m²):
- Number of the base regulatory act and latest amending regulatory act applicable: ...
- 1.1. test procedure: ESC
- CO: ... HC: ... NO_x: ... HC + NO_x: ... Particulates: ...
- Smoke opacity (ELR): ... (m⁻¹)
- 1.2. test procedure: WHSC (EURO VI)
- CO: ... THC: ... NMHC: ... NO_x: ... THC + NO_x: ... NH₃: ... Particulates (mass): ... Particles (number): ...
- 2.1. test procedure: ETC (if applicable)
- CO: ... NO_x: ... NMHC: ... THC: ... CH₄: ... Particulates: ...
- 2.2. test procedure: WHTC (EURO VI)
- CO: ... NO_x: ... NMHC: ... THC: ... CH₄: ... NH₃: ... Particulates (mass): ... Particles (number): ...
- 48.1. Smoke corrected absorption coefficient: ... (m⁻¹)

Miscellaneous

50. Type-approved according to the design requirements for transporting dangerous goods: yes/class(es): .../no (!):
51. For special purpose vehicles: designation in accordance with Annex II Section 5: ...
52. Remarks (ⁿ): ...

*SIDE 2**VEHICLE CATEGORIES O1 AND O2**(complete and completed vehicles)**Side 2**General construction characteristics*

1. Number of axles: ... and wheels: ...
- 1.1. Number and position of axles with twin wheels: ...

▼B*Main dimensions*

4. Wheelbase (°): ... mm
 - 4.1. Axle spacing:
 - 1-2: ... mm
 - 2-3: ... mm
 - 3-4: ... mm
5. Length: ... mm
6. Width: ... mm
7. Height: ... mm
10. Distance between the centre of the coupling device and the rear end of the vehicle: ... mm
11. Length of the loading area: ... mm
12. Rear overhang: ... mm

Masses

13. Mass in running order: ... kg
 - 13.1. Distribution of this mass amongst the axles:
 1. ... kg
 2. ... kg
 3. ... kg
 - 13.2. Actual mass of the vehicle: ... kg
16. Technically permissible maximum masses
 - 16.1. Technically permissible maximum laden mass: ... kg
 - 16.2. Technically permissible mass on each axle:
 1. ... kg
 2. ... kg
 3. ... kg etc.
 - 16.3. Technically permissible mass on each axle group:
 1. ... kg
 2. ... kg
 3. ... kg etc.
19. Technically permissible maximum static mass on the coupling point of a semi-trailer or centre-axle trailer: ... kg

Maximum speed

29. Maximum speed: ... km/h

▼B*Axles and suspension*

- 30.1. Track of each steered axle: ... mm
- 30.2. Track of all other axles: ... mm
- 31. Position of lift axle(s): ...
- 32. Position of loadable axle(s): ...
- 34. Axle(s) fitted with air suspension or equivalent: yes/no ⁽¹⁾
- 35. Tyre/wheel combination ^(h): ...

Brakes

- 36. Trailer brake connections mechanical/electric/pneumatic/hydraulic ⁽¹⁾

Bodywork

- 38. Code for bodywork ⁽ⁱ⁾: ...

Coupling device

- 44. Approval number or approval mark of coupling device (if fitted): ...
- 45.1. Characteristics values ⁽¹⁾: D: .../ V: .../ S: .../ U: ...

Miscellaneous

- 50. Type-approved according to the design requirements for transporting dangerous goods: yes/class(es): .../no ^(l):
- 51. For special purpose vehicles: designation in accordance with Annex II Section 5: ...
- 52. Remarks ⁽ⁿ⁾: ...

*SIDE 2**VEHICLE CATEGORIES O3 AND O4**(complete and completed vehicles)**Side 2**General construction characteristics*

- 1. Number of axles: ... and wheels: ...
- 1.1. Number and position of axles with twin wheels: ...
- 2. Steered axles (number, position): ...

Main dimensions

- 4. Wheelbase ^(e): ... mm
- 4.1. Axle spacing:
 - 1-2: ... mm
 - 2-3: ... mm
 - 3-4: ... mm
- 5. Length: ... mm
- 6. Width: ... mm

▼B

- 7. Height: ... mm
- 10. Distance between the centre of the coupling device and the rear end of the vehicle: ... mm
- 11. Length of the loading area: ... mm
- 12. Rear overhang: ... mm

Masses

- 13. Mass in running order: ... kg
 - 13.1. Distribution of this mass amongst the axles:
 - 1. ... kg
 - 2. ... kg
 - 3. ... kg
 - 13.2. Actual mass of the vehicle: kg
- 16. Technically permissible maximum masses
 - 16.1. Technically permissible maximum laden mass: ... kg
 - 16.2. Technically permissible mass on each axle:
 - 1. ... kg
 - 2. ... kg
 - 3. ... kg etc.
 - 16.3. Technically permissible mass on each axle group:
 - 1. ... kg
 - 2. ... kg
 - 3. ... kg etc.
- 17. Intended registration/in service maximum permissible masses in national/international traffic ⁽¹⁾ (°)
 - 17.1. Intended registration/in service maximum permissible laden mass: ... kg
 - 17.2. Intended registration/in service maximum permissible laden mass on each axle:
 - 1. ... kg
 - 2. ... kg
 - 3. ... kg
 - 17.3. Intended registration/in service maximum permissible laden mass on each axle group:
 - 1. ... kg
 - 2. ... kg
 - 3. ... kg

▼B

19. Technically permissible maximum static mass on the coupling point of a semi-trailer or centre-axle trailer: ... kg

Maximum speed

29. Maximum speed: ... km/h

Axles and suspension

31. Position of lift axle(s): ...
32. Position of loadable axle(s): ...
34. Axle(s) fitted with air suspension or equivalent: yes/no ⁽¹⁾
35. Tyre/wheel combination ^(h): ...

Brakes

36. Trailer brake connections mechanical/electric/pneumatic/hydraulic ⁽¹⁾

Bodywork

38. Code for bodywork ⁽ⁱ⁾: ...

Coupling device

44. Approval number or approval mark of coupling device (if fitted): ...
- 45.1. Characteristics values ⁽¹⁾: D: .../ V: .../ S: .../ U: ...Å

Miscellaneous

50. Type-approved according to the design requirements for transporting dangerous goods: yes/class(es): .../no ⁽¹⁾:
51. For special purpose vehicles: designation in accordance with Annex II Section 5: ...
52. Remarks ⁽ⁿ⁾: ...

PART II

INCOMPLETE VEHICLES*MODEL C1 — SIDE 1***INCOMPLETE VEHICLES****EC CERTIFICATE OF CONFORMITY***Side 1*

The undersigned [... (*Full name and position*)] hereby certifies that the vehicle:

- 0.1. Make (Trade name of manufacturer): ...
- 0.2. Type: ...
- Variant ^(a): ...
- Version ^(a): ...
- 0.2.1. Commercial name: ...
- 0.2.2. For multi-stage approved vehicles, type-approval information of the base/previous stages vehicle

(list the information for each stage):

▼ B

Type:

Variant ^(a):Version ^(a):

Type-approval number, extension number

0.4. Vehicle category: ...

0.5. Company name and address of manufacturer: ...

0.5.1. For multi-stage approved vehicles, company name and address of the manufacturer of the base/previous stage(s) vehicle

0.6. Location and method of attachment of the statutory plates: ...

Location of the vehicle identification number: ...

0.9. Name and address of the manufacturer's representative (if any):

0.10. Vehicle identification number: ...

conforms in all respects to the type described in approval (... *type-approval number including extension number*) issued on (... *date of issue*) and

cannot be permanently registered without further approvals.

(Place) (Date): ...	(Signature): ...
---------------------	------------------

*MODEL C2 — SIDE 1**INCOMPLETE VEHICLES TYPE-APPROVED IN SMALL SERIES*

[Year]	[Sequential number]
--------	---------------------

EC CERTIFICATE OF CONFORMITY*Side 1*The undersigned [... (*Full name and position*)] hereby certifies that the vehicle:

0.1. Make (Trade name of manufacturer): ...

0.2. Type: ...

Variant ^(a): ...Version ^(a): ...

0.2.1. Commercial name: ...

0.4. Vehicle category: ...

0.5. Company name and address of manufacturer: ...

0.6. Location and method of attachment of the statutory plates: ...

Location of the vehicle identification number: ...

▼B

0.9. Name and address of the manufacturer's representative (if any): ...

0.10. Vehicle identification number: ...

conforms in all respects to the type described in approval (... *type-approval number including extension number*) issued on (... *date of issue*) and

cannot be permanently registered without further approvals.

(Place) (Date): ...	(Signature): ...
---------------------	------------------

SIDE 2
VEHICLE CATEGORY M1
(incomplete vehicles)

Side 2

General construction characteristics

1. Number of axles: ... and wheels: ...
3. Powered axles (number, position, interconnection):

Main dimensions

4. Wheelbase (°): ... mm
 - 4.1. Axle spacing:
 - 1-2: ... mm
 - 2-3: ... mm
 - 3-4: ... mm
 - 5.1. Maximum permissible length: ... mm
 - 6.1. Maximum permissible width: ... mm
 - 7.1. Maximum permissible height: ... mm
 - 12.1. Maximum permissible rear overhang: ... mm

Masses

14. Mass in running order of the incomplete vehicle: ... kg
 - 14.1. Distribution of this mass amongst the axles:
 1. ... kg
 2. ... kg
 3. ... kg
 15. Minimum mass of the vehicle when completed: ... kg
 - 15.1. Distribution of this mass amongst the axles:
 1. ... kg
 2. ... kg
 3. ... kg

▼ B

- 16. Technically permissible maximum masses
 - 16.1. Technically permissible maximum laden mass: ... kg
 - 16.2. Technically permissible mass on each axle:
 - 1. ... kg
 - 2. ... kg
 - 3. ... kg etc.
 - 16.4. Technically permissible maximum mass of the combination: ... kg
- 18. Technically permissible maximum towable mass in case of:
 - 18.1. Drawbar trailer: ... kg
 - 18.3. Centre-axle trailer: ... kg
 - 18.4. Unbraked trailer: ... kg
- 19. Technically permissible maximum static vertical mass at the coupling point: ... kg

Power plant

- 20. Manufacturer of the engine: ...
- 21. Engine code as marked on the engine: ...
- 22. Working principle: ...
- 23. Pure electric: yes/no ⁽¹⁾
- 23.1. Hybrid [electric] vehicle: yes/no ⁽¹⁾
- 24. Number and arrangement of cylinders: ...
- 25. Engine capacity: ... cm³
- 26. Fuel: Diesel/petrol/LPG/CNG-Biomethane/LNG/Ethanol/Biodiesel/Hydrogen ⁽¹⁾
 - 26.1. Mono fuel/Bi fuel/Flex fuel/Dual-fuel ⁽¹⁾
 - 26.2. (Dual-fuel only) Type 1A/Type 1B/Type 2A/Type 2B/Type 3B ⁽¹⁾
- 27. Maximum power
 - 27.1. Maximum net power ⁽⁸⁾: ... kW at ... min⁻¹ (internal combustion engine) ⁽¹⁾
 - 27.2. Maximum hourly output: ... kW (electric motor) ⁽¹⁾ ⁽⁸⁾
 - 27.3. Maximum net power: ... kW (electric motor) ⁽¹⁾ ⁽⁸⁾
 - 27.4. Maximum 30 minutes power: ... kW (electric motor) ⁽¹⁾ ⁽⁸⁾

Maximum speed

- 29. Maximum speed: ... km/h

▼ B*Axles and suspension*

30. Axle(s) track:

1. ... mm

2. ... mm

3. ... mm

35. Tyre/wheel combination ^(h): ...

Brakes

36. Trailer brake connections mechanical/electric/pneumatic/hydraulic ^(l)

Bodywork

41. Number and configuration of doors: ...

42. Number of seating positions (including the driver) ^(k): ...

Environmental performances

46. Sound level

Stationary: ... dB(A) at engine speed: ... min⁻¹

Drive-by: ... dB(A)

47. Exhaust emission level ^(l): Euro ...

47.1. Parameters for emission testing

47.1.1. Test mass, kg: ...

47.1.2. Frontal area, m²: ...

47.1.3. Road load coefficients

47.1.3.0. f_0 , N:

47.1.3.1. f_1 , N/(km/h):

47.1.3.2. f_2 , N/(km/h)²

48. Exhaust emissions ^(m) ^(m¹) ^(m²):

Number of the base regulatory act and latest amending regulatory act applicable: ...

1.1. test procedure: Type 1 or ESC ^(l)

CO: ... HC: ... NO_x: ... HC + NO_x: ... Particulates: ...

Smoke opacity (ELR): ... (m⁻¹)

1.2. test procedure: Type 1 (NEDC average values, WLTP highest values) or WHSC (EURO VI) ^(l)

CO: ... THC: ... NMHC: ... NO_x: ... THC + NO_x: ... NH₃: ... Particulates (mass): ... Particles (number): ...

2.1. test procedure: ETC (if applicable)

CO: ... NO_x: ... NMHC: ... THC: ... CH₄: ... Particulates: ...

▼ B

2.2. test procedure: WHTC (EURO VI)

CO: ... NO_x: ... NMHC: ... THC: ... CH₄: ... NH₃: ...
 Particulates (mass): ... Particles (number): ...

48.1. Smoke corrected absorption coefficient: ... (m⁻¹)49. CO₂ emissions/fuel consumption/electric energy consumption (^m):

1. All power trains except pure electric vehicles under Regulation (EU) 2017/1151

	CO ₂ emissions	Fuel consumption
Urban conditions:	... g/km	... l/100 km/m ³ /100 km (¹)
Extra-urban conditions:	... g/km	... l/100 km/m ³ /100 km (¹)
Combined:	... g/km	... l/100 km/m ³ /100 km (¹)
Weighted, combined	... g/km	... l/100 km

2. pure electric vehicles and OVC hybrid electric vehicles

Electric energy consumption (weighted, combined (¹))		... Wh/km
Electric range		... km

*Miscellaneous*52. Remarks (ⁿ): ...*SIDE 2**VEHICLE CATEGORY M2**(incomplete vehicles)**Side 2**General construction characteristics*

1. Number of axles: ... and wheels: ...

1.1. Number and position of axles with twin wheels: ...

2. Steered axles (number, position): ...

3. Powered axles (number, position, interconnection):

*Main dimensions*4. Wheelbase (^e): ... mm

4.1. Axle spacing:

1-2: ... mm

2-3: ... mm

3-4: ... mm

5.1. Maximum permissible length: ... mm

6.1. Maximum permissible width: ... mm

▼B

- 7.1. Maximum permissible height: ... mm
 - 12.1. Maximum permissible rear overhang: ... mm
- Masses*
- 14. Mass in running order of the incomplete vehicle: ... kg
 - 14.1. Distribution of this mass amongst the axles:
 - 1. ... kg
 - 2. ... kg
 - 3. ... kg etc.
 - 15. Minimum mass of the vehicle when completed: ... kg
 - 15.1. Distribution of this mass amongst the axles:
 - 1. ... kg
 - 2. ... kg
 - 3. ... kg
 - 16. Technically permissible maximum masses
 - 16.1. Technically permissible maximum laden mass: ... kg
 - 16.2. Technically permissible mass on each axle:
 - 1. ... kg
 - 2. ... kg
 - 3. ... kg etc.
 - 16.3. Technically permissible mass on each axle group:
 - 1. ... kg
 - 2. ... kg
 - 3. ... kg etc.
 - 16.4. Technically permissible maximum mass of the combination: ... kg
 - 17. Intended registration/in service maximum permissible masses in national/international traffic ⁽¹⁾ (°)
 - 17.1. Intended registration/in service maximum permissible laden mass: ... kg
 - 17.2. Intended registration/in service maximum permissible laden mass on each axle:
 - 1. ... kg
 - 2. ... kg
 - 3. ... kg
 - 17.3. Intended registration/in service maximum permissible laden mass on each axle group:
 - 1. ... kg
 - 2. ... kg
 - 3. ... kg

▼B

- 17.4. Intended registration/in service maximum permissible mass of the combination: ... kg
18. Technically permissible maximum towable mass in case of:
- 18.1. Drawbar trailer: ... kg
- 18.3. Centre-axle trailer: ... kg
- 18.4. Unbraked trailer: ... kg
19. Technically permissible maximum static mass at the coupling point: ... kg

Power plant

20. Manufacturer of the engine: ...
21. Engine code as marked on the engine: ...
22. Working principle: ...
23. Pure electric: yes/no ⁽¹⁾
- 23.1. Hybrid [electric] vehicle: yes/no ⁽¹⁾
24. Number and arrangement of cylinders: ...
25. Engine capacity: ... cm³
26. Fuel: Diesel/petrol/LPG/CNG-Biomethane/LNG/Ethanol/Biodiesel/Hydrogen ⁽¹⁾
- 26.1. Mono fuel/Bi fuel/Flex fuel/Dual-fuel ⁽¹⁾
- 26.2. (Dual-fuel only) Type 1A/Type 1B/Type 2A/Type 2B/Type 3B ⁽¹⁾
27. Maximum power
- 27.1. Maximum net power ⁽⁸⁾: ... kW at ... min⁻¹ (internal combustion engine) ⁽¹⁾
- 27.2. Maximum hourly output: ... kW (electric motor) ⁽¹⁾ ⁽⁸⁾
- 27.3. Maximum net power: ... kW (electric motor) ⁽¹⁾ ⁽⁸⁾
- 27.4. Maximum 30 minutes power: ... kW (electric motor) ⁽¹⁾ ⁽⁸⁾
28. Gearbox (type): ...

Maximum speed

29. Maximum speed: ... km/h

Axles and suspension

30. Axle(s) track:
1. ... mm
2. ... mm
3. ... mm

▼ B

33. Drive axle(s) fitted with air suspension or equivalent: yes/no ⁽¹⁾

35. Tyre/wheel combination ^(h): ...

Brakes

36. Trailer brake connections mechanical/electric/pneumatic/hydraulic ⁽¹⁾

37. Pressure in feed line for trailer braking system: ... bar

Coupling device

44. Approval number or approval mark of coupling device (if fitted): ...

45. Type or classes of coupling devices which can be fitted: ...

45.1. Characteristics values ⁽¹⁾: D: .../ V: .../ S: .../ U: ...

Environmental performances

46. Sound level

Stationary: ... dB(A) at engine speed: ... min⁻¹

Drive-by: ... dB(A)

47. Exhaust emission level ⁽¹⁾: Euro ...

47.1. Parameters for emission testing

47.1.1. Test mass, kg: ...

47.1.2. Frontal area, m²: ...

47.1.3. Road load coefficients

47.1.3.0. f_0 , N:

47.1.3.1. f_1 , N/(km/h):

47.1.3.2. f_2 , N/(km/h)²

48. Exhaust emissions ^(m) ^(m¹) ^(m²):

Number of the base regulatory act and latest amending regulatory act applicable: ...

1.1. test procedure: Type 1 or ESC ⁽¹⁾

CO: ... HC: ... NO_x: ... HC + NO_x: ... Particulates: ...

Smoke opacity (ELR): ... (m⁻¹)

1.2. test procedure: Type 1 (NEDC average values, WLTP highest values) or WHSC (EURO VI) ⁽¹⁾

CO: ... THC: ... NMHC: ... NO_x: ... THC + NO_x: ... NH₃: ... Particulates (mass): ... Particles (number): ...

2.1. test procedure: ETC (if applicable)

CO: ... NO_x: ... NMHC: ... THC: ... CH₄: ... Particulates: ...

▼ B

2.2. test procedure: WHTC (EURO VI)

CO: ... NO_x: ... NMHC: ... THC: ... CH₄: ... NH₃: ...
 Particulates (mass): ... Particles (number): ...

48.1. Smoke corrected absorption coefficient: ... (m⁻¹)

Miscellaneous

52. Remarks ⁽ⁿ⁾: ...

SIDE 2

VEHICLE CATEGORY M3

(incomplete vehicles)

Side 2

General construction characteristics

1. Number of axles: ... and wheels: ...
 - 1.1. Number and position of axles with twin wheels: ...
2. Steered axles (number, position): ...
3. Powered axles (number, position, interconnection):

Main dimensions

4. Wheelbase (°): ... mm
 - 4.1. Axle spacing:
 - 1-2: ... mm
 - 2-3: ... mm
 - 3-4: ... mm
 - 5.1. Maximum permissible length: ... mm
 - 6.1. Maximum permissible width: ... mm
 - 7.1. Maximum permissible height: ... mm
 - 12.1. Maximum permissible rear overhang: ... mm

Masses

14. Mass in running order of the incomplete vehicle: ... kg
 - 14.1. Distribution of this mass amongst the axles:
 1. ... kg
 2. ... kg
 3. ... kg etc.
15. Minimum mass of the vehicle when completed: ... kg
 - 15.1. Distribution of this mass amongst the axles:
 1. ... kg
 2. ... kg
 3. ... kg

▼B

16. Technically permissible maximum masses
 - 16.1. Technically permissible maximum laden mass: ... kg
 - 16.2. Technically permissible mass on each axle:
 1. ... kg
 2. ... kg
 3. ... kg etc.
 - 16.3. Technically permissible mass on each axle group:
 1. ... kg
 2. ... kg
 3. ... kg etc.
 - 16.4. Technically permissible maximum mass of the combination: ... kg
 17. Intended registration/in service maximum permissible masses in national/international traffic ⁽¹⁾ ^(e)
 - 17.1. Intended registration/in service maximum permissible laden mass: ... kg
 - 17.2. Intended registration/in service maximum permissible laden mass on each axle:
 1. ... kg
 2. ... kg
 3. ... kg
 - 17.3. Intended registration/in service maximum permissible laden mass on each axle group:
 1. ... kg
 2. ... kg
 3. ... kg
 - 17.4. Intended registration/in service maximum permissible mass of the combination: ... kg
 18. Technically permissible maximum towable mass in case of:
 - 18.1. Drawbar trailer: ... kg
 - 18.3. Centre-axle trailer: ... kg
 - 18.4. Unbraked trailer: ... kg
 19. Technically permissible maximum static mass at the coupling point: ... kg
- Power plant*
20. Manufacturer of the engine: ...
 21. Engine code as marked on the engine: ...
 22. Working principle: ...

▼ B

23. Pure electric: yes/no ⁽¹⁾
- 23.1. Hybrid [electric] vehicle: yes/no ⁽¹⁾
24. Number and arrangement of cylinders: ...
25. Engine capacity: ... cm³
26. Fuel: Diesel/petrol/LPG/CNG-Biomethane/LNG/Ethanol/Biodiesel/Hydrogen ⁽¹⁾
- 26.1. Mono fuel/Bi fuel/Flex fuel/Dual-fuel ⁽¹⁾
- 26.2. (Dual-fuel only) Type 1A/Type 1B/Type 2A/Type 2B/Type 3B ⁽¹⁾
27. Maximum power
- 27.1. Maximum net power ^(g): ... kW at ... min⁻¹ (internal combustion engine) ⁽¹⁾
- 27.2. Maximum hourly output: ... kW (electric motor) ⁽¹⁾ ^(g)
- 27.3. Maximum net power: ... kW (electric motor) ⁽¹⁾ ^(g)
- 27.4. Maximum 30 minutes power: ... kW (electric motor) ⁽¹⁾ ^(g)
28. Gearbox (type): ...
- Maximum speed*
29. Maximum speed: ... km/h
- Axles and suspension*
- 30.1. Track of each steered axle: ... mm
- 30.2. Track of all other axles: ... mm
32. Position of loadable axle(s): ...
33. Drive axle(s) fitted with air suspension or equivalent: yes/no ⁽¹⁾
35. Tyre/wheel combination ^(h): ...
- Brakes*
36. Trailer brake connections mechanical/electric/pneumatic/hydraulic ⁽¹⁾
37. Pressure in feed line for trailer braking system: ... bar
- Coupling device*
44. Approval number or approval mark of coupling device (if fitted): ...
45. Types or classes of coupling devices which can be fitted: ...
- 45.1. Characteristics values ⁽¹⁾: D: .../ V: .../ S: .../ U: ...
- Environmental performances*
46. Sound level

▼B

Stationary: ... dB(A) at engine speed: ... min⁻¹

Drive-by: ... dB(A)

47. Exhaust emission level (l): Euro ...

47.1. Parameters for emission testing

47.1.1. Test mass, kg: ...

47.1.2. Frontal area, m²: ...

47.1.3. Road load coefficients

47.1.3.0. f_0 , N:

47.1.3.1. f_1 , N/(km/h):

47.1.3.2. f_2 , N/(km/h)²

48. Exhaust emissions (m) (m¹) (m²):

Number of the base regulatory act and latest amending regulatory act applicable: ...

1.1. test procedure: ESC

CO: ... HC: ... NO_x: ... HC + NO_x: ... Particulates: ...

Smoke opacity (ELR): ... (m⁻¹)

1.2. test procedure: WHSC (EURO VI)

CO: ... THC: ... NMHC: ... NO_x: ... THC + NO_x: ...
NH₃: ... Particulates (mass): ... Particles (number): ...

2.1. test procedure: ETC (if applicable)

CO: ... NO_x: ... NMHC: ... THC: ... CH₄: ... Particulates: ...

2.2. test procedure: WHTC (EURO VI)

CO: ... NO_x: ... NMHC: ... THC: ... CH₄: ... NH₃: ...
Particulates (mass): ... Particles (number): ...

48.1. Smoke corrected absorption coefficient: ... (m⁻¹)

Miscellaneous

52. Remarks (n): ...

SIDE 2

VEHICLE CATEGORY N1

(incomplete vehicles)

Side 2

General construction characteristics

1. Number of axles: ... and wheels: ...

1.1. Number and position of axles with twin wheels: ...

▼B

3. Powered axles (number, position, interconnection):

Main dimensions

4. Wheelbase (°): ... mm
- 4.1. Axle spacing:
 - 1-2: ... mm
 - 2-3: ... mm
 - 3-4: ... mm
- 5.1. Maximum permissible length: ... mm
- 6.1. Maximum permissible width: ... mm
- 7.1. Maximum permissible height: ... mm
8. Fifth wheel lead for semi-trailer towing vehicle (maximum and minimum): ... mm
- 12.1. Maximum permissible rear overhang: ... mm

Masses

14. Mass in running order of the incomplete vehicle: ... kg
- 14.1. Distribution of this mass amongst the axles:
 1. ... kg
 2. ... kg
 3. ... kg etc.
15. Minimum mass of the vehicle when completed: ... kg
- 15.1. Distribution of this mass amongst the axles:
 1. ... kg
 2. ... kg
 3. ... kg
16. Technically permissible maximum masses
- 16.1. Technically permissible maximum laden mass: ... kg
- 16.2. Technically permissible mass on each axle:
 1. ... kg
 2. ... kg
 3. ... kg etc.
- 16.4. Technically permissible maximum mass of the combination: ... kg
18. Technically permissible maximum towable mass in case of:
 - 18.1. Drawbar trailer: ... kg
 - 18.2. Semi-trailer: ... kg

▼ B

- 18.3. Centre-axle trailer: ... kg
- 18.4. Unbraked trailer: ... kg
- 19. Technically permissible maximum static mass at the coupling point:
... kg

Power plant

- 20. Manufacturer of the engine: ...
- 21. Engine code as marked on the engine: ...
- 22. Working principle: ...
- 23. Pure electric: yes/no ⁽¹⁾
- 23.1. Hybrid [electric] vehicle: yes/no ⁽¹⁾
- 24. Number and arrangement of cylinders: ...
- 25. Engine capacity: ... cm³
- 26. Fuel: Diesel/petrol/LPG/CNG-Biomethane/LNG/Ethanol/Biodiesel/
Hydrogen ⁽¹⁾
- 26.1. Mono fuel/Bi fuel/Flex fuel/Dual-fuel ⁽¹⁾
- 26.2. (Dual-fuel only) Type 1A/Type 1B/Type 2A/Type 2B/Type 3B ⁽¹⁾
- 27. Maximum power
- 27.1. Maximum net power ⁽⁸⁾: ... kW at ... min⁻¹ (internal combustion
engine) ⁽¹⁾
- 27.2. Maximum hourly output: ... kW (electric motor) ⁽¹⁾ ⁽⁸⁾
- 27.3. Maximum net power: ... kW (electric motor) ⁽¹⁾ ⁽⁸⁾
- 27.4. Maximum 30 minutes power: ... kW (electric motor) ⁽¹⁾ ⁽⁸⁾
- 28. Gearbox (type): ...

Maximum speed

- 29. Maximum speed: ... km/h

Axles and suspension

- 30. Axle(s) track:
 - 1. ... mm
 - 2. ... mm
 - 3. ... mm
- 35. Tyre/wheel combination ^(h): ...

Brakes

- 36. Trailer brake connections mechanical/electric/pneumatic/hydraulic ⁽¹⁾
- 37. Pressure in feed line for trailer braking system: ... bar

▼B*Coupling device*

44. Approval number or approval mark of coupling device (if fitted): ...
45. Types or classes of coupling devices which can be fitted: ...
- 45.1. Characteristics values ⁽¹⁾: D: .../ V: .../ S: .../ U: ...

Environmental performances

46. Sound level
- Stationary: ... dB(A) at engine speed: ... min⁻¹
- Drive-by: ... dB(A)
47. Exhaust emission level ⁽¹⁾: Euro ...
- 47.1. Parameters for emission testing
- 47.1.1. Test mass, kg: ...
- 47.1.2. Frontal area, m²: ...
- 47.1.3. Road load coefficients
- 47.1.3.0. f_0 , N:
- 47.1.3.1. f_1 , N/(km/h):
- 47.1.3.2. f_2 , N/(km/h)²
48. Exhaust emissions ^(m) ^(m¹) ^(m²):
- Number of the base regulatory act and latest amending regulatory act applicable: ...
- 1.1. test procedure: Type 1 or ESC ⁽¹⁾
- CO: ... HC: ... NO_x: ... HC + NO_x: ... Particulates: ...
- Smoke opacity (ELR): ... (m⁻¹)
- 1.2. test procedure: Type 1 (NEDC average values, WLTP highest values) or WHSC (EURO VI) ⁽¹⁾
- CO: ... THC: ... NMHC: ... NO_x: ... THC + NO_x: ... NH₃: ... Particulates (mass): ... Particles (number): ...
- 2.1. test procedure: ETC (if applicable)
- CO: ... NO_x: ... NMHC: ... THC: ... CH₄: ... Particulates:
- 2.2. test procedure: WHTC (EURO VI)
- CO: ... NO_x: ... NMHC: ... THC: ... CH₄: ... NH₃: ... Particulates (mass): ... Particles (number):
- 48.1. Smoke corrected absorption coefficient: ... (m⁻¹)

▼ B49. CO₂ emissions/fuel consumption/electric energy consumption ^(m):

1. all power trains except pure electric vehicles under Regulation (EU) 2017/1151

	CO ₂ emissions	Fuel consumption
Urban conditions:	... g/km	... l/100 km/m ³ /100 km ⁽¹⁾
Extra-urban conditions:	... g/km	... l/100 km/m ³ /100 km ⁽¹⁾
Combined:	... g/km	... l/100 km/m ³ /100 km ⁽¹⁾
Weighted, combined	... g/km	... l/100 km

2. pure electric vehicles and OVC hybrid electric vehicles

Electric energy consumption (weighted, combined ⁽¹⁾)		... Wh/km
Electric range		... km

3. Vehicle fitted with eco-innovation(s): yes/no ⁽¹⁾3.1. General code of the eco-innovation(s) ^(p1): ...3.2. Total CO₂ emissions saving due to the eco-innovation(s) ^(p2)
(repeat for each reference fuel tested): ...*Miscellaneous*52. Remarks ⁽ⁿ⁾: ...*SIDE 2**VEHICLE CATEGORY N2**(incomplete vehicles)**Side 2**General construction characteristics*

1. Number of axles: ... and wheels: ...

1.1. Number and position of axles with twin wheels: ...

2. Steered axles (number, position): ...

3. Powered axles (number, position, interconnection):

*Main dimensions*4. Wheelbase ^(e): ... mm

▼B

- 4.1. Axle spacing:
 - 1-2: ... mm
 - 2-3: ... mm
 - 3-4: ... mm
- 5.1. Maximum permissible length: ... mm
- 6.1. Maximum permissible width: ... mm
- 8. Fifth wheel lead for semi-trailer towing vehicle (maximum and minimum): ... mm
- 12.1. Maximum permissible rear overhang: ... mm

Masses

- 14. Mass in running order of the incomplete vehicle: ... kg
 - 14.1. Distribution of this mass amongst the axles:
 - 1. ... kg
 - 2. ... kg
 - 3. ... kg etc.
 - 15. Minimum mass of the vehicle when completed: ... kg
 - 15.1. Distribution of this mass amongst the axles:
 - 1. ... kg
 - 2. ... kg
 - 3. ... kg
 - 16. Technically permissible maximum masses
 - 16.1. Technically permissible maximum laden mass: ... kg
 - 16.2. Technically permissible mass on each axle:
 - 1. ... kg
 - 2. ... kg
 - 3. ... kg etc.
 - 16.3. Technically permissible mass on each axle group:
 - 1. ... kg
 - 2. ... kg
 - 3. ... kg etc.
 - 16.4. Technically permissible maximum mass of the combination: ... kg
 - 17. Intended registration/in service maximum permissible masses in national/international traffic⁽¹⁾ (°)
 - 17.1. Intended registration/in service maximum permissible laden mass: ... kg

▼B

- 17.2. Intended registration/in service maximum permissible laden mass on each axle:
1. ... kg
 2. ... kg
 3. ... kg
- 17.3. Intended registration/in service maximum permissible laden mass on each axle group:
1. ... kg
 2. ... kg
 3. ... kg
- 17.4. Intended registration/in service maximum permissible mass of the combination: ... kg
18. Technically permissible maximum towable mass in case of:
- 18.1. Drawbar trailer: ... kg
 - 18.2. Semi-trailer: ... kg
 - 18.3. Centre-axle trailer: ... kg
 - 18.4. Unbraked trailer: ... kg
19. Technically permissible maximum static mass at the coupling point: ... kg
- Power plant*
20. Manufacturer of the engine: ...
21. Engine code as marked on the engine: ...
22. Working principle: ...
23. Pure electric: yes/no ⁽¹⁾
- 23.1. Hybrid [electric] vehicle: yes/no ⁽¹⁾
24. Number and arrangement of cylinders: ...
25. Engine capacity: ... cm³
26. Fuel: Diesel/petrol/LPG/CNG-Biomethane/LNG/Ethanol/Biodiesel/Hydrogen ⁽¹⁾
- 26.1. Mono fuel/Bi fuel/Flex fuel/Dual-fuel ⁽¹⁾
- 26.2. (Dual-fuel only) Type 1A/Type 1B/Type 2A/Type 2B/Type 3B ⁽¹⁾
27. Maximum power
- 27.1. Maximum net power ^(g): ... kW at ... min⁻¹ (internal combustion engine) ⁽¹⁾

▼ B

27.2. Maximum hourly output: ... kW (electric motor) ⁽¹⁾ ⁽⁵⁾

27.3. Maximum net power: ... kW (electric motor) ⁽¹⁾ ⁽⁵⁾

27.4. Maximum 30 minutes power: ... kW (electric motor) ⁽¹⁾ ⁽⁵⁾

28. Gearbox (type): ...

Maximum speed

29. Maximum speed: ... km/h

Axles and suspension

31. Position of lift axle(s): ...

32. Position of loadable axle(s): ...

33. Drive axle(s) fitted with air suspension or equivalent: yes/no ⁽¹⁾

35. Tyre/wheel combination ^(b): ...

Brakes

36. Trailer brake connections mechanical/electric/pneumatic/hydraulic ⁽¹⁾

37. Pressure in feed line for trailer braking system: ... bar

Coupling device

44. Approval number or approval mark of coupling device (if fitted): ...

45. Types or classes of coupling devices which can be fitted: ...

45.1. Characteristics values ⁽¹⁾: D: .../ V: .../ S: .../ U: ...

Environmental performances

46. Sound level

Stationary: ... dB(A) at engine speed: ... min⁻¹

Drive-by: ... dB(A)

47. Exhaust emission level ⁽¹⁾: Euro ...

47.1. Parameters for emission testing

47.1.1. Test mass, kg: ...

47.1.2. Frontal area, m²: ...

47.1.3. Road load coefficients

47.1.3.0. f₀, N:

▼B

47.1.3.1. f_1 , N/(km/h):

47.1.3.2. f_2 , N/(km/h)²

48. Exhaust emissions (^m) (^m¹) (^m²):

Number of the base regulatory act and latest amending regulatory act applicable: ...

1.1. test procedure: Type 1 or ESC (¹)

CO: ... HC: ... NO_x: ... HC + NO_x: ... Particulates: ...

Smoke opacity (ELR): ... (m⁻¹)

1.2. test procedure: Type 1 (NEDC average values, WLTP highest values) or WHSC (EURO VI) (¹)

CO: ... THC: ... NMHC: ... NO_x: ... THC + NO_x: ... NH₃:
... Particulates (mass): ... Particles (number): ...

2.1. test procedure: ETC (if applicable)

CO: ... NO_x: ... NMHC: ... THC: ... CH₄: ... Particulates:

2.2. test procedure: WHTC (EURO VI)

CO: ... NO_x: ... NMHC: ... THC: ... CH₄: ... NH₃: ...
Particulates (mass): ... Particles (number): ...

48.1. Smoke corrected absorption coefficient: ... (m⁻¹)

Miscellaneous

52. Remarks (ⁿ): ...

SIDE 2

VEHICLE CATEGORY N3

(incomplete vehicles)

Side 2

General construction characteristics

1. Number of axles: ... and wheels: ...

1.1. Number and position of axles with twin wheels: ...

2. Steered axles (number, position): ...

3. Powered axles (number, position, interconnection):

Main dimensions

4. Wheelbase (°): ... mm

4.1. Axle spacing:

1-2: ... mm

2-3: ... mm

3-4: ... mm

▼B

- 5.1. Maximum permissible length: ... mm
- 6.1. Maximum permissible width: ... mm
- 8. Fifth wheel lead for semi-trailer towing vehicle (maximum and minimum): ... mm
- 12.1. Maximum permissible rear overhang: ... mm

Masses

- 14. Mass in running order of the incomplete vehicle: ... kg
 - 14.1. Distribution of this mass amongst the axles:
 - 1. ... kg
 - 2. ... kg
 - 3. ... kg etc.
 - 15. Minimum mass of the vehicle when completed: ... kg
 - 15.1. Distribution of this mass amongst the axles:
 - 1. ... kg
 - 2. ... kg
 - 3. ... kg
 - 16. Technically permissible maximum masses
 - 16.1. Technically permissible maximum laden mass: ... kg
 - 16.2. Technically permissible mass on each axle:
 - 1. ... kg
 - 2. ... kg
 - 3. ... kg etc.
 - 16.3. Technically permissible mass on each axle group:
 - 1. ... kg
 - 2. ... kg
 - 3. ... kg etc.
 - 16.4. Technically permissible maximum mass of the combination: ... kg
 - 17. Intended registration/in service maximum permissible masses in national/international traffic⁽¹⁾ (°)
 - 17.1. Intended registration/in service maximum permissible laden mass: ... kg
 - 17.2. Intended registration/in service maximum permissible laden mass on each axle:
 - 1. ... kg
 - 2. ... kg
 - 3. ... kg

▼B

- 17.3. Intended registration/in service maximum permissible laden mass on each axle group:
1. ... kg
 2. ... kg
 3. ... kg
- 17.4. Intended registration/in service maximum permissible mass of the combination: ... kg
18. Technically permissible maximum towable mass in case of:
- 18.1. Drawbar trailer: ... kg
 - 18.2. Semi-trailer: ... kg
 - 18.3. Centre-axle trailer: ... kg
 - 18.4. Unbraked trailer: ... kg
19. Technically permissible maximum static mass at the coupling point: ... kg

Power plant

20. Manufacturer of the engine: ...
21. Engine code as marked on the engine: ...
22. Working principle: ...
23. Pure electric: yes/no ⁽¹⁾
- 23.1. Hybrid [electric] vehicle: yes/no ⁽¹⁾
24. Number and arrangement of cylinders: ...
25. Engine capacity: ... cm³
26. Fuel: Diesel/petrol/LPG/CNG-Biomethane/LNG/Ethanol/Biodiesel/Hydrogen ⁽¹⁾
- 26.1. Mono fuel/Bi fuel/Flex fuel/Dual-fuel ⁽¹⁾
 - 26.2. (Dual-fuel only) Type 1A/Type 1B/Type 2A/Type 2B/Type 3B ⁽¹⁾
27. Maximum power
- 27.1. Maximum net power ⁽⁸⁾: ... kW at ... min⁻¹ (internal combustion engine) ⁽¹⁾
 - 27.2. Maximum hourly output: ... kW (electric motor) ⁽¹⁾ ⁽⁸⁾
 - 27.3. Maximum net power: ... kW (electric motor) ⁽¹⁾ ⁽⁸⁾
 - 27.4. Maximum 30 minutes power: ... kW (electric motor) ⁽¹⁾ ⁽⁸⁾
28. Gearbox (type): ...

Maximum speed

29. Maximum speed: ... km/h

▼B*Axles and suspension*

- 31. Position of lift axle(s): ...
- 32. Position of loadable axle(s): ...
- 33. Drive axle(s) fitted with air suspension or equivalent: yes/no ⁽¹⁾
- 35. Tyre/wheel combination ^(h): ...

Brakes

- 36. Trailer brake connections mechanical/electric/pneumatic/hydraulic ⁽¹⁾
- 37. Pressure in feed line for trailer braking system: ... bar

Coupling device

- 44. Approval number or approval mark of coupling device (if fitted): ...
- 45. Types or classes of coupling devices which can be fitted: ...
- 45.1. Characteristics values ⁽¹⁾: D: .../ V: .../ S: .../ U: ...

Environmental performances

- 46. Sound level
 - Stationary: ... dB(A) at engine speed: ... min⁻¹
 - Drive-by: ... dB(A)
- 47. Exhaust emission level ⁽¹⁾: Euro ...
 - 47.1. Parameters for emission testing
 - 47.1.1. Test mass, kg: ...
 - 47.1.2. Frontal area, m²: ...
 - 47.1.3. Road load coefficients
 - 47.1.3.0. f₀, N:
 - 47.1.3.1. f₁, N/(km/h):
 - 47.1.3.2. f₂, N/(km/h)²
- 48. Exhaust emissions ^(m) ^(m¹) ^(m²):
 - Number of the base regulatory act and latest amending regulatory act applicable: ...
 - 1.1. test procedure: ESC
 - CO: ... HC: ... NO_x: ... HC + NO_x: ... Particulates: ...

▼ B

Smoke opacity (ELR): ... (m⁻¹)

1.2. test procedure: WHSC (EURO VI)

CO: ... THC: ... NMHC: ... NO_x: ... THC + NO_x: ...
NH₃: ... Particulates (mass): ... Particles (number): ...

2.1. test procedure: ETC (if applicable)

CO: ... NO_x: ... NMHC: ... THC: ... CH₄: ... Particulates:

2.2. test procedure: WHTC (EURO VI)

CO: ... NO_x: ... NMHC: ... THC: ... CH₄: ... NH₃: ...
Particulates (mass): ... Particles (number): ...

48.1. Smoke corrected absorption coefficient: ... (m⁻¹)

Miscellaneous

52. Remarks ⁽ⁿ⁾: ...

*SIDE 2**VEHICLE CATEGORIES O1 AND O2*

(incomplete vehicles)

*Side 2**General construction characteristics*

1. Number of axles: ... and wheels: ...

1.1. Number and position of axles with twin wheels: ...

Main dimensions

4. Wheelbase (°): ... mm

4.1. Axle spacing:

1-2: ... mm

2-3: ... mm

3-4: ... mm

5.1. Maximum permissible length: ... mm

6.1. Maximum permissible width: ... mm

7.1. Maximum permissible height: ... mm

10. Distance between the centre of the coupling device and the rear end of the vehicle: ... mm

12.1. Maximum permissible rear overhang: ... mm

Masses

14. Mass in running order of the incomplete vehicle: ... kg

▼B

- 14.1. Distribution of this mass amongst the axles:
1. ... kg
 2. ... kg
 3. ... kg
15. Minimum mass of the vehicle when completed: ... kg
- 15.1. Distribution of this mass amongst the axles:
1. ... kg
 2. ... kg
 3. ... kg
16. Technically permissible maximum masses
- 16.1. Technically permissible maximum laden mass: ... kg
- 16.2. Technically permissible mass on each axle:
1. ... kg
 2. ... kg
 3. ... kg etc.
- 16.3. Technically permissible mass on each axle group:
1. ... kg
 2. ... kg
 3. ... kg etc.
- 19.1. Technically permissible maximum static mass on the coupling point of a semi-trailer or centre-axle trailer: ... kg

Maximum speed

29. Maximum speed: ... km/h

Axles and suspension

- 30.1. Track of each steered axle: ... mm
- 30.2. Track of all other axles: ... mm
31. Position of lift axle(s): ...
32. Position of loadable axle(s): ...
34. Axle(s) fitted with air suspension or equivalent: yes/no ⁽¹⁾
35. Tyre/wheel combination ^(h): ...

Coupling device

44. Approval number or approval mark of coupling device (if fitted): ...
45. Types or classes of coupling devices which can be fitted: ...

▼B

45.1. Characteristics values ⁽¹⁾: D: .../ V: .../ S: .../ U: ...

Miscellaneous

52. Remarks ⁽ⁿ⁾: ...

*SIDE 2**VEHICLE CATEGORIES O3 AND O4**(incomplete vehicles)**Side 2**General construction characteristics*

1. Number of axles: ... and wheels: ...

1.1. Number and position of axles with twin wheels: ...

2. Steered axle (number, position): ...

Main dimensions

4. Wheelbase ^(e): ... mm

4.1. Axle spacing:

1-2: ... mm

2-3: ... mm

3-4: ... mm

5.1. Maximum permissible length: ...mm

6.1. Maximum permissible width: ...mm

7.1. Maximum permissible height: ...mm

10. Distance between the centre of the coupling device and the rear end of the vehicle: ...mm

12.1. Maximum permissible rear overhang: ...mm

Masses

14. Mass in running order of the incomplete vehicle: ... kg

14.1. Distribution of this mass amongst the axles:

1. ... kg

2. ... kg

3. ... kg etc.

15. Minimum mass of the vehicle when completed: ... kg

15.1. Distribution of this mass amongst the axles:

1. ... kg

2. ... kg

3. ... kg

16. Technically permissible maximum masses

16.1. Technically permissible maximum laden mass: ... kg

▼B

- 16.2. Technically permissible mass on each axle:
1. ... kg
 2. ... kg
 3. ... kg etc.
- 16.3. Technically permissible mass on each axle group:
1. ... kg
 2. ... kg
 3. ... kg etc.
17. Intended registration/in service maximum permissible masses in national/international traffic ⁽¹⁾ (°)
- 17.1. Intended registration/in service maximum permissible laden mass: ... kg
- 17.2. Intended registration/in service maximum permissible laden mass on each axle:
1. ... kg
 2. ... kg
 3. ... kg
- 17.3. Intended registration/in service maximum permissible laden mass on each axle group:
1. ... kg
 2. ... kg
 3. ... kg
- 19.1. Technically permissible maximum static mass on the coupling point of a semi-trailer or centre-axle trailer: ... kg

Maximum speed

29. Maximum speed: ... km/h

Axles and suspension

31. Position of lift axle(s): ...
32. Position of loadable axle(s): ...
34. Axle(s) fitted with air suspension or equivalent: yes/no ⁽¹⁾
35. Tyre/wheel combination ^(b): ...

Coupling device

44. Approval number or approval mark of coupling device (if fitted): ...
45. Types or classes of coupling devices which can be fitted: ...

▼B

45.1. Characteristics values ⁽¹⁾: D: .../ V: .../ S: .../ U: ...

Miscellaneous

52. Remarks ⁽ⁿ⁾: ...

Explanatory notes relating to Annex IX

- (¹) Delete where not applicable
 - (^a) Indicate the identification code —
 - (^b) Indicate whether the vehicle is suitable for use in either right or left-hand traffic or both right and left-hand traffic.
 - (^c) Indicate whether the speedometer and/or odometer fitted has metric or both metric and imperial units.
 - (^d) This statement shall not restrict the right of the Member States to require technical adaptations in order to allow the registration of a vehicle in a Member State other than the one for which it was intended when the direction of the traffic is on the opposite side of the road.
 - (^e) Entries 4 and 4.1 shall be completed in accordance with definitions 25 (Wheelbase) and 26 (Axle spacing) of Regulation (EU) No 1230/2012 respectively
- —
- (^ε) For hybrid electric vehicles, indicate both power outputs.
 - (^h) Optional equipment under this letter can be added under entry “Remarks”.
 - (ⁱ) The codes described in Annex II Letter C shall be used.
 - (^j) Indicate only the basic colour(s) as follows: white, yellow, orange, red, violet, blue, green, grey, brown or black.
 - (^k) Excluding seats designated for use only when the vehicle is stationary and the number of wheelchair positions.
For coaches belonging to the vehicle category M₃ the number of crew members shall be included in the passenger number.
 - (^l) Add the number of the Euro level and the character corresponding to the provisions used for type-approval.
 - (^m) Repeat for the various fuels that can be used. Vehicles that can be fuelled with both petrol and gaseous fuel but in which the petrol system is fitted for emergency purposes or for starting only and the petrol tank of which cannot contain more than 15 litres of petrol will be regarded as vehicles that can only run on a gaseous fuel.
 - (^{m1}) In case of EURO VI dual-fuel engines and vehicles, repeat as appropriate.
 - (^{m2}) Solely emissions assessed in accordance with the applicable regulatory act or acts shall be stated.
 - (ⁿ) If the vehicle is equipped with 24 GHz short-range radar equipment in accordance with Commission Decision 2005/50/EC (OJ L 21, 25.1.2005, p. 15), the manufacturer shall indicate here: “Vehicle equipped with 24 GHz short-range radar equipment”.
 - (^o) The manufacturer may complete these entries either for international traffic or national traffic or both.
For national traffic, the code of the country where the vehicle is intended to be registered shall be mentioned. The code shall be in accordance with standard ISO 3166-1:2006.
For international traffic, the directive number shall be referred to (e.g. “96/53/EC” for Council Directive 96/53/EC).
 - (^p) Eco-innovations.
 - (^{p1}) The general code of the eco-innovation(s) shall consist of the following elements, each separated by a blank space:
 - Code of the approval authority as set out in Annex VII;
 - Individual code of each eco-innovation fitted in the vehicle, indicated in chronological order of the Commission approval decisions.
(E.g. the general code of three eco-innovations approved chronologically as 10, 15 and 16 and fitted to a vehicle certified by the German type-approval authority should be: “e1 10 15 16”.)
 - (^{p2}) Sum of the CO₂ emissions savings of each individual eco-innovation.
 - (^q) In the case of completed vehicles of category N₁ within the scope of Regulation (EC) No 715/2007.
 - (^r) Only applicable if the vehicle is approved to Regulation (EC) 715/2007
 - (^s) In the case of more than one electric motor indicate the consolidated effect of all the engines.’

▼B

ANNEX XIX

AMENDMENTS TO REGULATION (EU) No 1230/2012

Regulation (EU) No 1230/2012 is amended as follows:

1. Article 2(5) is replaced by the following:

“‘Mass of the optional equipment’ means maximum mass of the combinations of optional equipment which may be fitted to the vehicle in addition to the standard equipment in accordance with the manufacturer's specifications;”



ANNEX XX

**MEASUREMENT OF NET POWER AND THE MAXIMUM 30 MINUTES
POWER OF ELECTRIC DRIVE TRAINS**

1. INTRODUCTION

This Annex sets out requirements for measuring net engine power, net power and the maximum 30 minutes power of electric drive trains.

2. GENERAL SPECIFICATIONS

2.1. The general specifications for conducting the tests and interpreting the results are those set out in paragraph 5 of UN/ECE Regulation No 85 ⁽¹⁾, with the exceptions specified in this Annex.

2.2. Test fuel

Paragraphs 5.2.3.1., 5.2.3.2.1., 5.2.3.3.1., and 5.2.3.4. of UN/ECE Regulation No 85 shall be understood as follows:

The fuel used shall be the one available on the market. In any case of dispute, the fuel shall be the appropriate reference fuel specified in Annex IX to this Regulation.

2.3. Power correction factors

By way of derogation from paragraph 5.1 of Annex 5 to UN/ECE Regulation No 85, when a turbo-charged engine is fitted with a system which allows compensating the ambient conditions temperature and altitude, at the request of the manufacturer, the correction factors α_a or α_d shall be set to the value of 1.

⁽¹⁾ OJ L 326, 24.11.2006, p. 55.



ANNEX XXI

TYPE 1 EMISSIONS TEST PROCEDURES

1. INTRODUCTION

This Annex describes the procedure for determining the levels of emissions of gaseous compounds, particulate matter, particle number, CO₂ emissions, fuel consumption, electric energy consumption and electric range from light-duty vehicles.

2. RESERVED

3. DEFINITIONS

3.1. **Test equipment**

3.1.1. ‘*Accuracy*’ means the difference between a measured value and a reference value, traceable to a national standard and describes the correctness of a result. See Figure 1.

3.1.2. ‘*Calibration*’ means the process of setting a measurement system's response so that its output agrees with a range of reference signals.

3.1.3. ‘*Calibration gas*’ means a gas mixture used to calibrate gas analysers.

3.1.4. ‘*Double dilution method*’ means the process of separating a part of the diluted exhaust flow and mixing it with an appropriate amount of dilution air prior to the particulate sampling filter.

3.1.5. ‘*Full flow exhaust dilution system*’ means the continuous dilution of the total vehicle exhaust with ambient air in a controlled manner using a constant volume sampler (CVS).

3.1.6. ‘*Linearisation*’ means the application of a range of concentrations or materials to establish a mathematical relationship between concentration and system response.

3.1.7. ‘*Major maintenance*’ means the adjustment, repair or replacement of a component or module that could affect the accuracy of a measurement.

3.1.8. ‘*Non-methane hydrocarbons*’ (NMHC) are the total hydrocarbons (THC) minus the methane (CH₄) contribution.

3.1.9. ‘*Precision*’ means the degree to which repeated measurements under unchanged conditions show the same results (Figure 1) and, in this Annex, always refers to one standard deviation.

3.1.10. ‘*Reference value*’ means a value traceable to a national standard. See Figure 1.

3.1.11. ‘*Set point*’ means the target value a control system aims to reach.

3.1.12. ‘*Span*’ means to adjust an instrument so that it gives a proper response to a calibration standard that represents between 75 per cent and 100 per cent of the maximum value in the instrument range or expected range of use.

▼ B

- 3.1.13. ‘*Total hydrocarbons*’ (THC) means all volatile compounds measurable by a flame ionization detector (FID).
- 3.1.14. ‘*Verification*’ means to evaluate whether or not a measurement system’s outputs agrees with applied reference signals within one or more predetermined thresholds for acceptance.
- 3.1.15. ‘*Zero gas*’ means a gas containing no analyte, which is used to set a zero response on an analyser.

▼ M3

- 3.1.16. ‘*Response time*’ means the difference in time between the change of the component to be measured at the reference point and a system response of 90 per cent of the final reading (t_{90}) with the sampling probe being defined as the reference point, whereby the change of the measured component is at least 60 per cent full scale (FS) and takes place in less than 0,1 second. The system response time consists of the delay time to the system and of the rise time of the system.
- 3.1.17. ‘*Delay time*’ means the difference in time between the change of the component to be measured at the reference point and a system response of 10 per cent of the final reading (t_{10}) with the sampling probe being defined as the reference point. For gaseous components, this is the transport time of the measured component from the sampling probe to the detector.
- 3.1.18. ‘*Rise time*’ means the difference in time between the 10 per cent and 90 per cent response of the final reading ($t_{90} - t_{10}$).

▼ B

Figure 1

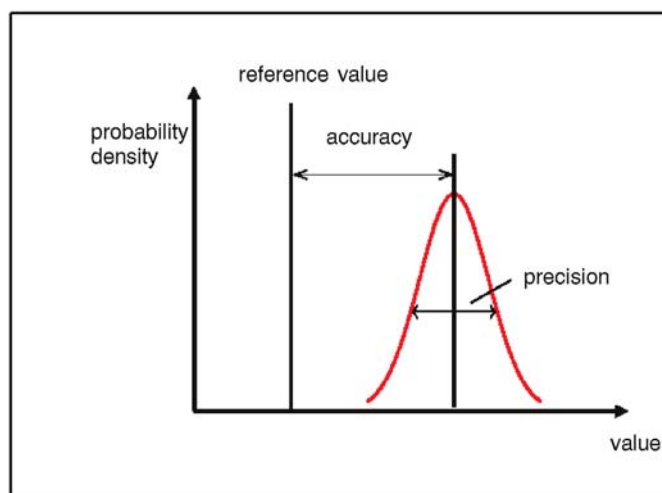
Definition of accuracy, precision and reference value**3.2. Road load and dynamometer setting**

- 3.2.1. ‘*Aerodynamic drag*’ means the force opposing a vehicle’s forward motion through air.
- 3.2.2. ‘*Aerodynamic stagnation point*’ means the point on the surface of a vehicle where wind velocity is equal to zero.
- 3.2.3. ‘*Anemometer blockage*’ means the effect on the anemometer measurement due to the presence of the vehicle where the apparent air speed is different than the vehicle speed combined with wind speed relative to the ground.

▼ B

- 3.2.4. ‘*Constrained analysis*’ means the vehicle’s frontal area and aerodynamic drag coefficient have been independently determined and those values shall be used in the equation of motion.
- 3.2.5. ‘*Mass in running order*’ means the mass of the vehicle, with its fuel tank(s) filled to at least 90 per cent of its or their capacity/capacities, including the mass of the driver, fuel and liquids, fitted with the standard equipment in accordance with the manufacturer’s specifications and, when they are fitted, the mass of the bodywork, the cabin, the coupling and the spare wheel(s) as well as the tools.
- 3.2.6. ‘*Mass of the driver*’ means a mass rated at 75 kg located at the driver’s seating reference point.
- 3.2.7. ‘*Maximum vehicle load*’ means the technically permissible maximum laden mass minus the mass in running order, 25 kg and the mass of the optional equipment as defined in paragraph 3.2.8.
- 3.2.8. ‘*Mass of the optional equipment*’ means maximum mass of the combinations of optional equipment which may be fitted to the vehicle in addition to the standard equipment in accordance with the manufacturer’s specifications.
- 3.2.9. ‘*Optional equipment*’ means all the features not included in the standard equipment which are fitted to a vehicle under the responsibility of the manufacturer, and that can be ordered by the customer.
- 3.2.10. ‘*Reference atmospheric conditions (regarding road load measurements)*’ means the atmospheric conditions to which these measurement results are corrected:
- (a) Atmospheric pressure: $p_0 = 100 \text{ kPa}$;
 - (b) Atmospheric temperature: $T_0 = 20 \text{ °C}$;
 - (c) Dry air density: $\rho_0 = 1,189 \text{ kg/m}^3$;
 - (d) Wind speed: 0 m/s.
- 3.2.11. ‘*Reference speed*’ means the vehicle speed at which road load is determined or chassis dynamometer load is verified.
- 3.2.12. ‘*Road load*’ means the force resisting the forward motion of a vehicle as measured with the coastdown method or methods that are equivalent regarding the inclusion of frictional losses of the drivetrain.
- 3.2.13. ‘*Rolling resistance*’ means the forces of the tyres opposing the motion of a vehicle.
- 3.2.14. ‘*Running resistance*’ means the torque resisting the forward motion of a vehicle measured by torque meters installed at the driven wheels of a vehicle.
- 3.2.15. ‘*Simulated road load*’ means the road load experienced by the vehicle on the chassis dynamometer which is intended to reproduce the road load measured on the road, and consists of the force applied by the chassis dynamometer and the forces resisting the vehicle while driving on the chassis dynamometer and is approximated by the three coefficients of a second order polynomial.

▼ B

- 3.2.16. ‘*Simulated running resistance*’ means the running resistance experienced by the vehicle on the chassis dynamometer which is intended to reproduce the running resistance measured on the road, and consists of the torque applied by the chassis dynamometer and the torque resisting the vehicle while driving on the chassis dynamometer and is approximated by the three coefficients of a second order polynomial.
- 3.2.17. ‘*Stationary anemometry*’ means measurement of wind speed and direction with an anemometer at a location and height above road level alongside the test road where the most representative wind conditions will be experienced.
- 3.2.18. ‘*Standard equipment*’ means the basic configuration of a vehicle which is equipped with all the features that are required under the regulatory acts referred to in Annex IV and Annex XI of Directive 2007/46/EC including all features that are fitted without giving rise to any further specifications on configuration or equipment level.

▼ M2

- 3.2.19. ‘*Target road load*’ means the road load to be reproduced on the chassis dynamometer.

▼ B

- 3.2.20. ‘*Target running resistance*’ means the running resistance to be reproduced on the chassis dynamometer.

▼ M3

- 3.2.21. ‘*Vehicle coastdown mode*’ means a system of operation enabling an accurate and repeatable determination of road load and an accurate dynamometer setting.

▼ B

- 3.2.22. ‘*Wind correction*’ means correction of the effect of wind on road load based on input of the stationary or on-board anemometry.
- 3.2.23. ‘*Technically permissible maximum laden mass*’ means the maximum mass allocated to a vehicle on the basis of its construction features and its design performances.
- 3.2.24. ‘*Actual mass of the vehicle*’ means the mass in running order plus the mass of the fitted optional equipment to an individual vehicle.
- 3.2.25. ‘*Test mass of the vehicle*’ means the sum of the actual mass of the vehicle, 25 kg and the mass representative of the vehicle load.
- 3.2.26. ‘*Mass representative of the vehicle load*’ means x per cent of the maximum vehicle load where x is 15 per cent for category M vehicles and 28 per cent for category N vehicles.
- 3.2.27. ‘*Technically permissible maximum laden mass of the combination*’ (MC) means the maximum mass allocated to the combination of a motor vehicle and one or more trailers on the basis of its construction features and its design performances or the maximum mass allocated to the combination of a tractor unit and a semi-trailer.

▼ M3

- 3.2.28. ‘*n/v ratio*’ means the engine rotational speed divided by vehicle speed in a specific gear.
- 3.2.29. ‘*Single roller dynamometer*’ means a dynamometer where each wheel on a vehicle's axle is in contact with one roller.

▼ M3

- 3.2.30. ‘*Twin-roller dynamometer*’ means a dynamometer where each wheel on a vehicle's axle is in contact with two rollers.
- 3.2.31. ‘*Powered axle*’ means an axle of a vehicle which is able to deliver propulsion energy and/or recuperate energy, independent of whether that is only temporarily or permanently possible and/or selectable by the driver.
- 3.2.32. ‘*2WD dynamometer*’ means a dynamometer where only the wheels on one vehicle axle are in contact with the roller(s).
- 3.2.33. ‘*4WD dynamometer*’ means a dynamometer where all wheels on both vehicle axles are in contact with the rollers.
- 3.2.34. ‘*Dynamometer in 2WD operation*’ means a 2WD dynamometer, or a 4WD dynamometer which only simulates inertia and road load on the powered axle of the test vehicle while the wheels on the non-powered axle do not influence the measurement result, independent of whether they are rotating or not.
- 3.2.35. ‘*Dynamometer in 4WD operation*’ means a 4WD dynamometer which simulates inertia and road load on both axles of the test vehicle.

3.3. Pure electric, hybrid electric, fuel cell and bi-fuel vehicles**▼ B**

- 3.3.1. ‘*All-electric range*’ (AER) means the total distance travelled by an OVC-HEV from the beginning of the charge-depleting test to the point in time during the test when the combustion engine starts to consume fuel.
- 3.3.2. ‘*Pure Electric range*’ (PER) means the total distance travelled by a PEV from the beginning of the charge-depleting test until the break-off criterion is reached.
- 3.3.3. ‘*Charge-depleting actual range*’ (R_{CDA}) means the distance travelled in a series of WLTCs in charge-depleting operating condition until the rechargeable electric energy storage system (REESS) is depleted.
- 3.3.4. ‘*Charge-depleting cycle range*’ (R_{CDC}) means the distance from the beginning of the charge-depleting test to the end of the last cycle prior to the cycle or cycles satisfying the break-off criterion, including the transition cycle where the vehicle may have operated in both depleting and sustaining conditions.
- 3.3.5. ‘*Charge-depleting operating condition*’ means an operating condition in which the energy stored in the REESS may fluctuate but decreases on average while the vehicle is driven until transition to charge-sustaining operation.
- 3.3.6. ‘*Charge-sustaining operating condition*’ means an operating condition in which the energy stored in the REESS may fluctuate but, on average, is maintained at a neutral charging balance level while the vehicle is driven.

▼ B

- 3.3.7. ‘*Utility Factors*’ are ratios based on driving statistics depending on the range achieved in charge-depleting condition and are used to weigh the charge-depleting and charge-sustaining exhaust emission compounds, CO₂ emissions and fuel consumption for OVC-HEVs.
- 3.3.8. ‘*Electric machine*’ (EM) means an energy converter transforming between electrical and mechanical energy.
- 3.3.9. ‘*Energy converter*’ means a system where the form of energy output is different from the form of energy input.
- 3.3.9.1. ‘*Propulsion energy converter*’ means an energy converter of the powertrain which is not a peripheral device whose output energy is used directly or indirectly for the purpose of vehicle propulsion
- 3.3.9.2. ‘*Category of propulsion energy converter*’ means (i) an internal combustion engine, or (ii) an electric machine, or (iii) a fuel cell.
- 3.3.10. ‘*Energy storage system*’ means a system which stores energy and releases it in the same form as was input.
- 3.3.10.1. ‘*Propulsion energy storage system*’ means an energy storage system of the powertrain which is not a peripheral device and whose output energy is used directly or indirectly for the purpose of vehicle propulsion.
- 3.3.10.2. ‘*Category of propulsion energy storage system*’ means (i) a fuel storage system, or (ii) a rechargeable electric energy storage system, or (iii) a rechargeable mechanical energy storage system.
- 3.3.10.3. ‘*Form of energy*’ means (i) electrical energy, or (ii) mechanical energy, or (iii) chemical energy (including fuels).
- 3.3.10.4. ‘*Fuel storage system*’ means a propulsion energy storage system that stores chemical energy as liquid or gaseous fuel.
- 3.3.11. ‘*Equivalent all-electric range*’ (EAER) means that portion of the total charge-depleting actual range (R_{CDA}) attributable to the use of electricity from the REESS over the charge-depleting range test.
- 3.3.12. ‘*Hybrid electric vehicle*’ (HEV) means a hybrid vehicle where one of the propulsion energy converters is an electric machine.
- 3.3.13. ‘*Hybrid vehicle*’ (HV) means a vehicle equipped with a powertrain containing at least two different categories of propulsion energy converters and at least two different categories of propulsion energy storage systems.
- 3.3.14. ‘*Net energy change*’ means the ratio of the REESS energy change divided by the cycle energy demand of the test vehicle.
- 3.3.15. ‘*Not off-vehicle charging hybrid electric vehicle*’ (NOVC-HEV) means a hybrid electric vehicle that cannot be charged from an external source
- 3.3.16. ‘*Off-vehicle charging hybrid electric vehicle*’ (OVC-HEV) means a hybrid electric vehicle that can be charged from an external source.

▼ B

- 3.3.17. ‘*Pure electric vehicle*’ (PEV) means a vehicle equipped with a powertrain containing exclusively electric machines as propulsion energy converters and exclusively rechargeable electric energy storage systems as propulsion energy storage systems.
- 3.3.18. ‘*Fuel cell*’ means an energy converter transforming chemical energy (input) into electrical energy (output) or vice versa.
- 3.3.19. ‘*Fuel cell vehicle*’ (FCV) means a vehicle equipped with a powertrain containing exclusively fuel cell(s) and electric machine(s) as propulsion energy converter(s).
- 3.3.20. ‘*Fuel cell hybrid vehicle*’ (FCHV) means a fuel cell vehicle equipped with a powertrain containing at least one fuel storage system and at least one rechargeable electric energy storage system as propulsion energy storage systems.

▼ M3

- 3.3.21. ‘*Bi-fuel vehicle*’ means a vehicle with two separate fuel storage systems that is designed to run primarily on only one fuel at a time; however the simultaneous use of both fuels is permitted in limited amount and duration.
- 3.3.22. ‘*Bi-fuel gas vehicle*’ means a bi-fuel vehicle where the two fuels are petrol (petrol mode) and either LPG, NG/biomethane, or hydrogen.

▼ B

- 3.4. **Powertrain**
- 3.4.1. ‘*Powertrain*’ means the total combination in a vehicle, of propulsion energy storage system(s), propulsion energy converter(s) and the drivetrain(s) providing the mechanical energy at the wheels for the purpose of vehicle propulsion, plus peripheral devices.
- 3.4.2. ‘*Auxiliary devices*’ means energy consuming, converting, storing or supplying non-peripheral devices or systems which are installed in the vehicle for purposes other than the propulsion of the vehicle and are therefore not considered to be part of the powertrain.
- 3.4.3. ‘*Peripheral devices*’ means energy consuming, converting, storing or supplying devices, where the energy is not primarily used for the purpose of vehicle propulsion, or other parts, systems and control units, which are essential to the operation of the powertrain.
- 3.4.4. ‘*Drivetrain*’ means the connected elements of the powertrain for transmission of the mechanical energy between the propulsion energy converter(s) and the wheels.
- 3.4.5. ‘*Manual transmission*’ means a transmission where gears can only be shifted by action of the driver.
- 3.5. **General**
- 3.5.1. ‘*Criteria emissions*’ means those emission compounds for which limits are set in this Regulation.
- 3.5.2. Reserved
- 3.5.3. Reserved
- 3.5.4. Reserved
- 3.5.5. Reserved
- 3.5.6. ‘*Cycle energy demand*’ means the calculated positive energy required by the vehicle to drive the prescribed cycle.
- 3.5.7. Reserved

▼ B

3.5.8. ‘*Driver-selectable mode*’ means a distinct driver-selectable condition which could affect emissions, or fuel and/or energy consumption.

▼ M3

3.5.9. ‘*Predominant mode*’ for the purpose of this Annex means a single driver-selectable mode that is always selected when the vehicle is switched on, regardless of the driver-selectable mode in operation when the vehicle was previously shut down, and which cannot be redefined to another mode. After the vehicle is switched on, the predominant mode can only be switched to another driver-selectable mode by an intentional action of the driver.

▼ B

3.5.10. ‘*Reference conditions (with regards to calculating mass emissions)*’ means the conditions upon which gas densities are based, namely 101,325 kPa and 273,15 K (0 °C).

▼ M3

3.5.11. ‘*Exhaust emissions*’ means the emission of gaseous, solid and liquid compounds from the tailpipe.

▼ B

3.6. **PM/PN**

The term ‘particle’ is conventionally used for the matter being characterised (measured) in the airborne phase (suspended matter), and the term ‘particulate’ for the deposited matter.

3.6.1. ‘*Particle number emissions*’ (PN) means the total number of solid particles emitted from the vehicle exhaust quantified according to the dilution, sampling and measurement methods as specified in this Annex.

3.6.2. ‘*Particulate matter emissions*’ (PM) means the mass of any particulate material from the vehicle exhaust quantified according to the dilution, sampling and measurement methods as specified in this Annex.

3.7. **WLTC**

▼ M3

3.7.1. ‘*Rated engine power*’ (P_{rated}) means maximum net power of the engine or motor in kW as per the requirements of Annex XX.

▼ B

3.7.2. ‘*Maximum speed*’ (v_{max}) means the maximum speed of a vehicle as declared by the manufacturer.

3.8. **Procedure**

▼ M3

3.8.1. ‘*Periodically regenerating system*’ means an exhaust emissions control device (e.g. catalytic converter, particulate trap) that requires a periodic regeneration process.

▼ B

3.9. **Ambient Temperature Correction Test (Sub-Annex 6a)**

3.9.1. ‘*Active heat storage device*’ means a technology that stores heat within any device of a vehicle and releases the heat to a power train component over a defined time period at engine start. It is characterised by the stored enthalpy in the system and the time for heat release to the power train components.

▼ B

3.9.2. ‘*Insulation materials*’ means any material in the engine compartment attached to the engine and/or the chassis with a thermal insulation effect and characterised by a maximum heat conductivity of 0,1 W/(mK).

4. ABBREVIATIONS

4.1. **General abbreviations**

AC	Alternating current
CFV	Critical flow venturi
CFO	Critical flow orifice
CLD	Chemiluminescent detector
CLA	Chemiluminescent analyser
CVS	Constant volume sampler
DC	Direct current
ET	Evaporation tube

▼ M3

Extra High ₂	Class 2 WLTC extra high speed phase
Extra High ₃	Class 3 WLTC extra high speed phase

▼ B

FCHV	Fuel cell hybrid vehicle
FID	Flame ionisation detector
FSD	Full scale deflection
GC	Gas chromatograph
HEPA	High efficiency particulate air (filter)
HFID	Heated flame ionisation detector

▼ M3

High ₂	Class 2 WLTC high speed phase
High _{3a}	Class 3a WLTC high speed phase
High _{3b}	Class 3b WLTC high speed phase

▼ B

ICE	Internal combustion engine
LoD	Limit of detection
LoQ	Limit of quantification

▼ M3

Low ₁	Class 1 WLTC low speed phase
Low ₂	Class 2 WLTC low speed phase
Low ₃	Class 3 WLTC low speed phase
Medium ₁	Class 1 WLTC medium speed phase
Medium ₂	Class 2 WLTC medium speed phase
Medium _{3a}	Class 3a WLTC medium speed phase
Medium _{3b}	Class 3b WLTC medium speed phase

▼ B

LC	Liquid chromatography
----	-----------------------

▼ B

LPG	Liquefied petroleum gas
NDIR	Non-dispersive infrared (analyser)
NDUV	Non-dispersive ultraviolet
NG/biomethane	Natural gas/biomethane
NMC	Non-methane cutter
NOVC-FCHV	Not off-vehicle charging fuel cell hybrid vehicle
NOVC	Not off-vehicle charging
NOVC-HEV	Not off-vehicle charging hybrid electric vehicle
OVC-HEV	Off-vehicle charging hybrid electric vehicle
P _a	Particulate mass collected on the background filter
P _e	Particulate mass collected on the sample filter
PAO	Poly-alpha-olefin
PCF	Particle pre-classifier
PCRF	Particle concentration reduction factor
PDP	Positive displacement pump
PER	Pure electric range
Per cent FS	Per cent of full scale
PM	Particulate matter emissions
PN	Particle number emissions
PNC	Particle number counter
PND ₁	First particle number dilution device
PND ₂	Second particle number dilution device
PTS	Particle transfer system
PTT	Particle transfer tube
QCL-IR	Infrared quantum cascade laser
R _{CDA}	Charge-depleting actual range
RCB	REESS charge balance
REESS	Rechargeable electric energy storage system

▼ M3

RRC	Rolling resistance coefficient
-----	--------------------------------

▼ B

SSV	Subsonic venturi
USFM	Ultrasonic flow meter
VPR	Volatile particle remover
WLTC	Worldwide light-duty test cycle

4.2. **Chemical symbols and abbreviations**

C ₁	Carbon 1 equivalent hydrocarbon
CH ₄	Methane
C ₂ H ₆	Ethane
C ₂ H ₅ OH	Ethanol
C ₃ H ₈	Propane
CO	Carbon monoxide
CO ₂	Carbon dioxide
DOP	Di-octylphthalate
H ₂ O	Water
NH ₃	Ammonia
NMHC	Non-methane hydrocarbons
NO _x	Oxides of nitrogen
NO	Nitric oxide
NO ₂	Nitrogen dioxide
N ₂ O	Nitrous oxide
THC	Total hydrocarbons

5. GENERAL REQUIREMENTS

▼ M3

5.0. Each of the vehicle families defined in paragraphs 5.6. to 5.9. shall be attributed a unique identifier of the following format:

FT-nnnnnnnnnnnnnnnnnnn-WMI-x

Where:

FT is an identifier of the family type:

- IP = Interpolation family as defined in paragraph 5.6.
- RL = Road load family as defined in paragraph 5.7.
- RM = Road load matrix family as defined in paragraph 5.8.
- PR = Periodically regenerating systems (K_i) family as defined in paragraph 5.9.
- AT = ATCT family as defined in paragraph 2. of Sub-Annex 6a.

nnnnnnnnnnnnnnnnnn is a string with a maximum of fifteen characters, restricted to using the characters 0-9, A-Z and the underscore character ‘_’.

WMI (world manufacturer identifier) is a code that identifies the manufacturer in a unique manner defined in ISO 3780:2009.

x shall be set to ‘1’ or ‘0’ in accordance with the following provisions:

- (a) With the agreement of the approval authority and the owner of the WMI, the number shall be set to ‘1’ where a vehicle family is defined for the purpose of covering vehicles of:
 - (i) a single manufacturer with one single WMI code;
 - (ii) a manufacturer with several WMI codes, but only in cases when one WMI code is to be used;
 - (iii) more than one manufacturer, but only in cases when one WMI code is to be used.

▼ M3

In the cases (i), (ii) and (iii), the family identifier code shall consist of one unique string of n-characters and one unique WMI code followed by '1'.

- (b) With the agreement of the approval authority, the number shall be set to '0' in the case that a vehicle family is defined based on the same criteria as the corresponding vehicle family defined in accordance with point (a), but the manufacturer chooses to use a different WMI. In this case the family identifier code shall consist of the same string of n-characters as the one determined for the vehicle family defined in accordance with point (a) and a unique WMI code which shall be different from any of the WMI codes used under case (a), followed by '0'.

▼ B

- 5.1. The vehicle and its components liable to affect the emissions of gaseous compounds, particulate matter and particle number shall be so designed, constructed and assembled as to enable the vehicle in normal use and under normal conditions of use such as humidity, rain, snow, heat, cold, sand, dirt, vibrations, wear, etc. to comply with the provisions of this Annex during its useful life.

▼ M3

This shall include the security of all hoses, joints and connections used within the emission control systems.

▼ B

- 5.2. The test vehicle shall be representative in terms of its emissions-related components and functionality of the intended production series to be covered by the approval. The manufacturer and the approval authority shall agree which vehicle test model is representative.
- 5.3. **Vehicle testing condition**
- 5.3.1. The types and amounts of lubricants and coolant for emissions testing shall be as specified for normal vehicle operation by the manufacturer.
- 5.3.2. The type of fuel for emissions testing shall be as specified in Annex IX.
- 5.3.3. All emissions controlling systems shall be in working order.
- 5.3.4. The use of any defeat device is prohibited, according to the provisions of Article 5(2) of Regulation (EC) No 715/2007.
- 5.3.5. The engine shall be designed to avoid crankcase emissions.

▼ M3

- 5.6. The tyres used for emissions testing shall be as defined in paragraph 2.4.5. of Sub-Annex 6 to this Annex.

▼ B

- 5.4. **Petrol tank inlet orifices**
- 5.4.1. Subject to paragraph 5.4.2., the inlet orifice of the petrol or ethanol tank shall be so designed as to prevent the tank from being filled from a fuel pump delivery nozzle that has an external diameter of 23.6 mm or greater.
- 5.4.2. Paragraph 5.4.1. shall not apply to a vehicle in respect of which both of the following conditions are satisfied:
- (a) The vehicle is so designed and constructed that no device designed to control the emissions shall be adversely affected by leaded petrol; and

▼ B

- (b) The vehicle is conspicuously, legibly and indelibly marked with the symbol for unleaded petrol, specified in ISO 2575:2010 'Road vehicles – Symbols for controls, indicators and tell-tales', in a position immediately visible to a person filling the petrol tank. Additional markings are permitted.

▼ M35.5. **Provisions for electronic system security**

The provisions for electronic system security shall be those specified in paragraph 2.3. of Annex I.

▼ B5.6. **Interpolation family****▼ M3**5.6.1. *Interpolation family for pure ICE vehicles*

5.6.1.1. Vehicles may be part of the same interpolation family in any of the following cases including combinations of these cases:

- (a) they belong to different vehicle classes as described in paragraph 2. of Sub-Annex 1;
- (b) they have different levels of downscaling as described in paragraph 8. of Sub-Annex 1;
- (c) they have different capped speeds as described in paragraph 9. of Sub-Annex 1.

5.6.1.2. Only vehicles that are identical with respect to the following vehicle/power-train/transmission characteristics may be part of the same interpolation family:

- (a) Type of internal combustion engine: fuel type (or types in the case of flex-fuel or bi-fuel vehicles), combustion process, engine displacement, full-load characteristics, engine technology, and charging system, and also other engine subsystems or characteristics that have a non-negligible influence on CO₂ mass emission under WLTP conditions;
- (b) Operation strategy of all CO₂ mass emission influencing components within the powertrain;
- (c) Transmission type (e.g. manual, automatic, CVT) and transmission model (e.g. torque rating, number of gears, number of clutches, etc.);
- (d) n/v ratios (engine rotational speed divided by vehicle speed). This requirement shall be considered fulfilled if, for all transmission ratios concerned, the difference with respect to n/v ratios of the most commonly installed transmission type is within 8 per cent;
- (e) Number of powered axles;
- (f) ATCT family, per reference fuel in the case of flex-fuel or bi-fuel vehicles;
- (g) Number of wheels per axle.

5.6.1.3. If an alternative parameter such as a higher n_{\min_drive} , as specified in paragraph 2.(k) of Sub-Annex 2, or ASM, as defined in paragraph 3.4. of Sub-Annex 2 is used, this parameter shall be the same within an interpolation family.

▼ B5.6.2. *Interpolation family for NOVC-HEVs and OVC-HEVs*

In addition to the requirements of paragraph 5.6.1., only OVC-HEVs and NOVC-HEVs that are identical with respect to the following characteristics may be part of the same interpolation family:

▼ B

- (a) Type and number of electric machines (construction type (asynchronous/ synchronous, etc.), type of coolant (air, liquid,) and any other characteristics having a non-negligible influence on CO₂ mass emission and electric energy consumption under WLTP conditions;
- (b) Type of traction REESS (model, capacity, nominal voltage, nominal power, type of coolant (air, liquid));

▼ M3

- (c) Type of electric energy converter between the electric machine and traction REESS, between the traction REESS and low voltage power supply and between the recharge-plug-in and traction REESS, and any other characteristics having a non-negligible influence on CO₂ mass emission and electric energy consumption under WLTP conditions;

▼ B

- (d) The difference between the number of charge-depleting cycles from the beginning of the test up to and including the transition cycle shall not be more than one.

5.6.3. *Interpolation family for PEVs*

Only PEVs that are identical with respect to the following electric powertrain/transmission characteristics may be part of the same interpolation family:

- (a) Type and number of electric machines (construction type (asynchronous/ synchronous, etc.), type of coolant (air, liquid) and any other characteristics having a non-negligible influence on electric energy consumption and range under WLTP conditions;
- (b) Type of traction REESS (model, capacity, nominal voltage, nominal power, type of coolant (air, liquid));
- (c) Transmission type (e.g. manual, automatic, CVT) and transmission model (e.g. torque rating, number of gears, numbers of clutches, etc.);
- (d) Number of powered axles;

▼ M3

- (e) Type of electric energy converter between the electric machine and traction REESS, between the traction REESS and low voltage power supply and between the recharge-plug-in and traction REESS, and any other characteristics having a non-negligible influence on electric energy consumption and range under WLTP conditions;

▼ B

- (f) Operation strategy of all components influencing the electric energy consumption within the powertrain;

▼ M3

- (g) n/v ratios (engine rotational speed divided by vehicle speed). This requirement shall be considered fulfilled if, for all transmission ratios concerned, the difference with respect to the n/v ratios of the most commonly installed transmission type and model is within 8 per cent.

▼ B5.7. **Road load family**

Only vehicles that are identical with respect to the following characteristics may be part of the same road load family:

- (a) Transmission type (e.g. manual, automatic, CVT) and transmission model (e.g. torque rating, number of gears, number of clutches, etc.). At the request of the manufacturer and with approval of the approval authority, a transmission with lower power losses may be included in the family;

▼B

- (b) n/v ratios (engine rotational speed divided by vehicle speed). This requirement shall be considered fulfilled if, for all transmission ratios concerned, the difference with respect to the transmission ratios of the most commonly installed transmission type is within 25 per cent;
- (c) Number of powered axles;

▼M3

- (d) Number of wheels per axle.

If at least one electric machine is coupled in the gearbox position neutral and the vehicle is not equipped with a vehicle coastdown mode (paragraph 4.2.1.8.5. of Sub-Annex 4) such that the electric machine has no influence on the road load, the criteria in paragraph 5.6.2. (a) and paragraph 5.6.3. (a) shall apply.

If there is a difference, apart from vehicle mass, rolling resistance and aerodynamics, that has a non-negligible influence on road load, that vehicle shall not be considered to be part of the family unless approved by the approval authority.

5.8. Road load matrix family

The road load matrix family may be applied for vehicles designed for a technically permissible maximum laden mass $\geq 3\,000$ kg.

The road load matrix family may also be applied for vehicles submitted for multi-stage type approval or multi-stage vehicles submitted for individual vehicle approval.

In these cases the provisions set out in point 2. of Annex XII shall apply.

Only vehicles which are identical with respect to the following characteristics may be part of the same road load matrix family:

- (a) Transmission type (e.g. manual, automatic, CVT);
- (b) Number of powered axles;
- (c) Number of wheels per axle.

5.9. Periodically regenerating systems (K_i) family

Only vehicles that are identical with respect to the following characteristics may be part of the same periodically regenerating systems family:

- (a) Type of internal combustion engine: fuel type, combustion process,
- (b) Periodically regenerating system (i.e. catalyst, particulate trap);
 - (i) Construction (i.e. type of enclosure, type of precious metal, type of substrate, cell density);
 - (ii) Type and working principle;
 - (iii) Volume ± 10 per cent;
 - (iv) Location (temperature ± 100 °C at second highest reference speed).

▼ M3

- (c) The test mass of each vehicle in the family shall be less than or equal to the test mass of the vehicle used for the K_i demonstration test plus 250 kg.

▼ B

6. PERFORMANCE REQUIREMENTS

▼ M3

6.1. **Limit values**

Limit values for emissions shall be those specified in Table 2 of Annex I of Regulation (EC) No 715/2007.

▼ B

6.2. **Testing**

Testing shall be performed according to:

- (a) The WLTCs as described in Sub-Annex 1;
- (b) The gear selection and shift point determination as described in Sub-Annex 2;
- (c) The appropriate fuel as described in Annex IX of this Regulation;
- (d) The road load and dynamometer settings as described in Sub-Annex 4;
- (e) The test equipment as described in Sub-Annex 5;
- (f) The test procedures as described in Sub-Annexes 6 and 8;
- (g) The methods of calculation as described in Sub-Annexes 7 and 8.

▼B*Sub-Annex 1***Worldwide light-duty test cycles (WLTC)****▼M3**

1. General requirements

The cycle to be driven depends on the ratio of the test vehicle's rated power to mass in running order minus 75 kg, W/kg, and its maximum velocity, v_{\max} .

The cycle resulting from the requirements described in this Sub-Annex shall be referred to in other parts of the Annex as the 'applicable cycle'.
2. Vehicle classifications
 - 2.1. Class 1 vehicles have a power to mass in running order minus 75 kg ratio $P_{\text{mr}} \leq 22$ W/kg.
 - 2.2. Class 2 vehicles have a power to mass in running order minus 75 kg ratio > 22 but ≤ 34 W/kg.
 - 2.3. Class 3 vehicles have a power to mass in running order minus 75 kg ratio > 34 W/kg.
 - 2.3.1. Class 3 vehicles are divided into 2 subclasses in accordance with their maximum speed, v_{\max} .
 - 2.3.1.1. Class 3a vehicles with $v_{\max} < 120$ km/h.
 - 2.3.1.2. Class 3b vehicles with $v_{\max} \geq 120$ km/h.
 - 2.3.2. All vehicles tested in accordance with Sub-Annex 8 shall be considered to be Class 3 vehicles.
3. Test cycles
 - 3.1. Class 1 cycle
 - 3.1.1. A complete Class 1 cycle shall consist of a low phase (Low_1), a medium phase (Medium_1) and an additional low phase (Low_1).
 - 3.1.2. The Low_1 phase is described in Figure A1/1 and Table A1/1.
 - 3.1.3. The Medium_1 phase is described in Figure A1/2 and Table A1/2.
 - 3.2. Class 2 cycle
 - 3.2.1. A complete Class 2 cycle shall consist of a low phase (Low_2), a medium phase (Medium_2), a high phase (High_2) and an extra high phase (Extra High_2).
 - 3.2.2. The Low_2 phase is described in Figure A1/3 and Table A1/3.
 - 3.2.3. The Medium_2 phase is described in Figure A1/4 and Table A1/4.
 - 3.2.4. The High_2 phase is described in Figure A1/5 and Table A1/5.
 - 3.2.5. The Extra High_2 phase is described in Figure A1/6 and Table A1/6.
 - 3.3. Class 3 cycle

Class 3 cycles are divided into 2 subclasses to reflect the subdivision of Class 3 vehicles.

▼ M3

- 3.3.1. Class 3a cycle
 - 3.3.1.1. A complete cycle shall consist of a low phase (Low_3), a medium phase ($Medium_{3a}$), a high phase ($High_{3a}$) and an extra high phase ($Extra\ High_3$).
 - 3.3.1.2. The Low_3 phase is described in Figure A1/7 and Table A1/7.
 - 3.3.1.3. The $Medium_{3a}$ phase is described in Figure A1/8 and Table A1/8.
 - 3.3.1.4. The $High_{3a}$ phase is described in Figure A1/10 and Table A1/10.
 - 3.3.1.5. The $Extra\ High_3$ phase is described in Figure A1/12 and Table A1/12.
- 3.3.2. Class 3b cycle
 - 3.3.2.1. A complete cycle shall consist of a low phase (Low_3) phase, a medium phase ($Medium_{3b}$), a high phase ($High_{3b}$) and an extra high phase ($Extra\ High_3$).
 - 3.3.2.2. The Low_3 phase is described in Figure A1/7 and Table A1/7.
 - 3.3.2.3. The $Medium_{3b}$ phase is described in Figure A1/9 and Table A1/9.
 - 3.3.2.4. The $High_{3b}$ phase is described in Figure A1/11 and Table A1/11.
 - 3.3.2.5. The $Extra\ High_3$ phase is described in Figure A1/12 and Table A1/12.
- 3.4. Duration of all phases
 - 3.4.1. All low speed phases last 589 seconds.
 - 3.4.2. All medium speed phases last 433 seconds.
 - 3.4.3. All high speed phases last 455 seconds.
 - 3.4.4. All extra high speed phases last 323 seconds.
- 3.5. WLTC city cycles

OVC-HEVs and PEVs shall be tested using the appropriate Class 3a and Class 3b WLTC and WLTC city cycles (see Sub-Annex 8).

The WLTC city cycle consists of the low and medium speed phases only.

▼ B

4. ► M3 WLTC Class 1 cycle ◀

Figure A1/1

▼ M3

WLTC, Class 1 cycle, phase Low₁

▼ B

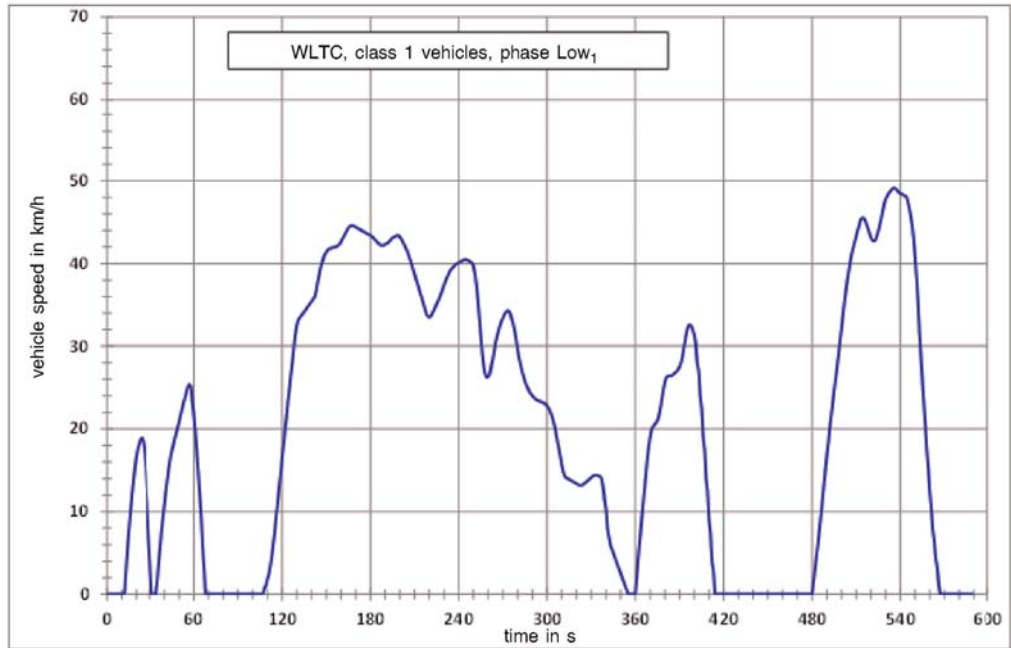
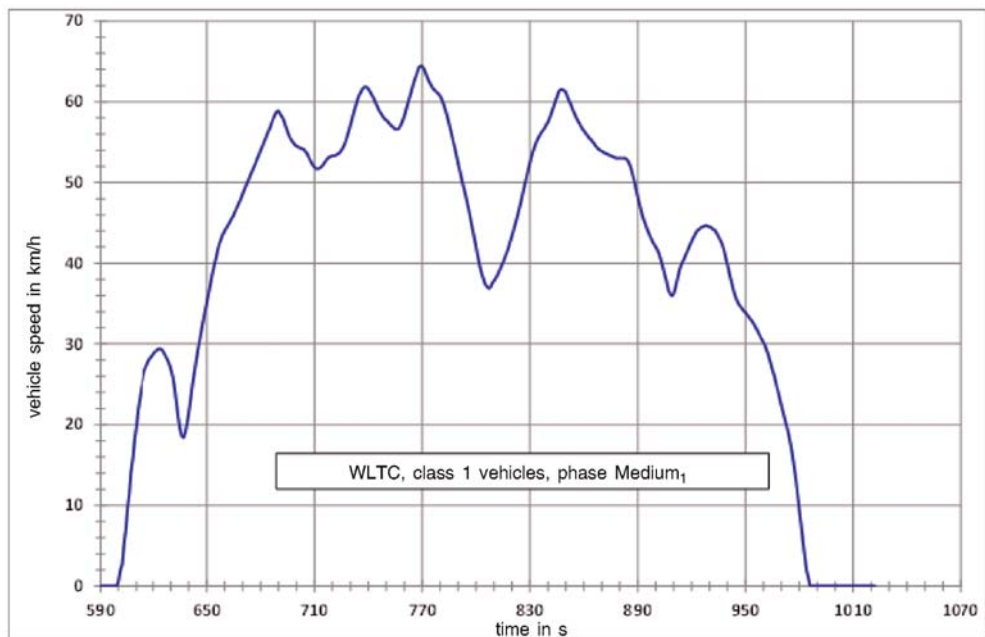

Figure A1/2

▼ M3

WLTC, Class 1 cycle, phase Medium₁

▼ B



▼B

Table A1/1

▼M3WLTC, Class 1 cycle, phase Low₁▼B

Time in s	Speed in km/h	Time in s	Speed in km/h	Time in s	Speed in km/h	Time in s	Speed in km/h
0	0,0	35	1,5	70	0,0	105	0,0
1	0,0	36	3,8	71	0,0	106	0,0
2	0,0	37	5,6	72	0,0	107	0,0
3	0,0	38	7,5	73	0,0	108	0,7
4	0,0	39	9,2	74	0,0	109	1,1
5	0,0	40	10,8	75	0,0	110	1,9
6	0,0	41	12,4	76	0,0	111	2,5
7	0,0	42	13,8	77	0,0	112	3,5
8	0,0	43	15,2	78	0,0	113	4,7
9	0,0	44	16,3	79	0,0	114	6,1
10	0,0	45	17,3	80	0,0	115	7,5
11	0,0	46	18,0	81	0,0	116	9,4
12	0,2	47	18,8	82	0,0	117	11,0
13	3,1	48	19,5	83	0,0	118	12,9
14	5,7	49	20,2	84	0,0	119	14,5
15	8,0	50	20,9	85	0,0	120	16,4
16	10,1	51	21,7	86	0,0	121	18,0
17	12,0	52	22,4	87	0,0	122	20,0
18	13,8	53	23,1	88	0,0	123	21,5
19	15,4	54	23,7	89	0,0	124	23,5
20	16,7	55	24,4	90	0,0	125	25,0
21	17,7	56	25,1	91	0,0	126	26,8
22	18,3	57	25,4	92	0,0	127	28,2
23	18,8	58	25,2	93	0,0	128	30,0
24	18,9	59	23,4	94	0,0	129	31,4
25	18,4	60	21,8	95	0,0	130	32,5
26	16,9	61	19,7	96	0,0	131	33,2
27	14,3	62	17,3	97	0,0	132	33,4
28	10,8	63	14,7	98	0,0	133	33,7
29	7,1	64	12,0	99	0,0	134	33,9
30	4,0	65	9,4	100	0,0	135	34,2
31	0,0	66	5,6	101	0,0	136	34,4
32	0,0	67	3,1	102	0,0	137	34,7
33	0,0	68	0,0	103	0,0	138	34,9
34	0,0	69	0,0	104	0,0	139	35,2

▼B

Time in s	Speed in km/h	Time in s	Speed in km/h	Time in s	Speed in km/h	Time in s	Speed in km/h
140	35,4	175	43,9	210	38,7	245	40,5
141	35,7	176	43,8	211	38,1	246	40,4
142	35,9	177	43,7	212	37,5	247	40,3
143	36,6	178	43,6	213	36,9	248	40,2
144	37,5	179	43,5	214	36,3	249	40,1
145	38,4	180	43,4	215	35,7	250	39,7
146	39,3	181	43,3	216	35,1	251	38,8
147	40,0	182	43,1	217	34,5	252	37,4
148	40,6	183	42,9	218	33,9	253	35,6
149	41,1	184	42,7	219	33,6	254	33,4
150	41,4	185	42,5	220	33,5	255	31,2
151	41,6	186	42,3	221	33,6	256	29,1
152	41,8	187	42,2	222	33,9	257	27,6
153	41,8	188	42,2	223	34,3	258	26,6
154	41,9	189	42,2	224	34,7	259	26,2
155	41,9	190	42,3	225	35,1	260	26,3
156	42,0	191	42,4	226	35,5	261	26,7
157	42,0	192	42,5	227	35,9	262	27,5
158	42,2	193	42,7	228	36,4	263	28,4
159	42,3	194	42,9	229	36,9	264	29,4
160	42,6	195	43,1	230	37,4	265	30,4
161	43,0	196	43,2	231	37,9	266	31,2
162	43,3	197	43,3	232	38,3	267	31,9
163	43,7	198	43,4	233	38,7	268	32,5
164	44,0	199	43,4	234	39,1	269	33,0
165	44,3	200	43,2	235	39,3	270	33,4
166	44,5	201	42,9	236	39,5	271	33,8
167	44,6	202	42,6	237	39,7	272	34,1
168	44,6	203	42,2	238	39,9	273	34,3
169	44,5	204	41,9	239	40,0	274	34,3
170	44,4	205	41,5	240	40,1	275	33,9
171	44,3	206	41,0	241	40,2	276	33,3
172	44,2	207	40,5	242	40,3	277	32,6
173	44,1	208	39,9	243	40,4	278	31,8
174	44,0	209	39,3	244	40,5	279	30,7

▼B

Time in s	Speed in km/h	Time in s	Speed in km/h	Time in s	Speed in km/h	Time in s	Speed in km/h
280	29,6	315	13,9	350	2,5	385	26,5
281	28,6	316	13,8	351	2,0	386	26,6
282	27,8	317	13,7	352	1,5	387	26,8
283	27,0	318	13,6	353	1,0	388	26,9
284	26,4	319	13,5	354	0,5	389	27,2
285	25,8	320	13,4	355	0,0	390	27,5
286	25,3	321	13,3	356	0,0	391	28,0
287	24,9	322	13,2	357	0,0	392	28,8
288	24,5	323	13,2	358	0,0	393	29,9
289	24,2	324	13,2	359	0,0	394	31,0
290	24,0	325	13,4	360	0,0	395	31,9
291	23,8	326	13,5	361	2,2	396	32,5
292	23,6	327	13,7	362	4,5	397	32,6
293	23,5	328	13,8	363	6,6	398	32,4
294	23,4	329	14,0	364	8,6	399	32,0
295	23,3	330	14,1	365	10,6	400	31,3
296	23,3	331	14,3	366	12,5	401	30,3
297	23,2	332	14,4	367	14,4	402	28,0
298	23,1	333	14,4	368	16,3	403	27,0
299	23,0	334	14,4	369	17,9	404	24,0
300	22,8	335	14,3	370	19,1	405	22,5
301	22,5	336	14,3	371	19,9	406	19,0
302	22,1	337	14,0	372	20,3	407	17,5
303	21,7	338	13,0	373	20,5	408	14,0
304	21,1	339	11,4	374	20,7	409	12,5
305	20,4	340	10,2	375	21,0	410	9,0
306	19,5	341	8,0	376	21,6	411	7,5
307	18,5	342	7,0	377	22,6	412	4,0
308	17,6	343	6,0	378	23,7	413	2,9
309	16,6	344	5,5	379	24,8	414	0,0
310	15,7	345	5,0	380	25,7	415	0,0
311	14,9	346	4,5	381	26,2	416	0,0
312	14,3	347	4,0	382	26,4	417	0,0
313	14,1	348	3,5	383	26,4	418	0,0
314	14,0	349	3,0	384	26,4	419	0,0

▼B

Time in s	Speed in km/h	Time in s	Speed in km/h	Time in s	Speed in km/h	Time in s	Speed in km/h
420	0,0	455	0,0	490	16,8	525	43,9
421	0,0	456	0,0	491	18,4	526	44,6
422	0,0	457	0,0	492	20,1	527	45,4
423	0,0	458	0,0	493	21,6	528	46,3
424	0,0	459	0,0	494	23,1	529	47,2
425	0,0	460	0,0	495	24,6	530	47,8
426	0,0	461	0,0	496	26,0	531	48,2
427	0,0	462	0,0	497	27,5	532	48,5
428	0,0	463	0,0	498	29,0	533	48,7
429	0,0	464	0,0	499	30,6	534	48,9
430	0,0	465	0,0	500	32,1	535	49,1
431	0,0	466	0,0	501	33,7	536	49,1
432	0,0	467	0,0	502	35,3	537	49,0
433	0,0	468	0,0	503	36,8	538	48,8
434	0,0	469	0,0	504	38,1	539	48,6
435	0,0	470	0,0	505	39,3	540	48,5
436	0,0	471	0,0	506	40,4	541	48,4
437	0,0	472	0,0	507	41,2	542	48,3
438	0,0	473	0,0	508	41,9	543	48,2
439	0,0	474	0,0	509	42,6	544	48,1
440	0,0	475	0,0	510	43,3	545	47,5
441	0,0	476	0,0	511	44,0	546	46,7
442	0,0	477	0,0	512	44,6	547	45,7
443	0,0	478	0,0	513	45,3	548	44,6
444	0,0	479	0,0	514	45,5	549	42,9
445	0,0	480	0,0	515	45,5	550	40,8
446	0,0	481	1,6	516	45,2	551	38,2
447	0,0	482	3,1	517	44,7	552	35,3
448	0,0	483	4,6	518	44,2	553	31,8
449	0,0	484	6,1	519	43,6	554	28,7
450	0,0	485	7,8	520	43,1	555	25,8
451	0,0	486	9,5	521	42,8	556	22,9
452	0,0	487	11,3	522	42,7	557	20,2
453	0,0	488	13,2	523	42,8	558	17,3
454	0,0	489	15,0	524	43,3	559	15,0

▼B

Time in s	Speed in km/h	Time in s	Speed in km/h	Time in s	Speed in km/h	Time in s	Speed in km/h
560	12,3	567	0,0	574	0,0	582	0,0
561	10,3	568	0,0	575	0,0	583	0,0
562	7,8	569	0,0	576	0,0	584	0,0
563	6,5	570	0,0	577	0,0	585	0,0
564	4,4	571	0,0	578	0,0	586	0,0
565	3,2	572	0,0	579	0,0	587	0,0
566	1,2	573	0,0	580	0,0	588	0,0
				581	0,0	589	0,0

Table A1/2

▼M3**WLTC, Class 1 cycle, phase Medium₁****▼B**

Time in s	Speed in km/h	Time in s	Speed in km/h	Time in s	Speed in km/h	Time in s	Speed in km/h
590	0,0	614	25,8	638	19,0	662	44,8
591	0,0	615	26,7	639	20,1	663	45,2
592	0,0	616	27,2	640	21,5	664	45,6
593	0,0	617	27,7	641	23,1	665	46,0
594	0,0	618	28,1	642	24,9	666	46,5
595	0,0	619	28,4	643	26,4	667	47,0
596	0,0	620	28,7	644	27,9	668	47,5
597	0,0	621	29,0	645	29,2	669	48,0
598	0,0	622	29,2	646	30,4	670	48,6
599	0,0	623	29,4	647	31,6	671	49,1
600	0,6	624	29,4	648	32,8	672	49,7
601	1,9	625	29,3	649	34,0	673	50,2
602	2,7	626	28,9	650	35,1	674	50,8
603	5,2	627	28,5	651	36,3	675	51,3
604	7,0	628	28,1	652	37,4	676	51,8
605	9,6	629	27,6	653	38,6	677	52,3
606	11,4	630	26,9	654	39,6	678	52,9
607	14,1	631	26,0	655	40,6	679	53,4
608	15,8	632	24,6	656	41,6	680	54,0
609	18,2	633	22,8	657	42,4	681	54,5
610	19,7	634	21,0	658	43,0	682	55,1
611	21,8	635	19,5	659	43,6	683	55,6
612	23,2	636	18,6	660	44,0	684	56,2
613	24,7	637	18,4	661	44,4	685	56,7
						686	57,3

▼B

Time in s	Speed in km/h	Time in s	Speed in km/h	Time in s	Speed in km/h	Time in s	Speed in km/h
687	57,9	723	53,5	760	58,2	797	45,4
688	58,4	724	53,7	761	59,0	798	44,3
689	58,8	725	54,0	762	59,8	799	43,1
690	58,9	726	54,4	763	60,6	800	42,0
691	58,4	727	54,9	764	61,4	801	40,8
692	58,1	728	55,6	765	62,2	802	39,7
693	57,6	729	56,3	766	62,9	803	38,8
694	56,9	730	57,1	767	63,5	804	38,1
695	56,3	731	57,9	768	64,2	805	37,4
696	55,7	732	58,8	769	64,4	806	37,1
697	55,3	733	59,6	770	64,4	807	36,9
698	55,0	734	60,3	771	64,0	808	37,0
699	54,7	735	60,9	772	63,5	809	37,5
700	54,5	736	61,3	773	62,9	810	37,8
701	54,4	737	61,7	774	62,4	811	38,2
702	54,3	738	61,8	775	62,0	812	38,6
703	54,2	739	61,8	776	61,6	813	39,1
704	54,1	740	61,6	777	61,4	814	39,6
705	53,8	741	61,2	778	61,2	815	40,1
706	53,5	742	60,8	779	61,0	816	40,7
707	53,0	743	60,4	780	60,7	817	41,3
708	52,6	744	59,9	781	60,2	818	41,9
709	52,2	745	59,4	782	59,6	819	42,7
710	51,9	746	58,9	783	58,9	820	43,4
711	51,7	747	58,6	784	58,1	821	44,2
712	51,7	748	58,2	785	57,2	822	45,0
713	51,8	749	57,9	786	56,3	823	45,9
714	52,0	750	57,7	787	55,3	824	46,8
715	52,3	751	57,5	788	54,4	825	47,7
716	52,6	752	57,2	789	53,4	826	48,7
717	52,9	753	57,0	790	52,4	827	49,7
718	53,1	754	56,8	791	51,4	828	50,6
719	53,2	755	56,6	792	50,4	829	51,6
720	53,3	756	56,6	793	49,4	830	52,5
721	53,3	757	56,7	794	48,5	831	53,3
722	53,4	758	57,1	795	47,5	832	54,1
		759	57,6	796	46,5	833	54,7

▼B

Time in s	Speed in km/h	Time in s	Speed in km/h	Time in s	Speed in km/h	Time in s	Speed in km/h
834	55,3	871	53,7	908	36,2	945	35,5
835	55,7	872	53,6	909	36,0	946	35,0
836	56,1	873	53,5	910	36,2	947	34,7
837	56,4	874	53,4	911	37,0	948	34,4
838	56,7	875	53,3	912	38,0	949	34,1
839	57,1	876	53,2	913	39,0	950	33,9
840	57,5	877	53,1	914	39,7	951	33,6
841	58,0	878	53,0	915	40,2	952	33,3
842	58,7	879	53,0	916	40,7	953	33,0
843	59,3	880	53,0	917	41,2	954	32,7
844	60,0	881	53,0	918	41,7	955	32,3
845	60,6	882	53,0	919	42,2	956	31,9
846	61,3	883	53,0	920	42,7	957	31,5
847	61,5	884	52,8	921	43,2	958	31,0
848	61,5	885	52,5	922	43,6	959	30,6
849	61,4	886	51,9	923	44,0	960	30,2
850	61,2	887	51,1	924	44,2	961	29,7
851	60,5	888	50,2	925	44,4	962	29,1
852	60,0	889	49,2	926	44,5	963	28,4
853	59,5	890	48,2	927	44,6	964	27,6
854	58,9	891	47,3	928	44,7	965	26,8
855	58,4	892	46,4	929	44,6	966	26,0
856	57,9	893	45,6	930	44,5	967	25,1
857	57,5	894	45,0	931	44,4	968	24,2
858	57,1	895	44,3	932	44,2	969	23,3
859	56,7	896	43,8	933	44,1	970	22,4
860	56,4	897	43,3	934	43,7	971	21,5
861	56,1	898	42,8	935	43,3	972	20,6
862	55,8	899	42,4	936	42,8	973	19,7
863	55,5	900	42,0	937	42,3	974	18,8
864	55,3	901	41,6	938	41,6	975	17,7
865	55,0	902	41,1	939	40,7	976	16,4
866	54,7	903	40,3	940	39,8	977	14,9
867	54,4	904	39,5	941	38,8	978	13,2
868	54,2	905	38,6	942	37,8	979	11,3
869	54,0	906	37,7	943	36,9	980	9,4
870	53,9	907	36,7	944	36,1	981	7,5

▼ B

Time in s	Speed in km/h	Time in s	Speed in km/h	Time in s	Speed in km/h	Time in s	Speed in km/h
982	5,6	993	0,0	1003	0,0	1013	0,0
983	3,7	994	0,0	1004	0,0	1014	0,0
984	1,9	995	0,0	1005	0,0	1015	0,0
985	1,0	996	0,0	1006	0,0	1016	0,0
986	0,0	997	0,0	1007	0,0	1017	0,0
987	0,0	998	0,0	1008	0,0	1018	0,0
988	0,0	999	0,0	1009	0,0	1019	0,0
989	0,0	1000	0,0	1010	0,0	1020	0,0
990	0,0	1001	0,0	1011	0,0	1021	0,0
991	0,0	1002	0,0	1012	0,0	1022	0,0

5. ▼ M3 WLTC Class 2 cycle ◀

Figure A1/3

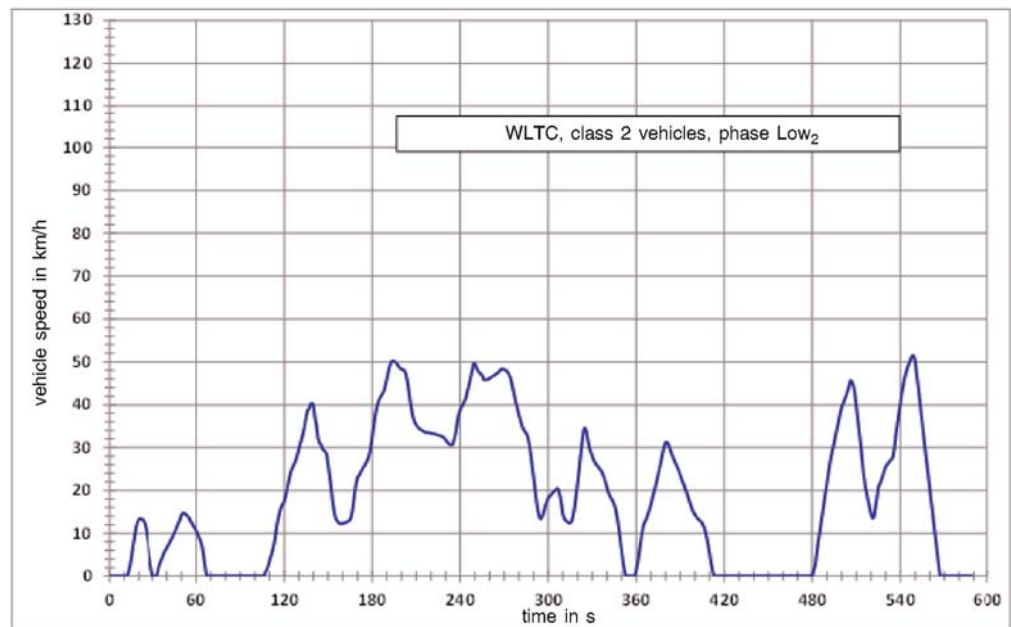
▼ M3WLTC, Class 2 cycle, phase Low₂▼ B

▼ B

Figure A1/4

▼ M3WLTC, Class 2 cycle, phase Medium₂▼ B

Figure A1/5

▼ M3WLTC, Class 2 cycle, phase High₂▼ B

▼ B

Figure A1/6

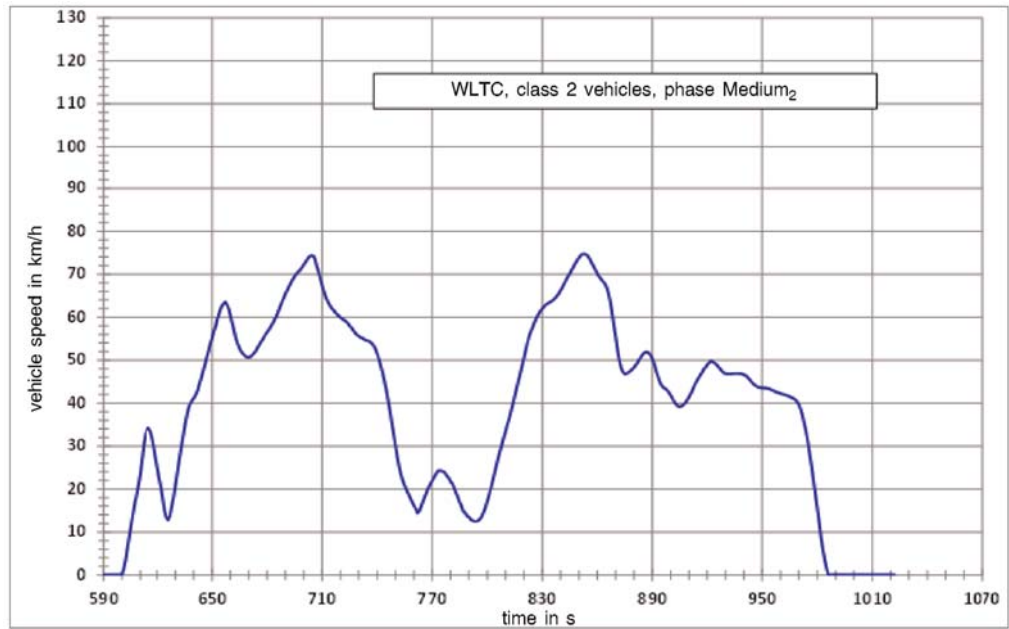
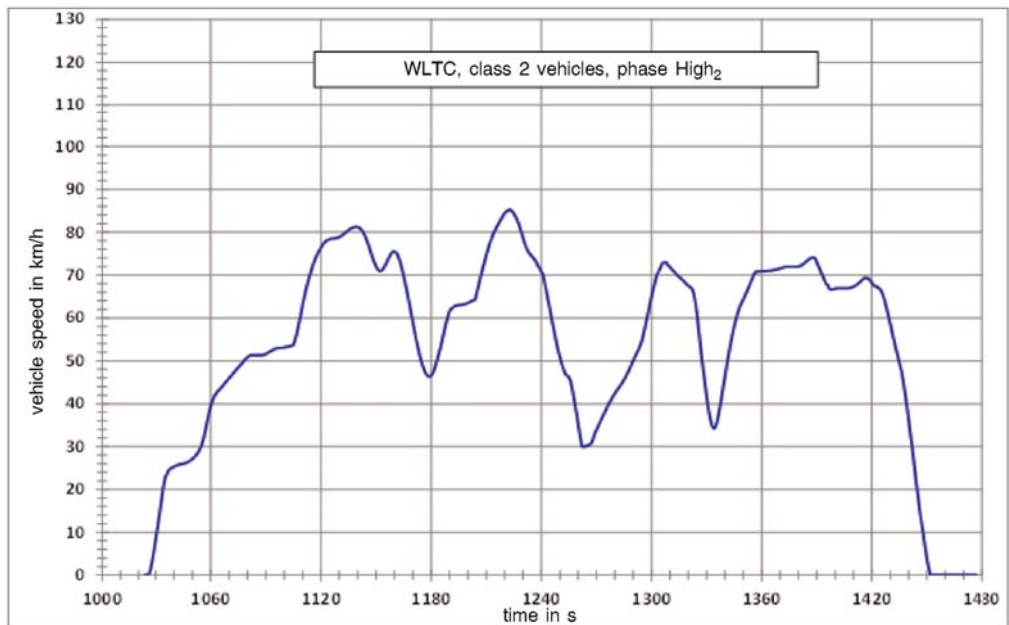
▼ M3WLTC, Class 2 cycle, phase Extra High₂▼ B

Table A1/3

▼ M3WLTC, Class 2 cycle, phase Low₂▼ B

Time in s	Speed in km/h	Time in s	Speed in km/h	Time in s	Speed in km/h	Time in s	Speed in km/h
0	0,0	19	12,7	38	5,3	57	12,4
1	0,0	20	13,3	39	6,0	58	11,8
2	0,0	21	13,4	40	6,6	59	11,2
3	0,0	22	13,3	41	7,3	60	10,6
4	0,0	23	13,1	42	7,9	61	9,9
5	0,0	24	12,5	43	8,6	62	9,0
6	0,0	25	11,1	44	9,3	63	8,2
7	0,0	26	8,9	45	10	64	7,0
8	0,0	27	6,2	46	10,8	65	4,8
9	0,0	28	3,8	47	11,6	66	2,3
10	0,0	29	1,8	48	12,4	67	0,0
11	0,0	30	0,0	49	13,2	68	0,0
12	0,0	31	0,0	50	14,2	69	0,0
13	1,2	32	0,0	51	14,8	70	0,0
14	2,6	33	0,0	52	14,7	71	0,0
15	4,9	34	1,5	53	14,4	72	0,0
16	7,3	35	2,8	54	14,1	73	0,0
17	9,4	36	3,6	55	13,6	74	0,0
18	11,4	37	4,5	56	13,0	75	0,0

▼B

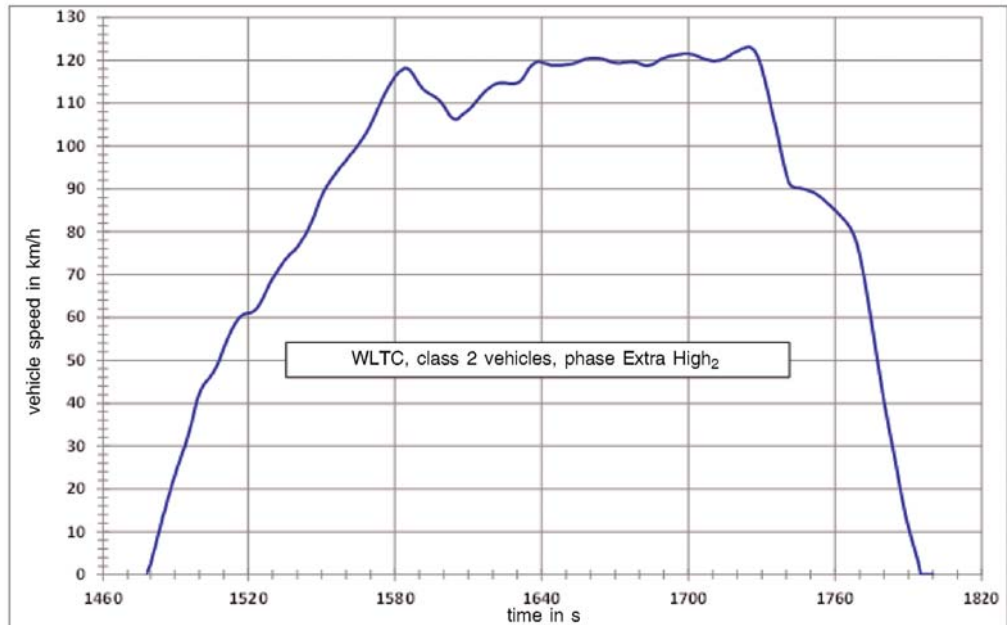
Time in s	Speed in km/h	Time in s	Speed in km/h	Time in s	Speed in km/h	Time in s	Speed in km/h
76	0,0	113	7,4	150	26,0	187	42,5
77	0,0	114	9,2	151	23,4	188	43,2
78	0,0	115	11,7	152	20,7	189	44,4
79	0,0	116	13,5	153	17,4	190	45,9
80	0,0	117	15,0	154	15,2	191	47,6
81	0,0	118	16,2	155	13,5	192	49,0
82	0,0	119	16,8	156	13,0	193	50,0
83	0,0	120	17,5	157	12,4	194	50,2
84	0,0	121	18,8	158	12,3	195	50,1
85	0,0	122	20,3	159	12,2	196	49,8
86	0,0	123	22,0	160	12,3	197	49,4
87	0,0	124	23,6	161	12,4	198	48,9
88	0,0	125	24,8	162	12,5	199	48,5
89	0,0	126	25,6	163	12,7	200	48,3
90	0,0	127	26,3	164	12,8	201	48,2
91	0,0	128	27,2	165	13,2	202	47,9
92	0,0	129	28,3	166	14,3	203	47,1
93	0,0	130	29,6	167	16,5	204	45,5
94	0,0	131	30,9	168	19,4	205	43,2
95	0,0	132	32,2	169	21,7	206	40,6
96	0,0	133	33,4	170	23,1	207	38,5
97	0,0	134	35,1	171	23,5	208	36,9
98	0,0	135	37,2	172	24,2	209	35,9
99	0,0	136	38,7	173	24,8	210	35,3
100	0,0	137	39,0	174	25,4	211	34,8
101	0,0	138	40,1	175	25,8	212	34,5
102	0,0	139	40,4	176	26,5	213	34,2
103	0,0	140	39,7	177	27,2	214	34,0
104	0,0	141	36,8	178	28,3	215	33,8
105	0,0	142	35,1	179	29,9	216	33,6
106	0,0	143	32,2	180	32,4	217	33,5
107	0,8	144	31,1	181	35,1	218	33,5
108	1,4	145	30,8	182	37,5	219	33,4
109	2,3	146	29,7	183	39,2	220	33,3
110	3,5	147	29,4	184	40,5	221	33,3
111	4,7	148	29,0	185	41,4	222	33,2
112	5,9	149	28,5	186	42,0	223	33,1

▼B

Time in s	Speed in km/h	Time in s	Speed in km/h	Time in s	Speed in km/h	Time in s	Speed in km/h
224	33,0	261	46,4	298	16,3	335	25,0
225	32,9	262	46,6	299	17,4	336	24,6
226	32,8	263	46,8	300	18,2	337	23,9
227	32,7	264	47,0	301	18,6	338	23,0
228	32,5	265	47,3	302	19,0	339	21,8
229	32,3	266	47,5	303	19,4	340	20,7
230	31,8	267	47,9	304	19,8	341	19,6
231	31,4	268	48,3	305	20,1	342	18,7
232	30,9	269	48,3	306	20,5	343	18,1
233	30,6	270	48,2	307	20,2	344	17,5
234	30,6	271	48,0	308	18,6	345	16,7
235	30,7	272	47,7	309	16,5	346	15,4
236	32,0	273	47,2	310	14,4	347	13,6
237	33,5	274	46,5	311	13,4	348	11,2
238	35,8	275	45,2	312	12,9	349	8,6
239	37,6	276	43,7	313	12,7	350	6,0
240	38,8	277	42,0	314	12,4	351	3,1
241	39,6	278	40,4	315	12,4	352	1,2
242	40,1	279	39,0	316	12,8	353	0,0
243	40,9	280	37,7	317	14,1	354	0,0
244	41,8	281	36,4	318	16,2	355	0,0
245	43,3	282	35,2	319	18,8	356	0,0
246	44,7	283	34,3	320	21,9	357	0,0
247	46,4	284	33,8	321	25,0	358	0,0
248	47,9	285	33,3	322	28,4	359	0,0
249	49,6	286	32,5	323	31,3	360	1,4
250	49,6	287	30,9	324	34,0	361	3,2
251	48,8	288	28,6	325	34,6	362	5,6
252	48,0	289	25,9	326	33,9	363	8,1
253	47,5	290	23,1	327	31,9	364	10,3
254	47,1	291	20,1	328	30,0	365	12,1
255	46,9	292	17,3	329	29,0	366	12,6
256	45,8	293	15,1	330	27,9	367	13,6
257	45,8	294	13,7	331	27,1	368	14,5
258	45,8	295	13,4	332	26,4	369	15,6
259	45,9	296	13,9	333	25,9	370	16,8
260	46,2	297	15,0	334	25,5	371	18,2

▼B

Time in s	Speed in km/h	Time in s	Speed in km/h	Time in s	Speed in km/h	Time in s	Speed in km/h
372	19,6	409	7,2	446	0,0	483	5,2
373	20,9	410	5,2	447	0,0	484	7,9
374	22,3	411	2,9	448	0,0	485	10,3
375	23,8	412	1,2	449	0,0	486	12,7
376	25,4	413	0,0	450	0,0	487	15,0
377	27,0	414	0,0	451	0,0	488	17,4
378	28,6	415	0,0	452	0,0	489	19,7
379	30,2	416	0,0	453	0,0	490	21,9
380	31,2	417	0,0	454	0,0	491	24,1
381	31,2	418	0,0	455	0,0	492	26,2
382	30,7	419	0,0	456	0,0	493	28,1
383	29,5	420	0,0	457	0,0	494	29,7
384	28,6	421	0,0	458	0,0	495	31,3
385	27,7	422	0,0	459	0,0	496	33,0
386	26,9	423	0,0	460	0,0	497	34,7
387	26,1	424	0,0	461	0,0	498	36,3
388	25,4	425	0,0	462	0,0	499	38,1
389	24,6	426	0,0	463	0,0	500	39,4
390	23,6	427	0,0	464	0,0	501	40,4
391	22,6	428	0,0	465	0,0	502	41,2
392	21,7	429	0,0	466	0,0	503	42,1
393	20,7	430	0,0	467	0,0	504	43,2
394	19,8	431	0,0	468	0,0	505	44,3
395	18,8	432	0,0	469	0,0	506	45,7
396	17,7	433	0,0	470	0,0	507	45,4
397	16,6	434	0,0	471	0,0	508	44,5
398	15,6	435	0,0	472	0,0	509	42,5
399	14,8	436	0,0	473	0,0	510	39,5
400	14,3	437	0,0	474	0,0	511	36,5
401	13,8	438	0,0	475	0,0	512	33,5
402	13,4	439	0,0	476	0,0	513	30,4
403	13,1	440	0,0	477	0,0	514	27,0
404	12,8	441	0,0	478	0,0	515	23,6
405	12,3	442	0,0	479	0,0	516	21,0
406	11,6	443	0,0	480	0,0	517	19,5
407	10,5	444	0,0	481	1,4	518	17,6
408	9,0	445	0,0	482	2,5	519	16,1

▼B

Time in s	Speed in km/h	Time in s	Speed in km/h	Time in s	Speed in km/h	Time in s	Speed in km/h
520	14,5	538	35,4	556	32,5	573	0,0
521	13,5	539	38,0	557	29,5	574	0,0
522	13,7	540	40,1	558	26,5	575	0,0
523	16,0	541	42,7	559	23,5	576	0,0
524	18,1	542	44,5	560	20,4	577	0,0
525	20,8	543	46,3	561	17,5	578	0,0
526	21,5	544	47,6	562	14,5	579	0,0
527	22,5	545	48,8	563	11,5	580	0,0
528	23,4	546	49,7	564	8,5	581	0,0
529	24,5	547	50,6	565	5,6	582	0,0
530	25,6	548	51,4	566	2,6	583	0,0
531	26,0	549	51,4	567	0,0	584	0,0
532	26,5	550	50,2	568	0,0	585	0,0
533	26,9	551	47,1	569	0,0	586	0,0
534	27,3	552	44,5	570	0,0	587	0,0
535	27,9	553	41,5	571	0,0	588	0,0
536	30,3	554	38,5	572	0,0	589	0,0
537	33,2	555	35,5				

Table A1/4

▼M3**WLTC, Class 2 cycle, phase Medium₂****▼B**

Time in s	Speed in km/h	Time in s	Speed in km/h	Time in s	Speed in km/h	Time in s	Speed in km/h
590	0,0	605	11,8	620	25,1	635	34,5
591	0,0	606	14,2	621	22,8	636	36,8
592	0,0	607	16,6	622	20,5	637	38,6
593	0,0	608	18,5	623	17,9	638	39,8
594	0,0	609	20,8	624	15,1	639	40,6
595	0,0	610	23,4	625	13,4	640	41,1
596	0,0	611	26,9	626	12,8	641	41,9
597	0,0	612	30,3	627	13,7	642	42,8
598	0,0	613	32,8	628	16,0	643	44,3
599	0,0	614	34,1	629	18,1	644	45,7
600	0,0	615	34,2	630	20,8	645	47,4
601	1,6	616	33,6	631	23,7	646	48,9
602	3,6	617	32,1	632	26,5	647	50,6
603	6,3	618	30,0	633	29,3	648	52,0
604	9,0	619	27,5	634	32,0	649	53,7

▼B

Time in s	Speed in km/h	Time in s	Speed in km/h	Time in s	Speed in km/h	Time in s	Speed in km/h
650	55,0	687	62,4	724	58,6	761	15,5
651	56,8	688	63,4	725	58,0	762	14,4
652	58,0	689	64,4	726	57,5	763	14,9
653	59,8	690	65,4	727	56,9	764	15,9
654	61,1	691	66,3	728	56,3	765	17,1
655	62,4	692	67,2	729	55,9	766	18,3
656	63,0	693	68,0	730	55,6	767	19,4
657	63,5	694	68,8	731	55,3	768	20,4
658	63,0	695	69,5	732	55,1	769	21,2
659	62,0	696	70,1	733	54,8	770	21,9
660	60,4	697	70,6	734	54,6	771	22,7
661	58,6	698	71,0	735	54,5	772	23,4
662	56,7	699	71,6	736	54,3	773	24,2
663	55,0	700	72,2	737	53,9	774	24,3
664	53,7	701	72,8	738	53,4	775	24,2
665	52,7	702	73,5	739	52,6	776	24,1
666	51,9	703	74,1	740	51,5	777	23,8
667	51,4	704	74,3	741	50,2	778	23,0
668	51,0	705	74,3	742	48,7	779	22,6
669	50,7	706	73,7	743	47,0	780	21,7
670	50,6	707	71,9	744	45,1	781	21,3
671	50,8	708	70,5	745	43,0	782	20,3
672	51,2	709	68,9	746	40,6	783	19,1
673	51,7	710	67,4	747	38,1	784	18,1
674	52,3	711	66,0	748	35,4	785	16,9
675	53,1	712	64,7	749	32,7	786	16,0
676	53,8	713	63,7	750	30,0	787	14,8
677	54,5	714	62,9	751	27,5	788	14,5
678	55,1	715	62,2	752	25,3	789	13,7
679	55,9	716	61,7	753	23,4	790	13,5
680	56,5	717	61,2	754	22,0	791	12,9
681	57,1	718	60,7	755	20,8	792	12,7
682	57,8	719	60,3	756	19,8	793	12,5
683	58,5	720	59,9	757	18,9	794	12,5
684	59,3	721	59,6	758	18,0	795	12,6
685	60,2	722	59,3	759	17,0	796	13,0
686	61,3	723	59,0	760	16,1	797	13,6

▼B

Time in s	Speed in km/h	Time in s	Speed in km/h	Time in s	Speed in km/h	Time in s	Speed in km/h
798	14,6	835	63,7	872	50,0	909	40,7
799	15,7	836	64,0	873	48,3	910	41,4
800	17,1	837	64,4	874	47,3	911	42,2
801	18,7	838	64,9	875	46,8	912	43,1
802	20,2	839	65,5	876	46,9	913	44,1
803	21,9	840	66,2	877	47,1	914	44,9
804	23,6	841	67,0	878	47,5	915	45,6
805	25,4	842	67,8	879	47,8	916	46,4
806	27,1	843	68,6	880	48,3	917	47,0
807	28,9	844	69,4	881	48,8	918	47,8
808	30,4	845	70,1	882	49,5	919	48,3
809	32,0	846	70,9	883	50,2	920	48,9
810	33,4	847	71,7	884	50,8	921	49,4
811	35,0	848	72,5	885	51,4	922	49,8
812	36,4	849	73,2	886	51,8	923	49,6
813	38,1	850	73,8	887	51,9	924	49,3
814	39,7	851	74,4	888	51,7	925	49,0
815	41,6	852	74,7	889	51,2	926	48,5
816	43,3	853	74,7	890	50,4	927	48,0
817	45,1	854	74,6	891	49,2	928	47,5
818	46,9	855	74,2	892	47,7	929	47,0
819	48,7	856	73,5	893	46,3	930	46,9
820	50,5	857	72,6	894	45,1	931	46,8
821	52,4	858	71,8	895	44,2	932	46,8
822	54,1	859	71,0	896	43,7	933	46,8
823	55,7	860	70,1	897	43,4	934	46,9
824	56,8	861	69,4	898	43,1	935	46,9
825	57,9	862	68,9	899	42,5	936	46,9
826	59,0	863	68,4	900	41,8	937	46,9
827	59,9	864	67,9	901	41,1	938	46,9
828	60,7	865	67,1	902	40,3	939	46,8
829	61,4	866	65,8	903	39,7	940	46,6
830	62,0	867	63,9	904	39,3	941	46,4
831	62,5	868	61,4	905	39,2	942	46,0
832	62,9	869	58,4	906	39,3	943	45,5
833	63,2	870	55,4	907	39,6	944	45,0
834	63,4	871	52,4	908	40,0	945	44,5

▼B

Time in s	Speed in km/h	Time in s	Speed in km/h	Time in s	Speed in km/h	Time in s	Speed in km/h
946	44,2	966	41,3	985	1,6	1004	0,0
947	43,9	967	41,1	986	0,0	1005	0,0
948	43,7	968	40,8	987	0,0	1006	0,0
949	43,6	969	40,3	988	0,0	1007	0,0
950	43,6	970	39,6	989	0,0	1008	0,0
951	43,5	971	38,5	990	0,0	1009	0,0
952	43,5	972	37,0	991	0,0	1010	0,0
953	43,4	973	35,1	992	0,0	1011	0,0
954	43,3	974	33,0	993	0,0	1012	0,0
955	43,1	975	30,6	994	0,0	1013	0,0
956	42,9	976	27,9	995	0,0	1014	0,0
957	42,7	977	25,1	996	0,0	1015	0,0
958	42,5	978	22,0	997	0,0	1016	0,0
959	42,4	979	18,8	998	0,0	1017	0,0
960	42,2	980	15,5	999	0,0	1018	0,0
961	42,1	981	12,3	1000	0,0	1019	0,0
962	42,0	982	8,8	1001	0,0	1020	0,0
963	41,8	983	6,0	1002	0,0	1021	0,0
964	41,7	984	3,6	1003	0,0	1022	0,0

Table A1/5

▼M3**WLTC, Class 2 cycle, phase High₂****▼B**

Time in s	Speed in km/h	Time in s	Speed in km/h	Time in s	Speed in km/h	Time in s	Speed in km/h
1023	0,0	1036	23,6	1049	26,8	1062	41,8
1024	0,0	1037	24,5	1050	27,1	1063	42,4
1025	0,0	1038	24,8	1051	27,5	1064	43,0
1026	0,0	1039	25,1	1052	28,0	1065	43,4
1027	1,1	1040	25,3	1053	28,6	1066	44,0
1028	3,0	1041	25,5	1054	29,3	1067	44,4
1029	5,7	1042	25,7	1055	30,4	1068	45,0
1030	8,4	1043	25,8	1056	31,8	1069	45,4
1031	11,1	1044	25,9	1057	33,7	1070	46,0
1032	14,0	1045	26,0	1058	35,8	1071	46,4
1033	17,0	1046	26,1	1059	37,8	1072	47,0
1034	20,1	1047	26,3	1060	39,5	1073	47,4
1035	22,7	1048	26,5	1061	40,8	1074	48,0

▼B

Time in s	Speed in km/h	Time in s	Speed in km/h	Time in s	Speed in km/h	Time in s	Speed in km/h
1075	48,4	1112	66,9	1149	72,9	1186	54,9
1076	49,0	1113	68,6	1150	71,9	1187	56,7
1077	49,4	1114	70,1	1151	71,2	1188	58,6
1078	50,0	1115	71,5	1152	70,9	1189	60,2
1079	50,4	1116	72,8	1153	71,0	1190	61,6
1080	50,8	1117	73,9	1154	71,5	1191	62,2
1081	51,1	1118	74,9	1155	72,3	1192	62,5
1082	51,3	1119	75,7	1156	73,2	1193	62,8
1083	51,3	1120	76,4	1157	74,1	1194	62,9
1084	51,3	1121	77,1	1158	74,9	1195	63,0
1085	51,3	1122	77,6	1159	75,4	1196	63,0
1086	51,3	1123	78,0	1160	75,5	1197	63,1
1087	51,3	1124	78,2	1161	75,2	1198	63,2
1088	51,3	1125	78,4	1162	74,5	1199	63,3
1089	51,4	1126	78,5	1163	73,3	1200	63,5
1090	51,6	1127	78,5	1164	71,7	1201	63,7
1091	51,8	1128	78,6	1165	69,9	1202	63,9
1092	52,1	1129	78,7	1166	67,9	1203	64,1
1093	52,3	1130	78,9	1167	65,7	1204	64,3
1094	52,6	1131	79,1	1168	63,5	1205	66,1
1095	52,8	1132	79,4	1169	61,2	1206	67,9
1096	52,9	1133	79,8	1170	59,0	1207	69,7
1097	53,0	1134	80,1	1171	56,8	1208	71,4
1098	53,0	1135	80,5	1172	54,7	1209	73,1
1099	53,0	1136	80,8	1173	52,7	1210	74,7
1100	53,1	1137	81,0	1174	50,9	1211	76,2
1101	53,2	1138	81,2	1175	49,4	1212	77,5
1102	53,3	1139	81,3	1176	48,1	1213	78,6
1103	53,4	1140	81,2	1177	47,1	1214	79,7
1104	53,5	1141	81,0	1178	46,5	1215	80,6
1105	53,7	1142	80,6	1179	46,3	1216	81,5
1106	55,0	1143	80,0	1180	46,5	1217	82,2
1107	56,8	1144	79,1	1181	47,2	1218	83,0
1108	58,8	1145	78,0	1182	48,3	1219	83,7
1109	60,9	1146	76,8	1183	49,7	1220	84,4
1110	63,0	1147	75,5	1184	51,3	1221	84,9
1111	65,0	1148	74,1	1185	53,0	1222	85,1

▼B

Time in s	Speed in km/h	Time in s	Speed in km/h	Time in s	Speed in km/h	Time in s	Speed in km/h
1223	85,2	1260	35,4	1297	58,8	1334	34,2
1224	84,9	1261	32,7	1298	60,9	1335	34,7
1225	84,4	1262	30,0	1299	63,0	1336	36,3
1226	83,6	1263	29,9	1300	65,0	1337	38,5
1227	82,7	1264	30,0	1301	66,9	1338	41,0
1228	81,5	1265	30,2	1302	68,6	1339	43,7
1229	80,1	1266	30,4	1303	70,1	1340	46,5
1230	78,7	1267	30,6	1304	71,0	1341	49,1
1231	77,4	1268	31,6	1305	71,8	1342	51,6
1232	76,2	1269	33,0	1306	72,8	1343	53,9
1233	75,4	1270	33,9	1307	72,9	1344	56,0
1234	74,8	1271	34,8	1308	73,0	1345	57,9
1235	74,3	1272	35,7	1309	72,3	1346	59,7
1236	73,8	1273	36,6	1310	71,9	1347	61,2
1237	73,2	1274	37,5	1311	71,3	1348	62,5
1238	72,4	1275	38,4	1312	70,9	1349	63,5
1239	71,6	1276	39,3	1313	70,5	1350	64,3
1240	70,8	1277	40,2	1314	70,0	1351	65,3
1241	69,9	1278	40,8	1315	69,6	1352	66,3
1242	67,9	1279	41,7	1316	69,2	1353	67,3
1243	65,7	1280	42,4	1317	68,8	1354	68,3
1244	63,5	1281	43,1	1318	68,4	1355	69,3
1245	61,2	1282	43,6	1319	67,9	1356	70,3
1246	59,0	1283	44,2	1320	67,5	1357	70,8
1247	56,8	1284	44,8	1321	67,2	1358	70,8
1248	54,7	1285	45,5	1322	66,8	1359	70,8
1249	52,7	1286	46,3	1323	65,6	1360	70,9
1250	50,9	1287	47,2	1324	63,3	1361	70,9
1251	49,4	1288	48,1	1325	60,2	1362	70,9
1252	48,1	1289	49,1	1326	56,2	1363	70,9
1253	47,1	1290	50,0	1327	52,2	1364	71,0
1254	46,5	1291	51,0	1328	48,4	1365	71,0
1255	46,3	1292	51,9	1329	45,0	1366	71,1
1256	45,1	1293	52,7	1330	41,6	1367	71,2
1257	43,0	1294	53,7	1331	38,6	1368	71,3
1258	40,6	1295	55,0	1332	36,4	1369	71,4
1259	38,1	1296	56,8	1333	34,8	1370	71,5

▼ B

Time in s	Speed in km/h	Time in s	Speed in km/h	Time in s	Speed in km/h	Time in s	Speed in km/h
1371	71,7	1398	66,6	1425	66,3	1452	0,0
1372	71,8	1399	66,7	1426	65,4	1453	0,0
1373	71,9	1400	66,8	1427	64,0	1454	0,0
1374	71,9	1401	66,9	1428	62,4	1455	0,0
1375	71,9	1402	66,9	1429	60,6	1456	0,0
1376	71,9	1403	66,9	1430	58,6	1457	0,0
1377	71,9	1404	66,9	1431	56,7	1458	0,0
1378	71,9	1405	66,9	1432	54,8	1459	0,0
1379	71,9	1406	66,9	1433	53,0	1460	0,0
1380	72,0	1407	66,9	1434	51,3	1461	0,0
1381	72,1	1408	67,0	1435	49,6	1462	0,0
1382	72,4	1409	67,1	1436	47,8	1463	0,0
1383	72,7	1410	67,3	1437	45,5	1464	0,0
1384	73,1	1411	67,5	1438	42,8	1465	0,0
1385	73,4	1412	67,8	1439	39,8	1466	0,0
1386	73,8	1413	68,2	1440	36,5	1467	0,0
1387	74,0	1414	68,6	1441	33,0	1468	0,0
1388	74,1	1415	69,0	1442	29,5	1469	0,0
1389	74,0	1416	69,3	1443	25,8	1470	0,0
1390	73,0	1417	69,3	1444	22,1	1471	0,0
1391	72,0	1418	69,2	1445	18,6	1472	0,0
1392	71,0	1419	68,8	1446	15,3	1473	0,0
1393	70,0	1420	68,2	1447	12,4	1474	0,0
1394	69,0	1421	67,6	1448	9,6	1475	0,0
1395	68,0	1422	67,4	1449	6,6	1476	0,0
1396	67,7	1423	67,2	1450	3,8	1477	0,0
1397	66,7	1424	66,9	1451	1,6		

Table A1/6

▼ M3**WLTC, Class 2 cycle, phase Extra High₂****▼ B**

Time in s	Speed in km/h	Time in s	Speed in km/h	Time in s	Speed in km/h	Time in s	Speed in km/h
1478	0,0	1484	10,9	1490	23,0	1496	33,7
1479	1,1	1485	13,5	1491	25,0	1497	35,8
1480	2,3	1486	15,2	1492	26,5	1498	38,1
1481	4,6	1487	17,6	1493	28,4	1499	40,5
1482	6,5	1488	19,3	1494	29,8	1500	42,2
1483	8,9	1489	21,4	1495	31,7	1501	43,5

▼B

Time in s	Speed in km/h	Time in s	Speed in km/h	Time in s	Speed in km/h	Time in s	Speed in km/h
1502	44,5	1539	75,7	1576	112,3	1613	110,2
1503	45,2	1540	76,4	1577	113,4	1614	110,9
1504	45,8	1541	77,2	1578	114,4	1615	111,6
1505	46,6	1542	78,2	1579	115,3	1616	112,2
1506	47,4	1543	78,9	1580	116,1	1617	112,8
1507	48,5	1544	79,9	1581	116,8	1618	113,3
1508	49,7	1545	81,1	1582	117,4	1619	113,7
1509	51,3	1546	82,4	1583	117,7	1620	114,1
1510	52,9	1547	83,7	1584	118,2	1621	114,4
1511	54,3	1548	85,4	1585	118,1	1622	114,6
1512	55,6	1549	87,0	1586	117,7	1623	114,7
1513	56,8	1550	88,3	1587	117,0	1624	114,7
1514	57,9	1551	89,5	1588	116,1	1625	114,7
1515	58,9	1552	90,5	1589	115,2	1626	114,6
1516	59,7	1553	91,3	1590	114,4	1627	114,5
1517	60,3	1554	92,2	1591	113,6	1628	114,5
1518	60,7	1555	93,0	1592	113,0	1629	114,5
1519	60,9	1556	93,8	1593	112,6	1630	114,7
1520	61,0	1557	94,6	1594	112,2	1631	115,0
1521	61,1	1558	95,3	1595	111,9	1632	115,6
1522	61,4	1559	95,9	1596	111,6	1633	116,4
1523	61,8	1560	96,6	1597	111,2	1634	117,3
1524	62,5	1561	97,4	1598	110,7	1635	118,2
1525	63,4	1562	98,1	1599	110,1	1636	118,8
1526	64,5	1563	98,7	1600	109,3	1637	119,3
1527	65,7	1564	99,5	1601	108,4	1638	119,6
1528	66,9	1565	100,3	1602	107,4	1639	119,7
1529	68,1	1566	101,1	1603	106,7	1640	119,5
1530	69,1	1567	101,9	1604	106,3	1641	119,3
1531	70,0	1568	102,8	1605	106,2	1642	119,2
1532	70,9	1569	103,8	1606	106,4	1643	119,0
1533	71,8	1570	105,0	1607	107,0	1644	118,8
1534	72,6	1571	106,1	1608	107,5	1645	118,8
1535	73,4	1572	107,4	1609	107,9	1646	118,8
1536	74,0	1573	108,7	1610	108,4	1647	118,8
1537	74,7	1574	109,9	1611	108,9	1648	118,8
1538	75,2	1575	111,2	1612	109,5	1649	118,9

▼B

Time in s	Speed in km/h	Time in s	Speed in km/h	Time in s	Speed in km/h	Time in s	Speed in km/h
1650	119,0	1688	120,0	1726	122,8	1763	83,2
1651	119,0	1689	120,3	1727	122,3	1764	82,6
1652	119,1	1690	120,5	1728	121,3	1765	81,9
1653	119,2	1691	120,7	1729	119,9	1766	81,1
1654	119,4	1692	120,9	1730	118,1	1767	80,0
1655	119,6	1693	121,0	1731	115,9	1768	78,7
1656	119,9	1694	121,1	1732	113,5	1769	76,9
1657	120,1	1695	121,2	1733	111,1	1770	74,6
1658	120,3	1696	121,3	1734	108,6	1771	72,0
1659	120,4	1697	121,4	1735	106,2	1772	69,0
1660	120,5	1698	121,5	1736	104,0	1773	65,6
1661	120,5	1699	121,5	1737	101,1	1774	62,1
1662	120,5	1700	121,5	1738	98,3	1775	58,5
1663	120,5	1701	121,4	1739	95,7	1776	54,7
1664	120,4	1702	121,3	1740	93,5	1777	50,9
1665	120,3	1703	121,1	1741	91,5	1778	47,3
1666	120,1	1704	120,9	1742	90,7	1779	43,8
1667	119,9	1705	120,6	1743	90,4	1780	40,4
1668	119,6	1706	120,4	1744	90,2	1781	37,4
1669	119,5	1707	120,2	1745	90,2	1782	34,3
1670	119,4	1708	120,1	1746	90,1	1783	31,3
1671	119,3	1709	119,9	1747	90,0	1784	28,3
1672	119,3	1710	119,8	1748	89,8	1785	25,2
1673	119,4	1711	119,8	1749	89,6	1786	22,0
1674	119,5	1712	119,9	1750	89,4	1787	18,9
1675	119,5	1713	120,0	1751	89,2	1788	16,1
1676	119,6	1714	120,2	1752	88,9	1789	13,4
1677	119,6	1715	120,4	1753	88,5	1790	11,1
1678	119,6	1716	120,8	1754	88,1	1791	8,9
1679	119,4	1717	121,1	1755	87,6	1792	6,9
1680	119,3	1718	121,6	1756	87,1	1793	4,9
1681	119,0	1719	121,8	1757	86,6	1794	2,8
1682	118,8	1720	122,1	1758	86,1	1795	0,0
1683	118,7	1721	122,4	1759	85,5	1796	0,0
1684	118,8	1722	122,7	1760	85,0	1797	0,0
1685	119,0	1723	122,8	1761	84,4	1798	0,0
1686	119,2	1724	123,1	1762	83,8	1799	0,0
1687	119,6	1725	123,1			1800	0,0

▼ B

6. ► M3 WLTC Class 3 cycle ◀

Figure A1/7

▼ M3

WLTC, Class 3 cycle, phase Low₃

▼ B

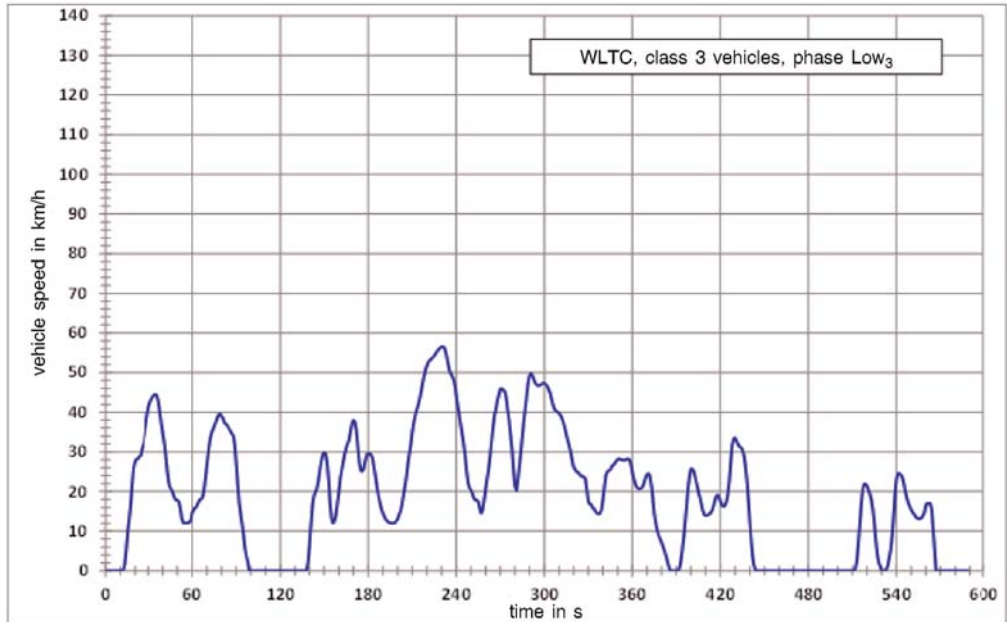
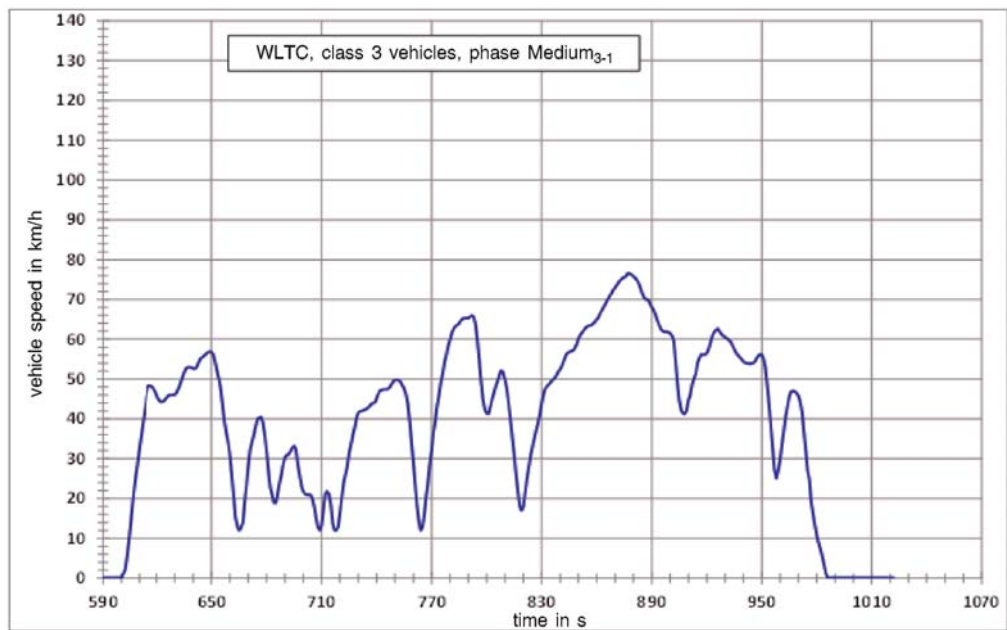

Figure A1/8

▼ M3

WLTC, Class 3a cycle, phase Medium_{3a}

▼ B



▼ B

Figure A1/9

▼ M3

WLTC, Class 3b cycle, phase Medium_{3b}

▼ B

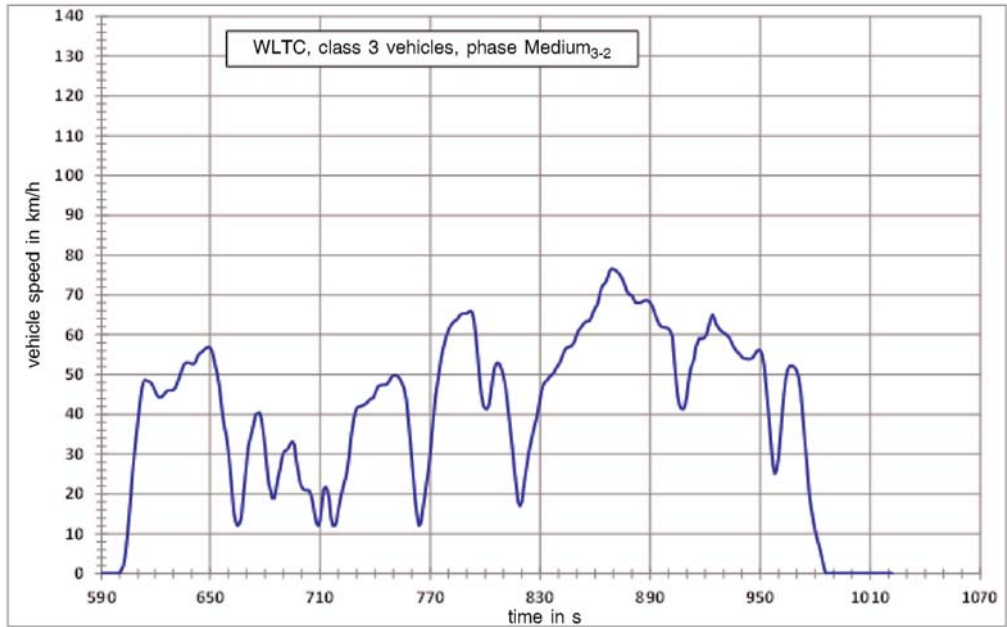
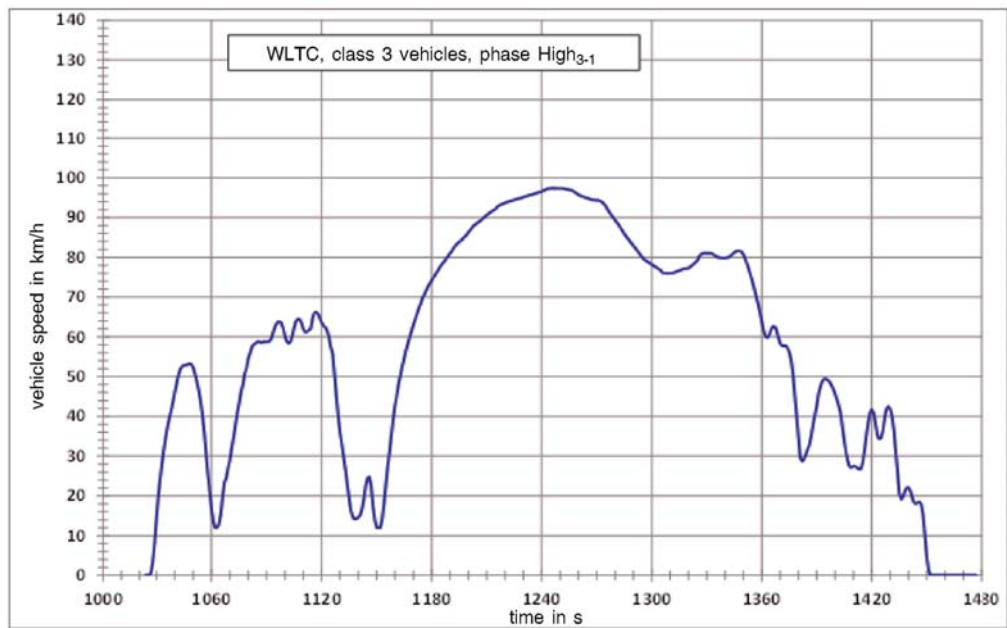

Figure A1/10

▼ M3

WLTC, Class 3a cycle, phase High_{3a}

▼ B



▼ B

Figure A1/11

▼ M3

WLTC, Class 3b cycle, phase High_{3b}

▼ B

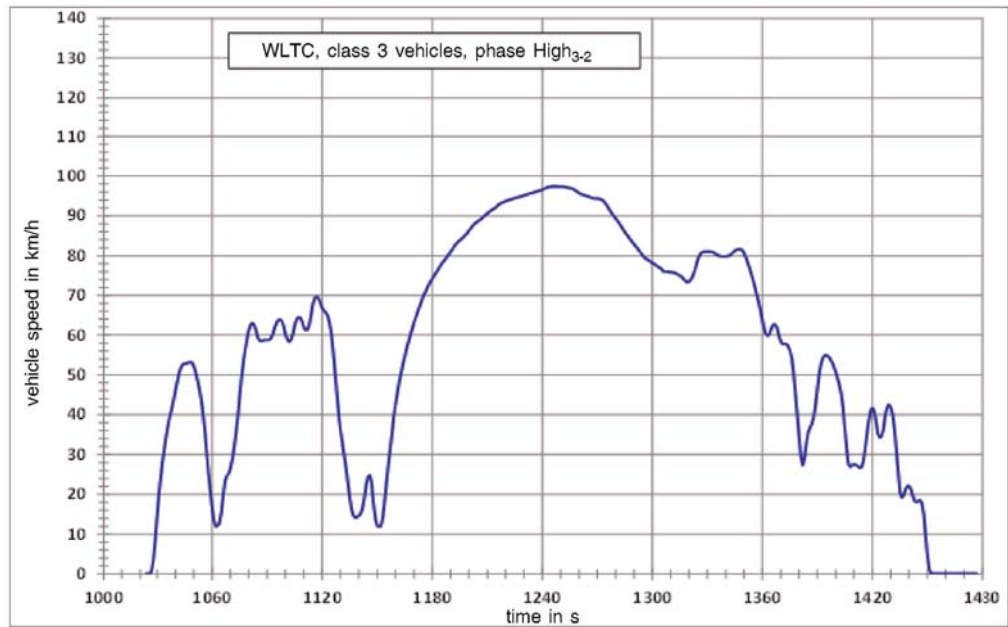
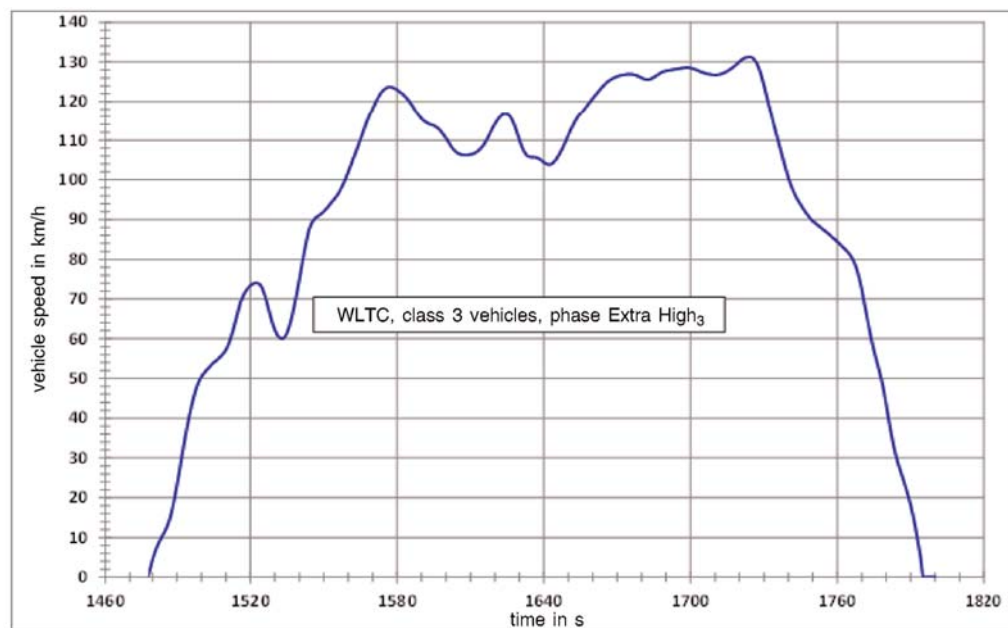

Figure A1/12

▼ M3

WLTC, Class 3 cycle, phase Extra High₃

▼ B



▼B

Table A1/7

▼M3WLTC, Class 3 cycle, phase Low₃▼B

Time in s	Speed in km/h	Time in s	Speed in km/h	Time in s	Speed in km/h	Time in s	Speed in km/h
0	0,0	36	44,2	72	32,6	108	0,0
1	0,0	37	42,7	73	34,4	109	0,0
2	0,0	38	39,9	74	35,5	110	0,0
3	0,0	39	37,0	75	36,4	111	0,0
4	0,0	40	34,6	76	37,4	112	0,0
5	0,0	41	32,3	77	38,5	113	0,0
6	0,0	42	29,0	78	39,3	114	0,0
7	0,0	43	25,1	79	39,5	115	0,0
8	0,0	44	22,2	80	39,0	116	0,0
9	0,0	45	20,9	81	38,5	117	0,0
10	0,0	46	20,4	82	37,3	118	0,0
11	0,0	47	19,5	83	37,0	119	0,0
12	0,2	48	18,4	84	36,7	120	0,0
13	1,7	49	17,8	85	35,9	121	0,0
14	5,4	50	17,8	86	35,3	122	0,0
15	9,9	51	17,4	87	34,6	123	0,0
16	13,1	52	15,7	88	34,2	124	0,0
17	16,9	53	13,1	89	31,9	125	0,0
18	21,7	54	12,1	90	27,3	126	0,0
19	26,0	55	12,0	91	22,0	127	0,0
20	27,5	56	12,0	92	17,0	128	0,0
21	28,1	57	12,0	93	14,2	129	0,0
22	28,3	58	12,3	94	12,0	130	0,0
23	28,8	59	12,6	95	9,1	131	0,0
24	29,1	60	14,7	96	5,8	132	0,0
25	30,8	61	15,3	97	3,6	133	0,0
26	31,9	62	15,9	98	2,2	134	0,0
27	34,1	63	16,2	99	0,0	135	0,0
28	36,6	64	17,1	100	0,0	136	0,0
29	39,1	65	17,8	101	0,0	137	0,0
30	41,3	66	18,1	102	0,0	138	0,2
31	42,5	67	18,4	103	0,0	139	1,9
32	43,3	68	20,3	104	0,0	140	6,1
33	43,9	69	23,2	105	0,0	141	11,7
34	44,4	70	26,5	106	0,0	142	16,4
35	44,5	71	29,8	107	0,0	143	18,9

▼B

Time in s	Speed in km/h	Time in s	Speed in km/h	Time in s	Speed in km/h	Time in s	Speed in km/h
144	19,9	181	29,5	218	49,0	255	17,4
145	20,8	182	29,2	219	50,6	256	15,7
146	22,8	183	28,3	220	51,8	257	14,5
147	25,4	184	26,1	221	52,7	258	15,4
148	27,7	185	23,6	222	53,1	259	17,9
149	29,2	186	21,0	223	53,5	260	20,6
150	29,8	187	18,9	224	53,8	261	23,2
151	29,4	188	17,1	225	54,2	262	25,7
152	27,2	189	15,7	226	54,8	263	28,7
153	22,6	190	14,5	227	55,3	264	32,5
154	17,3	191	13,7	228	55,8	265	36,1
155	13,3	192	12,9	229	56,2	266	39,0
156	12,0	193	12,5	230	56,5	267	40,8
157	12,6	194	12,2	231	56,5	268	42,9
158	14,1	195	12,0	232	56,2	269	44,4
159	17,2	196	12,0	233	54,9	270	45,9
160	20,1	197	12,0	234	52,9	271	46,0
161	23,4	198	12,0	235	51,0	272	45,6
162	25,5	199	12,5	236	49,8	273	45,3
163	27,6	200	13,0	237	49,2	274	43,7
164	29,5	201	14,0	238	48,4	275	40,8
165	31,1	202	15,0	239	46,9	276	38,0
166	32,1	203	16,5	240	44,3	277	34,4
167	33,2	204	19,0	241	41,5	278	30,9
168	35,2	205	21,2	242	39,5	279	25,5
169	37,2	206	23,8	243	37,0	280	21,4
170	38,0	207	26,9	244	34,6	281	20,2
171	37,4	208	29,6	245	32,3	282	22,9
172	35,1	209	32,0	246	29,0	283	26,6
173	31,0	210	35,2	247	25,1	284	30,2
174	27,1	211	37,5	248	22,2	285	34,1
175	25,3	212	39,2	249	20,9	286	37,4
176	25,1	213	40,5	250	20,4	287	40,7
177	25,9	214	41,6	251	19,5	288	44,0
178	27,8	215	43,1	252	18,4	289	47,3
179	29,2	216	45,0	253	17,8	290	49,2
180	29,6	217	47,1	254	17,8	291	49,8

▼B

Time in s	Speed in km/h	Time in s	Speed in km/h	Time in s	Speed in km/h	Time in s	Speed in km/h
292	49,2	329	20,5	366	20,8	403	23,3
293	48,1	330	17,5	367	21,2	404	21,6
294	47,3	331	16,9	368	22,1	405	20,2
295	46,8	332	16,7	369	23,5	406	18,7
296	46,7	333	15,9	370	24,3	407	17,0
297	46,8	334	15,6	371	24,5	408	15,3
298	47,1	335	15,0	372	23,8	409	14,2
299	47,3	336	14,5	373	21,3	410	13,9
300	47,3	337	14,3	374	17,7	411	14,0
301	47,1	338	14,5	375	14,4	412	14,2
302	46,6	339	15,4	376	11,9	413	14,5
303	45,8	340	17,8	377	10,2	414	14,9
304	44,8	341	21,1	378	8,9	415	15,9
305	43,3	342	24,1	379	8,0	416	17,4
306	41,8	343	25,0	380	7,2	417	18,7
307	40,8	344	25,3	381	6,1	418	19,1
308	40,3	345	25,5	382	4,9	419	18,8
309	40,1	346	26,4	383	3,7	420	17,6
310	39,7	347	26,6	384	2,3	421	16,6
311	39,2	348	27,1	385	0,9	422	16,2
312	38,5	349	27,7	386	0,0	423	16,4
313	37,4	350	28,1	387	0,0	424	17,2
314	36,0	351	28,2	388	0,0	425	19,1
315	34,4	352	28,1	389	0,0	426	22,6
316	33,0	353	28,0	390	0,0	427	27,4
317	31,7	354	27,9	391	0,0	428	31,6
318	30,0	355	27,9	392	0,5	429	33,4
319	28,0	356	28,1	393	2,1	430	33,5
320	26,1	357	28,2	394	4,8	431	32,8
321	25,6	358	28,0	395	8,3	432	31,9
322	24,9	359	26,9	396	12,3	433	31,3
323	24,9	360	25,0	397	16,6	434	31,1
324	24,3	361	23,2	398	20,9	435	30,6
325	23,9	362	21,9	399	24,2	436	29,2
326	23,9	363	21,1	400	25,6	437	26,7
327	23,6	364	20,7	401	25,6	438	23,0
328	23,3	365	20,7	402	24,9	439	18,2

▼B

Time in s	Speed in km/h	Time in s	Speed in km/h	Time in s	Speed in km/h	Time in s	Speed in km/h
440	12,9	479	0,0	517	20,5	555	13,1
441	7,7	480	0,0	518	21,9	556	13,1
442	3,8	481	0,0	519	21,9	557	13,3
443	1,3	482	0,0	520	21,3	558	13,8
444	0,2	483	0,0	521	20,3	559	14,5
445	0,0	484	0,0	522	19,2	560	16,5
446	0,0	485	0,0	523	17,8	561	17,0
447	0,0	486	0,0	524	15,5	562	17,0
448	0,0	487	0,0	525	11,9	563	17,0
449	0,0	488	0,0	526	7,6	564	15,4
450	0,0	489	0,0	527	4,0	565	10,1
451	0,0	490	0,0	528	2,0	566	4,8
452	0,0	491	0,0	529	1,0	567	0,0
453	0,0	492	0,0	530	0,0	568	0,0
454	0,0	493	0,0	531	0,0	569	0,0
455	0,0	494	0,0	532	0,0	570	0,0
456	0,0	495	0,0	533	0,2	571	0,0
457	0,0	496	0,0	534	1,2	572	0,0
458	0,0	497	0,0	535	3,2	573	0,0
459	0,0	498	0,0	536	5,2	574	0,0
460	0,0	499	0,0	537	8,2	575	0,0
461	0,0	500	0,0	538	13	576	0,0
462	0,0	501	0,0	539	18,8	577	0,0
463	0,0	502	0,0	540	23,1	578	0,0
464	0,0	503	0,0	541	24,5	579	0,0
465	0,0	504	0,0	542	24,5	580	0,0
466	0,0	505	0,0	543	24,3	581	0,0
467	0,0	506	0,0	544	23,6	582	0,0
468	0,0	507	0,0	545	22,3	583	0,0
469	0,0	508	0,0	546	20,1	584	0,0
470	0,0	509	0,0	547	18,5	585	0,0
471	0,0	510	0,0	548	17,2	586	0,0
472	0,0	511	0,0	549	16,3	587	0,0
473	0,0	512	0,5	550	15,4	588	0,0
474	0,0	513	2,5	551	14,7	589	0,0
475	0,0	514	6,6	552	14,3		
476	0,0	515	11,8	553	13,7		
477	0,0	516	16,8	554	13,3		
478	0,0						

▼B

Table A1/8

▼M3WLTC, Class 3a cycle, phase Medium_{3a}▼B

Time in s	Speed in km/h	Time in s	Speed in km/h	Time in s	Speed in km/h	Time in s	Speed in km/h
590	0,0	625	45,1	660	31,0	695	33,2
591	0,0	626	45,7	661	26,0	696	32,4
592	0,0	627	46,0	662	20,7	697	28,3
593	0,0	628	46,0	663	15,4	698	25,8
594	0,0	629	46,0	664	13,1	699	23,1
595	0,0	630	46,1	665	12,0	700	21,8
596	0,0	631	46,7	666	12,5	701	21,2
597	0,0	632	47,7	667	14,0	702	21,0
598	0,0	633	48,9	668	19,0	703	21,0
599	0,0	634	50,3	669	23,2	704	20,9
600	0,0	635	51,6	670	28,0	705	19,9
601	1,0	636	52,6	671	32,0	706	17,9
602	2,1	637	53,0	672	34,0	707	15,1
603	5,2	638	53,0	673	36,0	708	12,8
604	9,2	639	52,9	674	38,0	709	12,0
605	13,5	640	52,7	675	40,0	710	13,2
606	18,1	641	52,6	676	40,3	711	17,1
607	22,3	642	53,1	677	40,5	712	21,1
608	26,0	643	54,3	678	39,0	713	21,8
609	29,3	644	55,2	679	35,7	714	21,2
610	32,8	645	55,5	680	31,8	715	18,5
611	36,0	646	55,9	681	27,1	716	13,9
612	39,2	647	56,3	682	22,8	717	12,0
613	42,5	648	56,7	683	21,1	718	12,0
614	45,7	649	56,9	684	18,9	719	13,0
615	48,2	650	56,8	685	18,9	720	16,3
616	48,4	651	56,0	686	21,3	721	20,5
617	48,2	652	54,2	687	23,9	722	23,9
618	47,8	653	52,1	688	25,9	723	26,0
619	47,0	654	50,1	689	28,4	724	28,0
620	45,9	655	47,2	690	30,3	725	31,5
621	44,9	656	43,2	691	30,9	726	33,4
622	44,4	657	39,2	692	31,1	727	36,0
623	44,3	658	36,5	693	31,8	728	37,8
624	44,5	659	34,3	694	32,7	729	40,2

▼B

Time in s	Speed in km/h	Time in s	Speed in km/h	Time in s	Speed in km/h	Time in s	Speed in km/h
730	41,6	767	20,4	804	46,5	841	53,3
731	41,9	768	24,0	805	48,3	842	54,5
732	42,0	769	29,0	806	49,5	843	55,7
733	42,2	770	32,2	807	51,2	844	56,5
734	42,4	771	36,8	808	52,2	845	56,8
735	42,7	772	39,4	809	51,6	846	57,0
736	43,1	773	43,2	810	49,7	847	57,2
737	43,7	774	45,8	811	47,4	848	57,7
738	44,0	775	49,2	812	43,7	849	58,7
739	44,1	776	51,4	813	39,7	850	60,1
740	45,3	777	54,2	814	35,5	851	61,1
741	46,4	778	56,0	815	31,1	852	61,7
742	47,2	779	58,3	816	26,3	853	62,3
743	47,3	780	59,8	817	21,9	854	62,9
744	47,4	781	61,7	818	18,0	855	63,3
745	47,4	782	62,7	819	17,0	856	63,4
746	47,5	783	63,3	820	18,0	857	63,5
747	47,9	784	63,6	821	21,4	858	63,9
748	48,6	785	64,0	822	24,8	859	64,4
749	49,4	786	64,7	823	27,9	860	65,0
750	49,8	787	65,2	824	30,8	861	65,6
751	49,8	788	65,3	825	33,0	862	66,6
752	49,7	789	65,3	826	35,1	863	67,4
753	49,3	790	65,4	827	37,1	864	68,2
754	48,5	791	65,7	828	38,9	865	69,1
755	47,6	792	66,0	829	41,4	866	70,0
756	46,3	793	65,6	830	44,0	867	70,8
757	43,7	794	63,5	831	46,3	868	71,5
758	39,3	795	59,7	832	47,7	869	72,4
759	34,1	796	54,6	833	48,2	870	73,0
760	29,0	797	49,3	834	48,7	871	73,7
761	23,7	798	44,9	835	49,3	872	74,4
762	18,4	799	42,3	836	49,8	873	74,9
763	14,3	800	41,4	837	50,2	874	75,3
764	12,0	801	41,3	838	50,9	875	75,6
765	12,8	802	43,0	839	51,8	876	75,8
766	16,0	803	45,0	840	52,5	877	76,6

▼B

Time in s	Speed in km/h	Time in s	Speed in km/h	Time in s	Speed in km/h	Time in s	Speed in km/h
878	76,5	915	54,1	951	55,1	987	0,0
879	76,2	916	55,2	952	52,7	988	0,0
880	75,8	917	56,2	953	48,4	989	0,0
881	75,4	918	56,1	954	43,1	990	0,0
882	74,8	919	56,1	955	37,8	991	0,0
883	73,9	920	56,5	956	32,5	992	0,0
884	72,7	921	57,5	957	27,2	993	0,0
885	71,3	922	59,2	958	25,1	994	0,0
886	70,4	923	60,7	959	27,0	995	0,0
887	70,0	924	61,8	960	29,8	996	0,0
888	70,0	925	62,3	961	33,8	997	0,0
889	69,0	926	62,7	962	37,0	998	0,0
890	68,0	927	62,0	963	40,7	999	0,0
891	67,3	928	61,3	964	43,0	1000	0,0
892	66,2	929	60,9	965	45,6	1001	0,0
893	64,8	930	60,5	966	46,9	1002	0,0
894	63,6	931	60,2	967	47,0	1003	0,0
895	62,6	932	59,8	968	46,9	1004	0,0
896	62,1	933	59,4	969	46,5	1005	0,0
897	61,9	934	58,6	970	45,8	1006	0,0
898	61,9	935	57,5	971	44,3	1007	0,0
899	61,8	936	56,6	972	41,3	1008	0,0
900	61,5	937	56,0	973	36,5	1009	0,0
901	60,9	938	55,5	974	31,7	1010	0,0
902	59,7	939	55,0	975	27,0	1011	0,0
903	54,6	940	54,4	976	24,7	1012	0,0
904	49,3	941	54,1	977	19,3	1013	0,0
905	44,9	942	54,0	978	16,0	1014	0,0
906	42,3	943	53,9	979	13,2	1015	0,0
907	41,4	944	53,9	980	10,7	1016	0,0
908	41,3	945	54,0	981	8,8	1017	0,0
909	42,1	946	54,2	982	7,2	1018	0,0
910	44,7	947	55,0	983	5,5	1019	0,0
911	46,0	948	55,8	984	3,2	1020	0,0
912	48,8	949	56,2	985	1,1	1021	0,0
913	50,1	950	56,1	986	0,0	1022	0,0

▼B

Table A1/9

▼M3WLTC, Class 3b cycle, phase Medium_{3b}▼B

Time in s	Speed in km/h	Time in s	Speed in km/h	Time in s	Speed in km/h	Time in s	Speed in km/h
590	0,0	625	45,1	660	31,0	695	33,2
591	0,0	626	45,7	661	26,0	696	32,4
592	0,0	627	46,0	662	20,7	697	28,3
593	0,0	628	46,0	663	15,4	698	25,8
594	0,0	629	46,0	664	13,1	699	23,1
595	0,0	630	46,1	665	12,0	700	21,8
596	0,0	631	46,7	666	12,5	701	21,2
597	0,0	632	47,7	667	14,0	702	21,0
598	0,0	633	48,9	668	19,0	703	21,0
599	0,0	634	50,3	669	23,2	704	20,9
600	0,0	635	51,6	670	28,0	705	19,9
601	1,0	636	52,6	671	32,0	706	17,9
602	2,1	637	53,0	672	34,0	707	15,1
603	4,8	638	53,0	673	36,0	708	12,8
604	9,1	639	52,9	674	38,0	709	12,0
605	14,2	640	52,7	675	40,0	710	13,2
606	19,8	641	52,6	676	40,3	711	17,1
607	25,5	642	53,1	677	40,5	712	21,1
608	30,5	643	54,3	678	39,0	713	21,8
609	34,8	644	55,2	679	35,7	714	21,2
610	38,8	645	55,5	680	31,8	715	18,5
611	42,9	646	55,9	681	27,1	716	13,9
612	46,4	647	56,3	682	22,8	717	12,0
613	48,3	648	56,7	683	21,1	718	12,0
614	48,7	649	56,9	684	18,9	719	13,0
615	48,5	650	56,8	685	18,9	720	16,0
616	48,4	651	56,0	686	21,3	721	18,5
617	48,2	652	54,2	687	23,9	722	20,6
618	47,8	653	52,1	688	25,9	723	22,5
619	47,0	654	50,1	689	28,4	724	24,0
620	45,9	655	47,2	690	30,3	725	26,6
621	44,9	656	43,2	691	30,9	726	29,9
622	44,4	657	39,2	692	31,1	727	34,8
623	44,3	658	36,5	693	31,8	728	37,8
624	44,5	659	34,3	694	32,7	729	40,2

▼B

Time in s	Speed in km/h	Time in s	Speed in km/h	Time in s	Speed in km/h	Time in s	Speed in km/h
730	41,6	767	19,1	804	48,4	841	53,3
731	41,9	768	22,4	805	51,4	842	54,5
732	42,0	769	25,6	806	52,7	843	55,7
733	42,2	770	30,1	807	53,0	844	56,5
734	42,4	771	35,3	808	52,5	845	56,8
735	42,7	772	39,9	809	51,3	846	57,0
736	43,1	773	44,5	810	49,7	847	57,2
737	43,7	774	47,5	811	47,4	848	57,7
738	44,0	775	50,9	812	43,7	849	58,7
739	44,1	776	54,1	813	39,7	850	60,1
740	45,3	777	56,3	814	35,5	851	61,1
741	46,4	778	58,1	815	31,1	852	61,7
742	47,2	779	59,8	816	26,3	853	62,3
743	47,3	780	61,1	817	21,9	854	62,9
744	47,4	781	62,1	818	18,0	855	63,3
745	47,4	782	62,8	819	17,0	856	63,4
746	47,5	783	63,3	820	18,0	857	63,5
747	47,9	784	63,6	821	21,4	858	64,5
748	48,6	785	64,0	822	24,8	859	65,8
749	49,4	786	64,7	823	27,9	860	66,8
750	49,8	787	65,2	824	30,8	861	67,4
751	49,8	788	65,3	825	33,0	862	68,8
752	49,7	789	65,3	826	35,1	863	71,1
753	49,3	790	65,4	827	37,1	864	72,3
754	48,5	791	65,7	828	38,9	865	72,8
755	47,6	792	66,0	829	41,4	866	73,4
756	46,3	793	65,6	830	44,0	867	74,6
757	43,7	794	63,5	831	46,3	868	76,0
758	39,3	795	59,7	832	47,7	869	76,6
759	34,1	796	54,6	833	48,2	870	76,5
760	29,0	797	49,3	834	48,7	871	76,2
761	23,7	798	44,9	835	49,3	872	75,8
762	18,4	799	42,3	836	49,8	873	75,4
763	14,3	800	41,4	837	50,2	874	74,8
764	12,0	801	41,3	838	50,9	875	73,9
765	12,8	802	42,1	839	51,8	876	72,7
766	16,0	803	44,7	840	52,5	877	71,3

▼B

Time in s	Speed in km/h	Time in s	Speed in km/h	Time in s	Speed in km/h	Time in s	Speed in km/h
878	70,4	915	57,0	951	55,1	987	0,0
879	70,0	916	58,1	952	52,7	988	0,0
880	70,0	917	59,2	953	48,4	989	0,0
881	69,0	918	59,0	954	43,1	990	0,0
882	68,0	919	59,1	955	37,8	991	0,0
883	68,0	920	59,5	956	32,5	992	0,0
884	68,0	921	60,5	957	27,2	993	0,0
885	68,1	922	62,3	958	25,1	994	0,0
886	68,4	923	63,9	959	26,0	995	0,0
887	68,6	924	65,1	960	29,3	996	0,0
888	68,7	925	64,1	961	34,6	997	0,0
889	68,5	926	62,7	962	40,4	998	0,0
890	68,1	927	62,0	963	45,3	999	0,0
891	67,3	928	61,3	964	49,0	1000	0,0
892	66,2	929	60,9	965	51,1	1001	0,0
893	64,8	930	60,5	966	52,1	1002	0,0
894	63,6	931	60,2	967	52,2	1003	0,0
895	62,6	932	59,8	968	52,1	1004	0,0
896	62,1	933	59,4	969	51,7	1005	0,0
897	61,9	934	58,6	970	50,9	1006	0,0
898	61,9	935	57,5	971	49,2	1007	0,0
899	61,8	936	56,6	972	45,9	1008	0,0
900	61,5	937	56,0	973	40,6	1009	0,0
901	60,9	938	55,5	974	35,3	1010	0,0
902	59,7	939	55,0	975	30,0	1011	0,0
903	54,6	940	54,4	976	24,7	1012	0,0
904	49,3	941	54,1	977	19,3	1013	0,0
905	44,9	942	54,0	978	16,0	1014	0,0
906	42,3	943	53,9	979	13,2	1015	0,0
907	41,4	944	53,9	980	10,7	1016	0,0
908	41,3	945	54,0	981	8,8	1017	0,0
909	42,1	946	54,2	982	7,2	1018	0,0
910	44,7	947	55,0	983	5,5	1019	0,0
911	48,4	948	55,8	984	3,2	1020	0,0
912	51,4	949	56,2	985	1,1	1021	0,0
913	52,7	950	56,1	986	0,0	1022	0,0

▼B

Table A1/10

▼M3WLTC, Class 3a cycle, phase High_{3a}▼B

Time in s	Speed in km/h	Time in s	Speed in km/h	Time in s	Speed in km/h	Time in s	Speed in km/h
1023	0,0	1058	25,4	1093	60,1	1128	45,2
1024	0,0	1059	21,0	1094	61,7	1129	40,1
1025	0,0	1060	16,7	1095	63,0	1130	36,2
1026	0,0	1061	13,4	1096	63,7	1131	32,9
1027	0,8	1062	12,0	1097	63,9	1132	29,8
1028	3,6	1063	12,1	1098	63,5	1133	26,6
1029	8,6	1064	12,8	1099	62,3	1134	23,0
1030	14,6	1065	15,6	1100	60,3	1135	19,4
1031	20,0	1066	19,9	1101	58,9	1136	16,3
1032	24,4	1067	23,4	1102	58,4	1137	14,6
1033	28,2	1068	24,6	1103	58,8	1138	14,2
1034	31,7	1069	27,0	1104	60,2	1139	14,3
1035	35,0	1070	29,0	1105	62,3	1140	14,6
1036	37,6	1071	32,0	1106	63,9	1141	15,1
1037	39,7	1072	34,8	1107	64,5	1142	16,4
1038	41,5	1073	37,7	1108	64,4	1143	19,1
1039	43,6	1074	40,8	1109	63,5	1144	22,5
1040	46,0	1075	43,2	1110	62,0	1145	24,4
1041	48,4	1076	46,0	1111	61,2	1146	24,8
1042	50,5	1077	48,0	1112	61,3	1147	22,7
1043	51,9	1078	50,7	1113	61,7	1148	17,4
1044	52,6	1079	52,0	1114	62,0	1149	13,8
1045	52,8	1080	54,5	1115	64,6	1150	12,0
1046	52,9	1081	55,9	1116	66,0	1151	12,0
1047	53,1	1082	57,4	1117	66,2	1152	12,0
1048	53,3	1083	58,1	1118	65,8	1153	13,9
1049	53,1	1084	58,4	1119	64,7	1154	17,7
1050	52,3	1085	58,8	1120	63,6	1155	22,8
1051	50,7	1086	58,8	1121	62,9	1156	27,3
1052	48,8	1087	58,6	1122	62,4	1157	31,2
1053	46,5	1088	58,7	1123	61,7	1158	35,2
1054	43,8	1089	58,8	1124	60,1	1159	39,4
1055	40,3	1090	58,8	1125	57,3	1160	42,5
1056	36,0	1091	58,8	1126	55,8	1161	45,4
1057	30,7	1092	59,1	1127	50,5	1162	48,2

▼B

Time in s	Speed in km/h	Time in s	Speed in km/h	Time in s	Speed in km/h	Time in s	Speed in km/h
1163	50,3	1200	86,3	1237	96,1	1274	93,4
1164	52,6	1201	86,8	1238	96,3	1275	92,8
1165	54,5	1202	87,4	1239	96,4	1276	92,0
1166	56,6	1203	88,0	1240	96,6	1277	91,3
1167	58,3	1204	88,3	1241	96,8	1278	90,6
1168	60,0	1205	88,7	1242	97,0	1279	90,0
1169	61,5	1206	89,0	1243	97,2	1280	89,3
1170	63,1	1207	89,3	1244	97,3	1281	88,7
1171	64,3	1208	89,8	1245	97,4	1282	88,1
1172	65,7	1209	90,2	1246	97,4	1283	87,4
1173	67,1	1210	90,6	1247	97,4	1284	86,7
1174	68,3	1211	91,0	1248	97,4	1285	86,0
1175	69,7	1212	91,3	1249	97,3	1286	85,3
1176	70,6	1213	91,6	1250	97,3	1287	84,7
1177	71,6	1214	91,9	1251	97,3	1288	84,1
1178	72,6	1215	92,2	1252	97,3	1289	83,5
1179	73,5	1216	92,8	1253	97,2	1290	82,9
1180	74,2	1217	93,1	1254	97,1	1291	82,3
1181	74,9	1218	93,3	1255	97,0	1292	81,7
1182	75,6	1219	93,5	1256	96,9	1293	81,1
1183	76,3	1220	93,7	1257	96,7	1294	80,5
1184	77,1	1221	93,9	1258	96,4	1295	79,9
1185	77,9	1222	94,0	1259	96,1	1296	79,4
1186	78,5	1223	94,1	1260	95,7	1297	79,1
1187	79,0	1224	94,3	1261	95,5	1298	78,8
1188	79,7	1225	94,4	1262	95,3	1299	78,5
1189	80,3	1226	94,6	1263	95,2	1300	78,2
1190	81,0	1227	94,7	1264	95,0	1301	77,9
1191	81,6	1228	94,8	1265	94,9	1302	77,6
1192	82,4	1229	95,0	1266	94,7	1303	77,3
1193	82,9	1230	95,1	1267	94,5	1304	77,0
1194	83,4	1231	95,3	1268	94,4	1305	76,7
1195	83,8	1232	95,4	1269	94,4	1306	76,0
1196	84,2	1233	95,6	1270	94,3	1307	76,0
1197	84,7	1234	95,7	1271	94,3	1308	76,0
1198	85,2	1235	95,8	1272	94,1	1309	75,9
1199	85,6	1236	96,0	1273	93,9	1310	76,0

▼B

Time in s	Speed in km/h	Time in s	Speed in km/h	Time in s	Speed in km/h	Time in s	Speed in km/h
1311	76,0	1348	81,6	1385	31,7	1422	38,3
1312	76,1	1349	81,4	1386	32,9	1423	35,3
1313	76,3	1350	80,7	1387	35,0	1424	34,3
1314	76,5	1351	79,6	1388	38,0	1425	34,6
1315	76,6	1352	78,2	1389	40,5	1426	36,3
1316	76,8	1353	76,8	1390	42,7	1427	39,5
1317	77,1	1354	75,3	1391	45,8	1428	41,8
1318	77,1	1355	73,8	1392	47,5	1429	42,5
1319	77,2	1356	72,1	1393	48,9	1430	41,9
1320	77,2	1357	70,2	1394	49,4	1431	40,1
1321	77,6	1358	68,2	1395	49,4	1432	36,6
1322	78,0	1359	66,1	1396	49,2	1433	31,3
1323	78,4	1360	63,8	1397	48,7	1434	26,0
1324	78,8	1361	61,6	1398	47,9	1435	20,6
1325	79,2	1362	60,2	1399	46,9	1436	19,1
1326	80,3	1363	59,8	1400	45,6	1437	19,7
1327	80,8	1364	60,4	1401	44,2	1438	21,1
1328	81,0	1365	61,8	1402	42,7	1439	22,0
1329	81,0	1366	62,6	1403	40,7	1440	22,1
1330	81,0	1367	62,7	1404	37,1	1441	21,4
1331	81,0	1368	61,9	1405	33,9	1442	19,6
1332	81,0	1369	60,0	1406	30,6	1443	18,3
1333	80,9	1370	58,4	1407	28,6	1444	18,0
1334	80,6	1371	57,8	1408	27,3	1445	18,3
1335	80,3	1372	57,8	1409	27,2	1446	18,5
1336	80,0	1373	57,8	1410	27,5	1447	17,9
1337	79,9	1374	57,3	1411	27,4	1448	15,0
1338	79,8	1375	56,2	1412	27,1	1449	9,9
1339	79,8	1376	54,3	1413	26,7	1450	4,6
1340	79,8	1377	50,8	1414	26,8	1451	1,2
1341	79,9	1378	45,5	1415	28,2	1452	0,0
1342	80,0	1379	40,2	1416	31,1	1453	0,0
1343	80,4	1380	34,9	1417	34,8	1454	0,0
1344	80,8	1381	29,6	1418	38,4	1455	0,0
1345	81,2	1382	28,7	1419	40,9	1456	0,0
1346	81,5	1383	29,3	1420	41,7	1457	0,0
1347	81,6	1384	30,5	1421	40,9	1458	0,0

▼ **B**

Time in s	Speed in km/h	Time in s	Speed in km/h	Time in s	Speed in km/h	Time in s	Speed in km/h
1459	0,0	1464	0,0	1469	0,0	1474	0,0
1460	0,0	1465	0,0	1470	0,0	1475	0,0
1461	0,0	1466	0,0	1471	0,0	1476	0,0
1462	0,0	1467	0,0	1472	0,0	1477	0,0
1463	0,0	1468	0,0	1473	0,0		

Table A1/11

▼ **M3****WLTC, Class 3b cycle, phase High_{3b}**▼ **B**

Time in s	Speed in km/h	Time in s	Speed in km/h	Time in s	Speed in km/h	Time in s	Speed in km/h
1023	0,0	1051	50,7	1079	58,9	1107	64,5
1024	0,0	1052	48,8	1080	61,2	1108	64,4
1025	0,0	1053	46,5	1081	62,6	1109	63,5
1026	0,0	1054	43,8	1082	63,0	1110	62,0
1027	0,8	1055	40,3	1083	62,5	1111	61,2
1028	3,6	1056	36,0	1084	60,9	1112	61,3
1029	8,6	1057	30,7	1085	59,3	1113	62,6
1030	14,6	1058	25,4	1086	58,6	1114	65,3
1031	20,0	1059	21,0	1087	58,6	1115	68,0
1032	24,4	1060	16,7	1088	58,7	1116	69,4
1033	28,2	1061	13,4	1089	58,8	1117	69,7
1034	31,7	1062	12,0	1090	58,8	1118	69,3
1035	35,0	1063	12,1	1091	58,8	1119	68,1
1036	37,6	1064	12,8	1092	59,1	1120	66,9
1037	39,7	1065	15,6	1093	60,1	1121	66,2
1038	41,5	1066	19,9	1094	61,7	1122	65,7
1039	43,6	1067	23,4	1095	63,0	1123	64,9
1040	46,0	1068	24,6	1096	63,7	1124	63,2
1041	48,4	1069	25,2	1097	63,9	1125	60,3
1042	50,5	1070	26,4	1098	63,5	1126	55,8
1043	51,9	1071	28,8	1099	62,3	1127	50,5
1044	52,6	1072	31,8	1100	60,3	1128	45,2
1045	52,8	1073	35,3	1101	58,9	1129	40,1
1046	52,9	1074	39,5	1102	58,4	1130	36,2
1047	53,1	1075	44,5	1103	58,8	1131	32,9
1048	53,3	1076	49,3	1104	60,2	1132	29,8
1049	53,1	1077	53,3	1105	62,3	1133	26,6
1050	52,3	1078	56,4	1106	63,9	1134	23,0

▼B

Time in s	Speed in km/h	Time in s	Speed in km/h	Time in s	Speed in km/h	Time in s	Speed in km/h
1135	19,4	1172	65,7	1209	90,2	1246	97,4
1136	16,3	1173	67,1	1210	90,6	1247	97,4
1137	14,6	1174	68,3	1211	91,0	1248	97,4
1138	14,2	1175	69,7	1212	91,3	1249	97,3
1139	14,3	1176	70,6	1213	91,6	1250	97,3
1140	14,6	1177	71,6	1214	91,9	1251	97,3
1141	15,1	1178	72,6	1215	92,2	1252	97,3
1142	16,4	1179	73,5	1216	92,8	1253	97,2
1143	19,1	1180	74,2	1217	93,1	1254	97,1
1144	22,5	1181	74,9	1218	93,3	1255	97,0
1145	24,4	1182	75,6	1219	93,5	1256	96,9
1146	24,8	1183	76,3	1220	93,7	1257	96,7
1147	22,7	1184	77,1	1221	93,9	1258	96,4
1148	17,4	1185	77,9	1222	94,0	1259	96,1
1149	13,8	1186	78,5	1223	94,1	1260	95,7
1150	12,0	1187	79,0	1224	94,3	1261	95,5
1151	12,0	1188	79,7	1225	94,4	1262	95,3
1152	12,0	1189	80,3	1226	94,6	1263	95,2
1153	13,9	1190	81,0	1227	94,7	1264	95,0
1154	17,7	1191	81,6	1228	94,8	1265	94,9
1155	22,8	1192	82,4	1229	95,0	1266	94,7
1156	27,3	1193	82,9	1230	95,1	1267	94,5
1157	31,2	1194	83,4	1231	95,3	1268	94,4
1158	35,2	1195	83,8	1232	95,4	1269	94,4
1159	39,4	1196	84,2	1233	95,6	1270	94,3
1160	42,5	1197	84,7	1234	95,7	1271	94,3
1161	45,4	1198	85,2	1235	95,8	1272	94,1
1162	48,2	1199	85,6	1236	96,0	1273	93,9
1163	50,3	1200	86,3	1237	96,1	1274	93,4
1164	52,6	1201	86,8	1238	96,3	1275	92,8
1165	54,5	1202	87,4	1239	96,4	1276	92,0
1166	56,6	1203	88,0	1240	96,6	1277	91,3
1167	58,3	1204	88,3	1241	96,8	1278	90,6
1168	60,0	1205	88,7	1242	97,0	1279	90,0
1169	61,5	1206	89,0	1243	97,2	1280	89,3
1170	63,1	1207	89,3	1244	97,3	1281	88,7
1171	64,3	1208	89,8	1245	97,4	1282	88,1

▼B

Time in s	Speed in km/h	Time in s	Speed in km/h	Time in s	Speed in km/h	Time in s	Speed in km/h
1283	87,4	1320	73,5	1357	70,2	1394	54,9
1284	86,7	1321	74,0	1358	68,2	1395	54,9
1285	86,0	1322	74,9	1359	66,1	1396	54,7
1286	85,3	1323	76,1	1360	63,8	1397	54,1
1287	84,7	1324	77,7	1361	61,6	1398	53,2
1288	84,1	1325	79,2	1362	60,2	1399	52,1
1289	83,5	1326	80,3	1363	59,8	1400	50,7
1290	82,9	1327	80,8	1364	60,4	1401	49,1
1291	82,3	1328	81,0	1365	61,8	1402	47,4
1292	81,7	1329	81,0	1366	62,6	1403	45,2
1293	81,1	1330	81,0	1367	62,7	1404	41,8
1294	80,5	1331	81,0	1368	61,9	1405	36,5
1295	79,9	1332	81,0	1369	60,0	1406	31,2
1296	79,4	1333	80,9	1370	58,4	1407	27,6
1297	79,1	1334	80,6	1371	57,8	1408	26,9
1298	78,8	1335	80,3	1372	57,8	1409	27,3
1299	78,5	1336	80,0	1373	57,8	1410	27,5
1300	78,2	1337	79,9	1374	57,3	1411	27,4
1301	77,9	1338	79,8	1375	56,2	1412	27,1
1302	77,6	1339	79,8	1376	54,3	1413	26,7
1303	77,3	1340	79,8	1377	50,8	1414	26,8
1304	77,0	1341	79,9	1378	45,5	1415	28,2
1305	76,7	1342	80,0	1379	40,2	1416	31,1
1306	76,0	1343	80,4	1380	34,9	1417	34,8
1307	76,0	1344	80,8	1381	29,6	1418	38,4
1308	76,0	1345	81,2	1382	27,3	1419	40,9
1309	75,9	1346	81,5	1383	29,3	1420	41,7
1310	75,9	1347	81,6	1384	32,9	1421	40,9
1311	75,8	1348	81,6	1385	35,6	1422	38,3
1312	75,7	1349	81,4	1386	36,7	1423	35,3
1313	75,5	1350	80,7	1387	37,6	1424	34,3
1314	75,2	1351	79,6	1388	39,4	1425	34,6
1315	75,0	1352	78,2	1389	42,5	1426	36,3
1316	74,7	1353	76,8	1390	46,5	1427	39,5
1317	74,1	1354	75,3	1391	50,2	1428	41,8
1318	73,7	1355	73,8	1392	52,8	1429	42,5
1319	73,3	1356	72,1	1393	54,3	1430	41,9

▼B

Time in s	Speed in km/h	Time in s	Speed in km/h	Time in s	Speed in km/h	Time in s	Speed in km/h
1431	40,1	1443	18,3	1454	0,0	1466	0,0
1432	36,6	1444	18,0	1455	0,0	1467	0,0
1433	31,3	1445	18,3	1456	0,0	1468	0,0
1434	26,0	1446	18,5	1457	0,0	1469	0,0
1435	20,6	1447	17,9	1458	0,0	1470	0,0
1436	19,1	1448	15,0	1459	0,0	1471	0,0
1437	19,7	1449	9,9	1460	0,0	1472	0,0
1438	21,1	1450	4,6	1461	0,0	1473	0,0
1439	22,0	1451	1,2	1462	0,0	1474	0,0
1440	22,1	1452	0,0	1463	0,0	1475	0,0
1441	21,4	1453	0,0	1464	0,0	1476	0,0
1442	19,6			1465	0,0	1477	0,0

Table A1/12

▼M3**WLTC, Class 3 cycle, phase Extra High₃****▼B**

Time in s	Speed in km/h	Time in s	Speed in km/h	Time in s	Speed in km/h	Time in s	Speed in km/h
1478	0,0	1499	49,3	1520	73,4	1541	78,4
1479	2,2	1500	50,5	1521	73,8	1542	81,8
1480	4,4	1501	51,3	1522	74,1	1543	84,9
1481	6,3	1502	52,1	1523	74,0	1544	87,4
1482	7,9	1503	52,7	1524	73,6	1545	89,0
1483	9,2	1504	53,4	1525	72,5	1546	90,0
1484	10,4	1505	54,0	1526	70,8	1547	90,6
1485	11,5	1506	54,5	1527	68,6	1548	91,0
1486	12,9	1507	55,0	1528	66,2	1549	91,5
1487	14,7	1508	55,6	1529	64,0	1550	92,0
1488	17,0	1509	56,3	1530	62,2	1551	92,7
1489	19,8	1510	57,2	1531	60,9	1552	93,4
1490	23,1	1511	58,5	1532	60,2	1553	94,2
1491	26,7	1512	60,2	1533	60,0	1554	94,9
1492	30,5	1513	62,3	1534	60,4	1555	95,7
1493	34,1	1514	64,7	1535	61,4	1556	96,6
1494	37,5	1515	67,1	1536	63,2	1557	97,7
1495	40,6	1516	69,2	1537	65,6	1558	98,9
1496	43,3	1517	70,7	1538	68,4	1559	100,4
1497	45,7	1518	71,9	1539	71,6	1560	102,0
1498	47,7	1519	72,7	1540	74,9	1561	103,6

▼B

Time in s	Speed in km/h	Time in s	Speed in km/h	Time in s	Speed in km/h	Time in s	Speed in km/h
1562	105,2	1599	111,4	1636	105,7	1673	126,8
1563	106,8	1600	110,5	1637	105,6	1674	126,9
1564	108,5	1601	109,5	1638	105,3	1675	126,9
1565	110,2	1602	108,5	1639	104,9	1676	126,9
1566	111,9	1603	107,7	1640	104,4	1677	126,8
1567	113,7	1604	107,1	1641	104,0	1678	126,6
1568	115,3	1605	106,6	1642	103,8	1679	126,3
1569	116,8	1606	106,4	1643	103,9	1680	126,0
1570	118,2	1607	106,2	1644	104,4	1681	125,7
1571	119,5	1608	106,2	1645	105,1	1682	125,6
1572	120,7	1609	106,2	1646	106,1	1683	125,6
1573	121,8	1610	106,4	1647	107,2	1684	125,8
1574	122,6	1611	106,5	1648	108,5	1685	126,2
1575	123,2	1612	106,8	1649	109,9	1686	126,6
1576	123,6	1613	107,2	1650	111,3	1687	127,0
1577	123,7	1614	107,8	1651	112,7	1688	127,4
1578	123,6	1615	108,5	1652	113,9	1689	127,6
1579	123,3	1616	109,4	1653	115,0	1690	127,8
1580	123,0	1617	110,5	1654	116,0	1691	127,9
1581	122,5	1618	111,7	1655	116,8	1692	128,0
1582	122,1	1619	113,0	1656	117,6	1693	128,1
1583	121,5	1620	114,1	1657	118,4	1694	128,2
1584	120,8	1621	115,1	1658	119,2	1695	128,3
1585	120,0	1622	115,9	1659	120,0	1696	128,4
1586	119,1	1623	116,5	1660	120,8	1697	128,5
1587	118,1	1624	116,7	1661	121,6	1698	128,6
1588	117,1	1625	116,6	1662	122,3	1699	128,6
1589	116,2	1626	116,2	1663	123,1	1700	128,5
1590	115,5	1627	115,2	1664	123,8	1701	128,3
1591	114,9	1628	113,8	1665	124,4	1702	128,1
1592	114,5	1629	112,0	1666	125,0	1703	127,9
1593	114,1	1630	110,1	1667	125,4	1704	127,6
1594	113,9	1631	108,3	1668	125,8	1705	127,4
1595	113,7	1632	107,0	1669	126,1	1706	127,2
1596	113,3	1633	106,1	1670	126,4	1707	127,0
1597	112,9	1634	105,8	1671	126,6	1708	126,9
1598	112,2	1635	105,7	1672	126,7	1709	126,8

▼B

Time in s	Speed in km/h	Time in s	Speed in km/h	Time in s	Speed in km/h	Time in s	Speed in km/h
1710	126,7	1733	116,5	1755	87,1	1778	49,7
1711	126,8	1734	114,1	1756	86,6	1779	46,8
1712	126,9	1735	111,8	1757	86,1	1780	43,5
1713	127,1	1736	109,5	1758	85,5	1781	39,9
1714	127,4	1737	107,1	1759	85,0	1782	36,4
1715	127,7	1738	104,8	1760	84,4	1783	33,2
1716	128,1	1739	102,5	1761	83,8	1784	30,5
1717	128,5	1740	100,4	1762	83,2	1785	28,3
1718	129,0	1741	98,6	1763	82,6	1786	26,3
1719	129,5	1742	97,2	1764	82,0	1787	24,4
1720	130,1	1743	95,9	1765	81,3	1788	22,5
1721	130,6	1744	94,8	1766	80,4	1789	20,5
1722	131,0	1745	93,8	1767	79,1	1790	18,2
1723	131,2	1746	92,8	1768	77,4	1791	15,5
1724	131,3	1747	91,8	1769	75,1	1792	12,3
1725	131,2	1748	91,0	1770	72,3	1793	8,7
1726	130,7	1749	90,2	1771	69,1	1794	5,2
1727	129,8	1750	89,6	1772	65,9	1795	0,0
1728	128,4	1751	89,1	1773	62,7	1796	0,0
1729	126,5	1752	88,6	1774	59,7	1797	0,0
1730	124,1	1753	88,1	1775	57,0	1798	0,0
1731	121,6	1754	87,6	1776	54,6	1799	0,0
1732	119,0			1777	52,2	1800	0,0

7. Cycle identification

In order to confirm if the correct cycle version was chosen or if the correct cycle was implemented into the test bench operation system, checksums of the vehicle speed values for cycle phases and the whole cycle are listed in Table A1/13.

▼M3

Table A1/13

1 Hz checksums

Cycle class	Cycle phase	Checksum of 1 Hz target vehicle speeds
Class 1	Low	11 988,4
	Medium	17 162,8
	Low	11 988,4
	Total	41 139,6

▼M3

Cycle class	Cycle phase	Checksum of 1 Hz target vehicle speeds
Class 2	Low	11 162,2
	Medium	17 054,3
	High	24 450,6
	Extra High	28 869,8
	Total	81 536,9
Class 3a	Low	11 140,3
	Medium	16 995,7
	High	25 646,0
	Extra High	29 714,9
	Total	83 496,9
Class 3b	Low	11 140,3
	Medium	17 121,2
	High	25 782,2
	Extra High	29 714,9
	Total	83 758,6

▼B

8. Cycle modification

Paragraph 8. of this Sub-Annex shall not apply to OVC-HEVs, NOVC-HEVs and NOVC-FCHVs.

8.1. General remarks

▼M3

▼B

Driveability problems may occur for vehicles with power to mass ratios close to the borderlines between Class 1 and Class 2, Class 2 and Class 3 vehicles, or very low powered vehicles in Class 1.

Since these problems are related mainly to cycle phases with a combination of high vehicle speed and high accelerations rather than to the maximum speed of the cycle, the downscaling procedure shall be applied to improve driveability.

8.2. This paragraph describes the method to modify the cycle profile using the downscaling procedure.

8.2.1. Downscaling procedure for Class 1 vehicles

Figure A1/14 shows a downscaled medium speed phase of the Class 1 WLTC as an example.



Figure A1/14

Downscaled medium speed phase of the class 1 WLTC

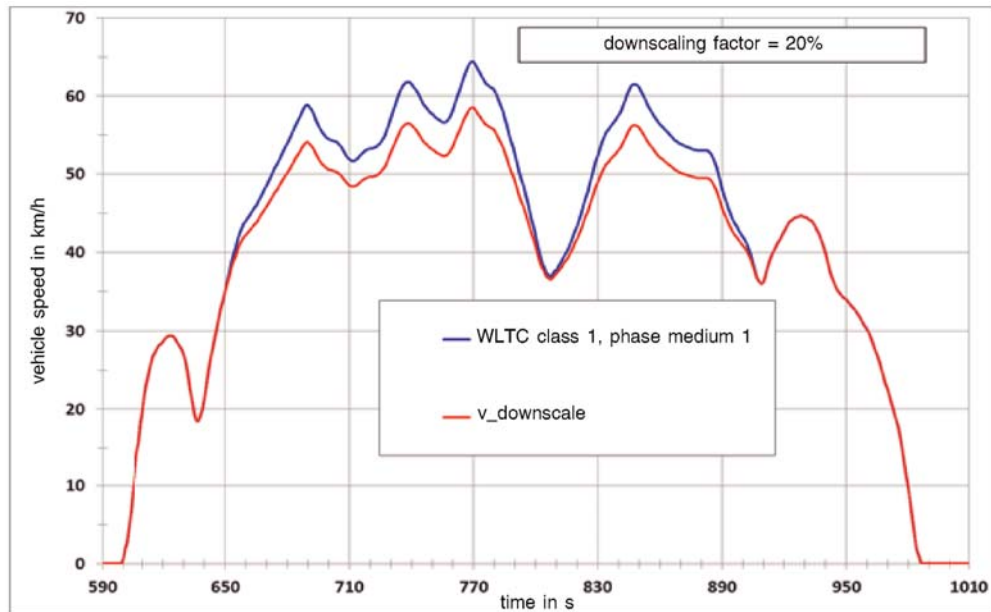

For the Class 1 cycle, the downscaling period is the time period between second 651 and second 906. Within this time period, the acceleration for the original cycle shall be calculated using the following equation:

$$a_{\text{orig}_i} = \frac{v_{i+1} - v_i}{3,6}$$

where:

v_i is the vehicle speed, km/h;

i is the time between second 651 and second 906.

The downscaling shall be applied first in the time period between second 651 and second 848. The downscaled speed trace shall be subsequently calculated using the following equation:

$$v_{\text{dsc}_{i+1}} = v_{\text{dsc}_i} + a_{\text{orig}_i} \times (1 - f_{\text{dsc}}) \times 3,6$$

with $i = 651$ to 847 .

For $i = 651$, $v_{\text{dsc}_i} = v_{\text{orig}_i}$

In order to meet the original vehicle speed at second 907, a correction factor for the deceleration shall be calculated using the following equation:

$$f_{\text{corr_dec}} = \frac{v_{\text{dsc_848}} - 36,7}{v_{\text{orig_848}} - 36,7}$$

where 36,7 km/h is the original vehicle speed at second 907.

▼B

The downscaled vehicle speed between second 849 and second 906 shall be subsequently calculated using the following equation:

$$v_{dsc_i} = v_{dsc_{i-1}} + a_{orig_{i-1}} \times f_{corr_dec} \times 3,6$$

for $i = 849$ to 906 .

▼M3

8.2.2. Downscaling procedure for Class 2 vehicles

Since the driveability problems are exclusively related to the extra high speed phases of the Class 2 and Class 3 cycles, the downscaling is related to those time periods of the extra high speed phases where driveability problems are expected to occur (see Figures A1/15 and A1/16).

▼B

Figure A1/15

Downscaled extra high speed phase of the class 2 WLTC

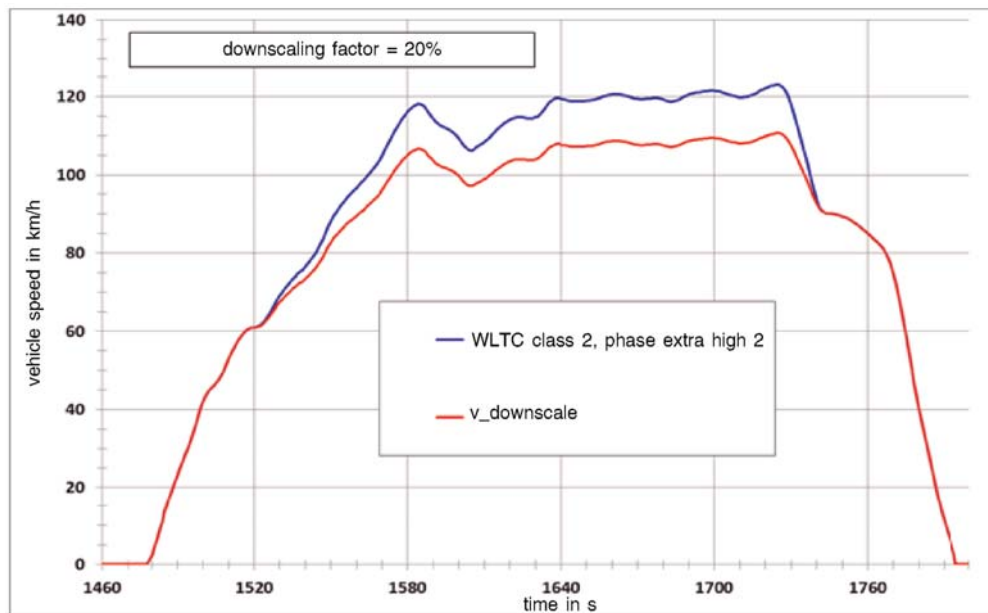

For the Class 2 cycle, the downscaling period is the time period between second 1520 and second 1742. Within this time period, the acceleration for the original cycle shall be calculated using the following equation:

$$a_{orig_i} = \frac{v_{i+1} - v_i}{3,6}$$

where:

v_i is the vehicle speed, km/h;

i is the time between second 1520 and second 1742.

The downscaling shall be applied first to the time period between second 1520 and second 1725. Second 1725 is the time when the maximum speed of the extra high speed phase is reached. The downscaled speed trace shall be subsequently calculated using the following equation:

$$v_{dsc_{i+1}} = v_{dsc_i} + a_{orig_i} \times (1 - f_{dsc}) \times 3,6$$

▼ B

for $i = 1520$ to 1724 .

For $i = 1520$, $v_{dsc_i} = v_{orig_i}$

In order to meet the original vehicle speed at second 1743, a correction factor for the deceleration shall be calculated using the following equation:

$$f_{corr_dec} = \frac{v_{dsc_1725} - 90,4}{v_{orig_1725} - 90,4}$$

90,4 km/h is the original vehicle speed at second 1743.

The downscaled vehicle speed between second 1726 and second 1742 shall be calculated using the following equation:

$$v_{dsc_i} = v_{dsc_{i-1}} + a_{orig_{i-1}} \times f_{corr_dec} \times 3,6$$

for $i = 1726$ to 1742 .

8.2.3. Downscaling procedure for Class 3 vehicles

▼ M3

Figure A1/16 shows an example for a downscaled extra high speed phase of the Class 3 WLTC.

▼ B

Figure A1/16

Downscaled extra high speed phase of the class 3 WLTC

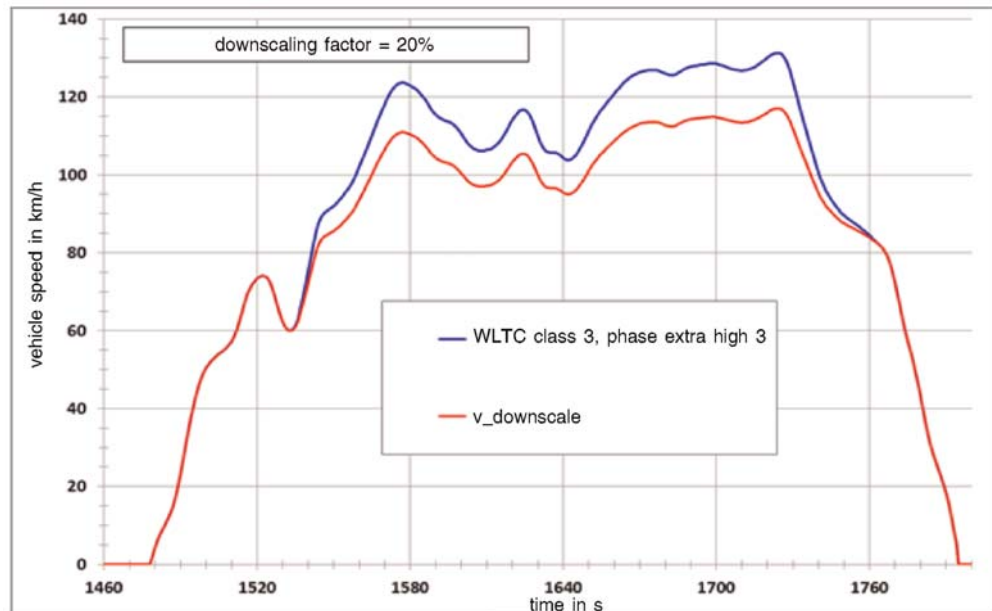

For the Class 3 cycle, the downscaling period is the time period between second 1533 and second 1762. Within this time period, the acceleration for the original cycle shall be calculated using the following equation:

$$a_{orig_i} = \frac{v_{i+1} - v_i}{3,6}$$

▼ B

where:

v_i is the vehicle speed, km/h;

i is the time between second 1533 and second 1762.

The downscaling shall be applied first in the time period between second 1533 and second 1724. Second 1724 is the time when the maximum speed of the extra high speed phase is reached. The down-scaled speed trace shall be subsequently calculated using the following equation:

$$v_{dsc_{i+1}} = v_{dsc_i} + a_{orig_i} \times (1 - f_{dsc}) \times 3,6$$

for $i = 1533$ to 1723 .

For $i = 1533$, $v_{dsc_i} = v_{orig_i}$

In order to meet the original vehicle speed at second 1763, a correction factor for the deceleration shall be calculated using the following equation:

$$f_{corr_dec} = \frac{v_{dsc_1724} - 82,6}{v_{orig_1724} - 82,6}$$

82.6 km/h is the original vehicle speed at second 1763.

The downscaled vehicle speed between second 1725 and second 1762 shall be subsequently calculated using the following equation:

$$v_{dsc_i} = v_{dsc_{i-1}} + a_{orig_{i-1}} \times f_{corr_dec} \times 3,6$$

for $i = 1725$ to 1762 .

8.3. Determination of the downscaling factor

The downscaling factor f_{dsc} , is a function of the ratio r_{max} between the maximum required power of the cycle phases where the downscaling is to be applied and the rated power of the vehicle, P_{rated} .

The maximum required power $P_{req,max,i}$ (in kW) is related to a specific time i and the corresponding vehicle speed v_i in the cycle trace and is calculated using the following equation:

$$P_{req,max,i} = \frac{\left((f_0 \times v_i) + (f_1 \times v_i^2) + (f_2 \times v_i^3) + (1,03 \times TM \times v_i \times a_i) \right)}{3\,600}$$

where:

▼ M3

f_0 , f_1 , f_2 are the applicable road load coefficients, N, N/(km/h), and N/(km/h)² respectively;

TM is the applicable test mass, kg;

v_i is the speed at time i , km/h;

a_i is the acceleration at time i , km/h².

▼ M3

The cycle time i at which maximum power or power values close to maximum power is required is second 764 for the Class 1 cycle, second 1 574 for the Class 2 cycle and second 1 566 for the Class 3 cycle.

▼ B

The corresponding vehicle speed values, v_i , and acceleration values, a_i , are as follows:

$$v_i = 61,4 \text{ km/h}, a_i = 0,22 \text{ m/s}^2 \text{ for Class 1,}$$

$$v_i = 109,9 \text{ km/h}, a_i = 0,36 \text{ m/s}^2 \text{ for Class 2,}$$

$$v_i = 111,9 \text{ km/h}, a_i = 0,50 \text{ m/s}^2 \text{ for Class 3.}$$

r_{\max} shall be calculated using the following equation:

$$r_{\max} = \frac{P_{\text{req,max},i}}{P_{\text{rated}}}$$

The downscaling factor, f_{dsc} , shall be calculated using the following equations:

$$\text{if } r_{\max} < r_0, \text{ then } f_{\text{dsc}} = 0$$

and no downscaling shall be applied.

$$\text{If } r_{\max} \geq r_0, \text{ then } f_{\text{dsc}} = a_1 \times r_{\max} + b_1$$

The calculation parameter/coefficients, r_0 , a_1 and b_1 , are as follows:

$$\text{Class 1 } r_0 = 0,978, a_1 = 0,680, b_1 = - 0,665$$

$$\text{Class 2 } r_0 = 0,866, a_1 = 0,606, b_1 = - 0,525.$$

$$\text{Class 3 } r_0 = 0,867, a_1 = 0,588, b_1 = - 0,510.$$

The resulting f_{dsc} is mathematically rounded to 3 places of decimal and is applied only if it exceeds 0,010.

The following data shall be included in all relevant test reports:

- (a) f_{dsc} ;
- (b) v_{\max} ;
- (c) distance driven, m.

The distance shall be calculated as the sum of v_i in km/h divided by 3,6 over the whole cycle trace.

8.4. Additional requirements

For different vehicle configurations in terms of test mass and driving resistance coefficients, downscaling shall be applied individually.

If, after the application of downscaling the vehicle maximum speed is lower than the maximum speed of the cycle, the process described in paragraph 9. of this Sub-Annex shall be applied with the applicable cycle.

▼ B

If the vehicle cannot follow the speed trace of the applicable cycle within the tolerance at speeds lower than its maximum speed, it shall be driven with the accelerator control fully activated during these periods. During such periods of operation, speed trace violations shall be permitted.

9. Cycle modifications for vehicles with a maximum speed lower than the maximum speed of the cycle specified in the previous paragraphs of this Sub-Annex

▼ M3

- 9.1. General remarks

This paragraph applies to vehicles that are technically able to follow the speed trace of the applicable cycle specified in paragraph 1. of this Sub-Annex (base cycle) at speeds lower than its maximum speed, but whose maximum speed is limited to a value lower than the maximum speed of the base cycle for other reasons. That applicable cycle shall be referred to as the 'base cycle' and used to determine the capped speed cycle.

In the cases where downscaling in accordance with paragraph 8.2. is applied, the downscaled cycle shall be used as the base cycle.

The maximum speed of the base cycle shall be referred to as $v_{\max, \text{cycle}}$.

The maximum speed of the vehicle shall be referred to as its capped speed v_{cap} .

If v_{cap} is applied to a Class 3b vehicle as defined in paragraph 3.3.2., the Class 3b cycle shall be used as the base cycle. This shall apply even if v_{cap} is lower than 120 km/h.

In the cases where v_{cap} is applied, the base cycle shall be modified as described in paragraph 9.2. in order to achieve the same cycle distance for the capped speed cycle as for the base cycle.

▼ B

- 9.2. Calculation steps

- 9.2.1. Determination of the distance difference per cycle phase

An interim capped speed cycle shall be derived by replacing all vehicle speed samples v_i where $v_i > v_{\text{cap}}$ by v_{cap} .

▼ M3

- 9.2.1.1. If $v_{\text{cap}} < v_{\max, \text{medium}}$, the distance of the medium speed phases of the base cycle $d_{\text{base, medium}}$ and the interim capped speed cycle $d_{\text{cap, medium}}$ shall be calculated using the following equation for both cycles:

$$d_{\text{medium}} = \sum \left(\frac{(v_i + v_{i-1})}{2 \times 3,6} \times (t_i - t_{i-1}) \right), \text{ for } i = 591 \text{ to } 1\,022$$

where:

$v_{\max, \text{medium}}$ is the maximum vehicle speed of the medium speed phase as listed in Table A1/2 for the Class 1 cycle, in Table A1/4 for the Class 2 cycle, in Table A1/8 for the Class 3a cycle and in Table A1/9 for the Class 3b cycle.

- 9.2.1.2. If $v_{\text{cap}} < v_{\max, \text{high}}$, the distances of the high speed phases of the base cycle $d_{\text{base, high}}$ and the interim capped speed cycle $d_{\text{cap, high}}$ shall be calculated using the following equation for both cycles:

$$d_{\text{high}} = \sum \left(\frac{(v_i + v_{i-1})}{2 \times 3,6} \times (t_i - t_{i-1}) \right), \text{ for } i = 1\,024 \text{ to } 1\,477$$

▼ M3

$v_{\max,high}$ is the maximum vehicle speed of the high speed phase as listed in Table A1/5 for the Class 2 cycle, in Table A1/10 for the Class 3a cycle and in Table A1/11 for the Class 3b cycle.

▼ B

- 9.2.1.3. The distances of the extra high speed phase of the base cycle $d_{\text{base,exhigh}}$ and the interim capped speed cycle $d_{\text{cap,exhigh}}$ shall be calculated applying the following equation to the extra high speed phase of both cycles:

$$d_{\text{exhigh}} = \sum \left(\frac{v_i + v_{i-1}}{2 \times 3,6} \times (t_i - t_{i-1}) \right), \text{ for } i = 1\ 479 \text{ to } 1\ 800$$

- 9.2.2. Determination of the time periods to be added to the interim capped speed cycle in order to compensate for distance differences

▼ M3

In order to compensate for a difference in distance between the base cycle and the interim capped speed cycle, corresponding time periods with $v_i = v_{\text{cap}}$ shall be added to the interim capped speed cycle as described in paragraphs 9.2.2.1. to 9.2.2.3.

▼ B

- 9.2.2.1. Additional time period for the medium speed phase

If $v_{\text{cap}} < v_{\max,medium}$, the additional time period to be added to the medium speed phase of the interim capped speed cycle shall be calculated using the following equation:

$$\Delta t_{\text{medium}} = \frac{(d_{\text{base,medium}} - d_{\text{cap,medium}})}{v_{\text{cap}}} \times 3,6$$

The number of time samples $n_{\text{add,medium}}$ with $v_i = v_{\text{cap}}$ to be added to the medium speed phase of the interim capped speed cycle equals Δt_{medium} , mathematically rounded to the nearest integer (e.g. 1.4 shall be rounded to 1, 1.5 shall be rounded to 2).

- 9.2.2.2. Additional time period for the high speed phase

If $v_{\text{cap}} < v_{\max,high}$, the additional time period to be added to the high speed phases of the interim capped speed cycle shall be calculated using the following equation:

$$\Delta t_{\text{high}} = \frac{(d_{\text{base,high}} - d_{\text{cap,high}})}{v_{\text{cap}}} \times 3,6$$

The number of time samples $n_{\text{add,high}}$ with $v_i = v_{\text{cap}}$ to be added to the high speed phase of the interim capped speed cycle equals Δt_{high} , mathematically rounded to the nearest integer.

- 9.2.2.3. The additional time period to be added to the extra high speed phase of the interim capped speed cycle shall be calculated using the following equation:

$$\Delta t_{\text{exhigh}} = \frac{(d_{\text{base,exhigh}} - d_{\text{cap,exhigh}})}{v_{\text{cap}}} \times 3,6$$

The number of time samples $n_{\text{add,exhigh}}$ with $v_i = v_{\text{cap}}$ to be added to the extra high speed phase of the interim capped speed cycle equals Δt_{exhigh} , mathematically rounded to the nearest integer.

- 9.2.3. Construction of the final capped speed cycle

▼ B9.2.3.1. ► **M3** Class 1 cycle ◀

The first part of the final capped speed cycle consists of the vehicle speed trace of the interim capped speed cycle up to the last sample in the medium speed phase where $v = v_{\text{cap}}$. The time of this sample is referred to as t_{medium} .

Then $n_{\text{add,medium}}$ samples with $v_i = v_{\text{cap}}$ shall be added, so that the time of the last sample is $(t_{\text{medium}} + n_{\text{add,medium}})$.

The remaining part of the medium speed phase of the interim capped speed cycle, which is identical with the same part of the base cycle, shall then be added, so that the time of the last sample is $(1022 + n_{\text{add,medium}})$.

9.2.3.2. ► **M3** Class 2 and Class 3 cycles ◀9.2.3.2.1. $v_{\text{cap}} < v_{\text{max,medium}}$

The first part of the final capped speed cycle consists of the vehicle speed trace of the interim capped speed cycle up to the last sample in the medium speed phase where $v = v_{\text{cap}}$. The time of this sample is referred to as t_{medium} .

Then $n_{\text{add,medium}}$ samples with $v_i = v_{\text{cap}}$ shall be added, so that the time of the last sample is $(t_{\text{medium}} + n_{\text{add,medium}})$.

The remaining part of the medium speed phase of the interim capped speed cycle, which is identical with the same part of the base cycle, shall then be added, so that the time of the last sample is $(1022 + n_{\text{add,medium}})$.

In a next step, the first part of the high speed phase of the interim capped speed cycle up to the last sample in the high speed phase where $v = v_{\text{cap}}$ shall be added. The time of this sample in the interim capped speed is referred to as t_{high} , so that the time of this sample in the final capped speed cycle is $(t_{\text{high}} + n_{\text{add,medium}})$.

Then, $n_{\text{add,high}}$ samples with $v_i = v_{\text{cap}}$ shall be added, so that the time of the last sample becomes $(t_{\text{high}} + n_{\text{add,medium}} + n_{\text{add,high}})$.

The remaining part of the high speed phase of the interim capped speed cycle, which is identical with the same part of the base cycle, shall then be added, so that the time of the last sample is $(1477 + n_{\text{add,medium}} + n_{\text{add,high}})$.

In a next step, the first part of the extra high speed phase of the interim capped speed cycle up to the last sample in the extra high speed phase where $v = v_{\text{cap}}$ shall be added. The time of this sample in the interim capped speed is referred to as t_{exhigh} , so that the time of this sample in the final capped speed cycle is $(t_{\text{exhigh}} + n_{\text{add,medium}} + n_{\text{add,high}})$.

Then $n_{\text{add,exhigh}}$ samples with $v_i = v_{\text{cap}}$ shall be added, so that the time of the last sample is $(t_{\text{exhigh}} + n_{\text{add,medium}} + n_{\text{add,high}} + n_{\text{add,exhigh}})$.

The remaining part of the extra high speed phase of the interim capped speed cycle, which is identical with the same part of the base cycle, shall then be added, so that the time of the last sample is $(1800 + n_{\text{add,medium}} + n_{\text{add,high}} + n_{\text{add,exhigh}})$.

▼ B

The length of the final capped speed cycle is equivalent to the length of the base cycle except for differences caused by the rounding process for $n_{\text{add,medium}}$, $n_{\text{add,high}}$ and $n_{\text{add,exhigh}}$.

9.2.3.2.2. ► **M3** $v_{\text{max, medium}} \leq v_{\text{cap}} < v_{\text{max, high}}$ ◀

The first part of the final capped speed cycle consists of the vehicle speed trace of the interim capped speed cycle up to the last sample in the high speed phase where $v = v_{\text{cap}}$. The time of this sample is referred to as t_{high} .

Then, $n_{\text{add,high}}$ samples with $v_i = v_{\text{cap}}$ shall be added, so that the time of the last sample is $(t_{\text{high}} + n_{\text{add,high}})$.

The remaining part of the high speed phase of the interim capped speed cycle, which is identical with the same part of the base cycle, shall then be added, so that the time of the last sample is $(1477 + n_{\text{add,high}})$.

In a next step, the first part of the extra high speed phase of the interim capped speed cycle up to the last sample in the extra high speed phase where $v = v_{\text{cap}}$ shall be added. The time of this sample in the interim capped speed is referred to as t_{exhigh} , so that the time of this sample in the final capped speed cycle is $(t_{\text{exhigh}} + n_{\text{add,high}})$.

Then $n_{\text{add,exhigh}}$ samples with $v_i = v_{\text{cap}}$ shall be added, so that the time of the last sample is $(t_{\text{exhigh}} + n_{\text{add,high}} + n_{\text{add,exhigh}})$.

The remaining part of the extra high speed phase of the interim capped speed cycle, which is identical with the same part of the base cycle, shall then be added, so that the time of the last sample is $(1800 + n_{\text{add,high}} + n_{\text{add,exhigh}})$.

The length of the final capped speed cycle is equivalent to the length of the base cycle except for differences caused by the rounding process for $n_{\text{add,high}}$ and $n_{\text{add,exhigh}}$.

9.2.3.2.3. ► **M3** $v_{\text{max, high}} \leq v_{\text{cap}} < v_{\text{max, exhigh}}$ ◀

The first part of the final capped speed cycle consists of the vehicle speed trace of the interim capped speed cycle up to the last sample in the extra high speed phase where $v = v_{\text{cap}}$. The time of this sample is referred to as t_{exhigh} .

Then, $n_{\text{add,exhigh}}$ samples with $v_i = v_{\text{cap}}$ shall be added, so that the time of the last sample is $(t_{\text{exhigh}} + n_{\text{add,exhigh}})$.

The remaining part of the extra high speed phase of the interim capped speed cycle, which is identical with the same part of the base cycle, shall then be added, so that the time of the last sample is $(1800 + n_{\text{add,exhigh}})$.

The length of the final capped speed cycle is equivalent to the length of the base cycle except for differences caused by the rounding process for $n_{\text{add,exhigh}}$.

▼ M3

10. Allocation of cycles to vehicles

- 10.1. A vehicle of a certain class shall be tested on the cycle of the same class, i.e. Class 1 vehicles on the Class 1 cycle, Class 2 vehicles on the Class 2 cycle, Class 3a vehicles on the Class 3a cycle, and Class 3b vehicles on the Class 3b cycle. However, at the request of the manufacturer and with approval of the approval authority, a vehicle may be tested on a numerically higher cycle class, e.g. a Class 2 vehicle may be tested on a Class 3 cycle. In this case the differences between Classes 3a and 3b shall be respected and the cycle may be downscaled in accordance with paragraphs 8. to 8.4.

▼ **M3***Sub-Annex 2***Gear selection and shift point determination for vehicles equipped with manual transmissions**

1. General approach
 - 1.1. The shifting procedures described in this Sub-Annex shall apply to vehicles equipped with manual shift transmissions.
 - 1.2. The prescribed gears and shifting points are based on the balance between the power required to overcome driving resistance and acceleration, and the power provided by the engine in all possible gears at a specific cycle phase.
 - 1.3. The calculation to determine the gears to use shall be based on engine speeds and full load power curves versus engine speed.
 - 1.4. For vehicles equipped with a dual-range transmission (low and high), only the range designed for normal on-road operation shall be considered for gear use determination.
 - 1.5. The prescriptions for the clutch operation shall not be applied if the clutch is operated automatically without the need of an engagement or disengagement of the driver.
 - 1.6. This Sub-Annex shall not apply to vehicles tested in accordance with Sub-Annex 8.

2. Required data and precalculations

The following data are required and calculations shall be performed in order to determine the gears to be used when driving the cycle on a chassis dynamometer:

- (a) P_{rated} , the maximum rated engine power as declared by the manufacturer, kW;
- (b) n_{rated} , the rated engine speed declared by the manufacturer as the engine speed at which the engine develops its maximum power, min^{-1} ;
- (c) n_{idle} , idling speed, min^{-1} .

n_{idle} shall be measured over a period of at least 1 minute at a sampling rate of at least 1 Hz with the engine running in warm condition, the gear lever placed in neutral, and the clutch engaged. The conditions for temperature, peripheral and auxiliary devices, etc. shall be the same as described in Sub-Annex 6 for the Type 1 test.

The value to be used in this Sub-Annex shall be the arithmetic average over the measuring period, rounded or truncated to the nearest 10 min^{-1} ;

- (d) n_g , the number of forward gears.

The forward gears in the transmission range designed for normal on-road operation shall be numbered in descending order of the ratio between engine speed in min^{-1} and vehicle speed in km/h. Gear 1 is the gear with the highest ratio, gear n_g is the gear with the lowest ratio. n_g determines the number of forward gears;

- (e) $(n/v)_i$, the ratio obtained by dividing the engine speed n by the vehicle speed v for each gear i , for i to $n_{g_{\text{max}}}$, $\text{min}^{-1}/(\text{km/h})$. $(n/v)_i$ shall be calculated using the equations in paragraph 8. of Sub-Annex 7;
- (f) f_0, f_1, f_2 , road load coefficients selected for testing, $N, N/(\text{km/h})$, and $N/(\text{km/h})^2$ respectively;

▼ **M3**(g) n_{\max}

$n_{\max1} = n_{95_high}$, the maximum engine speed where 95 per cent of rated power is reached, min^{-1} ;

If n_{95_high} cannot be determined because the engine speed is limited to a lower value n_{lim} for all gears and the corresponding full load power is higher than 95 per cent of rated power, n_{95_high} shall be set to n_{lim} .

$$n_{\max2} = (n/v)(ng_{\max}) \times v_{\max,cycle}$$

$$n_{\max3} = (n/v)(ng_{\max}) \times v_{\max,vehicle}$$

where:

$ng_{v\max}$ is defined in paragraph 2.(i);

$v_{\max,cycle}$ is the maximum speed of the vehicle speed trace in accordance with Sub-Annex 1, km/h;

$v_{\max,vehicle}$ is the maximum speed of the vehicle in accordance with paragraph 2.(i), km/h;

$(n/v)(ng_{v\max})$ is the ratio obtained by dividing engine speed n by the vehicle speed v for the gear $ng_{v\max}$, $\text{min}^{-1}/(\text{km/h})$;

n_{\max} is the maximum of $n_{\max1}$, $n_{\max2}$ and $n_{\max3}$, min^{-1} .

(h) $P_{wot}(n)$, the full load power curve over the engine speed range

The power curve shall consist of a sufficient number of data sets (n , P_{wot}) so that the calculation of interim points between consecutive data sets can be performed by linear interpolation. Deviation of the linear interpolation from the full load power curve in accordance with Annex XX shall not exceed 2 per cent. The first data set shall be at $n_{\min_drive_set}$ (see point (k)(3)) or lower. The last data set shall be at n_{\max} or higher engine speed. Data sets need not be spaced equally but all data sets shall be reported.

The data sets and the values P_{rated} and n_{rated} shall be taken from the power curve as declared by the manufacturer.

The full load power at engine speeds not covered by Annex XX shall be determined in accordance with the method described in Annex XX;

(i) Determination of $ng_{v\max}$ and v_{\max}

$ng_{v\max}$, the gear in which the maximum vehicle speed is reached and shall be determined as follows:

If $v_{\max}(ng) \geq v_{\max}(ng - 1)$ and $v_{\max}(ng - 1) \geq v_{\max}(ng - 2)$, then:

$$ng_{v\max} = ng \text{ and } v_{\max} = v_{\max}(ng).$$

If $v_{\max}(ng) < v_{\max}(ng - 1)$ and $v_{\max}(ng - 1) \geq v_{\max}(ng - 2)$, then:

$$ng_{v\max} = ng - 1 \text{ and } v_{\max} = v_{\max}(ng - 1),$$

otherwise, $ng_{v\max} = ng - 2$ and $v_{\max} = v_{\max}(ng - 2)$

▼ **M3**

where:

$v_{\max}(\text{ng})$ is the vehicle speed at which the required road load power equals the available power P_{wot} in gear ng (see Figure A2/1a).

$v_{\max}(\text{ng} - 1)$ is the vehicle speed at which the required road load power equals the available power P_{wot} in the next lower gear (gear ng - 1). See Figure A2/1b.

$v_{\max}(\text{ng} - 2)$ is the vehicle speed at which the required road load power equals the available power P_{wot} in the gear ng - 2.

Vehicle speed values rounded to one place of decimal shall be used for the determination of v_{\max} and $\text{ng}_{v_{\max}}$.

The required road load power, kW, shall be calculated using the following equation:

$$P_{\text{required}} = \frac{f_0 \times v + f_1 \times v^2 + f_2 \times v^3}{3\,600}$$

where:

v is the vehicle speed specified above, km/h.

The available power at vehicle speed v_{\max} in gear ng, gear ng - 1 or gear ng - 2 may be determined from the full load power curve, $P_{\text{wot}}(n)$, by using the following equations:

$$n_{\text{ng}} = (n/v)_{\text{ng}} \times v_{\max}(\text{ng});$$

$$n_{\text{ng} - 1} = (n/v)_{\text{ng} - 1} \times v_{\max}(\text{ng} - 1);$$

$$n_{\text{ng} - 2} = (n/v)_{\text{ng} - 2} \times v_{\max}(\text{ng} - 2),$$

and by reducing the power values of the full load power curve by 10 per cent.

The method described above shall be extended to even lower gears, i.e. ng - 3, ng - 4, etc. if necessary.

If, for the purpose of limiting maximum vehicle speed, the maximum engine speed is limited to n_{lim} which is lower than the engine speed corresponding to the intersection of the road load power curve and the available power curve, then:

$$\text{ng}_{v_{\max}} = \text{ng}_{\max} \text{ and } v_{\max} = n_{\text{lim}} / (n/v)_{\text{ng}_{\max}}.$$

▼ M3

Figure A2/1a

An example where $n_{g_{max}}$ is the highest gear

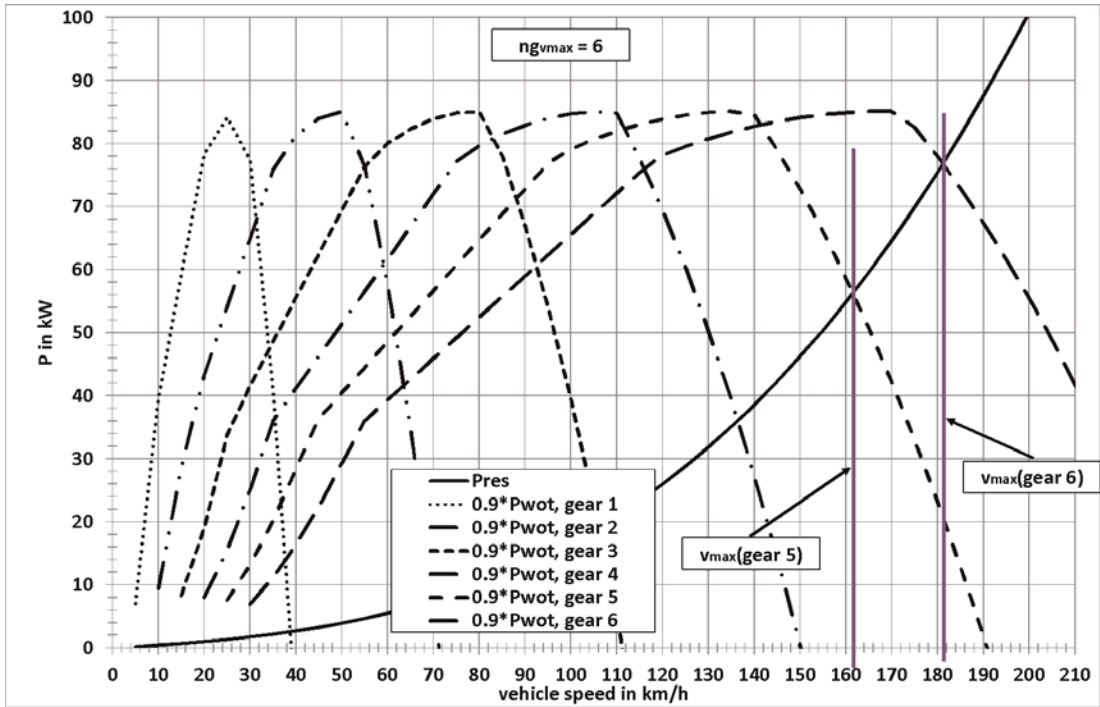
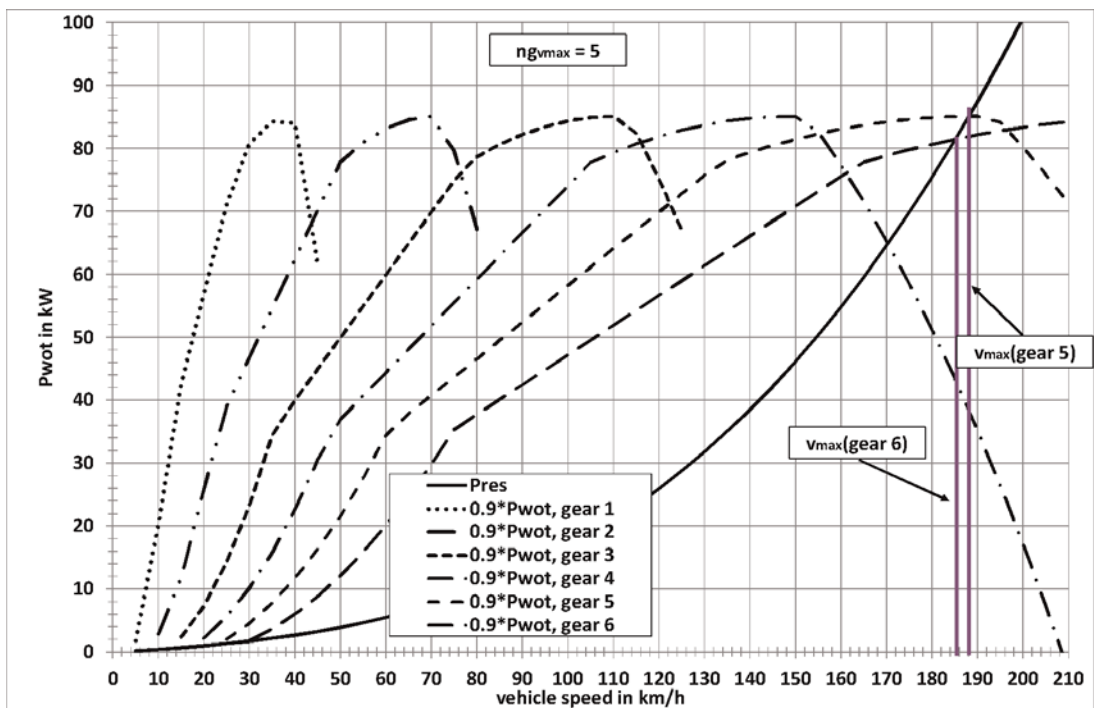

Figure A2/1b

An example where $n_{g_{max}}$ is the 2nd highest gear



▼ **M3**

(j) Exclusion of a crawler gear

Gear 1 may be excluded at the request of the manufacturer if all of the following conditions are fulfilled:

- (1) The vehicle family is homologated to tow a trailer;
- (2) $(n/v)_1 \times (v_{\max} / n_{95_high}) > 6,74$;
- (3) $(n/v)_2 \times (v_{\max} / n_{95_high}) > 3,85$;
- (4) The vehicle, having a mass m_t as defined in the equation below, is able to pull away from standstill within 4 seconds, on an uphill gradient of at least 12 per cent, on five separate occasions within a period of 5 minutes.

$$m_t = m_{r0} + 25 \text{ kg} + (MC - m_{r0} - 25 \text{ kg}) \times 0,28$$

(factor 0,28 in the above equation shall be used for category N vehicles with a gross vehicle mass up to 3,5 tonnes and shall be replaced by factor 0,15 in the case of category M vehicles),

where:

v_{\max} is the maximum vehicle speed as specified in paragraph 2. (i). Only the v_{\max} value resulting from the intersection of the required road load power curve and the available power curve of the relevant gear shall be used for the conditions in (3) and (4) above. A v_{\max} value resulting from a limitation of the engine speed which prevents this intersection of curves shall not be used;

$(n/v)(ng_{v_{\max}})$ is the ratio obtained by dividing the engine speed n by the vehicle speed v for gear $ng_{v_{\max}}$, $\text{min}^{-1}/(\text{km/h})$;

m_{r0} is the mass in running order, kg;

MC is the gross train mass (gross vehicle mass + max. trailer mass), kg.

In this case, gear 1 shall not be used when driving the cycle on a chassis dynamometer and the gears shall be renumbered starting with the second gear as gear 1.

(k) Definition of n_{\min_drive}

n_{\min_drive} is the minimum engine speed when the vehicle is in motion, min^{-1} ;

(1) For $n_{\text{gear}} = 1$, $n_{\min_drive} = n_{\text{idle}}$,

(2) For $n_{\text{gear}} = 2$,

(i) for transitions from first to second gear:

$$n_{\min_drive} = 1,15 \times n_{\text{idle}}$$

(ii) for decelerations to standstill:

$$n_{\min_drive} = n_{\text{idle}}$$

(iii) for all other driving conditions:

$$n_{\min_drive} = 0,9 \times n_{\text{idle}}$$

(3) For $n_{\text{gear}} > 2$, n_{\min_drive} shall be determined by:

$$n_{\min_drive} = n_{\text{idle}} + 0,125 \times (n_{\text{rated}} - n_{\text{idle}}).$$

This value shall be referred to as $n_{\min_drive_set}$.

▼ **M3**

The final results for n_{\min_drive} shall be rounded to the nearest integer.
Example: 1 199,5 becomes 1 200, 1 199,4 becomes 1 199.

Values higher than $n_{\min_drive_set}$ may be used for $n_{gear} > 2$ if requested by the manufacturer. In this case, the manufacturer may specify one value for acceleration/constant speed phases ($n_{\min_drive_up}$) and a different value for deceleration phases ($n_{\min_drive_down}$).

Samples which have acceleration values $\geq -0,1389 \text{ m/s}^2$ shall belong to the acceleration/constant speed phases.

In addition, for an initial period of time ($t_{\text{start_phase}}$), the manufacturer may specify higher values ($n_{\min_drive_start}$ and/or $n_{\min_drive_up_start}$) for the values n_{\min_drive} and/or $n_{\min_drive_up}$ for $n_{gear} > 2$ than specified above.

The initial time period shall be specified by the manufacturer but shall not exceed the low speed phase of the cycle and shall end in a stop phase so that there is no change of n_{\min_drive} within a short trip.

All individually chosen n_{\min_drive} values shall be equal to or higher than $n_{\min_drive_set}$ but shall not exceed ($2 \times n_{\min_drive_set}$).

All individually chosen n_{\min_drive} values and $t_{\text{start_phase}}$ shall be included in all relevant test reports.

Only $n_{\min_drive_set}$ shall be used as the lower limit for the full load power curve in accordance with paragraph 2(h).

(l) TM, test mass of the vehicle, kg.

3. Calculations of required power, engine speeds, available power, and possible gear to be used

3.1. Calculation of required power

For each second j of the cycle trace, the power required to overcome driving resistance and to accelerate shall be calculated using the following equation:

$$P_{\text{required},j} = \left(\frac{f_0 \times v_j + f_1 \times v_j^2 + f_2 \times v_j^3}{3\,600} \right) + \frac{kr \times a_j \times v_j \times TM}{3\,600}$$

where:

$P_{\text{required},j}$ is the required power at second j , kW;

a_j is the vehicle acceleration at second j , m/s^2 , and is calculated as follows:

$$a_j = \frac{(v_{j+1} - v_j)}{3,6 \times (t_{j+1} - t_j)}$$

kr is a factor taking the inertial resistances of the drivetrain during acceleration into account and is set to 1,03.

3.2. Determination of engine speeds

For any $v_j < 1 \text{ km/h}$, it shall be assumed that the vehicle is standing still and the engine speed shall be set to n_{idle} . The gear lever shall be placed in neutral with the clutch engaged except 1 second before beginning an acceleration from standstill where first gear shall be selected with the clutch disengaged.

For each $v_j \geq 1 \text{ km/h}$ of the cycle trace and each gear i , $i = 1$ to $n_{g_{\text{max}}}$, the engine speed, $n_{i,j}$, shall be calculated using the following equation:

$$n_{i,j} = (n/v)_i \times v_j$$

The calculation shall be performed with floating point numbers, the results shall not be rounded.

▼ **M3**

3.3. Selection of possible gears with respect to engine speed

The following gears may be selected for driving the speed trace at v_j :

- (a) All gears $i < n_{g_{vmax}}$ where $n_{min_drive} \leq n_{i,j} \leq n_{max1}$;
- (b) All gears $i \geq n_{g_{vmax}}$ where $n_{min_drive} \leq n_{i,j} \leq n_{max2}$;
- (c) Gear 1, if $n_{1,j} < n_{min_drive}$.

If $a_j < 0$ and $n_{i,j} \leq n_{idle}$, $n_{i,j}$ shall be set to n_{idle} and the clutch shall be disengaged.

If $a_j \geq 0$ and $n_{i,j} < \max(1,15 \times n_{idle}; \text{min. engine speed of the } P_{wot}(n) \text{ curve})$, $n_{i,j}$ shall be set to the maximum of $1,15 \times n_{idle}$ or $(n/v)_i \times v_j$ and the clutch shall be set to 'undefined'.

'undefined' covers any status of the clutch between disengaged and engaged, depending on the individual engine and transmission design. In this case the real engine speed may deviate from the calculated engine speed.

3.4. Calculation of available power

The available power for each possible gear i and each vehicle speed value of the cycle trace v_i shall be calculated using the following equation:

$$P_{available_ij} = P_{wot}(n_{i,j}) \times (1 - (SM + ASM))$$

where:

P_{rated} is the rated power, kW;

P_{wot} is the power available at $n_{i,j}$ at full load condition from the full load power curve;

SM is a safety margin accounting for the difference between the stationary full load condition power curve and the power available during transition conditions. SM is set to 10 per cent;

ASM is an additional power safety margin which may be applied at the request of the manufacturer.

When requested, the manufacturer shall provide the ASM values (in per cent reduction of the wot power) together with data sets for $P_{wot}(n)$ as shown by the example in Table A2/1. Linear interpolation shall be used between consecutive data points. ASM is limited to 50 per cent.

The application of an ASM requires the approval of the approval authority.

Table A2/1

n	P _{wot}	SM per cent	ASM per cent	P _{available}
min ⁻¹	kW			kW
700	6,3	10,0	20,0	4,4
1 000	15,7	10,0	20,0	11,0
1 500	32,3	10,0	15,0	24,2
1 800	56,6	10,0	10,0	45,3
1 900	59,7	10,0	5,0	50,8
2 000	62,9	10,0	0,0	56,6
3 000	94,3	10,0	0,0	84,9

▼ **M3**

n	P _{wot}	SM per cent	ASM per cent	P _{available}
min ⁻¹	kW			kW
4 000	125,7	10,0	0,0	113,2
5 000	157,2	10,0	0,0	141,5
5 700	179,2	10,0	0,0	161,3
5 800	180,1	10,0	0,0	162,1
6 000	174,7	10,0	0,0	157,3
6 200	169,0	10,0	0,0	152,1
6 400	164,3	10,0	0,0	147,8
6 600	156,4	10,0	0,0	140,8

3.5. Determination of possible gears to be used

The possible gears to be used shall be determined by the following conditions:

- (a) The conditions of paragraph 3.3. are fulfilled, and
- (b) For $n_{\text{gear}} > 2$, if $P_{\text{available},i,j} \geq P_{\text{required},j}$.

The initial gear to be used for each second j of the cycle trace is the highest final possible gear, i_{max} . When starting from standstill, only the first gear shall be used.

The lowest final possible gear is i_{min} .

4. Additional requirements for corrections and/or modifications of gear use

The initial gear selection shall be checked and modified in order to avoid too frequent gearshifts and to ensure driveability and practicality.

An acceleration phase is a time period of more than 2 seconds with a vehicle speed ≥ 1 km/h and with monotonic increase of vehicle speed. A deceleration phase is a time period of more than 2 seconds with a vehicle speed ≥ 1 km/h and with monotonic decrease of vehicle speed.

Corrections and/or modifications shall be made in accordance with the following requirements:

- (a) If a one step higher gear ($n + 1$) is required for only 1 second and the gears before and after are the same (n) or one of them is one step lower ($n - 1$), gear ($n + 1$) shall be corrected to gear n .

Examples:

Gear sequence $i - 1, i, i - 1$ shall be replaced by:

$i - 1, i - 1, i - 1$;

Gear sequence $i - 1, i, i - 2$ shall be replaced by:

$i - 1, i - 1, i - 2$;

Gear sequence $i - 2, i, i - 1$ shall be replaced by:

$i - 2, i - 1, i - 1$.

▼ **M3**

Gears used during accelerations at vehicle speeds ≥ 1 km/h shall be used for a period of at least 2 seconds (e.g. a gear sequence 1, 2, 3, 3, 3, 3 shall be replaced by 1, 1, 2, 2, 3, 3, 3). This requirement shall not be applied on downshifts during an acceleration phase. Such downshifts shall be corrected in accordance with paragraph 4(b). Gears shall not be skipped during acceleration phases.

However an upshift by two gears is permitted at the transition from an acceleration phase to a constant speed phase if the duration of the constant speed phase exceeds 5 seconds.

- (b) If a downshift is required during an acceleration phase the gear which is required during this downshift is noted (i_{DS}). The start point of a correction procedure is defined by either the last previous second when i_{DS} was identified, or the start point of the acceleration phase if all time samples before have gears $> i_{DS}$. The following check shall then be applied.

Working backwards from the end of the acceleration phase, the latest occurrence of a 10 second window containing i_{DS} for either 2 or more consecutive seconds, or 2 or more individual seconds shall be identified. The last usage of i_{DS} in this window defines the end point of the correction procedure. Between the start and end of the correction period, all requirements for gears greater than i_{DS} shall be corrected to a requirement of i_{DS} .

From the end of the correction period to the end of the acceleration phase, all downshifts with a duration of only one second shall be removed, if the downshift was a one step downshift. If the downshift was a two step downshift, all requirements for gears greater than or equal to i_{DS} up to the latest occurrence of i_{DS} shall be corrected to ($i_{DS} + 1$).

This final correction shall also be applied from the start point to the end of the acceleration phase, if no 10 second window containing i_{DS} for either 2 or more consecutive seconds or 2 or more individual seconds was identified.

Examples:

- (i) If the initially calculated gear use is:

2, 2, 3, [3, 4, 4, 4, 4, 3, 4, 4, 4, 4], 4, 4, 3, 4, 4, 4,

the gear use shall be corrected to:

2, 2, 3, 3, 3, 3, 3, 3, 3, 3, 3, 3, 3, 3, 4, 4, 4.

- (ii) If the initially calculated gear use is:

2, 2, 3, [3, 4, 4, 3, 4, 4, 4, 4, 4], 4, 4, 4, 4, 3, 4,

the gear use shall be corrected to:

2, 2, 3, 3, 3, 3, 3, 4, 4, 4, 4, 4, 4, 4, 4, 4, 4.

- (iii) If the initially calculated gear use is:

2, 2, 3, [3, 4, 4, 4, 4, 4, 4, 4, 4], 4, 4, 4, 3, 3, 4,

the gear use shall be corrected to:

2, 2, 3, 3, 3, 3, 3, 3, 3, 3, 3, 3, 3, 3, 3, 3, 3, 4.

The first 10 second windows are indicated by square brackets in the examples above.

The underlined gears (e.g. 3) indicate those cases which could lead to a correction of the gear before it.

This correction shall not be performed for gear 1.

▼ **M3**

- (c) If gear i is used for a time sequence of 1 to 5 seconds and the gear prior to this sequence is one step lower and the gear after this sequence is one or two steps lower than within this sequence or the gear prior to this sequence is two steps lower and the gear after this sequence is one step lower than within the sequence, the gear for the sequence shall be corrected to the maximum of the gears before and after the sequence.

Examples:

- (i) Gear sequence $i - 1, i, i - 1$ shall be replaced by:

$i - 1, i - 1, i - 1$;

Gear sequence $i - 1, i, i - 2$ shall be replaced by:

$i - 1, i - 1, i - 2$;

Gear sequence $i - 2, i, i - 1$ shall be replaced by:

$i - 2, i - 1, i - 1$.

- (ii) Gear sequence $i - 1, i, i, i - 1$ shall be replaced by:

$i - 1, i - 1, i - 1, i - 1$;

Gear sequence $i - 1, i, i, i - 2$ shall be replaced by:

$i - 1, i - 1, i - 1, i - 2$;

Gear sequence $i - 2, i, i, i - 1$ shall be replaced by:

$i - 2, i - 1, i - 1, i - 1$.

- (iii) Gear sequence $i - 1, i, i, i, i - 1$ shall be replaced by:

$i - 1, i - 1, i - 1, i - 1, i - 1$;

Gear sequence $i - 1, i, i, i, i - 2$ shall be replaced by:

$i - 1, i - 1, i - 1, i - 1, i - 2$;

Gear sequence $i - 2, i, i, i, i - 1$ shall be replaced by:

$i - 2, i - 1, i - 1, i - 1, i - 1$.

- (iv) Gear sequence $i - 1, i, i, i, i, i - 1$ shall be replaced by:

$i - 1, i - 1, i - 1, i - 1, i - 1, i - 1$;

Gear sequence $i - 1, i, i, i, i, i - 2$ shall be replaced by:

$i - 1, i - 1, i - 1, i - 1, i - 1, i - 2$;

Gear sequence $i - 2, i, i, i, i, i - 1$ shall be replaced by:

$i - 2, i - 1, i - 1, i - 1, i - 1, i - 1$.

- (v) Gear sequence $i - 1, i, i, i, i, i, i - 1$ shall be replaced by:

$i - 1, i - 1, i - 1, i - 1, i - 1, i - 1, i - 1$.

Gear sequence $i - 1, i, i, i, i, i, i - 2$ shall be replaced by:

$i - 1, i - 1, i - 1, i - 1, i - 1, i - 1, i - 2$;

Gear sequence $i - 2, i, i, i, i, i, i - 1$ shall be replaced by:

$i - 2, i - 1, i - 1, i - 1, i - 1, i - 1, i - 1$.

In all cases (i) to (v), $i - 1 \geq i_{\min}$ shall be fulfilled.

- (d) No upshift to a higher gear at the transition from an acceleration or constant speed phase to a deceleration phase shall be performed if the gear in the phase following the deceleration phase is lower than the upshifted gear.

▼ **M3**

Example:

If $v_i \leq v_{i+1}$ and $v_{i+2} < v_{i+1}$ and gear $i = 4$ and gear $(i + 1 = 5)$ and gear $(i + 2 = 5)$, then gear $(i + 1)$ and gear $(i + 2)$ shall be set to 4 if the gear for the phase following the deceleration phase is gear 4 or lower. For all following cycle trace points with gear 5 within the deceleration phase, the gear shall also be set to 4. If the gear following the deceleration phase is gear 5, an upshift shall be performed.

If there is an upshift during the transition and the initial deceleration phase by 2 gears, an upshift by 1 gear shall be performed.

No upshift to a higher gear shall be performed within a deceleration phase.

- (e) During a deceleration phase, gears with $n_{\text{gear}} > 2$ shall be used as long as the engine speed does not drop below $n_{\text{min_drive}}$.

Gear 2 shall be used during a deceleration phase within a short trip of the cycle (not at the end of a short trip) as long as the engine speed does not drop below $(0,9 \times n_{\text{idle}})$.

If the engine speed drops below n_{idle} , the clutch shall be disengaged.

If the deceleration phase is the last part of a short trip shortly before a stop phase, the second gear shall be used as long as the engine speed does not drop below n_{idle} .

- (f) If during a deceleration phase the duration of a gear sequence between two gear sequences of 3 seconds or more is only 1 second, it shall be replaced by gear 0 and the clutch shall be disengaged.

If during a deceleration phase the duration of a gear sequence between two gear sequences of 3 seconds or more is 2 seconds, it shall be replaced by gear 0 for the 1st second and for the 2nd second with the gear that follows after the 2 second period. The clutch shall be disengaged for the 1st second.

Example: A gear sequence 5, 4, 4, 2 shall be replaced by 5, 0, 2, 2.

This requirement shall only be applied if the gear that follows after the 2 second period is > 0 .

If several gear sequences with durations of 1 or 2 seconds follow one another, corrections shall be performed as follows:

A gear sequence $i, i, i, i - 1, i - 1, i - 2$ or $i, i, i, i - 1, i - 2, i - 2$ shall be changed to $i, i, i, 0, i - 2, i - 2$.

A gear sequence such as $i, i, i, i - 1, i - 2, i - 3$ or $i, i, i, i - 2, i - 2, i - 3$ or other possible combinations shall be changed to $i, i, i, 0, i - 3, i - 3$.

This change shall also be applied to gear sequences where the acceleration is ≥ 0 for the first 2 seconds and < 0 for the 3rd second or where the acceleration is ≥ 0 for the last 2 seconds.

For extreme transmission designs, it is possible that gear sequences with durations of 1 or 2 seconds following one another may last up to 7 seconds. In such cases, the correction above shall be complemented by the following correction requirements in a second step:

A gear sequence $j, 0, i, i, i - 1, k$ with $j > (i + 1)$ and $k \leq (i - 1)$ shall be changed to $j, 0, i - 1, i - 1, i - 1, k$, if gear $(i - 1)$ is one or two steps below i_{max} for second 3 of this sequence (one after gear 0).

▼ **M3**

If gear $(i - 1)$ is more than two steps below i_{\max} for second 3 of this sequence, a gear sequence $j, 0, i, i - 1, k$ with $j > (i + 1)$ and $k \leq (i - 1)$ shall be changed to $j, 0, 0, k, k, k$.

A gear sequence $j, 0, i, i - 2, k$ with $j > (i + 1)$ and $k \leq (i - 2)$ shall be changed to $j, 0, i - 2, i - 2, i - 2, k$, if gear $(i - 2)$ is one or two steps below i_{\max} for second 3 of this sequence (one after gear 0).

If gear $(i - 2)$ is more than two steps below i_{\max} for second 3 of this sequence, a gear sequence $j, 0, i, i - 2, k$ with $j > (i + 1)$ and $k \leq (i - 2)$ shall be changed to $j, 0, 0, k, k, k$.

In all cases specified above in this sub-paragraph, the clutch disengagement (gear 0) for 1 second is used in order to avoid too high engine speeds for this second. If this is not an issue and, if requested by the manufacturer, it is allowed to use the lower gear of the following second directly instead of gear 0 for downshifts of up to 3 steps. The use of this option shall be recorded.

If the deceleration phase is the last part of a short trip shortly before a stop phase and the last gear > 0 before the stop phase is used only for a period of up to 2 seconds, gear 0 shall be used instead and the gear lever shall be placed in neutral and the clutch shall be engaged.

Examples: A gear sequence of 4, 0, 2, 2, 0 for the last 5 seconds before a stop phase shall be replaced by 4, 0, 0, 0, 0. A gear sequence of 4, 3, 3, 0 for the last 4 seconds before a stop phase shall be replaced by 4, 0, 0, 0.

A downshift to first gear is not permitted during those deceleration phases.

5. Paragraphs 4.(a) to 4.(f) shall be applied sequentially, scanning the complete cycle trace in each case. Since modifications to paragraphs 4.(a) to 4.(f) may create new gear use sequences, these new gear sequences shall be checked three times and modified if necessary.

In order to enable the assessment of the correctness of the calculation, the average gear for $v \geq 1$ km/h, rounded to four places of decimal, shall be calculated and included in all relevant test reports.

▼B

Sub-Annex 3

Reserved

▼ B*Sub-Annex 4***Road load and dynamometer setting**

1. Scope

This Sub-Annex describes the determination of the road load of a test vehicle and the transfer of that road load to a chassis dynamometer.
2. Terms and definitions
 - 2.1. Reserved
 - 2.2. Reference speed points shall start at 20 km/h in incremental steps of 10 km/h and with the highest reference speed according to the following provisions:
 - (a) The highest reference speed point shall be 130 km/h or the reference speed point immediately above the maximum speed of the applicable test cycle if this value is less than 130 km/h. In the case that the applicable test cycle contains less than the 4 cycle phases (Low, Medium, High and Extra High) and at the request of the manufacturer and with approval of the approval authority, the highest reference speed may be increased to the reference speed point immediately above the maximum speed of the next higher phase, but no higher than 130 km/h; in this case road load determination and chassis dynamometer setting shall be done with the same reference speed points;
 - (b) If a reference speed point applicable for the cycle plus 14 km/h is more than or equal to the maximum vehicle speed v_{\max} , this reference speed point shall be excluded from the coastdown test and from chassis dynamometer setting. The next lower reference speed point shall become the highest reference speed point for the vehicle.
 - 2.3. Unless otherwise specified, a cycle energy demand shall be calculated according to paragraph 5. of Sub-Annex 7 over the target speed trace of the applicable drive cycle.

▼ M3

- 2.4. f_0 , f_1 , f_2 are the road load coefficients of the road load equation $F = f_0 + f_1 \times v + f_2 \times v^2$ determined in accordance with this Sub-Annex.

f_0 is the constant road load coefficient and shall be rounded to one place of decimal, N;

f_1 is the first order road load coefficient and shall be rounded to three places of decimal, N/(km/h);

f_2 is the second order road load coefficient and shall be rounded to five places of decimal, N/(km/h)².

Unless otherwise stated, the road load coefficients shall be calculated with a least square regression analysis over the range of the reference speed points.

▼ B

2.5. Rotational mass

2.5.1. Determination of m_r

m_r is the equivalent effective mass of all the wheels and vehicle components rotating with the wheels on the road while the gearbox is placed in neutral, in kilograms (kg). m_r shall be measured or calculated using an appropriate technique agreed upon by the approval authority. Alternatively, m_r may be estimated to be 3 per cent of the sum of the mass in running order and 25 kg.

2.5.2. Application of rotational mass to the road load

Coastdown times shall be transferred to forces and vice versa by taking into account the applicable test mass plus m_r . This shall apply to measurements on the road as well as on a chassis dynamometer.

2.5.3. Application of rotational mass for the inertia setting

▼ M3

If the vehicle is tested on a dynamometer in 4WD operation, the equivalent inertia mass of the chassis dynamometer shall be set to the applicable test mass.

▼ B

Otherwise, the equivalent inertia mass of the chassis dynamometer shall be set to the test mass plus either the equivalent effective mass of the wheels not influencing the measurement results or 50 per cent of m_r .

▼ M3

2.6. Additional masses for setting the test mass shall be applied such that the weight distribution of that vehicle is approximately the same as that of the vehicle with its mass in running order. In the case of category N vehicles or passenger vehicles derived from category N vehicles, the additional masses shall be located in a representative manner and shall be justified to the approval authority upon their request. The weight distribution of the vehicle shall be included in all relevant test reports and shall be used for any subsequent road load determination testing.

3. General requirements

The manufacturer shall be responsible for the accuracy of the road load coefficients and shall ensure this for each production vehicle within the road load family. Tolerances within the road load determination, simulation and calculation methods shall not be used to underestimate the road load of production vehicles. At the request of the approval authority, the accuracy of the road load coefficients of an individual vehicle shall be demonstrated.

3.1. Overall measurement accuracy, precision, resolution and frequency

The required overall measurement accuracy shall be as follows:

(a) Vehicle speed accuracy: $\pm 0,2$ km/h with a measurement frequency of at least 10 Hz;

(b) Time: min. accuracy: ± 10 ms; min. precision and resolution: 10 ms;

▼ M3

- (c) Wheel torque accuracy: ± 6 Nm or $\pm 0,5$ per cent of the maximum measured total torque, whichever is greater, for the whole vehicle, with a measurement frequency of at least 10 Hz;
- (d) Wind speed accuracy: $\pm 0,3$ m/s, with a measurement frequency of at least 1 Hz;
- (e) Wind direction accuracy: $\pm 3^\circ$, with a measurement frequency of at least 1 Hz;
- (f) Atmospheric temperature accuracy: ± 1 °C, with a measurement frequency of at least 0,1 Hz;
- (g) Atmospheric pressure accuracy: $\pm 0,3$ kPa, with a measurement frequency of at least 0,1 Hz;
- (h) Vehicle mass measured on the same weighing scale before and after the test: ± 10 kg (± 20 kg for vehicles $> 4\,000$ kg);
- (i) Tyre pressure accuracy: ± 5 kPa;
- (j) Wheel rotational speed accuracy: $\pm 0,05$ s⁻¹ or 1 per cent, whichever is greater.

▼ B

3.2. Wind tunnel criteria

3.2.1. Wind velocity

The wind velocity during a measurement shall remain within ± 2 km/h at the centre of the test section. The possible wind velocity shall be at least 140 km/h.

3.2.2. Air temperature

The air temperature during a measurement shall remain within ± 3 °C at the centre of the test section. The air temperature distribution at the nozzle outlet shall remain within ± 3 °C.

3.2.3. Turbulence

For an equally-spaced 3 by 3 grid over the entire nozzle outlet, the turbulence intensity, Tu , shall not exceed 1 per cent. See Figure A4/1.

Figure A4/1

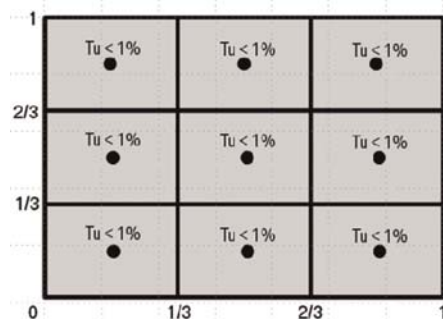
Turbulence intensity

$$Tu = \frac{u'}{U_\infty}$$

where:

Tu is the turbulence intensity;

▼ B

u' is the turbulent velocity fluctuation, m/s;

U_∞ is the free flow velocity, m/s.

3.2.4. Solid blockage ratio

The vehicle blockage ratio ε_{sb} expressed as the quotient of the vehicle frontal area and the area of the nozzle outlet as calculated using the following equation, shall not exceed 0,35.

$$\varepsilon_{sb} = \frac{A_f}{A_{nozzle}}$$

where:

ε_{sb} is the vehicle blockage ratio;

A_f is the frontal area of the vehicle, m²;

A_{nozzle} is the nozzle outlet area, m².

▼ M3

3.2.5. Rotating wheels

To properly determine the aerodynamic influence of the wheels, the wheels of the test vehicle shall rotate at such a speed that the resulting vehicle velocity is within ± 3 km/h of the wind velocity.

3.2.6. Moving belt

To simulate the fluid flow at the underbody of the test vehicle, the wind tunnel shall have a moving belt extending from the front to the rear of the vehicle. The speed of the moving belt shall be within ± 3 km/h of the wind velocity.

3.2.7. Fluid flow angle

At nine equally distributed points over the nozzle area, the root mean square deviation of both the pitch angle α and the yaw angle β (Y-, Z-plane) at the nozzle outlet shall not exceed 1°.

▼ B

3.2.8. Air pressure

At nine equally distributed points over the nozzle outlet area, the standard deviation of the total pressure at the nozzle outlet shall be equal to or less than 0.02.

$$\sigma \left(\frac{\Delta P_t}{q} \right) \leq 0,02$$

where:

σ is the standard deviation of the pressure ratio $\left(\frac{\Delta P_t}{q}\right)$;

ΔP_t is the variation of total pressure between the measurement points, N/m²;

q is the dynamic pressure, N/ m².

The absolute difference of the pressure coefficient c_p over a distance 3 metres ahead and 3 metres behind the centre of the balance in the empty test section and at a height of the centre of the nozzle outlet shall not deviate more than $\pm 0,02$.

▼ B

$$|c_{p_{x=+3m}} - c_{p_{x=-3m}}| \leq 0,02$$

where:

c_p is the pressure coefficient.

3.2.9. Boundary layer thickness

At $x = 0$ (balance center point), the wind velocity shall have at least 99 per cent of the inflow velocity 30 mm above the wind tunnel floor.

$$\delta_{99}(x = 0 \text{ m}) \leq 30 \text{ mm}$$

where:

δ_{99} is the distance perpendicular to the road, where 99 per cent of free stream velocity is reached (boundary layer thickness).

3.2.10. Restraint blockage ratio

The restraint system mounting shall not be in front of the vehicle. The relative blockage ratio of the vehicle frontal area due to the restraint system, $\varepsilon_{\text{restr}}$, shall not exceed 0,10.

$$\varepsilon_{\text{restr}} = \frac{A_{\text{restr}}}{A_f}$$

where:

$\varepsilon_{\text{restr}}$ is the relative blockage ratio of the restraint system;

A_{restr} is the frontal area of the restraint system projected on the nozzle face, m^2 ;

A_f is the frontal area of the vehicle, m^2 .

3.2.11. Measurement accuracy of the balance in the x-direction

The inaccuracy of the resulting force in the x-direction shall not exceed $\pm 5 \text{ N}$. The resolution of the measured force shall be within $\pm 3 \text{ N}$.

▼ M3

3.2.12. Measurement precision

The precision of the measured force shall be within $\pm 3 \text{ N}$.

▼ B

4. Road load measurement on road

4.1. Requirements for road test

4.1.1. Atmospheric conditions for road test

▼ M3

4.1.1.1. Permissible wind conditions

The maximum permissible wind conditions for road load determination are described in paragraphs 4.1.1.1.1. and 4.1.1.1.2.

▼ M3

In order to determine the applicability of the type of anemometry to be used, the arithmetic average of the wind speed shall be determined by continuous wind speed measurement, using a recognized meteorological instrument, at a location and height above the road level alongside the test road where the most representative wind conditions will be experienced.

If tests in opposite directions cannot be performed at the same part of the test track (e.g. on an oval test track with an obligatory driving direction), wind speed and direction at each part of the test track shall be measured. In this case the higher measured arithmetic average wind speed determines the type of anemometry to be used and the lower arithmetic average wind speed the criterion for the allowance of waiving of a wind correction.

4.1.1.1.1. Permissible wind conditions when using stationary anemometry

Stationary anemometry shall be used only when wind speeds over a period of 5 seconds average less than 5 m/s and peak wind speeds are less than 8 m/s for less than 2 seconds. In addition, the average vector component of the wind speed across the test road shall be less than 2 m/s during each valid run pair. Run pairs that do not meet the above criteria shall be excluded from the analysis. Any wind correction shall be calculated as given in paragraph 4.5.3. Wind correction may be waived when the lowest arithmetic average wind speed is 2 m/s or less.

4.1.1.1.2. Permissible wind conditions when using on-board anemometry

For testing with an on-board anemometer, a device as described in paragraph 4.3.2. shall be used. The arithmetic average of the wind speed during each valid run pair over the test road shall be less than 7 m/s with peak wind speeds of less than 10 m/s for more than 2 seconds. In addition, the average vector component of the wind speed across the road shall be less than 4 m/s during each valid run pair. Run pairs that do not meet the above criteria shall be excluded from the analysis.

▼ B

4.1.1.2. Atmospheric temperature

The atmospheric temperature should be within the range of 5 °C up to and including 35 °C.

If the difference between the highest and the lowest measured temperature during the coastdown test is more than 5 °C, the temperature correction shall be applied separately for each run with the arithmetic average of the ambient temperature of that run.

In that case the values of the road load coefficients f_0 , f_1 and f_2 shall be determined and corrected for each individual run. The final set of f_0 , f_1 and f_2 values shall be the arithmetic average of the individually corrected coefficients f_0 , f_1 and f_2 respectively.

At its option, a manufacturer may choose to perform coastdowns between 1 °C and 5 °C.

▼ B

4.1.2. Test road

The road surface shall be flat, even, clean, dry and free of obstacles or wind barriers that might impede the measurement of the road load, and its texture and composition shall be representative of current urban and highway road surfaces. The longitudinal slope of the test road shall not exceed ± 1 per cent. The local slope between any points 3 metres apart shall not deviate more than $\pm 0,5$ per cent from this longitudinal slope. If tests in opposite directions cannot be performed at the same part of the test track (e.g. on an oval test track with an obligatory driving direction), the sum of the longitudinal slopes of the parallel test track segments shall be between 0 and an upward slope of 0,1 per cent. The maximum camber of the test road shall be 1,5 per cent.

4.2. Preparation

4.2.1. Test vehicle

Each test vehicle shall conform in all its components with the production series, or, if the vehicle is different from the production vehicle, a full description shall be included in all relevant test reports.

▼ M3

4.2.1.1. Requirements for test vehicle selection

4.2.1.1.1. Without using the interpolation method

A test vehicle (vehicle H) with the combination of road load relevant characteristics (i.e. mass, aerodynamic drag and tyre rolling resistance) producing the highest cycle energy demand shall be selected from the family (see paragraphs 5.6. and 5.7. of this Annex).

If the aerodynamic influence of the different wheels within one interpolation family is not known, the selection shall be based on the highest expected aerodynamic drag. As a guideline, the highest aerodynamic drag may be expected for wheels with (a) the largest width, (b) the largest diameter, and (c) the most open structure design (in that order of importance).

The wheel selection shall be performed additional to the requirement of the highest cycle energy demand.

4.2.1.1.2. Using an interpolation method

At the request of the manufacturer, an interpolation method may be applied.

In this case, two test vehicles shall be selected from the family complying with the respective family requirement.

Test vehicle H shall be the vehicle producing the higher, and preferably highest, cycle energy demand of that selection, test vehicle L the one producing the lower, and preferably lowest, cycle energy demand of that selection.

▼ **M3**

All items of optional equipment and/or body shapes that are chosen not to be considered when applying the interpolation method shall be identical for both test vehicles H and L such that these items of optional equipment produce the highest combination of the cycle energy demand due to their road load relevant characteristics (i.e. mass, aerodynamic drag and tyre rolling resistance).

In the case where individual vehicles may be supplied with a complete set of standard wheels and tyres and a complete set of snow tyres (marked with 3 Peaked Mountain and Snowflake – 3PMS) with or without wheels, the additional wheels/tyres shall not be considered as optional equipment.

As a guidance, the following minimum deltas between vehicles H and L should be fulfilled for that road load relevant characteristic:

- (i) mass at least 30 kg;
- (ii) rolling resistance at least 1,0 kg/t;
- (iii) aerodynamic drag $C_D \times A$ at least 0,05 m².

To achieve a sufficient delta between vehicle H and L on a particular road load relevant characteristic, the manufacturer may artificially worsen vehicle H, e.g. by applying a higher test mass.

4.2.1.2. Requirements for families

4.2.1.2.1. Requirements for applying the interpolation family without using the interpolation method

For the criteria defining an interpolation family, see paragraph 5.6. of this Annex.

4.2.1.2.2. Requirements for applying the interpolation family using the interpolation method are:

- (a) Fulfilling the interpolation family criteria listed in paragraph 5.6. of this Annex;
- (b) Fulfilling the requirements in paragraphs 2.3.1. and 2.3.2. of Sub-Annex 6;
- (c) Performing the calculations in paragraph 3.2.3.2. of Sub-Annex 7.

▼ **M3**

- 4.2.1.2.3. Requirements for applying the road load family
- 4.2.1.2.3.1. At the request of the manufacturer and upon fulfilling the criteria of paragraph 5.7. of this Annex, the road load values for vehicles H and L of an interpolation family shall be calculated.
- 4.2.1.2.3.2. Test vehicles H and L as defined in paragraph 4.2.1.1.2. shall be referred to as H_R and L_R for the purpose of the road load family.
- 4.2.1.2.3.3. In addition to the requirements of an interpolation family in paragraphs 2.3.1. and 2.3.2. of Sub-Annex 6, the difference in cycle energy demand between H_R and L_R of the road load family shall be at least 4 per cent and shall not exceed 35 per cent based on H_R over a complete WLTC Class 3 cycle.

If more than one transmission is included in the road load family, a transmission with the highest power losses shall be used for road load determination.

- 4.2.1.2.3.4. If the road load delta of the vehicle option causing the friction difference is determined in accordance with paragraph 6.8., a new road load family shall be calculated which includes the road load delta in both vehicle L and vehicle H of that new road load family.

$$f_{0,N} = f_{0,R} + f_{0,Delta}$$

$$f_{1,N} = f_{1,R} + f_{1,Delta}$$

$$f_{2,N} = f_{2,R} + f_{2,Delta}$$

where:

N refers to the road load coefficients of the new road load family;

R refers to the road load coefficients of the reference road load family;

Delta refers to the delta road load coefficients determined in paragraph 6.8.1.

- 4.2.1.3. Allowable combinations of test vehicle selection and family requirements

Table A4/1 shows the permissible combinations of test vehicle selection and family requirements as described in paragraphs 4.2.1.1. and 4.2.1.2.

Table A4/1

Permissible combinations of test vehicle selection and family requirements

Requirements to be fulfilled:	(1) w/o interpolation method	(2) Interpolation method w/o road load family	(3) Applying the road load family	(4) Interpolation method using one or more road load families
Road load test vehicle	Paragraph 4.2.1.1.1.	Paragraph 4.2.1.1.2.	Paragraph 4.2.1.1.2.	n.a.
Family	Paragraph 4.2.1.2.1.	Paragraph 4.2.1.2.2.	Paragraph 4.2.1.2.3.	Paragraph 4.2.1.2.2.

▼ M3

Requirements to be fulfilled:	(1) w/o interpolation method	(2) Interpolation method w/o road load family	(3) Applying the road load family	(4) Interpolation method using one or more road load families
Additional	none	none	none	Application of column (3) 'Applying the road load family' and application of paragraph 4.2.1.3.1.

4.2.1.3.1. Deriving road loads of an interpolation family from a road load family

Road loads H_R and/or L_R shall be determined in accordance with this Sub-Annex.

The road load of vehicle H (and L) of an interpolation family within the road load family shall be calculated in accordance with paragraphs 3.2.3.2.2. to 3.2.3.2.2.4. of Sub-Annex 7 by:

- (a) Using H_R and L_R of the road load family instead of H and L as inputs for the equations;
- (b) Using the road load parameters (i.e. test mass, $\Delta(C_D \times A_f)$ compared to vehicle L_R , and tyre rolling resistance) of vehicle H (or L) of the interpolation family as inputs for the individual vehicle;
- (c) Repeating this calculation for each H and L vehicle of every interpolation family within the road load family.

The road load interpolation shall only be applied on those road load-relevant characteristics that were identified to be different between test vehicle L_R and H_R . For other road load-relevant characteristic(s), the value of vehicle H_R shall apply.

H and L of the interpolation family may be derived from different road load families. If that difference between these road load families comes from applying the delta method, refer to paragraph 4.2.1.2.3.4.

▼ B

4.2.1.4. Application of the road load matrix family

A vehicle that fulfils the criteria of paragraph 5.8. of this Annex that is:

- (a) representative of the intended series of complete vehicles to be covered by the road load matrix family in terms of estimated worst C_D value and body shape, and
- (b) representative of the intended series of vehicles to be covered by the road load matrix family in terms of estimated average of the mass of optional equipment, shall be used to determine the road load.

▼ B

In the case that no representative body shape for a complete vehicle can be determined, the test vehicle shall be equipped with a square box with rounded corners with radii of maximum of 25 mm and a width equal to the maximum width of the vehicles covered by the road load matrix family, and a total height of the test vehicle of $3,0\text{ m} \pm 0,1\text{ m}$, including the box.

The manufacturer and the approval authority shall agree which vehicle test model is representative.

The vehicle parameters test mass, tyre rolling resistance and frontal area of both a vehicle H_M and L_M shall be determined in such a way that vehicle H_M produces the highest cycle energy demand and vehicle L_M the lowest cycle energy from the road load matrix family. The manufacturer and the approval authority shall agree on the vehicle parameters for vehicle H_M and L_M .

The road load of all individual vehicles of the road load matrix family, including H_M and L_M , shall be calculated according to paragraph 5.1. of this Sub-Annex.

4.2.1.5. Movable aerodynamic body parts

Movable aerodynamic body parts on the test vehicles shall operate during road load determination as intended under WLTP Type 1 test conditions (test temperature, vehicle speed and acceleration range, engine load, etc.).

Every vehicle system that dynamically modifies the vehicle's aerodynamic drag (e.g. vehicle height control) shall be considered to be a movable aerodynamic body part. Appropriate requirements shall be added if future vehicles are equipped with movable aerodynamic items of optional equipment whose influence on aerodynamic drag justifies the need for further requirements.

4.2.1.6. Weighing

Before and after the road load determination procedure, the selected vehicle shall be weighed, including the test driver and equipment, to determine the arithmetic average mass, m_{av} . The mass of the vehicle shall be greater than or equal to the test mass of vehicle H or of vehicle L at the start of the road load determination procedure.

4.2.1.7. Test vehicle configuration

The test vehicle configuration shall be included in all relevant test reports and shall be used for any subsequent coastdown testing.

4.2.1.8. Test vehicle condition**4.2.1.8.1. Run-in**

The test vehicle shall be suitably run-in for the purpose of the subsequent test for at least 10 000 but no more than 80 000 km.

▼ M3

At the request of the manufacturer, a vehicle with a minimum of 3 000 km may be used.

▼ B

4.2.1.8.2. Manufacturer's specifications

The vehicle shall conform to the manufacturer's intended production vehicle specifications regarding tyre pressures described in paragraph 4.2.2.3. of this Sub-Annex, wheel alignment described in paragraph 4.2.1.8.3. of this Sub-Annex, ground clearance, vehicle height, drivetrain and wheel bearing lubricants, and brake adjustment to avoid unrepresentative parasitic drag.

4.2.1.8.3. Wheel alignment

Toe and camber shall be set to the maximum deviation from the longitudinal axis of the vehicle in the range defined by the manufacturer. If a manufacturer prescribes values for toe and camber for the vehicle, these values shall be used. At the request of the manufacturer, values with higher deviations from the longitudinal axis of the vehicle than the prescribed values may be used. The prescribed values shall be the reference for all maintenance during the lifetime of the vehicle.

Other adjustable wheel alignment parameters (such as caster) shall be set to the values recommended by the manufacturer. In the absence of recommended values, they shall be set to the arithmetic average of the range defined by the manufacturer.

Such adjustable parameters and set values shall be included in all relevant test sheets.

4.2.1.8.4. Closed panels

During the road load determination, the engine compartment cover, luggage compartment cover, manually-operated movable panels and all windows shall be closed.

▼ M3

4.2.1.8.5. Vehicle coastdown mode

If the determination of dynamometer settings cannot meet the criteria described in paragraphs 8.1.3. or 8.2.3. due to non-reproducible forces, the vehicle shall be equipped with a vehicle coastdown mode. The vehicle coastdown mode shall be approved by the approval authority and its use shall be included in all relevant test reports.

If a vehicle is equipped with a vehicle coastdown mode, it shall be engaged both during road load determination and on the chassis dynamometer.

▼ B

4.2.2. Tyres

▼ M3

4.2.2.1. Tyre rolling resistance

Tyre rolling resistances shall be measured in accordance with Annex 6 to UN/ECE Regulation No 117 – 02 series of amendments. The rolling resistance coefficients shall be aligned and categorised in accordance with the rolling resistance classes in Regulation (EC) No 1222/2009 (see Table A4/2).

▼ M3

Table A4/2

Energy efficiency classes in accordance with rolling resistance coefficients (RRC) for C1, C2 and C3 tyres and the RRC values to be used for those energy efficiency classes in the interpolation, kg/tonne

Energy Efficiency Class	Value of RRC to be used for interpolation for C1 tyres	Value of RRC to be used for interpolation for C2 tyres	Value of RRC to be used for interpolation for C3 tyres
A	RRC = 5,9	RRC = 4,9	RRC = 3,5
B	RRC = 7,1	RRC = 6,1	RRC = 4,5
C	RRC = 8,4	RRC = 7,4	RRC = 5,5
D	Empty	Empty	RRC = 6,5
E	RRC = 9,8	RRC = 8,6	RRC = 7,5
F	RRC = 11,3	RRC = 9,9	RRC = 8,5
G	RRC = 12,9	RRC = 11,2	Empty

If the interpolation method is applied to rolling resistance, for the purpose of the calculation in paragraph 3.2.3.2. of Sub-Annex 7, the actual rolling resistance values for the tyres fitted to the test vehicles L and H shall be used as input for the calculation procedure. For an individual vehicle within an interpolation family, the RRC value for the energy efficiency class of the tyres fitted shall be used.

In the case where individual vehicles may be supplied with a complete set of standard wheels and tyres and a complete set of snow tyres (marked with 3 Peaked Mountain and Snowflake – 3PMS) with or without wheels, the additional wheels/tyres shall not be considered as optional equipment.

▼ B

4.2.2.2. Tyre condition

Tyres used for the test shall:

- (a) Not be older than 2 years after the production date;
- (b) Not be specially conditioned or treated (e.g. heated or artificially aged), with the exception of grinding in the original shape of the tread;
- (c) Be run-in on a road for at least 200 km before road load determination;
- (d) Have a constant tread depth before the test between 100 and 80 per cent of the original tread depth at any point over the full tread width of the tyre.

▼ M3

After measurement of tread depth, the driving distance shall be limited to 500 km. If 500 km are exceeded, the tread depth shall be measured again.

▼ B

4.2.2.3. Tyre pressure

The front and rear tyres shall be inflated to the lower limit of the tyre pressure range for the respective axle for the selected tyre at the coastdown test mass, as specified by the vehicle manufacturer.

▼ B

4.2.2.3.1. Tyre pressure adjustment

If the difference between ambient and soak temperature is more than 5 °C, the tyre pressure shall be adjusted as follows:

- (a) The tyres shall be soaked for more than 1 hour at 10 per cent above the target pressure;
- (b) Prior to testing, the tyre pressure shall be reduced to the inflation pressure as specified in paragraph 4.2.2.3. of this Sub-Annex, adjusted for difference between the soaking environment temperature and the ambient test temperature at a rate of 0,8 kPa per 1 °C using the following equation:

$$\Delta p_t = 0,8 \times (T_{\text{soak}} - T_{\text{amb}})$$

where:

ΔP_t is the tyre pressure adjustment added to the tyre pressure defined in paragraph 4.2.2.3. of this Sub-Annex, kPa;

0,8 is the pressure adjustment factor, kPa/°C;

T_{soak} is the tyre soaking temperature, °C;

T_{amb} is the test ambient temperature, °C.

- (c) Between the pressure adjustment and the vehicle warm-up, the tyres shall be shielded from external heat sources including sun radiation.

4.2.3. Instrumentation

Any instruments shall be installed in such a manner as to minimise their effects on the aerodynamic characteristics of the vehicle.

If the effect of the installed instrument on $(C_D \times A_f)$ is expected to be greater than 0,015 m², the vehicle with and without the instrument shall be measured in a wind tunnel fulfilling the criterion in paragraph 3.2. of this Sub-Annex. The corresponding difference shall be subtracted from f_2 . At the request of the manufacturer, and with approval of the approval authority, the determined value may be used for similar vehicles where the influence of the equipment is expected to be the same.

4.2.4. Vehicle warm-up

4.2.4.1. On the road

Warming up shall be performed by driving the vehicle only.

- 4.2.4.1.1. Before warm-up, the vehicle shall be decelerated with the clutch disengaged or an automatic transmission placed in neutral by moderate braking from 80 to 20 km/h within 5 to 10 seconds. After this braking, there shall be no further actuation or manual adjustment of the braking system.

At the request of the manufacturer and upon approval of the approval authority, the brakes may also be activated after the warm-up with the same deceleration as described in this paragraph and only if necessary.

4.2.4.1.2. Warming up and stabilization

▼ M3

All vehicles shall be driven at 90 per cent of the maximum speed of the applicable WLTC. The vehicle shall be warmed up for at least 20 minutes until stable conditions are reached.

▼M3

Table A4/3

Reserved**▼B**

Vehicle class	Applicable WLTC	90 per cent of maximum speed	Next higher phase
Class1	Low ₁ + Medium ₁	58 km/h	NA
Class2	Low ₂ + Medium ₂ + High ₂ + Extra High ₂	111 km/h	NA
	Low ₂ + Medium ₂ + High ₂	77 km/h	Extra High (111 km/h)
Class3	Low ₃ + Medium ₃ + High ₃ + Extra High ₃	118 km/h	NA
	Low ₃ + Medium ₃ + High ₃	88 km/h	Extra High (118 km/h)

4.2.4.1.3. Criterion for stable condition

Refer to paragraph 4.3.1.4.2. of this Sub-Annex.

4.3. Measurement and calculation of road load by the coastdown method

The road load shall be determined by using either the stationary anemometry (paragraph 4.3.1. of this Sub-Annex) or the on-board anemometry (paragraph 4.3.2. of this Sub-Annex) method.

4.3.1. Coastdown method with stationary anemometry

▼M3

4.3.1.1. Selection of reference speeds for road load curve determination

Reference speeds for road load determination shall be selected in accordance with paragraph 2.2.

During the test, elapsed time and vehicle speed shall be measured at a minimum frequency of 10 Hz.

▼B

4.3.1.3. Vehicle coastdown procedure

4.3.1.3.1. Following the vehicle warm-up procedure described in paragraph 4.2.4. of this Sub-Annex and immediately prior to each test measurement, the vehicle shall be accelerated to 10 to 15 km/h above the highest reference speed and shall be driven at that speed for a maximum of 1 minute. After that, the coastdown shall be started immediately.

4.3.1.3.2. During coastdown, the transmission shall be in neutral. Any movement of the steering wheel shall be avoided as much as possible, and the vehicle brakes shall not be operated.

▼M3

4.3.1.3.3. The test shall be repeated until the coastdown data satisfy the statistical precision requirements as specified in paragraph 4.3.1.4.2.

4.3.1.3.4. Although it is recommended that each coastdown run be performed without interruption, split runs may be performed if data cannot be collected in a single run for all the reference speed points. For split runs, the following additional requirements shall apply:

▼ **M3**

- (a) Care shall be taken to keep the vehicle condition as constant as possible at each split point;
- (b) At least one speed point shall overlap with the higher speed range coastdown;
- (c) At each of all overlapped speed point, the average force of the lower speed range coastdown shall not deviate from the average force of the higher speed range coastdown by ± 10 N or ± 5 percent, whichever is greater;
- (d) If the track length does not allow fulfilling requirement (b) in this paragraph, one additional speed point shall be added to serve as overlapping speed point.

4.3.1.4. Coastdown time measurement

4.3.1.4.1. The coastdown time corresponding to reference speed v_j as the elapsed time from vehicle speed $(v_j + 5$ km/h) to $(v_j - 5$ km/h) shall be measured.

4.3.1.4.2. These measurements shall be carried out in opposite directions until a minimum of three pairs of measurements have been obtained that satisfy the statistical precision p_j defined in the following equation:

$$p_j = \frac{h \times \sigma_j}{\sqrt{n} \times \Delta t_{pj}} \leq 0,030$$

where:

p_j is the statistical precision of the measurements made at reference speed v_j ;

n is the number of pairs of measurements;

Δt_{pj} is the harmonic average of the coastdown time at reference speed v_j in seconds, given by the following equation:

$$\Delta t_{pj} = \frac{n}{\sum_{i=1}^n \frac{1}{\Delta t_{ji}}}$$

where:

Δt_{ji} is the harmonic average coastdown time of the i th pair of measurements at velocity v_j , seconds, s , given by the following equation:

$$\Delta t_{ji} = \frac{2}{\left(\frac{1}{\Delta t_{jai}}\right) + \left(\frac{1}{\Delta t_{jbi}}\right)}$$

where:

Δt_{jai} and Δt_{jbi} are the coastdown times of the i th measurement at reference speed v_j , in seconds, s , in the respective directions a and b ;

▼ **M3**

σ_j is the standard deviation, expressed in seconds, s, defined by:

$$\sigma_j = \sqrt{\frac{1}{n-1} \sum_{i=1}^n (\Delta t_{ji} - \Delta t_{pj})^2}$$

h is a coefficient given in Table A4/4.

Table A4/4

Coefficient h as a function of n

n	h	n	h
3	4,3	17	2,1
4	3,2	18	2,1
5	2,8	19	2,1
6	2,6	20	2,1
7	2,5	21	2,1
8	2,4	22	2,1
9	2,3	23	2,1
10	2,3	24	2,1
11	2,2	25	2,1
12	2,2	26	2,1
13	2,2	27	2,1
14	2,2	28	2,1
15	2,2	29	2,0
16	2,1	30	2,0

4.3.1.4.3. If during a measurement in one direction any external factor or driver action occurs that obviously influences the road load test, that measurement and the corresponding measurement in the opposite direction shall be rejected. All the rejected data and the reason for rejection shall be recorded, and the number of rejected pairs of measurement shall not exceed 1/3 of the total number of measurement pairs. The maximum number of pairs that still fulfil the statistical precision as defined in paragraph 4.3.1.4.2. shall be evaluated. In the case of exclusion, pairs shall be excluded from the evaluations starting with the pair having the maximum deviation from the average.

4.3.1.4.4. The following equation shall be used to compute the arithmetic average of the road load where the harmonic average of the alternate coastdown times shall be used.

$$F_j = \frac{1}{3,6} \times (m_{av} + m_r) \times \frac{2 \times \Delta v}{\Delta t_j}$$

where:

Δt_j is the harmonic average of alternate coastdown time measurements at velocity v_j , seconds, s, given by:

$$\Delta t_j = \frac{2}{\frac{1}{\Delta t_{ja}} + \frac{1}{\Delta t_{jb}}}$$

▼ M3

where:

Δt_{ja} and Δt_{jb} are the harmonic average coastdown times in directions a and b, respectively, corresponding to reference speed v_j , in seconds, s, given by the following two equations:

$$\Delta q_{ja} = \frac{n}{\sum_{i=1}^n \frac{1}{t_{jai}}}$$

and:

$$\Delta n_{jb} = \sum_{i=1}^n \frac{1}{t_{jbi}}.$$

where:

m_{av} is the arithmetic average of the test vehicle masses at the beginning and end of road load determination, kg;

m_r is the equivalent effective mass of rotating components in accordance with paragraph 2.5.1.;

The coefficients, f_0 , f_1 and f_2 , in the road load equation shall be calculated with a least squares regression analysis.

In the case that the tested vehicle is the representative vehicle of a road load matrix family, the coefficient f_1 shall be set to zero and the coefficients f_0 and f_2 shall be recalculated with a least squares regression analysis.

▼ B

4.3.2. Coastdown method with on-board anemometry

The vehicle shall be warmed up and stabilised according to paragraph 4.2.4. of this Sub-Annex.

4.3.2.1. Additional instrumentation for on-board anemometry

The on-board anemometer and instrumentation shall be calibrated by means of operation on the test vehicle where such calibration occurs during the warm-up for the test.

4.3.2.1.1. Relative wind speed shall be measured at a minimum frequency of 1 Hz and to an accuracy of 0.3 m/s. Vehicle blockage shall be accounted for in the calibration of the anemometer.

4.3.2.1.2. Wind direction shall be relative to the direction of the vehicle. The relative wind direction (yaw) shall be measured with a resolution of 1 degree and an accuracy of 3 degrees; the dead band of the instrument shall not exceed 10 degrees and shall be directed towards the rear of the vehicle.

4.3.2.1.3. Before the coastdown, the anemometer shall be calibrated for wind speed and yaw offset as specified in ISO 10521-1:2006(E) Annex A.

4.3.2.1.4. Anemometer blockage shall be corrected for in the calibration procedure as described in ISO 10521-1:2006(E) Annex A in order to minimise its effect.

▼B

4.3.2.2. Selection of vehicle speed range for road load curve determination

The test vehicle speed range shall be selected according to paragraph 2.2. of this Sub-Annex.

▼M3

4.3.2.3. Data collection

During the procedure, elapsed time, vehicle speed, and air velocity (wind speed, direction) relative to the vehicle, shall be measured at a minimum frequency of 5 Hz. Ambient temperature shall be synchronised and sampled at a minimum frequency of 0,1 Hz.

▼B

4.3.2.4. Vehicle coastdown procedure

The measurements shall be carried out in opposite directions until a minimum of ten consecutive runs (five in each direction) have been obtained. Should an individual run fail to satisfy the required on-board anemometry test conditions, that run and the corresponding run in the opposite direction shall be rejected. All valid pairs shall be included in the final analysis with a minimum of 5 pairs of coastdown runs. See paragraph 4.3.2.6.10. of this Sub-Annex for statistical validation criteria.

The anemometer shall be installed in a position such that the effect on the operating characteristics of the vehicle is minimised.

The anemometer shall be installed according to one of the options below:

- (a) Using a boom approximately 2 metres in front of the vehicle's forward aerodynamic stagnation point;
- (b) On the roof of the vehicle at its centreline. If possible, the anemometer shall be mounted within 30 cm from the top of the windshield.
- (c) On the engine compartment cover of the vehicle at its centreline, mounted at the midpoint position between the vehicle front and the base of the windshield.

In all cases, the anemometer shall be mounted parallel to the road surface. In the event that positions (b) or (c) are used, the coastdown results shall be analytically adjusted for the additional aerodynamic drag induced by the anemometer. The adjustment shall be made by testing the coastdown vehicle in a wind tunnel both with and without the anemometer installed in the same position as used on the track. The calculated difference shall be the incremental aerodynamic drag coefficient C_D combined with the frontal area, which shall be used to correct the coastdown results.

4.3.2.4.1. Following the vehicle warm-up procedure described in paragraph 4.2.4. of this Sub-Annex and immediately prior to each test measurement, the vehicle shall be accelerated to 10 to 15 km/h above the highest reference speed and shall be driven at that speed for a maximum of 1 minute. After that, the coastdown shall be started immediately.

4.3.2.4.2. During a coastdown, the transmission shall be in neutral. Any steering wheel movement shall be avoided as much as possible, and the vehicle's brakes shall not be operated.

▼ M3

4.3.2.4.3. Although it is recommended that each coastdown run be performed without interruption, split runs may be performed if data cannot be collected in a single run for all the reference speed points. For split runs, the following additional requirements shall apply:

- (a) Care shall be taken to keep the vehicle condition as constant as possible at each split point;
- (b) At least one speed point shall be overlapped with the higher speed range coastdown;
- (c) At each of all overlapped speed point(s), the average force of the lower speed range coastdown shall not deviate from the average force of the higher speed range coastdown by ± 10 N or ± 5 percent, whichever is greater;
- (d) If the track length does not allow fulfilling the requirement in point (b), one additional speed point shall be added to serve as overlapping speed point.

▼ B

4.3.2.5. Determination of the equation of motion

▼ M3

Symbols used in the on-board anemometer equations of motion are listed in Table A4/5.

Table A4/5

▼ B

Symbols used in the on-board anemometer equations of motion

Symbol	Units	Description
A_f	m^2	frontal area of the vehicle
$a_0 \dots a_n$	degrees ⁻¹	Aerodynamic drag coefficients as a function of yaw angle
A_m	N	mechanical drag coefficient
B_m	N/(km/h)	mechanical drag coefficient
C_m	N/(km/h) ²	mechanical drag coefficient
$C_D(Y)$		aerodynamic drag coefficient at yaw angle Y
D	N	drag
D_{aero}	N	aerodynamic drag
D_f	N	front axle drag (including driveline)

▼ B

Symbol	Units	Description
D_{grav}	N	gravitational drag
D_{mech}	N	mechanical drag
D_{r}	N	rear axle drag (including driveline)
D_{tyre}	N	tyre rolling resistance
(dh/ds)	—	sine of the slope of the track in the direction of travel (+ indicates ascending)
(dv/dt)	m/s^2	acceleration
g	m/s^2	gravitational constant
m_{av}	kg	arithmetic average mass of the test vehicle before and after road load determination
▼ M3		
m_{e}	kg	effective vehicle inertia including rotating components
▼ B		
ρ	kg/m^3	air density
t	s	time
T	K	Temperature
v	km/h	vehicle speed
v_{r}	km/h	relative wind speed
Y	degrees	yaw angle of apparent wind relative to direction of vehicle travel

▼ M3

4.3.2.5.1. General form

The general form of the equation of motion is as follows:

$$- m_{\text{e}} \left(\frac{dv}{dt} \right) = D_{\text{mech}} + D_{\text{aero}} + D_{\text{grav}}$$

where:

$$D_{\text{mech}} = D_{\text{tyre}} + D_{\text{f}} + D_{\text{r}};$$

$$D_{\text{aero}} = \left(\frac{1}{2} \right) \rho C_{\text{D}}(Y) A_{\text{f}} v_{\text{r}}^2;$$

$$D_{\text{grav}} = m \times g \times \left(\frac{dh}{ds} \right)$$

In the case that the slope of the test track is equal to or less than 0,1 per cent over its length, D_{grav} may be set to zero.

▼ B

4.3.2.5.2. Mechanical drag modelling

Mechanical drag consisting of separate components representing tyre D_{tyre} and front and rear axle frictional losses, D_f and D_r , including transmission losses) shall be modelled as a three-term polynomial as a function of vehicle speed v as in the equation below:

$$D_{\text{mech}} = A_m + B_m v + C_m v^2$$

where:

A_m , B_m , and C_m are determined in the data analysis using the least squares method. These constants reflect the combined driveline and tyre drag.

In the case that the tested vehicle is the representative vehicle of a road load matrix family, the coefficient B_m shall be set to zero and the coefficients A_m and C_m shall be recalculated with a least squares regression analysis.

4.3.2.5.3. Aerodynamic drag modelling

The aerodynamic drag coefficient $C_D(Y)$ shall be modelled as a four-term polynomial as a function of yaw angle Y as in the equation below:

$$C_D(Y) = a_0 + a_1 Y + a_2 Y^2 + a_3 Y^3 + a_4 Y^4$$

a_0 to a_4 are constant coefficients whose values are determined in the data analysis.

The aerodynamic drag shall be determined by combining the drag coefficient with the vehicle's frontal area A_f and the relative wind velocity v_r :

$$D_{\text{aero}} = \left(\frac{1}{2}\right) \times \rho \times A_f \times v_r^2 \times C_D(Y)$$

$$D_{\text{aero}} = \left(\frac{1}{2}\right) \times \rho \times A_f \times v_r^2 (a_0 + a_1 Y + a_2 Y^2 + a_3 Y^3 + a_4 Y^4)$$

4.3.2.5.4. Final equation of motion

Through substitution, the final form of the equation of motion becomes:

▼ M3

$$- m_e \left(\frac{dv}{dt}\right) = A_m + B_m v + C_m v^2 + \left(\frac{1}{2}\right) \times \rho \times A_f \times v_r^2 (a_0 + a_1 Y + a_2 Y^2 + a_3 Y^3 + a_4 Y^4) + \left(m \times g \times \frac{dh}{ds}\right)$$

▼ B

4.3.2.6. Data reduction

A three-term equation shall be generated to describe the road load force as a function of velocity, $F = A + Bv + Cv^2$, corrected to standard ambient temperature and pressure conditions, and in still air. The method for this analysis process is described in paragraphs 4.3.2.6.1. to 4.3.2.6.10. inclusive in this Sub-Annex.

▼ B

4.3.2.6.1. Determining calibration coefficients

If not previously determined, calibration factors to correct for vehicle blockage shall be determined for relative wind speed and yaw angle. Vehicle speed v , relative wind velocity v_r and yaw Y measurements during the warm-up phase of the test procedure shall be recorded. Paired runs in alternate directions on the test track at a constant velocity of 80 km/h shall be performed, and the arithmetic average values of v , v_r and Y for each run shall be determined. Calibration factors that minimise the total errors in head and cross winds over all the run pairs, i.e. the sum of $(\text{head}_i - \text{head}_{i+1})^2$, etc., shall be selected where head_i and head_{i+1} refer to wind speed and wind direction from the paired test runs in opposing directions during the vehicle warm-up/stabilization prior to testing.

4.3.2.6.2. Deriving second by second observations

From the data collected during the coastdown runs, values for v , $\left(\frac{dh}{ds}\right)\left(\frac{dv}{dt}\right)$, v_r^2 , and Y shall be determined by applying calibration factors obtained in paragraphs 4.3.2.1.3. and 4.3.2.1.4. of this Sub-Annex. Data filtering shall be used to adjust samples to a frequency of 1 Hz.

▼ M3

4.3.2.6.3. Preliminary analysis

Using a linear least squares regression technique, all data points shall be analysed at once to determine A_m , B_m , C_m , a_0 , a_1 , a_2 , a_3 and a_4 given m_e , $\left(\frac{dh}{ds}\right)$, $\left(\frac{dv}{dt}\right)$, v , v_r , and ρ .

▼ B

4.3.2.6.4. Data outliers

A predicted force $m_e\left(\frac{dv}{dt}\right)$ shall be calculated and compared to the observed data points. Data points with excessive deviations, e.g., over three standard deviations, shall be flagged.

4.3.2.6.5. Data filtering (optional)

Appropriate data filtering techniques may be applied and the remaining data points shall be smoothed out.

4.3.2.6.6. Data elimination

Data points gathered where yaw angles are greater than ± 20 degrees from the direction of vehicle travel shall be flagged. Data points gathered where relative wind is less than + 5 km/h (to avoid conditions where tailwind speed is higher than vehicle speed) shall also be flagged. Data analysis shall be restricted to vehicle speeds within the speed range selected according to paragraph 4.3.2.2. of this Sub-Annex.

▼ M3

4.3.2.6.7. Final data analysis

All data that has not been flagged shall be analysed using a linear least squares regression technique. A_m , B_m , C_m , a_0 , a_1 , a_2 , a_3 and a_4 shall be determined given m_e , $\left(\frac{dh}{ds}\right)$, $\left(\frac{dv}{dt}\right)$, v , v_r , and ρ .

▼ B

4.3.2.6.8. Constrained analysis (optional)

To better separate the vehicle aerodynamic and mechanical drag, a constrained analysis may be applied such that the vehicle's frontal area, A_f , and the drag coefficient, C_D , may be fixed if they have been previously determined.

4.3.2.6.9. Correction to reference conditions

Equations of motion shall be corrected to reference conditions as specified in paragraph 4.5. of this Sub-Annex.

4.3.2.6.10. Statistical criteria for on-board anemometry

The exclusion of each single pair of coastdown runs shall change the calculated road load for each coastdown reference speed v_j less than the convergence requirement, for all i and j :

$$\Delta F_i(v_j)/F(v_j) \leq \frac{0,03}{\sqrt{n-1}}$$

where:

$\Delta F_i(v_j)$ is the difference between the calculated road load with all coastdown runs and the calculated road load with the i^{th} pair of coastdown runs excluded, N;

$F(v_j)$ is the calculated road load with all coastdown runs included, N;

v_j is the reference speed, km/h;

n is the number of pairs of coastdown runs, all valid pairs are included.

In the case that the convergence requirement is not met, pairs shall be removed from the analysis, starting with the pair giving the highest change in calculated road load, until the convergence requirement is met, as long as a minimum of 5 valid pairs are used for the final road load determination.

4.4. Measurement and calculation of running resistance using the torque meter method

As an alternative to the coastdown methods, the torque meter method may also be used in which the running resistance is determined by measuring wheel torque on the driven wheels at the reference speed points for time periods of at least 5 seconds.

▼ M3

4.4.1. Installation of torque meter

Wheel torque meters shall be installed between the wheel hub and the wheel of each driven wheel, measuring the required torque to keep the vehicle at a constant speed.

The torque meter shall be calibrated on a regular basis, at least once a year, traceable to national or international standards, in order to meet the required accuracy and precision.

▼ B

4.4.2. Procedure and data sampling

4.4.2.1. Selection of reference speeds for running resistance curve determination

Reference speed points for running resistance determination shall be selected according to paragraph 2.2. of this Sub-Annex.

The reference speeds shall be measured in descending order. At the request of the manufacturer, there may be stabilization periods between measurements but the stabilization speed shall not exceed the speed of the next reference speed.

4.4.2.2. Data collection

Data sets consisting of actual speed v_{ji} actual torque C_{ji} and time over a period of at least 5 seconds shall be measured for every v_j at a sampling frequency of at least 10 Hz. The data sets collected over one time period for a reference speed v_j shall be referred to as one measurement.

4.4.2.3. Vehicle torque meter measurement procedure

Prior to the torque meter method test measurement, a vehicle warm-up shall be performed according to paragraph 4.2.4. of this Sub-Annex.

During test measurement, steering wheel movement shall be avoided as much as possible, and the vehicle brakes shall not be operated.

The test shall be repeated until the running resistance data satisfy the measurement precision requirements as specified in paragraph 4.4.3.2. of this Sub-Annex.

Although it is recommended that each test run be performed without interruption, split runs may be performed if data cannot be collected in a single run for all the reference speed points. For split runs, care shall be taken so that vehicle conditions remain as stable as possible at each split point

4.4.2.4. Velocity deviation

During a measurement at a single reference speed point, the velocity deviation from the arithmetic average velocity, $v_{ji}-v_{jm}$, calculated according to paragraph 4.4.3. of this Sub-Annex, shall be within the values in ► **M3** Table A4/6 ◀.

Additionally, the arithmetic average velocity v_{jm} at every reference speed point shall not deviate from the reference speed v_j by more than ± 1 km/h or 2 per cent of the reference speed v_j , whichever is greater.

▼ M3

Table A4/6

▼ B

Velocity deviation

Time period, s	Velocity deviation, km/h
5 - 10	$\pm 0,2$
10 - 15	$\pm 0,4$
15 - 20	$\pm 0,6$
20 - 25	$\pm 0,8$
25 - 30	$\pm 1,0$
≥ 30	$\pm 1,2$

▼ B

4.4.2.5. Atmospheric temperature

Tests shall be performed under the same temperature conditions as defined in paragraph 4.1.1.2. of this Sub-Annex.

4.4.3. Calculation of arithmetic average velocity and arithmetic average torque

4.4.3.1. Calculation process

Arithmetic average velocity v_{jm} , in km/h, and arithmetic average torque C_{jm} , in Nm, of each measurement shall be calculated from the data sets collected in paragraph 4.4.2.2. of this Sub-Annex using the following equations:

$$v_{jm} = \frac{1}{k} \sum_{i=1}^k v_{ji}$$

and

$$C_{jm} = \frac{1}{k} \sum_{i=1}^k C_{ji} - C_{js}$$

where:

v_{ji} is the actual vehicle speed of the i^{th} data set at reference speed point j , km/h;

k is the number of data sets in a single measurement;

C_{ji} is the actual torque of the i^{th} data set, Nm;

C_{js} is the compensation term for speed drift, Nm, given by the following equation:

$$C_{js} = (m_{st} + m_r) \times \alpha_j r_j.$$

$\frac{C_{js}}{\frac{1}{k} \sum_{i=1}^k C_{ji}}$ shall be no greater than 0,05 and may be disregarded if

α_j is not greater than $\pm 0,005 \text{ m/s}^2$;

m_{st} is the test vehicle mass at the start of the measurements and shall be measured immediately before the warm-up procedure and no earlier, kg;

m_r is the equivalent effective mass of rotating components according to paragraph 2.5.1. of this Sub-Annex, kg;

r_j is the dynamic radius of the tyre determined at a reference point of 80 km/h or at the highest reference speed point of the vehicle if this speed is lower than 80 km/h, calculated according to the following equation:

$$r_j = \frac{1}{3,6} \times \frac{v_{jm}}{2 \times \pi n}$$

▼ B

where:

n is the rotational frequency of the driven tyre, s^{-1} ;

α_j is the arithmetic average acceleration, m/s^2 , which calculated using the following equation:

$$\alpha_j = \frac{1}{3,6} \times \frac{k \sum_{i=1}^k t_i v_{ji} - \sum_{i=1}^k t_i \sum_{i=1}^k v_{ji}}{k \times \sum_{i=1}^k t_i^2 - [\sum_{i=1}^k t_i]^2}$$

where:

t_i is the time at which the i^{th} data set was sampled, s.

4.4.3.2. Measurement precision

The measurements shall be carried out in opposite directions until a minimum of three pairs of measurements at each reference speed v_i have been obtained, for which \bar{C}_j satisfies the precision ρ_j according to the following equation:

$$\rho_j = \frac{h \times s}{\sqrt{n} \times \bar{C}_j} \leq 0.03$$

where:

n is the number pairs of measurements for C_{jm} ;

\bar{C}_j is the running resistance at the speed v_j , Nm, given by the equation:

$$\bar{C}_j = \frac{1}{n} \sum_{i=1}^n C_{jmi}$$

where:

C_{jmi} is the arithmetic average torque of the i^{th} pair of measurements at speed v_j , Nm, and given by:

$$C_{jmi} = \frac{1}{2} \times (C_{jmai} + C_{jmibi})$$

where:

C_{jmai} and C_{jmibi} are the arithmetic average torques of the i^{th} measurement at speed v_j determined in paragraph 4.4.3.1. of this Sub-Annex for each direction, a and b respectively, Nm;

s is the standard deviation, Nm, calculated using the following equation:

$$s = \sqrt{\frac{1}{k-1} \sum_{i=1}^k (C_{jmi} - \bar{C}_j)^2};$$

▼ M3

h is a coefficient as a function of n as given in Table A4/4 in paragraph 4.3.1.4.2. of this Sub-Annex.

▼ B

4.4.4. Running resistance curve determination

▼ M3

The arithmetic average speed and arithmetic average torque at each reference speed point shall be calculated using the following equations:

▼ B

$$V_{jm} = \frac{1}{2} \times (v_{jma} + v_{jmb})$$

$$C_{jm} = \frac{1}{2} \times (C_{jma} + C_{jmb})$$

The following least squares regression curve of arithmetic average running resistance shall be fitted to all the data pairs (v_{jm}, C_{jm}) at all reference speeds described in paragraph 4.4.2.1. of this Sub-Annex to determine the coefficients c_0 , c_1 and c_2 .

The coefficients, c_0 , c_1 and c_2 , and as well as the coastdown times measured on the chassis dynamometer (see paragraph 8.2.4. of this Sub-Annex) shall be included in all relevant test sheets.

In the case that the tested vehicle is the representative vehicle of a road load matrix family, the coefficient c_1 shall be set to zero and the coefficients c_0 and c_2 shall be recalculated with a least squares regression analysis.

4.5. Correction to reference conditions and measurement equipment

4.5.1. Air resistance correction factor

The correction factor for air resistance K_2 shall be determined using the following equation:

$$K_2 = \frac{T}{293 \text{ K}} \times \frac{100 \text{ kPa}}{P}$$

where:

T is the arithmetic average atmospheric temperature of all individual runs, Kelvin (K);

P is the arithmetic average atmospheric pressure, kPa.

4.5.2. Rolling resistance correction factor

The correction factor for rolling resistance, in Kelvin⁻¹ (K⁻¹), may be determined based on empirical data and approved by the approval authority for the particular vehicle and tyre test, or may be assumed to be as follows:

$$K_0 = 8,6 \times 10^{-3} \text{ K}^{-1}$$

4.5.3. Wind correction

4.5.3.1. Wind correction with stationary anemometry

▼ M3

4.5.3.1.1. A wind correction for the absolute wind speed alongside the test road shall be made by subtracting the difference that cannot be cancelled out by alternate runs from the coefficient f_0 determined in accordance with paragraph 4.3.1.4.4., or from c_0 determined in accordance with paragraph 4.4.4.

▼ B

4.5.3.1.2. The wind correction resistance w_1 for the coastdown method or w_2 for the torque meter method shall be calculated by the equations:

$$w_1 = 3,6^2 \times f_2 \times v_w^2$$

$$\text{or : } w_2 = 3,6^2 \times c_2 \times v_w^2$$

where:

w_1 is the wind correction resistance for the coastdown method, N;

f_2 is the coefficient of the aerodynamic term determined in paragraph 4.3.1.4.4. of this Sub-Annex;

v_w is the lower arithmetic average wind speed of opposite directions alongside the test road during the test, m/s;

w_2 is the wind correction resistance for the torque meter method, Nm;

c_2 is the coefficient of the aerodynamic term for the torque meter method determined in paragraph 4.4.4. of this Sub-Annex.

4.5.3.2. Wind correction with on-board anemometry

In the case that the coastdown method is based on on-board anemometry, w_1 and w_2 in the equations in paragraph 4.5.3.1.2. shall be set to zero, as the wind correction is already applied according to paragraph 4.3.2. of this Sub-Annex.

4.5.4. Test mass correction factor

The correction factor K_1 for the test mass of the test vehicle shall be determined using the following equation:

$$K_1 = f_0 \times \left(1 - \frac{TM}{m_{av}}\right)$$

where:

f_0 is a constant term, N;

TM is the test mass of the test vehicle, kg;

▼ M3

m_{av} is the arithmetic average of the test vehicle masses at the beginning and end of road load determination, kg.

▼ B

4.5.5. Road load curve correction

4.5.5.1. The curve determined in paragraph 4.3.1.4.4. of this Sub-Annex shall be corrected to reference conditions as follows:

$$F^* = ((f_0 - w_1 - K_1) + f_1 v) \times (1 + K_0(T - 20)) + K_2 f_2 v^2$$

▼ B

where:

F^* is the corrected road load, N;

f_0 is the constant term, N;

▼ M3

f_1 is the coefficient of the first order term, N/(km/h);

f_2 is the coefficient of the second order term, N/(km/h)²;

▼ B

K_0 is the correction factor for rolling resistance as defined in paragraph 4.5.2. of this Sub-Annex;

K_1 is the test mass correction as defined in paragraph 4.5.4. of this Sub-Annex;

K_2 is the correction factor for air resistance as defined in paragraph 4.5.1. of this Sub-Annex;

T is the arithmetic average ambient atmospheric temperature, °C;

v is vehicle velocity, km/h;

w_1 is the wind resistance correction as defined in paragraph 4.5.3. of this Sub-Annex, N.

The result of the calculation $((f_0 - w_1 - K_1) \times (1 + K_0 \times (T-20)))$ shall be used as the target road load coefficient A_t in the calculation of the chassis dynamometer load setting described in paragraph 8.1. of this Sub-Annex.

The result of the calculation $(f_1 \times (1 + K_0 \times (T-20)))$ shall be used as the target road load coefficient B_t in the calculation of the chassis dynamometer load setting described in paragraph 8.1. of this Sub-Annex.

The result of the calculation $(K_2 \times f_2)$ shall be used as the target road load coefficient C_t in the calculation of the chassis dynamometer load setting described in paragraph 8.1. of this Sub-Annex.

4.5.5.2. The curve determined in paragraph 4.4.4. of this Sub-Annex shall be corrected to reference conditions and measurement equipment installed according to the following procedure.

4.5.5.2.1. Correction to reference conditions

$$C^* = ((c_0 - w_2 - K_1) + c_1 v) \times (1 + K_0(T - 20)) + K_2 c_2 v^2$$

where:

C^* is the corrected running resistance, Nm;

c_0 is the constant term as determined in paragraph 4.4.4. of this Sub-Annex, Nm;

▼M3

- c_1 is the coefficient of the first order term as determined in paragraph 4.4.4., Nm/(km/h);
- c_2 is the coefficient of the second order term as determined in paragraph 4.4.4., Nm/(km/h)²;

▼B

- K_0 is the correction factor for rolling resistance as defined in paragraph 4.5.2. of this Sub-Annex;
- K_1 is the test mass correction as defined in paragraph 4.5.4. of this Sub-Annex;
- K_2 is the correction factor for air resistance as defined in paragraph 4.5.1. of this Sub-Annex;
- v is the vehicle velocity, km/h;
- T is the arithmetic average atmospheric temperature, °C;
- w_2 is the wind correction resistance as defined in paragraph 4.5.3. of this Sub-Annex.

4.5.5.2.2. Correction for installed torque meters

If the running resistance is determined according to the torque meter method, the running resistance shall be corrected for effects of the torque measurement equipment installed outside the vehicle on its aerodynamic characteristics.

The running resistance coefficient c_2 shall be corrected according to the following equation:

$$c_{2\text{corr}} = K_2 \times c_2 \times (1 + (\Delta(C_D \times A_f)) / (C_{D'} \times A_{f'}))$$

where,

$$\Delta(C_D \times A_f) = (C_D \times A_f) - (C_{D'} \times A_{f'})$$

$C_{D'} \times A_{f'}$ is the product of the aerodynamic drag coefficient multiplied by the frontal area of the vehicle with the torque meter measurement equipment installed measured in a wind tunnel fulfilling the criteria of paragraph 3.2. of this Sub-Annex, m²;

$C_D \times A_f$ is the product of the aerodynamic drag coefficient multiplied by the frontal area of the vehicle with the torque meter measurement equipment not installed measured in a wind tunnel fulfilling the criteria of paragraph 3.2. of this Sub-Annex, m².

4.5.5.2.3. Target running resistance coefficients

The result of the calculation $((c_0 - w_2 - K_1) \times (1 + K_0 \times (T-20)))$ shall be used as the target running resistance coefficient a_t in the calculation of the chassis dynamometer load setting described in paragraph 8.2. of this Sub-Annex.

The result of the calculation $(c_1 \times (1 + K_0 \times (T-20)))$ shall be used as the target running resistance coefficient b_t in the calculation of the chassis dynamometer load setting described in paragraph 8.2. of this Sub-Annex.

▼ B

The result of the calculation ($c_{2\text{corr}} \times r$) shall be used as the target running resistance coefficient c_t in the calculation of the chassis dynamometer load setting described in paragraph 8.2. of this Sub-Annex.

5. Method for the calculation of road load or running resistance based on vehicle parameters

5.1. Calculation of road load and running resistance for vehicles based on a representative vehicle of a road load matrix family

If the road load of the representative vehicle is determined according to a method described in paragraph 4.3. of this Sub-Annex, the road load of an individual vehicle shall be calculated according to paragraph 5.1.1. of this Sub-Annex.

If the running resistance of the representative vehicle is determined according to the method described in paragraph 4.4. of this Sub-Annex, the running resistance of an individual vehicle shall be calculated according to paragraph 5.1.2. of this Sub-Annex.

5.1.1. For the calculation of the road load of vehicles of a road load matrix family, the vehicle parameters described in paragraph 4.2.1.4. of this Sub-Annex and the road load coefficients of the representative test vehicle determined in paragraphs 4.3. of this Sub-Annex shall be used.

▼ M3

5.1.1.1. The road load force for an individual vehicle shall be calculated using the following equation:

$$F_c = f_0 + (f_1 \times v) + (f_2 \times v^2)$$

where:

F_c is the calculated road load force as a function of vehicle velocity, N;

f_0 is the constant road load coefficient, N, defined by the equation:

$$f_0 = \text{Max} \left(\left(0,05 \times f_{0r} + 0,95 \times \left(f_{0r} \times \text{TM}/\text{TM}_r + \left(\frac{\text{RR} - \text{RR}_r}{1\,000} \right) \times 9,81 \times \text{TM} \right) \right); \right. \\ \left. \left(0,2 \times f_{0r} + 0,8 \times \left(f_{0r} \times \text{TM}/\text{TM}_r + \left(\frac{\text{RR} - \text{RR}_r}{1\,000} \right) \times 9,81 \times \text{TM} \right) \right) \right)$$

f_{0r} is the constant road load coefficient of the representative vehicle of the road load matrix family, N;

f_1 is the first order road load coefficient, N/(km/h), and shall be set to zero;

f_2 is the second order road load coefficient, N/(km/h)², defined by the equation:

$$f_2 = \text{Max} \left((0,05 \times f_{2r} + 0,95 \times f_{2r} \times A_f/A_{fr}); (0,2 \times f_{2r} + 0,8 \times f_{2r} \times A_f/A_{fr}) \right)$$

f_{2r} is the second order road load coefficient of the representative vehicle of the road load matrix family, N/(km/h)²;

▼ M3

v is the vehicle speed, km/h;

TM is the actual test mass of the individual vehicle of the road load matrix family, kg;

TM_r is the test mass of the representative vehicle of the road load matrix family, kg;

A_f is the frontal area of the individual vehicle of the road load matrix family, m^2 ,

A_{fr} is the frontal area of the representative vehicle of the road load matrix family, m^2 ;

RR is the tyre rolling resistance of the individual vehicle of the road load matrix family, kg/tonne;

RR_r is the tyre rolling resistance of the representative vehicle of the road load matrix family, kg/tonne.

For the tyres fitted to an individual vehicle, the value of the rolling resistance RR shall be set to the class value of the applicable tyre energy efficiency class in accordance with Table A4/2.

If the tyres on the front and rear axles belong to different energy efficiency classes, the weighted mean shall be used, calculated using the equation in paragraph 3.2.3.2.2.2. of Sub-Annex 7.

If the same tyres were fitted to test vehicles L and H, the value of RR_{ind} when using the interpolation method shall be set to RR_H .

▼ B

- 5.1.2. For the calculation of the running resistance of vehicles of a road load matrix family, the vehicle parameters described in paragraph 4.2.1.4. of this Sub-Annex and the running resistance coefficients of the representative test vehicle determined in paragraphs 4.4. of this Sub-Annex shall be used.

▼ M3

- 5.1.2.1. The running resistance for an individual vehicle shall be calculated using the following equation:

$$C_c = c_0 + c_1 \times v + c_2 \times v^2$$

where:

C_c is the calculated running resistance as a function of vehicle velocity, Nm;

c_0 is the constant running resistance coefficient, Nm, defined by the equation:

$$c_0 = \frac{r'/1,02 \times \text{Max} \left(\left(0,05 \times 1,02 \times c_{0r}/r' + 0,95 \times \left(1,02 \times c_{0r}/r' \times TM/TM_r + \left(\frac{RR - RR_r}{1\,000} \right) \times 9,81 \times TM \right) \right); \right.}{\left. \left(0,2 \times 1,02 \times c_{0r}/r' + 0,8 \times \left(1,02 \times c_{0r}/r' \times TM/TM_r + \left(\frac{RR - RR_r}{1\,000} \right) \times 9,81 \times TM \right) \right) \right)}$$

c_{0r} is the constant running resistance coefficient of the representative vehicle of the road load matrix family, Nm;

c_1 is the first order road load coefficient, Nm/(km/h), and shall be set to zero;

▼ M3

c_2 is the second order running resistance coefficient, $\text{Nm}/(\text{km}/\text{h})^2$, defined by the equation:

$$c_2 = r'/1,02 \times \text{Max}((0,05 \times 1,02 \times c_{2r}/r' + 0,95 \times 1,02 \times c_{2r}/r' \times A_f/A_{fr}); (0,2 \times 1,02 \times c_{2r}/r' + 0,8 \times 1,02 \times c_{2r}/r' \times A_f/A_{fr}))$$

c_{2r} is the second order running resistance coefficient of the representative vehicle of the road load matrix family, $\text{N}/(\text{km}/\text{h})^2$;

v is the vehicle speed, km/h ;

TM is the actual test mass of the individual vehicle of the road load matrix family, kg ;

TM_r is the test mass of the representative vehicle of the road load matrix family, kg ;

A_f is the frontal area of the individual vehicle of the road load matrix family, m^2 ;

A_{fr} is the frontal area of the representative vehicle of the road load matrix family, m^2 ;

RR is the tyre rolling resistance of the individual vehicle of the road load matrix family, kg/tonne ;

RR_r is the tyre rolling resistance of the representative vehicle of the road load matrix family, kg/tonne ;

r' is the dynamic radius of the tyre on the chassis dynamometer obtained at $80 \text{ km}/\text{h}$, m ;

$1,02$ is an approximate coefficient compensating for drivetrain losses.

▼ B

5.2. Calculation of the default road load based on vehicle parameters

5.2.1. As an alternative for determining road load with the coastdown or torque meter method, a calculation method for default road load may be used.

For the calculation of a default road load based on vehicle parameters, several parameters such as test mass, width and height of the vehicle shall be used. The default road load F_c shall be calculated for the reference speed points.

5.2.2. The default road load force shall be calculated using the following equation:

$$F_c = f_0 + f_1 \times v + f_2 \times v^2$$

where:

F_c is the calculated default road load force as a function of vehicle velocity, N ;

▼ B

f_0 is the constant road load coefficient, N, defined by the following equation:

$$f_0 = 0,140 \times TM;$$

▼ M3

f_1 is the first order road load coefficient, N/(km/h), and shall be set to zero;

f_2 is the second order road load coefficient, N/(km/h)², determined using the following equation:

$$f_2 = (2,8 \times 10^{-6} \times TM) + (0,0170 \times \text{width} \times \text{height});$$

▼ B

v is vehicle velocity, km/h;

TM test mass, kg;

width vehicle width as defined in 6.2. of Standard ISO 612:1978, m;

height vehicle height as defined in 6.3. of Standard ISO 612:1978, m.

6. Wind tunnel method

The wind tunnel method is a road load measurement method using a combination of a wind tunnel and a chassis dynamometer or of a wind tunnel and a flat belt dynamometer. The test benches may be separate facilities or integrated with one another.

6.1. Measurement method

6.1.1. The road load shall be determined by:

- (a) adding the road load forces measured in a wind tunnel and those measured using a flat belt dynamometer; or
- (b) adding the road load forces measured in a wind tunnel and those measured on a chassis dynamometer.

6.1.2. Aerodynamic drag shall be measured in the wind tunnel.

6.1.3. Rolling resistance and drivetrain losses shall be measured using a flat belt or a chassis dynamometer, measuring the front and rear axles simultaneously.

6.2. Approval of the facilities by the approval authority

The results of the wind tunnel method shall be compared to those obtained using the coastdown method to demonstrate qualification of the facilities and included in all relevant test reports.

6.2.1. Three vehicles shall be selected by the approval authority. The vehicles shall cover the range of vehicles (e.g. size, weight) planned to be measured with the facilities concerned.

6.2.2. Two separate coastdown tests shall be performed with each of the three vehicles according to paragraph 4.3. of this Sub-Annex, and the resulting road load coefficients, f_0 , f_1 and f_2 , shall be determined according to that paragraph and corrected according to paragraph 4.5.5. of this Sub-Annex. The coastdown test result of a test vehicle shall be the arithmetic average of the road load coefficients of its

▼ B

two separate coastdown tests. If more than two coastdown tests are necessary to fulfil the approval of facilities' criteria, all valid tests shall be averaged.

- 6.2.3. Measurement with the wind tunnel method according to paragraphs 6.3. to 6.7. inclusive of this Sub-Annex shall be performed on the same three vehicles as selected in paragraph 6.2.1. of this Sub-Annex and in the same conditions, and the resulting road load coefficients, f_0 , f_1 and f_2 , shall be determined.

If the manufacturer chooses to use one or more of the available alternative procedures within the wind tunnel method (i.e. paragraph 6.5.2.1. on preconditioning, paragraphs 6.5.2.2. and 6.5.2.3. on the procedure, and paragraph 6.5.2.3.3. on dynamometer setting), these procedures shall also be used also for the approval of the facilities.

- 6.2.4. Approval criteria

The facility or combination of facilities used shall be approved if both of the following two criteria are fulfilled:

- (a) The difference in cycle energy, expressed as ε_k , between the wind tunnel method and the coastdown method shall be within $\pm 0,05$ for each of the three vehicles k according to the following equation:

$$\varepsilon_k = \frac{E_{k,WTM}}{E_{k,coastdown}} - 1$$

where:

ε_k is the difference in cycle energy over a complete Class 3 WLTC for vehicle k between the wind tunnel method and the coastdown method, per cent;

$E_{k, WTM}$ is the cycle energy over a complete Class 3 WLTC for vehicle k , calculated with the road load derived from the wind tunnel method (WTM) calculated according to paragraph 5 of Sub-Annex 7, J;

$E_{k, coastdown}$ is the cycle energy over a complete Class 3 WLTC for vehicle k , calculated with the road load derived from the coastdown method calculated according to paragraph 5. of Sub-Annex 7, J.; and

- (b) The arithmetic average \bar{x} of the three differences shall be within 0,02.

$$\bar{x} = \left| \frac{\varepsilon_1 + \varepsilon_2 + \varepsilon_3}{3} \right|$$

▼ M3

The approval shall be recorded by the approval authority including measurement data and the facilities concerned.

▼ B

The facility may be used for road load determination for a maximum of two years after the approval has been granted.

▼ B

Each combination of roller chassis dynamometer or moving belt and wind tunnel shall be approved separately.

6.3. Vehicle preparation and temperature

Conditioning and preparation of the vehicle shall be performed according to paragraphs 4.2.1. and 4.2.2. of this Sub-Annex and applies to both the flat belt or roller chassis dynamometers and the wind tunnel measurements.

In the case that the alternative warm-up procedure described in paragraph 6.5.2.1. is applied, the target test mass adjustment, the weighing of the vehicle and the measurement shall all be performed without the driver in the vehicle.

The flat belt or the chassis dynamometer test cells shall have a temperature set point of 20 °C with a tolerance of ± 3 °C. At the request of the manufacturer, the set point may also be 23 °C with a tolerance of ± 3 °C.

6.4. Wind tunnel procedure

6.4.1. Wind tunnel criteria

▼ M3

The wind tunnel design, test methods and the corrections shall provide a value of $(C_D \times A_f)$ representative of the on-road $(C_D \times A_f)$ value and with a precision of $\pm 0,015$ m².

▼ B

For all $(C_D \times A_f)$ measurements, the wind tunnel criteria listed in paragraph 3.2. of this Sub-Annex shall be met with the following modifications:

- (a) The solid blockage ratio described in paragraph 3.2.4. of this Sub-Annex shall be less than 25 per cent;
- (b) The belt surface contacting any tyre shall exceed the length of that tyre's contact area by at least 20 per cent and shall be at least as wide as that contact patch;
- (c) The standard deviation of total air pressure at the nozzle outlet described in paragraph 3.2.8. of this Sub-Annex shall be less than 1 per cent;
- (d) The restraint system blockage ratio described in paragraph 3.2.10. of this Sub-Annex shall be less than 3 per cent.

6.4.2. Wind tunnel measurement

The vehicle shall be in the condition described in paragraph 6.3. of this Sub-Annex.

▼ M3

The vehicle shall be placed parallel to the longitudinal centre line of the tunnel with a maximum tolerance of ± 10 mm.

The vehicle shall be placed with a yaw angle of 0° within a tolerance of $\pm 0,1^\circ$.

▼ B

Aerodynamic drag shall be measured for at least for 60 seconds and at a minimum frequency of 5 Hz. Alternatively, the drag may be measured at a minimum frequency of 1 Hz and with at least 300 subsequent samples. The result shall be the arithmetic average of the drag.

▼B

In the case that the vehicle has movable aerodynamic body parts, paragraph 4.2.1.5. of this Sub-Annex shall apply. Where movable parts are velocity-dependent, every applicable position shall be measured in the wind tunnel and evidence shall be provided to the approval authority indicating the relationship between reference speed, movable part position, and the corresponding ($C_D \times A_f$).

6.5. Flat belt applied for the wind tunnel method

6.5.1. Flat belt criteria

6.5.1.1. Description of the flat belt test bench

The wheels shall rotate on flat belts that do not change the rolling characteristics of the wheels compared to those on the road. The measured forces in the x-direction shall include the frictional forces in the drivetrain.

6.5.1.2. Vehicle restraint system

The dynamometer shall be equipped with a centring device aligning the vehicle within a tolerance of ± 0.5 degrees of rotation around the z-axis. The restraint system shall maintain the centred drive wheel position throughout the coastdown runs of the road load determination within the following limits:

6.5.1.2.1. Lateral position (y-axis)

The vehicle shall remain aligned in the y-direction and lateral movement shall be minimised.

6.5.1.2.2. Front and rear position (x-axis)

Without prejudice to the requirement of paragraph 6.5.1.2.1. of this Sub-Annex, both wheel axes shall be within ± 10 mm of the belt's lateral centre lines.

6.5.1.2.3. Vertical force

The restraint system shall be designed so as to impose no vertical force on the drive wheels.

6.5.1.3. Accuracy of measured forces

Only the reaction force for turning the wheels shall be measured. No external forces shall be included in the result (e.g. force of the cooling fan air, vehicle restraints, aerodynamic reaction forces of the flat belt, dynamometer losses, etc.).

The force in the x-direction shall be measured with an accuracy of ± 5 N.

6.5.1.4. Flat belt speed control

The belt speed shall be controlled with an accuracy of $\pm 0,1$ km/h.

6.5.1.5. Flat belt surface

The flat belt surface shall be clean, dry and free from foreign material that might cause tyre slippage.

▼M3

6.5.1.6. Cooling

A current of air of variable speed shall be blown towards the vehicle. The set point of the linear velocity of the air at the blower outlet shall be equal to the corresponding dynamometer speed above measurement speeds of 5 km/h. The linear velocity of the air at the blower outlet shall be within ± 5 km/h or ± 10 per cent of the corresponding measurement speed, whichever is greater.

▼B

6.5.2. Flat belt measurement

The measurement procedure may be performed according to either paragraph 6.5.2.2. or paragraph 6.5.2.3. of this Sub-Annex.

6.5.2.1. Preconditioning

The vehicle shall be conditioned on the dynamometer as described in paragraphs 4.2.4.1.1. to 4.2.4.1.3. inclusive of this Sub-Annex.

The dynamometer load setting F_d , for the preconditioning shall be:

$$F_d = a_d + b_d \times v + c_d \times v^2$$

where:

$$a_d = 0$$

$$b_d = 0;$$

$$c_d = (C_D \times A_f) \times \frac{\rho_0}{2} \times \frac{1}{3,6^2}$$

The equivalent inertia of the dynamometer shall be the test mass.

The aerodynamic drag used for the load setting shall be taken from paragraph 6.7.2. of this Sub-Annex and may be set directly as input. Otherwise, a_d , b_d , and c_d from this paragraph shall be used.

At the request of the manufacturer, as an alternative to paragraph 4.2.4.1.2. of this Sub-Annex, the warm-up may be conducted by driving the vehicle with the flat belt.

In this case, the warm-up speed shall be 110 per cent of the maximum speed of the applicable WLTC and the duration shall exceed 1 200 seconds until the change of measured force over a period of 200 seconds is less than 5 N.

6.5.2.2. Measurement procedure with stabilised speeds

6.5.2.2.1. The test shall be conducted from the highest to the lowest reference speed point.

6.5.2.2.2. Immediately after the measurement at the previous speed point, the deceleration from the current to the next applicable reference speed point shall be performed in a smooth transition of approximately 1 m/s^2 .

6.5.2.2.3. The reference speed shall be stabilised for at least 4 seconds and for a maximum of 10 seconds. The measurement equipment shall ensure that the signal of the measured force is stabilised after that period.

▼ B

- 6.5.2.2.4. The force at each reference speed shall be measured for at least 6 seconds while the vehicle speed is kept constant. The resulting force for that reference speed point $F_{jD_{\text{Dyno}}}$ shall be the arithmetic average of the force during the measurement.

The steps in paragraphs 6.5.2.2.2. to 6.5.2.2.4. of this Sub-Annex inclusive shall be repeated for each reference speed.

- 6.5.2.3. Measurement procedure by deceleration
- 6.5.2.3.1. Preconditioning and dynamometer setting shall be performed according to paragraph 6.5.2.1. of this Sub-Annex. Prior to each coastdown, the vehicle shall be driven at the highest reference speed or, in the case that the alternative warm-up procedure is used at 110 per cent of the highest reference speed, for at least 1 minute. The vehicle shall be subsequently accelerated to at least 10 km/h above the highest reference speed and the coastdown shall be started immediately.
- 6.5.2.3.2. **► M3** The measurement shall be performed according to paragraphs 4.3.1.3.1. to 4.3.1.4.4. inclusive of this Sub-Annex. If coasting down in opposite directions is not possible then the equation used to calculate Δt_j in paragraph 4.3.1.4.2. of this Sub-Annex shall not apply. The measurement shall be stopped after two decelerations if the force of both coastdowns at each reference speed point is within ± 10 N, otherwise at least three coastdowns shall be performed using the criteria set out in paragraph 4.3.1.4.2. of this Sub-Annex. ◀
- 6.5.2.3.3. The force $f_{jD_{\text{Dyno}}}$ at each reference speed v_j shall be calculated by removing the simulated aerodynamic force:

$$f_{jD_{\text{Dyno}}} = f_{j\text{Decel}} - c_d \times v_j^2$$

where:

$f_{j\text{Decel}}$ is the force determined according to the equation calculating F_j in paragraph 4.3.1.4.4. of this Sub-Annex at reference speed point j , N;

c_d is the dynamometer set coefficient as defined in paragraph 6.5.2.1. of this Sub-Annex, $\text{N}/(\text{km/h})^2$.

Alternatively, at the request of the manufacturer, c_d may be set to zero during the coastdown and for calculating $f_{jD_{\text{Dyno}}}$.

- 6.5.2.4. Measurement conditions
- The vehicle shall be in the condition described in paragraph 4.3.1.3.2. of this Sub-Annex.

▼ M3**▼ B**

- 6.5.3. Measurement result of the flat belt method
- The result of the flat belt dynamometer $f_{jD_{\text{Dyno}}}$ shall be referred to as f_j for the further calculations in paragraph 6.7. of this Sub-Annex.

▼ B

6.6. Chassis dynamometer applied for the wind tunnel method

6.6.1. Criteria

In addition to the descriptions in paragraphs 1. and 2. of Sub-Annex 5, the criteria described in paragraphs 6.6.1.1. to 6.6.1.6. inclusive of this Sub-Annex shall apply.

▼ M3

6.6.1.1. Description of a chassis dynamometer

The front and rear axles shall be equipped with a single roller with a diameter of not less than 1,2 metres.

▼ B

6.6.1.2. Vehicle restraint system

The dynamometer shall be equipped with a centring device aligning the vehicle. The restraint system shall maintain the centred drive wheel position within the following recommended limits throughout the coastdown runs of the road load determination:

6.6.1.2.1. Vehicle position

The vehicle to be tested shall be installed on the chassis dynamometer roller as defined in paragraph 7.3.3. of this Sub-Annex.

6.6.1.2.2. Vertical force

The restraint system shall fulfil the requirements of paragraph 6.5.1.2.3. of this Sub-Annex.

6.6.1.3. Accuracy of measured forces

The accuracy of measured forces shall be as described in paragraph 6.5.1.3. of this Sub-Annex apart from the force in the x-direction that shall be measured with an accuracy as described in paragraph 2.4.1. of Sub-Annex 5.

6.6.1.4. Dynamometer speed control

The roller speeds shall be controlled with an accuracy of $\pm 0,2$ km/h.

▼ M3

6.6.1.5. Roller surface

The roller surface shall be clean, dry and free from foreign material that might cause tyre slippage.

▼ B

6.6.1.6. Cooling

The cooling fan shall be as described in paragraph 6.5.1.6. of this Sub-Annex.

6.6.2. Dynamometer measurement

The measurement shall be performed as described in paragraph 6.5.2. of this Sub-Annex.

▼ M3

6.6.3. Correcting measured chassis dynamometer forces to those on a flat surface

The measured forces on the chassis dynamometer shall be corrected to a reference equivalent to the road (flat surface) and the result shall be referred to as f_j .

▼ M3

$$f_j = f_{jD_{\text{dyno}}} \times c1 \times \sqrt{\frac{1}{\frac{R_{\text{Wheel}}}{R_{D_{\text{dyno}}}} \times c2 + 1}} + f_{jD_{\text{dyno}}} \times (1 - c1)$$

where:

- c1 is the tyre rolling resistance fraction of $f_{jD_{\text{dyno}}}$;
- c2 is a chassis dynamometer-specific radius correction factor;
- $f_{jD_{\text{dyno}}}$ is the force calculated in paragraph 6.5.2.3.3. for each reference speed j , N;
- R_{Wheel} is one-half of the nominal design tyre diameter, m;
- $R_{D_{\text{dyno}}}$ is the radius of the chassis dynamometer roller, m.

The manufacturer and the approval authority shall agree on the factors $c1$ and $c2$ to be used, based on correlation test evidence provided by the manufacturer for the range of tyre characteristics intended to be tested on the chassis dynamometer.

As an alternative the following conservative equation may be used:

$$f_j = f_{jD_{\text{dyno}}} \times \sqrt{\frac{1}{\frac{R_{\text{Wheel}}}{R_{D_{\text{dyno}}}} \times 0,2 + 1}}$$

$C2$ shall be 0,2 except that 2,0 shall be used if the road load delta method (see paragraph 6.8.) is used and the road load delta calculated in accordance with paragraph 6.8.1. is negative.

▼ B

- 6.7. Calculations
- 6.7.1. Correction of the flat belt and chassis dynamometer results

The measured forces determined in paragraphs 6.5. and 6.6. of this Sub-Annex shall be corrected to reference conditions using the following equation:

$$F_{Dj} = (f_j - K_1) \times (1 + K_0(T - 293))$$

where:

- F_{Dj} is the corrected resistance measured at the flat belt or chassis dynamometer at reference speed j , N;
- f_j is the measured force at reference speed j , N;
- K_0 is the correction factor for rolling resistance as defined in paragraph 4.5.2. of this Sub-Annex, K^{-1} ;
- K_1 is the test mass correction as defined in paragraph 4.5.4. of this Sub-Annex, N;
- T is the arithmetic average temperature in the test cell during the measurement, K.

▼ B

6.7.2. Calculation of the aerodynamic force

The aerodynamic drag shall be calculated using the equation below. If the vehicle is equipped with velocity-dependent movable aerodynamic body parts, the corresponding ($C_D \times A_f$) values shall be applied for the concerned reference speed points.

$$F_{Aj} = (C_D \times A_f)_j \times \frac{\rho_0}{2} \times \frac{v_j^2}{3,6^2}$$

where:

F_{Aj} is the aerodynamic drag measured in the wind tunnel at reference speed j , N;

$(C_D \times A_f)_j$ is the product of the drag coefficient and frontal area at a certain reference speed point j , where applicable, m^2 ;

ρ_0 is the dry air density defined in paragraph 3.2.10. of this Annex, kg/m^3 ;

v_j is the reference speed j , km/h.

6.7.3. Calculation of road load values

The total road load as a sum of the results of paragraphs 6.7.1 and 6.7.2. of this Sub-Annex shall be calculated using the following equation:

$$F_j^* = F_{Dj} + F_{Aj}$$

for all applicable reference speed points j , N;

For all calculated F_j^* , the coefficients f_0 , f_1 and f_2 in the road load equation shall be calculated with a least squares regression analysis and shall be used as the target coefficients in paragraph 8.1.1. of this Sub-Annex.

In the case that the vehicle(s) tested according to the wind tunnel method is (are) representative of a road load matrix family vehicle, the coefficient f_1 shall be set to zero and the coefficients f_0 and f_2 shall be recalculated with a least squares regression analysis.

▼ M3

6.8. Road load delta method

For the purpose of including options when using the interpolation method which are not incorporated in the road load interpolation (i.e. aerodynamics, rolling resistance and mass), a delta in vehicle friction may be measured by the road load delta method (e.g. friction difference between brake systems). The following steps shall be performed:

- (a) The friction of reference vehicle R shall be measured;
- (b) The friction of the vehicle with the option (vehicle N) causing the difference in friction shall be measured;
- (c) The difference shall be calculated in accordance with paragraph 6.8.1.

These measurements shall be performed on a flat belt in accordance with paragraph 6.5. or on a chassis dynamometer in accordance with paragraph 6.6., and the correction of the results (excluding aerodynamic force) calculated in accordance with paragraph 6.7.1.

▼ **M3**

The application of this method is permitted only if the following criterion is fulfilled:

$$\left| \frac{1}{n} \sum_{j=1}^n (F_{Dj,R} - F_{Dj,N}) \right| \leq 25N$$

where:

$F_{Dj,R}$ is the corrected resistance of vehicle R measured on the flat belt or chassis dynamometer at reference speed j calculated in accordance with paragraph 6.7.1., N;

$F_{Dj,N}$ is the corrected resistance of vehicle N measured on the flat belt or chassis dynamometer at reference speed j calculated in accordance with paragraph 6.7.1., N;

n is the total number of speed points.

This alternative road load determination method may only be applied if vehicles R and N have identical aerodynamic resistance and if the measured delta appropriately covers the entire influence on the vehicle's energy consumption. This method shall not be applied if the overall accuracy of the absolute road load of vehicle N is compromised in any way.

6.8.1. Determination of delta flat belt or chassis dynamometer coefficients

The delta road load shall be calculated using the following equation:

$$F_{Dj,Delta} = F_{Dj,N} - F_{Dj,R}$$

where:

$F_{Dj,Delta}$ is the delta road load at reference speed j, N;

$F_{Dj,N}$ is the corrected resistance measured on the flat belt or chassis dynamometer at reference speed j calculated in accordance with paragraph 6.7.1. for vehicle N, N;

$F_{Dj,R}$ is the corrected resistance of the reference vehicle measured on the flat belt or chassis dynamometer at reference speed j calculated in accordance with paragraph 6.7.1. for reference vehicle R, N.

For all calculated $F_{Dj,Delta}$, the coefficients $f_{0,Delta}$, $f_{1,Delta}$ and $f_{2,Delta}$ in the road load equation shall be calculated with a least squares regression analysis.

6.8.2. Determination of total road load

If the interpolation method (see paragraph 3.2.3.2. of Sub-Annex 7) is not used, the road load delta method for vehicle N shall be calculated in accordance with the following equations:

$$f_{0,N} = f_{0,R} + f_{0,Delta}$$

$$f_{1,N} = f_{1,R} + f_{1,Delta}$$

$$f_{2,N} = f_{2,R} + f_{2,Delta}$$

▼ M3

where:

N refers to the road load coefficients of vehicle N;

R refers to the road load coefficients of reference vehicle R;

Delta refers to the delta road load coefficients determined in paragraph 6.8.1.

▼ B

7. Transferring road load to a chassis dynamometer

7.1. Preparation for chassis dynamometer test

▼ M3

7.1.0. Selection of dynamometer operation

The test shall be done on either a dynamometer in 2WD operation or 4WD operation, in accordance with paragraph 2.4.2.4. of Sub-Annex 6.

▼ B

7.1.1. Laboratory conditions

▼ M3

7.1.1.1. Roller(s)

The chassis dynamometer roller(s) shall be clean, dry and free from foreign material that might cause tyre slippage. The dynamometer shall be run in the same coupled or uncoupled state as the subsequent Type 1 test. Chassis dynamometer speed shall be measured from the roller coupled to the power absorption unit.

▼ B

7.1.1.1.1. Tyre slippage

Additional weight may be placed on or in the vehicle to eliminate tyre slippage. The manufacturer shall perform the load setting on the chassis dynamometer with the additional weight. The additional weight shall be present for both load setting and the emissions and fuel consumption tests. The use of any additional weight shall be included in all relevant test sheets.

7.1.1.2. Room temperature

The laboratory atmospheric temperature shall be at a set point of 23 °C and shall not deviate by more than ± 5 °C during the test unless otherwise required by any subsequent test.

7.2. Preparation of chassis dynamometer

7.2.1. Inertia mass setting

The equivalent inertia mass of the chassis dynamometer shall be set according to paragraph 2.5.3. of this Sub-Annex. If the chassis dynamometer is not capable to meet the inertia setting exactly, the next higher inertia setting shall be applied with a maximum increase of 10 kg.

7.2.2. Chassis dynamometer warm-up

The chassis dynamometer shall be warmed up in accordance with the dynamometer manufacturer's recommendations, or as appropriate, so that the frictional losses of the dynamometer may be stabilized.

7.3. Vehicle preparation

▼B

- 7.3.1. Tyre pressure adjustment
- The tyre pressure at the soak temperature of a Type 1 test shall be set to no more than 50 per cent above the lower limit of the tyre pressure range for the selected tyre, as specified by the vehicle manufacturer (see paragraph 4.2.2.3. of this Sub-Annex), and shall be included in all relevant test reports.

▼M3

- 7.3.2. If the determination of dynamometer settings cannot meet the criteria described in paragraph 8.1.3. due to non-reproducible forces, the vehicle shall be equipped with a vehicle coastdown mode. The vehicle coastdown mode shall be approved by the approval authority and the use of a vehicle coastdown mode shall be included in all relevant test reports.

If a vehicle is equipped with a vehicle coastdown mode, it shall be engaged both during road load determination and on the chassis dynamometer.

-
- 7.3.3. Vehicle placement on the dynamometer

The tested vehicle shall be placed on the chassis dynamometer in a straight ahead position and restrained in a safe manner. In the case that a single roller chassis dynamometer is used, the centre of the tyre's contact patch on the roller shall be within ± 25 mm or ± 2 per cent of the roller diameter, whichever is smaller, from the top of the roller.

If the torque meter method is used, the tyre pressure shall be adjusted such that the dynamic radius is within 0,5 per cent of the dynamic radius r_j calculated using the equations in paragraph 4.4.3.1. at the 80 km/h reference speed point. The dynamic radius on the chassis dynamometer shall be calculated in accordance with the procedure described in paragraph 4.4.3.1.

If this adjustment is outside the range defined in paragraph 7.3.1., the torque meter method shall not apply.

- 7.3.3.1. [Reserved]

▼B

- 7.3.4. Vehicle warm-up

▼M3

- 7.3.4.1. The vehicle shall be warmed up with the applicable WLTC.

▼B

- 7.3.4.2. If the vehicle is already warmed up, the WLTC phase applied in paragraph 7.3.4.1. of this Sub-Annex, with the highest speed, shall be driven.

- 7.3.4.3. Alternative warm-up procedure

- 7.3.4.3.1. At the request of the vehicle manufacturer and with approval of the approval authority, an alternative warm-up procedure may be used. The approved alternative warm-up procedure may be used for vehicles within the same road load family and shall satisfy the requirements outlined in paragraphs 7.3.4.3.2. to 7.3.4.3.5. of this Sub-Annex inclusive.

- 7.3.4.3.2. At least one vehicle representing the road load family shall be selected.

▼ B

- 7.3.4.3.3. The cycle energy demand calculated according to paragraph 5. of Sub-Annex 7 with corrected road load coefficients f_{0a} , f_{1a} and f_{2a} , for the alternative warm-up procedure shall be equal to or higher than the cycle energy demand calculated with the target road load coefficients f_0 , f_1 , and f_2 , for each applicable phase.

The corrected road load coefficients f_{0a} , f_{1a} and f_{2a} , shall be calculated according to the following equations:

$$f_{0a} = f_0 + A_{d_alt} - A_{d_WLTC}$$

$$f_{1a} = f_1 + B_{d_alt} - B_{d_WLTC}$$

$$f_{2a} = f_2 + C_{d_alt} - C_{d_WLTC}$$

where:

A_{d_alt} , B_{d_alt} and C_{d_alt} are the chassis dynamometer setting coefficients after the alternative warm-up procedure;

A_{d_WLTC} , B_{d_WLTC} and C_{d_WLTC} are the chassis dynamometer setting coefficients after a WLTC warm-up procedure described in paragraph 7.3.4.1. of this Sub-Annex and a valid chassis dynamometer setting according to paragraph 8. of this Sub-Annex.

- 7.3.4.3.4. The corrected road load coefficients f_{0a} , f_{1a} and f_{2a} , shall be used only for the purpose of paragraph 7.3.4.3.3. of this Sub-Annex. For other purposes, the target road load coefficients f_0 , f_1 and f_2 , shall be used as the target road load coefficients.
- 7.3.4.3.5. Details of the procedure and of its equivalency shall be provided to the approval authority.

8. Chassis dynamometer load setting

8.1. Chassis dynamometer load setting using the coastdown method

This method is applicable when the road load coefficients f_0 , f_1 and f_2 have been determined.

In the case of a road load matrix family, this method shall be applied when the road load of the representative vehicle is determined using the coastdown method described in paragraph 4.3. of this Sub-Annex. The target road load values are the values calculated using the method described in paragraph 5.1. of this Sub-Annex.

8.1.1. Initial load setting

For a chassis dynamometer with coefficient control, the chassis dynamometer power absorption unit shall be adjusted with the arbitrary initial coefficients, A_d , B_d and C_d , of the following equation:

▼ B

$$F_d = A_d + B_d v + C_d v^2$$

where:

F_d is the chassis dynamometer setting load, N;

v is the speed of the chassis dynamometer roller, km/h.

The following are recommended coefficients to be used for the initial load setting:

(a) ► **M3** $A_d = 0,5 \times A_t$, $B_d = 0,2 \times B_t$, $C_d = C_t$ ◀

for single-axis chassis dynamometers, or

▼ M3

$$A_d = 0,5 \times A_t, B_d = 0,2 \times B_t, C_d = C_t$$

▼ B

for dual-axis chassis dynamometers, where, and are the target road load coefficients;

(b) empirical values, such as those used for the setting for a similar type of vehicle.

For a chassis dynamometer of polygonal control, adequate load values at each reference speed shall be set to the chassis dynamometer power absorption unit.

8.1.2. Coastdown

The coastdown test on the chassis dynamometer shall be performed with the procedure given in paragraph 8.1.3.4.1. or in paragraph 8.1.3.4.2. of this Sub-Annex and shall start no later than 120 seconds after completion of the warm-up procedure. Consecutive coastdown runs shall be started immediately. At the request of the manufacturer and with approval of the approval authority, the time between the warm-up procedure and coastdowns using the iterative method may be extended to ensure a proper vehicle setting for the coastdown. The manufacturer shall provide the approval authority with evidence for requiring additional time and evidence that the chassis dynamometer load setting parameters (e.g. coolant and/or oil temperature, force on a dynamometer) are not affected.

8.1.3. Verification

8.1.3.1. The target road load value shall be calculated using the target road load coefficient, A_t , B_t and C_t , for each reference speed, v_j :

$$F_{tj} = A_t + B_t v_j + C_t v_j^2$$

where:

▼ M3

A_t , B_t and C_t are the target road load parameters;

▼ B

F_{tj} is the target road load at reference speed v_j , N;

v_j is the j^{th} reference speed, km/h.

▼ B

- 8.1.3.2. The measured road load shall be calculated using the following equation:

$$F_{mj} = \frac{1}{3,6} \times (TM + m_r) \times \frac{2 \times \Delta v}{\Delta t_j}$$

where:

F_{mj} is the measured road load for each reference speed v_j , N;

TM is the test mass of the vehicle, kg;

m_r is the equivalent effective mass of rotating components according to paragraph 2.5.1. of this Sub-Annex, kg;

Δt_j is the coastdown time corresponding to speed v_j , s.

- 8.1.3.3. ► **M3** The simulated road load on the chassis dynamometer shall be calculated in accordance with the method as specified in paragraph 4.3.1.4., with the exception of measuring in opposite directions:

$$F_s = A_s + B_s \times v + C_s \times v^2 \blacktriangleleft$$

The simulated road load for each reference speed v_j shall be determined using the following equation, using the calculated A_s , B_s and C_s :

$$F_{sj} = A_s + B_s \times v_j + C_s \times v_j^2$$

- 8.1.3.4. For dynamometer load setting, two different methods may be used. If the vehicle is accelerated by the dynamometer, the methods described in paragraph 8.1.3.4.1. of this Sub-Annex shall be used. If the vehicle is accelerated under its own power, the methods in paragraphs 8.1.3.4.1. or 8.1.3.4.2. of this Sub-Annex shall be used. The minimum acceleration multiplied by speed shall be $6 \text{ m}^2/\text{sec}^3$. Vehicles which are unable to achieve $6 \text{ m}^2/\text{s}^3$ shall be driven with the acceleration control fully applied.

- 8.1.3.4.1. Fixed run method

- 8.1.3.4.1.1. The dynamometer software shall perform four coastdowns in total: From the first coastdown, the dynamometer setting coefficients for the second run according to paragraph 8.1.4. of this Sub-Annex shall be calculated. Following the first coastdown, the software shall perform three additional coastdowns with either the fixed dynamometer setting coefficients determined after the first coastdown or the adjusted dynamometer setting coefficients according to paragraph 8.1.4. of this Sub-Annex.

▼ B

8.1.3.4.1.2. The final dynamometer setting coefficients A, B and C shall be calculated using the following equations:

$$A = A_t - \frac{\sum_{n=2}^4 (A_{s_n} - A_{d_n})}{3}$$

$$B = B_t - \frac{\sum_{n=2}^4 (B_{s_n} - B_{d_n})}{3}$$

$$C = C_t - \frac{\sum_{n=2}^4 (C_{s_n} - C_{d_n})}{3}$$

where:

▼ M3

A_t , B_t and C_t are the target road load parameters;

▼ B

A_{s_n} , B_{s_n} and C_{s_n} are the simulated road load coefficients of the n^{th} run;

A_{d_n} , B_{d_n} and C_{d_n} are the dynamometer setting coefficients of the n^{th} run;

n is the index number of coastdowns including the first stabilisation run.

▼ M3

8.1.3.4.2. Iterative method

The calculated forces in the specified speed ranges shall either be within ± 10 N after a least squares regression of the forces for two consecutive coastdowns when compared with the target values, or additional coastdowns shall be performed after adjusting the chassis dynamometer load setting in accordance with paragraph 8.1.4. until the tolerance is satisfied.

▼ B

8.1.4. Adjustment

The chassis dynamometer setting load shall be adjusted according to the following equations:

$$\begin{aligned} F_{dj}^* &= F_{dj} - F_j = F_{dj} - F_{sj} + F_{ij} \\ &= (A_d + B_d v_j + C_d v_j^2) - (A_s + B_s v_j + C_s v_j^2) + (A_t + B_t v_j + C_t v_j^2) \\ &= (A_d + A_t - A_s) + (B_d + B_t - B_s) v_j + (C_d + C_t - C_s) v_j^2 \end{aligned}$$

Therefore:

$$A_d^* = A_d + A_t - A_s$$

$$B_d^* = B_d + B_t - B_s$$

$$C_d^* = C_d + C_t - C_s$$

where:

F_{dj} is the initial chassis dynamometer setting load, N;

F_{dj}^* is the adjusted chassis dynamometer setting load, N;

▼ B

F_j	is the adjustment road load equal to $(F_{sj} - F_{ij})$, N;
F_{sj}	is the simulated road load at reference speed v_j , N;
F_{ij}	is the target road load at reference speed v_j , N;
A^*_d , B^*_d and C^*_d	are the new chassis dynamometer setting coefficients.

▼ M3

- 8.1.5. A_t , B_t and C_t shall be used as the final values of f_0 , f_1 and f_2 , and shall be used for the following purposes:
- (a) Determination of downscaling, paragraph 8. of Sub-Annex 1;
 - (b) Determination of gearshift points, Sub-Annex 2;
 - (c) Interpolation of CO₂ and fuel consumption, paragraph 3.2.3. of Sub-Annex 7;
 - (d) Calculation of results of electric and hybrid-electric vehicles, paragraph 4. of Sub-Annex 8.

▼ B

- 8.2. Chassis dynamometer load setting using the torque meter method

This method is applicable when the running resistance is determined using the torque meter method described in paragraph 4.4. of this Sub-Annex.

In the case of a road load matrix family, this method shall be applied when the running resistance of the representative vehicle is determined using the torque meter method as specified in paragraph 4.4. of this Sub-Annex. ► **M2** The target running resistance values are the values calculated using the method specified in paragraph 5.1 of this Sub-Annex. ◀

- 8.2.1. Initial load setting

For a chassis dynamometer of coefficient control, the chassis dynamometer power absorption unit shall be adjusted with the arbitrary initial coefficients, A_d , B_d and C_d , of the following equation:

$$F_d = A_d + B_d v + C_d v^2$$

where:

F_d is the chassis dynamometer setting load, N;

v is the speed of the chassis dynamometer roller, km/h.

The following coefficients are recommended for the initial load setting:

(a) $A_d = 0,5 \times \frac{a_t}{r'}$, $B_d = 0,2 \times \frac{b_t}{r'}$, $C_d = \frac{c_t}{r'}$

for single-axis chassis dynamometers, or

$A_d = 0,1 \times \frac{a_t}{r'}$, $B_d = 0,2 \times \frac{b_t}{r'}$, $C_d = \frac{c_t}{r'}$

for dual-axis chassis dynamometers, where:

a_t , b_t and c_t are the target running resistance coefficients; and

r' is the dynamic radius of the tyre on the chassis dynamometer obtained at 80 km/h, m.; or

▼ B

- (b) Empirical values, such as those used for the setting for a similar type of vehicle.

For a chassis dynamometer of polygonal control, adequate load values at each reference speed shall be set for the chassis dynamometer power absorption unit.

8.2.2. Wheel torque measurement

The torque measurement test on the chassis dynamometer shall be performed with the procedure defined in paragraph 4.4.2. of this Sub-Annex. The torque meter(s) shall be identical to the one(s) used in the preceding road test.

8.2.3. Verification

- 8.2.3.1. The target running resistance (torque) curve shall be determined using the equation in paragraph 4.5.5.2.1. of this Sub-Annex and may be written as follows:

$$C_t^* = a_t + b_t \times v_j + c_t \times v_j^2$$

- 8.2.3.2. The simulated running resistance (torque) curve on the chassis dynamometer shall be calculated according to the method described and the measurement precision specified in ► **M3** paragraph 4.4.3.2. ◀ of this Sub-Annex, and the running resistance (torque) curve determination as described in paragraph 4.4.4. of this Sub-Annex with applicable corrections according to paragraph 4.5. of this Sub-Annex, all with the exception of measuring in opposite directions, resulting in a simulated running resistance curve:

$$C_s^* = C_{0s} + C_{1s} \times v_j + C_{2s} \times v_j^2$$

The simulated running resistance (torque) shall be within a tolerance of $\pm 10 \text{ N} \times r'$ from the target running resistance at every speed reference point where r' is the dynamic radius of the tyre in metres on the chassis dynamometer obtained at 80 km/h.

If the tolerance at any reference speed does not satisfy the criterion of the method described in this paragraph, the procedure specified in paragraph 8.2.3.3. of this Sub-Annex shall be used to adjust the chassis dynamometer load setting.

▼ M3

8.2.3.3. Adjustment

The chassis dynamometer load setting shall be adjusted using the following equation:

$$\begin{aligned} F_{*dj}^* &= F_{dj} - \frac{F_{ej}}{r'} = F_{dj} - \frac{F_{sj}}{r'} + \frac{F_{tj}}{r'} = (A_d + B_d v_j + C_d v_j^2) - \frac{(a_s + b_s v_j + c_s v_j^2)}{r'} + \frac{(a_t + b_t v_j + c_t v_j^2)}{r'} \\ &= \left\{ A_d + \frac{(a_t - a_s)}{r'} \right\} + \left\{ B_d + \frac{(b_t - b_s)}{r'} \right\} v_j + \left\{ C_d + \frac{(c_t - c_s)}{r'} \right\} v_j^2 \end{aligned}$$

▼ M3

therefore:

$$A^*_{d} = A_{d} + \frac{a_t - a_s}{r'}$$

$$B^*_{d} = B_{d} + \frac{b_t - b_s}{r'}$$

$$C^*_{d} = C_{d} + \frac{c_t - c_s}{r'}$$

where:

F^*_{dj} is the new chassis dynamometer setting load, N;

F_{ej} is the adjustment road load equal to $(F_{sj} - F_{tj})$, Nm;

F_{sj} is the simulated road load at reference speed v_j , Nm;

F_{tj} is the target road load at reference speed v_j , Nm;

A^*_{d} , B^*_{d} and C^*_{d} are the new chassis dynamometer setting coefficients;

r' is the dynamic radius of the tyre on the chassis dynamometer obtained at 80 km/h, m.

Paragraphs 8.2.2. and 8.2.3. shall be repeated until the tolerance in paragraph 8.2.3.2. is met.

▼ B

8.2.3.4. The mass of the driven axle(s), tyre specifications and chassis dynamometer load setting shall be included in all relevant test reports when the requirement of paragraph 8.2.3.2. of this Sub-Annex is fulfilled.

8.2.4. Transformation of running resistance coefficients to road load coefficients f_0 , f_1 , f_2

▼ M3

8.2.4.1. If the vehicle does not coast down in a repeatable manner and a vehicle coastdown mode in accordance with paragraph 4.2.1.8.5. is not feasible, the coefficients f_0 , f_1 and f_2 in the road load equation shall be calculated using the equations in paragraph 8.2.4.1.1. In any other case, the procedure described in paragraphs 8.2.4.2. to 8.2.4.4. shall be performed.

▼ B

8.2.4.1.1.
$$f_0 = \frac{c_0}{r} \times 1,02$$

$$f_1 = \frac{c_1}{r} \times 1,02$$

$$f_2 = \frac{c_2}{r} \times 1,02$$

▼B

where:

c_0, c_1, c_2 are the running resistance coefficients determined in paragraph 4.4.4. of this Sub-Annex, Nm, Nm/(km/h), Nm/(km/h)²;

r is the dynamic tyre radius of the vehicle with which the running resistance was determined, m.

1,02 is an approximate coefficient compensating for drivetrain losses.

8.2.4.1.2. The determined f_0, f_1, f_2 values shall not be used for a chassis dynamometer setting or any emission or range testing. They shall be used only in the following cases:

- (a) determination of downscaling, paragraph 8. of Sub-Annex 1;
- (b) determination of gearshift points, Sub-Annex 2;
- (c) interpolation of CO₂ and fuel consumption, paragraph 3.2.3 of Sub-Annex 7;

▼M3

- (d) calculation of results of electric and hybrid-electric vehicles, paragraph 4. of Sub-Annex 8.

▼B

8.2.4.2. Once the chassis dynamometer has been set within the specified tolerances, a vehicle coastdown procedure shall be performed on the chassis dynamometer as outlined in paragraph 4.3.1.3. of this Sub-Annex. The coastdown times shall be included in all relevant test sheets.

8.2.4.3. The road load F_j at reference speed v_j , N, shall be determined using the following equation:

$$F_j = \frac{1}{3,6} \times (TM + m_r) \times \frac{\Delta v}{\Delta t_j}$$

where:

F_j is the road load at reference speed v_j , N;

TM is the test mass of the vehicle, kg;

m_r is the equivalent effective mass of rotating components according to paragraph 2.5.1. of this Sub-Annex, kg;

$\Delta v = 10$ km/h

Δt_j is the coastdown time corresponding to speed v_j , s.

8.2.4.4. The coefficients f_0, f_1 and f_2 in the road load equation shall be calculated with a least squares regression analysis over the reference speed range.

▼B*Sub-Annex 5***Test equipment and calibrations**

1. Test bench specifications and settings
 - 1.1. Cooling fan specifications

▼M3

- 1.1.1. A variable speed current of air shall be blown towards the vehicle. The set point of the linear velocity of the air at the blower outlet shall be equal to the corresponding roller speed above roller speeds of 5 km/h. The linear velocity of the air at the blower outlet shall be within ± 5 km/h or ± 10 per cent of the corresponding roller speed, whichever is greater.

▼B

- 1.1.2. The above-mentioned air velocity shall be determined as an averaged value of a number of measuring points that:
 - (a) For fans with rectangular outlets, are located at the centre of each rectangle dividing the whole of the fan outlet into 9 areas (dividing both horizontal and vertical sides of the fan outlet into 3 equal parts). The centre area shall not be measured (as shown in Figure A5/1);

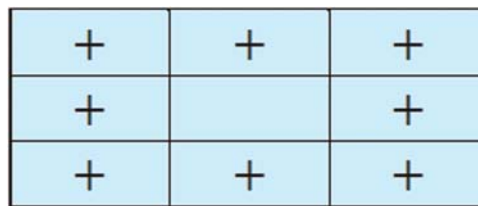
*Figure A5/1***Fan with rectangular outlet**

- (b) For fans with circular outlets, the outlet shall be divided into 8 equal sectors by vertical, horizontal and 45° lines. The measurement points shall lie on the radial centre line of each sector (22,5°) at two-thirds of the outlet radius (as shown in Figure A5/2).

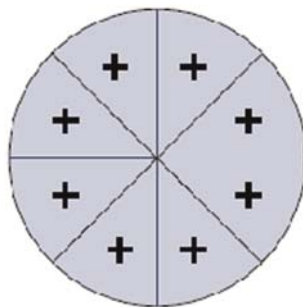
*Figure A5/2***Fan with circular outlet**

These measurements shall be made with no vehicle or other obstruction in front of the fan. The device used to measure the linear velocity of the air shall be located between 0 and 20 cm from the air outlet.

▼B

- 1.1.3. The outlet of the fan shall have the following characteristics:
- (a) An area of at least 0,3 m²; and
 - (b) A width/diameter of at least 0,8 metre.
- 1.1.4. The position of the fan shall be as follows:
- (a) Height of the lower edge above ground: approximately 20 cm;
 - (b) Distance from the front of the vehicle: approximately 30 cm;

▼M3

- (c) Approximately on the longitudinal centreline of the vehicle.
- 1.1.5. At the request of the manufacturer and if considered appropriate by the approval authority, the height, lateral position and distance from the vehicle of the cooling fan may be modified.

If the specified fan configuration is impractical for special vehicle designs, such as vehicles with rear-mounted engines or side air intakes, or it does not provide adequate cooling to properly represent in-use operation, at the request of the manufacturer and if considered appropriate by the approval authority, the height, capacity, longitudinal and lateral position of the cooling fan may be modified and additional fans which may have different specifications (including constant speed fans) may be used.

- 1.1.6. In the cases described in paragraph 1.1.5., the position and capacity of the cooling fan(s) and details of the justification supplied to the approval authority shall be included in all relevant test reports. For any subsequent testing, similar positions and specifications shall be used in consideration of the justification to avoid non-representative cooling characteristics.

▼B

2. Chassis dynamometer
- 2.1. General requirements
- 2.1.1. The dynamometer shall be capable of simulating road load with three road load coefficients that can be adjusted to shape the load curve.

▼M3

- 2.1.2. The chassis dynamometer may have a single or twin-roller configuration. In the case that twin-roller chassis dynamometers are used, the rollers shall be permanently coupled or the front roller shall drive, directly or indirectly, any inertial masses and the power absorption device.

▼B

- 2.2. Specific requirements
- The following specific requirements relate to the dynamometer manufacturer's specifications.
- 2.2.1. The roller run-out shall be less than 0,25 mm at all measured locations.
- 2.2.2. The roller diameter shall be within $\pm 1,0$ mm of the specified nominal value at all measurement locations.
- 2.2.3. The dynamometer shall have a time measurement system for use in determining acceleration rates and for measuring vehicle/dynamometer coastdown times. This time measurement system shall have an accuracy of at least $\pm 0,001$ per cent. This shall be verified upon initial installation.

▼ B

- 2.2.4. The dynamometer shall have a speed measurement system with an accuracy of at least $\pm 0,080$ km/h. This shall be verified upon initial installation.
- 2.2.5. The dynamometer shall have a response time (90 per cent response to a tractive effort step change) of less than 100 ms with instantaneous accelerations that are at least 3 m/s^2 . This shall be verified upon initial installation and after major maintenance.
- 2.2.6. The base inertia of the dynamometer shall be stated by the dynamometer manufacturer and shall be confirmed to within $\pm 0,5$ per cent for each measured base inertia and $\pm 0,2$ per cent relative to any arithmetic average value by dynamic derivation from trials at constant acceleration, deceleration and force.

▼ M3

- 2.2.7. Roller speed shall be measured at a frequency of not less than 10 Hz.
- 2.3. Additional specific requirements for a chassis dynamometer in 4WD operation
- 2.3.1. The 4WD control system of the dynamometer shall be designed such that the following requirements are fulfilled when tested with a vehicle driven over the WLTC.
- 2.3.1.1. Road load simulation shall be applied such that the dynamometer in 4WD operation reproduces the same proportioning of forces as would be encountered when driving the vehicle on a smooth, dry, level road surface.

▼ B

- 2.3.1.2. Upon initial installation and after major maintenance, the requirements of paragraph 2.3.1.2.1. of this Sub-Annex and either paragraph 2.3.1.2.2. or 2.3.1.2.3. of this Sub-Annex shall be satisfied. The speed difference between the front and rear rollers is assessed by applying a 1 second moving average filter to roller speed data acquired at a minimum frequency of 20 Hz.
- 2.3.1.2.1. The difference in distance covered by the front and rear rollers shall be less than 0,2 per cent of the distance driven over the WLTC. The absolute number shall be integrated for the calculation of the total difference in distance over the WLTC.
- 2.3.1.2.2. The difference in distance covered by the front and rear rollers shall be less than 0,1 m in any 200 ms time period.
- 2.3.1.2.3. The speed difference of all roller speeds shall be within $\pm 0,16$ km/h.

2.4. Chassis dynamometer calibration

▼ M3

- 2.4.1. Force measurement system
- The accuracy of the force transducer shall be at least ± 10 N for all measured increments. This shall be verified upon initial installation, after major maintenance and within 370 days before testing.

▼ B

- 2.4.2. Dynamometer parasitic loss calibration
- The dynamometer's parasitic losses shall be measured and updated if any measured value differs from the current loss curve by more than 9,0 N. This shall be verified upon initial installation, after major maintenance and within 35 days before testing.

▼B

- 2.4.3. Verification of road load simulation without a vehicle
- The dynamometer performance shall be verified by performing an unloaded coastdown test upon initial installation, after major maintenance, and within 7 days before testing. The arithmetic average coastdown force error shall be less than 10 N or 2 per cent, whichever is greater, at each reference speed point.
3. Exhaust gas dilution system
- 3.1. System specification
- 3.1.1. Overview
- 3.1.1.1. A full flow exhaust dilution system shall be used. The total vehicle exhaust shall be continuously diluted with ambient air under controlled conditions using a constant volume sampler. A critical flow venturi (CFV) or multiple critical flow venturis arranged in parallel, a positive displacement pump (PDP), a subsonic venturi (SSV), or an ultrasonic flow meter (UFM) may be used. The total volume of the mixture of exhaust and dilution air shall be measured and a continuously proportional sample of the volume shall be collected for analysis. The quantities of exhaust gas compounds shall be determined from the sample concentrations, corrected for their respective content of the dilution air and the totalised flow over the test period.
- 3.1.1.2. The exhaust dilution system shall consist of a connecting tube, a mixing device and dilution tunnel, dilution air conditioning, a suction device and a flow measurement device. Sampling probes shall be fitted in the dilution tunnel as specified in paragraphs 4.1., 4.2. and 4.3. of this Sub-Annex.
- 3.1.1.3. The mixing device referred to in paragraph 3.1.1.2. of this Sub-Annex shall be a vessel such as that illustrated in Figure A5/3 in which vehicle exhaust gases and the dilution air are combined so as to produce a homogeneous mixture at the sampling position.
- 3.2. General requirements
- 3.2.1. The vehicle exhaust gases shall be diluted with a sufficient amount of ambient air to prevent any water condensation in the sampling and measuring system at all conditions that may occur during a test.
- 3.2.2. The mixture of air and exhaust gases shall be homogeneous at the point where the sampling probes are located (paragraph 3.3.3. of this Sub-Annex). The sampling probes shall extract representative samples of the diluted exhaust gas.
- 3.2.3. The system shall enable the total volume of the diluted exhaust gases to be measured.
- 3.2.4. The sampling system shall be gas-tight. The design of the variable dilution sampling system and the materials used in its construction shall be such that the concentration of any compound in the diluted exhaust gases is not affected. If any component in the system (heat exchanger, cyclone separator, suction device, etc.) changes the concentration of any of the exhaust gas compounds and the systematic error cannot be corrected, sampling for that compound shall be carried out upstream from that component.

▼B

3.2.5. All parts of the dilution system in contact with raw or diluted exhaust gas shall be designed to minimise deposition or alteration of the particulate or particles. All parts shall be made of electrically conductive materials that do not react with exhaust gas components, and shall be electrically grounded to prevent electrostatic effects.

3.2.6. If the vehicle being tested is equipped with an exhaust pipe comprising several branches, the connecting tubes shall be connected as near as possible to the vehicle without adversely affecting their operation.

3.3. Specific requirements

3.3.1. Connection to vehicle exhaust

3.3.1.1. The start of the connecting tube is the exit of the tailpipe. The end of the connecting tube is the sample point, or first point of dilution.

For multiple tailpipe configurations where all the tailpipes are combined, the start of the connecting tube shall be taken at the last joint of where all the tailpipes are combined. In this case, the tube between the exit of the tailpipe and the start of the connecting tube may or may not be insulated or heated.

3.3.1.2. The connecting tube between the vehicle and dilution system shall be designed so as to minimize heat loss.

3.3.1.3. The connecting tube shall satisfy the following requirements:

(a) Be less than 3.6 metres long, or less than 6.1 metres long if heat-insulated. Its internal diameter shall not exceed 105 mm; the insulating materials shall have a thickness of at least 25 mm and thermal conductivity shall not exceed $0,1 \text{ W/m}^{-1}\text{K}^{-1}$ at $400 \text{ }^\circ\text{C}$. Optionally, the tube may be heated to a temperature above the dew point. This may be assumed to be achieved if the tube is heated to $70 \text{ }^\circ\text{C}$;

(b) Not cause the static pressure at the exhaust outlets on the vehicle being tested to differ by more than $\pm 0,75 \text{ kPa}$ at 50 km/h , or more than $\pm 1,25 \text{ kPa}$ for the duration of the test from the static pressures recorded when nothing is connected to the vehicle exhaust pipes. The pressure shall be measured in the exhaust outlet or in an extension having the same diameter and as near as possible to the end of the tailpipe. Sampling systems capable of maintaining the static pressure to within $\pm 0,25 \text{ kPa}$ may be used if a written request from a manufacturer to the approval authority substantiates the need for the closer tolerance;

(c) No component of the connecting tube shall be of a material that might affect the gaseous or solid composition of the exhaust gas. To avoid generation of any particles from elastomer connectors, elastomers employed shall be as thermally stable as possible and have minimum exposure to the exhaust gas. It is recommended not to use elastomer connectors to bridge the connection between the vehicle exhaust and the connecting tube.

3.3.2. Dilution air conditioning

▼ B

- 3.3.2.1. The dilution air used for the primary dilution of the exhaust in the CVS tunnel shall pass through a medium capable of reducing particles of the most penetrating particle size in the filter material by $\leq 99,95$ per cent, or through a filter of at least class H13 of EN 1822:2009. This represents the specification of High Efficiency Particulate Air (HEPA) filters. The dilution air may optionally be charcoal-scrubbed before being passed to the HEPA filter. It is recommended that an additional coarse particle filter be situated before the HEPA filter and after the charcoal scrubber, if used.
- 3.3.2.2. At the vehicle manufacturer's request, the dilution air may be sampled according to good engineering practice to determine the tunnel contribution to background particulate and particle levels, which can be subsequently subtracted from the values measured in the diluted exhaust. ► **M3** See paragraph 2.1.3. of Sub-Annex 6. ◀
- 3.3.3. Dilution tunnel
- 3.3.3.1. Provision shall be made for the vehicle exhaust gases and the dilution air to be mixed. A mixing device may be used.
- 3.3.3.2. The homogeneity of the mixture in any cross-section at the location of the sampling probe shall not vary by more than ± 2 per cent from the arithmetic average of the values obtained for at least five points located at equal intervals on the diameter of the gas stream.
- 3.3.3.3. For PM and PN emissions sampling, a dilution tunnel shall be used that:
- (a) Consists of a straight tube of electrically-conductive material that is grounded;
 - (b) Causes turbulent flow (Reynolds number $\geq 4\,000$) and be of sufficient length to cause complete mixing of the exhaust and dilution air;
 - (c) Is at least 200 mm in diameter;
 - (d) May be insulated and/or heated.
- 3.3.4. Suction device
- 3.3.4.1. This device may have a range of fixed speeds to ensure sufficient flow to prevent any water condensation. This result is obtained if the flow is either:
- (a) Twice as high as the maximum flow of exhaust gas produced by accelerations of the driving cycle; or
 - (b) Sufficient to ensure that the CO₂ concentration in the dilute exhaust sample bag is less than 3 per cent by volume for petrol and diesel, less than 2.2 per cent by volume for LPG and less than 1.5 per cent by volume for NG/biomethane.
- 3.3.4.2. Compliance with the requirements in paragraph 3.3.4.1. of this Sub-Annex may not be necessary if the CVS system is designed to inhibit condensation by such techniques, or combination of techniques, as:

▼B

- (a) Reducing water content in the dilution air (dilution air dehumidification);
- (b) Heating of the CVS dilution air and of all components up to the diluted exhaust flow measurement device and, optionally, the bag sampling system including the sample bags and also the system for the measurement of the bag concentrations.

In such cases, the selection of the CVS flow rate for the test shall be justified by showing that condensation of water cannot occur at any point within the CVS, bag sampling or analytical system.

3.3.5. Volume measurement in the primary dilution system

3.3.5.1. The method of measuring total dilute exhaust volume incorporated in the constant volume sampler shall be such that measurement is accurate to ± 2 per cent under all operating conditions. If the device cannot compensate for variations in the temperature of the mixture of exhaust gases and dilution air at the measuring point, a heat exchanger shall be used to maintain the temperature to within ± 6 °C of the specified operating temperature for a PDP CVS, ± 11 °C for a CFV CVS, ± 6 °C for a UFM CVS, and ± 11 °C for an SSV CVS.

3.3.5.2. If necessary, some form of protection for the volume measuring device may be used e.g. a cyclone separator, bulk stream filter, etc.

▼M3

3.3.5.3. A temperature sensor shall be installed immediately before the volume measuring device. This temperature sensor shall have an accuracy of ± 1 °C and a response time of 0,1 seconds at 62 per cent of a given temperature variation (value measured in silicone oil).

▼B

3.3.5.4. Measurement of the pressure difference from atmospheric pressure shall be taken upstream from and, if necessary, downstream from the volume measuring device.

3.3.5.5. The pressure measurements shall have a precision and an accuracy of $\pm 0,4$ kPa during the test. See Table A5/5.

3.3.6. Recommended system description

Figure A5/3 is a schematic drawing of exhaust dilution systems that meet the requirements of this Sub-Annex.

The following components are recommended:

- (a) A dilution air filter, which may be pre-heated if necessary. This filter shall consist of the following filters in sequence: an optional activated charcoal filter (inlet side), and a HEPA filter (outlet side). It is recommended that an additional coarse particle filter be situated before the HEPA filter and after the charcoal filter, if used. The purpose of the charcoal filter is to reduce and stabilize the hydrocarbon concentrations of ambient emissions in the dilution air;

▼ B

- (b) A connecting tube by which vehicle exhaust is admitted into a dilution tunnel;
- (c) An optional heat exchanger as described in paragraph 3.3.5.1. of this Sub-Annex;
- (d) A mixing device in which exhaust gas and dilution air are mixed homogeneously, and which may be located close to the vehicle so that the length of the connecting tube is minimized;
- (e) A dilution tunnel from which particulate and particles are sampled;
- (f) Some form of protection for the measurement system may be used e.g. a cyclone separator, bulk stream filter, etc.;
- (g) A suction device of sufficient capacity to handle the total volume of diluted exhaust gas.

Exact conformity with these figures is not essential. Additional components such as instruments, valves, solenoids and switches may be used to provide additional information and co-ordinate the functions of the component system.

Figure A5/3

Exhaust dilution system

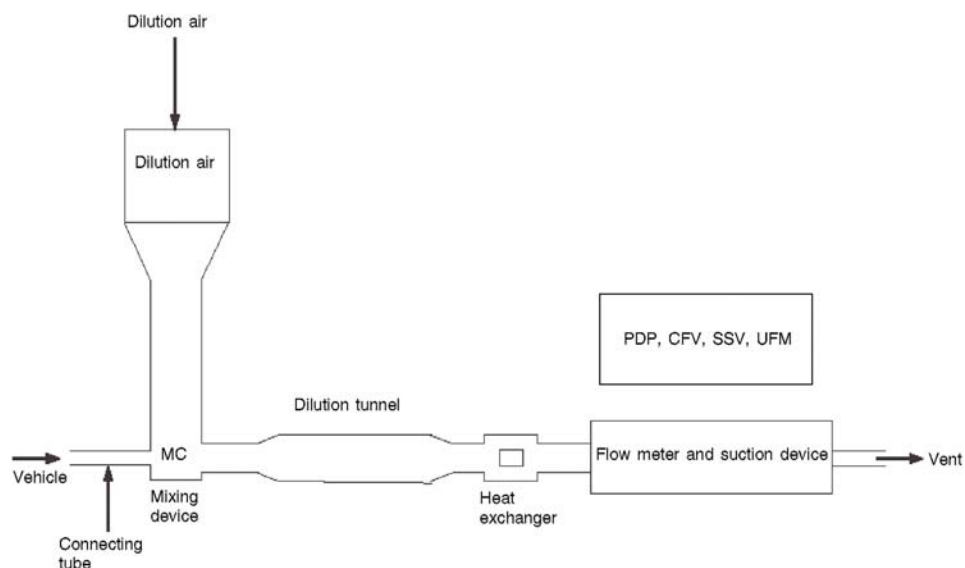
**▼ M3**

3.3.6.1. Positive displacement pump (PDP)

A positive displacement pump (PDP) full flow exhaust dilution system satisfies the requirements of this Sub-Annex by metering the flow of gas through the pump at constant temperature and pressure. The total volume is measured by counting the revolutions made by the calibrated positive displacement pump. The proportional sample is achieved by sampling with pump, flow meter and flow control valve at a constant flow rate.

▼ B

- 3.3.6.2. Critical flow venturi (CFV)
- 3.3.6.2.1. The use of a CFV for the full flow exhaust dilution system is based on the principles of flow mechanics for critical flow. The variable mixture flow rate of dilution and exhaust gas is maintained at sonic velocity that is directly proportional to the square root of the gas temperature. Flow is continually monitored, computed and integrated throughout the test.
- 3.3.6.2.2. The use of an additional critical flow sampling venturi ensures the proportionality of the gas samples taken from the dilution tunnel. As both pressure and temperature are equal at the two venturi inlets, the volume of the gas flow diverted for sampling is proportional to the total volume of diluted exhaust gas mixture produced, and thus the requirements of this Sub-Annex are fulfilled.
- 3.3.6.2.3. A measuring CFV tube shall measure the flow volume of the diluted exhaust gas.
- 3.3.6.3. Subsonic flow venturi (SSV)
- 3.3.6.3.1. The use of an SSV (Figure A5/4) for a full flow exhaust dilution system is based on the principles of flow mechanics. The variable mixture flow rate of dilution and exhaust gas is maintained at a subsonic velocity that is calculated from the physical dimensions of the subsonic venturi and measurement of the absolute temperature (T) and pressure (P) at the venturi inlet and the pressure in the throat of the venturi. Flow is continually monitored, computed and integrated throughout the test.
- 3.3.6.3.2. An SSV shall measure the flow volume of the diluted exhaust gas.

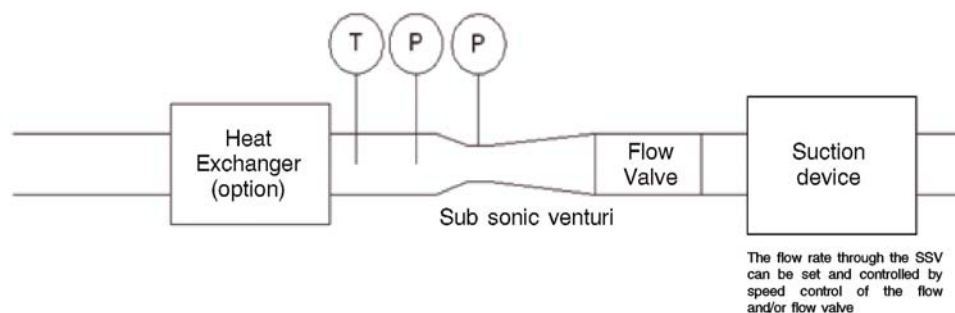
*Figure A5/4***Schematic of a subsonic venturi tube (SSV)**

- 3.3.6.4. Ultrasonic flow meter (UFM)
- 3.3.6.4.1. A UFM measures the velocity of the diluted exhaust gas in the CVS piping using the principle of ultrasonic flow detection by means of a pair, or multiple pairs, of ultrasonic transmitters/receivers mounted within the pipe as in Figure A5/5. The velocity of the flowing gas is determined by the difference in the time required for the ultrasonic signal to travel from transmitter to receiver in the upstream direction and the downstream direction. The gas velocity is converted to standard volumetric flow using a calibration factor for the tube diameter with real time corrections for the diluted exhaust temperature and absolute pressure.

▼ B

3.3.6.4.2. Components of the system include:

- (a) A suction device fitted with speed control, flow valve or other method for setting the CVS flow rate and also for maintaining constant volumetric flow at standard conditions;
- (b) A UFM;
- (c) Temperature and pressure measurement devices, T and P, required for flow correction;
- (d) An optional heat exchanger for controlling the temperature of the diluted exhaust to the UFM. If installed, the heat exchanger shall be capable of controlling the temperature of the diluted exhaust to that specified in paragraph 3.3.5.1. of this Sub-Annex. Throughout the test, the temperature of the air/exhaust gas mixture measured at a point immediately upstream of the suction device shall be within ± 6 °C of the arithmetic average operating temperature during the test.

Figure A5/5

Schematic of an ultrasonic flow meter (UFM)

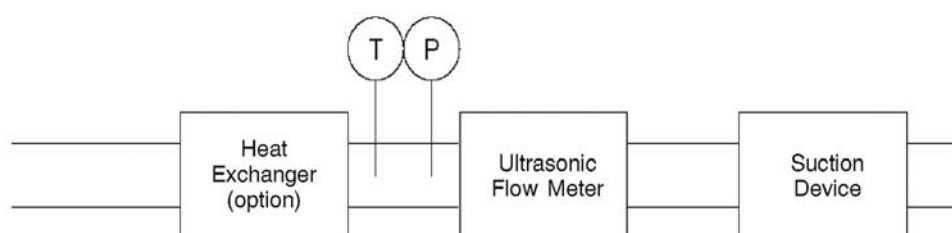

3.3.6.4.3. The following conditions shall apply to the design and use of the UFM type CVS:

- (a) The velocity of the diluted exhaust gas shall provide a Reynolds number higher than 4 000 in order to maintain a consistent turbulent flow before the ultrasonic flow meter;
- (b) An ultrasonic flow meter shall be installed in a pipe of constant diameter with a length of 10 times the internal diameter upstream and 5 times the diameter downstream;

▼ M3

- (c) A temperature sensor (T) for the diluted exhaust shall be installed immediately before the ultrasonic flow meter. This sensor shall have an accuracy of ± 1 °C and a response time of 0,1 seconds at 62 per cent of a given temperature variation (value measured in silicone oil);

▼ B

- (d) The absolute pressure (P) of the diluted exhaust shall be measured immediately before the ultrasonic flow meter to within $\pm 0,3$ kPa;

▼B

- (e) If a heat exchanger is not installed upstream of the ultrasonic flow meter, the flow rate of the diluted exhaust, corrected to standard conditions, shall be maintained at a constant level during the test. This may be achieved by control of the suction device, flow valve or other method.
- 3.4. CVS calibration procedure
- 3.4.1. General requirements
- 3.4.1.1. The CVS system shall be calibrated by using an accurate flow meter and a restricting device and at the intervals listed in Table A5/4. The flow through the system shall be measured at various pressure readings and the control parameters of the system measured and related to the flows. The flow metering device (e.g. calibrated venturi, laminar flow element (LFE), calibrated turbine meter) shall be dynamic and suitable for the high flow rate encountered in constant volume sampler testing. ► **M3** The device shall be of certified accuracy. ◀
- 3.4.1.2. The following paragraphs describe methods for calibrating PDP, CFV, SSV and UFM units using a laminar flow meter, which gives the required accuracy, along with a statistical check on the calibration validity.
- 3.4.2. Calibration of a positive displacement pump (PDP)
- 3.4.2.1. The following calibration procedure outlines the equipment, the test configuration and the various parameters that are measured to establish the flow rate of the CVS pump. All the parameters related to the pump are simultaneously measured with the parameters related to the flow meter that is connected in series with the pump. The calculated flow rate (given in m³/min at pump inlet for the measured absolute pressure and temperature) shall be subsequently plotted versus a correlation function that includes the relevant pump parameters. The linear equation that relates the pump flow and the correlation function shall be subsequently determined. In the case that a CVS has a multiple speed drive, a calibration for each range used shall be performed.
- 3.4.2.2. This calibration procedure is based on the measurement of the absolute values of the pump and flow meter parameters relating the flow rate at each point. The following conditions shall be maintained to ensure the accuracy and integrity of the calibration curve:
- 3.4.2.2.1. The pump pressures shall be measured at tappings on the pump rather than at the external piping on the pump inlet and outlet. Pressure taps that are mounted at the top centre and bottom centre of the pump drive head plate are exposed to the actual pump cavity pressures, and therefore reflect the absolute pressure differentials.
- 3.4.2.2.2. Temperature stability shall be maintained during the calibration. The laminar flow meter is sensitive to inlet temperature oscillations that cause data points to be scattered. Gradual changes of ± 1 °C in temperature are acceptable as long as they occur over a period of several minutes.

▼ B

- 3.4.2.2.3. All connections between the flow meter and the CVS pump shall be free of leakage.
- 3.4.2.3. During an exhaust emissions test, the measured pump parameters shall be used to calculate the flow rate from the calibration equation.
- 3.4.2.4. Figure A5/6 of this Sub-Annex shows an example of a calibration set-up. Variations are permissible, provided that the approval authority approves them as being of comparable accuracy. If the set-up shown in Figure A5/6 is used, the following data shall be found within the limits of accuracy given:

Barometric pressure (corrected), $P_b \pm 0,03 \text{ kPa}$

Ambient temperature, $T \blacktriangleright \underline{\mathbf{M3}} \pm 0,2 \text{ } ^\circ\text{C} \blacktriangleleft$

Air temperature at LFE, ETI $\blacktriangleright \underline{\mathbf{M3}} \pm 0,15 \text{ } ^\circ\text{C} \blacktriangleleft$

Pressure depression upstream of LFE, EPI $\pm 0,01 \text{ kPa}$

Pressure drop across the LFE matrix, EDP $\pm 0,0015 \text{ kPa}$

Air temperature at CVS pump inlet, PTI $\blacktriangleright \underline{\mathbf{M3}} \pm 0,2 \text{ } ^\circ\text{C} \blacktriangleleft$

Air temperature at CVS pump outlet, PTO $\blacktriangleright \underline{\mathbf{M3}} \pm 0,2 \text{ } ^\circ\text{C} \blacktriangleleft$

Pressure depression at CVS pump inlet, PPI $\pm 0,22 \text{ kPa}$

Pressure head at CVS pump outlet, PPO $\pm 0,22 \text{ kPa}$

Pump revolutions during test period, $n \pm 1 \text{ min}^{-1}$

Elapsed time for period (minimum 250 s), $t \pm 0,1 \text{ s}$

Figure A5/6

PDP calibration configuration

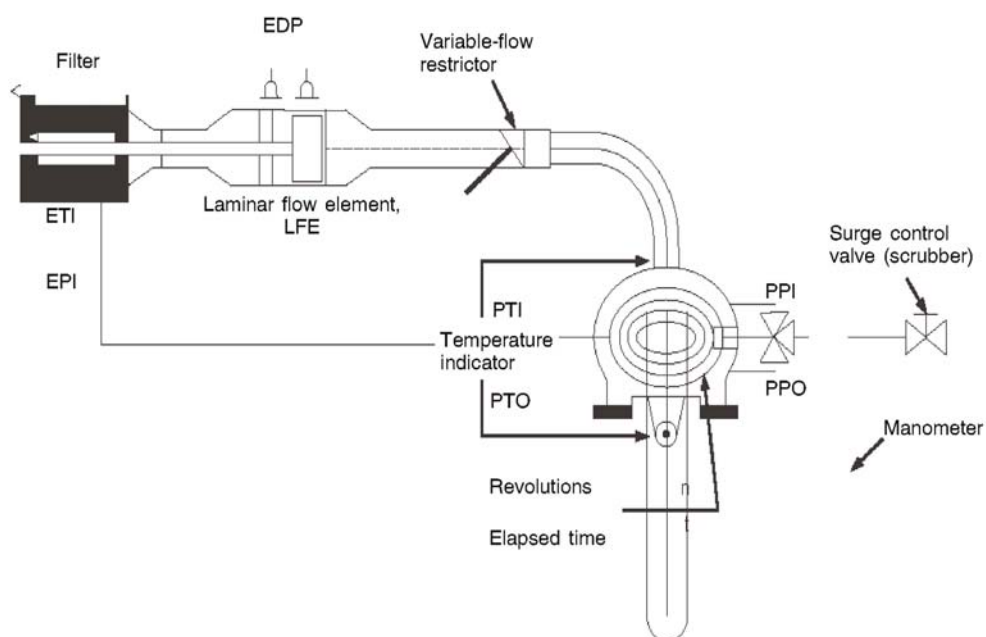

- 3.4.2.5. After the system has been connected as shown in Figure A5/6., the variable restrictor shall be set in the wide-open position and the CVS pump shall run for 20 minutes before starting the calibration.

▼ B

- 3.4.2.5.1. The restrictor valve shall be reset to a more restricted condition in increments of pump inlet depression (about 1 kPa) that will yield a minimum of six data points for the total calibration. The system shall be allowed to stabilize for 3 minutes before the data acquisition is repeated.
- 3.4.2.5.2. The air flow rate Q_s at each test point shall be calculated in standard m^3/min from the flow meter data using the manufacturer's prescribed method.
- 3.4.2.5.3. The air flow rate shall be subsequently converted to pump flow V_0 in m^3/rev at absolute pump inlet temperature and pressure.

$$V_0 = \frac{Q_s}{n} \times \frac{T_p}{273,15 \text{ K}} \times \frac{101,325 \text{ kPa}}{P_p}$$

where:

V_0 is the pump flow rate at T_p and P_p , m^3/rev ;

Q_s is the air flow at 101,325 kPa and 273,15 K (0 °C), m^3/min ;

T_p is the pump inlet temperature, Kelvin (K);

P_p is the absolute pump inlet pressure, kPa;

n is the pump speed, min^{-1} .

- 3.4.2.5.4. To compensate for the interaction of pump speed pressure variations at the pump and the pump slip rate, the correlation function x_0 between the pump speed n , the pressure differential from pump inlet to pump outlet and the absolute pump outlet pressure shall be calculated using the following equation:

$$x_0 = \frac{1}{n} \sqrt{\frac{\Delta P_p}{P_e}}$$

where:

x_0 is the correlation function;

ΔP_p is the pressure differential from pump inlet to pump outlet, kPa;

P_e absolute outlet pressure ($\text{PPO} + P_b$), kPa.

A linear least squares fit shall be performed to generate the calibration equations having the following form:

$$V_0 = D_0 - M \times x_0$$

$$n = A - B \times \Delta P_p$$

where B and M are the slopes, and A and D_0 are the intercepts of the lines.

▼B

- 3.4.2.6. A CVS system having multiple speeds shall be calibrated at each speed used. The calibration curves generated for the ranges shall be approximately parallel and the intercept values, D_0 shall increase as the pump flow range decreases.
- 3.4.2.7. The calculated values from the equation shall be within 0.5 per cent of the measured value of V_0 . Values of M will vary from one pump to another. A calibration shall be performed at initial installation and after major maintenance.
- 3.4.3. Calibration of a critical flow venturi (CFV)
- 3.4.3.1. Calibration of a CFV is based upon the flow equation for a critical venturi:

$$Q_s = \frac{K_v P}{\sqrt{T}}$$

where:

Q_s is the flow, m^3/min ;

K_v is the calibration coefficient;

P is the absolute pressure, kPa;

T is the absolute temperature, Kelvin (K).

Gas flow is a function of inlet pressure and temperature.

The calibration procedure described in paragraph 3.4.3.2. to 3.4.3.3.4. inclusive of this Sub-Annex establishes the value of the calibration coefficient at measured values of pressure, temperature and air flow.

- 3.4.3.2. ►**M3** Measurements for flow calibration of a critical flow venturi are required and the following data shall be within the limits of accuracy given: ◀

Barometric pressure (corrected), $P_b \pm 0,03$ kPa,

LFE air temperature, flow meter, ETI ►**M3** $\pm 0,15$ °C ◀,

Pressure depression upstream of LFE, EPI $\pm 0,01$ kPa,

Pressure drop across LFE matrix, EDP $\pm 0,0015$ kPa,

Air flow, $Q_s \pm 0,5$ per cent,

CFV inlet depression, PPI $\pm 0,02$ kPa,

Temperature at venturi inlet, T_v ►**M3** $\pm 0,2$ °C ◀.

- 3.4.3.3. The equipment shall be set up as shown in Figure A5/7 and checked for leaks. Any leaks between the flow-measuring device and the critical flow venturi will seriously affect the accuracy of the calibration and shall therefore be prevented.

▼B

Figure A5/7
CFV calibration configuration

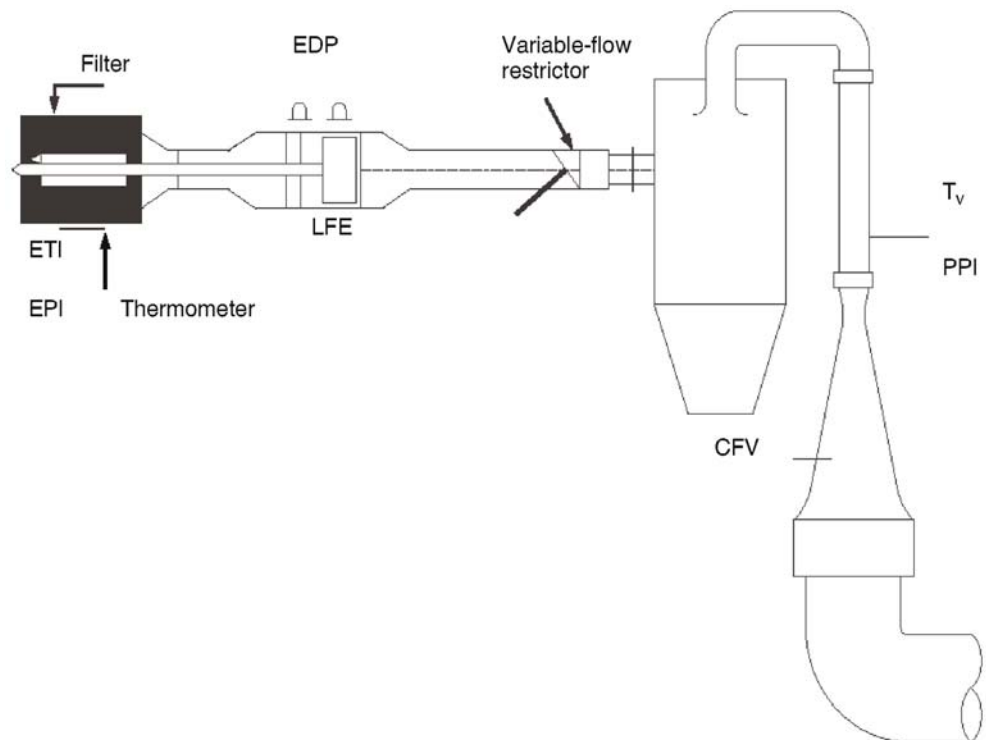

- 3.4.3.3.1. The variable-flow restrictor shall be set to the open position, the suction device shall be started and the system stabilized. Data from all instruments shall be collected.
- 3.4.3.3.2. The flow restrictor shall be varied and at least eight readings across the critical flow range of the venturi shall be made.
- 3.4.3.3.3. The data recorded during the calibration shall be used in the following calculation:
- 3.4.3.3.3.1. The air flow rate, Q_s at each test point shall be calculated from the flow meter data using the manufacturer's prescribed method.

Values of the calibration coefficient shall be calculated for each test point:

$$K_v = \frac{Q_s \sqrt{T_v}}{P_v}$$

where:

Q_s is the flow rate, m³/min at 273,15 K (0 °C) and 101,325, kPa;

T_v is the temperature at the venturi inlet, Kelvin (K);

P_v is the absolute pressure at the venturi inlet, kPa.

▼ B

- 3.4.3.3.3.2. K_v shall be plotted as a function of venturi inlet pressure P_v . For sonic flow K_v will have a relatively constant value. As pressure decreases (vacuum increases), the venturi becomes unchoked and K_v decreases. These values of K_v shall not be used for further calculations.
- 3.4.3.3.3.3. For a minimum of eight points in the critical region, an arithmetic average K_v and the standard deviation shall be calculated.
- 3.4.3.3.3.4. If the standard deviation exceeds 0,3 per cent of the arithmetic average K_v , corrective action shall be taken.
- 3.4.4. Calibration of a subsonic venturi (SSV)
- 3.4.4.1. Calibration of the SSV is based upon the flow equation for a subsonic venturi. Gas flow is a function of inlet pressure and temperature, and the pressure drop between the SSV inlet and throat.
- 3.4.4.2. Data analysis
- 3.4.4.2.1. The airflow rate, Q_{ssv} , at each restriction setting (minimum 16 settings) shall be calculated in standard m^3/s from the flow meter data using the manufacturer's prescribed method. The discharge coefficient, C_d , shall be calculated from the calibration data for each setting using the following equation:

$$C_d = \frac{Q_{ssv}}{d_v^2 \times P_p \times \sqrt{\left\{ \frac{1}{T} \times \left(r_p^{1,426} - r_p^{1,718} \right) \times \left(\frac{1}{1 - r_D^4 \times r_p^{1,426}} \right) \right\}}}$$

where:

Q_{ssv} is the airflow rate at standard conditions (101,325 kPa, 273,15 K (0 °C)), m^3/s ;

T is the temperature at the venturi inlet, Kelvin (K);

d_v is the diameter of the SSV throat, m;

r_p is the ratio of the SSV throat pressure to inlet absolute static pressure, $1 - \frac{\Delta p}{P_p}$;

r_D is the ratio of the SSV throat diameter, d_v , to the inlet pipe inner diameter D ;

C_d is the discharge coefficient of the SSV;

P_p is the absolute pressure at venturi inlet, kPa.

To determine the range of subsonic flow, C_d shall be plotted as a function of Reynolds number Re at the SSV throat. The Reynolds number at the SSV throat shall be calculated using the following equation:

$$Re = A_1 \times \frac{Q_{ssv}}{d_v \times \mu}$$

▼ B

where:

$$\mu = \frac{b \times T^{1.5}}{S + T}$$

A_1 is 25.55152 in SI, $\left(\frac{1}{\text{m}^3}\right)\left(\frac{\text{min}}{\text{s}}\right)\left(\frac{\text{mm}}{\text{m}}\right)$;

Q_{SSV} is the airflow rate at standard conditions (101,325 kPa, 273,15 K (0 °C)), m^3/s ;

d_v is the diameter of the SSV throat, m;

μ is the absolute or dynamic viscosity of the gas, kg/ms;

b is $1,458 \times 10^6$ (empirical constant), $\text{kg}/\text{ms K}^{0.5}$;

S is 110,4 (empirical constant), Kelvin (K).

3.4.4.2.2. Because Q_{SSV} is an input to the Re equation, the calculations shall be started with an initial guess for Q_{SSV} or C_d of the calibration venturi, and repeated until Q_{SSV} converges. The convergence method shall be accurate to at least 0.1 per cent.

3.4.4.2.3. For a minimum of sixteen points in the region of subsonic flow, the calculated values of C_d from the resulting calibration curve fit equation shall be within $\pm 0,5$ per cent of the measured C_d for each calibration point.

3.4.5. Calibration of an ultrasonic flow meter (UFM)

3.4.5.1. The UFM shall be calibrated against a suitable reference flow meter.

3.4.5.2. The UFM shall be calibrated in the CVS configuration that will be used in the test cell (diluted exhaust piping, suction device) and checked for leaks. See Figure A5/8.

3.4.5.3. A heater shall be installed to condition the calibration flow in the event that the UFM system does not include a heat exchanger.

3.4.5.4. For each CVS flow setting that will be used, the calibration shall be performed at temperatures from room temperature to the maximum that will be experienced during vehicle testing.

3.4.5.5. The manufacturer's recommended procedure shall be followed for calibrating the electronic portions (temperature (T) and pressure (P) sensors) of the UFM.

3.4.5.6. ► **M3** Measurements for flow calibration of the ultrasonic flow meter are required and the following data (in the case that a laminar flow element is used) shall be found within the limits of accuracy given: ◀

Barometric pressure (corrected), $P_b \pm 0,03$ kPa,

LFE air temperature, flow meter, ETI ► **M3** $\pm 0,15$ °C ◀,

Pressure depression upstream of LFE, EPI $\pm 0,01$ kPa,

Pressure drop across (EDP) LFE matrix $\pm 0,0015$ kPa,

▼ B

Air flow, $Q_s \pm 0,5$ per cent,

UFM inlet depression, $P_{act} \pm 0,02$ kPa,

Temperature at UFM inlet, $T_{act} \blacktriangleright \underline{\mathbf{M3}} \pm 0,2 \text{ } ^\circ\text{C} \blacktriangleleft$.

3.4.5.7. Procedure

- 3.4.5.7.1. The equipment shall be set up as shown in Figure A5/8 and checked for leaks. Any leaks between the flow-measuring device and the UFM will seriously affect the accuracy of the calibration.

Figure A5/8

UFM calibration configuration

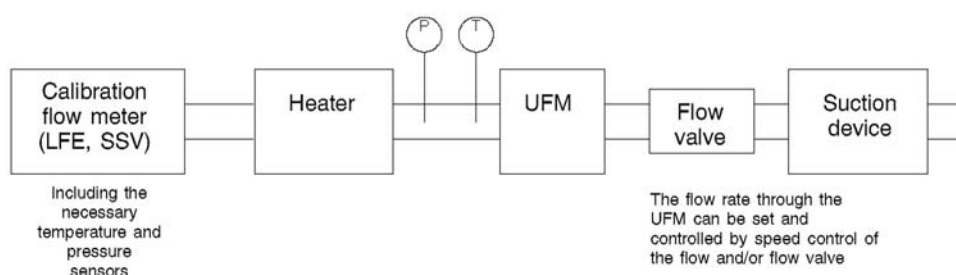

- 3.4.5.7.2. The suction device shall be started. Its speed and/or the position of the flow valve shall be adjusted to provide the set flow for the validation and the system stabilised. Data from all instruments shall be collected.
- 3.4.5.7.3. For UFM systems without a heat exchanger, the heater shall be operated to increase the temperature of the calibration air, allowed to stabilise and data from all the instruments recorded. The temperature shall be increased in reasonable steps until the maximum expected diluted exhaust temperature expected during the emissions test is reached.
- 3.4.5.7.4. The heater shall be subsequently turned off and the suction device speed and/or flow valve shall be adjusted to the next flow setting that will be used for vehicle emissions testing after which the calibration sequence shall be repeated.
- 3.4.5.8. The data recorded during the calibration shall be used in the following calculations. The air flow rate Q_s at each test point shall be calculated from the flow meter data using the manufacturer's prescribed method.

$$K_v = \frac{Q_{\text{reference}}}{Q_s}$$

where:

Q_s is the air flow rate at standard conditions (101,325 kPa, 273,15 K (0 °C)), m^3/s ;

$Q_{\text{reference}}$ is the air flow rate of the calibration flow meter at standard conditions (101,325 kPa, 273,15 K (0 °C)), m^3/s ;

▼ B

K_v is the calibration coefficient.

For UFM systems without a heat exchanger, K_v shall be plotted as a function of T_{act} .

The maximum variation in K_v shall not exceed 0,3 per cent of the arithmetic average K_v value of all the measurements taken at the different temperatures.

3.5. System verification procedure

3.5.1. General requirements

3.5.1.1. The total accuracy of the CVS sampling system and analytical system shall be determined by introducing a known mass of an emissions gas compound into the system whilst it is being operated under normal test conditions and subsequently analysing and calculating the emission gas compounds according to the equations of Sub-Annex 7. The CFO method described in paragraph 3.5.1.1.1. of this Sub-Annex and the gravimetric method described in paragraph 3.5.1.1.2. of this Sub-Annex are both known to give sufficient accuracy.

The maximum permissible deviation between the quantity of gas introduced and the quantity of gas measured is **►M3** ± 2 per cent. ◀

3.5.1.1.1. Critical flow orifice (CFO) method

The CFO method meters a constant flow of pure gas (CO, CO₂, or C₃H₈) using a critical flow orifice device.

▼ M3

A known mass of pure carbon monoxide, carbon dioxide or propane gas shall be introduced into the CVS system through the calibrated critical orifice. If the inlet pressure is high enough, the flow rate q which is restricted by means of the critical flow orifice, is independent of orifice outlet pressure (critical flow). The CVS system shall be operated as in a normal exhaust emissions test and enough time shall be allowed for subsequent analysis. The gas collected in the sample bag shall be analysed by the usual equipment (paragraph 4.1. of this Sub-Annex) and the results compared to the concentration of the known gas samples. If deviations exceed 2 per cent, the cause of the malfunction shall be determined and corrected.

▼ B

3.5.1.1.2. Gravimetric method

The gravimetric method weighs a quantity of pure gas (CO, CO₂, or C₃H₈).

▼ M3

The weight of a small cylinder filled with either pure carbon monoxide, carbon dioxide or propane shall be determined with a precision of $\pm 0,01$ g. The CVS system shall operate under normal exhaust emissions test conditions while the pure gas is injected into the system for a time sufficient for subsequent analysis. The quantity of pure gas involved shall be determined by means of differential weighing. The gas accumulated in the bag shall be analysed by means of the equipment normally used for exhaust gas analysis as described in paragraph 4.1.). The results shall be subsequently compared to the concentration figures computed previously. If deviations exceed ± 2 per cent, the cause of the malfunction shall be determined and corrected.

▼ B

4. Emissions measurement equipment

▼ B

- 4.1. Gaseous emissions measurement equipment
 - 4.1.1. System overview
 - 4.1.1.1. A continuously proportional sample of the diluted exhaust gases and the dilution air shall be collected for analysis.
 - 4.1.1.2. The mass of gaseous emissions shall be determined from the proportional sample concentrations and the total volume measured during the test. Sample concentrations shall be corrected to take into account the respective compound concentrations in dilution air.
 - 4.1.2. Sampling system requirements
 - 4.1.2.1. The sample of diluted exhaust gases shall be taken upstream from the suction device.

▼ M3

With the exception of paragraph 4.1.3.1. (hydrocarbon sampling system), paragraph 4.2. (PM measurement equipment) and paragraph 4.3. (PN measurement equipment), the dilute exhaust gas sample may be taken downstream of the conditioning devices (if any).

▼ B

-
- 4.1.2.2. The bag sampling flow rate shall be set to provide sufficient volumes of dilution air and diluted exhaust in the CVS bags to allow concentration measurement and shall not exceed 0,3 per cent of the flow rate of the dilute exhaust gases, unless the diluted exhaust bag fill volume is added to the integrated CVS volume.
 - 4.1.2.3. A sample of the dilution air shall be taken near the dilution air inlet (after the filter if one is fitted).
 - 4.1.2.4. The dilution air sample shall not be contaminated by exhaust gases from the mixing area.
 - 4.1.2.5. The sampling rate for the dilution air shall be comparable to that used for the dilute exhaust gases.
 - 4.1.2.6. The materials used for the sampling operations shall be such as not to change the concentration of the emissions compounds.
 - 4.1.2.7. Filters may be used in order to extract the solid particles from the sample.
 - 4.1.2.8. Any valve used to direct the exhaust gases shall be of a quick-adjustment, quick-acting type.
 - 4.1.2.9. Quick-fastening, gas-tight connections may be used between three-way valves and the sample bags, the connections sealing themselves automatically on the bag side. Other systems may be used for conveying the samples to the analyser (e.g. three-way stop valves).
 - 4.1.2.10. Sample storage
 - 4.1.2.10.1. The gas samples shall be collected in sample bags of sufficient capacity so as not to impede the sample flow.
 - 4.1.2.10.2. The bag material shall be such as to affect neither the measurements themselves nor the chemical composition of the gas samples by more than ± 2 per cent after 30 minutes (e.g., laminated polyethylene/polyamide films, or fluorinated polyhydrocarbons).

▼ B

- 4.1.3. Sampling systems
- 4.1.3.1. Hydrocarbon sampling system (heated flame ionisation detector, HFID)
- 4.1.3.1.1. The hydrocarbon sampling system shall consist of a heated sampling probe, line, filter and pump. The sample shall be taken upstream of the heat exchanger (if fitted). The sampling probe shall be installed at the same distance from the exhaust gas inlet as the particulate sampling probe and in such a way that neither interferes with samples taken by the other. It shall have a minimum internal diameter of 4 mm.
- 4.1.3.1.2. All heated parts shall be maintained at a temperature of 190 °C ± 10 °C by the heating system.
- 4.1.3.1.3. The arithmetic average concentration of the measured hydrocarbons shall be determined by integration of the second-by-second data divided by the phase or test duration.
- 4.1.3.1.4. The heated sampling line shall be fitted with a heated filter F_H having a 99 per cent efficiency for particles $\geq 0,3 \mu\text{m}$ to extract any solid particles from the continuous flow of gas required for analysis.
- 4.1.3.1.5. The sampling system delay time (from the probe to the analyser inlet) shall be no more than 4 seconds.
- 4.1.3.1.6. The HFID shall be used with a constant mass flow (heat exchanger) system to ensure a representative sample, unless compensation for varying CVS volume flow is made.
- 4.1.3.2. NO or NO₂ sampling system (where applicable)
- 4.1.3.2.1. A continuous sample flow of diluted exhaust gas shall be supplied to the analyser.
- 4.1.3.2.2. The arithmetic average concentration of the NO or NO₂ shall be determined by integration of the second-by-second data divided by the phase or test duration.
- 4.1.3.2.3. The continuous NO or NO₂ measurement shall be used with a constant flow (heat exchanger) system to ensure a representative sample, unless compensation for varying CVS volume flow is made.
- 4.1.4. Analysers
- 4.1.4.1. General requirements for gas analysis
- 4.1.4.1.1. The analysers shall have a measuring range compatible with the accuracy required to measure the concentrations of the exhaust gas sample compounds.
- 4.1.4.1.2. If not defined otherwise, measurement errors shall not exceed ± 2 per cent (intrinsic error of analyser) disregarding the reference value for the calibration gases.
- 4.1.4.1.3. The ambient air sample shall be measured on the same analyser with the same range.
- 4.1.4.1.4. No gas drying device shall be used before the analysers unless it is shown to have no effect on the content of the compound in the gas stream.
- 4.1.4.2. Carbon monoxide (CO) and carbon dioxide (CO₂) analysis

▼ M3

The analysers shall be of the non-dispersive infrared (NDIR) absorption type.

▼ B

4.1.4.3. Hydrocarbons (HC) analysis for all fuels other than diesel fuel

▼ M3

The analyser shall be of the flame ionization (FID) type calibrated with propane gas expressed in equivalent carbon atoms (C 1).

▼ B

4.1.4.4. Hydrocarbons (HC) analysis for diesel fuel and optionally for other fuels

▼ M3

The analyser shall be of the heated flame ionization type with detector, valves, pipework, etc., heated to $190\text{ °C} \pm 10\text{ °C}$. It shall be calibrated with propane gas expressed equivalent to carbon atoms (C 1).

▼ B

4.1.4.5. Methane (CH₄) analysis

▼ M3

The analyser shall be either a gas chromatograph combined with a flame ionization detector (FID), or a flame ionization detector (FID) combined with a non-methane cutter (NMC-FID), calibrated with methane or propane gas expressed equivalent to carbon atoms (C 1).

▼ B

4.1.4.6. Nitrogen oxides (NO_x) analysis

▼ M3

The analysers shall be of chemiluminescent (CLA) or non-dispersive ultra-violet resonance absorption (NDUV) types.

▼ B

4.1.5. Recommended system descriptions

4.1.5.1. Figure A5/9 is a schematic drawing of the gaseous emissions sampling system.

Figure A5/9

Full flow exhaust dilution system schematic

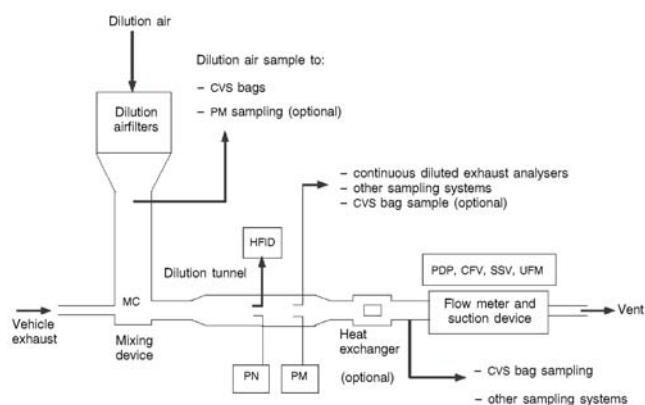

▼ B

- 4.1.5.2. Examples of system components are as listed below.
 - 4.1.5.2.1. Two sampling probes for continuous sampling of the dilution air and of the diluted exhaust gas/air mixture.
 - 4.1.5.2.2. A filter to extract solid particles from the flows of gas collected for analysis.
 - 4.1.5.2.3. Pumps and flow controller to ensure constant uniform flow of diluted exhaust gas and dilution air samples taken during the course of the test from sampling probes and flow of the gas samples shall be such that, at the end of each test, the quantity of the samples is sufficient for analysis.
 - 4.1.5.2.4. Quick-acting valves to divert a constant flow of gas samples into the sample bags or to the outside vent.
 - 4.1.5.2.5. Gas-tight, quick-lock coupling elements between the quick-acting valves and the sample bags. The coupling shall close automatically on the sampling bag side. As an alternative, other methods of transporting the samples to the analyser may be used (three-way stopcocks, for instance).
 - 4.1.5.2.6. Bags for collecting samples of the diluted exhaust gas and of the dilution air during the test.
 - 4.1.5.2.7. A sampling critical flow venturi to take proportional samples of the diluted exhaust gas (CFV-CVS only).
- 4.1.5.3. Additional components required for hydrocarbon sampling using a heated flame ionization detector (HFID) as shown in Figure A5/10.
 - 4.1.5.3.1. Heated sample probe in the dilution tunnel located in the same vertical plane as the particulate and particle sample probes.
 - 4.1.5.3.2. Heated filter located after the sampling point and before the HFID.
 - 4.1.5.3.3. Heated selection valves between the zero/calibration gas supplies and the HFID.
 - 4.1.5.3.4. Means of integrating and recording instantaneous hydrocarbon concentrations.
 - 4.1.5.3.5. Heated sampling lines and heated components from the heated probe to the HFID.

▼B

Figure A5/10

Components required for hydrocarbon sampling using an HFID

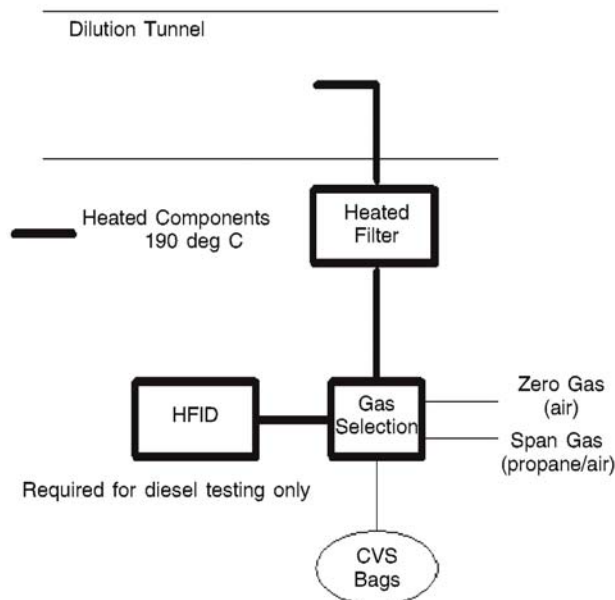

4.2. PM measurement equipment

4.2.1. Specification

4.2.1.1. System overview

4.2.1.1.1. The particulate sampling unit shall consist of a sampling probe (PSP), located in the dilution tunnel, a particle transfer tube (PTT), a filter holder(s) (FH), pump(s), flow rate regulators and measuring units. See Figures A5/11, A5/12 and A5/13.

4.2.1.1.2. A particle size pre-classifier (PCF), (e.g. cyclone or impactor) may be used. In such case, it is recommended that it be employed upstream of the filter holder.

Figure A5/11

Alternative particulate sampling probe configuration

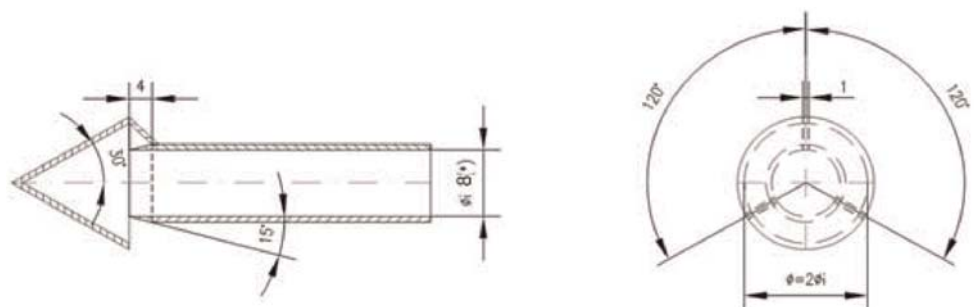

(*) Minimum internal diameter
Wall thickness ~ 1mm – Material: stainless steel

▼B

- 4.2.1.2. General requirements
- 4.2.1.2.1. The sampling probe for the test gas flow for particulate shall be arranged within the dilution tunnel so that a representative sample gas flow can be taken from the homogeneous air/exhaust mixture and shall be upstream of a heat exchanger (if any).
- 4.2.1.2.2. The particulate sample flow rate shall be proportional to the total mass flow of diluted exhaust gas in the dilution tunnel to within a tolerance of ± 5 per cent of the particulate sample flow rate. The verification of the proportionality of the particulate sampling shall be made during the commissioning of the system and as required by the approval authority.
- 4.2.1.2.3. The sampled dilute exhaust gas shall be maintained at a temperature above 20 °C and below 52 °C within 20 cm upstream or downstream of the particulate sampling filter face. Heating or insulation of components of the particulate sampling system to achieve this is permitted.
- In the event that the 52 °C limit is exceeded during a test where periodic regeneration event does not occur, the CVS flow rate shall be increased or double dilution shall be applied (assuming that the CVS flow rate is already sufficient so as not to cause condensation within the CVS, sample bags or analytical system).
- 4.2.1.2.4. The particulate sample shall be collected on a single filter mounted within a holder in the sampled dilute exhaust gas flow.
- 4.2.1.2.5. All parts of the dilution system and the sampling system from the exhaust pipe up to the filter holder that are in contact with raw and diluted exhaust gas shall be designed to minimise deposition or alteration of the particulate. All parts shall be made of electrically conductive materials that do not react with exhaust gas components, and shall be electrically grounded to prevent electrostatic effects.
- 4.2.1.2.6. If it is not possible to compensate for variations in the flow rate, provision shall be made for a heat exchanger and a temperature control device as specified in paragraphs 3.3.5.1. or 3.3.6.4.2. of this Sub-Annex, so as to ensure that the flow rate in the system is constant and the sampling rate accordingly proportional.

▼M3

- 4.2.1.2.7. Temperatures required for the measurement of PM shall be measured with an accuracy of ± 1 °C and a response time ($t_{90} - t_{10}$) of 15 seconds or less.

▼B

- 4.2.1.2.8. The sample flow from the dilution tunnel shall be measured with an accuracy of ± 2.5 per cent of reading or ± 1.5 per cent full scale, whichever is the least.

The accuracy specified above of the sample flow from the CVS tunnel is also applicable where double dilution is used. Consequently, the measurement and control of the secondary dilution air flow and diluted exhaust flow rates through the filter shall be of a higher accuracy.

- 4.2.1.2.9. All data channels required for the measurement of PM shall be logged at a frequency of 1 Hz or faster. Typically these would include:

▼ B

- (a) Diluted exhaust temperature at the particulate sampling filter;
- (b) Sampling flow rate;
- (c) Secondary dilution air flow rate (if secondary dilution is used);
- (d) Secondary dilution air temperature (if secondary dilution is used).

4.2.1.2.10. For double dilution systems, the accuracy of the diluted exhaust transferred from the dilution tunnel V_{ep} defined in paragraph 3.3.2. of Sub-Annex 7 in the equation is not measured directly but determined by differential flow measurement.

The accuracy of the flow meters used for the measurement and control of the double diluted exhaust passing through the particulate sampling filters and for the measurement/control of secondary dilution air shall be sufficient so that the differential volume V_{ep} shall meet the accuracy and proportional sampling requirements specified for single dilution.

The requirement that no condensation of the exhaust gas occur in the CVS dilution tunnel, diluted exhaust flow rate measurement system, CVS bag collection or analysis systems shall also apply in the case that double dilution systems are used.

4.2.1.2.11. Each flow meter used in a particulate sampling and double dilution system shall be subjected to a linearity verification as required by the instrument manufacturer.

Figure A5/12

Particulate sampling system

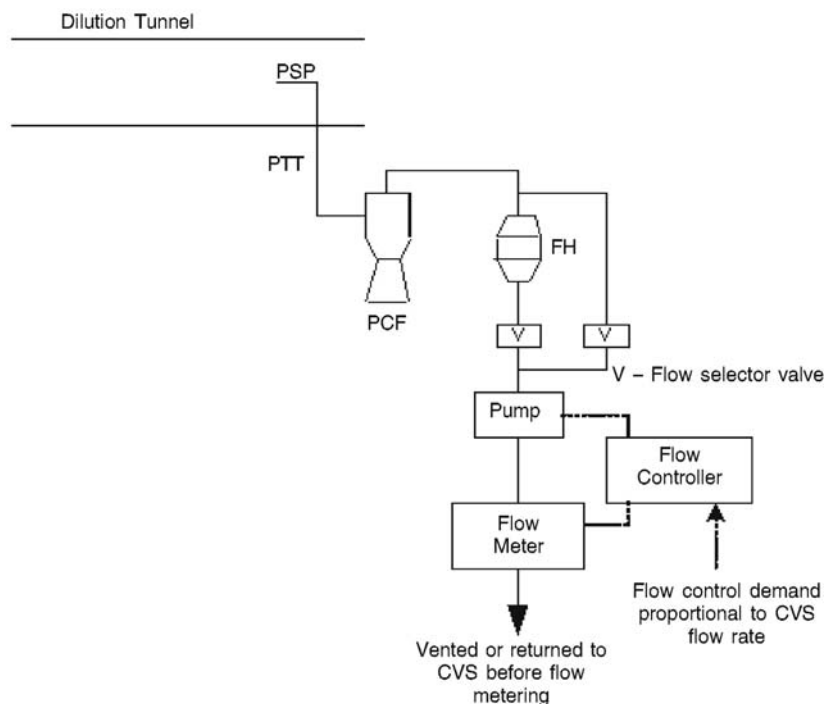

▼ B

Figure A5/13

Double dilution particulate sampling system

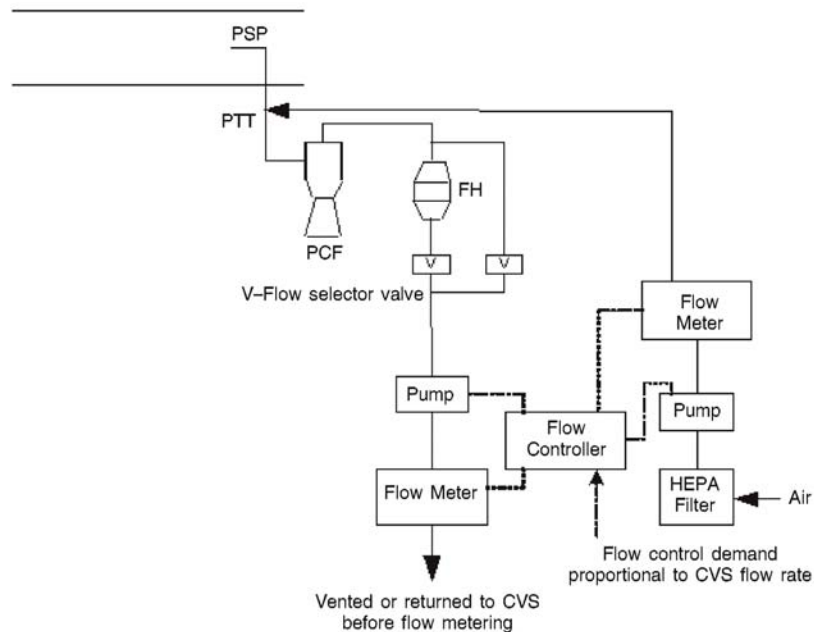

4.2.1.3. Specific requirements

4.2.1.3.1. Sample probe

4.2.1.3.1.1. The sample probe shall deliver the particle size classification performance specified in paragraph 4.2.1.3.1.4. of this Sub-Annex. It is recommended that this performance be achieved by the use of a sharp-edged, open-ended probe facing directly into the direction of flow plus a pre-classifier (cyclone impactor, etc.). An appropriate sample probe, such as that indicated in Figure A5/11, may alternatively be used provided it achieves the pre-classification performance specified in paragraph 4.2.1.3.1.4. of this Sub-Annex.

4.2.1.3.1.2. The sample probe shall be installed at least 10 tunnel diameters downstream of the exhaust gas inlet to the tunnel and have an internal diameter of at least 8 mm.

If more than one simultaneous sample is drawn from a single sample probe, the flow drawn from that probe shall be split into identical sub-flows to avoid sampling artefacts.

If multiple probes are used, each probe shall be sharp-edged, open-ended and facing directly into the direction of flow. Probes shall be equally spaced around the central longitudinal axis of the dilution tunnel, with a spacing between probes of at least 5 cm.

4.2.1.3.1.3. The distance from the sampling tip to the filter mount shall be at least five probe diameters, but shall not exceed 2 000 mm.

▼ B

4.2.1.3.1.4. The pre-classifier (e.g. cyclone, impactor, etc.) shall be located upstream of the filter holder assembly. The pre-classifier 50 per cent cut point particle diameter shall be between 2,5 µm and 10 µm at the volumetric flow rate selected for sampling PM. The pre-classifier shall allow at least 99 per cent of the mass concentration of 1 µm particles entering the pre-classifier to pass through the exit of the pre-classifier at the volumetric flow rate selected for sampling PM.

4.2.1.3.2. Particle transfer tube (PTT)

▼ M3

Any bends in the PTT shall be smooth and have the largest possible radii.

▼ B

4.2.1.3.3. Secondary dilution

4.2.1.3.3.1. As an option, the sample extracted from the CVS for the purpose of PM measurement may be diluted at a second stage, subject to the following requirements:

4.2.1.3.3.1.1. Secondary dilution air shall be filtered through a medium capable of reducing particles in the most penetrating particle size of the filter material by $\geq 99,95$ per cent, or through a HEPA filter of at least class H13 of EN 1822:2009. The dilution air may optionally be charcoal-scrubbed before being passed to the HEPA filter. It is recommended that an additional coarse particle filter be situated before the HEPA filter and after the charcoal scrubber, if used.

4.2.1.3.3.1.2. The secondary dilution air should be injected into the PTT as close to the outlet of the diluted exhaust from the dilution tunnel as possible.

4.2.1.3.3.1.3. The residence time from the point of secondary diluted air injection to the filter face shall be at least 0.25 seconds, but no longer than 5 seconds.

4.2.1.3.3.1.4. If the double diluted sample is returned to the CVS, the location of the sample return shall be selected so that it does not interfere with the extraction of other samples from the CVS.

4.2.1.3.4. Sample pump and flow meter

4.2.1.3.4.1. The sample gas flow measurement unit shall consist of pumps, gas flow regulators and flow measuring units.

4.2.1.3.4.2. The temperature of the gas flow in the flow meter may not fluctuate by more than ± 3 °C except:

(a) When the sampling flow meter has real time monitoring and flow control operating at a frequency of 1 Hz or faster;

(b) During regeneration tests on vehicles equipped with periodically regenerating after-treatment devices.

Should the volume of flow change unacceptably as a result of excessive filter loading, the test shall be invalidated. When it is repeated, the flow rate shall be decreased.

4.2.1.3.5. Filter and filter holder

4.2.1.3.5.1. A valve shall be located downstream of the filter in the direction of flow. The valve shall open and close within 1 second of the start and end of test.

▼B

4.2.1.3.5.2. For a given test, the gas filter face velocity shall be set to an initial value within the range 20 cm/s to 105 cm/s and shall be set at the start of the test so that 105 cm/s will not be exceeded when the dilution system is being operated with sampling flow proportional to CVS flow rate.

4.2.1.3.5.3. Fluorocarbon coated glass fibre filters or fluorocarbon membrane filters shall be used.

All filter types shall have a 0,3 µm DOP (di-octylphthalate) or PAO (poly-alpha-olefin) CS 68649-12-7 or CS 68037-01-4 collection efficiency of at least 99 per cent at a gas filter face velocity of 5,33 cm/s measured according to one of the following standards:

- (a) U.S.A. Department of Defense Test Method Standard, MIL-STD-282 method 102.8: DOP-Smoke Penetration of Aerosol-Filter Element;
- (b) U.S.A. Department of Defense Test Method Standard, MIL-STD-282 method 502.1.1: DOP-Smoke Penetration of Gas-Mask Canisters;
- (c) Institute of Environmental Sciences and Technology, IEST-RP-CC021: Testing HEPA and ULPA Filter Media.

4.2.1.3.5.4. The filter holder assembly shall be of a design that provides an even flow distribution across the filter stain area. The filter shall be round and have a stain area of at least 1 075 mm².

4.2.2. Weighing chamber (or room) and analytical balance specifications

4.2.2.1. Weighing chamber (or room) conditions

- (a) The temperature of the weighing chamber (or room) in which the particulate sampling filters are conditioned and weighed shall be maintained to within 22 °C ± 2 °C (22 °C ± 1 °C if possible) during all filter conditioning and weighing.
- (b) Humidity shall be maintained at a dew point of less than 10.5 °C and a relative humidity of 45 per cent ± 8 per cent.
- (c) Limited deviations from weighing chamber (or room) temperature and humidity specifications shall be permitted provided their total duration does not exceed 30 minutes in any one filter conditioning period.
- (d) The levels of ambient contaminants in the weighing chamber (or room) environment that would settle on the particulate sampling filters during their stabilisation shall be minimised.
- (e) During the weighing operation no deviations from the specified conditions are permitted.

▼M3

4.2.2.2. Linear response of an analytical balance

The analytical balance used to determine the filter weight shall meet the linearity verification criteria of Table A5/1 applying a linear regression. This implies a precision of at least ± 2 µg and a resolution of at least 1 µg (1 digit = 1 µg). At least 4 equally-spaced reference weights shall be tested. The zero value shall be within ± 1 µg.

▼ M3

Table A5/1

Analytical balance verification criteria

Measurement system	Intercept a0	Slope a1	Standard error of estimate (SEE)	Coefficient of determination r ²
Particulate balance	≤ 1 µg	0,99 – 1,01	≤ 1 per cent max	≥ 0,998

▼ B

4.2.2.3. Elimination of static electricity effects

The effects of static electricity shall be nullified. This may be achieved by grounding the balance through placement upon an antistatic mat and neutralization of the particulate sampling filters prior to weighing using a polonium neutraliser or a device of similar effect. Alternatively, nullification of static effects may be achieved through equalization of the static charge.

4.2.2.4. Buoyancy correction

The sample and reference filter weights shall be corrected for their buoyancy in air. The buoyancy correction is a function of sampling filter density, air density and the density of the balance calibration weight, and does not account for the buoyancy of the particulate matter itself.

If the density of the filter material is not known, the following densities shall be used:

- (a) PTFE coated glass fibre filter: 2 300 kg/m³;
- (b) PTFE membrane filter: 2 144 kg/m³;
- (c) PTFE membrane filter with polymethylpentene support ring: 920 kg/m³.

For stainless steel calibration weights, a density of 8 000 kg/m³ shall be used. If the material of the calibration weight is different, its density shall be known and be used. International Recommendation OIML R 111-1 Edition 2004(E) (or equivalent) from International Organization of Legal Metrology on calibration weights should be followed.

The following equation shall be used:

$$m_f = m_{\text{uncorr}} \times \left(\frac{1 - \frac{\rho_a}{\rho_w}}{1 - \frac{\rho_a}{\rho_f}} \right)$$

where:

m_f is the corrected particulate sample mass, mg;

m_{uncorr} is the uncorrected particulate sample mass, mg;

ρ_a is the density of the air, kg/m³;

ρ_w is the density of balance calibration weight, kg/m³;

▼ B

ρ_f is the density of the particulate sampling filter, kg/m³.

The density of the air ρ_a shall be calculated using the following equation:

$$\rho_a = \frac{p_b \times M_{\text{mix}}}{R \times T_a}$$

p_b is the total atmospheric pressure, kPa;

T_a is the air temperature in the balance environment, Kelvin (K);

M_{mix} is the molar mass of air in a balanced environment, 28,836 g mol⁻¹;

R is the molar gas constant, 8,3144 J mol⁻¹ K⁻¹.

4.3. PN measurement equipment

4.3.1. Specification

4.3.1.1. System overview

4.3.1.1.1. The particle sampling system shall consist of a probe or sampling point extracting a sample from a homogeneously mixed flow in a dilution system, a volatile particle remover (VPR) upstream of a particle number counter (PNC) and suitable transfer tubing. See Figure A5/14.

4.3.1.1.2. It is recommended that a particle size pre-classifier (PCF) (e.g. cyclone, impactor, etc.) be located prior to the inlet of the VPR. The PCF 50 per cent cut point particle diameter shall be between 2.5 μm and 10 μm at the volumetric flow rate selected for particle sampling. The PCF shall allow at least 99 per cent of the mass concentration of 1 μm particles entering the PCF to pass through the exit of the PCF at the volumetric flow rate selected for particle sampling.

A sample probe acting as an appropriate size-classification device, such as that shown in Figure A5/11, is an acceptable alternative to the use of a PCF.

4.3.1.2. General requirements

4.3.1.2.1. The particle sampling point shall be located within a dilution system. In the case that a double dilution system is used, the particle sampling point shall be located within the primary dilution system.

4.3.1.2.1.1. The sampling probe tip or PSP, and the PTT, together comprise the particle transfer system (PTS). The PTS conducts the sample from the dilution tunnel to the entrance of the VPR. The PTS shall meet the following conditions:

(a) The sampling probe shall be installed at least 10 tunnel diameters downstream of the exhaust gas inlet, facing upstream into the tunnel gas flow with its axis at the tip parallel to that of the dilution tunnel;

▼B

- (b) The sampling probe shall be upstream of any conditioning device (e.g. heat exchanger);
 - (c) The sampling probe shall be positioned within the dilution tunnel so that the sample is taken from a homogeneous diluent/exhaust mixture.
- 4.3.1.2.1.2. Sample gas drawn through the PTS shall meet the following conditions:
- (a) In the case that a full flow exhaust dilution system, is used it shall have a flow Reynolds number, Re , lower than 1 700;
 - (b) In the case that a double dilution system is used, it shall have a flow Reynolds number Re lower than 1 700 in the PTT i.e. downstream of the sampling probe or point;
 - (c) Shall have a residence time ≤ 3 seconds.
- 4.3.1.2.1.3. Any other sampling configuration for the PTS for which equivalent particle penetration at 30 nm can be demonstrated shall be considered acceptable.
- 4.3.1.2.1.4. The outlet tube (OT), conducting the diluted sample from the VPR to the inlet of the PNC, shall have the following properties:
- (a) An internal diameter ≥ 4 mm;
 - (b) A sample gas flow residence time of $\leq 0,8$ seconds.
- 4.3.1.2.1.5. Any other sampling configuration for the OT for which equivalent particle penetration at 30 nm can be demonstrated shall be considered acceptable.
- 4.3.1.2.2. The VPR shall include devices for sample dilution and for volatile particle removal.
- 4.3.1.2.3. All parts of the dilution system and the sampling system from the exhaust pipe up to the PNC, which are in contact with raw and diluted exhaust gas, shall be designed to minimize deposition of the particles. All parts shall be made of electrically conductive materials that do not react with exhaust gas components, and shall be electrically grounded to prevent electrostatic effects.
- 4.3.1.2.4. The particle sampling system shall incorporate good aerosol sampling practice that includes the avoidance of sharp bends and abrupt changes in cross-section, the use of smooth internal surfaces and the minimization of the length of the sampling line. Gradual changes in the cross-section are permitted.
- 4.3.1.3. Specific requirements
- 4.3.1.3.1. The particle sample shall not pass through a pump before passing through the PNC.
- 4.3.1.3.2. A sample pre-classifier is recommended.
- 4.3.1.3.3. The sample preconditioning unit shall:

▼B

- (a) Be capable of diluting the sample in one or more stages to achieve a particle number concentration below the upper threshold of the single particle count mode of the PNC and a gas temperature below 35 °C at the inlet to the PNC;
- (b) Include an initial heated dilution stage that outputs a sample at a temperature of ≥ 150 °C and ≤ 350 °C ± 10 °C, and dilutes by a factor of at least 10;
- (c) Control heated stages to constant nominal operating temperatures, within the range ≥ 150 °C and ≤ 400 °C ± 10 °C;
- (d) Provide an indication of whether or not heated stages are at their correct operating temperatures;
- (e) Be designed to achieve a solid particle penetration efficiency of at least 70 per cent for particles of 100 nm electrical mobility diameter;
- (f) Achieve a particle concentration reduction factor $f_r(d_i)$ for particles of 30 nm and 50 nm electrical mobility diameters that is no more than 30 per cent and 20 per cent respectively higher, and no more than 5 per cent lower than that for particles of 100 nm electrical mobility diameter for the VPR as a whole;

The particle concentration reduction factor at each particle size $f_r(d_i)$ shall be calculated using the following equation:

$$f_r(d_i) = \frac{N_{in}(d_i)}{N_{out}(d_i)}$$

where:

$N_{in}(d_i)$ is the upstream particle number concentration for particles of diameter d_i ;

$N_{out}(d_i)$ is the downstream particle number concentration for particles of diameter d_i ;

d_i is the particle electrical mobility diameter (30, 50 or 100 nm).

$N_{in}(d_i)$ and $N_{out}(d_i)$ shall be corrected to the same conditions.

The arithmetic average particle concentration reduction factor at a given dilution setting \bar{f}_r shall be calculated using the following equation:

$$\bar{f}_r = \frac{f_r(30 \text{ nm}) + f_r(50 \text{ nm}) + f_r(100 \text{ nm})}{3}$$

It is recommended that the VPR is calibrated and validated as a complete unit;

- (g) Be designed according to good engineering practice to ensure particle concentration reduction factors are stable across a test;

▼B

- (h) Also achieve > 99,0 per cent vaporization of 30 nm tetracontane ($\text{CH}_3(\text{CH}_2)_{38}\text{CH}_3$) particles, with an inlet concentration of $\geq 10\,000$ per cm^3 , by means of heating and reduction of partial pressures of the tetracontane.

4.3.1.3.4. The PNC shall:

- (a) Operate under full flow operating conditions;
- (b) Have a counting accuracy of ± 10 per cent across the range 1 per cm^3 to the upper threshold of the single particle count mode of the PNC against a suitable traceable standard. At concentrations below 100 per cm^3 , measurements averaged over extended sampling periods may be required to demonstrate the accuracy of the PNC with a high degree of statistical confidence;
- (c) Have a resolution of at least 0.1 particles per cm^3 at concentrations below 100 per cm^3 ;
- (d) Have a linear response to particle number concentrations over the full measurement range in single particle count mode;
- (e) Have a data reporting frequency equal to or greater than a frequency of 0,5 Hz;
- (f) Have a t_{90} response time over the measured concentration range of less than 5 seconds;
- (g) Incorporate a coincidence correction function up to a maximum 10 per cent correction, and may make use of an internal calibration factor as determined in paragraph 5.7.1.3. of this Sub-Annex but shall not make use of any other algorithm to correct for or define the counting efficiency;
- (h) Have counting efficiencies at the different particle sizes as specified in Table A5/2.

Table A5/2

PNC counting efficiency

Particle size electrical mobility diameter (nm)	PNC counting efficiency (per cent)
23 ± 1	50 ± 12
41 ± 1	> 90

4.3.1.3.5. If the PNC makes use of a working liquid, it shall be replaced at the frequency specified by the instrument manufacturer.

4.3.1.3.6. Where not held at a known constant level at the point at which PNC flow rate is controlled, the pressure and/or temperature at the PNC inlet shall be measured for the purposes of correcting particle number concentration measurements to standard conditions.

4.3.1.3.7. The sum of the residence time of the PTS, VPR and OT plus the t_{90} response time of the PNC shall be no greater than 20 seconds.

▼B

4.3.1.4. Recommended system description

The following paragraph contains the recommended practice for measurement of PN. However, systems meeting the performance specifications in paragraphs 4.3.1.2. and 4.3.1.3. of this Sub-Annex are acceptable.

Figure A5/14

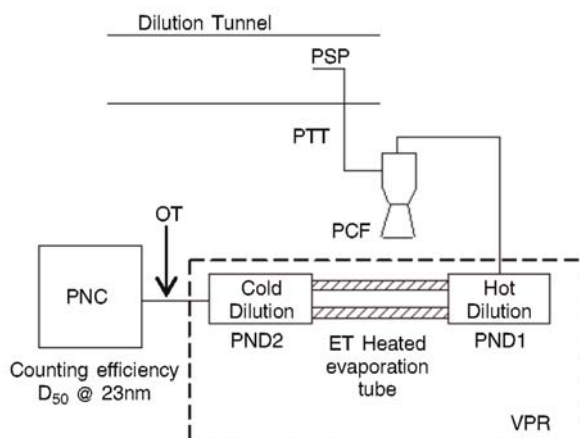
A recommended particle sampling system

4.3.1.4.1. Sampling system description

4.3.1.4.1.1. The particle sampling system shall consist of a sampling probe tip or particle sampling point in the dilution system, a PTT, a PCF, and a VPR, upstream of the PNC unit.

4.3.1.4.1.2. The VPR shall include devices for sample dilution (particle number diluters: PND₁ and PND₂) and particle evaporation (evaporation tube, ET).

4.3.1.4.1.3. The sampling probe or sampling point for the test gas flow shall be arranged within the dilution tunnel so that a representative sample gas flow is taken from a homogeneous diluent/exhaust mixture.

5. Calibration intervals and procedures

5.1. Calibration intervals

Table A5/3

Instrument calibration intervals

Instrument checks	Interval	Criterion
Gas analyser linearization (calibration)	Every 6 months	± 2 per cent of reading
Mid span	Every 6 months	± 2 per cent
CO NDIR:CO ₂ /H ₂ O interference	Monthly	– 1 to 3 ppm
NO _x converter check	Monthly	> 95 per cent
CH ₄ cutter check	Yearly	98 per cent of ethane
FID CH ₄ response	Yearly	See paragraph 5.4.3. of this Sub-Annex

▼B

Instrument checks	Interval	Criterion
FID air/fuel flow	At major maintenance	According to instrument manufacturer.
Laser infrared spectrometers (modulated high resolution narrow band infrared analysers): interference check	Yearly or at major maintenance	According to instrument manufacturer.
QCL	Yearly or at major maintenance	According to instrument manufacturer.
GC methods	See paragraph 7.2. of this Sub-Annex	See paragraph 7.2. of this Sub-Annex
LC methods	Yearly or at major maintenance	According to instrument manufacturer.
Photoacoustics	Yearly or at major maintenance	According to instrument manufacturer.
Microgram balance linearity	Yearly or at major maintenance	See paragraph 4.2.2.2. of this Sub-Annex
PNC (particle number counter)	See paragraph 5.7.1.1. of this Sub-Annex	See paragraph 5.7.1.3. of this Sub-Annex
VPR (volatile particle remover)	See paragraph 5.7.2.1. of this Sub-Annex	See paragraph 5.7.2. of this Sub-Annex

Table A5/4

Constant volume sampler (CVS) calibration intervals

CVS	Interval	Criterion
CVS flow	After overhaul	± 2 per cent
Dilution flow	Yearly	± 2 per cent
Temperature sensor	Yearly	± 1 °C
Pressure sensor	Yearly	± 0,4 kPa
Injection check	Weekly	± 2 per cent

Table A5/5

Environmental data calibration intervals

Climate	Interval	Criterion
Temperature	Yearly	± 1 °C
Moisture dew	Yearly	± 5 per cent RH
Ambient pressure	Yearly	± 0,4 kPa
Cooling fan	After overhaul	According to paragraph 1.1.1. of this Sub-Annex

- 5.2. Analyser calibration procedures
- 5.2.1. Each analyser shall be calibrated as specified by the instrument manufacturer or at least as often as specified in Table A5/3.
- 5.2.2. Each normally used operating range shall be linearized by the following procedure:

▼ B

- 5.2.2.1. The analyser linearization curve shall be established by at least five calibration points spaced as uniformly as possible. The nominal concentration of the calibration gas of the highest concentration shall be not less than 80 per cent of the full scale.
- 5.2.2.2. The calibration gas concentration required may be obtained by means of a gas divider, diluting with purified N₂ or with purified synthetic air.
- 5.2.2.3. The linearization curve shall be calculated by the least squares method. If the resulting polynomial degree is greater than 3, the number of calibration points shall be at least equal to this polynomial degree plus 2.
- 5.2.2.4. The linearization curve shall not differ by more than ± 2 per cent from the nominal value of each calibration gas.
- 5.2.2.5. From the trace of the linearization curve and the linearization points it is possible to verify that the calibration has been carried out correctly. The different characteristic parameters of the analyser shall be indicated, particularly:
- (a) Analyser and gas component;
 - (b) Range;
 - (c) Date of linearisation.
- 5.2.2.6. If the approval authority is satisfied that alternative technologies (e.g. computer, electronically controlled range switch, etc.) give equivalent accuracy, these alternatives may be used.
- 5.3. Analyser zero and calibration verification procedure
- 5.3.1. Each normally used operating range shall be checked prior to each analysis in accordance with paragraphs 5.3.1.1. and 5.3.1.2. of this Sub-Annex

▼ M3

- 5.3.1.1. The calibration shall be checked by use of a zero gas and by use of a calibration gas in accordance with paragraph 2.14.2.3. of Sub-Annex 6.
- 5.3.1.2. After testing, zero gas and the same calibration gas shall be used for re-checking in accordance with paragraph 2.14.2.4. of Sub-Annex 6.

▼ B

- 5.4. FID hydrocarbon response check procedure
- 5.4.1. Detector response optimization
- The FID shall be adjusted as specified by the instrument manufacturer. Propane in air shall be used on the most common operating range.
- 5.4.2. Calibration of the HC analyser
- 5.4.2.1. The analyser shall be calibrated using propane in air and purified synthetic air.
- 5.4.2.2. A calibration curve as described in paragraph 5.2.2. of this Sub-Annex shall be established.
- 5.4.3. Response factors of different hydrocarbons and recommended limits

▼B

- 5.4.3.1. The response factor R_f for a particular hydrocarbon compound is the ratio of the FID C_1 reading to the gas cylinder concentration, expressed as ppm C_1 .

The concentration of the test gas shall be at a level to give a response of approximately 80 per cent of full-scale deflection for the operating range. The concentration shall be known to an accuracy of ± 2 per cent in reference to a gravimetric standard expressed in volume. In addition, the gas cylinder shall be preconditioned for 24 hours at a temperature between 20 and 30 °C.

- 5.4.3.2. Response factors shall be determined when introducing an analyser into service and at major service intervals thereafter. The test gases to be used and the recommended response factors are:

Propylene and purified air: $0,90 < R_f < 1,10$

Toluene and purified air: $0,90 < R_f < 1,10$

These are relative to an R_f of 1,00 for propane and purified air.

- 5.5. NO_x converter efficiency test procedure
- 5.5.1. Using the test set up as shown in Figure A5/15 and the procedure described below, the efficiency of converters for the conversion of NO_2 into NO shall be tested by means of an ozonator as follows:
- 5.5.1.1. The analyser shall be calibrated in the most common operating range following the manufacturer's specifications using zero and calibration gas (the NO content of which shall amount to approximately 80 per cent of the operating range and the NO_2 concentration of the gas mixture shall be less than 5 per cent of the NO concentration). The NO_x analyser shall be in the NO mode so that the calibration gas does not pass through the converter. The indicated concentration shall be included in all relevant test sheets.
- 5.5.1.2. Via a T-fitting, oxygen or synthetic air shall be added continuously to the calibration gas flow until the concentration indicated is approximately 10 per cent less than the indicated calibration concentration given in paragraph 5.5.1.1. of this Sub-Annex. The indicated concentration (c) shall be included in all relevant test sheets. The ozonator shall be kept deactivated throughout this process.
- 5.5.1.3. The ozonator shall now be activated to generate enough ozone to bring the NO concentration down to 20 per cent (minimum 10 per cent) of the calibration concentration given in paragraph 5.5.1.1. of this Sub-Annex. The indicated concentration (d) shall be included all relevant test sheets.
- 5.5.1.4. The NO_x analyser shall be subsequently switched to the NO_x mode, whereby the gas mixture (consisting of NO, NO_2 , O_2 and N_2) now passes through the converter. The indicated concentration (a) shall be included in all relevant test sheets.
- 5.5.1.5. The ozonator shall now be deactivated. The mixture of gases described in paragraph 5.5.1.2. of this Sub-Annex shall pass through the converter into the detector. The indicated concentration (b) shall be included in all relevant test sheets.

▼ B

Figure A5/15

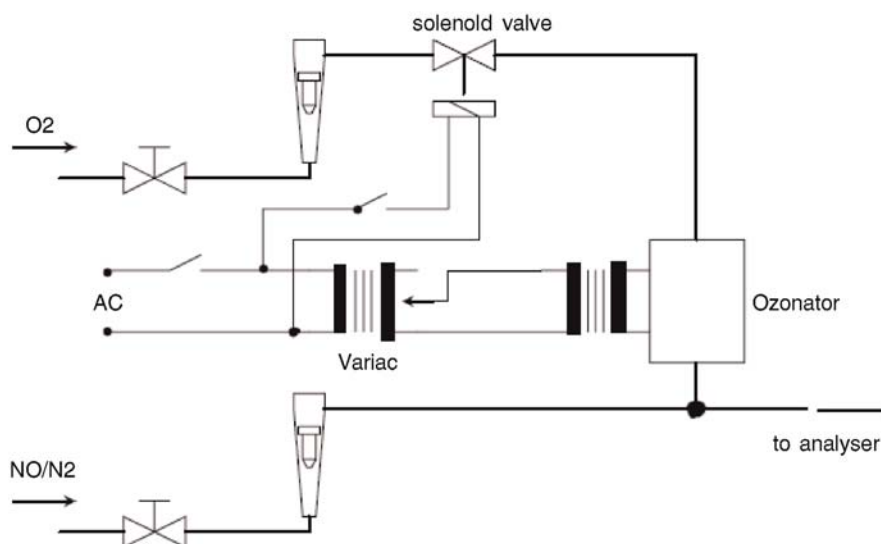
NO_x converter efficiency test configuration

5.5.1.6. With the ozonator deactivated, the flow of oxygen or synthetic air shall be shut off. The NO₂ reading of the analyser shall then be no more than 5 per cent above the figure given in paragraph 5.5.1.1. of this Sub-Annex.

5.5.1.7. The per cent efficiency of the NO_x converter shall be calculated using the concentrations a, b, c and d determined in paragraphs 5.5.1.2. to 5.5.1.5. of this Sub-Annex inclusive using the following equation:

$$\text{Efficiency} = \left(1 + \frac{a - b}{c - d} \right) \times 100$$

▼ M3

The efficiency of the converter shall not be less than 95 per cent. The efficiency of the converter shall be tested in the frequency defined in Table A5/3.

▼ B

5.6. Calibration of the microgram balance

▼ M3

The calibration of the microgram balance used for particulate sampling filter weighing shall be traceable to a national or international standard. The balance shall comply with the linearity requirements given in paragraph 4.2.2.2. The linearity verification shall be performed at least every 12 months or whenever a system repair or change is made that could influence the calibration.

▼ B

5.7. Calibration and validation of the particle sampling system

Examples of calibration/validation methods are available at:

<http://www.unece.org/trans/main/wp29/wp29wgs/wp29grpe/pmpFCP.html>

▼ B

5.7.1. Calibration of the PNC

5.7.1.1. The approval authority shall ensure the existence of a calibration certificate for the PNC demonstrating compliance with a traceable standard within a 13-month period prior to the emissions test. Between calibrations either the counting efficiency of the PNC shall be monitored for deterioration or the PNC wick shall be routinely changed every 6 months. See Figures A5/16 and A5/17. PNC counting efficiency may be monitored against a reference PNC or against at least two other measurement PNCs. If the PNC reports particle number concentrations within ± 10 per cent of the arithmetic average of the concentrations from the reference PNC, or a group of two or more PNCs, the PNC shall subsequently be considered stable, otherwise maintenance of the PNC is required. Where the PNC is monitored against two or more other measurement PNCs, it is permitted to use a reference vehicle running sequentially in different test cells each with its own PNC.

Figure A5/16

Nominal PNC annual sequence

Figure A5/17

Extended PNC annual sequence (in the case that a full PNC calibration is delayed)

5.7.1.2. The PNC shall also be recalibrated and a new calibration certificate issued following any major maintenance.

5.7.1.3. Calibration shall be traceable to a national or international standard calibration method by comparing the response of the PNC under calibration with that of:

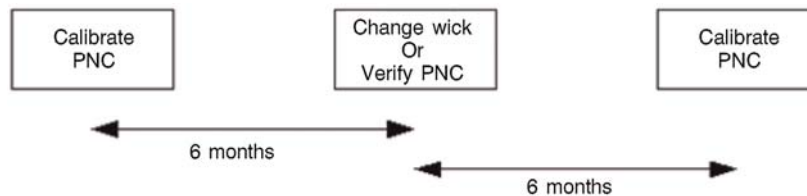
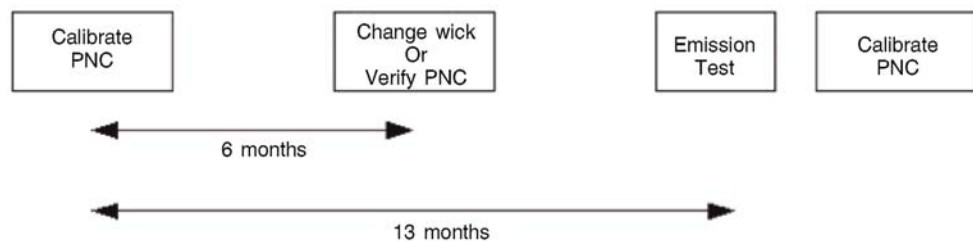
- (a) A calibrated aerosol electrometer when simultaneously sampling electrostatically classified calibration particles; or
- (b) A second PNC that has been directly calibrated by the method described above.

5.7.1.3.1. In paragraph 5.7.1.3. (a) of this Sub-Annex, calibration shall be undertaken using at least six standard concentrations spaced as uniformly as possible across the PNC's measurement range.

▼B

- 5.7.1.3.2. In paragraph 5.7.1.3. (b) of this Sub-Annex, calibration shall be undertaken using at least six standard concentrations across the PNC's measurement range. At least 3 points shall be at concentrations below 1,000 per cm³, the remaining concentrations shall be linearly spaced between 1,000 per cm³ and the maximum of the PNC's range in single particle count mode.
- 5.7.1.3.3. In paragraphs 5.7.1.3.(a) and 5.7.1.3.(b) of this Sub-Annex, the selected points shall include a nominal zero concentration point produced by attaching HEPA filters of at least class H13 of EN 1822:2008, or equivalent performance, to the inlet of each instrument. With no calibration factor applied to the PNC under calibration, measured concentrations shall be within ± 10 per cent of the standard concentration for each concentration, with the exception of the zero point, otherwise the PNC under calibration shall be rejected. The gradient from a linear least squares regression of the two data sets shall be calculated and recorded. A calibration factor equal to the reciprocal of the gradient shall be applied to the PNC under calibration. Linearity of response is calculated as the square of the Pearson product moment correlation coefficient (r) of the two data sets and shall be equal to or greater than 0.97. In calculating both the gradient and r^2 , the linear regression shall be forced through the origin (zero concentration on both instruments).
- 5.7.1.4. Calibration shall also include a check, according to the requirements of paragraph 4.3.1.3.4.(h) of this Sub-Annex, on the PNC's detection efficiency with particles of 23 nm electrical mobility diameter. A check of the counting efficiency with 41 nm particles is not required.
- 5.7.2. Calibration/validation of the VPR
- 5.7.2.1. Calibration of the VPR's particle concentration reduction factors across its full range of dilution settings, at the instrument's fixed nominal operating temperatures, shall be required when the unit is new and following any major maintenance. The periodic validation requirement for the VPR's particle concentration reduction factor is limited to a check at a single setting, typical of that used for measurement on particulate filter-equipped vehicles. The approval authority shall ensure the existence of a calibration or validation certificate for the VPR within a 6-month period prior to the emissions test. If the VPR incorporates temperature monitoring alarms, a 13 month validation interval is permitted.

It is recommended that the VPR is calibrated and validated as a complete unit.

The VPR shall be characterised for particle concentration reduction factor with solid particles of 30, 50 and 100 nm electrical mobility diameter. Particle concentration reduction factors $f_r(d)$ for particles of 30 nm and 50 nm electrical mobility diameters shall be no more than 30 per cent and 20 per cent higher respectively, and no more than 5 per cent lower than that for particles of 100 nm electrical mobility diameter. For the purposes of validation, the arithmetic average of the particle concentration reduction factor shall be within ± 10 per cent of the arithmetic average particle concentration reduction factor \bar{f}_r determined during the primary calibration of the VPR.

▼ B

5.7.2.2. The test aerosol for these measurements shall be solid particles of 30, 50 and 100 nm electrical mobility diameter and a minimum concentration of 5 000 particles per cm³ at the VPR inlet. As an option, a polydisperse aerosol with an electrical mobility median diameter of 50 nm may be used for validation. The test aerosol shall be thermally stable at the VPR operating temperatures. Particle number concentrations shall be measured upstream and downstream of the components.

The particle concentration reduction factor for each monodisperse particle size, $f_r(d_i)$, shall be calculated using the following equation:

$$f_r(d_i) = \frac{N_{in}(d_i)}{N_{out}(d_i)}$$

where:

$N_{in}(d_i)$ is the upstream particle number concentration for particles of diameter d_i ;

$N_{out}(d_i)$ is the downstream particle number concentration for particles of diameter d_i ;

d_i is the particle electrical mobility diameter (30, 50 or 100 nm).

$N_{in}(d_i)$ and $N_{out}(d_i)$ shall be corrected to the same conditions.

The arithmetic average particle concentration reduction factor \bar{f}_r at a given dilution setting shall be calculated using the following equation:

$$\bar{f}_r = \frac{f_r(30\text{nm}) + f_r(50\text{nm}) + f_r(100\text{nm})}{3}$$

Where a polydisperse 50 nm aerosol is used for validation, the arithmetic average particle concentration reduction factor \bar{f}_v at the dilution setting used for validation shall be calculated using the following equation:

$$\bar{f}_v = \frac{N_{in}}{N_{out}}$$

where:

N_{in} is the upstream particle number concentration;

N_{out} is the downstream particle number concentration.

5.7.2.3. The VPR shall demonstrate greater than 99.0 per cent removal of tetracontane ($\text{CH}_3(\text{CH}_2)_{38}\text{CH}_3$) particles of at least 30 nm electrical mobility diameter with an inlet concentration $\geq 10\,000$ per cm³ when operated at its minimum dilution setting and manufacturers recommended operating temperature.

5.7.3. PN measurement system check procedures

▼ M3

On a monthly basis, the flow into the PNC shall have a measured value within 5 per cent of the PNC nominal flow rate when checked with a calibrated flow meter.

▼ B

5.8. Accuracy of the mixing device

In the case that a gas divider is used to perform the calibrations as defined in paragraph 5.2. of this Sub-Annex, the accuracy of the mixing device shall be such that the concentrations of the diluted calibration gases may be determined to within ± 2 per cent. A calibration curve shall be verified by a mid-span check as described in paragraph 5.3. of this Sub-Annex. A calibration gas with a concentration below 50 per cent of the analyser range shall be within 2 per cent of its certified concentration.

6. Reference gases

6.1. Pure gases

▼ M3

6.1.1. All values in ppm mean volume-ppm (vpm)

▼ B

6.1.2. The following pure gases shall be available, if necessary, for calibration and operation:

▼ M3

6.1.2.1. Nitrogen:

Purity: ≤ 1 ppm C₁, ≤ 1 ppm CO, ≤ 400 ppm CO₂, $\leq 0,1$ ppm NO, $\leq 0,1$ ppm N₂O, $\leq 0,1$ ppm NH₃;

6.1.2.2. Synthetic air:

Purity: ≤ 1 ppm C₁, ≤ 1 ppm CO, ≤ 400 ppm CO₂, $\leq 0,1$ ppm NO, $\leq 0,1$ ppm NO₂; oxygen content between 18 and 21 per cent volume;

▼ B

6.1.2.3. Oxygen:

Purity: $> 99,5$ per cent vol. O₂;

6.1.2.4. Hydrogen (and mixture containing helium or nitrogen):

Purity: ≤ 1 ppm C₁, ≤ 400 ppm CO₂; hydrogen content between 39 and 41 per cent volume;

6.1.2.5. Carbon monoxide:

Minimum purity 99,5 per cent;

6.1.2.6. Propane:

Minimum purity 99,5 per cent.

▼ M3

6.2. Calibration gases

The true concentration of a calibration gas shall be within ± 1 per cent of the stated value or as given below, and shall be traceable to national or international standards.

Mixtures of gases having the following compositions shall be available with bulk gas specifications in accordance with paragraphs 6.1.2.1. or 6.1.2.2.:

(a) C₃H₈ in synthetic air (see paragraph 6.1.2.2.);

(b) CO in nitrogen;

(c) CO₂ in nitrogen;

(d) CH₄ in synthetic air;

(e) NO in nitrogen (the amount of NO₂ contained in this calibration gas shall not exceed 5 per cent of the NO content).

▼ **M3***Sub-Annex 6***Type 1 test procedures and test conditions**

1. Description of tests
 - 1.1. The Type 1 test is used to verify the emissions of gaseous compounds, particulate matter, particle number, CO₂ mass emission, fuel consumption, electric energy consumption and electric ranges over the applicable WLTP test cycle.
 - 1.1.1. The tests shall be carried out in accordance with the method described in paragraph 2. of this Sub-Annex or paragraph 3. of Sub-Annex 8 for pure electric, hybrid electric and compressed hydrogen fuel cell hybrid vehicles. Exhaust gases, particulate matter and particle number shall be sampled and analysed by the prescribed methods.
 - 1.2. The number of tests shall be determined in accordance with the flowchart in Figure A6/1. The limit value is the maximum allowed value for the respective criteria emission as specified in Table 2 of Annex I of Regulation (EC) No 715/2007.
 - 1.2.1. The flowchart in Figure A6/1 shall be applicable only to the whole applicable WLTP test cycle and not to single phases.
 - 1.2.2. The test results shall be the values after the target speed, REESS energy change-based, Ki, ATCT and Deterioration Factor corrections are applied.
 - 1.2.3. Determination of total cycle values
 - 1.2.3.1. If during any of the tests a criteria emissions limit is exceeded, the vehicle shall be rejected.
 - 1.2.3.2. Depending on the vehicle type, the manufacturer shall declare as applicable the total cycle value of the CO₂ mass emission, the electric energy consumption, fuel consumption for NOVC-FCHV as well as PER and AER in accordance with Table A6/1.
 - 1.2.3.3. The declared value of the electric energy consumption for OVC-HEVs under charge-depleting operating condition shall not be determined in accordance with Figure A6/1. It shall be taken as the type approval value if the declared CO₂ value is accepted as the approval value. If that is not the case, the measured value of electric energy consumption shall be taken as the type approval value.
 - 1.2.3.4. If after the first test all criteria in row 1 of the applicable Table A6/2 are fulfilled, all values declared by the manufacturer shall be accepted as the type approval value. If any one of the criteria in row 1 of the applicable Table A6/2 is not fulfilled, a second test shall be performed with the same vehicle.
 - 1.2.3.5. After the second test, the arithmetic average results of the two tests shall be calculated. If all criteria in row 2 of the applicable Table A6/2 are fulfilled by these arithmetic average results, all values declared by the manufacturer shall be accepted as the type approval value. If any one of the criteria in row 2 of the applicable Table A6/2 is not fulfilled, a third test shall be performed with the same vehicle.

▼ **M3**

1.2.3.6. After the third test, the arithmetic average results of the three tests shall be calculated. For all parameters which fulfil the corresponding criterion in row 3 of the applicable Table A6/2, the declared value shall be taken as the type approval value. For any parameter which does not fulfil the corresponding criterion in row 3 of the applicable Table A6/2, the arithmetic average result shall be taken as the type approval value.

1.2.3.7. In the case that any one of the criterion of the applicable Table A6/2 is not fulfilled after the first or second test, at the request of the manufacturer and with the approval of the approval authority, the values may be re-declared as higher values for emissions or consumption, or as lower values for electric ranges, in order to reduce the required number of tests for type approval.

1.2.3.8. Determination of the acceptance value dCO_{21} , dCO_{22} and dCO_{23}

1.2.3.8.1. Additional to the requirement of paragraph 1.2.3.8.2., the following values for dCO_{21} , dCO_{22} and dCO_{23} shall be used in relation to the criteria for the number of tests in Table A6/2:

$$dCO_{21} = 0,990$$

$$dCO_{22} = 0,995$$

$$dCO_{23} = 1,000$$

1.2.3.8.2. If the charge depleting Type 1 test for OVC-HEVs consists of two or more applicable WLTP test cycles and the dCO_{2x} value is below 1,0, the dCO_{2x} value shall be replaced by 1,0.

1.2.3.9. In the case that a test result or an average of test results was taken and confirmed as the type approval value, this result shall be referred to as the 'declared value' for further calculations.

Table A6/1

Applicable rules for a manufacturer's declared values (total cycle values) ⁽¹⁾

Vehicle type	M_{CO_2} ⁽²⁾ (g/km)	FC (kg/100 km)	Electric energy consumption ⁽³⁾ (Wh/km)	All electric range/ Pure Electric Range ⁽³⁾ (km)
Vehicles tested in accordance with Sub-Annex 6 (pure ICE)	M_{CO_2} Paragraph 3. of Sub-Annex 7.	—	—	—
NOVC-FCHV	—	FC_{CS} Paragraph 4.2.1.2.1. of Sub-Annex 8.	—	—
NOVC-HEV	$M_{CO_2,CS}$ Paragraph 4.1.1. of Sub- Annex 8.	—	—	—

▼ M3

Vehicle type		M_{CO_2} ⁽²⁾ (g/km)	FC (kg/100 km)	Electric energy consumption ⁽³⁾ (Wh/km)	All electric range/ Pure Electric Range ⁽³⁾ (km)
OVC-HEV	CD	$M_{CO_2,CD}$ Paragraph 4.1.2. of.	—	$EC_{AC,CD}$ Paragraph 4.3.1. of Sub-Annex 8.	AER Paragraph 4.4.1.1. of Sub-Annex 8.
	CS	$M_{CO_2,CS}$ Sub-Annex 8 Paragraph 4.1.1. of Sub-Annex 8.	—	—	—
PEV		—	—	EC_{WLTC} Paragraph 4.3.4.2. of Sub-Annex 8.	PER_{WLTC} Paragraph 4.4.2. of Sub-Annex 8.

- (¹) The declared value shall be the value to which the necessary corrections are applied (i.e. Ki, ATCT and DF corrections)
- (²) Rounding xxx,xx
- (³) Rounding xxx,x

Figure A6/1

Flowchart for the number of Type 1 tests

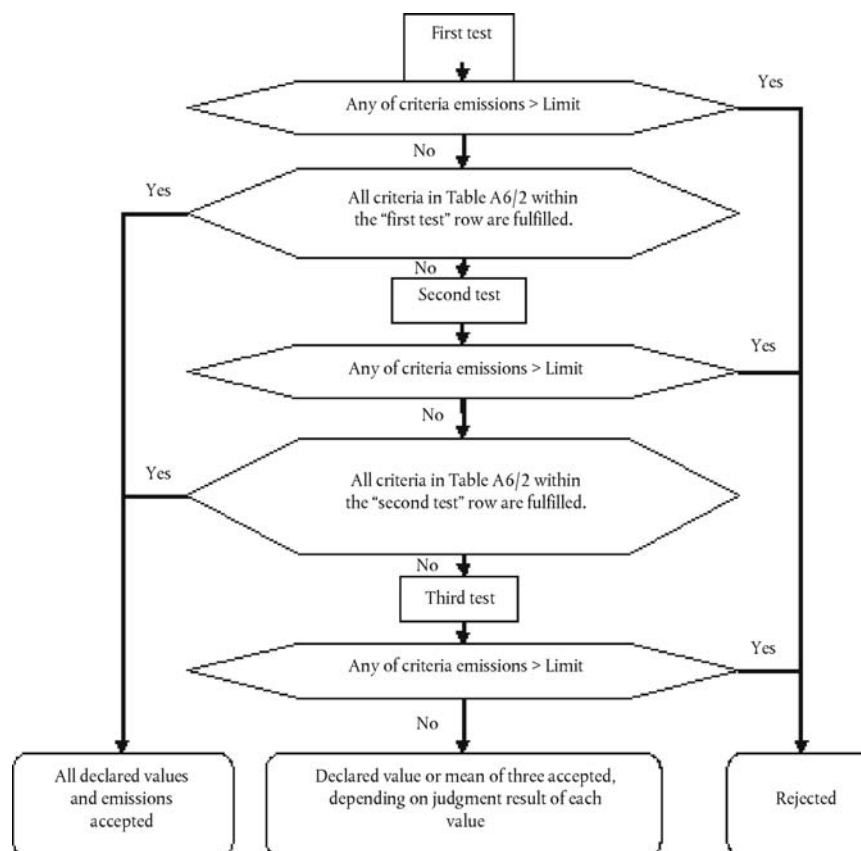

▼ **M3**

Table A6/2

Criteria for number of tests

For pure ICE vehicles, NOVC-HEVs and OVC-HEVs charge-sustaining Type 1 test.

	Test	Judgement parameter	Criteria emission	M _{CO2}
Row 1	First test	First test results	\leq Regulation limit \times 0,9	\leq Declared value \times dCO ₂₁
Row 2	Second test	Arithmetic average of the first and second test results	\leq Regulation limit \times 1,0 ⁽¹⁾	\leq Declared value \times dCO ₂₂
Row 3	Third test	Arithmetic average of three test results	\leq Regulation limit \times 1,0 ⁽¹⁾	\leq Declared value \times dCO ₂₃

⁽¹⁾ Each test result shall fulfil the regulation limit.

For OVC-HEVs charge-depleting Type 1 test.

	Test	Judgement parameter	Criteria emissions	M _{CO2,CD}	AER
Row 1	First test	First test results	\leq Regulation limit \times 0,9 ⁽¹⁾	\leq Declared value \times dCO ₂₁	\geq Declared value \times 1,0
Row 2	Second test	Arithmetic average of the first and second test results	\leq Regulation limit \times 1,0 ⁽²⁾	\leq Declared value \times dCO ₂₂	\geq Declared value \times 1,0
Row 3	Third test	Arithmetic average of three test results	\leq Regulation limit \times 1,0 ⁽²⁾	\leq Declared value \times dCO ₂₃	\geq Declared value \times 1,0

⁽¹⁾ '0,9' shall be replaced by '1,0' for charge-depleting Type 1 test for OVC-HEVs, only if the charge-depleting test contains two or more applicable WLTC cycles.

⁽²⁾ Each test result shall fulfil the regulation limit.

For PEVs

	Test	Judgement parameter	Electric energy consumption	PER
Row 1	First test	First test results	\leq Declared value \times 1,0	\geq Declared value \times 1,0
Row 2	Second test	Arithmetic average of the first and second test results	\leq Declared value \times 1,0	\geq Declared value \times 1,0
Row 3	Third test	Arithmetic average of three test results	\leq Declared value \times 1,0	\geq Declared value \times 1,0

For NOVC-FCHVs

	Test	Judgement parameter	FC _{cs}
Row 1	First test	First test results	\leq Declared value \times 1,0

▼ **M3**

	Test	Judgement parameter	FC _{CS}
Row 2	Second test	Arithmetic average of the first and second test results	≤ Declared value × 1,0
Row 3	Third test	Arithmetic average of three test results	≤ Declared value × 1,0

1.2.4. Determination of phase-specific values

1.2.4.1. Phase-specific value for CO₂

1.2.4.1.1. After the total cycle declared value of the CO₂ mass emission is accepted, the arithmetic average of the phase-specific values of the test results in g/km shall be multiplied by the adjustment factor CO₂_AF to compensate for the difference between the declared value and the test results. This corrected value shall be the type approval value for CO₂.

$$\text{CO}_2\text{-AF} = \frac{\text{Declared value}}{\text{Phase combined value}}$$

where:

$$\text{Phase combined value} = \frac{(\text{CO}_{2\text{aveL}} \times D_L) + (\text{CO}_{2\text{aveM}} \times D_M) + (\text{CO}_{2\text{aveH}} \times D_H) + (\text{CO}_{2\text{aveexH}} \times D_{\text{exH}})}{D_L + D_M + D_H + D_{\text{exH}}}$$

where:

CO_{2aveL} is the arithmetic average CO₂ mass emission result for the L phase test result(s), g/km;

CO_{2aveM} is the arithmetic average CO₂ mass emission result for the M phase test result(s), g/km;

CO_{2aveH} is the arithmetic average CO₂ mass emission result for the H phase test result(s), g/km;

CO_{2aveexH} is the arithmetic average CO₂ mass emission result for the exH phase test result(s), g/km;

D_L is theoretical distance of phase L, km;

D_M is theoretical distance of phase M, km;

D_H is theoretical distance of phase H, km;

D_{exH} is theoretical distance of phase exH, km.

1.2.4.1.2. If the total cycle declared value of the CO₂ mass emission is not accepted, the type approval phase-specific CO₂ mass emission value shall be calculated by taking the arithmetic average of the all test results for the respective phase.

1.2.4.2. Phase-specific values for fuel consumption

The fuel consumption value shall be calculated by the phase-specific CO₂ mass emission using the equations in paragraph 1.2.4.1. of this Sub-Annex and the arithmetic average of the emissions.

▼ **M3**

- 1.2.4.3. Phase-specific value for electric energy consumption, PER and AER
- The phase-specific electric energy consumption and the phase-specific electric ranges are calculated by taking the arithmetic average of the phase specific values of the test result(s), without an adjustment factor.
2. Type 1 test conditions
- 2.1. Overview
- 2.1.1. The Type 1 test shall consist of prescribed sequences of dynamometer preparation, fuelling, soaking, and operating conditions.
- 2.1.2. The Type 1 test shall consist of vehicle operation on a chassis dynamometer on the applicable WLTC for the interpolation family. A proportional part of the diluted exhaust emissions shall be collected continuously for subsequent analysis using a constant volume sampler.
- 2.1.3. Background concentrations shall be measured for all compounds for which dilute mass emissions measurements are conducted. For exhaust emissions testing, this requires sampling and analysis of the dilution air.
- 2.1.3.1. Background particulate measurement
- 2.1.3.1.1. Where the manufacturer requests subtraction of either dilution air or dilution tunnel background particulate mass from emissions measurements, these background levels shall be determined in accordance with the procedures listed in paragraphs 2.1.3.1.1.1. to 2.1.3.1.1.3. of this Sub-Annex.
- 2.1.3.1.1.1. The maximum permissible background correction shall be a mass on the filter equivalent to 1 mg/km at the flow rate of the test.
- 2.1.3.1.1.2. If the background exceeds this level, the default figure of 1 mg/km shall be subtracted.
- 2.1.3.1.1.3. Where subtraction of the background contribution gives a negative result, the background level shall be considered to be zero.
- 2.1.3.1.2. Dilution air background particulate mass level shall be determined by passing filtered dilution air through the particulate background filter. This shall be drawn from a point immediately downstream of the dilution air filters. Background levels in $\mu\text{g}/\text{m}^3$ shall be determined as a rolling arithmetic average of at least 14 measurements with at least one measurement per week.
- 2.1.3.1.3. Dilution tunnel background particulate mass level shall be determined by passing filtered dilution air through the particulate background filter. This shall be drawn from the same point as the particulate matter sample. Where secondary dilution is used for the test, the secondary dilution system shall be active for the purposes of background measurement. One measurement may be performed on the day of test, either prior to or after the test.
- 2.1.3.2. Background particle number determination
- 2.1.3.2.1. Where the manufacturer requests a background correction, these background levels shall be determined as follows:

▼ **M3**

- 2.1.3.2.1.1. The background value may be either calculated or measured. The maximum permissible background correction shall be related to the maximum allowable leak rate of the particle number measurement system (0,5 particles per cm³) scaled from the particle concentration reduction factor, PCRf, and the CVS flow rate used in the actual test;
- 2.1.3.2.1.2. Either the approval authority or the manufacturer may request that actual background measurements are used instead of calculated ones.
- 2.1.3.2.1.3. Where subtraction of the background contribution gives a negative result, the PN result shall be considered to be zero.
- 2.1.3.2.2. The dilution air background particle number level shall be determined by sampling filtered dilution air. This shall be drawn from a point immediately downstream of the dilution air filters into the PN measurement system. Background levels in particles per cm³ shall be determined as a rolling arithmetic average of least 14 measurements with at least one measurement per week.
- 2.1.3.2.3. The dilution tunnel background particle number level shall be determined by sampling filtered dilution air. This shall be drawn from the same point as the PN sample. Where secondary dilution is used for the test the secondary dilution system shall be active for the purposes of background measurement. One measurement may be performed on the day of test, either prior to or after the test using the actual PCRf and the CVS flow rate utilised during the test.
- 2.2. General test cell equipment
- 2.2.1. Parameters to be measured
- 2.2.1.1. The following temperatures shall be measured with an accuracy of $\pm 1,5$ °C:
- (a) Test cell ambient air;
- (b) Dilution and sampling system temperatures as required for emissions measurement systems defined in Sub-Annex 5.
- 2.2.1.2. Atmospheric pressure shall be measurable with a precision of $\pm 0,1$ kPa.
- 2.2.1.3. Specific humidity H shall be measurable with a precision of ± 1 g H₂O/kg dry air.
- 2.2.2. Test cell and soak area
- 2.2.2.1. Test cell
- 2.2.2.1.1. The test cell shall have a temperature set point of 23 °C. The tolerance of the actual value shall be within ± 5 °C. The air temperature and humidity shall be measured at the test cell's cooling fan outlet at a minimum frequency of 0,1 Hz. For the temperature at the start of the test, see paragraph 2.8.1. of this Sub-Annex.
- 2.2.2.1.2. The specific humidity H of either the air in the test cell or the intake air of the engine shall be such that:
- $$5,5 \leq H \leq 12,2 \text{ (g H}_2\text{O/kg dry air)}$$
- 2.2.2.1.3. Humidity shall be measured continuously at a minimum frequency of 0,1 Hz.

▼ M3

2.2.2.2. Soak area

The soak area shall have a temperature set point of 23 °C and the tolerance of the actual value shall be within ± 3 °C on a 5-minute running arithmetic average and shall not show a systematic deviation from the set point. The temperature shall be measured continuously at a minimum frequency of 0,033 Hz (every 30 s).

2.3. Test vehicle

2.3.1. General

The test vehicle shall conform in all its components with the production series, or, if the vehicle is different from the production series, a full description shall be included in all relevant test reports. In selecting the test vehicle, the manufacturer and the approval authority shall agree which vehicle model is representative for the interpolation family.

For the measurement of emissions, the road load as determined with test vehicle H shall be applied. In the case of a road load matrix family, for the measurement of emissions, the road load as calculated for vehicle H_M in accordance with paragraph 5.1. of Sub-Annex 4 shall be applied.

If at the request of the manufacturer the interpolation method is used (see paragraph 3.2.3.2. of Sub-Annex 7), an additional measurement of emissions shall be performed with the road load as determined with test vehicle L. Tests on vehicles H and L should be performed with the same test vehicle and shall be tested with the shortest n/v ratio (with a tolerance of $\pm 1,5$ per cent) within the interpolation family. In the case of a road load matrix family, an additional measurement of emissions shall be performed with the road load as calculated for vehicle L_M in accordance with paragraph 5.1. of Sub-Annex 4.

Road load coefficients and the test mass of test vehicle L and H may be taken from different road load families, as long as the difference between these road load families results from applying paragraph 6.8. of Sub-Annex 4, and the requirements in paragraph 2.3.2. of this Sub-Annex are maintained.

2.3.2. CO₂ interpolation range

2.3.2.1. The interpolation method shall only be used if:

- (a) The difference in CO₂ over the applicable cycle resulting from step 9 of Table A7/1 of Sub-Annex 7 between test vehicles L and H is between a minimum of 5 g/km and a maximum defined in paragraph 2.3.2.2.;
- (b) for all applicable phase values the CO₂ values resulting of step 9 of Table A7/1 of Sub-Annex 7 of vehicle H are higher than those of vehicle L.

If these requirements are not met, tests can be declared void and repeated in agreement with the approval authority.

▼ **M3**

- 2.3.2.2. The maximum delta CO₂ allowed over the applicable cycle resulting from step 9 of Table A7/1 of Sub-Annex 7 between test vehicles L and H is 20 per cent plus 5 g/km of the CO₂ emissions from vehicle H, but at least 15 g/km and not exceeding 30 g/km.

This restriction does not apply for the application of a road load matrix family.

- 2.3.2.3. At the request of the manufacturer and with approval of the approval authority, the interpolation line may be extrapolated to a maximum of 3 g/km above the CO₂ emission of vehicle H and/or below the CO₂ emission of vehicle L. This extension is valid only within the absolute boundaries of the interpolation range specified in paragraph 2.3.2.2.

For the application of a road load matrix family, extrapolation is not permitted.

When two or more interpolation families are identical regarding the requirements of paragraph 5.6. of this Annex, but are distinct because their overall range for CO₂ would be higher than the maximum delta specified in paragraph 2.3.2.2., then all individual vehicles of identical specification (e.g. make, model, optional equipment) shall belong to only one of the interpolation families.

- 2.3.3. Run-in

The vehicle shall be presented in good technical condition. It shall have been run-in and driven between 3 000 and 15 000 km before the test. The engine, transmission and vehicle shall be run-in in accordance with the manufacturer's recommendations.

- 2.4. Settings

- 2.4.1. Dynamometer settings and verification shall be performed in accordance with Sub-Annex 4.

- 2.4.2. Dynamometer operation

- 2.4.2.1. Auxiliary devices shall be switched off or deactivated during dynamometer operation unless their operation is required by legislation.

- 2.4.2.2. The vehicle's dynamometer operation mode, if any, shall be activated by using the manufacturer's instruction (e.g. using vehicle steering wheel buttons in a special sequence, using the manufacturer's workshop tester, removing a fuse).

The manufacturer shall provide the approval authority a list of the deactivated devices and justification for the deactivation. The dynamometer operation mode shall be approved by the approval authority and the use of a dynamometer operation mode shall be included in all relevant test reports.

- 2.4.2.3. The vehicle's dynamometer operation mode shall not activate, modulate, delay or deactivate the operation of any part that affects the emissions and fuel consumption under the test conditions. Any device that affects the operation on a chassis dynamometer shall be set to ensure a proper operation.

- 2.4.2.4. Allocation of dynamometer type to test vehicle

▼ **M3**

2.4.2.4.1. If the test vehicle has two powered axles, and under WLTP conditions it is partially or permanently operated with two axles being powered or recuperating energy over the applicable cycle the vehicle shall be tested on a dynamometer in 4WD operation which fulfils the specifications in paragraphs 2.2. and 2.3. of Sub-Annex 5.

2.4.2.4.2. If the test vehicle is tested with only one powered axle, the test vehicle shall be tested on a dynamometer in 2WD operation which fulfils the specifications in paragraph 2.2. of Sub-Annex 5.

At the request of the manufacturer and with the approval of the approval authority a vehicle with one powered axle may be tested on a 4WD dynamometer in 4WD operation mode.

2.4.2.4.3. If the test vehicle is operated with two axles being powered in dedicated driver-selectable modes which are not intended for normal daily operation but only for special limited purposes, such as ‘mountain mode’ or ‘maintenance mode’, or when the mode with two powered axles is only activated in an off-road situation, the vehicle shall be tested on a dynamometer in 2WD operation which fulfils the specifications in paragraph 2.2. of Sub-Annex 5.

2.4.2.4.4. If the test vehicle is tested on a 4WD dynamometer in 2WD operation the wheels on the non-powered axle may rotate during the test, provided that the vehicle dynamometer operation mode and vehicle coastdown mode support this way of operation.

Figure A6/1a

Possible test configurations on 2WD and 4WD dynamometers

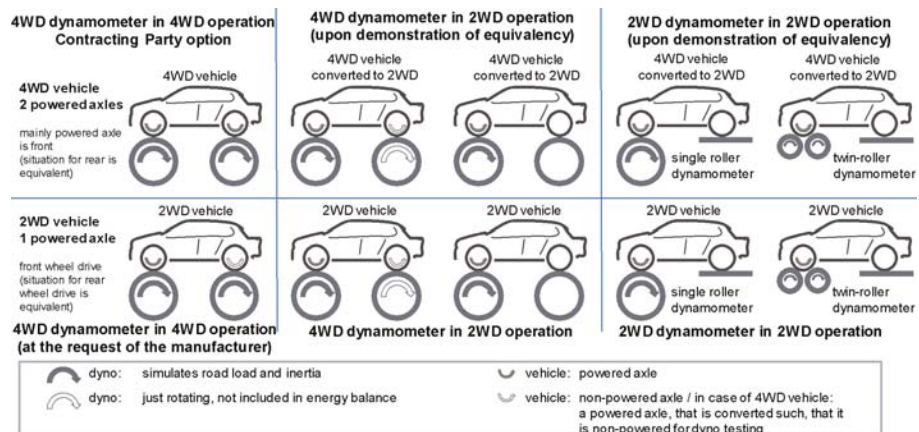

2.4.2.5. Demonstration of equivalency between a dynamometer in 2WD operation and a dynamometer in 4WD operation

2.4.2.5.1. At the request of the manufacturer and with the approval of the approval authority, the vehicle which has to be tested on a dynamometer in 4WD operation may alternatively be tested on a dynamometer in 2WD operation if the following conditions are met:

▼ **M3**

- a. the test vehicle is converted to have only one powered axle;
 - b. the manufacturer demonstrates to the approval authority that the CO₂, fuel consumption and/or electrical energy consumption of the converted vehicle is the same or higher as for the non-converted vehicle being tested on a dynamometer in 4WD operation;
 - c. a safe operation is ensured for the test (e.g. by removing a fuse or dismounting a drive shaft) and an instruction is provided together with the dynamometer operation mode;
 - d. the conversion is only applied to the vehicle tested at the chassis dynamometer, the road load determination procedure shall be applied to the unconverted test vehicle.
- 2.4.2.5.2. This demonstration of equivalency shall apply to all vehicles in the same road load family. At the request of the manufacturer, and with approval of the approval authority, this demonstration of equivalency may be extended to other road load families upon evidence that a vehicle from the worst-case road load family was selected as the test vehicle.
- 2.4.2.6. Information on whether the vehicle was tested on a 2WD dynamometer or a 4WD dynamometer and whether it was tested on a dynamometer in 2WD operation or 4WD operation shall be included in all relevant test reports. In the case that the vehicle was tested on a 4WD dynamometer, with that dynamometer in 2WD operation, this information shall also indicate whether or not the wheels on the non-powered wheels were rotating.
- 2.4.3. The vehicle's exhaust system shall not exhibit any leak likely to reduce the quantity of gas collected.
- 2.4.4. The settings of the powertrain and vehicle controls shall be those prescribed by the manufacturer for series production.
- 2.4.5. Tyres shall be of a type specified as original equipment by the vehicle manufacturer. Tyre pressure may be increased by up to 50 per cent above the pressure specified in paragraph 4.2.2.3. of Sub-Annex 4. The same tyre pressure shall be used for the setting of the dynamometer and for all subsequent testing. The tyre pressure used shall be included in all relevant test reports.
- 2.4.6. Reference fuel
The appropriate reference fuel as specified in Annex IX shall be used for testing.
- 2.4.7. Test vehicle preparation
- 2.4.7.1. The vehicle shall be approximately horizontal during the test so as to avoid any abnormal distribution of the fuel.
- 2.4.7.2. If necessary, the manufacturer shall provide additional fittings and adapters, as required to accommodate a fuel drain at the lowest point possible in the tank(s) as installed on the vehicle, and to provide for exhaust sample collection.

▼ M3

- 2.4.7.3. For PM sampling during a test when the regenerating device is in a stabilized loading condition (i.e. the vehicle is not undergoing a regeneration), it is recommended that the vehicle has completed $> 1/3$ of the mileage between scheduled regenerations or that the periodically regenerating device has undergone equivalent loading off the vehicle.
- 2.5. Preliminary testing cycles
- Preliminary testing cycles may be carried out if requested by the manufacturer to follow the speed trace within the prescribed limits.
- 2.6. Test vehicle preconditioning
- 2.6.1. Vehicle preparation
- 2.6.1.1. Fuel tank filling
- The fuel tank (or fuel tanks) shall be filled with the specified test fuel. If the existing fuel in the fuel tank (or fuel tanks) does not meet the specifications contained in paragraph 2.4.6. of this Sub-Annex, the existing fuel shall be drained prior to the fuel fill. The evaporative emission control system shall neither be abnormally purged nor abnormally loaded.
- 2.6.1.2. REESSs charging
- Before the preconditioning test cycle, the REESSs shall be fully charged. At the request of the manufacturer, charging may be omitted before preconditioning. The REESSs shall not be charged again before official testing.
- 2.6.1.3. Tyre pressures
- The tyre pressure of the driving wheels shall be set in accordance with paragraph 2.4.5. of this Sub-Annex.
- 2.6.1.4. Gaseous fuel vehicles
- Between the tests on the first gaseous reference fuel and the second gaseous reference fuel, for vehicles with positive ignition engines fuelled with LPG or NG/biomethane or so equipped that they can be fuelled with either petrol or LPG or NG/biomethane, the vehicle shall be preconditioned again before the test on the second reference fuel. Between the tests on the first gaseous reference fuel and the second gaseous reference fuel, for vehicles with positive ignition engines fuelled with LPG or NG/biomethane or so equipped that they can be fuelled with either petrol or LPG or NG/biomethane, the vehicle shall be preconditioned again before the test on the second reference fuel.
- 2.6.2. Test cell
- 2.6.2.1. Temperature
- During preconditioning, the test cell temperature shall be the same as defined for the Type 1 test (paragraph 2.2.2.1.1. of this Sub-Annex).
- 2.6.2.2. Background measurement
- In a test facility in which there may be possible contamination of a low particulate emitting vehicle test with residue from a previous test on a high particulate emitting vehicle, it is recommended, for the purpose of sampling equipment preconditioning, that a 120 km/h steady state drive cycle of 20 minutes duration be

▼ **M3**

driven by a low particulate emitting vehicle. Longer and/or higher speed running is permissible for sampling equipment preconditioning if required. Dilution tunnel background measurements, if applicable, shall be taken after the tunnel preconditioning, and prior to any subsequent vehicle testing.

2.6.3. Procedure

2.6.3.1. The test vehicle shall be placed, either by being driven or pushed, on a dynamometer and operated through the applicable WLTCs. The vehicle need not be cold, and may be used to set the dynamometer load.

2.6.3.2. The dynamometer load shall be set in accordance with paragraphs 7. and 8. of Sub-Annex 4. In the case that a dynamometer in 2WD operation is used for testing, the road load setting shall be carried out on a dynamometer in 2WD operation, and in the case that a dynamometer in 4WD operation is used for testing the road load setting shall be carried out on a dynamometer in 4WD operation.

2.6.4. Operating the vehicle

2.6.4.1. The powertrain start procedure shall be initiated by means of the devices provided for this purpose in accordance with the manufacturer's instructions.

A non-vehicle initiated switching of mode of operation during the test shall not be permitted unless otherwise specified.

2.6.4.1.1. If the initiation of the powertrain start procedure is not successful, e.g. the engine does not start as anticipated or the vehicle displays a start error, the test is void, preconditioning tests shall be repeated and a new test shall be driven.

2.6.4.1.2. In the cases where LPG or NG/biomethane is used as a fuel, it is permissible that the engine is started on petrol and switched automatically to LPG or NG/biomethane after a predetermined period of time that cannot be changed by the driver. This period of time shall not exceed 60 seconds.

It is also permissible to use petrol only or simultaneously with gas when operating in gas mode provided that the energy consumption of gas is higher than 80 per cent of the total amount of energy consumed during the Type 1 test. This percentage shall be calculated in accordance with the method set out in Appendix 3 to this Sub-Annex.

2.6.4.2. The cycle starts on initiation of the powertrain start procedure.

2.6.4.3. For preconditioning, the applicable WLTC shall be driven.

At the request of the manufacturer or the approval authority, additional WLTCs may be performed in order to bring the vehicle and its control systems to a stabilized condition.

The extent of such additional preconditioning shall be included in all relevant test reports.

▼ M3

2.6.4.4. Accelerations

The vehicle shall be operated with the appropriate accelerator control movement necessary to accurately follow the speed trace.

The vehicle shall be operated smoothly, following representative shift speeds and procedures.

For manual transmissions, the accelerator controller shall be released during each shift and the shift shall be accomplished in minimum time.

If the vehicle cannot follow the speed trace, it shall be operated at maximum available power until the vehicle speed reaches the respective target speed again.

2.6.4.5. Deceleration

During decelerations of the cycle, the driver shall deactivate the accelerator control but shall not manually disengage the clutch until the point specified in paragraphs 4.(d), 4.(e) or 4.(f) of Sub-Annex 2.

If the vehicle decelerates faster than prescribed by the speed trace, the accelerator control shall be operated such that the vehicle accurately follows the speed trace.

If the vehicle decelerates too slowly to follow the intended deceleration, the brakes shall be applied such that it is possible to accurately follow the speed trace.

2.6.4.6. Brake application

During stationary/idling vehicle phases, the brakes shall be applied with appropriate force to prevent the drive wheels from turning.

2.6.5. Use of the transmission

2.6.5.1. Manual shift transmissions

2.6.5.1.1. The gear shift prescriptions specified in Sub-Annex 2 shall be followed. Vehicles tested in accordance with Sub-Annex 8 shall be driven in accordance with paragraph 1.5. of that Sub-Annex.

2.6.5.1.2. The gear change shall be started and completed within $\pm 1,0$ second of the prescribed gear shift point.

2.6.5.1.3. The clutch shall be depressed within $\pm 1,0$ second of the prescribed clutch operating point.

2.6.5.2. Automatic shift transmissions

2.6.5.2.1. After initial engagement, the selector shall not be operated at any time during the test. Initial engagement shall be done 1 second before beginning the first acceleration.

2.6.5.2.2. Vehicles with an automatic transmission with a manual mode shall not be tested in manual mode.

2.6.6. Driver-selectable modes

2.6.6.1. Vehicles equipped with a predominant mode shall be tested in that mode. At the request of the manufacturer, the vehicle may alternatively be tested with the driver-selectable mode in the worst-case position for CO₂ emissions.

▼ **M3**

- 2.6.6.2. The manufacturer shall provide evidence to the approval authority of the existence of a driver-selectable mode that fulfils the requirements of paragraph 3.5.9. of this Annex. With the agreement of the approval authority, the predominant mode may be used as the only driver-selectable mode for the relevant system or device for the determination of criteria emissions, CO₂ emissions, and fuel consumption.
- 2.6.6.3. If the vehicle has no predominant mode or the requested predominant mode is not agreed by the approval authority as being a predominant mode, the vehicle shall be tested in the best case driver-selectable mode and worst case driver-selectable mode for criteria emissions, CO₂ emissions, and fuel consumption. Best and worst case modes shall be identified by the evidence provided on the CO₂ emissions and fuel consumption in all modes. CO₂ emissions and fuel consumption shall be the arithmetic average of the test results in both modes. Test results for both modes shall be recorded.
- At the request of the manufacturer, the vehicle may alternatively be tested with the driver-selectable mode in the worst case position for CO₂ emissions.
- 2.6.6.4. On the basis of technical evidence provided by the manufacturer and with the agreement of the approval authority, the dedicated driver-selectable modes for very special limited purposes shall not be considered (e.g. maintenance mode, crawler mode). All remaining driver-selectable modes used for forward driving shall be considered and the criteria emissions limits shall be fulfilled in all these modes.
- 2.6.6.5. Paragraphs 2.6.6.1. to 2.6.6.4. of this Sub-Annex shall apply to all vehicle systems with driver-selectable modes, including those not solely specific to the transmission.
- 2.6.7. Voiding of the Type 1 test and completion of the cycle
- If the engine stops unexpectedly, the preconditioning or Type 1 test shall be declared void.
- After completion of the cycle, the engine shall be switched off. The vehicle shall not be restarted until the beginning of the test for which the vehicle has been preconditioned.
- 2.6.8. Data required, quality control
- 2.6.8.1. Speed measurement
- During the preconditioning, speed shall be measured against actual time or collected by the data acquisition system at a frequency of not less than 1 Hz so that the actual driven speed can be assessed.
- 2.6.8.2. Distance travelled
- The distance actually driven by the vehicle shall be included in all relevant test sheets for each WLTC phase.
- 2.6.8.3. Speed trace tolerances
- Vehicles that cannot attain the acceleration and maximum speed values required in the applicable WLTC shall be operated with the accelerator control fully activated until they once again reach the required speed trace. Speed trace violations under these circumstances shall not void a test. Deviations from the driving cycle shall be included in all relevant test reports.

▼ **M3**

- 2.6.8.3.1. The following tolerances shall be permitted between the actual vehicle speed and the prescribed speed of the applicable test cycles.

The tolerances shall not be shown to the driver:

- (a) Upper limit: 2,0 km/h higher than the highest point of the trace within $\pm 1,0$ second of the given point in time;
- (b) Lower limit: 2,0 km/h lower than the lowest point of the trace within $\pm 1,0$ second of the given time.

See Figure A6/2.

Speed tolerances greater than those prescribed shall be accepted provided the tolerances are never exceeded for more than 1 second on any one occasion.

There shall be no more than ten such deviations per test cycle.

- 2.6.8.3.2. IWR and RMSSE drive trace indices shall be calculated in accordance with the requirements of paragraph 7. of Sub-Annex 7.

If either IWR or RMSSE is outside the respective validity range, the driving test has to be considered invalid.

Figure A6/2

Speed trace tolerances

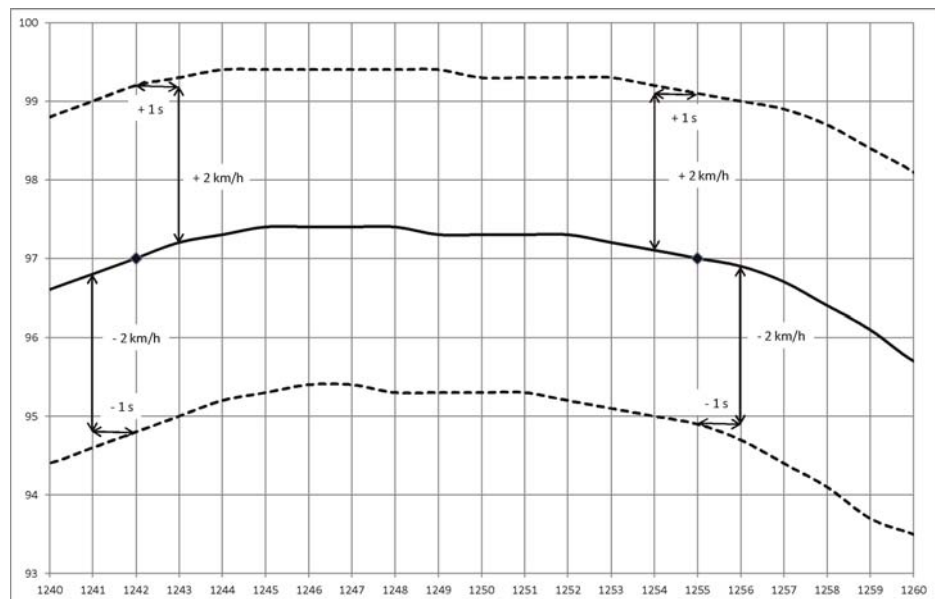

2.7. Soaking

- 2.7.1. After preconditioning and before testing, the test vehicle shall be kept in an area with ambient conditions as specified in paragraph 2.2.2.2. of this Sub-Annex.

- 2.7.2. The vehicle shall be soaked for a minimum of 6 hours and a maximum of 36 hours with the engine compartment cover opened or closed. If not excluded by specific provisions for a particular vehicle, cooling may be accomplished by forced cooling down to the set point temperature. If cooling is accelerated by fans, the fans shall be placed so that the maximum cooling of the drive train, engine and exhaust after-treatment system is achieved in a homogeneous manner.

▼ M3

- 2.8. Emission and fuel consumption test (Type 1 test)
- 2.8.1. The test cell temperature at the start of the test shall be $23\text{ °C} \pm 3\text{ °C}$. The engine oil temperature and coolant temperature, if any, shall be within $\pm 2\text{ °C}$ of the set point of 23 °C .
- 2.8.2. The test vehicle shall be pushed onto a dynamometer.
- 2.8.2.1. The drive wheels of the vehicle shall be placed on the dynamometer without starting the engine.
- 2.8.2.2. The drive-wheel tyre pressures shall be set in accordance with the provisions of paragraph 2.4.5. of this Sub-Annex.
- 2.8.2.3. The engine compartment cover shall be closed.
- 2.8.2.4. An exhaust connecting tube shall be attached to the vehicle tail-pipe(s) immediately before starting the engine.
- 2.8.3. Starting of the powertrain and driving
- 2.8.3.1. The powertrain start procedure shall be initiated by means of the devices provided for this purpose in accordance with the manufacturer's instructions.
- 2.8.3.2. The vehicle shall be driven as described in paragraphs 2.6.4. to 2.6.7. of this Sub-Annex over the applicable WLTC, as described in Sub-Annex 1.
- 2.8.4. RCB data shall be measured for each phase of the WLTC as defined in Appendix 2 to this Sub-Annex.
- 2.8.5. Actual vehicle speed shall be sampled with a measurement frequency of 10 Hz and the drive trace indices described in paragraph 7. of Sub-Annex 7 shall be calculated and documented.
- 2.8.6. Actual vehicle speed sampled with a measurement frequency of 10 Hz together with actual time shall be applied for corrections of CO₂ results against the target speed and distance as defined in Sub-Annex 6b.
- 2.9. Gaseous sampling
- Gaseous samples shall be collected in bags and the compounds analysed at the end of the test or a test phase, or the compounds may be analysed continuously and integrated over the cycle.
- 2.9.1. The following steps shall be taken prior to each test:
- 2.9.1.1. The purged, evacuated sample bags shall be connected to the dilute exhaust and dilution air sample collection systems.
- 2.9.1.2. Measuring instruments shall be started in accordance with the instrument manufacturer's instructions.
- 2.9.1.3. The CVS heat exchanger (if installed) shall be pre-heated or pre-cooled to within its operating test temperature tolerance as specified in paragraph 3.3.5.1. of Sub-Annex 5.
- 2.9.1.4. Components such as sample lines, filters, chillers and pumps shall be heated or cooled as required until stabilised operating temperatures are reached.
- 2.9.1.5. CVS flow rates shall be set in accordance with paragraph 3.3.4. of Sub-Annex 5, and sample flow rates shall be set to the appropriate levels.
- 2.9.1.6. Any electronic integrating device shall be zeroed and may be re-zeroed before the start of any cycle phase.

▼ M3

- 2.9.1.7. For all continuous gas analysers, the appropriate ranges shall be selected. These may be switched during a test only if switching is performed by changing the calibration over which the digital resolution of the instrument is applied. The gains of an analyser's analogue operational amplifiers may not be switched during a test.
- 2.9.1.8. All continuous gas analysers shall be zeroed and calibrated using gases fulfilling the requirements of paragraph 6. of Sub-Annex 5.
- 2.10. Sampling for PM determination
- 2.10.1. The steps described in paragraphs 2.10.1.1. to 2.10.1.2.2. of this Sub-Annex shall be taken prior to each test.
- 2.10.1.1. Filter selection
- A single particulate sample filter without back-up shall be employed for the complete applicable WLTC. In order to accommodate regional cycle variations, a single filter may be employed for the first three phases and a separate filter for the fourth phase.
- 2.10.1.2. Filter preparation
- 2.10.1.2.1. At least 1 hour before the test, the filter shall be placed in a petri dish protecting against dust contamination and allowing air exchange, and placed in a weighing chamber (or room) for stabilization.
- At the end of the stabilization period, the filter shall be weighed and its weight shall be included in all relevant test sheets. The filter shall subsequently be stored in a closed petri dish or sealed filter holder until needed for testing. The filter shall be used within 8 hours of its removal from the weighing chamber (or room).
- The filter shall be returned to the stabilization room within 1 hour after the test and shall be conditioned for at least 1 hour before weighing.
- 2.10.1.2.2. The particulate sample filter shall be carefully installed into the filter holder. The filter shall be handled only with forceps or tongs. Rough or abrasive filter handling will result in erroneous weight determination. The filter holder assembly shall be placed in a sample line through which there is no flow.
- 2.10.1.2.3. It is recommended that the microbalance be checked at the start of each weighing session, within 24 hours of the sample weighing, by weighing one reference item of approximately 100 mg. This item shall be weighed three times and the arithmetic average result included in all relevant test sheets. If the arithmetic average result of the weighings is $\pm 5 \mu\text{g}$ of the result from the previous weighing session, the weighing session and balance are considered valid.
- 2.11. PN sampling
- 2.11.1. The steps described in paragraphs 2.11.1.1. to 2.11.1.2. of this Sub-Annex shall be taken prior to each test:
- 2.11.1.1. The particle specific dilution system and measurement equipment shall be started and made ready for sampling;
- 2.11.1.2. The correct function of the PNC and VPR elements of the particle sampling system shall be confirmed in accordance with the procedures listed in paragraphs 2.11.1.2.1. to 2.11.1.2.4. of this Sub-Annex.

▼ M3

- 2.11.1.2.1. A leak check, using a filter of appropriate performance attached to the inlet of the entire PN measurement system, VPR and PNC, shall report a measured concentration of less than 0,5 particles per cm³.
- 2.11.1.2.2. Each day, a zero check on the PNC, using a filter of appropriate performance at the PNC inlet, shall report a concentration of $\leq 0,2$ particles per cm³. Upon removal of the filter, the PNC shall show an increase in measured concentration to at least 100 particles per cm³ when sampling ambient air and a return to $\leq 0,2$ particles per cm³ on replacement of the filter.
- 2.11.1.2.3. It shall be confirmed that the measurement system indicates that the evaporation tube, where featured in the system, has reached its correct operating temperature.
- 2.11.1.2.4. It shall be confirmed that the measurement system indicates that the diluter PND₁ has reached its correct operating temperature.
- 2.12. Sampling during the test
- 2.12.1. The dilution system, sample pumps and data collection system shall be started.
- 2.12.2. The PM and PN sampling systems shall be started.
- 2.12.3. Particle number shall be measured continuously. The arithmetic average concentration shall be determined by integrating the analyser signals over each phase.
- 2.12.4. Sampling shall begin before or at the initiation of the powertrain start procedure and end on conclusion of the cycle.
- 2.12.5. Sample switching
- 2.12.5.1. Gaseous emissions
Sampling from the diluted exhaust and dilution air shall be switched from one pair of sample bags to subsequent bag pairs, if necessary, at the end of each phase of the applicable WLTC to be driven.
- 2.12.5.2. Particulate
The requirements of paragraph 2.10.1.1. of this Sub-Annex shall apply.
- 2.12.6. Dynamometer distance shall be included in all relevant test sheets for each phase.
- 2.13. Ending the test
- 2.13.1. The engine shall be turned off immediately after the end of the last part of the test.
- 2.13.2. The constant volume sampler, CVS, or other suction device shall be turned off, or the exhaust tube from the tailpipe or tailpipes of the vehicle shall be disconnected.
- 2.13.3. The vehicle may be removed from the dynamometer.
- 2.14. Post-test procedures
- 2.14.1. Gas analyser check
Zero and calibration gas reading of the analysers used for continuous diluted measurement shall be checked. The test shall be considered acceptable if the difference between the pre-test and post-test results is less than 2 per cent of the calibration gas value.

▼ M3

- 2.14.2. Bag analysis
- 2.14.2.1. Exhaust gases and dilution air contained in the bags shall be analysed as soon as possible. Exhaust gases shall, in any event, be analysed not later than 30 minutes after the end of the cycle phase.
- The gas reactivity time for compounds in the bag shall be taken into consideration.
- 2.14.2.2. As soon as practical prior to analysis, the analyser range to be used for each compound shall be set to zero with the appropriate zero gas.
- 2.14.2.3. The calibration curves of the analysers shall be set by means of calibration gases of nominal concentrations of 70 to 100 per cent of the range.
- 2.14.2.4. The zero settings of the analysers shall be subsequently rechecked: if any reading differs by more than 2 per cent of the range from that set in paragraph 2.14.2.2. of this Sub-Annex, the procedure shall be repeated for that analyser.
- 2.14.2.5. The samples shall be subsequently analysed.
- 2.14.2.6. After the analysis, zero and calibration points shall be rechecked using the same gases. The test shall be considered acceptable if the difference is less than 2 per cent of the calibration gas value.
- 2.14.2.7. The flow rates and pressures of the various gases through analysers shall be the same as those used during calibration of the analysers.
- 2.14.2.8. The content of each of the compounds measured shall be included in all relevant test sheets after stabilization of the measuring device.
- 2.14.2.9. The mass and number of all emissions, where applicable, shall be calculated in accordance with Sub-Annex 7.
- 2.14.2.10. Calibrations and checks shall be performed either:
- (a) Before and after each bag pair analysis; or
- (b) Before and after the complete test.
- In case (b), calibrations and checks shall be performed on all analysers for all ranges used during the test.
- In both cases, (a) and (b), the same analyser range shall be used for the corresponding ambient air and exhaust bags.
- 2.14.3. Particulate sample filter weighing
- 2.14.3.1. The particulate sample filter shall be returned to the weighing chamber (or room) no later than 1 hour after completion of the test. It shall be conditioned in a petri dish, which is protected against dust contamination and allows air exchange, for at least 1 hour, and weighed. The gross weight of the filter shall be included in all relevant test sheets.
- 2.14.3.2. At least two unused reference filters shall be weighed within 8 hours of, but preferably at the same time as, the sample filter weighings. Reference filters shall be of the same size and material as the sample filter.
- 2.14.3.3. If the specific weight of any reference filter changes by more than $\pm 5 \mu\text{g}$ between sample filter weighings, the sample filter and reference filters shall be reconditioned in the weighing chamber (or room) and reweighed.

▼ M3

- 2.14.3.4. The comparison of reference filter weighings shall be made between the specific weights and the rolling arithmetic average of that reference filter's specific weights. The rolling arithmetic average shall be calculated from the specific weights collected in the period after the reference filters were placed in the weighing chamber (or room). The averaging period shall be at least one day but not more than 15 days.
- 2.14.3.5. Multiple reconditionings and reweighings of the sample and reference filters are permitted until a period of 80 hours has elapsed following the measurement of gases from the emissions test. If, prior to or at the 80-hour point, more than half the number of reference filters meet the $\pm 5 \mu\text{g}$ criterion, the sample filter weighing may be considered valid. If, at the 80-hour point, two reference filters are employed and one filter fails the $\pm 5 \mu\text{g}$ criterion, the sample filter weighing may be considered valid under the condition that the sum of the absolute differences between specific and rolling means from the two reference filters shall be less than or equal to $10 \mu\text{g}$.
- 2.14.3.6. In the case that less than half of the reference filters meet the $\pm 5 \mu\text{g}$ criterion, the sample filter shall be discarded, and the emissions test repeated. All reference filters shall be discarded and replaced within 48 hours. In all other cases, reference filters shall be replaced at least every 30 days and in such a manner that no sample filter is weighed without comparison to a reference filter that has been present in the weighing chamber (or room) for at least one day.
- 2.14.3.7. If the weighing chamber (or room) stability criteria outlined in paragraph 4.2.2.1. of Sub-Annex 5 are not met, but the reference filter weighings meet the above criteria, the vehicle manufacturer has the option of accepting the sample filter weights or voiding the tests, repairing the weighing chamber (or room) control system and re-running the test.

▼ M3*Sub-Annex 6 - Appendix 1***Emissions test procedure for all vehicles equipped with periodically regenerating systems**

1. General
 - 1.1. This Appendix defines the specific provisions regarding testing a vehicle equipped with periodically regenerating systems as defined in paragraph 3.8.1. of this Annex.
 - 1.2. During cycles where regeneration occurs, emission standards need not apply. If a periodic regeneration occurs at least once per Type 1 test and has already occurred at least once during vehicle preparation or the distance between two successive periodic regenerations is more than 4 000 km of driving repeated Type 1 tests, it does not require a special test procedure. In this case, this Appendix does not apply and a K_i factor of 1,0 shall be used.
 - 1.3. The provisions of this Appendix shall apply for the purposes of PM measurements only and not PN measurements.
 - 1.4. At the request of the manufacturer, and with approval of the approval authority, the test procedure specific to periodically regenerating systems need not apply to a regenerative device if the manufacturer provides data demonstrating that, during cycles where regeneration occurs, emissions remain below the emissions limits for the relevant vehicle category. In this case, a fixed K_i value of 1,05 shall be used for CO₂ and fuel consumption.
 - 1.5. At the request of the manufacturer and with the agreement of the approval authority the Extra High phase may be excluded for determining the regenerative factor K_i for Class 2 and Class 3 vehicles.
2. Test procedure

The test vehicle shall be capable of inhibiting or permitting the regeneration process provided that this operation has no effect on original engine calibrations. Prevention of regeneration is only permitted during loading of the regeneration system and during the preconditioning cycles. It is not permitted during the measurement of emissions during the regeneration phase. The emission test shall be carried out with the unchanged, original equipment manufacturer's (OEM) control unit. At the request of the manufacturer and with agreement of the approval authority, an 'engineering control unit' which has no effect on original engine calibrations may be used during K_i determination.

 - 2.1. Exhaust emissions measurement between two WLTCs with regeneration events
 - 2.1.1. The arithmetic average emissions between regeneration events and during loading of the regenerative device shall be determined from the arithmetic mean of several approximately equidistant (if more than two) Type 1 tests. As an alternative, the manufacturer may provide data to show that the emissions remain constant (± 15 per cent) on WLTCs between regeneration events. In this case, the emissions measured during the Type 1 test may be used. In any other case, emissions measurements for at least two Type 1 cycles shall be completed: one immediately after regeneration (before new loading) and one as close as possible prior to a regeneration phase. All emissions measurements shall be carried out in accordance with this Sub-Annex and all calculations shall be carried out in accordance with paragraph 3. of this Appendix.

▼ **M3**

- 2.1.2. The loading process and K_i determination shall be made during the Type 1 driving cycle on a chassis dynamometer or on an engine test bench using an equivalent test cycle. These cycles may be run continuously (i.e. without the need to switch the engine off between cycles). After any number of completed cycles, the vehicle may be removed from the chassis dynamometer and the test continued at a later time. Upon request of the manufacturer and with approval of the approval authority, a manufacturer may develop an alternative procedure and demonstrate its equivalency, including filter temperature, loading quantity and distance driven. This may be done on an engine bench or on a chassis dynamometer.
- 2.1.3. The number of cycles D between two WLTCs where regeneration events occur, the number of cycles over which emission measurements are made n and mass emissions measurement M'_{sij} for each compound i over each cycle j shall be included in all relevant test sheets.
- 2.2. Measurement of emissions during regeneration events
- 2.2.1. Preparation of the vehicle, if required, for the emissions test during a regeneration phase, may be completed using the preconditioning cycles in paragraph 2.6. of this Sub-Annex or equivalent engine test bench cycles, depending on the loading procedure chosen in paragraph 2.1.2. of this Appendix.
- 2.2.2. The test and vehicle conditions for the Type 1 test described in this Annex apply before the first valid emission test is carried out.
- 2.2.3. Regeneration shall not occur during the preparation of the vehicle. This may be ensured by one of the following methods:
- 2.2.3.1. A 'dummy' regenerating system or partial system may be fitted for the preconditioning cycles.
- 2.2.3.2. Any other method agreed between the manufacturer and the approval authority.
- 2.2.4. A cold start exhaust emissions test including a regeneration process shall be performed in accordance with the applicable WLTC.
- 2.2.5. If the regeneration process requires more than one WLTC, each WLTC shall be completed. Use of a single particulate sample filter for multiple cycles required to complete regeneration is permissible.
- If more than one WLTC is required, subsequent WLTC(s) shall be driven immediately, without switching the engine off, until complete regeneration has been achieved. In the case that the number of gaseous emission bags required for the multiple cycles would exceed the number of bags available, the time necessary to set up a new test shall be as short as possible. The engine shall not be switched off during this period.
- 2.2.6. The emission values during regeneration M_{pi} for each compound i shall be calculated in accordance with paragraph 3. of this Appendix. The number of applicable test cycles d measured for complete regeneration shall be included in all relevant test sheets.
3. Calculations
- 3.1. Calculation of the exhaust and CO₂ emissions, and fuel consumption of a single regenerative system

▼ **M3**

$$M_{si} = \frac{\sum_{j=1}^n M'_{sij}}{n} \text{ for } n \geq 1$$

$$M_{ri} = \frac{\sum_{j=1}^d M'_{rij}}{d} \text{ for } d \geq 1$$

$$M_{pi} = \frac{M_{si} \times D + M_{ri} \times d}{D + d}$$

where for each compound i considered:

M'_{sij} are the mass emissions of compound i over test cycle j without regeneration, g/km;

M'_{rij} are the mass emissions of compound i over test cycle j during regeneration, g/km (if $d > 1$, the first WLTC test shall be run cold and subsequent cycles hot);

M_{si} are the mean mass emissions of compound i without regeneration, g/km;

M_{ri} are the mean mass emissions of compound i during regeneration, g/km;

M_{pi} are the mean mass emissions of compound i , g/km;

n is the number of test cycles, between cycles where regenerative events occur, during which emissions measurements on Type 1 WLTCs are made, ≥ 1 ;

d is the number of complete applicable test cycles required for regeneration;

D is the number of complete applicable test cycles between two cycles where regeneration events occur.

The calculation of M_{pi} is shown graphically in Figure A6.App1/1.

Figure A6.App1/1

Parameters measured during emissions test during and between cycles where regeneration occurs (schematic example, the emissions during D may increase or decrease)

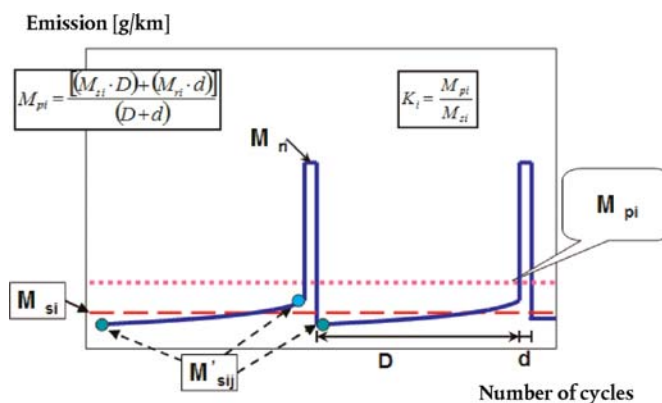

3.1.1. Calculation of the regeneration factor K_i for each compound i considered.

The manufacturer may elect to determine for each compound independently either additive offsets or multiplicative factors.

K_i factor: $K_i = \frac{M_{pi}}{M_{si}}$

K_i offset: $K_i = M_{pi} - M_{si}$

▼ **M3**

M_{si} , M_{pi} and K_i results, and the manufacturer's choice of type of factor shall be recorded. The K_i result shall be included in all relevant test reports. M_{si} , M_{pi} and K_i results shall be included in all relevant test sheets.

K_i may be determined following the completion of a single regeneration sequence comprising measurements before, during and after regeneration events as shown in Figure A6.App1/1.

3.2. Calculation of exhaust and CO₂ emissions, and fuel consumption of multiple periodically regenerating systems

The following shall be calculated for one Type 1 operation cycle for criteria emissions and for CO₂ emissions. The CO₂ emissions used for that calculation shall be from the result of step 3 described in Table A7/1 of Sub-Annex 7.

$$M_{sik} = \frac{\sum_{j=1}^{n_k} M'_{sik,j}}{n_k} \text{ for } n_j \geq 1$$

$$M_{rik} = \frac{\sum_{j=1}^{d_k} M'_{rik,j}}{d_k} \text{ for } d \geq 1$$

$$M_{si} = \frac{\sum_{k=1}^x M_{sik} \times D_k}{\sum_{k=1}^x D_k}$$

$$M_{ri} = \frac{\sum_{k=1}^x M_{rik} \times d_k}{\sum_{k=1}^x d_k}$$

$$M_{pi} = \frac{M_{si} \times \sum_{k=1}^x D_k + M_{ri} \times \sum_{k=1}^x d_k}{\sum_{k=1}^x (D_k + d_k)}$$

$$M_{pi} = \frac{\sum_{k=1}^x (M_{sik} \times D_k + M_{rik} \times d_k)}{\sum_{k=1}^x (D_k + d_k)}$$

K_i factor: $K_i = \frac{M_{pi}}{M_{si}}$

K_i offset: $K_i = M_{pi} - M_{si}$

where:

M_{si} are the mean mass emissions of all events k of compound i without regeneration, g/km;

M_{ri} are the mean mass emissions of all events k of compound i during regeneration, g/km;

M_{pi} are the mean mass emission of all events k of compound i , g/km;

M_{sik} are the mean mass emissions of event k of compound i without regeneration, g/km;

M_{rik} are the mean mass emissions of event k of compound i during regeneration, g/km;

$M'_{sik,j}$ are the mass emissions of event k of compound i in g/km without regeneration measured at point j where $1 \leq j \leq n_k$, g/km;

$M'_{rik,j}$ are the mass emissions of event k of compound i during regeneration (when $j > 1$, the first Type 1 test is run cold, and subsequent cycles are hot) measured at test cycle j where $1 \leq j \leq d_k$, g/km;

n_k are the number of complete test cycles of event k , between two cycles where regenerative phases occur, during which emissions measurements (Type 1 WLTCs or equivalent engine test bench cycles) are made, ≥ 2 ;

▼ **M3**

- d_k is the number of complete applicable test cycles of event k required for complete regeneration;
- D_k is the number of complete applicable test cycles of event k between two cycles where regenerative phases occur;
- x is the number of complete regeneration events.

The calculation of M_{pi} is shown graphically in Figure A6.App1/2.

Figure A6.App1/2

Parameters measured during emissions test during and between cycles where regeneration occurs (schematic example)

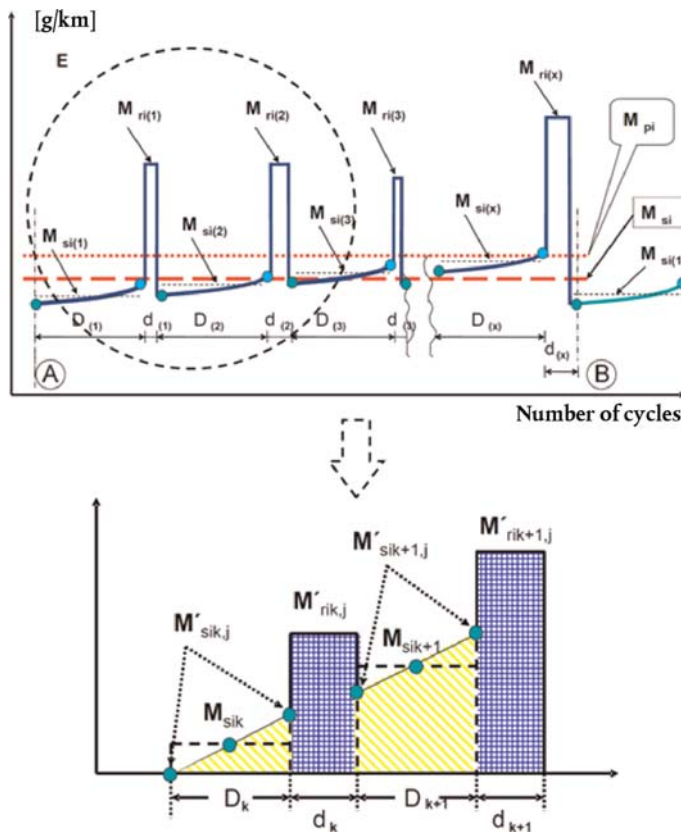

The calculation of K_i for multiple periodically regenerating systems is only possible after a certain number of regeneration events for each system.

After performing the complete procedure (A to B, see Figure A6.App1/2), the original starting condition A should be reached again.

- 3.3. K_i factors (multiplicative or additive) shall be rounded to four decimal places based on the physical unit of the emission standard value.

▼ **M3***Sub-Annex 6 - Appendix 2***Test procedure for rechargeable electric energy storage system monitoring**

1. General

In the case that NOVC-HEVs and OVC-HEVs are tested, Appendices 2 and 3 to Sub-Annex 8 shall apply.

This Appendix defines the specific provisions regarding the correction of test results for CO₂ mass emission as a function of the energy balance ΔE_{REESS} for all REESSs.

The corrected values for CO₂ mass emission shall correspond to a zero energy balance ($\Delta E_{\text{REESS}} = 0$), and shall be calculated using a correction coefficient determined as defined below.

2. Measurement equipment and instrumentation

2.1. Current measurement

REESS depletion shall be defined as negative current.

2.1.1. The REESS current(s) shall be measured during the tests using a clamp-on or closed type current transducer. The current measurement system shall fulfil the requirements specified in Table A8/1. The current transducer(s) shall be capable of handling the peak currents at engine starts and temperature conditions at the point of measurement.

In order to have an accurate measurement, zero adjustment and degaussing shall be performed before the test in accordance with the instrument manufacturer's instructions.

2.1.2. Current transducers shall be fitted to any of the REESS on one of the cables connected directly to the REESS and shall include the total REESS current.

In case of shielded wires, appropriate methods shall be applied in accordance with the approval authority.

In order to easily measure REESS current using external measuring equipment, manufacturers should preferably integrate appropriate, safe and accessible connection points in the vehicle. If this is not feasible, the manufacturer shall support the approval authority by providing the means to connect a current transducer to the REESS cables in the manner described above.

2.1.3. The measured current shall be integrated over time at a minimum frequency of 20 Hz, yielding the measured value of Q, expressed in ampere-hours Ah. The measured current shall be integrated over time, yielding the measured value of Q, expressed in ampere-hours Ah. The integration may be done in the current measurement system.

2.2. Vehicle on-board data

2.2.1. Alternatively, the REESS current shall be determined using vehicle-based data. In order to use this measurement method, the following information shall be accessible from the test vehicle:

- (a) Integrated charging balance value since last ignition run in Ah;
- (b) Integrated on-board data charging balance value calculated at a minimum sample frequency of 5 Hz;
- (c) The charging balance value via an OBD connector as described in SAE J1962.

▼ M3

2.2.2. The accuracy of the vehicle on-board REESS charging and discharging data shall be demonstrated by the manufacturer to the approval authority.

The manufacturer may create a REESS monitoring vehicle family to prove that the vehicle on-board REESS charging and discharging data are correct. The accuracy of the data shall be demonstrated on a representative vehicle.

The following family criteria shall be valid:

- (a) Identical combustion processes (i.e. positive ignition, compression ignition, two-stroke, four-stroke);
- (b) Identical charge and/or recuperation strategy (software REESS data module);
- (c) On-board data availability;
- (d) Identical charging balance measured by REESS data module;
- (e) Identical on-board charging balance simulation.

2.2.3. All REESS having no influence on CO₂ mass emissions shall be excluded from monitoring.

3. REESS energy change-based correction procedure

3.1. Measurement of the REESS current shall start at the same time as the test starts and shall end immediately after the vehicle has driven the complete driving cycle.

3.2. The electricity balance Q measured in the electric power supply system, shall be used as a measure of the difference in the REESS energy content at the end of the cycle compared to the beginning of the cycle. The electricity balance shall be determined for the total driven WLTC.

3.3. Separate values of Q_{phase} shall be logged over the driven cycle phases.

3.4. Correction of CO₂ mass emission over the whole cycle as a function of the correction criterion c

3.4.1. Calculation of the correction criterion c

The correction criterion c is the ratio between the absolute value of the electric energy change $\Delta E_{\text{REESS},j}$ and the fuel energy and shall be calculated using the following equations:

$$c = \left| \frac{\Delta E_{\text{REESS},j}}{E_{\text{fuel}}} \right|$$

where:

c is the correction criterion;

$\Delta E_{\text{REESS},j}$ is the electric energy change of all REESSs over period j determined in accordance with paragraph 4.1. of this Appendix, Wh;

j is, in this paragraph, the whole applicable WLTP test cycle;

E_{Fuel} is the fuel energy calculated with the following equation:

$$E_{\text{fuel}} = 10 \times \text{HV} \times \text{FC}_{\text{nb}} \times d$$

where:

E_{fuel} is the energy content of the consumed fuel over the applicable WLTP test cycle, Wh;

HV is the heating value in accordance with Table A6.App2/1, kWh/l;

▼ **M3**

- FC_{nb} is the non-balanced fuel consumption of the Type 1 test, not corrected for the energy balance, determined in accordance with paragraph 6. of Sub-Annex 7, and using the results for criteria emissions and CO_2 calculated in Step 2 in Table A7/1, l/100 km;
- d is the distance driven over the corresponding applicable WLTP test cycle, km;
- 10 conversion factor to Wh.

3.4.2. The correction shall be applied if ΔE_{REESS} is negative (corresponding to REESS discharging) and the correction criterion 'c' calculated in accordance with paragraph 3.4.1. of this Appendix is greater than the applicable threshold in accordance with Table A6.App2/2.

3.4.3. The correction shall be omitted and uncorrected values shall be used if the correction criterion 'c' calculated in accordance with paragraph 3.4.1. of this Appendix is less than the applicable threshold in accordance with Table A6.App2/2.

3.4.4. The correction may be omitted and uncorrected values may be used if:

- (a) ΔE_{REESS} is positive (corresponding to REESS charging) and the correction criterion 'c' calculated in accordance with paragraph 3.4.1. of this Appendix is greater than the applicable threshold in accordance with Table A6.App2/2;
- (b) the manufacturer can prove to the approval authority by measurement that there is no relation between ΔE_{REESS} and CO_2 mass emission and ΔE_{REESS} and fuel consumption respectively.

Table A6.App2/1

Energy content of fuel

Fuel	Petrol						Diesel				
Content Ethanol/ Biodiesel, per cent			E10			E85			B7		
Heat value (kWh/l)			8,64			6,41			9,79		

Table A6.App2/2

RCB correction criteria thresholds

Cycle	low + medium)	low + medium + high	low + medium + high + extra high
Thresholds for correction criterion c	0,015	0,01	0,005

4. Applying the correction function

4.1. To apply the correction function, the electric energy change $\Delta T_{REESS,j}$ of a period j of all REESSs shall be calculated from the measured current and the nominal voltage:

$$\Delta E_{REESS,j} = \sum_{i=1}^n \Delta E_{REESS,j,i}$$

where:

$\Delta E_{REESS,j,i}$ is the electric energy change of REESS i during the considered period j , Wh;

▼ **M3**

and:

$$\Delta E_{\text{REESS},j,i} = \frac{1}{3\,600} \times U_{\text{REESS}} \times \int_{t_0}^{t_{\text{end}}} I(t)_{j,i} dt$$

where:

U_{REESS} is the nominal REESS voltage determined in accordance with IEC 60050-482, V;

$I(t)_{j,i}$ is the electric current of REESS i during the considered period j , determined in accordance with paragraph 2. of this Appendix, A;

t_0 is the time at the beginning of the considered period j , s;

t_{end} is the time at the end of the considered period j , s.

i is the index number of the considered REESS;

n is the total amount of REESS;

j is the index number for the considered period, where a period shall be any applicable cycle phase, combination of cycle phases and the applicable total cycle;

$\frac{1}{3\,600}$ is the conversion factor from Ws to Wh.

4.2. For correction of CO₂ mass emission, g/km, combustion process-specific Willans factors from Table A6.App2/3 shall be used.

4.3. The correction shall be performed and applied for the total cycle and for each of its cycle phases separately, and shall be included in all relevant test reports.

4.4. For this specific calculation, a fixed electric power supply system alternator efficiency shall be used:

$\eta_{\text{alternator}} = 0,67$ for electric power supply system REESS alternators

4.5. The resulting CO₂ mass emission difference for the considered period j due to load behaviour of the alternator for charging a REESS shall be calculated using the following equation:

$$\Delta M_{\text{CO}_2,j} = 0,0036 \times \Delta E_{\text{REESS},j} \times \frac{1}{\eta_{\text{alternator}}} \times \text{Willans}_{\text{factor}} \times \frac{1}{d_j}$$

where:

$\Delta M_{\text{CO}_2,j}$ is the resulting CO₂ mass emission difference of period j , g/km;

$\Delta E_{\text{REESS},j}$ is the REESS energy change of the considered period j calculated in accordance with paragraph 4.1. of this Appendix, Wh;

d_j is the driven distance of the considered period j , km;

j is the index number for the considered period, where a period shall be any applicable cycle phase, combination of cycle phases and the applicable total cycle;

0,0036 is the conversion factor from Wh to MJ;

$\eta_{\text{alternator}}$ is the efficiency of the alternator in accordance with paragraph 4.4. of this Appendix;

$\text{Willans}_{\text{factor}}$ is the combustion process-specific Willans factor as defined in Table A6.App2/3, gCO₂/MJ;

4.5.1. The CO₂ values of each phase and the total cycle shall be corrected as follows:

$$M_{\text{CO}_2,p,3} = M_{\text{CO}_2,p,1} - \Delta M_{\text{CO}_2,j}$$

▼ **M3**

$$M_{\text{CO}_2, \text{e}, 3} = M_{\text{CO}_2, \text{e}, 2} - \Delta M_{\text{CO}_2, \text{j}}$$

where:

$\Delta M_{\text{CO}_2, \text{j}}$ is the result from paragraph 4.5. of this Appendix for a period j , g/km.

- 4.6. For the correction of CO₂ emission, g/km, the Willans factors in Table A6.App2/3 shall be used.

Table A6.App2/3

Willans factors

			Naturally aspirated	Pressure-charged
Positive ignition				
	Petrol (E10)	l/MJ	0,0756	0,0803
		gCO ₂ /MJ	174	184
	CNG (G20)	m ³ /MJ	0,0719	0,0764
		gCO ₂ /MJ	129	137
	LPG	l/MJ	0,0950	0,101
		gCO ₂ /MJ	155	164
	E85	l/MJ	0,102	0,108
		gCO ₂ /MJ	169	179
Compression ignition				
	Diesel (B7)	l/MJ	0,0611	0,0611
		gCO ₂ /MJ	161	161

▼ **M3***Sub-Annex 6 - Appendix 3***Calculation of gas energy ratio for gaseous fuels (LPG and NG/biomethane)**

1. Measurement of the mass of gaseous fuel consumed during the Type 1 test cycle

Measurement of the mass of gas consumed during the cycle shall be done by a fuel weighing system capable of measuring the weight of the storage container during the test in accordance with the following:

- (a) An accuracy of ± 2 per cent of the difference between the readings at the beginning and at the end of the test or better.
- (b) Precautions shall be taken to avoid measurement errors.
Such precautions shall at least include the careful installation of the device in accordance with the instrument manufacturer's recommendations and to good engineering practice.
- (c) Other measurement methods are permitted if an equivalent accuracy can be demonstrated.

2. Calculation of the gas energy ratio

The fuel consumption value shall be calculated from the emissions of hydrocarbons, carbon monoxide, and carbon dioxide determined from the measurement results assuming that only the gaseous fuel is burned during the test.

The gas ratio of the energy consumed in the cycle shall be determined using the following equation:

$$G_{\text{gas}} = \left(\frac{M_{\text{gas}} \times \text{cf} \times 10^4}{\text{FC}_{\text{norm}} \times \text{dist} \times \rho} \right)$$

where:

- G_{gas} is the gas energy ratio, per cent;
- M_{gas} is the mass of the gaseous fuel consumed during the cycle, kg;
- FC_{norm} is the fuel consumption (l/100 km for LPG, m³/100 km for NG/biomethane) calculated in accordance with paragraphs 6.6. and 6.7. of Sub-Annex 7;
- dist is the distance recorded during the cycle, km;
- ρ is the gas density:
 $\rho = 0,654 \text{ kg/m}^3$ for NG/Biomethane;
 $\rho = 0,538 \text{ kg/litre}$ for LPG;
- cf is the correction factor, assuming the following values:
 cf = 1 in the case of LPG or G20 reference fuel;
 cf = 0,78 in the case of G25 reference fuel.

▼ **M3***Sub-Annex 6a***Ambient Temperature Correction Test for the determination of CO₂ emissions under representative regional temperature conditions**

1. Introduction

This Sub-Annex describes the supplemental Ambient Temperature Correction Test (ATCT) procedure to determine the CO₂ emissions under representative regional temperature conditions.

- 1.1. The CO₂ emissions of ICE vehicles, NOVC-HEVs and the charge sustaining value of OVC-HEVs shall be corrected in accordance with the requirements of this Sub-Annex. No correction is required for the CO₂ value of the charge depleting test. No correction is required for an Electric Range.

2. Ambient Temperature Correction Test (ATCT) Family

- 2.1. Only vehicles which are identical with respect to all the following characteristics are permitted to be part of the same ATCT Family:

- (a) Powertrain architecture (i.e. internal combustion, hybrid, fuel cell, or electric);
- (b) Combustion process (i.e. two stroke or four stroke);
- (c) Number and arrangement of cylinders;
- (d) Method of engine combustion (i.e. indirect or direct injection);
- (e) Type of cooling system (i.e. air, water, or oil);
- (f) Method of aspiration (i.e. naturally aspirated, or charged);
- (g) Fuel for which the engine is designed (i.e. petrol, diesel, NG, LPG, etc.);
- (h) Catalytic converter (i.e. three-way catalyst, lean NO_x trap, SCR, lean NO_x catalyst or other(s));
- (i) Whether or not a particulate trap is installed; and
- (j) Exhaust gas recirculation (with or without, cooled or non-cooled).

In addition the vehicles shall be similar with respect to the following characteristics:

- (k) The vehicles shall have a variation in engine cylinder capacity of no more than 30 % of the vehicle with the lowest capacity; and
- (l) Engine compartment insulation shall be of a similar type regarding material, amount and location of the insulation. Manufacturers shall provide evidence (e.g. by CAD drawings) to the approval authority that for all vehicles in the family, the volume and weight of the insulation material which will be installed is greater than 90 % of that of the ATCT measured reference vehicle.

Difference in insulation material and location may also be accepted to be part of a single ATCT family under the condition that the test vehicle can be demonstrated as being the worst case with regards to engine compartment insulation.

▼ M3

2.1.1. If active heat storage devices are installed, only vehicles that meet the following requirements shall be considered to be part of the same ATCT Family:

- (i) the heat capacity, defined by the enthalpy stored in the system, is within a range of 0 to 10 % above the enthalpy of the test vehicle; and
- (ii) the OEM can provide evidence to the technical service that the time for heat release at engine start within a family is within a range of 0 to 10 % below the time for the heat release of the test vehicle.

2.1.2. Only vehicles that meet the criteria set out in paragraph 3.9.4. of this Sub-Annex 6a shall be considered to be part of the same ATCT Family.

3. ATCT Procedure

The Type 1 test specified in Sub-Annex 6 shall be carried out with the exception of the requirements specified in paragraphs 3.1. to 3.9. of this Sub-Annex 6a. That requires also a new calculation and application of gearshift points in accordance with Sub-Annex 2 taking into account the different road load as specified in paragraph 3.4. of this Sub-Annex 6a.

3.1. Ambient conditions for ATCT

3.1.1. The temperature (T_{reg}) at which the vehicle should be soaked and tested for the ATCT shall be 14 °C.

3.1.2. The minimum soaking time (t_{soak_ATCT}) for the ATCT shall be 9 hours.

3.2. Test cell and soak area

3.2.1. Test cell

3.2.1.1. The test cell shall have a temperature set point equal to T_{reg} . The actual temperature value shall be within ± 3 °C at the start of the test and within ± 5 °C during the test.

3.2.1.2. The specific humidity (H) of either the air in the test cell or the intake air of the engine shall be such that:

$$3,0 \leq H \leq 8,1 \quad (\text{g H}_2\text{O/kg dry air})$$

3.2.1.3. The air temperature and humidity shall be measured at the cooling fan outlet at a rate of 0,1 Hz.

3.2.2. Soak area

3.2.2.1. The soak area shall have a temperature set point equal to T_{reg} and the actual temperature value shall be within ± 3 °C on a 5 minute running arithmetic average and shall not show a systematic deviation from the set point. The temperature shall be measured continuously at a minimum frequency of 0,033 Hz.

3.2.2.2. The location of the temperature sensor for the soak area shall be representative to measure the ambient temperature around the vehicle and shall be checked by the technical service.

The sensor shall be at least 10 cm away from the wall of the soak area and shall be shielded from direct air flow.

▼ **M3**

The air-flow conditions within the soak room in the vicinity of the vehicle shall represent a natural convection flow representative for the dimension of the room (no forced convection).

- 3.3. Test vehicle
- 3.3.1. The vehicle to be tested shall be representative of the family for which the ATCT data are determined (as described in paragraph 2.1. of this Sub-Annex 6a).
- 3.3.2. From the ATCT Family, the Interpolation Family with the lowest engine capacity shall be selected (see paragraph 2 of this Sub-Annex 6a), and the test vehicle shall be in the 'vehicle H' configuration of this family.
- 3.3.3. Where applicable, the vehicle with the lowest enthalpy of the active heat storage device and the slowest heat release for the active heat storage device from the ATCT Family shall be selected.
- 3.3.4. The test vehicle shall meet the requirements detailed in paragraph 2.3. of Sub-Annex 6 and paragraph 2.1 of this Sub-Annex 6a.
- 3.4. Settings
- 3.4.1. Road load and dynamometer settings shall be as specified in Sub-Annex 4, including the requirement for the room temperature to be at 23 °C.

To take account of the difference in air density at 14 °C when compared to the air density at 20 °C, the chassis dynamometer shall be set as specified in paragraphs 7. and 8. of Sub-Annex 4 with the exception that f_{2_TReg} from the following equation shall be used as the target coefficient C_t .

$$f_{2_TReg} = f_2 \times (T_{ref} + 273)/(T_{reg} + 273)$$

where:

f_2 is the second order road load coefficient, at reference conditions, $N/(km/h)^2$;

T_{ref} is the road load reference temperature as specified in paragraph 3.2.10. of this Annex, C;

T_{reg} is the regional temperature, as defined in paragraph 3.1.1., C.

In the case that a valid chassis dynamometer setting of the 23 °C test is available, the second order chassis dynamometer coefficient of C_d shall be adapted in accordance with the following equation:

$$C_{d_TReg} = C_d + (f_{2_TReg} - f_2)$$

- 3.4.2. The ATCT test and its road load setting shall be performed on a 2WD dynamometer in the case that the corresponding Type 1 test was done on a 2WD dynamometer; and it shall be performed on a 4WD dynamometer in the case that the corresponding Type 1 test was done on a 4WD dynamometer.

3.5. Preconditioning

At the request of the manufacturer preconditioning may be undertaken at T_{reg} .

The engine temperature shall be within ± 2 °C of the set point of 23 °C or T_{reg} , whichever temperature is chosen for the preconditioning.

▼ **M3**

- 3.5.1. Pure ICE vehicles shall be preconditioned as described in paragraph 2.6. of Sub-Annex 6.
- 3.5.2. NOVC-HEVs shall be preconditioned as described in paragraph 3.3.1.1. of Sub-Annex 8.
- 3.5.3. OVC-HEVs shall be preconditioned as described in paragraph 2.1.1. or 2.1.2. of Appendix 4 to Sub-Annex 8.
- 3.6. Soak procedure
- 3.6.1. After preconditioning and before testing, vehicles shall be kept in a soak area with the ambient conditions described in paragraph 3.2.2. of this Sub-Annex 6a.
- 3.6.2. From the end of the preconditioning until the soaking at T_{reg} , the vehicle shall not be exposed to a different temperature than T_{reg} for longer than 10 minutes.
- 3.6.3. The vehicle shall then be kept in the soak area such that the time from the end of the preconditioning test to the beginning of the ATCT test is equal to t_{soak_ATCT} with a tolerance of an additional 15 minutes. At the request of the manufacturer, and upon approval of the approval authority, t_{soak_ATCT} can be extended by up to 120 minutes. In this case, the extended time shall be used for the cool down specified in paragraph 3.9. of this Sub-Annex 6a.
- 3.6.4. The soak shall be performed without using a cooling fan and with all body parts positioned as intended under normal parking operation. The time between the end of the preconditioning and the start of the ATCT test shall be recorded.
- 3.6.5. The transfer from the soak area to the test cell shall be undertaken as quickly as possible. The vehicle shall not be exposed to a temperature different from T_{reg} for longer than 10 minutes.
- 3.7. ATCT Test
- 3.7.1. The test cycle shall be the applicable WLTC specified in Sub-Annex 1 for that class of vehicle.
- 3.7.2. The procedures for undertaking the emissions test as specified in Sub-Annex 6 for pure ICE vehicles and in Sub-Annex 8 for NOVC-HEVs and for the charge-sustaining Type 1 test of OVC-HEVs shall be followed, with the exception that the ambient conditions for the test cell shall be those as described in paragraph 3.2.1. of this Sub-Annex 6a.
- 3.7.3. In particular, the tailpipe emissions defined by Table A7/1 Step no.1 for pure ICE vehicles and Table A8/5 Step no.2 for HEVs at an ATCT test shall not exceed the Euro 6 emission limits applicable to the vehicle tested defined in Table 2 of Annex I to Regulation (EC) No 715/2007.
- 3.8. Calculation and Documentation
- 3.8.1. The family correction factor, FCF , shall be calculated as follows:

$$FCF = M_{CO_2, T_{reg}} / M_{CO_2, 23^\circ}$$

▼ **M3**

where

$M_{CO_2,23^\circ}$ is the CO₂ mass emission of the average of all applicable Type 1 tests at 23 °C of vehicle H, after Step 3 of Table A7/1 of Sub-Annex 7 for pure ICE vehicles and after Step 3 of Table A8/5 for OVC-HEVs and NOVC-HEVs, but without any further corrections, g/km;

$M_{CO_2,Treg}$ is the CO₂ mass emission over the complete WLTC cycle of the test at regional temperature after Step 3 of Table A7/1 of Sub-Annex 7 for pure ICE vehicles and after Step 3 of Table A8/5 for OVC-HEVs and NOVC-HEVs but without any further corrections, g/km. For OVC-HEVs and NOVC-HEVs, the K_{CO_2} factor as defined in Sub-Annex 8 Appendix 2 shall be used.

Both $M_{CO_2,23^\circ}$ and $M_{CO_2,Treg}$ shall be measured on the same test vehicle.

The *FCF* shall be included in all relevant test reports.

The *FCF* shall be rounded to 4 points of decimal.

- 3.8.2. The CO₂ values for each pure ICE vehicle within the ATCT Family (as defined in paragraph 2.3. of this Sub-Annex 6a) shall be calculated using the following equations:

$$M_{CO_2,c,5} = M_{CO_2,c,4} \times FCF$$

$$M_{CO_2,p,5} = M_{CO_2,p,4} \times FCF$$

where

$M_{CO_2,c,4}$ and $M_{CO_2,p,4}$ are the CO₂ mass emissions over the complete WLTC, c, and the cycle phases, p, resulting from the previous calculation step, g/km;

$M_{CO_2,c,5}$ and $M_{CO_2,p,5}$ are the CO₂ mass emissions over the complete WLTC, c, and the cycle phases, p, including the ATCT correction, and shall be used for any further corrections or any further calculations, g/km;

- 3.8.3. The CO₂ values for each OVC-HEV and NOVC-HEV within the ATCT Family (as defined in paragraph 2.3. of this Sub-Annex 6a) shall be calculated using the following equations:

$$M_{CO_2,CS,c,5} = M_{CO_2,CS,c,4} \times FCF$$

$$M_{CO_2,CS,p,5} = M_{CO_2,CS,p,4} \times FCF$$

where

$M_{CO_2,CS,c,4}$ and $M_{CO_2,CS,p,4}$ are the CO₂ mass emissions over the complete WLTC, c, and the cycle phases, p, resulting from the previous calculation step, g/km;

$M_{CO_2,CS,c,5}$ and $M_{CO_2,CS,p,5}$ are the CO₂ mass emissions over the complete WLTC, c, and the cycle phases, p, including the ATCT correction, and shall be used for any further corrections or any further calculations, g/km.

- 3.8.4. If a *FCF* is less than one, it is deemed to be equal to one, in the case of the worstcase approach, in accordance with paragraph 4.1 of this Sub-Annex.

- 3.9. Provision for cool down

▼ **M3**

- 3.9.1. For the test vehicle serving as a reference vehicle for the ATCT Family and all vehicles H of the interpolation families within the ATCT Family, the end temperature of the engine coolant shall be measured after soaking at 23 °C for the duration of $t_{\text{soak_ATCT}}$, with a tolerance of an additional 15 minutes, having beforehand driven the respective Type 1 test at 23 °C. The duration is measured from the end of that respective Type 1 test.
- 3.9.1.1. In the case that $t_{\text{soak_ATCT}}$ was extended in the respective ATCT test, the same soaking time shall be used, with a tolerance of an additional 15 minutes.
- 3.9.2. The cool down procedure shall be undertaken as soon as possible after the end of the Type 1 test, with a maximum delay of 20 minutes. The measured soaking time is the time between the measurement of the end temperature and the end of the Type 1 test at 23 °C, and shall be included in all relevant test sheets.
- 3.9.3. The average temperature of the soak area of the last 3 hours shall be subtracted from the measured temperature of the engine coolant at the end of the soaking time specified in paragraph 3.9.1. This is referred to as Δ_{T_ATCT} , rounded to the nearest whole number.
- 3.9.4. If Δ_{T_ATCT} is higher or equal than -2 °C from the test vehicle Δ_{T_ATCT} , this Interpolation Family shall be considered to be a member of the same ATCT Family.
- 3.9.5. For all vehicles within an ATCT Family the coolant shall be measured at the same location in the cooling system. That location shall be as close as possible to the engine so that the coolant temperature is as representative as possible to the engine temperature.
- 3.9.6. The measurement of the temperature of the soak areas shall be as specified in paragraph 3.2.2.2. of this Sub-Annex 6a.
4. Alternatives in the measurement process
- 4.1. Worst case approach vehicle cool down
- On request by the manufacturer and with approval by the approval authority, the Type 1 Test procedure for cool down may be applied instead of provisions of paragraph 3.6 of this Sub-Annex 6a. For that purpose:
- (a) The provisions of paragraph 2.7.2. of Sub-Annex 6 shall apply with the additional requirement of a minimum soak time of 9 hours.
- (b) The engine temperature shall be within ± 2 °C of the set point T_{reg} before the start of the ATCT test. That temperature shall be included in all relevant test sheets. In this case, the provision for cool down described in paragraph 3.9. of this Sub-Annex 6a and the criteria on engine compartment insulation can be skipped for all vehicles in the family.

This alternative is not allowed if the vehicle is equipped with an active heat storage device.

The application of that approach shall be included in all relevant test reports.

▼ M3

4.2. ATCT family composed of a single Interpolation family

In the case, that the ATCT family consists of only one interpolation family, the provision for cool down described in paragraph 3.9. of this Sub-Annex 6a can be skipped. This shall be included in all relevant test reports.

4.3. Alternative engine temperature measurement

In the case that measuring the coolant temperature is not feasible, on request of the manufacturer and with approval of the approval authority, instead of using the coolant temperature for the provision for cool down described in paragraph 3.9. of this Sub-Annex 6a, the engine oil temperature may be used. In that case, for all vehicles within the family the engine oil temperature shall be used.

The application of that procedure shall be included in all relevant test reports.

▼ **M3***Sub-Annex 6b***Correction of CO₂ results against the target speed and distance**

1. General

This Sub-Annex 6b defines the specific provisions regarding the correction of CO₂ test results for tolerances against the target speed and distance.

This Sub-Annex 6b applies to pure ICE vehicles only.

2. Vehicle speed measurement

- 2.1. The actual/measured vehicle speed (v_{mi} ; km/h) coming from the roller speed of the chassis dynamometer shall be sampled with a measurement frequency of 10 Hz together with the actual time that corresponds to the actual speed.
- 2.2. The target speed (v_i ; km/h) between time points in Tables A1/1 to A1/12 in Sub-Annex 1 shall be determined by a linear interpolation method at a frequency of 10 Hz.

3. Correction procedure

3.1. Calculation of the actual/measured and target power at the wheels

The power and the forces at the wheels from the target and actual/measured speed shall be calculated by applying the following equations:

$$F_i = f_0 + f_1 \times \frac{(V_i + V_{i-1})}{2} + f_2 \times \frac{(V_i + V_{i-1})^2}{4} + (TM + m_r) \times a_i$$

$$P_i = F_i \times \frac{(V_i + V_{i-1})}{3,6 \times 2} \times 0,001$$

$$F_{mi} = f_0 + f_1 \times \frac{(Vm_i + Vm_{i-1})}{2} + f_2 \times \frac{(Vm_i + Vm_{i-1})^2}{4} + (TM + m_r) \times a_{mi}$$

$$P_{mi} = F_{mi} \times \frac{(Vm_i + Vm_{i-1})}{3,6 \times 2} \times 0,001$$

$$a_i = \frac{(V_i - V_{i-1})}{3,6 \times (t_i - t_{i-1})}$$

$$a_{mi} = \frac{(Vm_i - Vm_{i-1})}{3,6 \times (t_i - t_{i-1})}$$

where:

- F_i is the target driving force during the period from (i - 1) to (i), N;
- F_{mi} is the actual/measured driving force during the period from (i - 1) to (i), N;
- P_i is the target power during the period from (i - 1) to (i), kW;
- P_{mi} is the actual/measured power during the period from (i - 1) to (i), kW;
- f_0, f_1, f_2 are the road load coefficients from Sub-Annex 4, N, N/(km/h), N/(km/h)²;
- V_i is the target speed at time (i); km/h;
- Vm_i is the actual/measured speed at time (i); km/h;

▼ **M3**

TM	is the test mass of the vehicle, kg;
m_r	is the equivalent effective mass of rotating components in accordance with paragraph 2.5.1. of Sub-Annex 4, kg;
a_i	is the target acceleration during the period from (i-1) to (i), m/s^2 ;
a_{mi}	is the actual/measured acceleration during the period from (i - 1) to (i), m/s^2 ;
t_i	is the time, s.

- 3.2. In the next step an initial $P_{\text{OVERRUN},1}$ is calculated using the following equation:

$$P_{\text{OVERRUN},1} = -0,02 \times P_{\text{RATED}}$$

where:

$P_{\text{OVERRUN},1}$	is the initial overrun power, kW;
P_{RATED}	is the rated vehicle power, kW.

- 3.3. All calculated P_i and P_{mi} values that are below $P_{\text{OVERRUN},1}$ shall be set to $P_{\text{OVERRUN},1}$ in order to exclude negative values not relevant for the CO₂ emissions.
- 3.4. The $P_{m,j}$ values shall be calculated for each individual phase of the WLTC using the following equation:

$$P_{m,j} = \sum_{t_0}^{t_{end}} P_{mi} / n$$

where:

$P_{m,j}$	is the average actual/measured power of the considered phase j, kW;
P_{mi}	is the actual/measured power during the period from (i - 1) to (i), kW;
t_0	is the time at the beginning of the considered phase j, s;
t_{end}	is the time at the end of the considered phase j, s;
n	is the number of time steps in the considered phase;
j	is the index number for the considered phase.

- 3.5. The average RCB corrected CO₂ mass emissions (g/km) for each phase of the applicable WLTC shall be expressed in units g/s using the following equation:

$$M_{CO_2,j} = M_{CO_2,RCB,j} \times \frac{d_{m,j}}{t_j}$$

where:

$M_{CO_2,j}$	is the average CO ₂ mass emission of phase j, g/s;
$M_{CO_2,RCB,j}$	is the CO ₂ mass emission from step 1 of Table A7/1 of Sub-Annex 7 for the considered WLTC phase j corrected in accordance with Appendix 2 to Sub-Annex 6, and with the requirement of applying the RCB correction without considering the correction criterion c;
$d_{m,j}$	is the actually driven distance of the considered phase j, km;
t_j	is the duration of considered phase j, s.

▼ **M3**

- 3.6. In the next step these CO₂ mass emissions (g/s) for each phase of the WLTC shall be correlated to the average $P_{m,j1}$ values calculated in accordance with paragraph 3.4. of this Sub-Annex 6b.

The best fit of the data shall be calculated using the least square regression method. An example for this regression line (Veline line) is shown in Figure A6b /1.

Figure A6b/1

Example of the Veline regression line

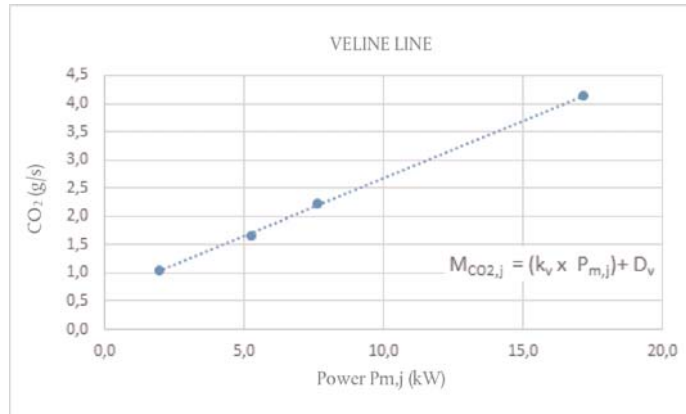

- 3.7. The vehicle specific Veline equation-1 calculated from paragraph 3.6. of this Sub-Annex 6b defines the correlation between CO₂ emissions in g/s for the considered phase j and the average measured power at the wheel for the same phase j and is expressed with the following equation:

$$M_{CO_2,j} = (k_{v,1} \times P_{m,j1}) + D_{v,1}$$

where:

$M_{CO_2,j}$ is the average CO₂ mass emission of phase j, g/s;

$P_{m,j1}$ is the average actual/measured power of the considered phase j calculated using $P_{OVERRUN,1}$, kW;

$k_{v,1}$ is the slope of the Veline equation-1, g CO₂/kWs;

$D_{v,1}$ is the constant of the Veline equation-1, g CO₂/s.

- 3.8. In the next step, a second $P_{OVERRUN,2}$ is calculated following the equation:

$$P_{OVERRUN,2} = - D_{v,1} / k_{v,1}$$

where:

$P_{OVERRUN,2}$ is the second overrun power, kW;

$k_{v,1}$ is the slope of the Veline equation-1, g CO₂/kWs;

$D_{v,1}$ is the constant of the Veline equation-1, g CO₂/s.

- 3.9. All calculated P_i and P_{mi} values from paragraph 3.1. of this Sub-Annex 6b that are below $P_{OVERRUN,2}$ shall be set to $P_{OVERRUN,2}$ in order to exclude negative values not relevant for the CO₂ emissions.

- 3.10. The $P_{m,j2}$ values shall be computed again for each individual phase of the WLTC using the equations from paragraph 3.4. of this Sub-Annex 6b.

▼ **M3**

- 3.11. New vehicle specific Veline equation-2 shall be computed using the least square regression method described in paragraph 3.6. of this Sub-Annex 6b. The Veline equation-2 is expressed with the following equation:

$$M_{CO_2,j} = (k_{v,2} \times P_{m,j2}) + D_{v,2}$$

where:

- $M_{CO_2,j}$ is the average CO₂ mass emission of phase j, g/s;
- $P_{m,j2}$ is the average actual/measured power of the considered phase j calculated using $P_{OVERRUN,2}$, kW;
- $k_{v,2}$ is the slope of the Veline equation-2, g CO₂/kW;
- $D_{v,2}$ is the constant of the Veline equation-2, g CO₂/s.

- 3.12. In the next step, the $P_{i,j}$ values coming from the target speed profile shall be calculated for each individual phase of the WLTC using the following equation:

$$P_{i,j2} = \sum_{t_0}^{t_{end}} P_{i,2} / n$$

where:

- $P_{i,j2}$ is the average target power of the considered phase j calculated using $P_{OVERRUN,2}$, kW;
- $P_{i,2}$ is the target power during the period from (i – 1) to (i) calculated using $P_{OVERRUN,2}$, kW;
- t_0 is the time at the beginning of the considered phase j, s;
- t_{end} is the time at the end of the considered phase j, s;
- n is the number of time steps in the considered phase;
- j is the index number for the considered WLTC phase.

- 3.13. Delta in CO₂ mass emissions of period j expressed in g/s is then calculated following the equation:

$$\Delta CO_{2,j} = k_{v,2} \times (P_{i,j2} - P_{m,j2})$$

where:

- $\Delta CO_{2,j}$ is the delta in CO₂ mass emissions of period j expressed, g/s;
- $k_{v,2}$ is the slope of the Veline equation-2, g CO₂/kW;
- $P_{i,j2}$ is the average target power of the considered period j calculated using $P_{OVERRUN,2}$, kW;
- $P_{m,j2}$ is the average actual/measured power of the considered period j calculated using $P_{OVERRUN,2}$, kW;
- j is the considered period j and it can be the cycle phase or the total cycle.

- 3.14. The final distance and speed corrected CO₂ mass emissions of period j is calculated following the equation:

$$M_{CO_2,j,2b} = \left(\Delta CO_{2,j} + M_{CO_2,j,1} \times \frac{d_{mj}}{t_j} \right) \times t_j / d_{i,j}$$

where:

- $M_{CO_2,j,2b}$ is distance and speed corrected CO₂ mass emissions of period j, g/km;
- $M_{CO_2,j,1}$ is CO₂ mass emissions of period j of step 1, see Table A7/1 in Sub-Annex 7, g/km;

▼ M3

$\Delta\text{CO}_{2,j}$	is the delta in CO ₂ mass emissions of period j expressed, g/s;
t_j	is the duration of considered period j, s;
$d_{m,j}$	is the actually driven distance of the considered phase j, km;
$d_{i,j}$	is the target distance of the considered period j, km;
j	is the considered period j, which can either be the cycle phase or the total cycle.

▼ B*Sub-Annex 7***Calculations**

1. General requirements
 - 1.1. Calculations related specifically to hybrid, pure electric and compressed hydrogen fuel cell vehicles are described in Sub-Annex 8.

▼ M3

A stepwise procedure for calculating test results is described in paragraph 4. of Sub-Annex 8.

▼ B

- 1.2. The calculations described in this Sub-Annex shall be used for vehicles using combustion engines.
- 1.3. Rounding of test results
 - 1.3.1. Intermediate steps in the calculations shall not be rounded.
 - 1.3.2. The final criteria emission results shall be rounded in one step to the number of places to the right of the decimal point indicated by the applicable emission standard plus one additional significant figure.
 - 1.3.3. The NO_x correction factor, KH, shall be rounded to two decimal places.
 - 1.3.4. The dilution factor, DF, shall be rounded to two decimal places.
 - 1.3.5. For information not related to standards, good engineering judgement shall be used.
 - 1.3.6. Rounding of CO₂ and fuel consumption results is described in paragraph 1.4. of this Sub-Annex.
- 1.4. ► **M3** Stepwise procedure for calculating the final test results for vehicles using combustion engines ◀

The results shall be calculated in the order described in Table A7/1. All applicable results in the column 'Output' shall be recorded. The column 'Process' describes the paragraphs to be used for calculation or contains additional calculations.

For the purpose of this table, the following nomenclature within the equations and results is used:

- c complete applicable cycle;
- p every applicable cycle phase;
- i every applicable criteria emission component, without CO₂;

CO₂ CO₂ emission.

▼ M3

Table A7/1

Procedure for calculating final test results

Source	Input	Process	Output	Step No.
Sub-Annex 6	Raw test results	Mass emissions Paragraphs 3. to 3.2.2. of this Sub-Annex.	$M_{i,p,1}$, g/km; $M_{CO_2,p,1}$, g/km.	1
Output step 1	$M_{i,p,1}$, g/km; $M_{CO_2,p,1}$, g/km.	Calculation of combined cycle values: $M_{i,c,2} = \frac{\sum_p M_{i,p,1} \times d_p}{\sum_p d_p}$ $M_{CO_2,c,2} = \frac{\sum_p M_{CO_2,p,1} \times d_p}{\sum_p d_p}$ where: $M_{i/CO_2,c,2}$ are the emission results over the total cycle; d_p are the driven distances of the cycle phases, p.	$M_{i,c,2}$, g/km; $M_{CO_2,c,2}$, g/km.	2
Output step 1 and 2	$M_{CO_2,p,1}$, g/km; $M_{CO_2,c,2}$, g/km.	Correction of CO ₂ results against the target speed and distance. Sub-Annex 6b. Note: As the distance is also corrected, from this calculation step onwards any reference to a driven distance shall be interpreted as a reference to the target distance.	$M_{CO_2,p,2b}$, g/km; $M_{CO_2,c,2b}$, g/km.	2b
Output step 2b	$M_{CO_2,p,2b}$, g/km; $M_{CO_2,c,2b}$, g/km.	RCB correction Appendix 2 to Sub-Annex 6.	$M_{CO_2,p,3}$, g/km; $M_{CO_2,c,3}$, g/km.	3
Output step 2 and 3	$M_{i,c,2}$, g/km; $M_{CO_2,c,3}$, g/km.	Emissions test procedure for all vehicles equipped with periodically regenerating systems, K_i . Sub-Annex 6, Appendix 1. $M_{i,c,4} = K_i \times M_{i,c,2}$ or $M_{i,c,4} = K_i + M_{i,c,2}$ and $M_{CO_2,c,4} = K_{CO_2} \times M_{CO_2,c,3}$ or $M_{CO_2,c,4} = K_{CO_2} + M_{CO_2,c,3}$ Additive offset or multiplicative factor to be used in accordance with K_i determination.	$M_{i,c,4}$, g/km; $M_{CO_2,c,4}$, g/km.	4a

▼ M3

Source	Input	Process	Output	Step No.
		If K_i is not applicable: $M_{i,c,4} = M_{i,c,2}$ $M_{CO_2,c,4} = M_{CO_2,c,3}$		
Output step 3 and 4a	$M_{CO_2,p,3}$, g/km; $M_{CO_2,c,3}$, g/km; $M_{CO_2,c,4}$, g/km.	If K_i is applicable, align CO_2 phase values to the combined cycle value: $M_{CO_2,p,4} = M_{CO_2,p,3} \times AF_{K_i}$ for every cycle phase p; where: $AF_{K_i} = \frac{M_{CO_2,c,4}}{M_{CO_2,c,3}}$ If K_i is not applicable: $M_{CO_2,p,4} = M_{CO_2,p,3}$	$M_{CO_2,p,4}$, g/km.	4b
Output step 4	$M_{i,c,4}$, g/km; $M_{CO_2,c,4}$, g/km; $M_{CO_2,p,4}$, g/km.	ATCT correction in accordance with paragraph 3.8.2. of Sub-Annex 6a. Deterioration factors calculated in accordance with Annex VII and applied to the criteria emissions values.	$M_{i,c,5}$, g/km; $M_{CO_2,c,5}$, g/km; $M_{CO_2,p,5}$, g/km.	5 Result of a single test.
Output step 5	For every test: $M_{i,c,5}$, g/km; $M_{CO_2,c,5}$, g/km; $M_{CO_2,p,5}$, g/km.	Averaging of tests and declared value. Paragraphs 1.2. to 1.2.3. of Sub-Annex 6.	$M_{i,c,6}$, g/km; $M_{CO_2,c,6}$, g/km; $M_{CO_2,p,6}$, g/km. $M_{CO_2,c,declared}$, g/km.	6
Output step 6	$M_{CO_2,c,6}$, g/km; $M_{CO_2,p,6}$, g/km. $M_{CO_2,c,declared}$, g/km.	Alignment of phase values. Paragraph 1.2.4. of Sub-Annex 6. and: $M_{CO_2,c,7} = M_{CO_2,c,declared}$	$M_{CO_2,c,7}$, g/km; $M_{CO_2,p,7}$, g/km.	7
Output steps 6 and 7	$M_{i,c,6}$, g/km; $M_{CO_2,c,7}$, g/km; $M_{CO_2,p,7}$, g/km.	Calculation of fuel consumption. Paragraph 6 of this Sub-Annex. The calculation of fuel consumption shall be performed for the applicable cycle and its phases separately. For that purpose: (a) the applicable phase or cycle CO_2 values shall be used; (b) the criteria emission over the complete cycle shall be used. and: $M_{i,c,8} = M_{i,c,6}$ $M_{CO_2,c,8} = M_{CO_2,c,7}$ $M_{CO_2,p,8} = M_{CO_2,p,7}$	$FC_{c,8}$, l/100 km; $FC_{p,8}$, l/100 km; $M_{i,c,8}$, g/km; $M_{CO_2,c,8}$, g/km; $M_{CO_2,p,8}$, g/km.	8 Result of a Type 1 test for a test vehicle.

▼ M3

Source	Input	Process	Output	Step No.
Step 8	For each of the test vehicles H and L: $M_{i,c,8}$, g/km; $M_{CO_2,c,8}$, g/km; $M_{CO_2,p,8}$, g/km; $FC_{c,8}$, l/100 km; $FC_{p,8}$, l/100 km.	If a test vehicle L was tested in addition to a test vehicle H, the resulting criteria emission value shall be the highest of the two values and referred to as $M_{i,c}$. In the case of the combined THC + NO _x emissions, the highest value of the sum referring to either the VH or VL is to be used. Otherwise, if no vehicle L was tested, $M_{i,c} = M_{i,c,8}$ For CO ₂ and FC, the values derived in step 8 shall be used, and CO ₂ values shall be rounded to two decimal places, and FC values shall be rounded to three decimal places.	$M_{i,c}$, g/km; $M_{CO_2,c,H}$, g/km; $M_{CO_2,p,H}$, g/km; $FC_{c,H}$, l/100 km; $FC_{p,H}$, l/100 km; and if a vehicle L was tested: $M_{CO_2,c,L}$, g/km; $M_{CO_2,p,L}$, g/km; $FC_{c,L}$, l/100 km; $FC_{p,L}$, l/100 km.	9 Interpolation family result. Final criteria emission result.
Step 9	$M_{CO_2,c,H}$, g/km; $M_{CO_2,p,H}$, g/km; $FC_{c,H}$, l/100 km; $FC_{p,H}$, l/100 km; and if a vehicle L was tested: $M_{CO_2,c,L}$, g/km; $M_{CO_2,p,L}$, g/km; $FC_{c,L}$, l/100 km; $FC_{p,L}$, l/100 km.	Fuel consumption and CO ₂ calculations for individual vehicles in an interpolation family. Paragraph 3.2.3. of this Sub-Annex. CO ₂ emissions shall be expressed in grams per kilometre (g/km) rounded to the nearest whole number; FC values shall be rounded to one decimal place, expressed in (l/100 km).	$M_{CO_2,c,ind}$ g/km; $M_{CO_2,p,ind}$ g/km; $FC_{c,ind}$ l/100 km; $FC_{p,ind}$, l/100 km.	10 Result of an individual vehicle. Final CO ₂ and FC result.

▼ B

2. Determination of diluted exhaust gas volume
 - 2.1. Volume calculation for a variable dilution device capable of operating at a constant or variable flow rate

▼ M3

The volumetric flow shall be measured continuously. The total volume shall be measured for the duration of the test.

▼ B

- 2.2. Volume calculation for a variable dilution device using a positive displacement pump
 - 2.2.1. The volume shall be calculated using the following equation:

$$V = V_0 \times N$$

where:

V is the volume of the diluted gas, in litres per test (prior to correction);

▼ B

V_0 is the volume of gas delivered by the positive displacement pump in testing conditions, litres per pump revolution;

N is the number of revolutions per test.

2.2.1.1. Correcting the volume to standard conditions

The diluted exhaust gas volume, V , shall be corrected to standard conditions according to the following equation:

$$V_{\text{mix}} = V \times K_1 \times \left(\frac{P_B - P_1}{T_p} \right)$$

where:

$$K_1 = \frac{273,15(\text{K})}{101,325(\text{kPa})} = 2,6961$$

P_B is the test room barometric pressure, kPa;

P_1 is the vacuum at the inlet of the positive displacement pump relative to the ambient barometric pressure, kPa;

T_p is the arithmetic average temperature of the diluted exhaust gas entering the positive displacement pump during the test, Kelvin (K).

3. Mass emissions

3.1. General requirements

3.1.1. Assuming no compressibility effects, all gases involved in the engine's intake, combustion and exhaust processes may be considered to be ideal according to Avogadro's hypothesis.

3.1.2. The mass, M of gaseous compounds emitted by the vehicle during the test shall be determined by the product of the volumetric concentration of the gas in question and the volume of the diluted exhaust gas with due regard for the following densities under the reference conditions of 273,15 K (0 °C) and 101,325 kPa:

Carbon monoxide (CO) $\rho = 1,25\text{g/l}$

Carbon dioxide (CO₂) $\rho = 1,964\text{g/l}$

Hydrocarbons:

for petrol (E10) (C₁H_{1,93}O_{0,033}) $\rho = 0,646\text{g/l}$

for diesel (B7) (C₁H_{1,86}O_{0,007}) $\rho = 0,625\text{g/l}$

for LPG (C₁H_{2,525}) $\rho = 0,649\text{g/l}$

for NG/biomethane (CH₄) $\rho = 0,716\text{g/l}$

for ethanol (E85) (C₁H_{2,74}O_{0,385}) $\rho = 0,934\text{g/l}$

Nitrogen oxides (NO_x) $\rho = 2,05\text{g/l}$

▼ B

The density for NMHC mass calculations shall be equal to that of total hydrocarbons at 273,15 K (0 °C) and 101,325 kPa, and is fuel-dependent. The density for propane mass calculations (see paragraph 3.5. in Sub-Annex 5) is 1,967 g/l at standard conditions.

If a fuel type is not listed in this paragraph, the density of that fuel shall be calculated using the equation given in paragraph 3.1.3. of this Sub-Annex.

- 3.1.3. The general equation for the calculation of total hydrocarbon density for each reference fuel with an mean composition of $C_XH_YO_Z$ is as follows:

$$\rho_{\text{THC}} = \frac{MW_C + \frac{H}{C} \times MW_H + \frac{O}{C} \times MW_O}{V_M}$$

where:

ρ_{THC} is the density of total hydrocarbons and non-methane hydrocarbons, g/l;

MW_C is the molar mass of carbon (12,011 g/mol);

MW_H is the molar mass of hydrogen (1,008 g/mol);

MW_O is the molar mass of oxygen (15,999 g/mol);

V_M is the molar volume of an ideal gas at 273,15 K (0°C) and 101,325 kPa (22,413 l/mol);

H/C is the hydrogen to carbon ratio for a specific fuel $C_XH_YO_Z$;

O/C is the oxygen to carbon ratio for a specific fuel $C_XH_YO_Z$.

- 3.2. Mass emissions calculation

- 3.2.1. Mass emissions of gaseous compounds per cycle phase shall be calculated using the following equations:

$$M_{i,\text{phase}} = \frac{V_{\text{mix,phase}} \times \rho_i \times KH_{\text{phase}} \times C_{i,\text{phase}} \times 10^{-6}}{d_{\text{phase}}}$$

where:

M_i is the mass emission of compound i per test or phase, g/km;

V_{mix} is the volume of the diluted exhaust gas per test or phase expressed in litres per test/phase and corrected to standard conditions (273,15 K (0 °C) and 101,325 kPa);

ρ_i is the density of compound i in grams per litre at standard temperature and pressure (273,15 K (0 °C) and 101,325 kPa);

KH is a humidity correction factor applicable only to the mass emissions of oxides of nitrogen, NO_2 and NO_x , per test or phase;

▼ B

C_i is the concentration of compound i per test or phase in the diluted exhaust gas expressed in ppm and corrected by the amount of compound i contained in the dilution air;

d is the distance driven over the applicable WLTC, km;

n is the number of phases of the applicable WLTC.

3.2.1.1. The concentration of a gaseous compound in the diluted exhaust gas shall be corrected by the amount of the gaseous compound in the dilution air using the following equation:

$$C_i = C_e - C_d \times \left(1 - \frac{1}{DF}\right)$$

where:

C_i is the concentration of gaseous compound i in the diluted exhaust gas corrected by the amount of gaseous compound i contained in the dilution air, ppm;

C_e is the measured concentration of gaseous compound i in the diluted exhaust gas, ppm;

C_d is the concentration of gaseous compound i in the dilution air, ppm;

DF is the dilution factor.

3.2.1.1.1. The dilution factor DF shall be calculated using the equation for the concerned fuel:

$$DF = \frac{13.4}{C_{CO_2} + (C_{HC} + C_{CO}) \times 10^{-4}} \quad \text{for petrol (E10)}$$

$$DF = \frac{13.5}{C_{CO_2} + (C_{HC} + C_{CO}) \times 10^{-4}} \quad \text{for diesel (B7)}$$

$$DF = \frac{11.9}{C_{CO_2} + (C_{HC} + C_{CO}) \times 10^{-4}} \quad \text{for LPG}$$

$$DF = \frac{9.5}{C_{CO_2} + (C_{HC} + C_{CO}) \times 10^{-4}} \quad \text{for NG/biomethane}$$

$$DF = \frac{12.5}{C_{CO_2} + (C_{HC} + C_{CO}) \times 10^{-4}} \quad \text{for ethanol (E85)}$$

$$DF = \frac{35.03}{C_{H_2O} - C_{H_2O-DA} + C_{H_2} \times 10^{-4}} \quad \text{for hydrogen}$$

With respect to the equation for hydrogen:

C_{H_2O} is the concentration of H_2O in the diluted exhaust gas contained in the sample bag, per cent volume;

C_{H_2O-DA} is the concentration of H_2O in the dilution air, per cent volume;

C_{H_2} is the concentration of H_2 in the diluted exhaust gas contained in the sample bag, ppm.

If a fuel type is not listed in this paragraph, the DF for that fuel shall be calculated using the equations in paragraph 3.2.1.1.2. of this Sub-Annex.

▼ B

If the manufacturer uses a DF that covers several phases, it shall calculate a DF using the mean concentration of gaseous compounds for the phases concerned.

The mean concentration of a gaseous compound shall be calculated using the following equation:

$$\bar{C}_i = \frac{\sum_{\text{phase}=1}^n (C_{i,\text{phase}} \times V_{\text{mix,phase}})}{\sum_{\text{phase}=1}^n V_{\text{mix,phase}}}$$

where:

C_i is mean concentration of a gaseous compound;

$C_{i,\text{phase}}$ is the concentration of each phase;

$V_{\text{mix,phase}}$ is the V_{mix} of the corresponding phase;

3.2.1.1.2. The general equation for calculating the dilution factor DF for each reference fuel with an arithmetic average composition of $C_xH_yO_z$ is as follows:

$$DF = \frac{X}{C_{CO_2} + (C_{HC} + C_{CO}) \times 10^{-4}}$$

where:

$$X = 100 \times \frac{x}{x + \frac{y}{2} + 3,76(x + \frac{y}{4} - \frac{z}{2})}$$

C_{CO_2} is the concentration of CO_2 in the diluted exhaust gas contained in the sample bag, per cent volume;

C_{HC} is the concentration of HC in the diluted exhaust gas contained in the sample bag, ppm carbon equivalent;

C_{CO} is the concentration of CO in the diluted exhaust gas contained in the sample bag, ppm.

3.2.1.1.3. Methane measurement

3.2.1.1.3.1. For methane measurement using a GC-FID, NMHC shall be calculated using the following equation:

$$C_{NMHC} = C_{THC} - (Rf_{CH_4} \times C_{CH_4})$$

where:

C_{NMHC} is the corrected concentration of NMHC in the diluted exhaust gas, ppm carbon equivalent;

C_{THC} is the concentration of THC in the diluted exhaust gas, ppm carbon equivalent and corrected by the amount of THC contained in the dilution air;

C_{CH_4} is the concentration of C_{CH_4} in the diluted exhaust gas, ppm carbon equivalent and corrected by the amount of CH_4 contained in the dilution air;

▼ M3

R_{fCH_4} is the FID response factor to methane determined and specified in paragraph 5.4.3.2. of Sub-Annex 5.

- 3.2.1.1.3.2. For methane measurement using an NMC-FID, the calculation of NMHC depends on the calibration gas/method used for the zero/calibration adjustment.

The FID used for the THC measurement (without NMC) shall be calibrated with propane/air in the normal manner.

For the calibration of the FID in series with an NMC, the following methods are permitted:

- (a) The calibration gas consisting of propane/air bypasses the NMC;
- (b) The calibration gas consisting of methane/air passes through the NMC.

It is highly recommended to calibrate the methane FID with methane/air through the NMC.

In case (a), the concentration of CH_4 and NMHC shall be calculated using the following equations:

$$C_{CH_4} = \frac{C_{HC(w/NMC)} - C_{HC(w/oNMC)} \times (1 - E_E)}{R_{fCH_4} \times (E_E - E_M)}$$

$$C_{NMHC} = \frac{C_{HC(w/oNMC)} \times (1 - E_M) - C_{HC(w/NMC)}}{E_E - E_M}$$

If $R_{fCH_4} < 1,05$, it may be omitted from the equation above for C_{CH_4} .

In case (b), the concentration of CH_4 and NMHC shall be calculated using the following equations:

$$C_{CH_4} = \frac{C_{HC(w/NMC)} \times R_{fCH_4} \times (1 - E_M) - C_{HC(w/oNMC)} \times (1 - E_E)}{R_{fCH_4} \times (E_E - E_M)}$$

$$C_{NMHC} = \frac{C_{HC(w/oNMC)} \times (1 - E_M) - C_{HC(w/NMC)} \times R_{fCH_4} \times (1 - E_M)}{E_E - E_M}$$

where:

$C_{HC(w/NMC)}$ is the HC concentration with sample gas flowing through the NMC, ppm C;

$C_{HC(w/oNMC)}$ is the HC concentration with sample gas bypassing the NMC, ppm C;

R_{fCH_4} is the methane response factor as determined per paragraph 5.4.3.2. of Sub-Annex 5;

E_M is the methane efficiency as determined per paragraph 3.2.1.1.3.3.1. of this Sub-Annex;

▼ M3

E_E is the ethane efficiency as determined per paragraph 3.2.1.1.3.3.2. of this Sub-Annex.

If $R_{fCH_4} < 1,05$, it may be omitted in the equations for case (b) above for C_{CH_4} and C_{NMHC} .

▼ B

3.2.1.1.3.3. Conversion efficiencies of the non-methane cutter, NMC

The NMC is used for the removal of the non-methane hydrocarbons from the sample gas by oxidizing all hydrocarbons except methane. Ideally, the conversion for methane is 0 per cent, and for the other hydrocarbons represented by ethane is 100 per cent. For the accurate measurement of NMHC, the two efficiencies shall be determined and used for the calculation of the NMHC emission.

3.2.1.1.3.3.1. Methane conversion efficiency, E_M

The methane/air calibration gas shall be flowed to the FID through the NMC and bypassing the NMC and the two concentrations recorded. The efficiency shall be determined using the following equation:

$$E_M = 1 - \frac{C_{HC(w/NMC)}}{C_{HC(w/oNMC)}}$$

where:

$C_{HC(w/NMC)}$ is the HC concentration with CH_4 flowing through the NMC, ppm C;

$C_{HC(w/oNMC)}$ is the HC concentration with CH_4 bypassing the NMC, ppm C.

3.2.1.1.3.3.2. Ethane conversion efficiency, E_E

The ethane/air calibration gas shall be flowed to the FID through the NMC and bypassing the NMC and the two concentrations recorded. The efficiency shall be determined using the following equation:

$$E_E = 1 - \frac{C_{HC(w/NMC)}}{C_{HC(w/oNMC)}}$$

where:

$C_{HC(w/NMC)}$ is the HC concentration with C_2H_6 flowing through the NMC, ppm C;

$C_{HC(w/oNMC)}$ is the HC concentration with C_2H_6 bypassing the NMC, ppm C.

If the ethane conversion efficiency of the NMC is 0,98 or above, E_E shall be set to 1 for any subsequent calculation.

3.2.1.1.3.4. If the methane FID is calibrated through the cutter, E_M shall be 0.**▼ M3**

The equation to calculate C_{CH_4} in paragraph 3.2.1.1.3.2. (case (b)) in this Sub-Annex becomes:

▼ B

$$C_{CH4} = C_{HC(w/NMC)}$$

The equation to calculate C_{NMHC} in paragraph 3.2.1.1.3.2. (case (b)) in this Sub-Annex becomes:

$$C_{NMHC} = C_{HC(w/oNMC)} - C_{HC(w/NMC)} \times r_h$$

The density used for NMHC mass calculations shall be equal to that of total hydrocarbons at 273,15 K (0 °C) and 101,325 kPa and is fuel-dependent.

3.2.1.1.4. Flow-weighted arithmetic average concentration calculation

The following calculation method shall only be applied for CVS systems that are not equipped with a heat exchanger or for CVS systems with a heat exchanger that do not comply with paragraph 3.3.5.1. of Sub-Annex 5.

When the CVS flow rate, q_{vcvs} , over the test varies by more than ± 3 per cent of the arithmetic average flow rate, a flow-weighted arithmetic average shall be used for all continuous diluted measurements including PN:

$$C_e = \frac{\sum_{i=1}^n q_{vcvs}(i) \times \Delta t \times C(i)}{V}$$

where:

C_e is the flow-weighted arithmetic average concentration;

$q_{vcvs}(i)$ is the CVS flow rate at time $t = i \times \Delta t$, m^3/min ;

$C(i)$ is the concentration at time $t = i \times \Delta t$, ppm;

Δt sampling interval, s;

V total CVS volume, m^3 .

3.2.1.2. Calculation of the NO_x humidity correction factor

In order to correct the influence of humidity on the results of oxides of nitrogen, the following calculations apply:

$$KH = \frac{1}{1 - 0,0329 \times (H - 10,71)}$$

where:

$$H = \frac{6,211 \times R_a \times P_d}{P_B - P_d \times R_a \times 10^{-2}}$$

and:

H is the specific humidity, grams of water vapour per kilogram dry air;

▼ B

R_a is the relative humidity of the ambient air, per cent;

P_d is the saturation vapour pressure at ambient temperature, kPa;

P_B is the atmospheric pressure in the room, kPa.

The KH factor shall be calculated for each phase of the test cycle.

The ambient temperature and relative humidity shall be defined as the arithmetic average of the continuously measured values during each phase.

3.2.2. Determination of the HC mass emissions from compression-ignition engines

3.2.2.1. To calculate HC mass emission for compression-ignition engines, the arithmetic average HC concentration shall be calculated using the following equation:

$$C_e = \frac{\int_{t_1}^{t_2} C_{HC} dt}{t_2 - t_1}$$

where:

$\int_{t_1}^{t_2} C_{HC} dt$ is the integral of the recording of the heated FID over the test (t_1 to t_2);

C_e is the concentration of HC measured in the diluted exhaust in ppm of C_i and is substituted for C_{HC} in all relevant equations.

3.2.2.1.1. Dilution air concentration of HC shall be determined from the dilution air bags. Correction shall be carried out according to paragraph 3.2.1.1. of this Sub-Annex.

3.2.3. Fuel consumption and CO₂ calculations for individual vehicles in an interpolation family

▼ M3

3.2.3.1. Fuel consumption and CO₂ emissions without using the interpolation method (i.e. using vehicle H only)

The CO₂ value, as calculated in paragraphs 3.2.1. to 3.2.1.1.2. of this Sub-Annex, and fuel consumption, as calculated in accordance with paragraph 6. of this Sub-Annex, shall be attributed to all individual vehicles in the interpolation family and the interpolation method shall not be applicable.

▼ B

3.2.3.2. Fuel consumption and CO₂ emissions using the interpolation method

The CO₂ emissions and the fuel consumption for each individual vehicle in the interpolation family may be calculated according to the interpolation method outlined in paragraphs 3.2.3.2.1. to 3.2.3.2.5. inclusive of this Sub-Annex.

3.2.3.2.1. Fuel consumption and CO₂ emissions of test vehicles L and H

The mass of CO₂ emissions, M_{CO_2-L} , and M_{CO_2-H} and its phases p, $M_{CO_2-L,p}$ and $M_{CO_2-H,p}$, of test vehicles L and H, used for the following calculations, shall be taken from step 9 of Table A7/1.

▼ B

Fuel consumption values are also taken from step 9 of Table A7/1 and are referred to as $FC_{L,p}$ and $FC_{H,p}$.

▼ M3

3.2.3.2.2. Road load calculation for an individual vehicle

In the case that the interpolation family is derived from one or more road load families, the calculation of the individual road load shall only be performed within the road load family applicable to that individual vehicle.

▼ B

3.2.3.2.2.1. Mass of an individual vehicle

The test masses of vehicles H and L shall be used as input for the interpolation method.

TM_{ind} , in kg, shall be the individual test mass of the vehicle according to paragraph 3.2.25. of this Annex.

If the same test mass is used for test vehicles L and H, the value of TM_{ind} shall be set to the mass of test vehicle H for the interpolation method.

▼ M3

3.2.3.2.2.2. Rolling resistance of an individual vehicle

3.2.3.2.2.2.1. The actual RRC values for the selected tyres on test vehicle L, RR_L , and test vehicle H, RR_H , shall be used as input for the interpolation method. See paragraph 4.2.2.1. of Sub-Annex 4.

If the tyres on the front and rear axles of vehicle L or H have different RRC values, the weighted mean of the rolling resistances shall be calculated using the equation in paragraph 3.2.3.2.2.2.3. of this Sub-Annex.

3.2.3.2.2.2.2. For the tyres fitted to an individual vehicle, the value of the rolling resistance coefficient RR_{ind} shall be set to the RRC value of the applicable tyre energy efficiency class in accordance with Table A4/2 of Sub-Annex 4.

In the case where individual vehicles may be supplied with a complete set of standard wheels and tyres and a complete set of snow tyres (marked with 3 Peaked Mountain and Snowflake – 3PMS) with or without wheels, the additional wheels/tyres shall not be considered as optional equipment.

If the tyres on the front and rear axles belong to different energy efficiency classes, the weighted mean shall be used and calculated using the equation in paragraph 3.2.3.2.2.2.3. of this Sub-Annex.

If the same tyres, or tyres with the same rolling resistance coefficient were fitted to test vehicles L and H, the value of RR_{ind} for the interpolation method shall be set to RR_H .

3.2.3.2.2.2.3. Calculating the weighted mean of the rolling resistances

$$RR_x = (RR_{x,FA} \times mp_{x,FA}) + (RR_{x,RA} \times (1 - mp_{x,FA}))$$

▼ **M3**

where:

x	represents vehicle L, H or an individual vehicle.
$RR_{L,FA}$ and $RR_{H,FA}$	are the actual RRCs of the front axle tyres on vehicles L and H respectively, kg/tonne;
$RR_{ind,FA}$	is the RRC value of the applicable tyre energy efficiency class in accordance with Table A4/2 of Sub-Annex 4 of the front axle tyres on the individual vehicle, kg/tonne;
$RR_{L,RA}$, and $RR_{H,RA}$	are the actual RRCs of the rear axle tyres on vehicles L and H respectively, kg/tonne;
$RR_{ind,RA}$	is the RRC value of the applicable tyre energy efficiency class in accordance with Table A4/2 of Sub-Annex 4 of the rear axle tyres on the individual vehicle, kg/tonne;
$mp_{x,FA}$	is the proportion of the vehicle mass in running order on the front axle;

RR_x shall not be rounded or categorised to tyre energy efficiency classes.

3.2.3.2.2.3. Aerodynamic drag of an individual vehicle

3.2.3.2.2.3.1. Determination of aerodynamic influence of optional equipment

The aerodynamic drag shall be measured for each of the aerodynamic drag-influencing items of optional equipment and body shapes in a wind tunnel fulfilling the requirements of paragraph 3.2. of Sub-Annex 4 verified by the approval authority.

3.2.3.2.2.3.2. Alternative method for determination of aerodynamic influence of optional equipment

At the request of the manufacturer and with approval of the approval authority, an alternative method (e.g. simulation, wind tunnel not fulfilling the criteria in Sub-Annex 4) may be used to determine $\Delta(C_D \times A_f)$ if the following criteria are fulfilled:

- (a) The alternative method shall fulfil an accuracy for $\Delta(C_D \times A_f)$ of $\pm 0,015 \text{ m}^2$ and, additionally, in the case that simulation is used, the Computational Fluid Dynamics method should be validated in detail such that the actual air flow patterns around the body, including magnitudes of flow velocities, forces, or pressures, are shown to match the validation test results;

▼ **M3**

- (b) The alternative method shall be used only for those aerodynamic-influencing parts (e.g. wheels, body shapes, cooling system) for which equivalency was demonstrated;
- (c) Evidence of equivalency shall be shown in advance to the approval authority for each road load family in the case that a mathematical method is used, or every four years in the case that a measurement method is used, and in any case shall be based on wind tunnel measurements fulfilling the criteria of this Annex;
- (d) If the $\Delta(C_D \times A_f)$ of a particular item of optional equipment is more than double the value of the optional equipment for which the evidence was given, aerodynamic drag shall not be determined by the alternative method; and
- (e) In the case that a simulation model is changed, a revalidation shall be necessary.

3.2.3.2.2.3.3. Application of aerodynamic influence on the individual vehicle

$\Delta(C_D \times A_f)_{\text{ind}}$ is the difference in the product of the aerodynamic drag coefficient multiplied by frontal area between an individual vehicle and test vehicle L due to options and body shapes on the vehicle that differ from those of test vehicle L, m^2 ;

These differences in aerodynamic drag, $\Delta(C_D \times A_f)$, shall be determined with an accuracy of $\pm 0,015 \text{ m}^2$.

$\Delta(C_D \times A_f)_{\text{ind}}$ may be calculated using the following equation maintaining the accuracy of $\pm 0,015 \text{ m}^2$ also for the sum of items of optional equipment and body shapes:

$$\Delta(C_D \times A_f)_{\text{ind}} = \sum_{i=1}^n \Delta(C_D \times A_f)_i$$

where:

C_D is the aerodynamic drag coefficient;

A_f is the frontal area of the vehicle, m^2 ;

n is the number of items of optional equipment on the vehicle that are different between an individual vehicle and test vehicle L;

$\Delta(C_D \times A_f)_i$ is the difference in the product of the aerodynamic drag coefficient multiplied by frontal area due to an individual feature, i , on the vehicle and is positive for an item of optional equipment that adds aerodynamic drag with respect to test vehicle L and vice versa, m^2 .

The sum of all $\Delta(C_D \times A_f)_i$ differences between test vehicles L and H shall correspond to $\Delta(C_D \times A_f)_{LH}$.

3.2.3.2.2.3.4. Definition of complete aerodynamic delta between test vehicles H and L

▼ M3

The total difference of the aerodynamic drag coefficient multiplied by frontal area between test vehicles L and H shall be referred to as $\Delta(C_D \times A_f)_{LH}$ and shall be included in all the relevant test reports, m^2 .

3.2.3.2.2.3.5. Documentation of aerodynamic influences

The increase or decrease of the product of the aerodynamic drag coefficient multiplied by frontal area expressed as $\Delta(C_D \times A_f)$ for all items of optional equipment and body shapes in the interpolation family that:

- (a) have an influence on the aerodynamic drag of the vehicle; and
- (b) are to be included in the interpolation,

shall be included in all relevant test reports, m^2 .

3.2.3.2.2.3.6. Additional provisions for aerodynamic influences

The aerodynamic drag of vehicle H shall be applied to the whole interpolation family and $\Delta(C_D \times A_f)_{LH}$ shall be set to zero, if:

- (a) the wind tunnel facility is not able to accurately determine $\Delta(C_D \times A_f)$; or
- (b) there are no drag-influencing items of optional equipment between the test vehicles H and L that are to be included in the interpolation method.

3.2.3.2.2.4. Calculation of road load coefficients for individual vehicles

The road load coefficients f_0 , f_1 and f_2 (as defined in Sub-Annex 4) for test vehicles H and L are referred to as $f_{0,H}$, $f_{1,H}$ and $f_{2,H}$, and $f_{0,L}$, $f_{1,L}$ and $f_{2,L}$ respectively. An adjusted road load curve for the test vehicle L is defined as follows:

$$F_L(v) = f_{0,L}^* + f_{1,H} \times v + f_{2,L}^* \times v^2$$

▼ B

Applying the least squares regression method in the range of the reference speed points, adjusted road load coefficients $f_{0,L}^*$ and $f_{2,L}^*$ shall be determined for $F_L(v)$ with the linear coefficient $f_{1,L}^*$ set to $f_{1,H}$. The road load coefficients $f_{0,ind}$, $f_{1,ind}$ and $f_{2,ind}$ for an individual vehicle in the interpolation family shall be calculated using the following equations:

$$f_{0,ind} = f_{0,H} - \Delta f_0 \times \frac{(TM_H \times RR_H - TM_{ind} \times RR_{ind})}{(TM_H \times RR_H - TM_L \times RR_L)}$$

or, if $(TM_H \times RR_H - TM_L \times RR_L) = 0$, the equation for $f_{0,ind}$ below shall apply:

$$f_{0,ind} = f_{0,H} - \Delta f_0$$

▼ B

$$f_{1,ind} = f_{1,H}$$

$$f_{2,ind} = f_{2,H} - \Delta f_2 \frac{(\Delta[C_d \times A_f]_{LH} - \Delta[C_d \times A_f]_{ind})}{(\Delta[C_d \times A_f]_{LH})}$$

or, if $\Delta(C_d \times A_f)_{LH} = 0$, the equation for $F_{2,ind}$ below shall apply:

$$f_{2,ind} = f_{2,H} - \Delta f_2$$

where:

$$\Delta f_0 = f_{0,H} - f_{0,L}^*$$

$$\Delta f_2 = f_{2,H} - f_{2,L}^*$$

In the case of a road load matrix family, the road load coefficients f_0 , f_1 and f_2 for an individual vehicle shall be calculated according to the equations in paragraph 5.1.1. of Sub-Annex 4.

3.2.3.2.3. Calculation of cycle energy demand

The cycle energy demand of the applicable WLTC, E_k , and the energy demand for all applicable cycle phases $E_{k,p}$, shall be calculated according to the procedure in paragraph 5. of this Sub-Annex, for the following sets, k , of road load coefficients and masses:

$$k=1: f_0 = f_{0,L}^*, f_1 = f_{1,H}, f_2 = f_{2,L}^*, m = TM_L$$

(test vehicle L)

$$k=2: f_0 = f_{0,H}, f_1 = f_{1,H}, f_2 = f_{2,H}, m = TM_H$$

(test vehicle H)

$$k=3: f_0 = f_{0,ind}, f_1 = f_{1,H}, f_2 = f_{2,ind}, m = TM_{ind}$$

(an individual vehicle in the interpolation family)

▼ M3

These three sets of road loads may be derived from different road load families.

▼ B

3.2.3.2.4. Calculation of the CO₂ value for an individual vehicle within an interpolation family using the interpolation method

For each cycle phase p of the applicable cycle the mass of CO₂ emissions g/km , for an individual vehicle shall be calculated using the following equation:

$$M_{CO_2-ind,p} = M_{CO_2-L,p} + \left(\frac{E_{3,p} - E_{1,p}}{E_{2,p} - E_{1,p}} \right) \times (M_{CO_2-H,p} - M_{CO_2-L,p})$$

The mass of CO₂ emissions, g/km , over the complete cycle for an individual vehicle shall be calculated using the following equation:

$$M_{CO_2-ind} = M_{CO_2-L} + \left(\frac{E_3 - E_1}{E_2 - E_1} \right) \times (M_{CO_2-H} - M_{CO_2-L})$$

▼ M3

The terms $E_{1,p}$, $E_{2,p}$ and $E_{3,p}$ and E_1 , E_2 and E_3 respectively shall be calculated as specified in paragraph 3.2.3.2.3. of this Sub-Annex.

▼B

- 3.2.3.2.5. Calculation of the fuel consumption FC value for an individual vehicle within an interpolation family using the interpolation method

For each cycle phase *p* of the applicable cycle, the fuel consumption, l/100 km, for an individual vehicle shall be calculated using the following equation:

$$FC_{ind,p} = FC_{L,p} + \left(\frac{E_{3,p} - E_{1,p}}{E_{2,p} - E_{1,p}} \right) \times (FC_{H,p} - FC_{L,p})$$

The fuel consumption, l/100 km, of the complete cycle for an individual vehicle shall be calculated using the following equation:

$$FC_{ind} = FC_L + \left(\frac{E_3 - E_1}{E_2 - E_1} \right) \times (FC_H - FC_L)$$

▼M3

The terms $E_{1,p}$, $E_{2,p}$ and $E_{3,p}$, and E_1 , E_2 and E_3 respectively shall be calculated as specified in paragraph 3.2.3.2.3. of this Sub-Annex.

- 3.2.3.2.6. The individual CO₂ value determined in accordance with paragraph 3.2.3.2.4. of this Sub-Annex may be increased by the OEM. In such cases:

- (a) The CO₂ phase values shall be increased by the ratio of the increased CO₂ value divided by the calculated CO₂ value;
- (b) The fuel consumption values shall be increased by the ratio of the increased CO₂ value divided by the calculated CO₂ value.

This shall not compensate for technical elements that would effectively require a vehicle to be excluded from the interpolation family.

▼B

- 3.2.4. Fuel consumption and CO₂ calculations for individual vehicles in a road load matrix family

The CO₂ emissions and the fuel consumption for each individual vehicle in the road load matrix family shall be calculated according to the interpolation method outlined in paragraphs 3.2.3.2.3. to 3.2.3.2.5. inclusive of this Sub-Annex. Where applicable, references to vehicle L and/or H shall be replaced by references to vehicle L_M and/or H_M respectively.

- 3.2.4.1. Determination of fuel consumption and CO₂ emissions of vehicles L_M and H_M

The mass of CO₂ emissions M_{CO_2} of vehicles L_M and H_M shall be determined according to the calculations in paragraph 3.2.1. of this Sub-Annex for the individual cycle phases *p* of the applicable WLTC and are referred to as $M_{CO_2-LM,p}$ and $M_{CO_2-HM,p}$ respectively. Fuel consumption for individual cycle phases of the applicable WLTC shall be determined according to paragraph 6. of this Sub-Annex and are referred to as $FC_{LM,p}$ and $FC_{HM,p}$ respectively.

▼ B

3.2.4.1.1. Road load calculation for an individual vehicle

The road load force shall be calculated according to the procedure described in paragraph 5.1. of Sub-Annex 4.

3.2.4.1.1.1. Mass of an individual vehicle

The test masses of vehicles H_M and L_M selected according to paragraph 4.2.1.4. of Sub-Annex 4 shall be used as input.

TM_{ind} , in kg, shall be the test mass of the individual vehicle according to the definition of test mass in paragraph 3.2.25. of this Annex.

If the same test mass is used for vehicles L_M and H_M , the value of TM_{ind} shall be set to the mass of vehicle H_M for the road load matrix family method.

▼ M3

3.2.4.1.1.2. Rolling resistance of an individual vehicle

3.2.4.1.1.2.1. The rolling resistance coefficient (RRC) values for vehicle L_M , RR_{L_M} , and vehicle H_M , RR_{H_M} , selected under paragraph 4.2.1.4. of Sub-Annex 4 shall be used as input.

If the tyres on the front and rear axles of vehicle L_M or H_M have different RRC values, the weighted mean of the rolling resistances shall be calculated using the equation in paragraph 3.2.4.1.1.2.3. of this Sub-Annex.

3.2.4.1.1.2.2. For the tyres fitted to an individual vehicle, the value of the rolling resistance coefficient RR_{ind} shall be set to the RRC value of the applicable tyre energy efficiency class in accordance with Table A4/2 of Sub-Annex 4.

In the case where individual vehicles may be supplied with a complete set of standard wheels and tyres and a complete set of snow tyres (marked with 3 Peaked Mountain and Snowflake – 3PMS) with or without wheels, the additional wheels/tyres shall not be considered as optional equipment.

If the tyres on the front and rear axles belong to different energy efficiency classes, the weighted mean shall be used, calculated with the equation in paragraph 3.2.4.1.1.2.3. of this Sub-Annex.

If the same rolling resistance is used for vehicles L_M and H_M , the value of RR_{ind} shall be set to RR_{H_M} for the road load matrix family method.

3.2.4.1.1.2.3. Calculating the weighed mean of the rolling resistances

$$RR_x = (RR_{x,FA} \times mp_{x,FA}) + (RR_{x,RA} \times (1 - mp_{x,FA}))$$

▼ M3

where:

x	represents vehicle L, H or an individual vehicle;
$RR_{LM,FA}$ and $RR_{HM,FA}$	are the actual RRCs of the front axle tyres on vehicles L and H respectively, kg/tonne;
$RR_{ind,FA}$	is the RRC value of the applicable tyre energy efficiency class in accordance with Table A4/2 of Sub-Annex 4 of the front axle tyres on the individual vehicle, kg/tonne;
$RR_{LM,RA}$, and $RR_{HM,RA}$	are the actual rolling resistance coefficients of the rear axle tyres on vehicles L and H respectively, kg/tonne;
$RR_{ind,RA}$	is the RRC value of the applicable tyre energy efficiency class in accordance with Table A4/2 of Sub-Annex 4 of the rear axle tyres on the individual vehicle, kg/tonne;
$mp_{x,FA}$	is the proportion of the vehicle mass in running order on the front axle.

RR_x shall not be rounded or categorised to tyre energy efficiency classes.

▼ B

3.2.4.1.1.3. Frontal area of an individual vehicle

The frontal area for vehicle L_M , A_{fLM} , and vehicle H_M , A_{fHM} , selected under paragraph 4.2.1.4. of Sub-Annex 4 shall be used as input.

$A_{f,ind}$, m^2 , shall be the frontal area of the individual vehicle.

If the same frontal area is used for vehicles L_M and H_M , the value of $A_{f,ind}$ shall be set to the frontal area of vehicle H_M for the road load matrix family method.

3.3. PM

3.3.1. Calculation

PM shall be calculated using the following two equations:

$$PM = \frac{(V_{mix} + V_{ep}) \times P_e}{V_{ep} \times d}$$

▼ B

where exhaust gases are vented outside tunnel;

and:

$$PM = \frac{V_{\text{mix}} \times P_e}{V_{\text{ep}} \times d}$$

where exhaust gases are returned to the tunnel;

where:

V_{mix} is the volume of diluted exhaust gases (see paragraph 2. of this Sub-Annex), under standard conditions;

V_{ep} is the volume of diluted exhaust gas flowing through the particulate sampling filter under standard conditions;

P_e is the mass of particulate matter collected by one or more sample filters, mg;

d is the distance driven corresponding to the test cycle, km.

3.3.1.1. Where correction for the background particulate mass from the dilution system has been used, this shall be determined in accordance with ► **M3** paragraph 2.1.3.1. of Sub-Annex 6 ◀. In this case, particulate mass (mg/km) shall be calculated using the following equations:

$$PM = \left\{ \frac{P_e}{V_{\text{ep}}} - \left[\frac{P_a}{V_{\text{ap}}} \times \left(1 - \frac{1}{DF} \right) \right] \right\} \times \frac{(V_{\text{mix}} + V_{\text{ep}})}{d}$$

in the case that the exhaust gases are vented outside the tunnel;

and:

$$PM = \left\{ \frac{P_e}{V_{\text{ep}}} - \left[\frac{P_a}{V_{\text{ap}}} \times \left(1 - \frac{1}{DF} \right) \right] \right\} \times \frac{V_{\text{mix}}}{d}$$

in the case that the exhaust gases are returned to the tunnel;

where:

V_{ap} is the volume of tunnel air flowing through the background particulate filter under standard conditions;

P_a is the particulate mass from the dilution air, or the dilution tunnel background air, as determined by the one of the methods described in ► **M3** paragraph 2.1.3.1. of Sub-Annex 6 ◀;

DF is the dilution factor determined in paragraph 3.2.1.1.1. of this Sub-Annex.

Where application of a background correction results in a negative result, it shall be considered to be zero mg/km.

▼ B

3.3.2. Calculation of PM using the double dilution method

$$V_{ep} = V_{set} - V_{ssd}$$

where:

V_{ep} is the volume of diluted exhaust gas flowing through the particulate sample filter under standard conditions;

V_{set} is the volume of the double diluted exhaust gas passing through the particulate sampling filters under standard conditions;

V_{ssd} is the volume of the secondary dilution air under standard conditions.

Where the secondary diluted sample gas for PM measurement is not returned to the tunnel, the CVS volume shall be calculated as in single dilution, i.e.:

$$V_{mix} = V_{mix\ indicated} + V_{ep}$$

where:

$V_{mix\ indicated}$ is the measured volume of diluted exhaust gas in the dilution system following extraction of the particulate sample under standard conditions.

▼ M3

4. Determination of PN

PN shall be calculated using the following equation:

$$PN = \frac{V \times k \times (\overline{C}_s \times \overline{f}_r - C_b \times \overline{f}_{rb}) \times 10^3}{d}$$

where:

PN is the particle number emission, particles per kilometre;

V is the volume of the diluted exhaust gas in litres per test (after primary dilution only in the case of double dilution) and corrected to standard conditions (273,15 K (0 °C) and 101,325 kPa);

k is a calibration factor to correct the PNC measurements to the level of the reference instrument where this is not applied internally within the PNC. Where the calibration factor is applied internally within the PNC, the calibration factor shall be 1;

\overline{C}_s is the corrected particle number concentration from the diluted exhaust gas expressed as the arithmetic average number of particles per cubic centimetre from the emissions test including the full duration of the drive cycle. If the volumetric mean concentration results \overline{C} from the PNC are not measured at standard conditions (273,15 K (0 °C) and 101,325 kPa), the concentrations shall be corrected to those conditions \overline{C}_s ;

▼ M3

C_b is either the dilution air or the dilution tunnel background particle number concentration, as permitted by the approval authority, in particles per cubic centimetre, corrected for coincidence and to standard conditions (273,15 K (0 °C) and 101,325 kPa);

\bar{f}_r is the mean particle concentration reduction factor of the VPR at the dilution setting used for the test;

\bar{f}_{rb} is the mean particle concentration reduction factor of the VPR at the dilution setting used for the background measurement;

d is the distance driven corresponding to the applicable test cycle, km.

\bar{C} shall be calculated using the following equation:

$$\bar{C} = \frac{\sum_{i=1}^n C_i}{n}$$

where:

C_i is a discrete measurement of particle number concentration in the diluted gas exhaust from the PNC; particles per cm^3 and corrected for coincidence;

n is the total number of discrete particle number concentration measurements made during the applicable test cycle and shall be calculated using the following equation:

$$n = t \times f$$

where:

t is the time duration of the applicable test cycle, s;

f is the data logging frequency of the particle counter, Hz.

▼ B

5. Calculation of cycle energy demand

Unless otherwise specified, the calculation shall be based on the target speed trace given in discrete time sample points.

For the calculation, each time sample point shall be interpreted as a time period. Unless otherwise specified, the duration Δt of these periods shall be 1 second.

The total energy demand E for the whole cycle or a specific cycle phase shall be calculated by summing E_i over the corresponding cycle time between t_{start} and t_{end} according to the following equation:

$$E = \sum_{t_{\text{start}}}^{t_{\text{end}}} E_i$$

▼ B

where:

$$E_i = F_i \times d_i \text{ if } F_i > 0$$

$$E_i = 0 \text{ if } F_i \leq 0$$

and:

t_{start} is the time at which the applicable test cycle or phase starts, s;

t_{end} is the time at which the applicable test cycle or phase ends, s;

E_i is the energy demand during time period (i-1) to (i), Ws;

F_i is the driving force during time period (i-1) to (i), N;

d_i is the distance travelled during time period (i-1) to (i), m.

$$F_i = f_0 + f_1 \times \left(\frac{v_i + v_{i-1}}{2} \right) + f_2 \times \frac{(v_i + v_{i-1})^2}{4} + (1.03 \times TM) \times a_i$$

where:

F_i is the driving force during time period (i-1) to (i), N;

▼ M3

v_i is the target velocity at time t_i , km/h;

▼ B

TM is the test mass, kg;

a_i is the acceleration during time period (i-1) to (i), m/s²;

f_0 , f_1 , f_2 are the road load coefficients for the test vehicle under consideration (TM_L , TM_H or TM_{ind}) in N, N/km/h and in N/(km/h)² respectively.

$$d_i = \frac{(v_i + v_{i-1})}{2 \times 3,6} \times (t_i - t_{i-1})$$

where:

d_i is the distance travelled in time period (i-1) to (i), m;

▼ M3

v_i is the target velocity at time t_i , km/h;

▼ B

t_i is time, s.

$$a_i = \frac{v_i - v_{i-1}}{3,6 \times (t_i - t_{i-1})}$$

where:

a_i is the acceleration during time period (i-1) to (i), m/s²;

▼ M3

v_i is the target velocity at time t_i , km/h;

▼ B

t_i is time, s.

▼B

6. Calculation of fuel consumption
- 6.1. The fuel characteristics required for the calculation of fuel consumption values shall be taken from Annex IX.
- 6.2. The fuel consumption values shall be calculated from the emissions of hydrocarbons, carbon monoxide, and carbon dioxide using the results of step 6 for criteria emissions and step 7 for CO₂ of Table A7/1.

▼M3

- 6.2.1. The general equation in paragraph 6.12. of this Sub-Annex using H/C and O/C ratios shall be used for the calculation of fuel consumption.

▼B

- 6.2.2. For all equations in paragraph 6. of this Sub-Annex:

FC is the fuel consumption of a specific fuel, 1/100 km (or m₃ per 100 km in the case of natural gas or kg/100 km in the case of hydrogen);

H/C is the hydrogen to carbon ratio of a specific fuel C_xH_yO_z;

O/C is the oxygen to carbon ratio of a specific fuel C_xH_yO_z;

MW_C is the molar mass of carbon (12,011 g/mol);

MW_H is the molar mass of hydrogen (1,008 g/mol);

MW_O is the molar mass of oxygen (15,999 g/mol);

ρ_{fuel} is the test fuel density, kg/l. For gaseous fuels, fuel density at 15 °C;

HC are the emissions of hydrocarbon, g/km;

CO are the emissions of carbon monoxide, g/km;

CO₂ are the emissions of carbon dioxide, g/km;

H₂O are the emissions of water, g/km;

H₂ are the emissions of hydrogen, g/km;

p₁ is the gas pressure in the fuel tank before the applicable test cycle, Pa;

p₂ is the gas pressure in the fuel tank after the applicable test cycle, Pa;

T₁ is the gas temperature in the fuel tank before the applicable test cycle, K;

T₂ is the gas temperature in the fuel tank after the applicable test cycle, K;

Z₁ is the compressibility factor of the gaseous fuel at p₁ and T₁;

▼ B

Z_2 is the compressibility factor of the gaseous fuel at p_2 and T_2 ;

V is the interior volume of the gaseous fuel tank, m^3 ;

d is the theoretical length of the applicable phase or cycle, km.

6.3. Reserved

6.4. Reserved

6.5. For a vehicle with a positive ignition engine fuelled with petrol (E10)

$$FC = \left(\frac{0,1206}{\rho_{\text{fuel}}} \right) \times [(0,829 \times \text{HC}) + (0,429 \times \text{CO}) + (0,273 \times \text{CO}_2)]$$

6.6. For a vehicle with a positive ignition engine fuelled with LPG

$$FC_{\text{norm}} = \left(\frac{0,1212}{0,538} \right) \times [(0,825 \times \text{HC}) + (0,429 \times \text{CO}) + (0,273 \times \text{CO}_2)]$$

6.6.1. If the composition of the fuel used for the test differs from the composition that is assumed for the calculation of the normalised consumption, on the manufacturer's request a correction factor cf may be applied, using the following equation:

$$FC_{\text{norm}} = \left(\frac{0,1212}{0,538} \right) \times cf \times [(0,825 \times \text{HC}) + (0,429 \times \text{CO}) + (0,273 \times \text{CO}_2)]$$

The correction factor, cf , which may be applied, is determined using the following equation:

$$cf = 0,825 + 0,0693 \times n_{\text{actual}}$$

where:

n_{actual} is the actual H/C ratio of the fuel used.

6.7. For a vehicle with a positive ignition engine fuelled with NG/biomethane

$$FC_{\text{norm}} = \left(\frac{0,1336}{0,654} \right) \times [(0,749 \times \text{HC}) + (0,429 \times \text{CO}) + (0,273 \times \text{CO}_2)]$$

6.8. Reserved

6.9. Reserved

6.10. For a vehicle with a compression engine fuelled with diesel (B7)

$$FC = \left(\frac{0,1165}{\rho_{\text{fuel}}} \right) \times [(0,858 \times \text{HC}) + (0,429 \times \text{CO}) + (0,273 \times \text{CO}_2)]$$

▼B

- 6.11. For a vehicle with a positive ignition engine fuelled with ethanol (E85)

$$FC = \left(\frac{0,1743}{\rho_{\text{fuel}}} \right) \times [(0,574 \times \text{HC}) + (0,429 \times \text{CO}) + (0,273 \times \text{CO}_2)]$$

- 6.12. Fuel consumption for any test fuel may be calculated using the following equation:

$$FC = \frac{MW_C + \frac{H}{C} \times MW_H + \frac{O}{C} \times MW_O}{MW_C \times \rho_{\text{fuel}} \times 10} \times \left(\frac{MW_C}{MW_C + \frac{H}{C} \times MW_H + \frac{O}{C} \times MW_O} \times \text{HC} + \frac{MW_C}{MW_{\text{CO}}} \times \text{CO} + \frac{MW_C}{MW_{\text{CO}_2}} \times \text{CO}_2 \right)$$

- 6.13. Fuel consumption for a vehicle with a positive ignition engine fuelled by hydrogen:

$$FC = 0,024 \times \frac{V}{d} \times \left(\frac{1}{Z_1} \times \frac{p_1}{T_1} - \frac{1}{Z_2} \times \frac{p_2}{T_2} \right)$$

▼M3

For vehicles fuelled either with gaseous or liquid hydrogen, and with approval of the approval authority, the manufacturer may choose to calculate fuel consumption using either the equation for FC below or a method using a standard protocol such as SAE J2572.

▼B

$$FC = 0,1 \times (0,1119 \times \text{H}_2\text{O} + \text{H}_2)$$

The compressibility factor, Z, shall be obtained from the following table:

Table A7/2

Compressibility factor Z

		T (K)									
		5	100	200	300	400	500	600	700	800	900
p (bar)	33	0,859	1,051	1,885	2,648	3,365	4,051	4,712	5,352	5,973	6,576
	53	0,965	0,922	1,416	1,891	2,338	2,765	3,174	3,57	3,954	4,329
	73	0,989	0,991	1,278	1,604	1,923	2,229	2,525	2,810	3,088	3,358
	93	0,997	1,042	1,233	1,470	1,711	1,947	2,177	2,400	2,617	2,829
	113	1,000	1,066	1,213	1,395	1,586	1,776	1,963	2,146	2,324	2,498
	133	1,002	1,076	1,199	1,347	1,504	1,662	1,819	1,973	2,124	2,271
	153	1,003	1,079	1,187	1,312	1,445	1,580	1,715	1,848	1,979	2,107
	173	1,003	1,079	1,176	1,285	1,401	1,518	1,636	1,753	1,868	1,981
	193	1,003	1,077	1,165	1,263	1,365	1,469	1,574	1,678	1,781	1,882
	213	1,003	1,071	1,147	1,228	1,311	1,396	1,482	1,567	1,652	1,735
	233	1,004	1,071	1,148	1,228	1,312	1,397	1,482	1,568	1,652	1,736
	248	1,003	1,069	1,141	1,217	1,296	1,375	1,455	1,535	1,614	1,693

▼ B

		T (K)									
		5	100	200	300	400	500	600	700	800	900
	263	1,003	1,066	1,136	1,207	1,281	1,356	1,431	1,506	1,581	1,655
	278	1,003	1,064	1,130	1,198	1,268	1,339	1,409	1,480	1,551	1,621
	293	1,003	1,062	1,125	1,190	1,256	1,323	1,390	1,457	1,524	1,590
	308	1,003	1,060	1,120	1,182	1,245	1,308	1,372	1,436	1,499	1,562
	323	1,003	1,057	1,116	1,175	1,235	1,295	1,356	1,417	1,477	1,537
	338	1,003	1,055	1,111	1,168	1,225	1,283	1,341	1,399	1,457	1,514
	353	1,003	1,054	1,107	1,162	1,217	1,272	1,327	1,383	1,438	1,493

In the case that the required input values for p and T are not indicated in the table, the compressibility factor shall be obtained by linear interpolation between the compressibility factors indicated in the table, choosing the ones that are the closest to the sought value.

▼ M3

7. Drive trace indices

7.1. General requirement

The prescribed speed between time points in Tables A1/1 to A1/12 shall be determined by linear interpolation at a frequency of 10 Hz.

In the case that the accelerator control is fully activated, the prescribed speed shall be used instead of the actual vehicle speed for drive trace index calculations during such periods of operation.

For PEVs, the calculation of the drive trace indices shall include all the WLTC cycles and phases completed before the occurrence of the break-off criterion, as specified in paragraph 3.2.4.5. of Sub-Annex 8.

7.2. Calculation of drive trace indices

The following indices shall be calculated in accordance with SAE J2951(Revised Jan-2014):

- (a) IWR: Inertial Work Rating, per cent;
- (b) RMSSE: Root Mean Squared Speed Error, km/h.

7.3. Criteria for drive trace indices

In the case of a type approval test, the indices shall fulfil the following criteria:

- (a) IWR shall be in the range of – 2,0 to + 4,0 per cent;
- (b) RMSSE shall be less than 1,3 km/h.

8. Calculating n/v ratios

n/v ratios shall be calculated using the following equation:

▼ **M3**

$$\left(\frac{n}{v}\right)_i = (r_i \times r_{\text{axle}} \times 60\,000) / (U_{\text{dyn}} \times 3,6)$$

where:

n is engine speed, min^{-1} ;

v is the vehicle speed, km/h;

r_i is the transmission ratio in gear i ;

r_{axle} is the axle transmission ratio.

U_{dyn} is the dynamic rolling circumference of the tyres of the drive axle and is calculated using the following equation:

$$U_{\text{dyn}} = 3,05 \times \left(2 \left(\frac{H/W}{100} \right) \times W + (R \times 25,4) \right)$$

where:

H/W is the tyre's aspect ratio, e.g. '45' for a 225/45 R17 tyre;

W is the tyre width, mm; e.g. '225' for a 225/45 R17 tyre;

R is the wheel diameter, inch; e.g. '17' for a 225/45 R17 tyre.

U_{dyn} shall be rounded to whole millimetres.

If U_{dyn} is different for the front and the rear axles, the value of n/v for the mainly powered axle shall be applied. Upon request, the approval authority shall be provided with the necessary information for that selection.

▼B*Sub-Annex 8***Pure electric, hybrid electric and compressed hydrogen fuel cell hybrid vehicles**

1. General requirements

In the case of testing NOVC-HEVs, OVC-HEVs and NOVC-FCHVs, Appendix 2 and Appendix 3 to this Sub-Annex shall replace Appendix 2 to Sub-Annex 6.

Unless stated otherwise, all requirements in this Sub-Annex shall apply to vehicles with and without driver-selectable modes. Unless explicitly stated otherwise in this Sub-Annex, all of the requirements and procedures specified in Sub-Annex 6 shall continue to apply for NOVC-HEVs, OVC-HEVs, NOVC-FCHVs and PEVs.

▼M3

1.1. Units, accuracy and resolution of electric parameters

Units, accuracy and resolution of measurements shall be as shown in Table A8/1.

*Table A8/1***Parameters, units, accuracy and resolution of measurements**

Parameter	Units	Accuracy	Resolution
Electrical energy ⁽¹⁾	Wh	± 1 per cent	0,001 kWh ⁽²⁾
Electrical current	A	± 0,3 per cent FSD or ± 1 per cent of reading ⁽³⁾ ⁽⁴⁾	0,1 A
Electric voltage	V	± 0,3 per cent FSD or ± 1 per cent of reading ⁽³⁾	0,1 V

⁽¹⁾ Equipment: static meter for active energy.

⁽²⁾ AC watt-hour meter, Class 1 in accordance with IEC 62053-21 or equivalent.

⁽³⁾ Whichever is greater.

⁽⁴⁾ Current integration frequency 20 Hz or more.

1.2. Emission and fuel consumption testing

Parameters, units and accuracy of measurements shall be the same as those required for pure ICE vehicles.

▼B

1.3. Units and precision of final test results

Units and their precision for the communication of the final results shall follow the indications given in Table A8/2. For the purpose of calculation in paragraph 4. of this Sub-Annex, the unrounded values shall apply.

▼ M3

Table A8/2

Units and precision of final test results

Parameter	Units	Precision of final test result
PER _(p) ⁽²⁾ , PER _{city} , AER _(p) ⁽²⁾ , AER _{city} , EAER _(p) ⁽²⁾ , EAER _{city} , R _{CDA} ⁽¹⁾ , R _{CDC}	km	Rounded to nearest whole number
FC _{CS(p)} ⁽²⁾ , FC _{CD} , FC _{weighted} for HEVs	l/100 km	Rounded to the first place of decimal
FC _{CS(p)} ⁽²⁾ for FCHVs	kg/100 km	Rounded to the second place of decimal
M _{CO₂,CS(p)} ⁽²⁾ , M _{CO₂,CD} , M _{CO₂,weighted}	g/km	Rounded to the nearest whole number
EC _(p) ⁽²⁾ , EC _{city} , EC _{AC,CD} , EC _{AC,weighted}	Wh/km	Rounded to the nearest whole number
E _{AC}	kWh	Rounded to the first place of decimal

(¹) No vehicle individual parameter.

(²) (p) means the considered period which can be a phase, a combination of phases or the whole cycle.

▼ B

1.4. Vehicle classification

All OVC-HEVs, NOVC-HEVs, PEVs and NOVC-FCHVs shall be classified as Class 3 vehicles. The applicable test cycle for the Type 1 test procedure shall be determined according to paragraph 1.4.2. of this Sub-Annex based on the corresponding reference test cycle as described in paragraph 1.4.1. of this Sub-Annex.

1.4.1. Reference test cycle

▼ M3

1.4.1.1. The Class 3 reference test cycles are specified in paragraph 3.3. of Sub-Annex 1.

1.4.1.2. For PEVs, the downscaling procedure, in accordance with paragraphs 8.2.3. and 8.3. of Sub-Annex 1, may be applied on the test cycles in accordance with paragraph 3.3. of Sub-Annex 1 by replacing the rated power with maximum net power in accordance with UN/ECE Regulation No. 85. In such a case, the downscaled cycle is the reference test cycle.

▼ B

1.4.2. Applicable test cycle

1.4.2.1. Applicable WLTP test cycle

The reference test cycle according to paragraph 1.4.1. of this Sub-Annex shall be the applicable WLTP test cycle (WLTC) for the Type 1 test procedure.

In the case that paragraph 9. of Sub-Annex 1 is applied based on the reference test cycle as described in paragraph 1.4.1. of this Sub-Annex, this modified test cycle shall be the applicable WLTP test cycle (WLTC) for the Type 1 test procedure.

▼ M3

- 1.4.2.2. Applicable WLTP city test cycle
- The Class 3 WLTP city test cycle (WLTC_{city}) is specified in paragraph 3.5. of Sub-Annex 1.
- 1.5. OVC-HEVs, NOVC-HEVs and PEVs with manual transmissions
- The vehicles shall be driven in accordance with the technical gear shift indicator, if available, or in accordance with instructions incorporated in the manufacturer's handbook.
2. Run-in of test vehicle
- The vehicle tested in accordance with this Annex shall be presented in good technical condition and shall be run-in in accordance with the manufacturer's recommendations. In the case that the REESSs are operated above the normal operating temperature range, the operator shall follow the procedure recommended by the vehicle manufacturer in order to keep the temperature of the REESS in its normal operating range. The manufacturer shall provide evidence that the thermal management system of the REESS is neither disabled nor reduced.
- 2.1. OVC-HEVs and NOVC-HEVs shall have been run-in in accordance with the requirements of paragraph 2.3.3. of Sub-Annex 6.
- 2.2. NOVC-FCHVs shall have been run-in at least 300 km with their fuel cell and REESS installed.
- 2.3. PEVs shall have been run-in at least 300 km or one full charge distance, whichever is longer.
- 2.4. All REESS having no influence on CO₂ mass emissions or H₂ consumption shall be excluded from monitoring.

▼ B

3. Test procedure
- 3.1. General requirements
- 3.1.1. For all OVC-HEVs, NOVC-HEVs, PEVs and NOVC-FCHVs, the following shall apply where applicable:
- 3.1.1.1. Vehicles shall be tested according to the applicable test cycles described in paragraph 1.4.2. of this Sub-Annex.

▼ M3

- 3.1.1.2. If the vehicle cannot follow the applicable test cycle within the speed trace tolerances in accordance with paragraph 2.6.8.3. of Sub-Annex 6, the accelerator control shall, unless stated otherwise, be fully activated until the required speed trace is reached again.

▼ B

- 3.1.1.3. The powertrain start procedure shall be initiated by means of the devices provided for this purpose according to the manufacturer's instructions.
- 3.1.1.4. For OVC-HEVs, NOVC-HEVs and PEVs, exhaust emissions sampling and measurement of electric energy consumption shall begin for each applicable test cycle before or at the initiation of the vehicle start procedure and end at the conclusion of each applicable test cycle.
- 3.1.1.5. For OVC-HEVs and NOVC-HEVs, gaseous emission compounds, shall be analysed for each individual test phase. It is permitted to omit the phase analysis for phases where no combustion engine operates.
- 3.1.1.6. Particle number shall be analysed for each individual phase and particulate matter emission shall be analysed for each applicable test cycle.

▼ M3

- 3.1.2. Forced cooling as described in paragraph 2.7.2. of Sub-Annex 6 shall apply only for the charge-sustaining Type 1 test for OVC-HEVs in accordance with paragraph 3.2. of this Sub-Annex and for testing NOVC-HEVs in accordance with paragraph 3.3. of this Sub-Annex.

▼ B

- 3.2. OVC-HEVs
 - 3.2.1. Vehicles shall be tested under charge-depleting operating condition (CD condition), and charge-sustaining operating condition (CS condition).
 - 3.2.2. Vehicles may be tested according to four possible test sequences:
 - 3.2.2.1. Option 1: charge-depleting Type 1 test with no subsequent charge-sustaining Type 1 test.
 - 3.2.2.2. Option 2: charge-sustaining Type 1 test with no subsequent charge-depleting Type 1 test.
 - 3.2.2.3. Option 3: charge-depleting Type 1 test with a subsequent charge-sustaining Type 1 test.
 - 3.2.2.4. Option 4: charge-sustaining Type 1 test with a subsequent charge-depleting Type 1 test.



Figure A8/1

Possible test sequences in the case of OVC-HEV testing

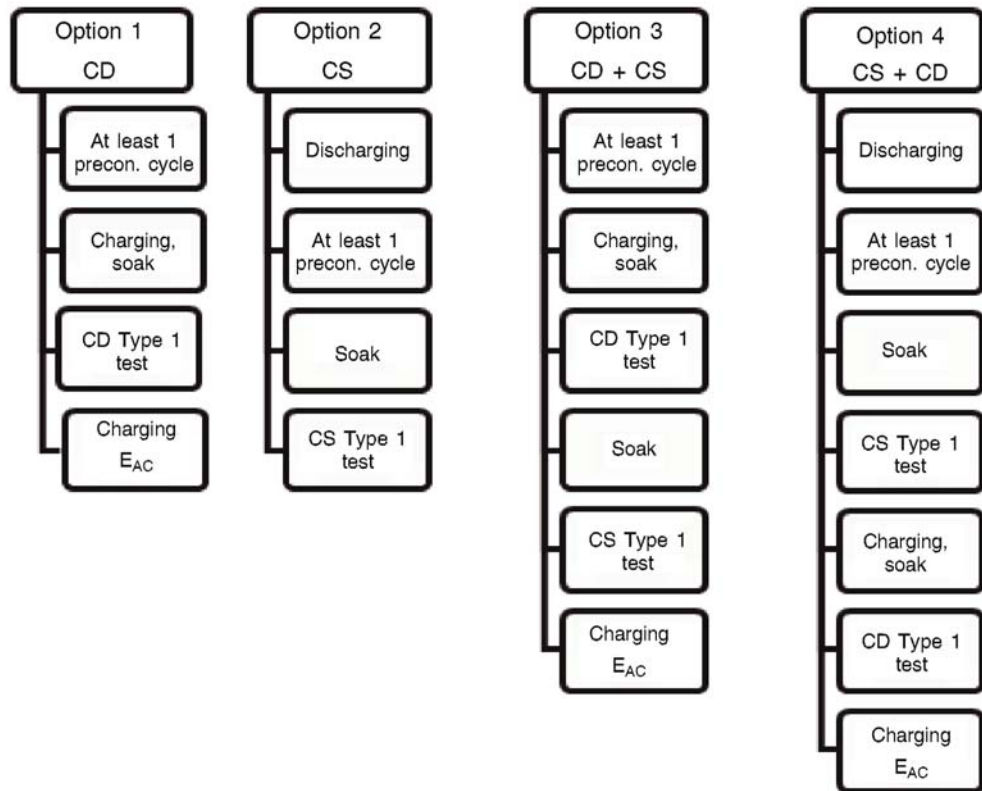

3.2.3. The driver-selectable mode shall be set as described in the following test sequences (Option 1 to Option 4).

3.2.4. Charge-depleting Type 1 test with no subsequent charge-sustaining Type 1 test (Option 1)

The test sequence according to Option 1, described in paragraphs 3.2.4.1. to 3.2.4.7. inclusive of this Sub-Annex, as well as the corresponding REESS state of charge profile, are shown in Figure A8.App1/1 in Appendix 1 to this Sub-Annex.

3.2.4.1. Preconditioning

The vehicle shall be prepared according to the procedures in paragraph 2.2. of Appendix 4 to this Sub-Annex.

3.2.4.2. Test conditions

3.2.4.2.1. The test shall be carried out with a fully charged REESS according to the charging requirements as described in paragraph 2.2.3. of Appendix 4 to this Sub-Annex and with the vehicle operated in charge-depleting operating condition as defined in paragraph 3.3.5. of this Annex.

3.2.4.2.2. Selection of a driver-selectable mode

For vehicles equipped with a driver-selectable mode, the mode for the charge-depleting Type 1 test shall be selected according to paragraph 2. of Appendix 6 to this Sub-Annex.

▼ B

- 3.2.4.3. Charge-depleting Type 1 test procedure
- 3.2.4.3.1. The charge-depleting Type 1 test procedure shall consist of a number of consecutive cycles, each followed by a soak period of no more than 30 minutes until charge-sustaining operating condition is achieved.

- 3.2.4.3.2. During soaking between individual applicable test cycles, the powertrain shall be deactivated and the REESS shall not be recharged from an external electric energy source. The instrumentation for measuring the electric current of all REESSs and for determining the electric voltage of all REESSs according to Appendix 3 of this Sub-Annex shall not be turned off between test cycle phases. In the case of ampere-hour meter measurement, the integration shall remain active throughout the entire test until the test is concluded.

Restarting after soak, the vehicle shall be operated in the driver-selectable mode according to paragraph 3.2.4.2.2. of this Sub-Annex.

- 3.2.4.3.3. In deviation from paragraph 5.3.1. of Sub-Annex 5 and without prejudice to paragraph 5.3.1.2. of Sub-Annex 5, analysers may be calibrated and zero-checked before and after the charge-depleting Type 1 test.

- 3.2.4.4. End of the charge-depleting Type 1 test
- The end of the charge-depleting Type 1 test is considered to have been reached when the break-off criterion according to paragraph 3.2.4.5. of this Sub-Annex is reached for the first time. The number of applicable WLTP test cycles up to and including the one where the break-off criterion was reached for the first time is set to n+1.

The applicable WLTP test cycle n is defined as the transition cycle.

The applicable WLTP test cycle n+1 is defined to be the confirmation cycle.

▼ M3

For vehicles without a charge-sustaining capability over the complete applicable WLTP test cycle, the end of the charge-depleting Type 1 test is reached by an indication on a standard on-board instrument panel to stop the vehicle, or when the vehicle deviates from the prescribed speed trace tolerance for 4 consecutive seconds or more. The accelerator control shall be deactivated and the vehicle shall be braked to standstill within 60 seconds.

▼ B

- 3.2.4.5. Break-off criterion

▼ B

- 3.2.4.5.1. Whether the break-off criterion has been reached for each driven applicable WLTP test cycle shall be evaluated.
- 3.2.4.5.2. The break-off criterion for the charge-depleting Type 1 test is reached when the relative electric energy change $REEC_i$ as calculated using the following equation, is less than 0.04.

$$REEC_i = \frac{|\Delta E_{REESS,i}|}{E_{cycle} \times \frac{1}{3\,600}}$$

where:

$REEC_i$ is the relative electric energy change of the applicable test cycle considered i of the charge-depleting Type 1 test;

$\Delta E_{REESS,i}$ is the change of electric energy of all REESSs for the considered charge-depleting Type 1 test cycle i calculated according to paragraph 4.3. of this Sub-Annex, Wh;

E_{cycle} is the cycle energy demand of the considered applicable WLTP test cycle calculated according to paragraph 5. of Sub-Annex 7, Ws;

i is the index number for the considered applicable WLTP test cycle;

$\frac{1}{3\,600}$ is a conversion factor to Wh for the cycle energy demand.

- 3.2.4.6. REESS charging and measuring the recharged electric energy
- 3.2.4.6.1. The vehicle shall be connected to the mains within 120 minutes after the applicable WLTP test cycle $n+1$ in which the break-off criterion for the charge-depleting Type 1 test is reached for the first time.

The REESS is fully charged when the end-of-charge criterion, as defined in paragraph 2.2.3.2. of Appendix 4 to this Sub-Annex, is reached.

- 3.2.4.6.2. The electric energy measurement equipment, placed between the vehicle charger and the mains, shall measure the recharged electric energy E_{AC} delivered from the mains, as well as its duration. Electric energy measurement may be stopped when the end-of-charge criterion, as defined in paragraph 2.2.3.2. of Appendix 4 to this Sub-Annex, is reached.

▼ M3

- 3.2.4.7. Each individual applicable WLTP test cycle within the charge-depleting Type 1 test shall fulfil the applicable criteria emission limits according to paragraph 1.2. of Sub-Annex 6.

▼B

- 3.2.5. Charge-sustaining Type 1 test with no subsequent charge-depleting Type 1 test (Option 2)
- The test sequence according to Option 2, as described in paragraphs 3.2.5.1. to 3.2.5.3.3. inclusive of this Sub-Annex, as well as the corresponding REESS state of charge profile, are shown in Figure A8.App1/2 in Appendix 1 to this Sub-Annex.
- 3.2.5.1. Preconditioning and soaking
- The vehicle shall be prepared according to the procedures in paragraph 2.1. of Appendix 4 to this Sub-Annex.
- 3.2.5.2. Test conditions
- 3.2.5.2.1. Tests shall be carried out with the vehicle operated in charge-sustaining operating condition as defined in paragraph 3.3.6. of this Annex.
- 3.2.5.2.2. Selection of a driver-selectable mode
- For vehicles equipped with a driver-selectable mode, the mode for the charge-sustaining Type 1 test shall be selected according to paragraph 3. of Appendix 6 to this Sub-Annex.
- 3.2.5.3. Type 1 test procedure
- 3.2.5.3.1. Vehicles shall be tested according to the Type 1 test procedures described in Sub-Annex 6.
- 3.2.5.3.2. If required, CO₂ mass emission shall be corrected according to Appendix 2 to this Sub-Annex.

▼M3

- 3.2.5.3.3. The test pursuant to paragraph 3.2.5.3.1. of this Sub-Annex shall fulfil the applicable criteria emission limits in accordance with paragraph 1.2. of Sub-Annex 6.

▼B

- 3.2.6. Charge-depleting Type 1 test with a subsequent charge-sustaining Type 1 test (Option 3)
- The test sequence according to Option 3, as described in paragraphs 3.2.6.1. to 3.2.6.3. inclusive of this Sub-Annex, as well as the corresponding REESS state of charge profile, are shown in Figure A8.App1/3 in Appendix 1 to this Sub-Annex.
- 3.2.6.1. For the charge-depleting Type 1 test, the procedure described in paragraphs 3.2.4.1. to 3.2.4.5. inclusive as well as paragraph 3.2.4.7. of this Sub-Annex shall be followed.
- 3.2.6.2. Subsequently, the procedure for the charge-sustaining Type 1 test described in paragraphs 3.2.5.1. to 3.2.5.3. inclusive of this Sub-Annex shall be followed. Paragraphs 2.1.1. to 2.1.2. inclusive of Appendix 4 to this Sub-Annex shall not apply.
- 3.2.6.3. REESS charging and measuring the recharged electric energy

▼B

- 3.2.6.3.1. The vehicle shall be connected to the mains within 120 minutes after the conclusion of the charge-sustaining Type 1 test.

The REESS is fully charged when the end-of-charge criterion as defined in paragraph 2.2.3.2. of Appendix 4 to this Sub-Annex is reached.

- 3.2.6.3.2. The energy measurement equipment, placed between the vehicle charger and the mains, shall measure the recharged electric energy E_{AC} delivered from the mains, as well as its duration. Electric energy measurement may be stopped when the end-of-charge criterion as defined in paragraph 2.2.3.2. of Appendix 4 to this Sub-Annex is reached.

- 3.2.7. Charge-sustaining Type 1 test with a subsequent charge-depleting Type 1 test (Option 4)

The test sequence according to Option 4, described in paragraphs 3.2.7.1. to 3.2.7.2. inclusive of this Sub-Annex, as well as the corresponding REESS state of charge profile, are shown in Figure A8.App1/4 of Appendix 1 to this Sub-Annex.

- 3.2.7.1. For the charge-sustaining Type 1 test, the procedure described in paragraphs 3.2.5.1. to 3.2.5.3. inclusive of this Sub-Annex, as well as paragraph 3.2.6.3.1. of this Sub-Annex shall be followed.

- 3.2.7.2. Subsequently, the procedure for the charge-depleting Type 1 test described in paragraphs 3.2.4.2. to 3.2.4.7. inclusive of this Sub-Annex shall be followed.

- 3.3. NOVC-HEVs

The test sequence described in paragraphs 3.3.1. to 3.3.3. inclusive of this Sub-Annex, as well as the corresponding REESS state of charge profile, are shown in Figure A8.App1/5 of Appendix 1 to this Sub-Annex.

- 3.3.1. Preconditioning and soaking

▼M3

- 3.3.1.1. Vehicles shall be preconditioned in accordance with paragraph 2.6. of Sub-Annex 6.

In addition to the requirements of paragraph 2.6. of Sub-Annex 6, the level of the state of charge of the traction REESS for the charge-sustaining test may be set in accordance with the manufacturer's recommendation before preconditioning in order to achieve a test under charge-sustaining operating condition.

- 3.3.1.2. Vehicles shall be soaked in accordance with paragraph 2.7. of Sub-Annex 6.

▼B

- 3.3.2. Test conditions

- 3.3.2.1. Vehicles shall be tested under charge-sustaining operating condition as defined in paragraph 3.3.6. of this Annex.

▼ B

- 3.3.2.2. Selection of a driver-selectable mode
For vehicles equipped with a driver-selectable mode, the mode for the charge-sustaining Type 1 test shall be selected according to paragraph 3. of Appendix 6 to this Sub-Annex.
- 3.3.3. Type 1 test procedure
- 3.3.3.1. Vehicles shall be tested according to the Type 1 test procedure described in Sub-Annex 6.
- 3.3.3.2. If required, the CO₂ mass emission shall be corrected according to Appendix 2 to this Sub-Annex.

▼ M3

- 3.3.3.3. The charge-sustaining Type 1 test shall fulfil the applicable criteria emission limits in accordance with paragraph 1.2. of Sub-Annex 6.

▼ B

- 3.4. PEVs

▼ M3

- 3.4.1. General requirements
The test procedure to determine the pure electric range and electric energy consumption shall be selected in accordance with the estimated pure electric range (PER) of the test vehicle from Table A8/3. In the case that the interpolation method is applied, the applicable test procedure shall be selected in accordance with the PER of vehicle H within the specific interpolation family.

Table A8/3

Procedures to determine pure electric range and electric energy consumption

Applicable test cycle	The estimated PER is...	Applicable test procedure
Test cycle pursuant to paragraph 1.4.2.1. of this Sub-Annex.	...less than the length of 3 applicable WLTP test cycles.	Consecutive cycle Type 1 test procedure (in accordance with paragraph 3.4.4.1. of this Sub-Annex).
	... equal to or greater than the length of 3 applicable WLTP test cycles.	Shortened Type 1 test procedure (in accordance with paragraph 3.4.4.2. of this Sub-Annex).
City cycle pursuant to paragraph 1.4.2.2. of this Sub-Annex.	...not available over the applicable WLTP test cycle.	Consecutive cycle Type 1 test procedure (in accordance with paragraph 3.4.4.1. of this Sub-Annex).

The manufacturer shall give evidence to the approval authority concerning the estimated pure electric range (PER) prior to the test. In the case that the interpolation method is applied, the applicable test procedure shall be determined based on the estimated PER of vehicle H of the interpolation family. The PER determined by the applied test procedure shall confirm that the correct test procedure was applied.

▼ M3

The test sequence for the consecutive cycle Type 1 test procedure, as described in paragraphs 3.4.2., 3.4.3. and 3.4.4.1. of this Sub-Annex, as well as the corresponding REESS state of charge profile, are shown in Figure A8.App1/6 of Appendix 1 to this Sub-Annex.

The test sequence for the shortened Type 1 test procedure, as described in paragraphs 3.4.2., 3.4.3. and 3.4.4.2. of this Sub-Annex as well as the corresponding REESS state of charge profile, are shown in Figure A8.App1/7 in Appendix 1 to this Sub-Annex.

▼ B

3.4.2. Preconditioning

The vehicle shall be prepared according to the procedures in paragraph 3. of Appendix 4 to this Sub-Annex.

▼ M3

3.4.3. Selection of a driver-selectable mode

For vehicles equipped with a driver-selectable mode, the mode for the test shall be selected according to paragraph 4. of Appendix 6 to this Sub-Annex.

▼ B

3.4.4. PEV Type 1 test procedures

3.4.4.1. Consecutive cycle Type 1 test procedure

3.4.4.1.1. Speed trace and breaks

The test shall be performed by driving consecutive applicable test cycles until the break-off criterion according to paragraph 3.4.4.1.3. of this Sub-Annex is reached.

▼ M3

Breaks for the driver and/or operator are permitted only between test cycles and with a maximum total break time of 10 minutes. During the break, the powertrain shall be switched off.

▼ B

3.4.4.1.2. REESS current and voltage measurement

From the beginning of the test until the break-off criterion is reached, the electric current of all REESSs shall be measured according to Appendix 3 to this Sub-Annex and the electric voltage shall be determined according to Appendix 3 to this Sub-Annex.

▼ M3

3.4.4.1.3. Break-off criterion

The break-off criterion is reached when the vehicle exceeds the prescribed speed trace tolerance as specified in paragraph 2.6.8.3. of Sub-Annex 6 for 4 consecutive seconds or more. The accelerator control shall be deactivated. The vehicle shall be braked to standstill within 60 seconds.

▼ B

3.4.4.2. Shortened Type 1 test procedure

3.4.4.2.1. Speed trace

The shortened Type 1 test procedure consists of two dynamic segments (DS₁ and DS₂) combined with two constant speed segments (CSS_M and CSS_E) as shown in Figure A8/2.

▼ B

Figure A8/2

Shortened Type 1 test procedure speed trace

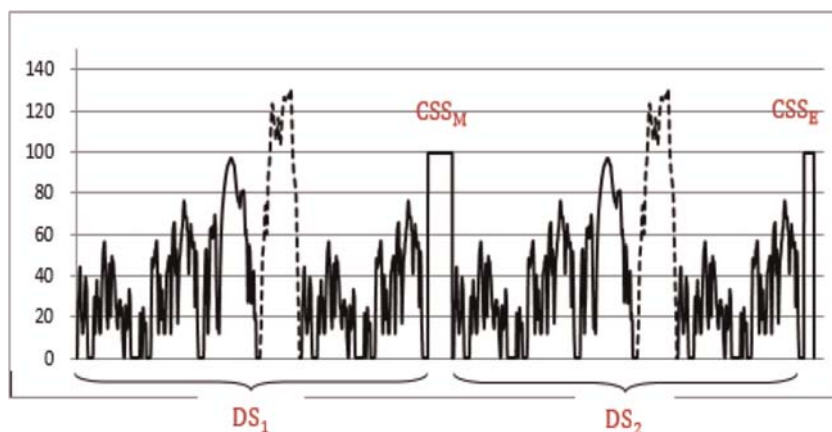
▼ M3

The dynamic segments DS_1 and DS_2 are used to calculate the energy consumption of the phase considered, the applicable WLTP city cycle and the applicable WLTP test cycle.

▼ B

The constant speed segments CSS_M and CSS_E are intended to reduce test duration by depleting the REESS more rapidly than the consecutive cycle Type 1 test procedure.

▼ M3

3.4.4.2.1.1. Dynamic segments

Each dynamic segment DS_1 and DS_2 consists of an applicable WLTP test cycle in accordance with paragraph 1.4.2.1. of this Sub-Annex followed by an applicable WLTP city test cycle in accordance with paragraph 1.4.2.2. of this Sub-Annex.

▼ B

3.4.4.2.1.2. Constant speed segment

▼ M3

The constant speeds during segments CSS_M and CSS_E shall be identical. If the interpolation method is applied, the same constant speed shall be applied within the interpolation family.

▼ B

(a) Speed specification

The minimum speed of the constant speed segments shall be 100 km/h. At the request of manufacturer and with approval of the approval authority, a higher constant speed in the constant speed segments may be selected.

The acceleration to the constant speed level shall be smooth and accomplished within 1 minute after completion of the dynamic segments and, in the case of a break according to Table A8/4, after initiating the powertrain start procedure.

If the maximum speed of the vehicle is lower than the required minimum speed for the constant speed segments according to the speed specification of this paragraph, the required speed in the constant speed segments shall be equal to the maximum speed of the vehicle.

▼ B(b) Distance determination of CSS_E and CSS_M

The length of the constant speed segment CSS_E shall be determined based on the percentage of the usable REESS energy UBE_{STP} according to paragraph 4.4.2.1. of this Sub-Annex. The remaining energy in the traction REESS after dynamic speed segment DS_2 shall be equal to or less than 10 per cent of UBE_{STP} . The manufacturer shall provide evidence to the approval authority after the test that this requirement is fulfilled.

The length of the constant speed segment CSS_M may be calculated using the following equation:

$$d_{CSSM} = PER_{est} - d_{DS1} - d_{DS2} - d_{CSS_E}$$

where:

PER_{est} is the estimated pure electric range of the considered PEV, km;

d_{DS1} is the length of dynamic speed segment 1, km;

d_{DS2} is the length of dynamic speed segment 2, km;

d_{CSS_E} is the length of constant speed segment CSS_E , km.

3.4.4.2.1.3. Breaks

Breaks for the driver and/or operator are permitted only in the constant speed segments as prescribed in Table A8/4.

Table A8/4

Breaks for the driver and/or test operator

▼ M3**▼ B**

Distance driven in constant speed segment CSS_M (km)	Maximum total break (min)
Up to 100	10
Up to 150	20
Up to 200	30
Up to 300	60
More than 300	Shall be based on the manufacturer's recommendation

Note: During a break, the powertrain shall be switched off.

3.4.4.2.2. REESS current and voltage measurement

From the beginning of the test until the break-off criterion is reached, the electric current of all REESSs and the electric voltage of all REESSs shall be determined according to Appendix 3 to this Sub-Annex.

▼ M3

3.4.4.2.3. Break-off criterion

The break-off criterion is reached when the vehicle exceeds the prescribed speed trace tolerance as specified in paragraph 2.6.8.3. of Sub-Annex 6 for 4 consecutive seconds or more in the second constant speed segment CSS_E . The accelerator control shall be deactivated. The vehicle shall be braked to a standstill within 60 seconds.

▼ B

3.4.4.3. REESS charging and measuring the recharged electric energy

3.4.4.3.1. After coming to a standstill according to paragraph 3.4.4.1.3. of this Sub-Annex for the consecutive cycle Type 1 test procedure and in paragraph 3.4.4.2.3. of this Sub-Annex for the shortened Type 1 test procedure, the vehicle shall be connected to the mains within 120 minutes.

The REESS is fully charged when the end-of-charge criterion, as defined in paragraph 2.2.3.2. of Appendix 4 to this Sub-Annex, is reached.

3.4.4.3.2. The energy measurement equipment, placed between the vehicle charger and the mains, shall measure the recharged electric energy E_{AC} delivered from the mains as well as its duration. Electric energy measurement may be stopped when the end-of-charge criterion, as defined in paragraph 2.2.3.2. of Appendix 4 to this Sub-Annex, is reached.

3.5. NOVC-FCHVs

The test sequence, described in paragraphs 3.5.1. to 3.5.3. inclusive of this Sub-Annex, as well as the corresponding REESS state of charge profile, is shown in Figure A8.App1/5 in Appendix 1 to this Sub-Annex.

3.5.1. Preconditioning and soaking

Vehicles shall be conditioned and soaked according to paragraph 3.3.1. of this Sub-Annex.

3.5.2. Test conditions

3.5.2.1. Vehicles shall be tested under charge-sustaining operating conditions as defined in paragraph 3.3.6. of this Annex.

3.5.2.2. Selection of a driver-selectable mode

For vehicles equipped with a driver-selectable mode, the mode for the charge-sustaining Type 1 test shall be selected according to paragraph 3. of Appendix 6 to this Sub-Annex.

3.5.3. Type 1 test procedure

3.5.3.1. Vehicles shall be tested according to the Type 1 test procedure described in Sub-Annex 6 and fuel consumption calculated according to Appendix 7 to this Sub-Annex.

▼ B

3.5.3.2. If required, fuel consumption shall be corrected according to Appendix 2 to this Sub-Annex.

4. Calculations for hybrid electric, pure electric and compressed hydrogen fuel cell vehicles

4.1. Calculations of gaseous emission compounds, particulate matter emission and particle number emission

4.1.1. Charge-sustaining mass emission of gaseous emission compounds, particulate matter emission and particle number emission for OVC-HEVs and NOVC-HEVs

The charge-sustaining particulate matter emission PM_{CS} shall be calculated according to paragraph 3.3. of Sub-Annex 7.

The charge-sustaining particle number emission PN_{CS} shall be calculated according to paragraph 4. of Sub-Annex 7.

4.1.1.1. ► **M3** Stepwise procedure for calculating the final test results of the charge-sustaining Type 1 test for NOVC-HEVs and OVC-HEVs ◀

The results shall be calculated in the order described in Table A8/5. All applicable results in the column 'Output' shall be recorded. The column 'Process' describes the paragraphs to be used for calculation or contains additional calculations.

For the purpose of this table, the following nomenclature within the equations and results is used:

c complete applicable test cycle;

p every applicable cycle phase;

i applicable criteria emission component (except CO_2);

CS charge-sustaining

CO_2 CO_2 mass emission.

▼ M3

Table A8/5

Calculation of final charge-sustaining gaseous emission values

Source	Input	Process	Output	Step No.
Sub-Annex 6	Raw test results	Charge-sustaining mass emissions Paragraphs 3. to 3.2.2. of Sub-Annex 7.	$M_{i,CS,p,1}$, g/km; $M_{CO_2,CS,p,1}$, g/km.	1

▼ M3

Source	Input	Process	Output	Step No.
Output from step No. 1 of this table.	$M_{i,CS,p,1}$, g/km; $M_{CO_2,CS,p,1}$, g/km.	Calculation of combined charge-sustaining cycle values: $M_{i,CS,e,2} = \frac{\sum_p M_{i,CS,p,1} \times d_p}{\sum_p d_p}$ $M_{CO_2,CS,e,2} = \frac{\sum_p M_{CO_2,CS,p,1} \times d_p}{\sum_p d_p}$ where: $M_{i,CS,e,2}$ is the charge-sustaining mass emission result over the total cycle; $M_{CO_2,CS,e,2}$ is the charge-sustaining CO ₂ mass emission result over the total cycle; d_p are the driven distances of the cycle phases p.	$M_{i,CS,e,2}$, g/km; $M_{CO_2,CS,e,2}$, g/km.	2
Output from steps Nos. 1 and 2 of this table.	$M_{CO_2,CS,p,1}$, g/km; $M_{CO_2,CS,e,2}$, g/km.	REESS electric energy change correction Paragraphs 4.1.1.2. to 4.1.1.5. of this Sub-Annex.	$M_{CO_2,CS,p,3}$, g/km; $M_{CO_2,CS,e,3}$, g/km.	3
Output from steps Nos. 2 and 3 of this table.	$M_{i,CS,e,2}$, g/km; $M_{CO_2,CS,e,3}$, g/km.	Charge-sustaining mass emission correction for all vehicles equipped with periodically regenerating systems K_i in accordance with Sub-Annex 6, Appendix 1. $M_{i,CS,e,4} = K_i \times M_{i,CS,e,2}$ or $M_{i,CS,e,4} = K_i + M_{i,CS,e,2}$ and $M_{CO_2,CS,e,4} = K_{CO_2,K_i} \times M_{CO_2,CS,e,3}$ or $M_{CO_2,CS,e,4} = K_{CO_2,K_i} + M_{CO_2,CS,e,3}$ Additive offset or multiplicative factor to be used in accordance with K_i determination. If K_i is not applicable: $M_{i,CS,e,4} = M_{i,CS,e,2}$ $M_{CO_2,CS,e,4} = M_{CO_2,CS,e,3}$	$M_{i,CS,e,4}$, g/km; $M_{CO_2,CS,e,4}$, g/km.	4a

▼ M3

Source	Input	Process	Output	Step No.
Output from steps Nos. 3 and 4a of this table.	$M_{CO_2,CS,p,3}$, g/km; $M_{CO_2,CS,e,3}$, g/km; $M_{CO_2,CS,e,4}$, g/km.	If K_i is applicable, align CO ₂ phase values to combined cycle value: $M_{CO_2,CS,p,4} = M_{CO_2,CS,p,3} \times AF_{K_i}$ for every cycle phase p; where: $AF_{K_i} = \frac{M_{CO_2,CS,e,4}}{M_{CO_2,CS,e,3}}$ If K_i is not applicable: $M_{CO_2,CS,p,4} = M_{CO_2,CS,p,3}$	$M_{CO_2,CS,p,4}$, g/km.	4b
Output from step No. 4 of this table.	$M_{i,CS,e,4}$, g/km; $M_{CO_2,CS,p,4}$, g/km; $M_{CO_2,CS,e,4}$, g/km;	ATCT correction in accordance with paragraph 3.8.2. of Sub-Annex 6a. Deterioration factors calculated and applied in accordance with Annex VII.	$M_{i,CS,e,5}$, g/km; $M_{CO_2,CS,e,5}$, g/km; $M_{CO_2,CS,p,5}$, g/km.	5 Result of a single test.
Output from step No. 5 of this table.	For every test: $M_{i,CS,e,5}$, g/km; $M_{CO_2,CS,e,5}$, g/km; $M_{CO_2,CS,p,5}$, g/km.	Averaging of tests and declared value in accordance with paragraphs 1.2. to 1.2.3. of Sub-Annex 6.	$M_{i,CS,e,6}$, g/km; $M_{CO_2,CS,e,6}$, g/km; $M_{CO_2,CS,p,6}$, g/km; $M_{CO_2,CS,e,declared}$, g/km.	6 $M_{i,CS}$ results of a Type 1 test for a test vehicle.
Output from step No. 6 of this table.	$M_{CO_2,CS,e,6}$, g/km; $M_{CO_2,CS,p,6}$, g/km; $M_{CO_2,CS,e,declared}$, g/km.	Alignment of phase values. Paragraph 1.2.4. of Sub-Annex 6, and: $M_{CO_2,CS,e,7} = M_{CO_2,CS,e,declared}$	$M_{CO_2,CS,e,7}$, g/km; $M_{CO_2,CS,p,7}$, g/km.	7 $M_{CO_2,CS}$ results of a Type 1 test for a test vehicle.
Output from steps Nos. 6 and 7 of this table.	For each of the test vehicles H and L: $M_{i,CS,e,6}$, g/km; $M_{CO_2,CS,e,7}$, g/km; $M_{CO_2,CS,p,7}$, g/km.	If in addition to a test vehicle H a test vehicle L and, if applicable vehicle M was also tested, the resulting criteria emission value shall be the highest of the two or, if applicable, three values and referred to as $M_{i,CS,e}$. In the case of the combined THC + NO _x emissions, the highest value of the sum referring to either the vehicle H or vehicle L or, if applicable, vehicle M is to be declared. Otherwise, if no vehicle L or if applicable vehicle M was tested, $M_{i,CS,e} = M_{i,CS,e,6}$ For CO ₂ the values derived in step 7 of this Table shall be used. CO ₂ values shall be rounded to two decimal places.	$M_{i,CS,e}$, g/km; $M_{CO_2,CS,e,H}$, g/km; $M_{CO_2,CS,p,H}$, g/km; If a vehicle L was tested: $M_{CO_2,CS,e,L}$, g/km; $M_{CO_2,CS,p,L}$, g/km; and, if applicable, a vehicle M was tested: $M_{CO_2,CS,e,M}$, g/km; $M_{CO_2,CS,p,M}$, g/km;	8 Interpolation family result. Final criteria emission result.

▼ M3

Source	Input	Process	Output	Step No.
Output from step No. 8 of this table.	$M_{CO_2,CS,e,H}$, g/km; $M_{CO_2,CS,p,H}$, g/km; If a vehicle L was tested: $M_{CO_2,CS,e,L}$, g/km; $M_{CO_2,CS,p,L}$, g/km and, if applicable, a vehicle M was tested: $M_{CO_2,CS,e,M}$, g/km; $M_{CO_2,CS,p,M}$, g/km;	CO ₂ mass emission calculation in accordance with paragraph 4.5.4.1. of this Sub-Annex for individual vehicles in an interpolation family. CO ₂ values shall be rounded in accordance with Table A8/2.	$M_{CO_2,CS,e,ind}$, g/km; $M_{CO_2,CS,p,ind}$, g/km.	9 Result of an individual vehicle. Final CO ₂ result.

▼ B

- 4.1.1.2. In the case that the correction according to paragraph 1.1.4. of Appendix 2 to this Sub-Annex was not applied, the following charge-sustaining CO₂ mass emission shall be used:

$$M_{CO_2,CS} = M_{CO_2,CS,nb}$$

where:

$M_{CO_2,CS}$ is the charge-sustaining CO₂ mass emission of the charge-sustaining Type 1 test according to Table A8/5, step no. 3, g/km;

$M_{CO_2,CS,nb}$ is the non-balanced charge-sustaining CO₂ mass emission of the charge-sustaining Type 1 test, not corrected for the energy balance, determined according to Table A8/5, step no. 2, g/km.

- 4.1.1.3. If the correction of the charge-sustaining CO₂ mass emission is required according to paragraph 1.1.3. of Appendix 2 to this Sub-Annex or in the case that the correction according to paragraph 1.1.4. of Appendix 2 to this Sub-Annex was applied, the CO₂ mass emission correction coefficient shall be determined according to paragraph 2. of Appendix 2 to this Sub-Annex. The corrected charge-sustaining CO₂ mass emission shall be determined using the following equation:

$$M_{CO_2,CS} = M_{CO_2,CS,nb} - K_{CO_2} \times EC_{DC,CS}$$

where:

▼ M3

$M_{CO_2,CS}$ is the charge-sustaining CO₂ mass emission of the charge-sustaining Type 1 test according to Table A8/5, step No. 3, g/km;

▼ B

$M_{CO_2,CS,nb}$ is the non-balanced CO₂ mass emission of the charge-sustaining Type 1 test, not corrected for the energy balance, determined according to Table A8/5, step no. 2, g/km;

▼ B

$EC_{DC,CS}$ is the electric energy consumption of the charge-sustaining Type 1 test according to paragraph 4.3. of this Sub-Annex, Wh/km;

K_{CO_2} is the CO₂ mass emission correction coefficient according to paragraph 2.3.2. of Appendix 2 to this Sub-Annex, (g/km)/(Wh/km).

- 4.1.1.4. In the case that phase-specific CO₂ mass emission correction coefficients have not been determined, the phase-specific CO₂ mass emission shall be calculated using the following equation:

$$M_{CO_2,CS,p} = M_{CO_2,CS,nb,p} - K_{CO_2} \times EC_{DC,CS,p}$$

where:

▼ M3

$M_{CO_2,CS,p}$ is the charge-sustaining CO₂ mass emission of phase p of the charge-sustaining Type 1 test in accordance with Table A8/5, step No. 3, g/km;

$M_{CO_2,CS,nb,p}$ is the non-balanced CO₂ mass emission of phase p of the charge-sustaining Type 1 test, not corrected for the energy balance, determined in accordance with Table A8/5, step No. 1, g/km;

▼ B

$EC_{DC,CS,p}$ is the electric energy consumption of phase p of the charge-sustaining Type 1 test according to paragraph 4.3. of this Sub-Annex, Wh/km;

K_{CO_2} is the CO₂ mass emission correction coefficient according to paragraph 2.3.2. of Appendix 2 to this Sub-Annex, (g/km)/(Wh/km).

- 4.1.1.5. In the case that phase-specific CO₂ mass emission correction coefficients have been determined, the phase-specific CO₂ mass emission shall be calculated using the following equation:

$$M_{CO_2,CS,p} = M_{CO_2,CS,nb,p} - K_{CO_2,p} \times EC_{DC,CS,p}$$

where:

$M_{CO_2,CS,p}$ is the charge-sustaining CO₂ mass emission of phase p of the charge-sustaining Type 1 test according to Table A8/5, step no. 3, g/km;

▼ M3

$M_{CO_2,CS,nb,p}$ is the non-balanced CO₂ mass emission of phase p of the charge-sustaining Type 1 test, not corrected for the energy balance, determined in accordance with Table A8/5, step No. 1, g/km;

▼ B

- $EC_{DC,CS,p}$ is the electric energy consumption of phase p of the charge-sustaining Type 1 test, determined according to paragraph 4.3. of this Sub-Annex, Wh/km;
- $K_{CO_2,p}$ is the CO₂ mass emission correction coefficient according to paragraph 2.3.2.2. of Appendix 2 to this Sub-Annex, (g/km)/(Wh/km);
- p is the index of the individual phase within the applicable WLTP test cycle.

4.1.2. Utility factor-weighted charge-depleting CO₂ mass emission for OVC-HEVs

The utility factor-weighted charge-depleting CO₂ mass emission $M_{CO_2,CD}$ shall be calculated using the following equation:

$$M_{CO_2,CD} = \frac{\sum_{j=1}^k (UF_j \times M_{CO_2,CD,j})}{\sum_{j=1}^k UF_j}$$

where:

- $M_{CO_2,CD}$ is the utility factor-weighted charge-depleting CO₂ mass emission, g/km;
- $M_{CO_2,CD,j}$ is the CO₂ mass emission determined according to paragraph 3.2.1. of Sub-Annex 7 of phase j of the charge-depleting Type 1 test, g/km;
- UF_j is the utility factor of phase j according to Appendix 5 of this Sub-Annex;
- j is the index number of the phase considered;
- k is the number of phases driven up to the end of the transition cycle according to paragraph 3.2.4.4. of this Sub-Annex.

▼ M3

In the case that the interpolation method is applied, k shall be the number of phases driven up to the end of the transition cycle of vehicle L $n_{veh,L}$.

If the transition cycle number driven by vehicle H, $n_{veh,H}$, and, if applicable, by an individual vehicle within the vehicle interpolation family, $n_{veh,ind}$, is lower than the transition cycle number driven by vehicle L, $n_{veh,L}$, the confirmation cycle of vehicle H and, if applicable, an individual vehicle shall be included in the calculation. The CO₂ mass emission of each phase of the confirmation cycle shall then be corrected to an electric energy consumption of zero $EC_{DC,CD,j} = 0$ by using the CO₂ correction coefficient in accordance with Appendix 2 of this Sub-Annex.

▼ B

4.1.3. Utility factor-weighted mass emissions of gaseous compounds, particulate matter emission and particle number emission for OVC-HEVs.

▼ B

4.1.3.1. The utility factor-weighted mass emission of gaseous compounds shall be calculated using the following equation:

$$M_{i,\text{weighted}} = \sum_{j=1}^k (UF_j \times M_{i,\text{CD},j}) + (1 - \sum_{j=1}^k UF_j) \times M_{i,\text{CS}}$$

where:

$M_{i,\text{weighted}}$ is the utility factor-weighted mass emission compound i , g/km;

i is the index of the considered gaseous emission compound;

UF_j is the utility factor of phase j according to Appendix 5 of this Sub-Annex;

$M_{i,\text{CD},j}$ is the mass emission of the gaseous emission compound i determined according to paragraph 3.2.1. of Sub-Annex 7 of phase j of the charge-depleting Type 1 test, g/km;

$M_{i,\text{CS}}$ is the charge-sustaining mass emission of gaseous emission compound i for the charge-sustaining Type 1 test according to Table A8/5, step no. 7, g/km;

j is the index number of the phase considered;

k is the number of phases driven until the end of the transition cycle according to paragraph 3.2.4.4. of this Sub-Annex.

▼ M3

In the case that the interpolation method is applied for $i = \text{CO}_2$, k shall be the number of phases driven up to the end of the transition cycle of vehicle L $n_{\text{veh},L}$.

If the transition cycle number driven by vehicle H , $n_{\text{veh},H}$, and, if applicable, by an individual vehicle within the vehicle interpolation family $n_{\text{veh},\text{ind}}$ is lower than the transition cycle number driven by vehicle L , $n_{\text{veh},L}$, the confirmation cycle of vehicle H and, if applicable, an individual vehicle shall be included in the calculation. The CO_2 mass emission of each phase of the confirmation cycle shall then be corrected to an electric energy consumption of zero $EC_{\text{DC},\text{CD},j} = 0$ by using the CO_2 correction coefficient in accordance with Appendix 2 of this Sub-Annex.

▼ B

4.1.3.2. The utility factor-weighted particle number emission shall be calculated using the following equation:

$$PN_{\text{weighted}} = \sum_{j=1}^k (UF_j \times PN_{\text{CD},j}) + (1 - \sum_{j=1}^k UF_j) \times PN_{\text{CS}}$$

where:

PN_{weighted} is the utility factor-weighted particle number emission, particles per kilometre;

▼ B

UF _j	is the utility factor of phase j according to Appendix 5 of this Sub-Annex;
PN _{CDj}	is the particle number emission during phase j determined according to paragraph 4. of Sub-Annex 7 for the charge-depleting Type 1 test, particles per kilometre;
PN _{CS}	is the particle number emission determined according to paragraph 4.1.1. of this Sub-Annex for the charge-sustaining Type 1 test, particles per kilometre;
j	is the index number of the phase considered;
k	is the number of phases driven until the end of transition cycle n according to paragraph 3.2.4.4. of this Sub-Annex.

4.1.3.3. The utility factor-weighted particulate matter emission shall be calculated using the following equation:

$$PM_{\text{weighted}} = \sum_{c=1}^{n_c} (UF_c \times PM_{CD,c}) + (1 - \sum_{c=1}^{n_c} UF_c) \times PM_{CS}$$

where:

PM _{weighted}	is the utility factor-weighted particulate matter emission, mg/km;
UF _c	is the utility factor of cycle c according to Appendix 5 of this Sub-Annex;
PM _{CD,c}	is the charge-depleting particulate matter emission during cycle c determined according to paragraph 3.3. of Sub-Annex 7 for the charge-depleting Type 1 test, mg/km;
PM _{CS}	is the particulate matter emission of the charge-sustaining Type 1 test according to paragraph 4.1.1. of this Sub-Annex, mg/km;
c	is the index number of the cycle considered;
n _c	is the number of applicable WLTP test cycles driven until the end of the transition cycle n according to paragraph 3.2.4.4. of this Sub-Annex.

4.2. Calculation of fuel consumption

4.2.1. Charge-sustaining fuel consumption for OVC-HEVs, NOVC-HEVs and NOVC-FCHVs

4.2.1.1. The charge-sustaining fuel consumption for OVC-HEVs and NOVC-HEVs shall be calculated stepwise according to Table A8/6.



Table A8/6

Calculation of final charge-sustaining fuel consumption for OVC-HEVs, NOVC-HEVs

Source	Input	Process	Output	Step no.
Output from step no. 6 and 7 of Table A8/5 of this Sub-Annex.	$M_{i,CS,e,6}$, g/km; $M_{CO_2,CS,e,7}$, g/km; $M_{CO_2,CS,p,7}$, g/km;	<p>Calculation of fuel consumption according to paragraph 6. of Sub-Annex 7.</p> <p>The calculation of fuel consumption shall be performed separately for the applicable cycle and its phases.</p> <p>For that purpose:</p> <p>(a) the applicable phase or cycle CO₂ values shall be used;</p> <p>(b) the criteria emission over the complete cycle shall be used.</p>	$FC_{CS,e,1}$, l/100 km; $FC_{CS,p,1}$, l/100 km;	1 ‘FC _{CS} results of a Type 1 test for a test vehicle’
Step no. 1 of this Table.	For each of the test vehicles H and L: $FC_{CS,e,1}$, l/100 km; $FC_{CS,p,1}$, l/100 km;	<p>For FC the values derived in step no. 1 of this Table shall be used.</p> <p>FC values shall be rounded to three decimal places.</p>	$FC_{CS,e,H}$, l/100 km; $FC_{CS,p,H}$, l/100 km; and if a vehicle L was tested: $FC_{CS,e,L}$, l/100 km; $FC_{CS,p,L}$, l/100 km;	2 ‘interpolation family result’ final criteria emission result
Step no. 2 of this Table.	$FC_{CS,e,H}$, l/100 km; $FC_{CS,p,H}$, l/100 km; and if a vehicle L was tested: $FC_{CS,e,L}$, l/100 km; $FC_{CS,p,L}$, l/100 km;	<p>Fuel consumption calculation according to paragraph 4.5.5.1. of this Sub-Annex for individual vehicles in an interpolation family.</p> <p>FC values shall be rounded according to Table A8/2.</p>	$FC_{CS,e,ind}$, l/100 km; $FC_{CS,p,ind}$, l/100 km;	3 ‘result of an individual vehicle’ final FC result

▼B

4.2.1.2. Charge-sustaining fuel consumption for NOVC-FCHVs

▼M3

4.2.1.2.1. Stepwise procedure for calculating the final test fuel consumption results of the charge-sustaining Type 1 test for NOVC-FCHVs

▼B

The results shall be calculated in the order described in the Tables A8/7. All applicable results in the column 'Output' shall be recorded. The column 'Process' describes the paragraphs to be used for calculation or contains additional calculations.

For the purpose of this table, the following nomenclature within the equations and results is used:

c: complete applicable test cycle;

p: every applicable cycle phase;

CS: charge-sustaining

Table A8/7

Calculation of final charge-sustaining fuel consumption for NOVC-FCHVs

Source	Input	Process	Output	Step no.
Appendix 7 of this Sub-Annex.	Non-balanced charge-sustaining fuel consumption $FC_{CS,nb}$, kg/100 km	Charge-sustaining fuel consumption according to paragraph 2.2.6. of Appendix 7. to this Sub-Annex	$FC_{CS,c,1}$, kg/100 km;	1
Output from step no. 1 of this Table.	$FC_{CS,c,1}$, kg/100 km;	REESS electric energy change correction Sub-Annex 8, paragraphs 4.2.1.2.2. to 4.2.1.2.3. inclusive of this Sub-Annex	$FC_{CS,c,2}$, kg/100 km;	2

▼ B▼ M3

Source	Input	Process	Output	Step no.
Output from step No. 2 of this table.	$FC_{CS,e,2}$, kg/100 km.	$FC_{CS,e,3} = FC_{CS,e,2}$	$FC_{CS,e,3}$, kg/100 km.	3 Result of a single test.
Output from step No. 3 of this table.	For every test: $FC_{CS,e,3}$, kg/100 km.	Averaging of tests and declared value according to paragraphs 1.2. to 1.2.3. inclusive of Sub-Annex 6.	$FC_{CS,e,4}$, kg/100 km.	4
Output from step no. 4 of this Table.	$FC_{CS,e,4}$, kg/100 km; $FC_{CS,c,declared}$, kg/100 km	Alignment of phase values. Sub-Annex 6, paragraph 1.1.2.4. And: $FC_{CS,e5} = FC_{CS,c,declared}$	$FC_{CS,e,5}$, kg/100 km;	5 ' FC_{CS} results of a Type 1 test for a test vehicle'

▼ B

4.2.1.2.2. In the case that the correction according to paragraph 1.1.4. of Appendix 2 to this Sub-Annex was not applied, the following charge-sustaining fuel consumption shall be used:

$$FC_{CS} = FC_{CS,nb}$$

where:

FC_{CS} is the charge-sustaining fuel consumption of the charge-sustaining Type 1 test according to Table A8/7, step no. 2, kg/100 km;

$FC_{CS,nb}$ is the non-balanced charge-sustaining fuel consumption of the charge-sustaining Type 1 test, not corrected for the energy balance, according to Table A8/7, step no. 1, kg/100 km.

▼B

- 4.2.1.2.3. If the correction of the fuel consumption is required according to paragraph 1.1.3. of Appendix 2 to this Sub-Annex or in the case that the correction according to paragraph 1.1.4. of Appendix 2 to this Sub-Annex was applied, the fuel consumption correction coefficient shall be determined according to paragraph 2. of Appendix 2 to this Sub-Annex. The corrected charge-sustaining fuel consumption shall be determined using the following equation:

$$FC_{CS} = FC_{CS,nb} - K_{fuel,FCHV} \times EC_{DC,CS}$$

where:

FC_{CS} is the charge-sustaining fuel consumption of the charge-sustaining Type 1 test according to Table A8/7, step no. 2, kg/100 km;

$FC_{CS,nb}$ is the non-balanced fuel consumption of the charge-sustaining Type 1 test, not corrected for the energy balance, according to Table A8/7, step no. 1, kg/100 km;

$EC_{DC,CS}$ is the electric energy consumption of the charge-sustaining Type 1 test according to paragraph 4.3. of this Sub-Annex, Wh/km;

$K_{fuel,FCHV}$ is the fuel consumption correction coefficient according to paragraph 2.3.1. of Appendix 2 to this Sub-Annex, (kg/100 km)/(Wh/km).

- 4.2.2. Utility factor-weighted charge-depleting fuel consumption for OVC-HEVs

The utility factor-weighted charge-depleting fuel consumption FC_{CD} shall be calculated using the following equation:

$$FC_{CD} = \frac{\sum_{j=1}^k (UF_j \times FC_{CD,j})}{\sum_{j=1}^k UF_j}$$

where:

FC_{CD} is the utility factor weighted charge-depleting fuel consumption, l/100 km;

$FC_{CD,j}$ is the fuel consumption for phase j of the charge-depleting Type 1 test, determined according to paragraph 6. of Sub-Annex 7, l/100 km;

UF_j is the utility factor of phase j according to Appendix 5 of this Sub-Annex;

▼ B

- j is the index number of the phase considered;
- k is the number of phases driven up to the end of the transition cycle according to paragraph 3.2.4.4 of this Sub-Annex.

▼ M3

In the case that the interpolation method is applied, k shall be the number of phases driven up to the end of the transition cycle of vehicle L n_{veh_L} .

If the transition cycle number driven by vehicle H, n_{vehH} , and, if applicable, by an individual vehicle within the vehicle interpolation family, n_{vehind} , is lower than the transition cycle number driven by vehicle L n_{veh_L} the confirmation cycle of vehicle H and, if applicable, an individual vehicle shall be included in the calculation. The fuel consumption of each phase of the confirmation cycle shall be calculated in accordance with paragraph 6. of Sub-Annex 7 with the criteria emission over the complete confirmation cycle and the applicable CO₂ phase value which shall be corrected to an electric energy consumption of zero, $EC_{DC,CD,j} = 0$, by using the CO₂ mass correction coefficient (K_{CO_2}) in accordance with Appendix 2 to this Sub-Annex.

▼ B

4.2.3. Utility factor-weighted fuel consumption for OVC-HEVs

The utility factor-weighted fuel consumption from the charge-depleting and charge-sustaining Type 1 test shall be calculated using the following equation:

$$FC_{weighted} = \sum_{j=1}^k (UF_j \times FC_{CD,j}) + (1 - \sum_{j=1}^k UF_j) \times FC_{CS}$$

where:

$FC_{weighted}$ is the utility factor-weighted fuel consumption, l/100 km;

UF_j is the utility factor of phase j according to Appendix 5 of this Sub-Annex;

$FC_{CD,j}$ is the fuel consumption of phase j of the charge-depleting Type 1 test, determined according to paragraph 6. of Sub-Annex 7, l/100 km;

FC_{CS} is the fuel consumption determined according to Table A8/6, step no. 1, l/100 km;

j is the index number of the phase considered;

k is the number of phases driven up to the end of the transition cycle according to paragraph 3.2.4.4. of this Sub-Annex.

▼ M3

In the case that the interpolation method is applied, k shall be the number of phases driven up to the end of the transition cycle of vehicle L n_{veh_L} .

If the transition cycle number driven by vehicle H, n_{vehH} , and, if applicable, by an individual vehicle within the vehicle interpolation family n_{vehind} is lower than the transition cycle number driven by vehicle L, n_{veh_L} , the confirmation cycle of vehicle H and, if applicable, an individual vehicle shall be included in the calculation.

▼ M3

The fuel consumption of each phase of the confirmation cycle shall be calculated in accordance with paragraph 6. of Sub-Annex 7 with the criteria emission over the complete confirmation cycle and the applicable CO₂ phase value which shall be corrected to an electric energy consumption of zero $EC_{DC,CDj} = 0$ by using the CO₂ mass correction coefficient (K_{CO_2}) in accordance with Appendix 2 to this Sub-Annex.

▼ B

4.3. Calculation of electric energy consumption

For the determination of the electric energy consumption based on the current and voltage determined according to Appendix 3 of this Sub-Annex, the following equations shall be used:

$$EC_{DC,j} = \frac{\Delta E_{REESS,j}}{d_j}$$

where:

$EC_{DC,j}$ is the electric energy consumption over the considered period j based on the REESS depletion, Wh/km;

$\Delta E_{REESS,j}$ is the electric energy change of all REESSs during the considered period j, Wh;

d_j is the distance driven in the considered period j, km;

and

$$\Delta E_{REESS,j} = \sum_{i=1}^n \Delta E_{REESS,j,i}$$

where:

$\Delta E_{REESS,j,i}$ is the electric energy change of REESS i during the considered period j, Wh;

and

$$\Delta E_{REESS,j,i} = \frac{1}{3600} \times \int_{t_0}^{t_{end}} U(t)_{REESS,j,i} \times I(t)_{j,i} dt$$

where:

$U(t)_{REESS,j,i}$ is the voltage of REESS i during the considered period j determined according to Appendix 3 to this Sub-Annex, V;

t_0 is the time at the beginning of the considered period j, s;

t_{end} is the time at the end of the considered period j, s;

$I(t)_{j,i}$ is the electric current of REESS i during the considered period j determined according to Appendix 3 to this Sub-Annex, A;

▼ B

- i is the index number of the considered REESS;
- n is the total number of REESS;
- j is the index for the considered period, where a period can be any combination of phases or cycles;
- $\frac{1}{3600}$ is the conversion factor from Ws to Wh.

▼ M3

- 4.3.1. Utility factor-weighted charge-depleting electric energy consumption based on the recharged electric energy from the mains for OVC-HEVs

The utility factor-weighted charge-depleting electric energy consumption based on the recharged electric energy from the mains shall be calculated using the following equation:

$$EC_{AC,CD} = \frac{\sum_{j=1}^k (UF_j \times EC_{AC,CD,j})}{\sum_{j=1}^k UF_j}$$

where:

$EC_{AC,CD}$ is the utility factor-weighted charge-depleting electric energy consumption based on the recharged electric energy from the mains, Wh/km;

UF_j is the utility factor of phase j in accordance with Appendix 5 to this Sub-Annex;

$EC_{AC,CD,j}$ is the electric energy consumption based on the recharged electric energy from the mains of phase j, Wh/km;

and

$$EC_{AC,CD,j} = EC_{DC,CD,j} \times \frac{E_{AC}}{\sum_{j=1}^k \Delta E_{REESS,j}}$$

where:

$EC_{DC,CD,j}$ is the electric energy consumption based on the REESS depletion of phase j of the charge-depleting Test 1 in accordance with paragraph 4.3. of this Sub-Annex, Wh/km;

E_{AC} is the recharged electric energy from the mains determined in accordance with paragraph 3.2.4.6. of this Sub-Annex, Wh;

$\Delta E_{REESS,j}$ is the electric energy change of all REESSs of phase j in accordance with paragraph 4.3. of this Sub-Annex, Wh;

j is the index number for the considered phase;

k is the number of phases driven up to the end of the transition cycle in accordance with paragraph 3.2.4.4. of this Sub-Annex.

In the case that the interpolation method is applied, k is the number of phases driven up to the end of the transition cycle of L, n_{veh_L} .

▼ B

- 4.3.2. Utility factor-weighted electric energy consumption based on the recharged electric energy from the mains for OVC-HEVs

The utility factor-weighted electric energy consumption based on the recharged electric energy from the mains shall be calculated using the following equation:

$$EC_{AC,weighted} = \sum_{j=1}^k (UF_j \times EC_{AC,CD,j})$$

where:

$EC_{AC,weighted}$ is the utility factor-weighted electric energy consumption based on the recharged electric energy from the mains, Wh/km;

UF_j is the utility factor of phase j according to Appendix 5 of this Sub-Annex;

$EC_{AC,CD,j}$ is the electric energy consumption based on the recharged electric energy from the mains of phase j according to paragraph 4.3.1. of this Sub-Annex, Wh/km;

j is the index number of the phase considered;

▼ M3

k is the number of phases driven up to the end of the transition cycle in accordance with paragraph 3.2.4.4. of this Sub-Annex.

in the case that the interpolation method is applied, k is the number of phases driven up to the end of the transition cycle of vehicle L, $n_{veh,L}$.

▼ B

- 4.3.3. Electric energy consumption for OVC-HEVs

- 4.3.3.1. Determination of cycle-specific electric energy consumption

The electric energy consumption based on the recharged electric energy from the mains and the equivalent all-electric range shall be calculated using the following equation:

$$EC = \frac{E_{AC}}{EAER}$$

where:

EC is the electric energy consumption of the applicable WLTP test cycle based on the recharged electric energy from the mains and the equivalent all-electric range, Wh/km;

E_{AC} is the recharged electric energy from the mains according to paragraph 3.2.4.6. of this Sub-Annex, Wh;

EAER is the equivalent all-electric range according to paragraph 4.4.4.1. of this Sub-Annex, km.

▼ B

4.3.3.2. Determination of phase-specific electric energy consumption

The phase-specific electric energy consumption based on the recharged electric energy from the mains and the phase-specific equivalent all-electric range shall be calculated using the following equation:

$$EC_p = \frac{E_{AC}}{EAER_p}$$

where:

EC_p : is the phase-specific electric energy consumption based on the recharged electric energy from the mains and the equivalent all-electric range, Wh/km;

E_{AC} : is the recharged electric energy from the mains according to paragraph 3.2.4.6. of this Sub-Annex, Wh;

$EAER_p$: is the phase-specific equivalent all-electric range according to paragraph 4.4.4.2. of this Sub-Annex, km.

4.3.4. Electric energy consumption of PEVs

▼ M3

4.3.4.1. The electric energy consumption determined in this paragraph shall be calculated only if the vehicle was able to follow the applicable test cycle within the speed trace tolerances in accordance with paragraph 2.6.8.3. of Sub-Annex 6 during the entire considered period.

▼ B

4.3.4.2. Electric energy consumption determination of the applicable WLTP test cycle

The electric energy consumption of the applicable WLTP test cycle based on the recharged electric energy from the mains and the pure electric range shall be calculated using the following equation:

$$EC_{WLTC} = \frac{E_{AC}}{PER_{WLTC}}$$

where:

EC_{WLTC} is the electric energy consumption of the applicable WLTP test cycle based on the recharged electric energy from the mains and the pure electric range for the applicable WLTP test cycle, Wh/km;

E_{AC} is the recharged electric energy from the mains according to paragraph 3.4.4.3. of this Sub-Annex, Wh;

PER_{WLTC} is the pure electric range for the applicable WLTP test cycle as calculated according to paragraph 4.4.2.1.1. or paragraph 4.4.2.2.1. of this Sub-Annex, depending on the PEV test procedure that must be used, km.

▼ B

4.3.4.3. Electric energy consumption determination of the applicable WLTP city test cycle

The electric energy consumption of the applicable WLTP city test cycle based on the recharged electric energy from the mains and the pure electric range for the applicable WLTP city test cycle shall be calculated using the following equation:

$$EC_{\text{city}} = \frac{E_{\text{AC}}}{\text{PER}_{\text{city}}}$$

where:

EC_{city} is the electric energy consumption of the applicable WLTP city test cycle based on the recharged electric energy from the mains and the pure electric range for the applicable WLTP city test cycle, Wh/km;

E_{AC} is the recharged electric energy from the mains according to paragraph 3.4.4.3. of this Sub-Annex, Wh;

PER_{city} is the pure electric range for the applicable WLTP city test cycle as calculated according to paragraph 4.4.2.1.2. or paragraph 4.4.2.2.2. of this Sub-Annex, depending on the PEV test procedure that must be used, km.

4.3.4.4. Electric energy consumption determination of the phase-specific values

The electric energy consumption of each individual phase based on the recharged electric energy from the mains and the phase-specific pure electric range shall be calculated using the following equation:

$$EC_p = \frac{E_{\text{AC}}}{\text{PER}_p}$$

where:

EC_p is the electric energy consumption of each individual phase p based on the recharged electric energy from the mains and the phase-specific pure electric range, Wh/km

E_{AC} is the recharged electric energy from the mains according to paragraph 3.4.4.3. of this Sub-Annex, Wh;

PER_p is the phase-specific pure electric range as calculated according to paragraph 4.4.2.1.3. or paragraph 4.4.2.2.3. of this Sub-Annex, depending on the PEV test procedure used, km.

4.4. Calculation of electric ranges

4.4.1. All-electric ranges AER and AER_{city} for OVC-HEVs

4.4.1.1. All-electric range AER

▼ B

The all-electric range AER for OVC-HEVs shall be determined from the charge-depleting Type 1 test described in paragraph 3.2.4.3. of this Sub-Annex as part of the Option 1 test sequence and is referenced in paragraph 3.2.6.1. of this Sub-Annex as part of the Option 3 test sequence by driving the applicable WLTP test cycle according to paragraph 1.4.2.1. of this Sub-Annex. The AER is defined as the distance driven from the beginning of the charge-depleting Type 1 test to the point in time where the combustion engine starts consuming fuel.

4.4.1.2. All-electric range city AER_{city}

4.4.1.2.1. The all-electric range city AER_{city} for OVC-HEVs shall be determined from the charge-depleting Type 1 test described in paragraph 3.2.4.3. of this Sub-Annex as part of the Option 1 test sequence and is referenced in paragraph 3.2.6.1. of this Sub-Annex as part of the Option 3 test sequence by driving the applicable WLTP city test cycle according to paragraph 1.4.2.2. of this Sub-Annex. The AER_{city} is defined as the distance driven from the beginning of the charge-depleting Type 1 test to the point in time where the combustion engine starts consuming fuel.

4.4.1.2.2. As an alternative to paragraph 4.4.1.2.1. of this Sub-Annex, the all-electric range city AER_{city} may be determined from the charge-depleting Type 1 test described in paragraph 3.2.4.3. of this Sub-Annex by driving the applicable WLTP test cycles according to paragraph 1.4.2.1. of this Sub-Annex. In that case, the charge-depleting Type 1 test by driving the applicable WLTP city test cycle shall be omitted and the all-electric range city AER_{city} shall be calculated using the following equation:

$$AER_{city} = \frac{UBE_{city}}{EC_{DC,city}}$$

where:

UBE_{city} is the usable REESS energy determined from the beginning of the charge-depleting Type 1 test described in paragraph 3.2.4.3. of this Sub-Annex by driving applicable WLTP test cycles until the point in time where the combustion engine starts consuming fuel, Wh;

$EC_{DC,city}$ is the weighted electric energy consumption of the pure electrically driven applicable WLTP city test cycles of the charge-depleting Type 1 test described in paragraph 3.2.4.3. of this Sub-Annex by driving applicable WLTP test cycle(s), Wh/km;

and

▼ M3

$$UBE_{city} = \sum_{j=1}^{k+1} \Delta E_{REESS,j}$$

where:

▼ M3

- $\Delta E_{\text{REESS},j}$ is the electric energy change of all REESSs during phase j , Wh;
- j is the index number of the considered phase;
- $k + 1$ is the number of the phases driven from the beginning of the test until the point in time when the combustion engine starts consuming fuel;

▼ B

and

$$EC_{\text{DC},\text{city}} = \sum_{j=1}^{n_{\text{city,pe}}} EC_{\text{DC},\text{city},j} \times K_{\text{city},j}$$

where:

- $EC_{\text{DC},\text{city},j}$ is the electric energy consumption for the j th pure electrically driven WLTP city test cycle of the charge-depleting Type 1 test according to paragraph 3.2.4.3. of this Sub-Annex by driving applicable WLTP test cycles, Wh/km;
- $K_{\text{city},j}$ is the weighting factor for the j th pure electrically driven applicable WLTP city test cycle of the charge-depleting Type 1 test according to paragraph 3.2.4.3. of this Sub-Annex by driving applicable WLTP test cycles;
- j is the index number of the pure electrically driven applicable WLTP city test cycle considered;
- $n_{\text{city,pe}}$ is the number of pure electrically driven applicable WLTP city test cycles;

and

$$K_{\text{city},1} = \frac{\Delta E_{\text{REESS},\text{city},1}}{UBE_{\text{city}}}$$

where:

- $\Delta E_{\text{REESS},\text{city},1}$ is the electric energy change of all REESSs during the first applicable WLTP city test cycle of the charge-depleting Type 1 test, Wh;

and

$$K_{\text{city},j} = \frac{1 - K_{\text{city},1}}{n_{\text{city,pe}} - 1} \text{ for } j = 2 \text{ to } n_{\text{city,pe}}.$$

▼ M3

4.4.2. Pure electric range for PEVs

The ranges determined in this paragraph shall only be calculated if the vehicle was able to follow the applicable WLTP test cycle within the speed trace tolerances in accordance with paragraph 2.6.8.3. of Sub-Annex 6 during the entire considered period.

▼ B

4.4.2.1. Determination of the pure electric ranges when the shortened Type 1 test procedure is applied

▼ B

4.4.2.1.1. The pure -electric range for the applicable WLTP test cycle PER_{WLTC} for PEVs shall be calculated from the shortened Type 1 test as described in paragraph 3.4.4.2. of this Sub-Annex using the following equations:

$$PER_{WLTC} = \frac{UBE_{STP}}{EC_{DC,WLTC}}$$

where:

UBE_{STP} is the usable REESS energy determined from the beginning of the shortened Type 1 test procedure until the break-off criterion as defined in paragraph 3.4.4.2.3. of this Sub-Annex is reached, Wh;

$EC_{DC,WLTC}$ is the weighted electric energy consumption for the applicable WLTP test cycle of DS_1 and DS_2 of the shortened Type 1 test procedure Type 1 test, Wh/km;

and

$$UBE_{STP} = \Delta E_{REESS,DS_1} + \Delta E_{REESS,DS_2} + \Delta E_{REESS,CSS_M} + \Delta E_{REESS,CSS_E}$$

where:

$\Delta E_{REESS,DS_1}$ is the electric energy change of all REESSs during DS_1 of the shortened Type 1 test procedure, Wh;

$\Delta E_{REESS,DS_2}$ is the electric energy change of all REESSs during DS_2 of the shortened Type 1 test procedure, Wh;

$\Delta E_{REESS,CSS_M}$ is the electric energy change of all REESSs during CSS_M of the shortened Type 1 test procedure, Wh;

$\Delta E_{REESS,CSS_E}$ is the electric energy change of all REESSs during CSS_E of the shortened Type 1 test procedure, Wh;

and

$$EC_{DC,WLTC} = \sum_{j=1}^2 EC_{DC,WLTC,j} \times K_{WLTC,j}$$

where:

▼ M3

$EC_{DC,WLTC,j}$ is the electric energy consumption for the applicable WLTP test cycle of DS_j of the shortened Type 1 test procedure according to paragraph 4.3. of this Sub-Annex, Wh/km;

▼ B

$k_{WLTC,j}$ is the weighting factor for the applicable WLTP test cycle of DS_j of the shortened Type 1 test procedure;

▼ B

and

$$K_{\text{WLTC},1} = \frac{\Delta E_{\text{REESS,WLTC},1}}{U\text{BE}_{\text{STP}}} \text{ and } K_{\text{WLTC},2} = 1 - K_{\text{WLTC},1}$$

where:

$K_{\text{WLTC},j}$ is the weighting factor for the applicable WLTP test cycle of DS_j of the shortened Type 1 test procedure;

$\Delta E_{\text{REESS,WLTC},1}$ is the electric energy change of all REESSs during the applicable WLTP test cycle from DS_1 of the shortened Type 1 test procedure, Wh;

4.4.2.1.2. The pure electric range for the applicable WLTP city test cycle PER_{city} for PEVs shall be calculated from the shortened Type 1 test procedure as described in paragraph 3.4.4.2. of this Sub-Annex using the following equations:

$$\text{PER}_{\text{city}} = \frac{U\text{BE}_{\text{STP}}}{\text{EC}_{\text{DC,city}}}$$

where:

$U\text{BE}_{\text{STP}}$ is the usable REESS energy according to paragraph 4.4.2.1.1. of this Sub-Annex, Wh;

$\text{EC}_{\text{DC,city}}$ is the weighted electric energy consumption for the applicable WLTP city test cycle of DS_1 and DS_2 of the shortened Type 1 test procedure, Wh/km;

and

$$\text{EC}_{\text{DC,city}} = \sum_{j=1}^4 \text{EC}_{\text{DC,city},j} \times K_{\text{city},j}$$

where:

$\text{EC}_{\text{DC,city},j}$ is the electric energy consumption for the applicable WLTP city test cycle where the first applicable WLTP city test cycle of DS_1 is indicated as $j = 1$, the second applicable WLTP city test cycle of DS_1 is indicated as $j = 2$, the first applicable WLTP city test cycle of DS_2 is indicated as $j = 3$ and the second applicable WLTP city test cycle of DS_2 is indicated as $j = 4$ of the shortened Type 1 test procedure according to paragraph 4.3. of this Sub-Annex, Wh/km;

$K_{\text{city},j}$ is the weighting factor for the applicable WLTP city test cycle where the first applicable WLTP city test cycle of DS_1 is indicated as $j = 1$, the second applicable WLTP city test cycle of DS_1 is indicated as $j = 2$, the first applicable WLTP city test cycle of DS_2 is indicated as $j = 3$ and the second applicable WLTP city test cycle of DS_2 is indicated as $j = 4$,

▼ B

and

$$K_{\text{city},1} = \frac{\Delta E_{\text{REESS,city},1}}{UBE_{\text{STP}}} \text{ and } K_{\text{city},j} = \frac{1 - K_{\text{city},1}}{3} \text{ for } j = 2 \dots 4$$

where:

$\Delta E_{\text{REESS,city},1}$ is the energy change of all REESSs during the first applicable WLTP city test cycle of DS₁ of the shortened Type 1 test procedure, Wh;

- 4.4.2.1.3. The phase-specific pure electric-range PER_p for PEVs shall be calculated from the Type 1 test as described in paragraph 3.4.4.2. of this Sub-Annex by using the following equations:

$$PER_p = \frac{UBE_{\text{STP}}}{EC_{\text{DC},p}}$$

where:

▼ M3

UBE_{STP} is the usable REESS energy in accordance with paragraph 4.4.2.1.1. of this Sub-Annex, Wh;

▼ B

EC_{DC,p} is the weighted electric energy consumption for each individual phase of DS₁ and DS₂ of the shortened Type 1 test procedure, Wh/km;

In the case that phase p = low and phase p = medium, the following equations shall be used:

$$EC_{\text{DC},p} = \sum_{j=1}^4 EC_{\text{DC},p,j} \times K_{p,j}$$

where:

EC_{DC,p,j} is the electric energy consumption for phase p where the first phase p of DS₁ is indicated as j = 1, the second phase p of DS₁ is indicated as j = 2, the first phase p of DS₂ is indicated as j = 3 and the second phase p of DS₂ is indicated as j = 4 of the shortened Type 1 test procedure according to paragraph 4.3. of this Sub-Annex, Wh/km;

K_{p,j} is the weighting factor for phase p where the first phase p of DS₁ is indicated as j = 1, the second phase p of DS₁ is indicated as j = 2, the first phase p of DS₂ is indicated as j = 3, and the second phase p of DS₂ is indicated as j = 4 of the shortened Type 1 test procedure;

and

$$K_{p,1} = \frac{\Delta E_{\text{REESS,p},1}}{UBE_{\text{STP}}} \text{ and } K_{p,j} = \frac{1 - K_{p,1}}{3} \text{ for } j = 2 \dots 4$$

where:

$\Delta E_{\text{REESS,p},1}$: is the energy change of all REESSs during the first phase p of DS₁ of the shortened Type 1 test procedure, Wh.

▼ B

In the case that phase $p = \text{high}$ and phase $p = \text{extraHigh}$, the following equations shall be used:

$$EC_{DC,p} = \sum_{j=1}^2 EC_{DC,p,j} \times K_{p,j}$$

where:

$EC_{DC,p,j}$ is the electric energy consumption for phase p of DS_j of the shortened Type 1 test procedure according to paragraph 4.3. of this Sub-Annex, Wh/km;

$k_{p,j}$ is the weighting factor for phase p of DS_j of the shortened Type 1 test procedure

and

$$K_{p,1} = \frac{\Delta E_{REESS,p,1}}{UBE_{STP}} \text{ and } K_{p,2} = 1 - K_{p,1}$$

where:

$\Delta E_{REESS,p,1}$ is the electric energy change of all REESSs during the first phase p of DS_1 of the shortened Type 1 test procedure, Wh.

4.4.2.2. Determination of the pure electric ranges when the consecutive cycle Type 1 test procedure is applied

4.4.2.2.1. The pure electric range for the applicable WLTP test cycle PER_{WLTP} for PEVs shall be calculated from the Type 1 test as described in paragraph 3.4.4.1. of this Sub-Annex using the following equations:

$$PER_{WLTC} = \frac{UBE_{CCP}}{EC_{DC,WLTC}}$$

where:

UBE_{CCP} is the usable REESS energy determined from the beginning of the consecutive cycle Type 1 test procedure until the break-off criterion according to paragraph 3.4.4.1.3. of this Sub-Annex is reached, Wh;

$EC_{DC,WLTC}$ is the electric energy consumption for the applicable WLTP test cycle determined from completely driven applicable WLTP test cycles of the consecutive cycle Type 1 test procedure, Wh/km;

and

$$UBE_{CCP} = \sum_{j=1}^k \Delta E_{REESS,j}$$

▼ B

where:

$\Delta E_{\text{REESS},j}$ is the electric energy change of all REESSs during phase j of the consecutive cycle Type 1 test procedure, Wh;

j is the index number of the phase considered;

k is the number of phases driven from the beginning up to and including the phase where the break-off criterion is reached;

and

$$EC_{\text{DC,WLTC}} = \sum_{j=1}^{n_{\text{WLTC}}} EC_{\text{DC,WLTC},j} \times K_{\text{WLTC},j}$$

where:

$EC_{\text{DC,WLTC},j}$ is the electric energy consumption for the applicable WLTP test cycle j of the consecutive cycle Type 1 test procedure according to paragraph 4.3. of this Sub-Annex, Wh/km;

$K_{\text{WLTC},j}$ is the weighting factor for the applicable WLTP test cycle j of the consecutive cycle Type 1 test procedure;

j is the index number of the applicable WLTP test cycle;

n_{WLTC} is the whole number of complete applicable WLTP test cycles driven;

and

$$K_{\text{WLTC},1} = \frac{\Delta E_{\text{REESS,WLTC},1}}{UBE_{\text{CCP}}} \text{ and } K_{\text{WLTC},j} = \frac{1 - K_{\text{WLTC},1}}{n_{\text{WLTC}} - 1} \text{ for } j = 2 \dots n_{\text{WLTC}}$$

where:

$\Delta E_{\text{REESS,WLTC},1}$ is the electric energy change of all REESSs during the first applicable WLTP test cycle of the consecutive Type 1 test cycle procedure, Wh.

4.4.2.2.2. The pure electric range for the WLTP city test cycle PER_{city} for PEVs shall be calculated from the Type 1 test as described in paragraph 3.4.4.1. of this Sub-Annex using the following equations:

$$PER_{\text{city}} = \frac{UBE_{\text{CCP}}}{EC_{\text{DC,city}}}$$

where:

UBE_{CCP} is the usable REESS energy according to paragraph 4.4.2.2.1. of this Sub-Annex, Wh;

▼ B

$EC_{DC,city}$ is the electric energy consumption for the applicable WLTP city test cycle determined from completely driven applicable WLTP city test cycles of the consecutive cycle Type 1 test procedure, Wh/km;

and

$$EC_{DC,city} = \sum_{j=1}^{n_{city}} EC_{DC,city,j} \times K_{city,j}$$

where:

$EC_{DC,city,j}$ is the electric energy consumption for the applicable WLTP city test cycle j of the consecutive cycle Type 1 test procedure according to paragraph 4.3. of this Sub-Annex, Wh/km;

$K_{city,j}$ is the weighting factor for the applicable WLTP city test cycle j of the consecutive cycle Type 1 test procedure;

j is the index number of the applicable WLTP city test cycle;

n_{city} is the whole number of complete applicable WLTP city test cycles driven;

and

$$K_{city,1} = \frac{\Delta E_{REESS,city,1}}{UBE_{CCP}} \text{ and } K_{city,j} = \frac{1 - K_{city,1}}{n_{city} - 1} \text{ for } j = 2 \dots n_{city}$$

where:

$\Delta E_{REESS,city,1}$ is the electric energy change of all REESSs during the first applicable WLTP city test cycle of the consecutive cycle Type 1 test procedure, Wh.

4.4.2.2.3. The phase-specific pure electric-range PER_p for PEVs shall be calculated from the Type 1 test as described in paragraph 3.4.4.1. of this Sub-Annex using the following equations:

$$PER_p = \frac{UBE_{CCP}}{EC_{DC,p}}$$

where:

UBE_{CCP} is the usable REESS energy according to paragraph 4.4.2.2.1. of this Sub-Annex, Wh;

$EC_{DC,p}$ is the electric energy consumption for the considered phase p determined from completely driven phases p of the consecutive cycle Type 1 test procedure, Wh/km;

▼ B

and

$$EC_{DC,p} = \sum_{j=1}^{n_p} EC_{DC,p,j} \times K_{p,j}$$

where:

$EC_{DC,p,j}$ is the j th electric energy consumption for the considered phase p of the consecutive cycle Type 1 test procedure according to paragraph 4.3. of this Sub-Annex, Wh/km;

$k_{p,j}$ is the j th weighting factor for the considered phase p of the consecutive cycle Type 1 test procedure;

j is the index number of the considered phase p ;

n_p is the whole number of complete WLTC phases p driven;

and

$$K_{p,1} = \frac{\Delta E_{REESS,p,1}}{UBE_{CCP}} \text{ and } K_{p,j} = \frac{1 - K_{p,1}}{n_p - 1} \text{ for } j = 2 \dots n_p$$

where:

$\Delta E_{REESS,p,1}$ is the electric energy change of all REESSs during the first driven phase p during the consecutive cycle Type 1 test procedure, Wh.

4.4.3. Charge-depleting cycle range for OVC-HEVs

The charge-depleting cycle range R_{CDC} shall be determined from the charge-depleting Type 1 test described in paragraph 3.2.4.3. of this Sub-Annex as part of the Option 1 test sequence and is referenced in paragraph 3.2.6.1. of this Sub-Annex as part of the Option 3 test sequence. The R_{CDC} is the distance driven from the beginning of the charge-depleting Type 1 test to the end of the transition cycle according to paragraph 3.2.4.4 of this Sub-Annex.

4.4.4. Equivalent all-electric range for OVC-HEVs

4.4.4.1. Determination of cycle-specific equivalent all-electric range

The cycle-specific equivalent all-electric range shall be calculated using the following equation:

$$EAER = \left(\frac{M_{CO_2,CS} - M_{CO_2,CD,avg}}{M_{CO_2,CS}} \right) \times R_{CDC}$$

where:

EAER is the cycle-specific equivalent all-electric range, km;

▼ B

$M_{CO_2,CS}$ is the charge-sustaining CO₂ mass emission according to Table A8/5, step no. 7, g/km;

$M_{CO_2,CD,avg}$ is the arithmetic average charge-depleting CO₂ mass emission according to the equation below, g/km;

R_{CDC} is the charge-depleting cycle range according to paragraph 4.4.2. of this Sub-Annex, km;

and

$$M_{CO_2,CD,avg} = \frac{\sum_{j=1}^k (M_{CO_2,CD,j} \times d_j)}{\sum_{j=1}^k d_j}$$

where:

$M_{CO_2,CD,avg}$ is the arithmetic average charge-depleting CO₂ mass emission, g/km;

$M_{CO_2,CD,j}$ is the CO₂ mass emission determined according to paragraph 3.2.1. of Sub-Annex 7 of phase j of the charge-depleting Type 1 test, g/km;

d_j is the distance driven in phase j of the charge-depleting Type 1 test, km;

j is the index number of the considered phase;

k is the number of phases driven up to the end of the transition cycle n according to paragraph 3.2.4.4 of this Sub-Annex.

▼ M3

4.4.4.2. Determination of the phase-specific and city equivalent all-electric range

The phase-specific and city equivalent all-electric range shall be calculated using the following equation:

$$EAER_p = \left(\frac{M_{CO_2,CS,p} - M_{CO_2,CD,avg,p}}{M_{CO_2,CS,p}} \right) \times \frac{\sum_{j=1}^k \Delta E_{REESS,j}}{EC_{DC,CD,p}}$$

where:

$EAER_p$ is the equivalent all-electric range for the considered period p, km;

$M_{CO_2,CS,p}$ is the phase-specific CO₂ mass emission from the charge-sustaining Type 1 test for the considered period p according to Table A8/5, step no. 7, g/km;

$\Delta E_{REESS,j}$ are the electric energy changes of all REESSs during the considered phase j, Wh;

$EC_{DC,CD,p}$ is the electric energy consumption over the considered period p based on the REESS depletion, Wh/km;

j is the index number of the considered phase;

▼ **M3**

k is the number of phases driven up to the end of the transition cycle n according to paragraph 3.2.4.4 of this Sub-Annex;

and

$$M_{\text{CO}_2,\text{CD,avg,p}} = \frac{\sum_{c=1}^{n_c} (M_{\text{CO}_2,\text{CD,p,c}} \times d_{p,c})}{\sum_{c=1}^{n_c} d_{p,c}}$$

where:

$M_{\text{CO}_2,\text{CD,avg,p}}$ is the arithmetic average charge-depleting CO₂ mass emission for the considered period p, g/km;

$M_{\text{CO}_2,\text{CD,p,c}}$ is the CO₂ mass emission determined according to paragraph 3.2.1. of Sub-Annex 7 of period p in cycle c of the charge-depleting Type 1 test, g/km;

$d_{p,c}$ is the distance driven in the considered period p of cycle c of the charge-depleting Type 1 test, km;

c is the index number of the considered applicable WLTP test cycle;

p is the index of the individual period within the applicable WLTP test cycle;

n_c is the number of applicable WLTP test cycles driven up to the end of the transition cycle n according to paragraph 3.2.4.4. of this Sub-Annex;

and

$$EC_{\text{DC,CD,p}} = \frac{\sum_{c=1}^{n_c} EC_{\text{DC,CD,p,c}} \times d_{p,c}}{\sum_{c=1}^{n_c} d_{p,c}}$$

where:

$EC_{\text{DC,CD,p}}$ is the electric energy consumption of the considered period p based on the REESS depletion of the charge-depleting Type 1 test, Wh/km;

$EC_{\text{DC,CD,p,c}}$ is the electric energy consumption of the considered period p of cycle c based on the REESS depletion of the charge-depleting Type 1 test according to paragraph 4.3. of this Sub-Annex, Wh/km;

$d_{p,c}$ is the distance driven in the considered period p of cycle c of the charge-depleting Type 1 test, km;

c is the index number of the considered applicable WLTP test cycle;

p is the index of the individual period within the applicable WLTP test cycle;

n_c is the number of applicable WLTP test cycles driven up to the end of the transition cycle n according to paragraph 3.2.4.4. of this Sub-Annex.

The considered phase values shall be the low-phase, medium-phase, high-phase, extra high-phase, and the city driving cycle.

▼ B

4.4.5. Actual charge-depleting range for OVC-HEVs

The actual charge-depleting range shall be calculated using the following equation:

$$R_{CDA} = \sum_{c=1}^{n-1} d_c + \left(\frac{M_{CO_2,CS} - M_{CO_2,n,cycle}}{M_{CO_2,CS} - M_{CO_2,CD,avg,n-1}} \right) \times d_n$$

where:

- R_{CDA} is the actual charge-depleting range, km;
- $M_{CO_2,CS}$ is the charge-sustaining CO₂ mass emission according to Table A8/5, step no. 7, g/km;
- $M_{CO_2,n,cycle}$ is the CO₂ mass emission of the applicable WLTP test cycle n of the charge-depleting Type 1 test, g/km;
- $M_{CO_2,CD,avg,n-1}$ is the arithmetic average CO₂ mass emission of the charge-depleting Type 1 test from the beginning up to and including the applicable WLTP test cycle (n-1), g/km;
- d_c is the distance driven in the applicable WLTP test cycle c of the charge-depleting Type 1 test, km;
- d_n is the distance driven in the applicable WLTP test cycle n of the charge-depleting Type 1 test, km;
- c is the index number of the considered applicable WLTP test cycle;
- n is the number of applicable WLTP test cycles driven including the transition cycle according to paragraph 3.2.4.4. of this Sub-Annex;

and

$$M_{CO_2,CD,avg,n-1} = \frac{\sum_{c=1}^{n-1} (M_{CO_2,CD,c} \times d_c)}{\sum_{c=1}^{n-1} d_c}$$

where:

- $M_{CO_2,CD,avg,n-1}$ is the arithmetic average CO₂ mass emission of the charge-depleting Type 1 test from the beginning up to and including the applicable WLTP test cycle (n-1), g/km;

▼ B

$M_{CO_2,CD,c}$	is the CO ₂ mass emission determined according to paragraph 3.2.1. of Sub-Annex 7 of the applicable WLTP test cycle c of the charge-depleting Type 1 test, g/km;
d_c	is the distance driven in the applicable WLTP test cycle c of the charge-depleting Type 1 test, km;
c	is the index number of the considered applicable WLTP test cycle;
n	is the number of applicable WLTP test cycles driven including the transition cycle according to paragraph 3.2.4.4 of this Sub-Annex;

4.5. Interpolation of individual vehicle values

4.5.1. Interpolation range for NOVC-HEVs and OVC-HEVs

▼ M3

The interpolation method shall only be used if the difference in charge-sustaining CO₂ mass emission, $M_{CO_2,CS}$, according to Table A8/5, step no. 8 between test vehicles L and H is between a minimum of 5 g/km and a maximum of 20 per cent plus 5 g/km of the charge-sustaining CO₂ mass emission, $M_{CO_2,CS}$, according to Table A8/5, step no. 8 for vehicle H, but at least 15 g/km and not exceeding 20 g/km.

At the request of the manufacturer and with approval of the approval authority, the application of the interpolation method on individual vehicle values within a family may be extended if the maximum extrapolation is not more than 3 g/km above the charge-sustaining CO₂ mass emission of vehicle H and/or is not more than 3 g/km below the charge-sustaining CO₂ mass emission of vehicle L. This extension is valid only within the absolute boundaries of the interpolation range specified in this paragraph.

▼ B

The maximum absolute boundary of 20 g/km charge-sustaining CO₂ mass emission difference between vehicle L and vehicle H or 20 per cent of the charge-sustaining CO₂ mass emission for vehicle H, whichever is smaller, may be extended by 10 g/km if a vehicle M is tested. Vehicle M is a vehicle within the interpolation family with a cycle energy demand within ± 10 per cent of the arithmetic average of vehicles L and H.

The linearity of charge-sustaining CO₂ mass emission for vehicle M shall be verified against the linear interpolated charge-sustaining CO₂ mass emission between vehicle L and H.

The linearity criterion for vehicle M shall be considered fulfilled if the difference between the charge-sustaining CO₂ mass emission of

▼ B

vehicle M derived from the measurement and the interpolated charge-sustaining CO₂ mass emission between vehicle L and H is below 1 g/km. If this difference is greater, the linearity criterion shall be considered to be fulfilled if this difference is 3 g/km or 3 per cent of the interpolated charge-sustaining CO₂ mass emission for vehicle M, whichever is smaller.

▼ M3

If the linearity criterion is fulfilled, the interpolation method shall be applicable for all individual vehicles between vehicles L and H within the interpolation family.

▼ B

If the linearity criterion is not fulfilled, the interpolation family shall be split into two sub-families for vehicles with a cycle energy demand between vehicles L and M, and vehicles with a cycle energy demand between vehicles M and H.

▼ M3

For vehicles with a cycle energy demand between that of vehicles L and M, each parameter of vehicle H necessary for the application of the interpolation method on individual OVC-HEV and NOVC-HEV values, shall be substituted by the corresponding parameter of vehicle M.

For vehicles with a cycle energy demand between that of vehicles M and H, each parameter of vehicle L that is necessary for the application of the interpolation method on individual OVC-HEV and NOVC-HEV values shall be substituted by the corresponding parameter of vehicle M.

▼ B

4.5.2. Calculation of energy demand per period

The energy demand $E_{k,p}$ and distance driven $d_{c,p}$ per period p applicable for individual vehicles in the interpolation family shall be calculated according to the procedure in paragraph 5. of Sub-Annex 7, for the sets k of road load coefficients and masses according to paragraph 3.2.3.2.3. of Sub-Annex 7.

4.5.3. Calculation of the interpolation coefficient for individual vehicles $K_{ind,p}$

The interpolation coefficient $K_{ind,p}$ per period shall be calculated for each considered period p using the following equation:

$$K_{ind,p} = \frac{E_{3,p} - E_{1,p}}{E_{2,p} - E_{1,p}}$$

where:

▼ M3

$K_{ind,p}$ is the interpolation coefficient for the considered individual vehicle for period p;

$E_{1,p}$ is the energy demand for the considered period for vehicle L in accordance with paragraph 5. of Sub-Annex 7, W_s ;

▼ M3

- $E_{2,p}$ is the energy demand for the considered period for vehicle H in accordance with paragraph 5. of Sub-Annex 7, Ws;
- $3,p$ is the energy demand for the considered period for the individual vehicle in accordance with paragraph 5. of Sub-Annex 7, Ws;
- p is the index of the individual period within the applicable test cycle.

▼ B

In the case that the considered period p is the applicable WLTP test cycle, $K_{ind,p}$ is named K_{ind} .

- 4.5.4. Interpolation of the CO₂ mass emission for individual vehicles
- 4.5.4.1. Individual charge-sustaining CO₂ mass emission for OVC-HEVs and NOVC-HEVs

The charge-sustaining CO₂ mass emission for an individual vehicle shall be calculated using the following equation:

$$M_{CO_2-ind,CS,p} = M_{CO_2-L,CS,p} + K_{ind,d} \times (M_{CO_2-H,CS,p} - M_{CO_2-L,CS,p})$$

where:

$M_{CO_2-ind,CS,p}$ is the charge-sustaining CO₂ mass emission for an individual vehicle of the considered period p according to Table A8/5, step no. 9, g/km;

$M_{CO_2-L,CS,p}$ is the charge-sustaining CO₂ mass emission for vehicle L of the considered period p according to Table A8/5, step no. 8, g/km;

$M_{CO_2-H,CS,p}$ is the charge-sustaining CO₂ mass emission for vehicle H of the considered period p according to Table A8/5, step no. 8, g/km;

$K_{ind,d}$ is the interpolation coefficient for the considered individual vehicle for period p ;

p is the index of the individual period within the applicable WLTP test cycle.

▼ M3

The considered periods shall be the low phase, medium phase, high phase, extra high phase, and the applicable WLTP test cycle.

▼B4.5.4.2. Individual utility factor-weighted charge-depleting CO₂ mass emission for OVC-HEVs

The utility factor-weighted charge-depleting CO₂ mass emission for an individual vehicle shall be calculated using the following equation:

$$M_{\text{CO}_2\text{-ind,CD}} = M_{\text{CO}_2\text{-L,CD}} + K_{\text{ind}} \times (M_{\text{CO}_2\text{-H,CD}} - M_{\text{CO}_2\text{-L,CD}})$$

where:

$M_{\text{CO}_2\text{-ind,CD}}$ is the utility factor-weighted charge-depleting CO₂ mass emission for an individual vehicle, g/km;

$M_{\text{CO}_2\text{-L,CD}}$ is the utility factor-weighted charge-depleting CO₂ mass emission for vehicle L, g/km;

$M_{\text{CO}_2\text{-H,CD}}$ is the utility factor-weighted charge-depleting CO₂ mass emission for vehicle H, g/km;

K_{ind} is the interpolation coefficient for the considered individual vehicle for the applicable WLTP test cycle.

4.5.4.3. Individual utility factor-weighted CO₂ mass emission for OVC-HEVs

The utility factor-weighted CO₂ mass emission for an individual vehicle shall be calculated using the following equation:

$$M_{\text{CO}_2\text{-ind,weighted}} = M_{\text{CO}_2\text{-L,weighted}} + K_{\text{ind}} \times (M_{\text{CO}_2\text{-H,weighted}} - M_{\text{CO}_2\text{-L,weighted}})$$

where:

$M_{\text{CO}_2\text{-ind,weighted}}$ is the utility factor-weighted CO₂ mass emission for an individual vehicle, g/km;

$M_{\text{CO}_2\text{-L,weighted}}$ is the utility factor-weighted CO₂ mass emission for vehicle L, g/km;

▼ B

$M_{\text{CO}_2\text{-H,weighted}}$ is the utility factor-weighted CO₂ mass emission for vehicle H, g/km;

K_{ind} is the interpolation coefficient for the considered individual vehicle for the applicable WLTP test cycle.

4.5.5. Interpolation of the fuel consumption for individual vehicles

4.5.5.1. Individual charge-sustaining fuel consumption for OVC-HEVs and NOVC-HEVs

The charge-sustaining fuel consumption for an individual vehicle shall be calculated using the following equation:

$$FC_{\text{ind,CS,p}} = FC_{\text{L,CS,p}} + K_{\text{ind,p}} \times (FC_{\text{H,CS,p}} - FC_{\text{L,CS,p}})$$

where:

$FC_{\text{ind,CS,p}}$ is the charge-sustaining fuel consumption for an individual vehicle of the considered period p according to Table A8/6, step no. 3, l/100 km;

$FC_{\text{L,CS,p}}$ is the charge-sustaining fuel consumption for vehicle L of the considered period p according to Table A8/6, step no. 2, l/100 km;

$FC_{\text{H,CS,p}}$ is the charge-sustaining fuel consumption for vehicle H of the considered period p according to Table A8/6, step no. 2, l/100 km;

$K_{\text{ind,p}}$ is the interpolation coefficient for the considered individual vehicle for period p;

p is the index of the individual period within the applicable WLTP test cycle.

▼ M3

The considered periods shall be the low phase, medium phase, high phase, extra high phase, and the applicable WLTP test cycle.

▼ B

4.5.5.2. Individual utility factor-weighted charge depleting fuel consumption for OVC-HEVs

The utility factor-weighted charge-depleting fuel consumption for an individual vehicle shall be calculated using the following equation:

$$FC_{\text{ind,CD}} = FC_{\text{L,CD}} + K_{\text{ind}} \times (FC_{\text{H,CD}} - FC_{\text{L,CD}})$$

▼ B

where:

$FC_{ind,CD}$ is the utility factor-weighted charge-depleting fuel consumption for an individual vehicle, l/100 km;

$FC_{L,CD}$ is the utility factor-weighted charge-depleting fuel consumption for vehicle L, l/100 km;

$FC_{H,CD}$ is the utility factor-weighted charge-depleting fuel consumption for vehicle H, l/100 km;

K_{ind} is the interpolation coefficient for the considered individual vehicle for the applicable WLTP test cycle.

4.5.5.3. Individual utility factor-weighted fuel consumption for OVC-HEVs

The utility factor-weighted fuel consumption for an individual vehicle shall be calculated using the following equation:

$$FC_{ind,weighted} = FC_{L,weighted} + K_{ind} \times (FC_{H,weighted} - FC_{L,weighted})$$

where:

$FC_{ind,weighted}$ is the utility factor-weighted fuel consumption for an individual vehicle, l/100 km;

$FC_{L,weighted}$ is the utility factor-weighted fuel consumption for vehicle L, l/100 km;

$FC_{H,weighted}$ is the utility factor-weighted fuel consumption for vehicle H, l/100 km;

K_{ind} is the interpolation coefficient for the considered individual vehicle for the applicable WLTP test cycle.

4.5.6 Interpolation of electric energy consumption for individual vehicles

4.5.6.1. Individual utility factor-weighted charge-depleting electric energy consumption based on the recharged electric energy from the mains for OVC-HEVs

The utility factor-weighted charge-depleting electric energy consumption based on the recharged electric energy from for an individual vehicle shall be calculated using the following equation:

$$EC_{AC-ind,CD} = EC_{AC-L,CD} + K_{ind} \times (EC_{AC-H,CD} - EC_{AC-L,CD})$$

where:

$EC_{AC-ind,CD}$ is the utility factor-weighted charge-depleting electric energy consumption based on the recharged electric energy from the mains for an individual vehicle, Wh/km;

▼ B

$EC_{AC-L,CD}$ is the utility factor-weighted charge-depleting electric energy consumption based on the recharged electric energy from the mains for vehicle L, Wh/km;

$EC_{AC-H,CD}$ is the utility factor-weighted charge-depleting electric energy consumption based on the recharged electric energy from the mains for vehicle H, Wh/km;

K_{ind} is the interpolation coefficient for the considered individual vehicle for the applicable WLTP test cycle

4.5.6.2. Individual utility factor-weighted electric energy consumption based on the recharged electric energy from the mains for OVC-HEVs

The utility factor-weighted electric energy consumption based on the recharged electric energy from the mains for an individual vehicle shall be calculated using the following equation:

$$EC_{AC-ind,weighted} = EC_{AC-L,weighted} + K_{ind} \times (EC_{AC-H,weighted} - EC_{AC-L,weighted})$$

where:

$EC_{AC-ind,weighted}$ is the utility factor weighted electric energy consumption based on the recharged electric energy from the mains for an individual vehicle, Wh/km;

$EC_{AC-L,weighted}$ is the utility factor weighted electric energy consumption based on the recharged electric energy from the mains for vehicle L, Wh/km;

$EC_{AC-H,weighted}$ is the utility factor weighted electric energy consumption based on the recharged electric energy from the mains for vehicle H, Wh/km;

K_{ind} is the interpolation coefficient for the considered individual vehicle for the applicable WLTP test cycle.

4.5.6.3. Individual electric energy consumption for OVC-HEVs and PEVs

The electric energy consumption for an individual vehicle according to paragraph 4.3.3. of this Sub-Annex in the case of OVC-HEVs and according to paragraph 4.3.4. of this Sub-Annex in the case of PEVs shall be calculated using the following equation:

$$EC_{ind,p} = EC_{L,p} + K_{ind,p} \times (EC_{H,p} - EC_{L,p})$$

▼ B

where:

$EC_{ind,p}$ is the electric energy consumption for an individual vehicle for the considered period p , Wh/km;

$EC_{L,p}$ is the electric energy consumption for vehicle L for the considered period p , Wh/km;

$EC_{H,p}$ is the electric energy consumption for vehicle H for the considered period p , Wh/km;

$K_{ind,p}$ is the interpolation coefficient for the considered individual vehicle for period p ;

p is the index of the individual period within the applicable test cycle.

▼ M3

The considered periods shall be the low phase, medium phase, high phase, extra high phase, the applicable WLTP city test cycle and the applicable WLTP test cycle.

▼ B

4.5.7 Interpolation of electric ranges for individual vehicles

4.5.7.1. Individual all-electric range for OVC-HEVs

If the following criterion

$$\left| \frac{AER_L}{R_{CDA,L}} - \frac{AER_H}{R_{CDA,H}} \right| \leq 0, 1$$

where:

AER_L : is the all-electric range of vehicle L for the applicable WLTP test cycle, km;

AER_H : is the all-electric range of vehicle H for the applicable WLTP test cycle, km;

$R_{CDA,L}$: is the actual charge-depleting range of vehicle L, km;

$R_{CDA,H}$: is the actual charge-depleting range of vehicle H, km;

is fulfilled, the all-electric range for an individual vehicle shall be calculated using the following equation:

$$AER_{ind,p} = AER_{L,p} + K_{ind,p} \times (AER_{H,p} - AER_{L,p})$$

where:

$AER_{ind,p}$ is the all-electric range for an individual vehicle for the considered period p , km;

▼ B

- $AER_{L,p}$ is the all-electric range for vehicle L for the considered period p, km;
- $AER_{H,p}$ is the all-electric range for vehicle H for the considered period p, km
- $K_{ind,p}$ is the interpolation coefficient for the considered individual vehicle for period p;
- p is the index of the individual period within the applicable test cycle.

The considered periods shall be the applicable WLTP city test cycle and the applicable WLTP test cycle.

If the criterion defined in this paragraph is not fulfilled, the AER determined for vehicle H is applicable to all vehicles within the interpolation family.

4.5.7.2. Individual pure electric range for PEVs

The pure electric range for an individual vehicle shall be calculated using the following equation:

$$PER_{ind,p} = PER_{L,p} + K_{ind,p} \times (PER_{H,p} - PER_{L,p})$$

where:

- $PER_{ind,p}$ is the pure electric range for an individual vehicle for the considered period p, km;
- $PER_{L,p}$ is the pure electric range for vehicle L for the considered period p, km;
- $PER_{H,p}$ is the pure electric range for vehicle H for the considered period p, km;
- $K_{ind,p}$ is the interpolation coefficient for the considered individual vehicle for period p;
- p is the index of the individual period within the applicable test cycle.

▼ M3

The considered periods shall be the low phase, medium phase, high phase, extra high phase, the applicable WLTP city test cycle and the applicable WLTP test cycle.

▼ B

4.5.7.3. Individual equivalent all-electric range for OVC-HEVs

The equivalent all-electric range for an individual vehicle shall be calculated using the following equation:

$$EAER_{ind,p} = EAER_{L,p} + K_{ind,p} \times (EAER_{H,p} - EAER_{L,p})$$

▼ B

where:

$EAER_{ind,p}$ is the equivalent all-electric range for an individual vehicle for the considered period p , km;

$EAER_{L,p}$ is the equivalent all-electric range for vehicle L for the considered period p , km;

$EAER_{H,p}$ is the equivalent all-electric range for vehicle H for the considered period p , km;

$K_{ind,p}$ is the interpolation coefficient for the considered individual vehicle for period p ;

p is the index of the individual period within the applicable test cycle.

The considered periods shall be the low-phase, mid-phase, high-phase, extra high-phase, applicable WLTP city test cycle and the applicable WLTP test cycle.

▼ M3

4.6. Stepwise procedure for calculating the final test results of OVC-HEVs

In addition to the stepwise procedure for calculating the final charge-sustaining test results for gaseous emission compounds in accordance with paragraph 4.1.1.1. of this Sub-Annex and for fuel consumption in accordance with paragraph 4.2.1.1. of this Sub-Annex, paragraphs 4.6.1. and 4.6.2. of this Sub-Annex describe the stepwise calculation of the final charge-depleting as well as the final charge-sustaining and charge-depleting weighted test results.

4.6.1. Stepwise procedure for calculating the final test results of the charge-depleting Type 1 test for OVC-HEVs

The results shall be calculated in the order described in Table A8/8. All applicable results in the column 'Output' shall be recorded. The column 'Process' describes the paragraphs to be used for calculation or contains additional calculations.

For the purpose of Table A8/8, the following nomenclature within the equations and results is used:

c complete applicable test cycle;

p every applicable cycle phase;

i applicable criteria emission component;

CS charge-sustaining;

CO₂ CO₂ mass emission.

▼ M3

Table A8/8

Calculation of final charge-depleting values

Source	Input	Process	Output	Step no.
Sub-Annex 8	Charge-depleting test results	<p>Results measured in accordance with Appendix 3 to this Sub-Annex, pre-calculated in accordance with paragraph 4.3. of this Sub-Annex.</p> <p>Usable battery energy in accordance with paragraph 4.4.1.2.2. of this Sub-Annex.</p> <p>Recharged electric energy in accordance with paragraph 3.2.4.6. of this Sub-Annex.</p> <p>Cycle energy in accordance with paragraph 5. of Sub-Annex 7.</p> <p>CO₂ mass emission in accordance with paragraph 3.2.1. of Sub-Annex 7.</p> <p>Mass of gaseous emission compound i in accordance with paragraph 3.2.1. of Sub-Annex 7.</p> <p>Particle number emissions in accordance with paragraph 4. of Sub-Annex 7.</p> <p>Particulate matter emissions in accordance with paragraph 3.3. of Sub-Annex 7.</p> <p>All-electric range determined in accordance with paragraph 4.4.1.1. of this Sub-Annex.</p> <p>In the case that the applicable WLTC city test cycle was driven: all-electric range city in accordance with paragraph 4.4.1.2.1. of this Sub-Annex.</p> <p>CO₂ mass emission K_{CO2} correction coefficient might be necessary in accordance with Appendix 2 to this Sub-Annex.</p> <p>Output is available for each test.</p> <p>In the case that the interpolation method is applied, the output (except of K_{CO2}) is available for vehicle H, L and, if applicable, M.</p>	<p>$\Delta E_{REESS,j}$, Wh; d_j, km;</p> <p>UBE_{city}, Wh;</p> <p>E_{AC}, Wh;</p> <p>E_{cycle}, Ws;</p> <p>$M_{CO2,CD,j}$, g/km;</p> <p>$M_{i,CD,j}$, g/km;</p> <p>$PN_{CD,j}$, particles per kilometer;</p> <p>$PM_{CD,c}$, mg/km;</p> <p>AER, km;</p> <p>AER_{city}, km.</p> <p>K_{CO2}, (g/km)/(Wh/km).</p>	1

▼ M3

Source	Input	Process	Output	Step no.
Output step 1	$\Delta E_{REESS,j}$, Wh; E_{cycle} , Ws.	Calculation of relative electric energy change for each cycle in accordance with paragraph 3.2.4.5.2. of this Sub-Annex. Output is available for each test and each applicable WLTP test cycle. In the case that the interpolation method is applied, the output is available for vehicle H, L and, if applicable, M.	REEC _i .	2
Output step 2	REEC _i .	Determination of the transition and confirmation cycle in accordance with paragraph 3.2.4.4. of this Sub-Annex. In the case that more than one charge-depleting test is available for one vehicle, for the purpose of averaging, each test shall have the same transition cycle number n_{veh} . Determination of the charge-depleting cycle range in accordance with paragraph 4.4.3. of this Sub-Annex. Output is available for each test. In the case that the interpolation method is applied, the output is available for vehicle H, L and, if applicable, M.	n_{veh} ; R _{CDC} ; km.	3
Output step 3	n_{veh} ;	In the case that the interpolation method is used, the transition cycle shall be determined for vehicle H, L and, if applicable, M. Check whether the interpolation criterion in accordance with paragraph 5.6.2. (d) of this Annex is fulfilled.	$n_{veh,L}$; $n_{veh,H}$; if applicable $n_{veh,M}$.	4
Output step 1	$M_{i,CD,j}$, g/km; $PM_{CD,e}$, mg/km; $PN_{CD,j}$, particles per kilometer.	Calculation of combined values for emissions for n_{veh} cycles; in the case of interpolation for $n_{veh,L}$ cycles for each vehicle. Output is available for each test. In the case that the interpolation method is applied, the output is available for vehicle H, L and, if applicable, M.	$M_{i,CD,e}$, g/km; $PM_{CD,e}$, mg/km; $PN_{CD,e}$, particles per kilometer.	5

▼ M3

Source	Input	Process	Output	Step no.
Output step 5	$M_{i,CD,c}$, g/km; $PM_{CD,c}$, mg/km; $PN_{CD,c}$, particles per kilometer.	Emission averaging of tests for each applicable WLTP test cycle within the charge-depleting Type 1 test and check with the limits in accordance with Table A6/2 of Sub-Annex 6.	$M_{i,CD,c,ave}$, g/km; $PM_{CD,c,ave}$, mg/km; $PN_{CD,c,ave}$, particles per kilometer.	6
Output step 1	$\Delta E_{REESS,j}$, Wh; d_j , km; UBE_{city} , Wh.	In the case that AER_{city} is derived from the Type 1 test by driving the applicable WLTP test cycles, the value shall be calculated in accordance with paragraph 4.4.1.2.2. of this Sub-Annex. In the case of more than one test, $n_{city,pe}$ shall be equal for each test. Output available for each test. Averaging of AER_{city} . In the case that the interpolation method is applied, the output is available for vehicle H, L and, if applicable, M.	AER_{city} , km; $AER_{city,ave}$, km.	7
Output step 1	d_j , km;	Phase-specific and cycle-specific UF calculation. Output is available for each test.	$UF_{phase,j}$; $UF_{cycle,c}$.	8
Output step 3	n_{veh} ;	In the case that the interpolation method is applied, the output is available for vehicle H, L and, if applicable, M.		
Output step 4	$n_{veh,L}$;			
Output step 1	$\Delta E_{REESS,j}$, Wh; d_j , km; E_{AC} , Wh;	Calculation of the electric energy consumption based on the recharged energy according to paragraphs 4.3.1. and 4.3.2. of this Sub-Annex. In the case of interpolation, $n_{veh,L}$ cycles shall be used. Therefore, due to the required correction of the CO ₂ mass emission, the electric energy consumption of the confirmation cycle and its phases shall be set to zero.	$EC_{AC,weighted}$, Wh/km; $EC_{AC,CD}$, Wh/km;	9
Output step 3	n_{veh} ;			
Output step 4	$n_{veh,L}$;	Output is available for each test.		
Output step 8	$UF_{phase,j}$;	In the case that the interpolation method is applied, the output is available for vehicle H, L and, if applicable, M.		

▼ M3

Source	Input	Process	Output	Step no.
Output step 1	$M_{CO_2,CD,j}$, g/km; K_{CO_2} , (g/km)/(Wh/km); $\Delta E_{REESS,j}$, Wh; d_j , km;	Calculation of the charge-depleting CO_2 mass emission in accordance with paragraph 4.1.2. of this Sub-Annex. In the case that the interpolation method is applied, $n_{veh,L}$ cycles shall be used. With reference to paragraph 4.1.2. of this Sub-Annex, the confirmation cycle shall be corrected in accordance with Appendix 2 to this Sub-Annex. Output is available for each test.	$M_{CO_2,CD}$, g/km;	10
Output step 3	n_{veh} ;			
Output step 4	$n_{veh,L}$;	In the case that the interpolation method is applied, the output is available for vehicle H, L and, if applicable, M.		
Output step 8	$UF_{phase,j}$.			
Output step 1	$M_{CO_2,CD,j}$, g/km; $M_{i,CD,j}$, g/km; K_{CO_2} , (g/km)/(Wh/km).	Calculation of the charge-depleting fuel consumption in accordance with paragraph 4.2.2. of this Sub-Annex. In the case that the interpolation method is applied, $n_{veh,L}$ cycles shall be used. With reference to paragraph 4.1.2. of this Sub-Annex, $M_{CO_2,CD,j}$ of the confirmation cycle shall be corrected in accordance with Appendix 2 to this Sub-Annex. The phase-specific fuel consumption $FC_{CD,j}$ shall be calculated using the corrected CO_2 mass emission in accordance with paragraph 6. of Sub-Annex 7. Output is available for each test.	$FC_{CD,j}$, l/100 km; FC_{CD} , l/100 km.	11
Output step 3	n_{veh} ;			
Output step 4	$n_{veh,L}$;			
Output step 8	$UF_{phase,j}$;	In the case that the interpolation method is applied, the output is available for vehicle H, L and, if applicable, M.		
Output step 1	$\Delta E_{REESS,j}$, Wh; d_j , km;	Calculation of the electric energy consumption from the first applicable WLTP test cycle. Output is available for each test. In the case that the interpolation method is applied, the output is available for vehicle H, L and, if applicable, M.	$EC_{DC,CD,first}$, Wh/km	12

▼ M3

Source	Input	Process	Output	Step no.
Output step 9	$EC_{AC,weighted}$, Wh/km;	Averaging of tests for each vehicle. In the case that the interpolation method is applied, the output is available for each vehicle H, L and, if applicable, M.	$EC_{AC,weighted,ave}$, Wh/km;	13
Output step 10	$EC_{AC,CD}$, Wh/km;		$EC_{AC,CD,ave}$, Wh/km;	
Output step 11	$M_{CO_2,CD}$, g/km;		$M_{CO_2,CD,ave}$, g/km;	
Output step 12	FC_{CD} , l/100 km;		$FC_{CD,ave}$, l/100 km;	
Output step 13	$EC_{DC,CD,first}$, Wh/km.		$EC_{DC,CD,first,ave}$, Wh/km	
Output step 13	$EC_{AC,CD,ave}$, Wh/km;	Declaration of charge-depleting electric energy consumption and CO ₂ mass emission for each vehicle. In the case that the interpolation method is applied, the output is available for each vehicle H, L and, if applicable, M.	$EC_{AC,CD,dec}$, Wh/km;	14
Output step 14	$M_{CO_2,CD,ave}$, g/km.		$M_{CO_2,CD,dec}$, g/km.	
Output step 12	$EC_{DC,CD,first}$, Wh/km;	Adjustment of electric energy consumption for the purpose of COP. In the case that the interpolation method is applied, the output is available for each vehicle H, L and, if applicable, M.	$EC_{DC,CD,COP}$, Wh/km;	15
Output step 13	$EC_{AC,CD,ave}$, Wh/km;			
Output step 14	$EC_{AC,CD,dec}$, Wh/km;			
Output step 15	$EC_{DC,CD,COP}$, Wh/km;	Intermediate rounding. In the case that the interpolation method is applied, the output is available for each vehicle H, L and, if applicable, M.	$EC_{DC,CD,COP,final}$, Wh/km;	16
Output step 14	$EC_{AC,CD,dec}$, Wh/km;		$EC_{AC,CD,final}$, Wh/km;	
Output step 13	$M_{CO_2,CD,dec}$, g/km;		$M_{CO_2,CD,final}$, g/km;	
Output step 13	$EC_{AC,weighted,ave}$, Wh/km;		$EC_{AC,weighted,final}$, Wh/km;	
Output step 13	$FC_{CD,ave}$, l/100 km;		$FC_{CD,final}$, l/100 km;	

▼ M3

Source	Input	Process	Output	Step no.
Output step 16	$EC_{DC,CD,COP,final}$, Wh/km; $EC_{AC,CD,final}$, Wh/km; $M_{CO_2,CD,final}$, g/km; $EC_{AC,weighted,final}$, Wh/km; $FC_{CD,final}$, l/100 km;	Interpolation of individual values based on input from vehicle L, M and H, and final rounding. Output available for individual vehicles.	$EC_{DC,CD,COP,ind}$, Wh/km; $EC_{AC,CD,ind}$, Wh/km; $M_{CO_2,CD,ind}$, g/km; $EC_{AC,weighted,ind}$, Wh/km; $FC_{CD,ind}$, l/100 km;	17

4.6.2. Stepwise procedure for calculating the final charge-sustaining and charge-depleting weighted test results of the Type 1 test

The results shall be calculated in the order described in Table A8/9. All applicable results in the column 'Output' shall be recorded. The column 'Process' describes the paragraphs to be used for calculation or contains additional calculations.

For the purpose of this table, the following nomenclature within the equations and results is used:

- c considered period is the complete applicable test cycle;
- p considered period is the applicable cycle phase;
- i applicable criteria emission component (except for CO₂);
- j index for the considered period;
- CS charge-sustaining;
- CD charge-depleting;
- CO₂ CO₂ mass emission;

REESS Rechargeable Electric Energy Storage System.

▼ M3

Table A8/9

Calculation of final charge-depleting and charge-sustaining weighted values

Source	Input	Process	Output	Step no.
Output step 1, Table A8/8	$M_{i,CD,j}$, g/km; $PN_{CD,j}$, particles per kilometer; $PM_{CD,c}$, mg/km; $M_{CO2,CD,j}$, g/km; $\Delta E_{REESS,j}$, Wh; d_j , km; AER, km; E_{AC} , Wh;	Input from CD and CS postpro- cessing.	$M_{i,CD,j}$, g/km; $PN_{CD,j}$, particles per kilometer; $PM_{CD,c}$, mg/km; $M_{CO2,CD,j}$, g/km; $\Delta E_{REESS,j}$, Wh; d_j , km; AER, km; E_{AC} , Wh; $AER_{city,ave}$, km; n_{veh} ;	1
Output step 7, Table A8/8	$AER_{city,ave}$, km;		R_{CDC} , km; $n_{veh,L}$; $n_{veh,H}$; $UF_{phase,j}$; $UF_{cycle,c}$;	
Output step 3, Table A8/8	n_{veh} ; R_{CDC} , km;		$M_{i,CS,c,6}$, g/km; $M_{CO2,CS}$, g/km;	
Output step 4, Table A8/8	$n_{veh,L}$; $n_{veh,H}$;			
Output step 8, Table A8/8	$UF_{phase,j}$; $UF_{cycle,c}$;			
Output step 6, Table A8/5	$M_{i,CS,c,6}$, g/km;			
Output step 7, Table A8/5	$M_{CO2,CS}$, g/km;			
		Output in the case of CD is available for each CD test. Output in the case of CS is available once due to CS test averaged values.		

▼ M3

Source	Input	Process	Output	Step no.
	K_{CO_2} , (g/km)/(Wh/km).	In the case that the interpolation method is applied, the output (except of K_{CO_2}) is available for vehicle H, L and, if applicable, M. CO_2 mass emission correction coefficient K_{CO_2} might be necessary in accordance with Appendix 2 to this Sub-Annex.	K_{CO_2} , (g/km)/(Wh/km).	
Output step 1,	$M_{i,CD,j}$, g/km; $PN_{CD,j}$, particles per kilometer; $PM_{CD,c}$, mg/km; n_{veh} ; $n_{veh,L}$; $UF_{phase,j}$; $UF_{cycle,c}$; $M_{i,CS,e,6}$, g/km;	Calculation of weighted emission (except $M_{CO_2,weighted}$) compounds in accordance with paragraphs 4.1.3.1. to 4.1.3.3. of this Sub-Annex. Remark: $M_{i,CS,e,6}$ includes $PN_{CS,c}$ and $PM_{CS,c}$. Output is available for each CD test. In the case that the interpolation method is applied, the output is available for each vehicle L, H and, if applicable, M.	$M_{i,weighted}$, g/km; $PN_{weighted}$, particles per kilometer; $PM_{weighted}$, mg/km;	2
Output step 1,	$M_{CO_2,CD,j}$, g/km; $\Delta E_{REESS,j}$, Wh; d_j , km; n_{veh} ; R_{CDC} , km $M_{CO_2,CS}$, g/km;	Calculation of equivalent all-electric range in accordance with paragraphs 4.4.4.1. and 4.4.4.2. of this Sub-Annex, and actual charge-depleting range in accordance with paragraph 4.4.5. of this Sub-Annex. Output is available for each CD test. In the case that the interpolation method is applied, the output is available for each vehicle L, H and, if applicable, M.	EAER, km; EAER _p , km; R_{CDA} , km.	3
Output step 1 Output step 3	AER, km; R_{CDA} , km.	Output is available for each CD test. In the case that the interpolation method is applied, check the availability of AER interpolation between vehicle H, L and, if applicable, M in accordance with paragraph 4.5.7.1. of this Sub-Annex. If the interpolation method is used, each test shall fulfil the requirement.	AER-interpolation availability.	4

▼ M3

Source	Input	Process	Output	Step no.
Output step 1	AER, km.	<p>Averaging AER and AER declaration.</p> <p>The declared AER shall be rounded as defined in Table A6/1.</p> <p>In the case that the interpolation method is applied and the AER-interpolation availability criterion is fulfilled, the output is available for each vehicle L, H and if applicable, M.</p> <p>If the criterion is not fulfilled, AER of vehicle H shall be applied for the whole interpolation family.</p>	AER _{ave} , km; AER _{dec} , km.	5
Output step 1	$M_{i,CD,j}$, g/km; $M_{CO_2,CD,j}$, g/km; n_{veh} ; $n_{veh,L}$; $UF_{phase,j}$; $M_{i,CS,e,6}$, g/km; $M_{CO_2,CS}$, g/km.	<p>Calculation of weighted CO₂ mass emission and fuel consumption in accordance with paragraphs 4.1.3.1. and 4.2.3. of this Sub-Annex.</p> <p>Output is available for each CD test.</p> <p>In the case that the interpolation method is applied, $n_{veh,L}$ cycles shall be used. With reference to paragraph 4.1.2. of this Sub-Annex, $M_{CO_2,CD,j}$ of the confirmation cycle shall be corrected in accordance with Appendix 2 to this Sub-Annex.</p> <p>In the case that the interpolation method is applied, the output is available for each vehicle L, H and, if applicable, M.</p>	$M_{CO_2,weighted}$, g/km; $FC_{weighted}$, l/100 km;	6
Output step 1	E_{AC} , Wh;	<p>Calculation of the electric energy consumption based in EAER in accordance with paragraphs 4.3.3.1. and 4.3.3.2. of this Sub-Annex.</p> <p>Output is available for each CD test.</p>	EC , Wh/km; EC_p , Wh/km;	7
Output step 3	$EAER$, km; $EAER_p$, km;	<p>In the case that the interpolation method is applied, the output is available for each vehicle L, H and, if applicable, M.</p>		

▼ M3

Source	Input	Process	Output	Step no.
Output step 1	$AER_{city, ave}$, km;	Averaging and intermediate rounding.	$AER_{city, final}$, km;	8
Output step 6	$M_{CO2, weighted}$, g/km; $FC_{weighted}$, l/100 km;	In the case that the interpolation method is applied, the output is available for each vehicle L, H and, if applicable, M.	$M_{CO2, weighted, final}$, g/km; $FC_{weighted, final}$, l/100 km; EC_{final} , Wh/km; $EC_{p, final}$, Wh/km; $EAER_{final}$, km; $EAER_{p, final}$, km.	
Output step 7	EC , Wh/km; EC_p , Wh/km;			
Output step 3	$EAER$, km; $EAER_p$, km.			
Output step 5	AER_{ave} , km;	Interpolation of individual values based on input from vehicle low, medium and high in accordance with paragraph 4.5. of this Sub-Annex, and final rounding.	AER_{ind} , km; $AER_{city, ind}$, km;	9
Output step 8	$AER_{city, final}$, km; $M_{CO2, weighted, final}$, g/km; $FC_{weighted, final}$, l/100 km; EC_{final} , Wh/km; $EC_{p, final}$, Wh/km; $EAER_{final}$, km; $EAER_{p, final}$, km;	AER_{ind} shall be rounded as defined in Table A8/2. Output available for individual vehicles.	$M_{CO2, weighted, ind}$, g/km; $FC_{weighted, ind}$, l/100 km; EC_{ind} , Wh/km; $EC_{p, ind}$, Wh/km; $EAER_{ind}$, km; $EAER_{p, ind}$, km.	
Output step 4	AER-interpolation availability.			

4.7. Stepwise procedure for calculating the final test results of PEVs

The results shall be calculated in the order described in Table A8/10 in case of the consecutive cycle procedure and in the order described in Table A8/11 in case of the shortened test procedure. All applicable results in the column 'Output' shall be recorded. The column 'Process' describes the paragraphs to be used for calculation or contains additional calculations.

4.7.1. Stepwise procedure for calculating the final test results of PEVs in case of the consecutive cycles procedure

For the purpose of this table, the following nomenclature within the questions and results is used:

j index for the considered period.

▼ M3

Table A8/10

Calculation of final PEV values determined by application of the consecutive cycle Type 1 procedure

Source	Input	Process	Output	Step no.
Sub-Annex 8	Test results	<p>Results measured in accordance with Appendix 3 to this Sub-Annex and pre-calculated in accordance with paragraph 4.3. of this Sub-Annex.</p> <p>Usable battery energy in accordance with paragraph 4.4.2.2.1. of this Sub-Annex.</p> <p>Recharged electric energy in accordance with paragraph 3.4.4.3. of this Sub-Annex.</p> <p>Output available for each test.</p> <p>In the case that the interpolation method is applied, the output is available for vehicle H and vehicle L.</p>	<p>$\Delta E_{REESS,j}$, Wh; d_j, km;</p> <p>UBE_{CCP}, Wh;</p> <p>E_{AC}, Wh.</p>	1
Output step 1	$\Delta E_{REESS,j}$, Wh; UBE_{CCP} , Wh.	<p>Determination of the number of completely driven applicable WLTC phases and cycles in accordance with paragraph 4.4.2.2. of this Sub-Annex.</p> <p>Output available for each test.</p> <p>In the case that the interpolation method is applied, the output is available for vehicle H and vehicle L.</p>	<p>n_{WLTC};</p> <p>n_{city};</p> <p>n_{low};</p> <p>n_{med};</p> <p>n_{high};</p> <p>n_{exHigh}.</p>	2
Output step 1 Output step 2	<p>$\Delta E_{REESS,j}$, Wh; UBE_{CCP}, Wh.</p> <p>n_{WLTC};</p> <p>n_{city};</p> <p>n_{low};</p> <p>n_{med};</p> <p>n_{high};</p> <p>n_{exHigh}.</p>	<p>Calculation of weighting factors in accordance with paragraph 4.4.2.2. of this Sub-Annex.</p> <p>Output available for each test.</p> <p>In the case that the interpolation method is applied, the output is available for vehicle H and vehicle L.</p>	<p>$K_{WLTC,1}$</p> <p>$K_{WLTC,2}$</p> <p>$K_{WLTC,3}$</p> <p>$K_{WLTC,4}$</p> <p>$K_{city,1}$</p> <p>$K_{city,2}$</p> <p>$K_{city,3}$</p> <p>$K_{city,4}$</p> <p>$K_{low,1}$</p> <p>$K_{low,2}$</p> <p>$K_{low,3}$</p> <p>$K_{low,4}$</p> <p>$K_{med,1}$</p> <p>$K_{med,2}$</p> <p>$K_{med,3}$</p> <p>$K_{med,4}$</p> <p>$K_{high,1}$</p> <p>$K_{high,2}$</p> <p>$K_{high,3}$</p> <p>$K_{high,4}$</p> <p>$K_{exHigh,1}$</p> <p>$K_{exHigh,2}$</p> <p>$K_{exHigh,3}$</p>	3

▼ M3

Source	Input	Process	Output	Step no.
Output step 1	$\Delta E_{REESS,j}$, Wh; d_j , km; UBE_{CCP} , Wh.	Calculation of electric energy consumption at the REESSs in accordance with paragraph 4.4.2.2. of this Sub-Annex. $EC_{DC,COP,1}$ Output available for each test.	$EC_{DC,WLTC}$, Wh/km; $EC_{DC,city}$, Wh/km; $EC_{DC,low}$, Wh/km; $EC_{DC,med}$, Wh/km; $EC_{DC,high}$, Wh/km;	4
Output step 2	n_{WLTC} ; n_{city} ; n_{low} ; n_{med} ; n_{high} ; n_{exHigh} .	In the case that the interpolation method is applied, the output is available for vehicle H and vehicle L.	$EC_{DC,exHigh}$, Wh/km; $EC_{DC,COP,1}$, Wh/km.	
Output step 3	All weighting factors			
Output step 1	UBE_{CCP} , Wh;	Calculation of pure electric range in accordance with paragraph 4.4.2.2. of this Sub-Annex. Output available for each test.	PER_{WLTC} , km; PER_{city} , km; PER_{low} , km; PER_{med} , km; PER_{high} , km;	5
Output step 4	$EC_{DC,WLTC}$, Wh/km; $EC_{DC,city}$, Wh/km; $EC_{DC,low}$, Wh/km; $EC_{DC,med}$, Wh/km; $EC_{DC,high}$, Wh/km; $EC_{DC,exHigh}$, Wh/km.	In the case that the interpolation method is applied, the output is available for vehicle H and vehicle L.	PER_{exHigh} , km.	
Output step 1	E_{AC} , Wh;	Calculation of electric energy consumption at the mains in accordance with paragraph 4.3.4. of this Sub-Annex. Output available for each test.	EC_{WLTC} , Wh/km; EC_{city} , Wh/km; EC_{low} , Wh/km; EC_{med} , Wh/km; EC_{high} , Wh/km;	6
Output step 5	PER_{WLTC} , km; PER_{city} , km; PER_{low} , km; PER_{med} , km; PER_{high} , km; PER_{exHigh} , km.	In the case that the interpolation method is applied, the output is available for vehicle H and vehicle L.	EC_{exHigh} , Wh/km.	

▼ M3

Source	Input	Process	Output	Step no.
Output step 5	<p>PER_{WLTC}, km; PER_{city}, km; PER_{low}, km; PER_{med}, km; PER_{high}, km; PER_{exHigh}, km;</p>	<p>Averaging of tests for all input values. EC_{DC,COP,ave} Declaration of PER_{WLTC,dec} and EC_{WLTC,dec} based on PER_{WLTC,ave} and EC_{WLTC,ave}. PER_{WLTC,dec} and EC_{WLTC,dec} shall be rounded as defined in Table A6/1. In the case that the interpolation method is applied, the output is available for vehicle H and vehicle L.</p>	<p>PER_{WLTC,dec}, km; PER_{WLTC,ave}, km; PER_{city,ave}, km; PER_{low,ave}, km; PER_{med,ave}, km; PER_{high,ave}, km; PER_{exHigh,ave}, km;</p>	7
Output step 6	<p>EC_{WLTC}, Wh/km; EC_{city}, Wh/km; EC_{low}, Wh/km; EC_{med}, Wh/km; EC_{high}, Wh/km; EC_{exHigh}, Wh/km.</p>		<p>EC_{WLTC,dec}, Wh/km; EC_{WLTC,ave}, Wh/km; EC_{city,ave}, Wh/km; EC_{low,ave}, Wh/km; EC_{med,ave}, Wh/km; EC_{high,ave}, Wh/km; EC_{exHigh,ave}, Wh/km; EC_{DC,COP,ave}, Wh/km.</p>	
Output step 4	<p>EC_{DC,COP,1}, Wh/km.</p>			
Output step 7	<p>EC_{WLTC,dec}, Wh/km; EC_{WLTC,ave}, Wh/km; EC_{DC,COP,ave}, Wh/km.</p>	<p>Determination of the adjustment factor and application to EC_{DC,COP,ave}. For example: $AF = \frac{EC_{WLTC,dec}}{EC_{WLTC,ave}}$ $EC_{DC,COP} = EC_{DC,COP,ave} \times AF$ In the case that the interpolation method is applied, the output is available for vehicle H and vehicle L.</p>	<p>EC_{DC,COP}, Wh/km.</p>	8

▼ M3

Source	Input	Process	Output	Step no.
Output step 7	$PER_{city,ave}$, km; $PER_{low,ave}$, km; $PER_{med,ave}$, km; $PER_{high,ave}$, km; $PER_{exHigh,ave}$, km;	Intermediate rounding. $EC_{DC,COP,final}$ In the case that the interpolation method is applied, the output is available for vehicle H and vehicle L.	$PER_{city,final}$, km; $PER_{low,final}$, km; $PER_{med,final}$, km; $PER_{high,final}$, km; $PER_{exHigh,final}$, km;	9
Output step 8	$EC_{city,ave}$, Wh/km; $EC_{low,ave}$, Wh/km; $EC_{med,ave}$, Wh/km; $EC_{high,ave}$, Wh/km; $EC_{exHigh,ave}$, Wh/km;		$EC_{city,final}$, Wh/km; $EC_{low,final}$, Wh/km; $EC_{med,final}$, Wh/km; $EC_{high,final}$, Wh/km; $EC_{exHigh,final}$, Wh/km;	
Output step 8	$EC_{DC,COP}$, Wh/km.		$EC_{DC,COP,final}$, Wh/km.	
Output step 7	$PER_{WLTC,dec}$, km;	Interpolation in accordance with paragraph 4.5. of this Sub-Annex, and final rounding as defined in Table A8/2. $EC_{DC,COP,ind}$	$PER_{WLTC,ind}$, km; $PER_{city,ind}$, km; $PER_{low,ind}$, km; $PER_{med,ind}$, km; $PER_{high,ind}$, km; $PER_{exHigh,ind}$, km;	10
Output step 9	$EC_{WLTC,dec}$, Wh/km; $PER_{city,final}$, km; $PER_{low,final}$, km; $PER_{med,final}$, km; $PER_{high,final}$, km; $PER_{exHigh,final}$, km;	In the case that the interpolation method is applied, the output available for each individual vehicle.	$EC_{city,final}$, Wh/km; $EC_{low,final}$, Wh/km; $EC_{med,final}$, Wh/km; $EC_{high,final}$, Wh/km; $EC_{exHigh,final}$, Wh/km;	
	$EC_{city,final}$, Wh/km; $EC_{low,final}$, Wh/km; $EC_{med,final}$, Wh/km; $EC_{high,final}$, Wh/km; $EC_{exHigh,final}$, Wh/km;		$EC_{WLTC,ind}$, Wh/km; $EC_{city,ind}$, Wh/km; $EC_{low,ind}$, Wh/km; $EC_{med,ind}$, Wh/km; $EC_{high,ind}$, Wh/km; $EC_{exHigh,ind}$, Wh/km;	
	$EC_{DC,COP,final}$, Wh/km.		$EC_{DC,COP,ind}$, Wh/km.	

▼ **M3**

4.7.2. Stepwise procedure for calculating the final test results of PEVs in case of the shortened test procedure

For the purpose of this table, the following nomenclature within the questions and results is used:

j index for the considered period.

Table A8/11

Calculation of final PEV values determined by application the shortened Type 1 test procedure

Source	Input	Process	Output	Step no.
Sub-Annex 8	Test results	<p>Results measured in accordance with Appendix 3 to this Sub-Annex, and pre-calculated in accordance with paragraph 4.3. of this Sub-Annex.</p> <p>Usable battery energy in accordance with paragraph 4.4.2.1.1. of this Sub-Annex.</p> <p>Recharged electric energy in accordance with paragraph 3.4.4.3. of this Sub-Annex.</p> <p>Output is available for each test.</p> <p>In the case that the interpolation method is applied, the output is available for vehicle L and vehicle H.</p>	<p>$\Delta E_{REESS,j}$, Wh; d_j, km;</p> <p>UBE_{STP}, Wh;</p> <p>E_{AC}, Wh.</p>	1
Output step 1	<p>$\Delta E_{REESS,j}$, Wh; UBE_{STP}, Wh.</p>	<p>Calculation of weighting factors in accordance with paragraph 4.4.2.1. of this Sub-Annex.</p> <p>Output is available for each test.</p> <p>In the case that the interpolation method is applied, the output is available for vehicle L and vehicle H.</p>	<p>$K_{WLTC,1}$ $K_{WLTC,2}$ $K_{city,1}$ $K_{city,2}$ $K_{city,3}$ $K_{city,4}$ $K_{low,1}$ $K_{low,2}$ $K_{low,3}$ $K_{low,4}$ $K_{med,1}$ $K_{med,2}$ $K_{med,3}$ $K_{med,4}$ $K_{high,1}$ $K_{high,2}$ $K_{exHigh,1}$ $K_{exHigh,2}$</p>	2

▼ M3

Source	Input	Process	Output	Step no.
Output step 1	$\Delta E_{REESS,j}$, Wh; d_j , km; UBE_{STP} , Wh.	Calculation of electric energy consumption at the REESSs in accordance with paragraph 4.4.2.1. of this Sub-Annex. $EC_{DC,COP,1}$ Output is available for each test.	$EC_{DC,WLTC}$, Wh/km; $EC_{DC,city}$, Wh/km; $EC_{DC,low}$, Wh/km; $EC_{DC, med}$, Wh/km;	3
Output step 2	All weighting factors	In the case that the interpolation method is applied, the output is available for vehicle L and vehicle H.	$EC_{DC,high}$, Wh/km; $EC_{DC,exHigh}$, Wh/km; $EC_{DC,COP,1}$, Wh/km.	
Output step 1	UBE_{STP} , Wh;	Calculation of pure electric range in accordance with paragraph 4.4.2.1. of this Sub-Annex. Output is available for each test.	PER_{WLTC} , km; PER_{city} , km; PER_{low} , km; PER_{med} , km;	4
Output step 3	$EC_{DC,WLTC}$, Wh/km; $EC_{DC,city}$, Wh/km; $EC_{DC,low}$, Wh/km; $EC_{DC, med}$, Wh/km; $EC_{DC,high}$, Wh/km; $EC_{DC,exHigh}$, Wh/km.	In the case that the interpolation method is applied, the output is available for vehicle L and vehicle H.	PER_{high} , km; PER_{exHigh} , km.	
Output step 1	E_{AC} , Wh;	Calculation of electric energy consumption at the mains in accordance with paragraph 4.3.4. of this Sub-Annex. Output is available for each test.	EC_{WLTC} , Wh/km; EC_{city} , Wh/km; EC_{low} , Wh/km; EC_{med} , Wh/km;	5
Output step 4	PER_{WLTC} , km; PER_{city} , km; PER_{low} , km; PER_{med} , km; PER_{high} , km; PER_{exHigh} , km.	In the case that the interpolation method is applied, the output is available for vehicle L and vehicle H.	EC_{high} , Wh/km; EC_{exHigh} , Wh/km.	

▼ M3

Source	Input	Process	Output	Step no.
Output step 4	PER _{WLTC} , km; PER _{city} , km; PER _{low} , km; PER _{med} , km; PER _{high} , km; PER _{exHigh} , km;	Averaging of tests for all input values. EC _{DC,COP,ave} Declaration of PER _{WLTC,dec} and EC _{WLTC,dec} based on PER _{WLTC,ave} and EC _{WLTC,ave} . PER _{WLTC,dec} and EC _{WLTC,dec} shall be rounded as defined in Table A6/1. In the case that the interpolation method is applied, the output is available for vehicle L and vehicle H.	PER _{WLTC,dec} , km; PER _{WLTC,ave} , km; PER _{city,ave} , km; PER _{low,ave} , km; PER _{med,ave} , km; PER _{high,ave} , km; PER _{exHigh,ave} , km; EC _{WLTC,dec} , Wh/km; EC _{WLTC,ave} , Wh/km; EC _{city,ave} , Wh/km; EC _{low,ave} , Wh/km; EC _{med,ave} , Wh/km; EC _{high,ave} , Wh/km; EC _{exHigh,ave} , Wh/km; EC _{DC,COP,ave} , Wh/km.	6
Output step 5	EC _{WLTC} , Wh/km; EC _{city} , Wh/km; EC _{low} , Wh/km; EC _{med} , Wh/km; EC _{high} , Wh/km; EC _{exHigh} , Wh/km.			
Output step 3	EC _{DC,COP,1} , Wh/km.			
Output step 6	EC _{WLTC,dec} , Wh/km; EC _{WLTC,ave} , Wh/km; EC _{DC,COP,ave} , Wh/km.	Determination of the adjustment factor and application to EC _{DC,COP,ave} . For example: $AF = \frac{EC_{WLTC,dec}}{EC_{WLTC,ave}}$ EC _{DC,COP} = EC _{DC,COP,ave} × AF In the case that the interpolation method is applied, the output is available for vehicle L and vehicle H.	EC _{DC,COP} , Wh/km.	7

▼ M3

Source	Input	Process	Output	Step no.
Output step 6	$PER_{city,ave}$, km; $PER_{low,ave}$, km; $PER_{med,ave}$, km; $PER_{high,ave}$, km; $PER_{exHigh,ave}$, km; $EC_{city,ave}$, Wh/km; $EC_{low,ave}$, Wh/km; $EC_{med,ave}$, Wh/km; $EC_{high,ave}$, Wh/km; $EC_{exHigh,ave}$, Wh/km;	Intermediate rounding. $EC_{DC,COP,final}$ In the case that the interpolation method is applied, the output is available for vehicle L and vehicle H.	$PER_{city,final}$, km; $PER_{low,final}$, km; $PER_{med,final}$, km; $PER_{high,final}$, km; $PER_{exHigh,final}$, km; $EC_{city,final}$, Wh/km; $EC_{low,final}$, Wh/km; $EC_{med,final}$, Wh/km; $EC_{high,final}$, Wh/km; $EC_{exHigh,final}$, Wh/km;	8
Output step 7	$EC_{DC,COP}$, Wh/km.		$EC_{DC,COP,final}$, Wh/km.	
Output step 6	$PER_{WLTC,dec}$, km; $EC_{WLTC,dec}$, Wh/km; $PER_{city,final}$, km; $PER_{low,final}$, km; $PER_{med,final}$, km; $PER_{high,final}$, km; $PER_{exHigh,final}$, km; $EC_{city,final}$, Wh/km; $EC_{low,final}$, Wh/km; $EC_{med,final}$, Wh/km; $EC_{high,final}$, Wh/km; $EC_{exHigh,final}$, Wh/km; $EC_{DC,COP,final}$, Wh/km.	Interpolation in accordance with paragraph 4.5. of this Sub-Annex and final rounding as defined in Table A8/2. $EC_{DC,COP,ind}$ Output available for each individual vehicle.	$PER_{WLTC,ind}$, km; $PER_{city,ind}$, km; $PER_{low,ind}$, km; $PER_{med,ind}$, km; $PER_{high,ind}$, km; $PER_{exHigh,ind}$, km; $EC_{WLTC,ind}$, Wh/km; $EC_{city,ind}$, Wh/km; $EC_{low,ind}$, Wh/km; $EC_{med,ind}$, Wh/km; $EC_{high,ind}$, Wh/km; $EC_{exHigh,ind}$, Wh/km;	9
Output step 8			$EC_{DC,COP,ind}$, Wh/km.	

▼ **B**

Sub-Annex 8

Appendix 1

REESS state of charge profile

1. Test sequences and REESS profiles: OVC-HEVs, charge-depleting and charge-sustaining test

1.1. Test sequence OVC-HEVs according to option 1:

Charge-depleting type 1 test with no subsequent charge-sustaining Type 1 test (A8.App1/1)

Figure A8.App1/1

OVC-HEVs, charge-depleting Type 1 test

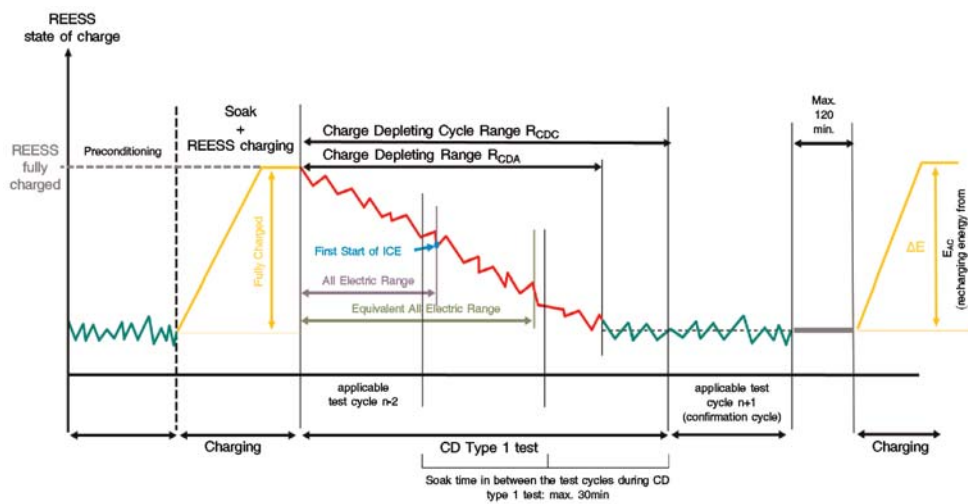

1.2. Test sequence OVC-HEVs according to option 2:

Charge-sustaining Type 1 test with no subsequent charge-depleting Type 1 test (A8.App1/2)

Figure A8.App1/2

OVC-HEVs, charge-sustaining Type 1 test

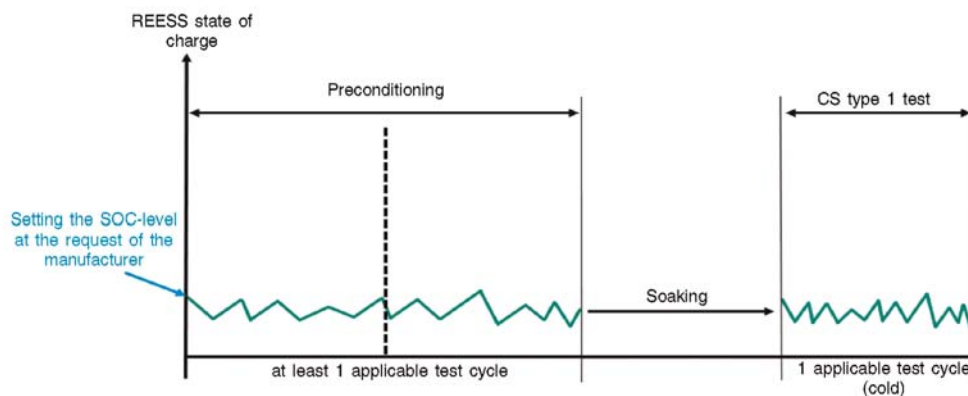

▼B

1.3. Test sequence OVC-HEVs according to option 3:

Charge-depleting Type 1 test with subsequent charge-sustaining Type 1 test
(A8.App1/3)

Figure A8.App1/3

OVC-HEVs, charge-depleting type 1 test with subsequent charge-sustaining Type 1 test

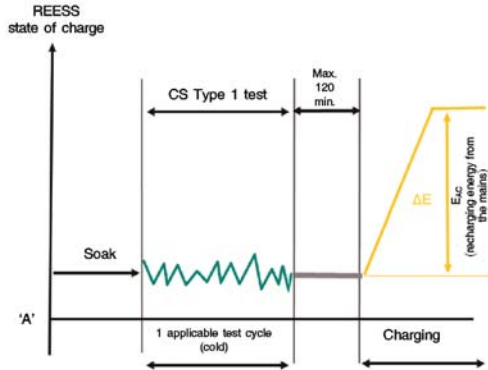
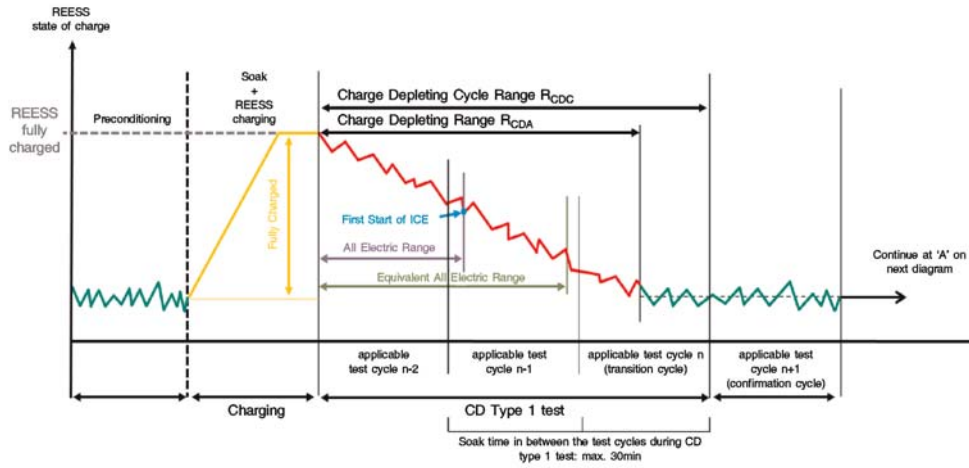

▼ M3

1.4. Test sequence OVC-HEVs in accordance with option 4

Charge-sustaining Type 1 test with subsequent charge-depleting Type 1 test
(Figure A8.App1/4)

Figure A8.App1/4

OVC-HEVs, charge-sustaining Type 1 test with subsequent charge-depleting Type 1 test

▼ B

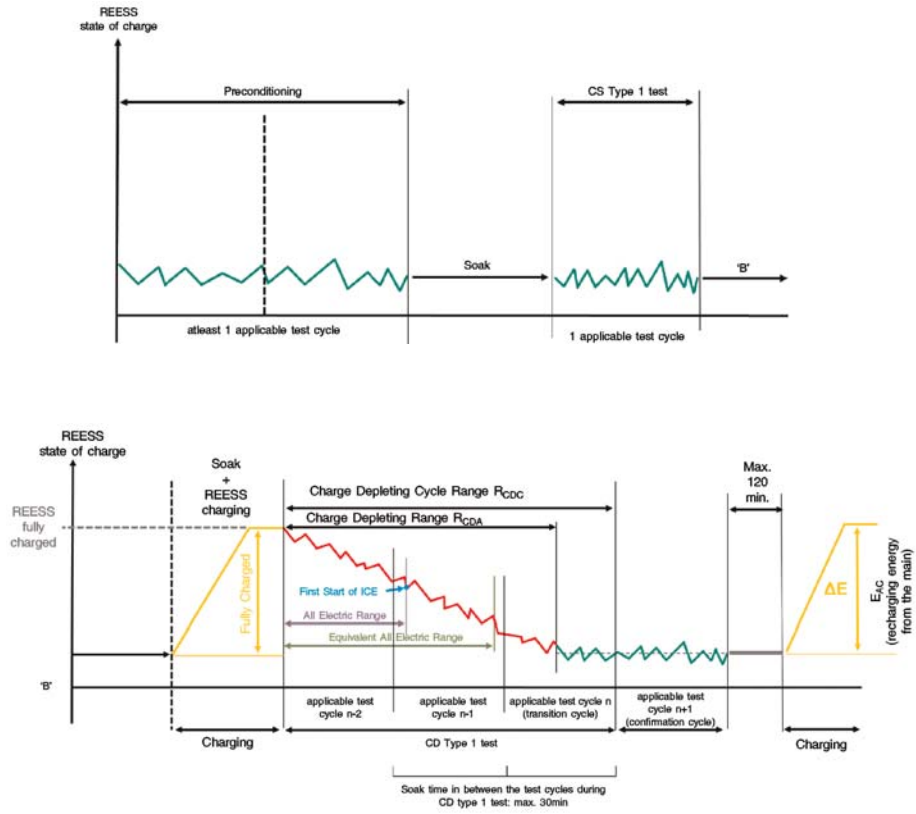

▼ B

- 2. Test sequence NOVC-HEVs and NOVC-FCHVs
Charge-sustaining Type 1 test

Figure A8.App1/5

NOVC-HEVs and NOVC-FCHVs, charge-sustaining Type 1 test

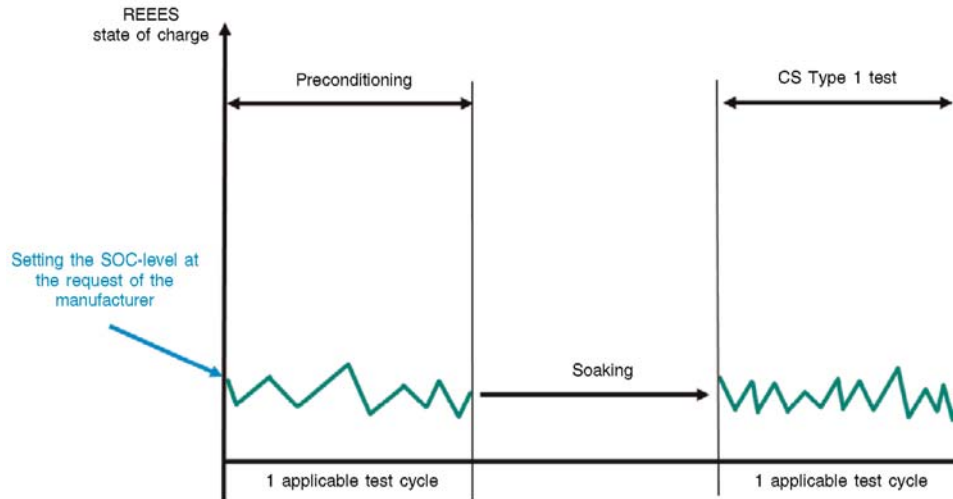

- 3. Test sequences PEV
 - 3.1. Consecutive cycles procedure

Figure A8.App1/6

Consecutive cycles test sequence PEV

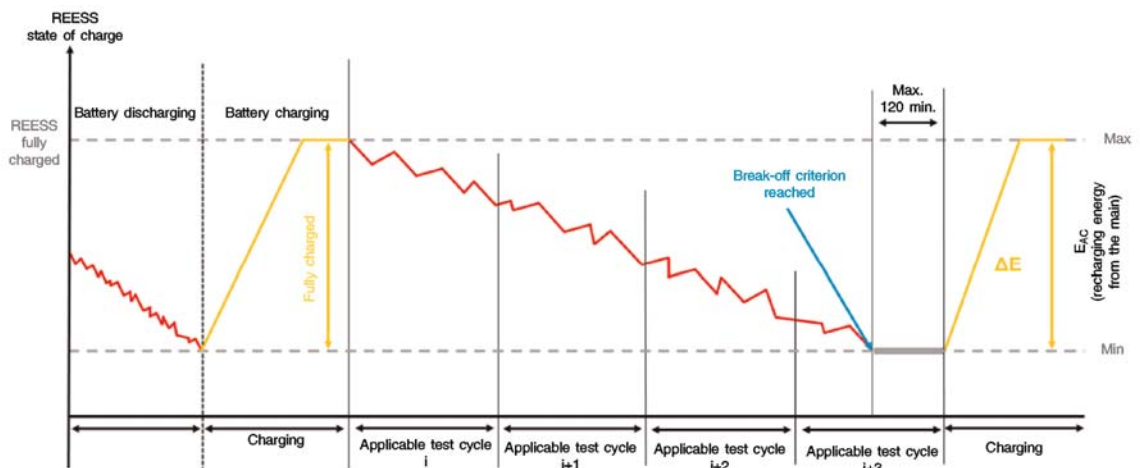

▼ **B**

3.2. Shortened Test Procedure

Figure A8.App1/7

Shortened test procedure test sequence for PEVs

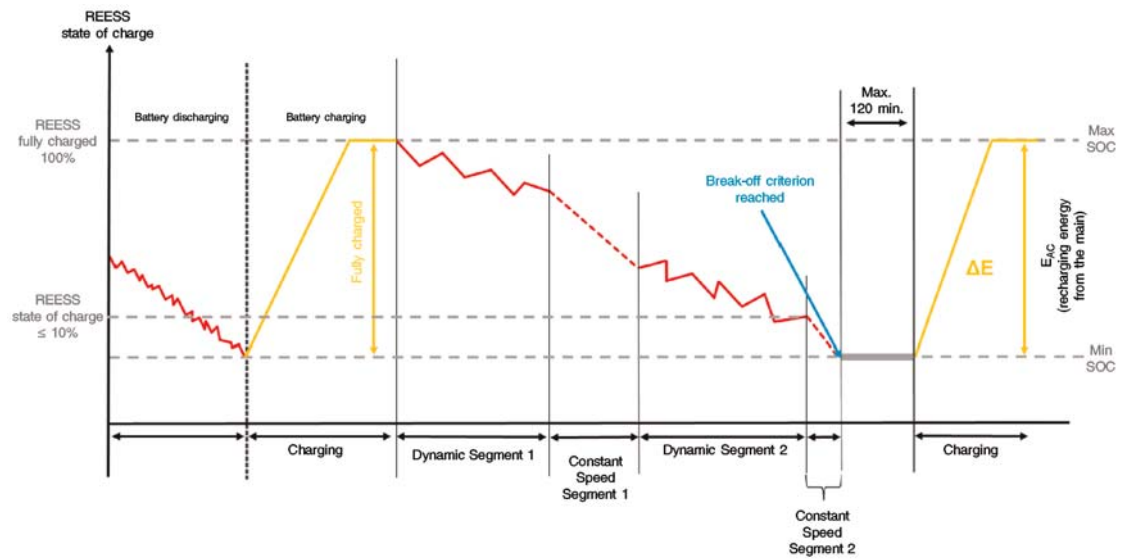

▼ B*Sub-Annex 8**Appendix 2***REESS energy change-based correction procedure**

This Appendix describes the procedure to correct the charge-sustaining Type 1 test CO₂ mass emission for NOVC-HEVs and OVC-HEVs, and the fuel consumption for NOVC-FCHVs as a function of the electric energy change of all REESSs.

1. General requirements
 - 1.1. Applicability of this Appendix
 - 1.1.1. The phase-specific fuel consumption for NOVC-FCHVs, and the CO₂ mass emission for NOVC-HEVs and OVC-HEVs shall be corrected.
 - 1.1.2. In the case that a correction of fuel consumption for NOVC-FCHVs or a correction of CO₂ mass emission for NOVC-HEVs and OVC-HEVs measured over the whole cycle according to paragraph 1.1.3. or paragraph 1.1.4. of this Appendix is applied, paragraph 4.3. of this Sub-Annex shall be used to calculate the charge-sustaining REESS energy change $\Delta E_{\text{REESS,CS}}$ of the charge-sustaining Type 1 test. The considered period *j* used in paragraph 4.3. of this Sub-Annex is defined by the charge-sustaining Type 1 test.

▼ M3

- 1.1.3. The correction shall be applied if $\Delta E_{\text{REESS,CS}}$ is negative which corresponds to REESS discharging and the correction criterion *c* calculated in paragraph 1.2. of this Appendix is greater than the applicable threshold in accordance with Table A8.App2/1.
- 1.1.4. The correction may be omitted and uncorrected values may be used if:
 - (a) $\Delta E_{\text{REESS,CS}}$ is positive which corresponds to REESS charging and the correction criterion *c* calculated in paragraph 1.2. of this Appendix is greater than the applicable threshold in accordance with Table A8.App2/1;
 - (b) The correction criterion *c* calculated in paragraph 1.2. of this Appendix is smaller than the applicable threshold in accordance with Table A8.App2/1;
 - (c) The manufacturer can prove to the approval authority by measurement that there is no relation between $\Delta b_{\text{REESS,CS}}$ and charge-sustaining CO₂ mass emission and $\Delta m_{\text{REESS,CS}}$ and fuel consumption respectively.

▼ B

- 1.2. The correction criterion *c* is the ratio between the absolute value of the REESS electric energy change $\Delta E_{\text{REESS,CS}}$ and the fuel energy and shall be calculated as follows:

$$c = \frac{|\Delta E_{\text{REESS,CS}}|}{E_{\text{fuel,CS}}}$$

where:

$\Delta E_{\text{REESS,CS}}$ is the charge-sustaining REESS energy change according to paragraph 1.1.2. of this Appendix, Wh;

▼ M3

$E_{\text{fuel,CS}}$ is the charge-sustaining energy content of the consumed fuel in accordance with paragraph 1.2.1. of this Appendix in the case of NOVC-HEVs and OVC-HEVs, and in accordance with paragraph 1.2.2. of this Appendix in the case of NOVC-FCHVs, Wh.

▼ B

1.2.1. Charge-sustaining fuel energy for NOVC-HEVs and OVC-HEVs

The charge-sustaining energy content of the consumed fuel for NOVC-HEVs and OVC-HEVs shall be calculated using the following equation:

$$E_{\text{fuel,CS}} = 10 \times HV \times FC_{\text{CS,nb}} \times d_{\text{CS}}$$

where:

$E_{\text{fuel,CS}}$ is the charge-sustaining energy content of the consumed fuel of the applicable WLTP test cycle of the charge-sustaining Type 1 test, Wh;

HV is the heating value according to Table A6.App2/1, kWh/l;

$FC_{\text{CS,nb}}$ is the non-balanced charge-sustaining fuel consumption of the charge-sustaining Type 1 test, not corrected for the energy balance, determined according to paragraph 6. of Sub-Annex 7, using the gaseous emission compound values according to Table A8/5, step no. 2, l/100 km;

d_{CS} is the distance driven over the corresponding applicable WLTP test cycle, km;

10 conversion factor to Wh.

1.2.2. Charge-sustaining fuel energy for NOVC-FCHVs

The charge-sustaining energy content of the consumed fuel for NOVC-FCHVs shall be calculated using the following equation:

$$E_{\text{fuel,CS}} = \frac{1}{0,36} \times 121 \times FC_{\text{CS,nb}} \times d_{\text{CS}}$$

$E_{\text{fuel,CS}}$ is the charge-sustaining energy content of the consumed fuel of the applicable WLTP test cycle of the charge-sustaining Type 1 test, Wh;

121 is the lower heating value of hydrogen, MJ/kg;

$FC_{\text{CS,nb}}$ is the non-balanced charge-sustaining fuel consumption of the charge-sustaining Type 1 test, not corrected for the energy balance, determined according to Table A8/7, step no.1, kg/100 km;

d_{CS} is the distance driven over the corresponding applicable WLTP test cycle, km;

$\frac{1}{0,36}$ conversion factor to Wh.

▼ M3

Table A8.App2/1

RCB correction criteria thresholds

Applicable Type 1 test cycle	Low + Medium	Low + Medium + High	Low + Medium + High + Extra High
Thresholds for correction criterion c	0,015	0,01	0,005

▼ B

2. Calculation of correction coefficients
- 2.1. The CO₂ mass emission correction coefficient K_{CO₂}, the fuel consumption correction coefficients K_{fuel,FCHV}, as well as, if required by the manufacturer, the phase-specific correction coefficients K_{CO₂,p} and K_{fuel,FCHV,p} shall be developed based on the applicable charge-sustaining Type 1 test cycles.

In the case that vehicle H was tested for the development of the correction coefficient for CO₂ mass emission for NOVC-HEVs and OVC-HEVs, the coefficient may be applied within the interpolation family.

- 2.2. The correction coefficients shall be determined from a set of charge-sustaining Type 1 tests according to paragraph 3. of this Appendix. The number of tests performed by the manufacturer shall be equal to or greater than five.

The manufacturer may request to set the state of charge of the REESS prior to the test according to the manufacturer's recommendation and as described in paragraph 3. of this Appendix. This practice shall only be used for the purpose of achieving a charge-sustaining Type 1 test with opposite sign of the ΔE_{REESS,CS} and with approval of the approval authority.

The set of measurements shall fulfil the following criteria:

▼ M3

- (a) The set shall contain at least one test with ΔE_{REESS,CS,n} ≤ 0 and at least one test with ΔE_{REESS,CS,n} > 0. ΔE_{REESS,CS,n} is the sum of electric energy changes of all REESSs of test n calculated in accordance with paragraph 4.3. of this Sub-Annex.

▼ B

- (b) The difference in M_{CO₂,CS} between the test with the highest negative electric energy change and the test with the highest positive electric energy change shall be greater than or equal to 5 g/km. This criterion shall not be applied for the determination of K_{fuel,FCHV}.

In the case of the determination of K_{CO₂}, the required number of tests may be reduced to three tests if all of the following criteria are fulfilled in addition to (a) and (b):

- (c) the difference in M_{CO₂,CS} between any two adjacent measurements, related to the electric energy change during the test, shall be less than or equal to 10 g/km.
- (d) in addition to (b), the test with the highest negative electric energy change and the test with the highest positive electric energy change shall not be within the region that is defined by:

$$-0,01 \leq \frac{\Delta E_{\text{REESS}}}{E_{\text{fuel}}} \leq +0,01,$$

▼ B

where:

E_{fuel} is the energy content of the consumed fuel calculated according to paragraph 1.2. of this Appendix, Wh.

▼ M3

- (e) The difference in $M_{\text{CO}_2,\text{CS}}$ between the test with the highest negative electric energy change and the mid-point, and the difference in $M_{\text{CO}_2,\text{CS}}$ between the mid-point and the test with the highest positive electric energy change shall be similar. The mid-point should preferably be within the range defined by (d). If this requirement is not feasible, the approval authority shall decide if a retest is necessary.

The correction coefficients determined by the manufacturer shall be reviewed and approved by the approval authority prior to its application.

If the set of at least five tests does not fulfil criterion (a) or criterion (b) or both, the manufacturer shall provide evidence to the approval authority as to why the vehicle is not capable of meeting either or both criteria. If the approval authority is not satisfied with the evidence, it may require additional tests to be performed. If the criteria after additional tests are still not fulfilled, the approval authority shall determine a conservative correction coefficient, based on the measurements.

▼ B

2.3. Calculation of correction coefficients $K_{\text{fuel,FCHV}}$ and K_{CO_2}

2.3.1. Determination of the fuel consumption correction coefficient $K_{\text{fuel,FCHV}}$

For NOVC-FCHVs, the fuel consumption correction coefficient $K_{\text{fuel,FCHV}}$, determined by driving a set of charge-sustaining Type 1 tests, is defined using the following equation:

$$K_{\text{fuel,FCHV}} = \frac{\sum_{n=1}^{n_{\text{CS}}} \left((EC_{\text{DC,CS},n} - EC_{\text{DC,CS,avg}}) \times (FC_{\text{CS,nb},n} - FC_{\text{CS,nb,avg}}) \right)}{\sum_{n=1}^{n_{\text{CS}}} (EC_{\text{DC,CS},n} - EC_{\text{DC,CS,avg}})^2}$$

where:

$K_{\text{fuel,FCHV}}$ is the fuel consumption correction coefficient, (kg/100 km)/(Wh/km);

$EC_{\text{DC,CS},n}$ is the charge-sustaining electric energy consumption of test n based on the REESS depletion according to the equation below, Wh/km

$EC_{\text{DC,CS,avg}}$ is the mean charge-sustaining electric energy consumption of n_{CS} tests based on the REESS depletion according to the equation below, Wh/km;

$FC_{\text{CS,nb},n}$ is the charge-sustaining fuel consumption of test n, not corrected for the energy balance, according to Table A8/7, step no. 1, kg/100 km;

$FC_{\text{CS,nb,avg}}$ is the arithmetic average of the charge-sustaining fuel consumption of n_{CS} tests based on the fuel consumption, not corrected for the energy balance, according to the equation below, kg/100 km;

▼ B

n is the index number of the considered test;

n_{CS} is the total number of tests;

and:

$$EC_{DC,CS,avg} = \frac{1}{n_{CS}} \times \sum_{n=1}^{n_{CS}} EC_{DC,CS,n}$$

and:

$$FC_{CS,nb,avg} = \frac{1}{n_{CS}} \times \sum_{n=1}^{n_{CS}} FC_{CS,nb,n}$$

and:

$$EC_{DC,CS,n} = \frac{\Delta E_{REESS,CS,n}}{d_{CS,n}}$$

where:

$\Delta E_{REESS,CS,n}$ is the charge-sustaining REESS electric energy change of test n according to paragraph 1.1.2. of this Appendix, Wh;

$d_{CS,n}$ is the distance driven over the corresponding charge-sustaining Type 1 test n , km.

The fuel consumption correction coefficient shall be rounded to four significant figures. The statistical significance of the fuel consumption correction coefficient shall be evaluated by the approval authority.

2.3.1.1. It is permitted to apply the fuel consumption correction coefficient that was developed from tests over the whole applicable WLTP test cycle for the correction of each individual phase.

2.3.1.2. Without prejudice to the requirements of paragraph 2.2. of this Appendix, at the manufacturer's request and upon approval of the approval authority, separate fuel consumption correction coefficients $K_{fuel,FCHV,p}$ for each individual phase may be developed. In this case, the same criteria as described in paragraph 2.2. of this Appendix shall be fulfilled in each individual phase and the procedure described in paragraph 2.3.1. of this Appendix shall be applied for each individual phase to determine each phase specific correction coefficient.

2.3.2. Determination of CO₂ mass emission correction coefficient K_{CO_2}

For OVC-HEVs and NOVC-HEVs, the CO₂ mass emission correction coefficient K_{CO_2} , determined by driving a set of charge-sustaining Type 1 tests, is defined by the following equation:

$$K_{CO_2} = \frac{\sum_{n=1}^{n_{CS}} \left((EC_{DC,CS,n} - EC_{DC,CS,avg}) \times (M_{CO_2,CS,nb,n} - M_{CO_2,CS,nb,avg}) \right)}{\sum_{n=1}^{n_{CS}} (EC_{DC,CS,n} - EC_{DC,CS,avg})^2}$$

▼ B

where:

K_{CO_2} is the CO₂ mass emission correction coefficient, (g/km)/(Wh/km);

$EC_{DC,CS,n}$ is the charge-sustaining electric energy consumption of test n based on the REESS depletion according to paragraph 2.3.1. of this Appendix, Wh/km;

$EC_{DC,CS,avg}$ is the arithmetic average of the charge-sustaining electric energy consumption of n_{cs} tests based on the REESS depletion according to paragraph 2.3.1. of this Appendix, Wh/km;

$M_{CO_2,CS,nb,n}$ is the charge-sustaining CO₂ mass emission of test n, not corrected for the energy balance, calculated according Table A8/5, step no. 2, g/km;

$M_{CO_2,CS,nb,avg}$ is the arithmetic average of the charge-sustaining CO₂ mass emission of n_{cs} tests based on the CO₂ mass emission, not corrected for the energy balance, according to the equation below, g/km;

n is the index number of the considered test;

n_{cs} is the total number of tests;

and:

$$M_{CO_2,CS,nb,avg} = \frac{1}{n_{CS}} \times \sum_{n=1}^{n_{cs}} M_{CO_2,CS,nb,n}$$

The CO₂ mass emission correction coefficient shall be rounded to four significant figures. The statistical significance of the CO₂ mass emission correction coefficient shall be evaluated by the approval authority.

2.3.2.1. It is permitted to apply the CO₂ mass emission correction coefficient developed from tests over the whole applicable WLTP test cycle for the correction of each individual phase.

2.3.2.2. Without prejudice to the requirements of paragraph 2.2. of this Appendix, at the request of the manufacturer upon approval of the approval authority, separate CO₂ mass emission correction coefficients $K_{CO_2,p}$ for each individual phase may be developed. In this case, the same criteria as described in paragraph 2.2. of this Appendix shall be fulfilled in each individual phase and the procedure described in paragraph 2.3.2. of this Appendix shall be applied for each individual phase to determine phase-specific correction coefficients.

3. Test procedure for the determination of the correction coefficients

3.1. OVC-HEVs

For OVC-HEVs, one of the following test sequences according to Figure A8.App2/1 shall be used to measure all values that are necessary for the determination of the correction coefficients according to paragraph 2. of this Appendix.

▼B

Figure A8.App2/1
OVC-HEV test sequences

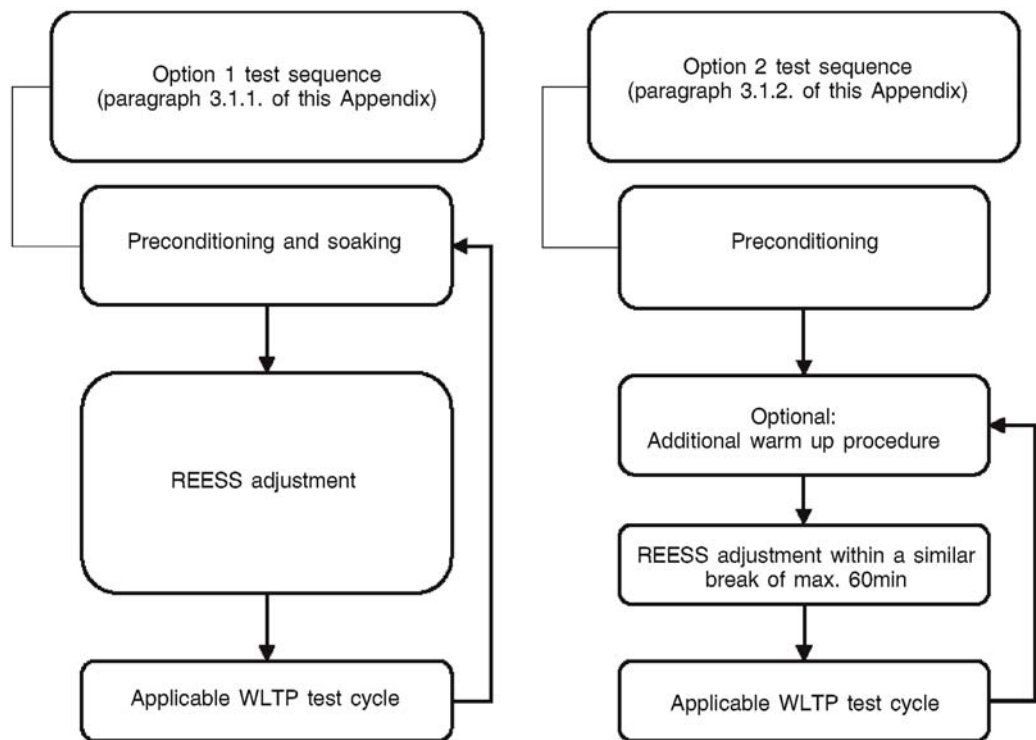

3.1.1. Option 1 test sequence

3.1.1.1. Preconditioning and soaking

Preconditioning and soaking shall be conducted according to paragraph 2.1. of Appendix 4. to this Sub-Annex.

▼M3

3.1.1.2. REESS adjustment

Prior to the test procedure in accordance with paragraph 3.1.1.3. of this Appendix, the manufacturer may adjust the REESS. The manufacturer shall provide evidence that the requirements for the beginning of the test in accordance with paragraph 3.1.1.3. of this Appendix are fulfilled.

▼B

3.1.1.3. Test procedure

3.1.1.3.1. The driver-selectable mode for the applicable WLTP test cycle shall be selected according to paragraph 3. of Appendix 6 to this Sub-Annex.

3.1.1.3.2. For testing, the applicable WLTP test cycle according to paragraph 1.4.2. of this Sub-Annex shall be driven.

3.1.1.3.3. Unless stated otherwise in this Appendix, the vehicle shall be tested according to the Type 1 test procedure described in Sub-Annex 6.

3.1.1.3.4. To obtain a set of applicable WLTP test cycles required for the determination of the correction coefficients, the test may be followed by a number of consecutive sequences required according to paragraph 2.2 of this Appendix consisting of paragraph 3.1.1.1. to paragraph 3.1.1.3. inclusive of this Appendix.

▼ B

3.1.2. Option 2 test sequence

3.1.2.1. Preconditioning

The test vehicle shall be preconditioned according to paragraph 2.1.1. or paragraph 2.1.2. of Appendix 4 to this Sub-Annex.

3.1.2.2. REESS adjustment

After preconditioning, soaking according to paragraph 2.1.3. of Appendix 4 to this Sub-Annex shall be omitted and a break, during which the REESS is permitted to be adjusted, shall be set to a maximum duration of 60 minutes. A similar break shall be applied in advance of each test. Immediately after the end of this break, the requirements of paragraph 3.1.2.3. of this Appendix shall be applied.

Upon request of the manufacturer, an additional warm-up procedure may be conducted in advance of the REESS adjustment to ensure similar starting conditions for the correction coefficient determination. If the manufacturer requests this additional warm-up procedure, the identical warm-up procedure shall be applied repeatedly within the test sequence.

3.1.2.3. Test procedure

3.1.2.3.1. The driver-selectable mode for the applicable WLTP test cycle shall be selected according to paragraph 3. of Appendix 6 to this Sub-Annex.

3.1.2.3.2. For testing, the applicable WLTP test cycle according to paragraph 1.4.2. of this Sub-Annex shall be driven.

3.1.2.3.3. Unless stated otherwise in this Appendix, the vehicle shall be tested according to the Type 1 test procedure described in Sub-Annex 6.

3.1.2.3.4. To obtain a set of applicable WLTP test cycles that are required for the determination of the correction coefficients, the test may be followed by a number of consecutive sequences required according to paragraph 2.2. of this Appendix consisting of paragraphs 3.1.2.2. and 3.1.2.3. of this Appendix.

3.2. NOVC-HEVs and NOVC-FCHVs

For NOVC-HEVs and NOVC-FCHVs, one of the following test sequences according to Figure A8.App2/2 shall be used to measure all values that are necessary for the determination of the correction coefficients according to paragraph 2. of this Appendix.

▼ **B**

Figure A8.App2/2

NOVC-HEV and NOVC-FCHV test sequences

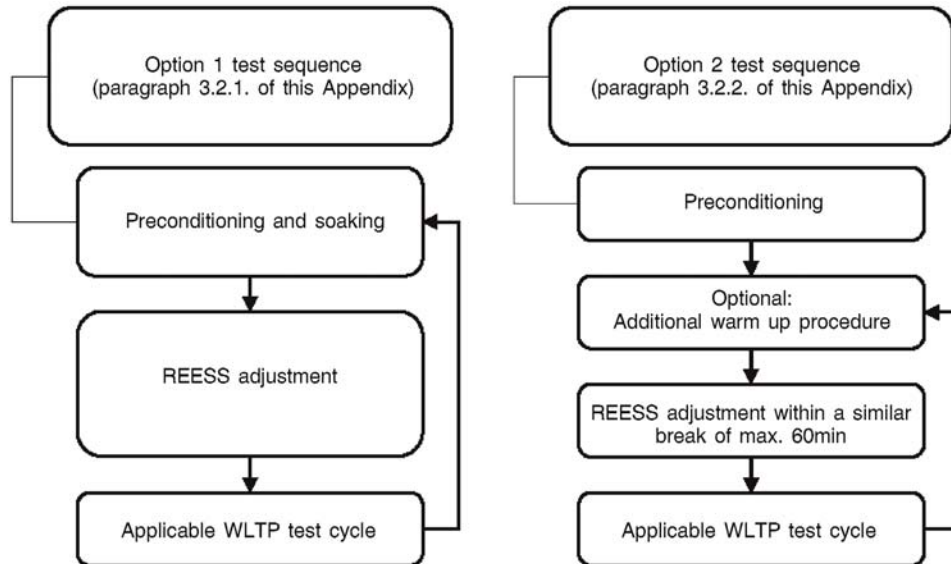

3.2.1. Option 1 test sequence

3.2.1.1. Preconditioning and soaking

The test vehicle shall be preconditioned and soaked according to paragraph 3.3.1. of this Sub-Annex.

3.2.1.2. REESS adjustment

Prior to the test procedure, according to paragraph 3.2.1.3., the manufacturer may adjust the REESS. The manufacturer shall provide evidence that the requirements for the beginning of the test according to paragraph 3.2.1.3. are fulfilled.

3.2.1.3. Test procedure

3.2.1.3.1. The driver-selectable mode shall be selected according to paragraph 3. of Appendix 6 to this Sub-Annex.

3.2.1.3.2. For testing, the applicable WLTP test cycle according to paragraph 1.4.2. of this Sub-Annex shall be driven.

3.2.1.3.3. Unless stated otherwise in this Appendix, the vehicle shall be tested according to the charge-sustaining Type 1 test procedure described in Sub-Annex 6.

3.2.1.3.4. To obtain a set of applicable WLTP test cycles that are required for the determination of the correction coefficients, the test can be followed by a number of consecutive sequences required according to paragraph 2.2. of this Appendix consisting of paragraph 3.2.1.1. to paragraph 3.2.1.3. inclusive of this Appendix.

3.2.2. Option 2 test sequence

3.2.2.1. Preconditioning

The test vehicle shall be preconditioned according to paragraph 3.3.1.1. of this Sub-Annex.

▼ B

3.2.2.2. REESS adjustment

After preconditioning, the soaking according to paragraph 3.3.1.2. of this Sub-Annex shall be omitted and a break, during which the REESS is permitted to be adjusted, shall be set to a maximum duration of 60 minutes. A similar break shall be applied in advance of each test. Immediately after the end of this break, the requirements of paragraph 3.2.2.3. of this Appendix shall be applied.

Upon request of the manufacturer, an additional warm-up procedure may be conducted in advance of the REESS adjustment to ensure similar starting conditions for the correction coefficient determination. If the manufacturer requests this additional warm-up procedure, the identical warm-up procedure shall be applied repeatedly within the test sequence.

3.2.2.3. Test procedure

3.2.2.3.1. The driver-selectable mode for the applicable WLTP test cycle shall be selected according to paragraph 3. of Appendix 6 to this Sub-Annex.

3.2.2.3.2. For testing, the applicable WLTP test cycle according to paragraph 1.4.2. of this Sub-Annex shall be driven.

3.2.2.3.3. Unless stated otherwise in this Appendix, the vehicle shall be tested according to the Type 1 test procedure described in Sub-Annex 6.

3.2.2.3.4. To get a set of applicable WLTP test cycles that are required for the determination of the correction coefficients, the test can be followed by a number of consecutive sequences required according to paragraph 2.2. of this Appendix consisting of paragraphs 3.2.2.2. and 3.2.2.3. of this Appendix.

▼B*Sub-Annex 8**Appendix 3***Determination of REESS current and REESS voltage for NOVC-HEVs, OVC-HEVs, PEVs and NOVC-FCHVs**

1. Introduction
 - 1.1. This Appendix defines the method and required instrumentation to determine the REESS current and the REESS voltage of NOVC-HEVs, OVC-HEVs, PEVs and NOVC-FCHVs.
 - 1.2. Measurement of REESS current and REESS voltage shall start at the same time as the test starts and shall end immediately after the vehicle has finished the test.
 - 1.3. The REESS current and the REESS voltage of each phase shall be determined.
 - 1.4. A list of the instrumentation used by the manufacturer to measure REESS voltage and current (including instrument manufacturer, model number, serial number, last calibration dates (where applicable)) during:
 - (a) the Type 1 test according to paragraph 3 of this Sub-Annex,
 - (b) the procedure to determine the correction coefficients according to Appendix 2 of this Sub-Annex (where applicable),
 - (c) the ATCT as specified in Sub-Annex 6a

shall be provided to the approval authority.

2. REESS current

REESS depletion is considered as a negative current.

 - 2.1. External REESS current measurement
 - 2.1.1. The REESS current(s) shall be measured during the tests using a clamp-on or closed type current transducer. The current measurement system shall fulfil the requirements specified in Table A8/1 of this Sub-Annex. The current transducer(s) shall be capable of handling the peak currents at engine starts and temperature conditions at the point of measurement.

▼M3

In order to have an accurate measurement, zero adjustment and degaussing shall be performed before the test in accordance with the instrument manufacturer's instructions.

▼B

- 2.1.2. Current transducers shall be fitted to any of the REESS on one of the cables connected directly to the REESS and shall include the total REESS current.

In case of shielded wires, appropriate methods shall be applied in accordance with the approval authority.

In order to easily measure the REESS current using external measuring equipment, the manufacturer should provide appropriate, safe and accessible connection points in the vehicle. If that is not feasible, the manufacturer is obliged to support the approval authority in connecting a current transducer to one of the cables directly connected to the REESS in the manner described above in this paragraph.

▼ B

2.1.3. The current transducer output shall be sampled with a minimum frequency of 20 Hz. The measured current shall be integrated over time, yielding the measured value of Q, expressed in ampere-hours Ah. The integration may be done in the current measurement system.

2.2. Vehicle on-board REESS current data

As an alternative to paragraph 2.1. of this Appendix, the manufacturer may use the on-board current measurement data. The accuracy of these data shall be demonstrated to the approval authority.

3. REESS voltage

3.1. External REESS voltage measurement

During the tests described in paragraph 3. of this Sub-Annex, the REESS voltage shall be measured with the equipment and accuracy requirements specified in paragraph 1.1. of this Sub-Annex. To measure the REESS voltage using external measuring equipment, the manufacturers shall support the approval authority by providing REESS voltage measurement points.

▼ M3

3.2. Nominal REESS voltage

For NOVC-HEVs, NOVC-FCHVs and OVC-HEVs, instead of using the measured REESS voltage in accordance with paragraph 3.1. of this Appendix, the nominal voltage of the REESS determined in accordance with IEC 60050-482 may be used.

▼ B

3.3. Vehicle on-board REESS voltage data

As an alternative to paragraph 3.1. and 3.2. of this Appendix, the manufacturer may use the on-board voltage measurement data. The accuracy of these data shall be demonstrated to the approval authority.

▼ B*Sub-Annex 8**Appendix 4***Preconditioning, soaking and REESS charging conditions of PEVs and OVC-HEVs**

1. This Appendix describes the test procedure for REESS and combustion engine preconditioning in preparation for:
 - (a) Electric range, charge-depleting and charge-sustaining measurements when testing OVC-HEVs; and
 - (b) Electric range measurements as well as electric energy consumption measurements when testing PEVs.
2. OVC-HEV preconditioning and soaking
 - 2.1. Preconditioning and soaking when the test procedure starts with a charge-sustaining test
 - 2.1.1. For preconditioning the combustion engine, the vehicle shall be driven over at least one applicable WLTP test cycle. During each driven preconditioning cycle, the charging balance of the REESS shall be determined. The preconditioning shall be stopped at the end of the applicable WLTP test cycle during which the break-off criterion is fulfilled according to paragraph 3.2.4.5. of this Sub-Annex.
 - 2.1.2. As an alternative to paragraph 2.1.1. of this Appendix, at the request of the manufacturer and upon approval of the approval authority, the state of charge of the REESS for the charge-sustaining Type 1 test may be set according to the manufacturer's recommendation in order to achieve a test under charge-sustaining operating condition.

▼ M3

In such a case, a preconditioning procedure, such as that applicable to pure ICE vehicles as described in paragraph 2.6. of Sub-Annex 6, shall be applied.

- 2.1.3. Soaking of the vehicle shall be performed in accordance with paragraph 2.7. of Sub-Annex 6.

▼ B

- 2.2. Preconditioning and soaking when the test procedure starts with a charge-depleting test
 - 2.2.1. OVC-HEVs shall be driven over at least one applicable WLTP test cycle. During each driven preconditioning cycle, the charging balance of the REESS shall be determined. The preconditioning shall be stopped at the end of the applicable WLTP test cycle during which the break-off criterion is fulfilled according to paragraph 3.2.4.5. of this Sub-Annex.

▼ M3

- 2.2.2. Soaking of the vehicle shall be performed in accordance with paragraph 2.7. of Sub-Annex 6. Forced cooling down shall not be applied to vehicles preconditioned for the Type 1 test. During soak, the REESS shall be charged using the normal charging procedure as defined in paragraph 2.2.3. of this Appendix.

▼B

2.2.3. Application of a normal charge

2.2.3.1. ►**M3** The REESS shall be charged at an ambient temperature as specified in paragraph 2.2.2.2. of Sub-Annex 6 either with: ◀

- (a) The on-board charger if fitted; or
- (b) An external charger recommended by the manufacturer using the charging pattern prescribed for normal charging.

The procedures in this paragraph exclude all types of special charges that could be automatically or manually initiated, e.g. equalization charges or servicing charges. The manufacturer shall declare that, during the test, a special charge procedure has not occurred.

2.2.3.2. End-of-charge criterion

The end-of-charge criterion is reached when the on-board or external instruments indicate that the REESS is fully charged.

3. PEV preconditioning

3.1. Initial charging of the REESS

Initial charging of the REESS consists of discharging the REESS and applying a normal charge.

3.1.1. Discharging the REESS

The discharge procedure shall be performed according to the manufacturer's recommendation. The manufacturer shall guarantee that the REESS is as fully depleted as is possible by the discharge procedure.

3.1.2. Application of a normal charge

The REESS shall be charged according to paragraph 2.2.3.1. of this Appendix.

▼ **M3***Sub-Annex 8 - Appendix 5***Utility factors (UF) for OVC-HEVs**

1. Reserved.
2. The methodology recommended for the determination of a UF curve based on driving statistics is described in SAE J2841 (Sept. 2010, Issued 2009-03, Revised 2010-09).
3. For the calculation of a fractional utility factor UF_j for the weighting of period j , the following equation shall be applied by using the coefficients from Table A8.App5/1.

$$UF_j(d_j) = 1 - \exp \left\{ - \left(\sum_{i=1}^k C_i \times \left(\frac{d_j}{d_n} \right)^i \right) \right\} - \sum_{l=1}^{j-1} UF_l$$

where:

UF_j utility factor for period j ;

d_j measured distance driven at the end of period j , km;

C_i i th coefficient (see Table A8.App5/1);

d_n normalized distance (see Table A8.App5/1), km;

k number of terms and coefficients in the exponent;

j number of period considered;

i number of considered term/coefficient;

$\sum_{l=1}^{j-1} UF_l$ sum of calculated utility factors up to period $(j - 1)$.

Table A8.App5/1

Parameters for the determination of fractional UFs

Parameter	Value
d_n	800 km
C1	26,25
C2	- 38,94

▼ M3

Parameter	Value
C3	– 631,05
C4	5 964,83
C5	– 25 095
C6	60 380,2
C7	– 87 517
C8	75 513,8
C9	– 35 749
C10	7 154,94

▼ B*Sub-Annex 8**Appendix 6***Selection of driver-selectable modes**

1. General requirement

▼ M3

- 1.1. The manufacturer shall select the driver-selectable mode for the Type 1 test procedure in accordance with paragraphs 2. to 4. of this Appendix which enables the vehicle to follow the considered test cycle within the speed trace tolerances in accordance with paragraph 2.6.8.3. of Sub-Annex 6. This shall apply to all vehicle systems with driver-selectable modes including those not solely specific to the transmission.
- 1.2. The manufacturer shall provide evidence to the approval authority concerning:
 - (a) The availability of a predominant mode under the considered conditions;
 - (b) The maximum speed of the considered vehicle;

and if required:

 - (c) The best and worst case mode identified by the evidence on the fuel consumption and, if applicable, on the CO₂ mass emission in all modes. See paragraph 2.6.6.3. of Sub-Annex 6;
 - (d) The highest electric energy consuming mode;
 - (e) The cycle energy demand (in accordance with Sub-Annex 7, paragraph 5. where the target speed is replaced by the actual speed).
- 1.3. Dedicated driver-selectable modes, such as ‘mountain mode’ or ‘maintenance mode’ which are not intended for normal daily operation but only for special limited purposes, shall not be considered.

▼ B

2. OVC-HEV equipped with a driver-selectable mode under charge-depleting operating condition

For vehicles equipped with a driver-selectable mode, the mode for the charge-depleting Type 1 test shall be selected according to the following conditions.

▼ M3

The flow chart in Figure A8.App6/1 illustrates the mode selection in accordance with this paragraph.

▼ B

- 2.1. If there is a predominant mode that enables the vehicle to follow the reference test cycle under charge-depleting operating condition, this mode shall be selected.
- 2.2. If there is no predominant mode or if there is a predominant mode but this mode does not enable the vehicle to follow the reference test cycle under charge-depleting operating condition, the mode for the test shall be selected according to the following conditions:
 - (a) If there is only one mode which allows the vehicle to follow the reference test cycle under charge-depleting operating conditions, this mode shall be selected;

▼ **B**

- (b) If several modes are capable of following the reference test cycle under charge-depleting operating conditions, the most electric energy consuming mode of those shall be selected.
- 2.3. If there is no mode according to paragraph 2.1. and paragraph 2.2. of this Appendix that enables the vehicle to follow the reference test cycle, the reference test cycle shall be modified according to paragraph 9 of Sub-Annex 1:

- (a) If there is a predominant mode which allows the vehicle to follow the modified reference test cycle under charge-depleting operating conditions, this mode shall be selected.
- (b) If there is no predominant mode but other modes which allow the vehicle to follow the modified reference test cycle under charge-depleting operating condition, the mode with the highest electric energy consumption shall be selected.
- (c) If there is no mode which allows the vehicle to follow the modified reference test cycle under charge-depleting operating condition, the mode or modes with the highest cycle energy demand shall be identified and the mode with the highest electric energy consumption shall be selected.

▼ **M3**

Figure A8.App6/1

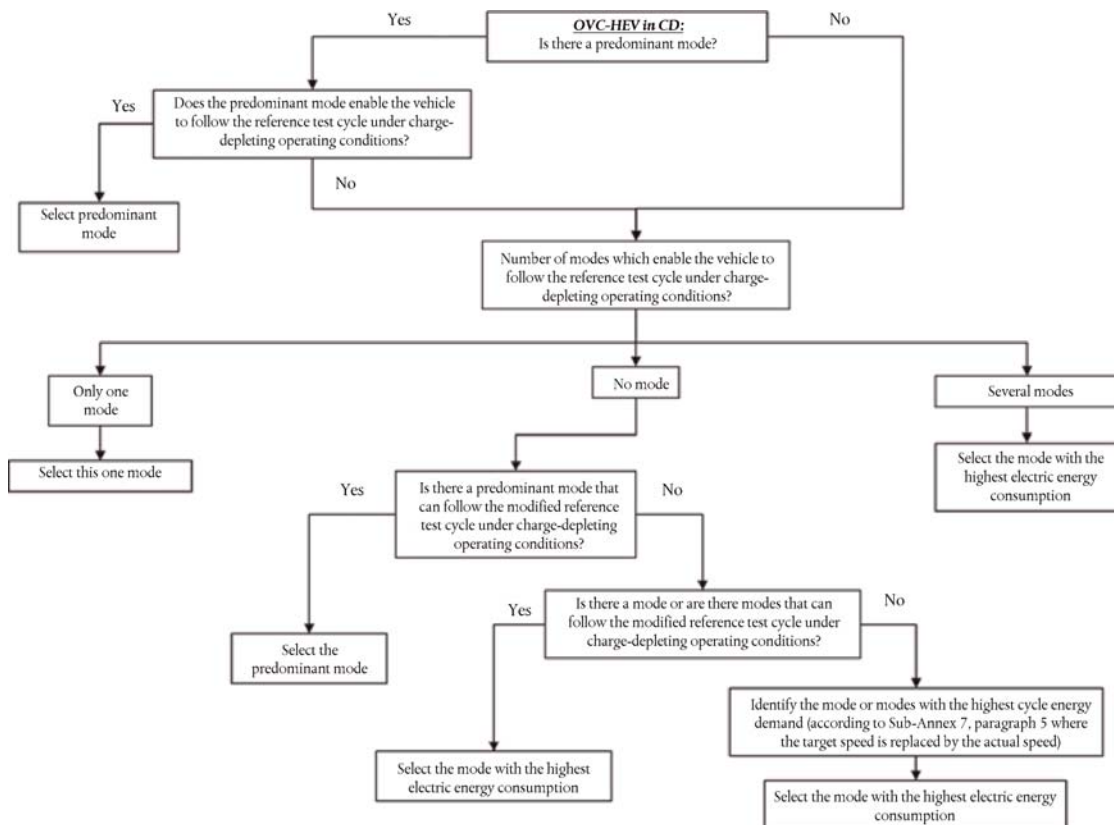
Selection of driver-selectable mode for OVC-HEVs under charge-depleting operating condition

▼ B

3. OVC-HEVs, NOVC-HEVs and NOVC-FCHVs equipped with a driver-selectable mode under charge-sustaining operating condition

For vehicles equipped with a driver-selectable mode, the mode for the charge-sustaining Type 1 test shall be selected according to the following conditions.

▼ M3

The flow chart in Figure A8.App6/2 illustrates the mode selection in accordance with this paragraph.

▼ B

- 3.1. If there is a predominant mode that enables the vehicle to follow the reference test cycle under charge-sustaining operating condition, this mode shall be selected.
- 3.2. If there is no predominant mode or if there is a predominant mode but this mode does not enable the vehicle to follow the reference test cycle under charge-sustaining operating condition, the mode for the test shall be selected according to the following conditions:
 - (a) If there is only one mode which allows the vehicle to follow the reference test cycle under charge-sustaining operating conditions, this mode shall be selected;
 - (b) If several modes are capable of following the reference test cycle under charge-sustaining operating conditions, it shall be at the option of the manufacturer either to select the worst case mode or to select both best case mode and worst case mode and average the test results arithmetically.
- 3.3. If there is no mode according to paragraph 3.1. and paragraph 3.2. of this Appendix that enables the vehicle to follow the reference test cycle, the reference test cycle shall be modified according to paragraph 9. of Sub-Annex 1:
 - (a) If there is a predominant mode which allows the vehicle to follow the modified reference test cycle under charge-sustaining operating condition, this mode shall be selected.
 - (b) If there is no predominant mode but other modes which allow the vehicle to follow the modified reference test cycle under charge-sustaining operating condition, the worst case mode of these modes shall be selected.
 - (c) If there is no mode which allows the vehicle to follow the modified reference test cycle under charge-sustaining operating condition, the mode or modes with the highest cycle energy demand shall be identified and the worst case mode shall be selected.

▼ **M3**

Figure A8.App6/2

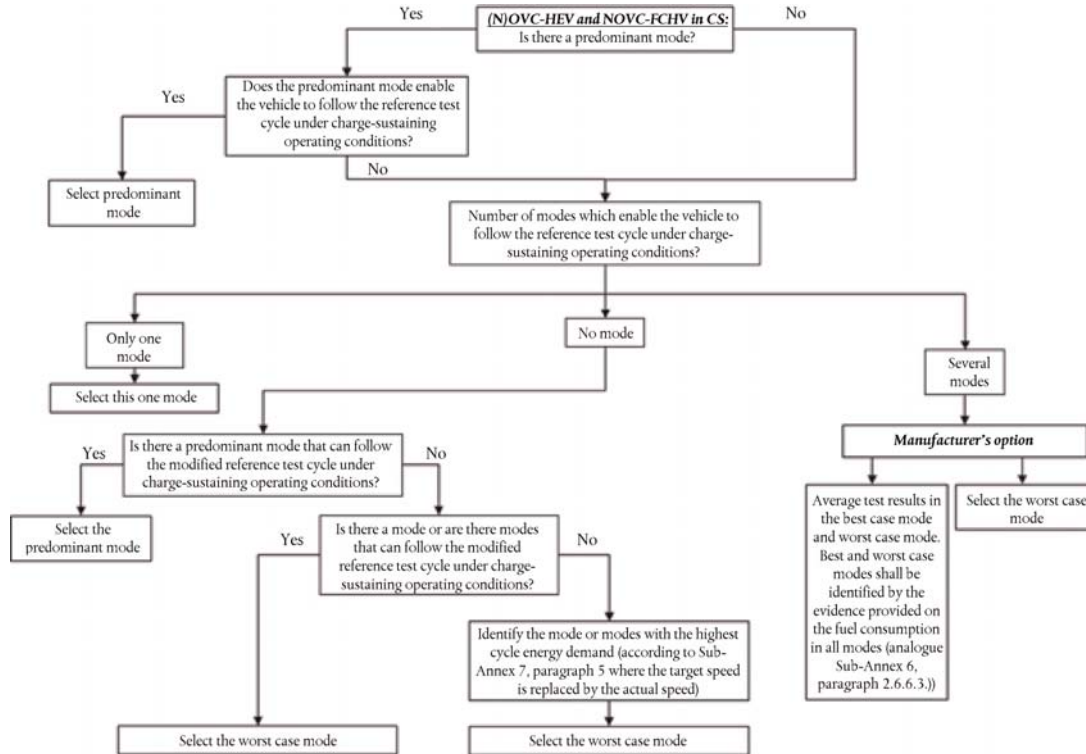
Selection of a driver-selectable mode for OVC-HEVs, NOVC-HEVs and NOVC- FCHVs under charge-sustaining operating condition▼ **B**

4. PEVs equipped with a driver-selectable mode

For vehicles equipped with a driver-selectable mode, the mode for the test shall be selected according to the following conditions.

▼ **M3**

The flow chart in Figure A8.App6/3 illustrates the mode selection in accordance with this paragraph.

▼ **B**

- 4.1. If there is a predominant mode that enables the vehicle to follow the reference test cycle, this mode shall be selected.
- 4.2. If there is no predominant mode or if there is a predominant mode but this mode does not enable the vehicle to follow the reference test cycle, the mode for the test shall be selected according to the following conditions.
 - (a) If there is only one mode which allows the vehicle to follow the reference test cycle, this mode shall be selected.
 - (b) If several modes are capable of following the reference test cycle, the most electric energy consuming mode of those shall be selected.
- 4.3. If there is no mode according to paragraph 4.1. and paragraph 4.2. of this Appendix that enables the vehicle to follow the reference test cycle, the reference test cycle shall be modified according to paragraph 9. of Sub-Annex 1. The resulting test cycle shall be named as the applicable WLTP test cycle:

▼ B

- (a) If there is a predominant mode which allows the vehicle to follow the modified reference test cycle, this mode shall be selected;
- (b) If there is no predominant mode but other modes which allow the vehicle to follow the modified reference test cycle, the mode with the highest electric energy consumption shall be selected;
- (c) If there is no mode which allows the vehicle to follow the modified reference test cycle, the mode or modes with the highest cycle energy demand shall be identified and the mode with the highest electric energy consumption shall be selected.

▼ M3

Figure A8.App6/3

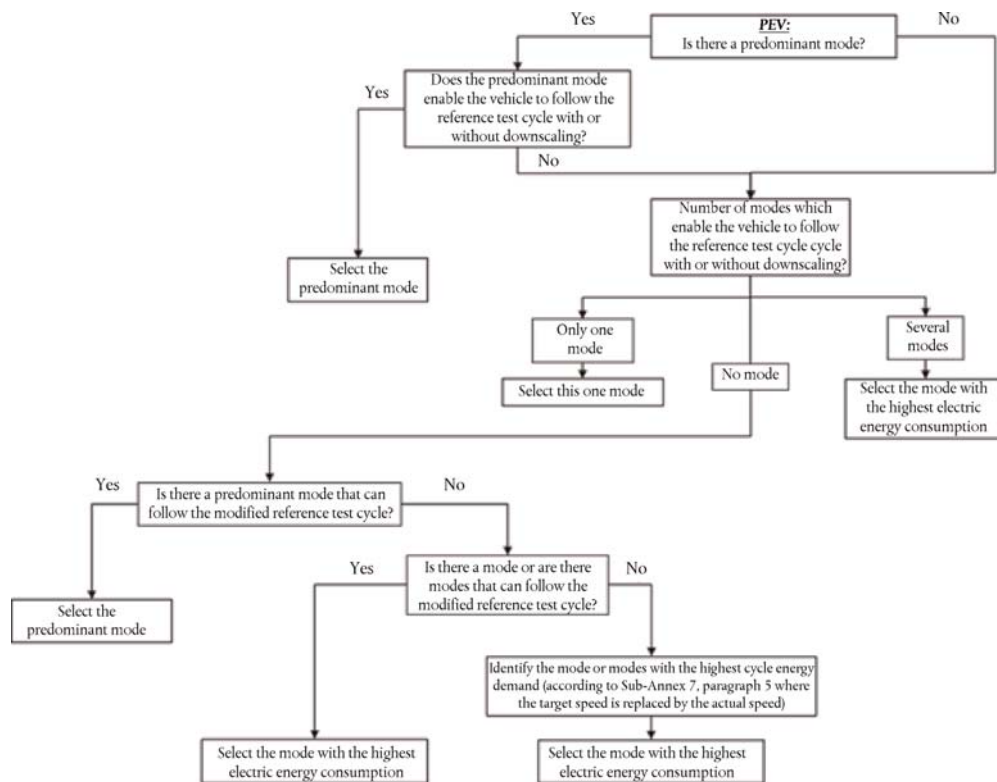
Selection of the driver-selectable mode for PEVs

▼ **M3***Sub-Annex - 8 Appendix 7***Fuel consumption measurement of compressed hydrogen fuel cell hybrid vehicles**

1. General requirements

Fuel consumption shall be measured using the gravimetric method in accordance with paragraph 2. of this Appendix.

At the request of the manufacturer and with approval of the approval authority, fuel consumption may be measured using either the pressure method or the flow method. In this case, the manufacturer shall provide technical evidence that the method yields equivalent results. The pressure and flow methods are described in ISO 23828:2013.

2. Gravimetric method

Fuel consumption shall be calculated by measuring the mass of the fuel tank before and after the test.

2.1. Equipment and setting

2.1.1. An example of the instrumentation is shown in Figure A8.App7/1. One or more off-vehicle tanks shall be used to measure the fuel consumption. The off-vehicle tank(s) shall be connected to the vehicle fuel line between the original fuel tank and the fuel cell system.

2.1.2. For preconditioning, the originally installed tank or an external source of hydrogen may be used.

2.1.3. The refuelling pressure shall be adjusted to the manufacturer's recommended value.

2.1.4. Difference of the gas supply pressures in lines shall be minimized when the lines are switched.

In the case that influence of pressure difference is expected, the manufacturer and the approval authority shall agree whether correction is necessary or not.

2.1.5. Balance

2.1.5.1. The balance used for fuel consumption measurement shall meet the specification of Table A8.App7/1.

*Table A8.App7/1***Analytical balance verification criteria**

Measurement system	Resolution	Precision
Balance	0,1 g maximum	± 0,02 maximum ⁽¹⁾

⁽¹⁾ Fuel consumption (REESS charge balance = 0) during the test, in mass, standard deviation.

2.1.5.2. The balance shall be calibrated in accordance with the specifications provided by the balance manufacturer or at least as often as specified in Table A8.App7/2.

▼ **M3**

Table A8.App7/2

Instrument calibration intervals

Instrument checks	Interval
Precision	Yearly and at major maintenance

- 2.1.5.3. Appropriate means for reducing the effects of vibration and convection, such as a damping table or a wind barrier, shall be provided.

Figure A8.App7/1

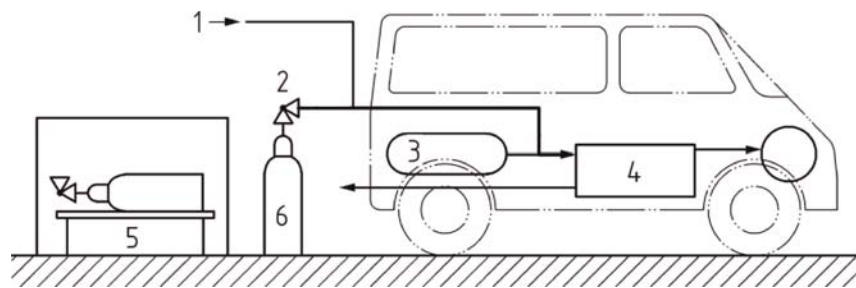
Example of instrumentation

where:

- 1 is the external fuel supply for preconditioning
 - 2 is the pressure regulator
 - 3 is the original tank
 - 4 is the fuel cell system
 - 5 is the balance
 - 6 is/are off-vehicle tank(s) for fuel consumption measurement
- 2.2. Test procedure
- 2.2.1. The mass of the off-vehicle tank shall be measured before the test.
- 2.2.2. The off-vehicle tank shall be connected to the vehicle fuel line as shown in Figure A8.App7/1.
- 2.2.3. The test shall be conducted by fuelling from the off-vehicle tank.
- 2.2.4. The off-vehicle tank shall be removed from the line.
- 2.2.5. The mass of the tank after the test shall be measured.
- 2.2.6. The non-balanced charge-sustaining fuel consumption $FC_{CS,nb}$ from the measured mass before and after the test shall be calculated using the following equation:

▼ M3

$$FC_{CS,nb} = \frac{g_1 - g_2}{d} \times 100$$

where:

$FC_{CS,nb}$ is the non-balanced charge-sustaining fuel consumption measured during the test, kg/100 km;

g_1 is the mass of the tank at the start of the test, kg;

g_2 is the mass of the tank at the end of the test, kg;

d is the distance driven during the test, km.

*Sub-Annex 9***Determination of method equivalency**

1. General Requirement

Upon request of the manufacturer, other measurement methods may be approved by the approval authority if they yield equivalent results in accordance with paragraph 1.1. of this Sub-Annex. The equivalence of the candidate method shall be demonstrated to the approval authority.

1.1. Decision on Equivalency

A candidate method shall be considered equivalent if the accuracy and the precision is equal to or better than the reference method.

1.2. Determination of Equivalency

The determination of method equivalency shall be based on a correlation study between the candidate and the reference methods. The methods to be used for correlation testing shall be subject to approval by the approval authority.

The basic principle for the determination of accuracy and precision of candidate and reference methods shall follow the guidelines in ISO 5725 Part 6 Annex 8 'Comparison of alternative Measurement Methods'.

1.3. Implementation requirements

Reserved

▼ **M3**

ANNEX XXII

Devices for monitoring on board the vehicle the consumption of fuel and/or electric energy**1. Introduction**

This Annex sets out the definitions and requirements applicable to the devices for monitoring on board the vehicle the consumption of fuel and/or electric energy.

2. Definitions

- 2.1 ‘*On-board Fuel and/or Energy Consumption Monitoring Device*’ (‘OBFCM device’) means any element of design, either software and/or hardware, which senses and uses vehicle, engine, fuel and/or electric energy parameters to determine and make available at least the information laid down in point 3, and store the lifetime values on board the vehicle.
- 2.2 ‘*Lifetime*’ value of a certain quantity determined and stored at a time t shall be the values of this quantity accumulated since the completion of production of the vehicle until time t .
- 2.3 ‘*Engine fuel rate*’ means the amount of fuel injected into the engine per unit of time. It does not include fuel injected directly into the pollution control device.
- 2.4 ‘*Vehicle fuel rate*’ means the amount of fuel injected into the engine and directly into the pollution control device per unit of time. It does not include the fuel used by a fuel operated heater.
- 2.5 ‘*Total Fuel Consumed (lifetime)*’ means the accumulation of the calculated amount of fuel injected into the engine and the calculated amount of fuel injected directly into the pollution control device. It does not include the fuel used by a fuel operated heater.
- 2.6 ‘*Total Distance Travelled (lifetime)*’ means the accumulation of the distance travelled using the same data source that the vehicle odometer uses.
- 2.7 ‘*Grid energy*’ means, for OVC-HEVs, the electric energy flowing into the battery when the vehicle is connected to an external power supply and the engine is turned off. It shall not include electrical losses between the external power source and the battery.
- 2.8 ‘*Charge sustaining operation*’ means, for OVC-HEVs, the state of vehicle operation when the REESS state of charge (SOC) may fluctuate but the intent of the vehicle control system is to maintain, on average, the current state of charge.
- 2.9 ‘*Charge depleting operation*’ means, for OVC-HEVs, the state of vehicle operation when the current REESS SOC is higher than the charge sustaining target SOC value and, while it may fluctuate, the intent of the vehicle control system is to deplete the SOC from a higher level down to the charge sustaining target SOC value.

▼ **M3**

2.10 ‘*Driver-selectable charge increasing operation*’ means, for OVC-HEVs, the operating condition in which the driver has selected a mode of operation, with the intention to increase the REESS SOC.

3. **Information to be determined, stored and made available**

The OBFCM device shall determine at least the following parameters and store the lifetime values on board the vehicle. The parameters shall be calculated and scaled according the standards referred to in points 6.5.3.2 (a) of Paragraph 6.5.3. of Appendix 1 to Annex 11 to UN/ECE Regulation No 83, understood as set out in Point 2.8. of Appendix 1 to Annex XI to this Regulation.

3.1. *For all vehicles referred to in Article 4a, with the exception of OVC-HEVs:*

- (a) Total fuel consumed (lifetime) (litres);
- (b) total distance travelled (lifetime) (kilometres);
- (c) engine fuel rate (grams/second);
- (d) engine fuel rate (litres/hour);
- (e) vehicle fuel rate (grams/second);
- (f) vehicle speed (kilometres/hour).

3.2. *For OVC-HEVs:*

- (a) Total fuel consumed (lifetime) (litres);
- (b) total fuel consumed in charge depleting operation (lifetime) (litres);
- (c) total fuel consumed in driver-selectable charge increasing operation (lifetime) (litres);
- (d) total distance travelled (lifetime) (kilometres);
- (e) total distance travelled in charge depleting operation with engine off (lifetime) (kilometres);
- (f) total distance travelled in charge depleting operation with engine running (lifetime) (kilometres);
- (g) total distance travelled in driver-selectable charge increasing operation (lifetime) (kilometres);
- (h) engine fuel rate (grams/second);
- (i) engine fuel rate (litres/hour);
- (j) vehicle fuel rate (grams/second);
- (k) vehicle speed (kilometres/hour);
- (l) total grid energy into the battery (lifetime) (kWh).

▼ **M3****4. Accuracy**

- 4.1 With regard to the information specified in point 3, the manufacturer shall ensure that the OBFCM device provides the most accurate values that can be achieved by the measurement and calculation system of the engine control unit.
- 4.2 Notwithstanding point 4.1, the manufacturer shall ensure that the accuracy is higher than – 0,05 and lower than 0,05 calculated with three decimals using the following formula:

$$Accuracy = \frac{Fuel_Consumed_{WLTP} - Fuel_Consumed_{OBFCM}}{Fuel_Consumed_{WLTP}}$$

Where:

Fuel_Consumed_{WLTP} (litres) is the fuel consumption determined at the first test carried out in accordance with point 1.2 of Sub-Annex 6 of Annex XXI, calculated in accordance with paragraph 6 of Sub-Annex 7 of that Annex, using emission results over the total cycle before applying corrections (output of step 2 in table A7/1 of Sub-Annex 7), multiplied by the actual distance driven and divided by 100.

Fuel_Consumed_{OBFCM} (litres) is the fuel consumption determined for the same test using the differentials of the parameter 'Total fuel consumed (lifetime)' as provided by the OBFCM device.

For OVC-HEVs the charge-sustaining Type 1 test shall be used.

- 4.2.1 If the accuracy requirements set out in point 4.2 are not met, the accuracy shall be recalculated for subsequent Type 1 tests performed in accordance with point 1.2 of Sub-Annex 6, in accordance with the formulae in point 4.2, using the fuel consumed determined and accumulated over all performed tests. The accuracy requirement shall be deemed to be fulfilled once the accuracy is higher than – 0,05 and lower than 0,05.
- 4.2.2 If the accuracy requirements set out in point 4.2.1 are not met following the subsequent tests pursuant to this point, additional tests may be performed for the purpose of determining the accuracy, however, the total number of tests shall not exceed three tests for a vehicle tested without using the interpolation method (vehicle H), and six tests for a vehicle tested using the interpolation method (three tests for vehicle H and three tests for vehicle L). The accuracy shall be recalculated for the additional subsequent Type 1 tests in accordance with the formulae in point 4.2, using the fuel consumed determined and accumulated over all performed tests. The requirement shall be deemed to be fulfilled once the accuracy is higher than – 0,05 and lower than 0,05. Where the tests have been performed only for the purpose of determining the accuracy of the OBFCM device, the results of the additional tests shall not be taken into account for any other purposes.

▼ M3

5. **Access to the information provided by the OBFCM device**
- 5.1 The OBFCM device shall provide for standardised and unrestricted access of the information specified in point 3, and shall conform to the standards referred to in points 6.5.3.1 (a) and 6.5.3.2 (a) of Paragraph 6.5.3. of Appendix 1 to Annex 11 to UN/ECE Regulation No 83, understood as set out in Point 2.8. of Appendix 1 to Annex XI to this Regulation.
- 5.2 By way of exemption from the reset conditions specified in the standards referred to in point 5.1 and notwithstanding points 5.3. and 5.4., once the vehicle has entered into service the values of the lifetime counters shall be preserved.
- 5.3 The values of the lifetime counters may be reset only for those vehicles for which the memory type of the engine control unit is unable to preserve data when not powered by electricity. For those vehicles the values may be reset simultaneously only in the case the battery is disconnected from the vehicle. The obligation to preserve the values of the lifetime counters shall in this case apply for new type approvals at the latest from 1 January 2022 and for new vehicles from 1 January 2023.
- 5.4 In the case of malfunctioning affecting the values of the lifetime counters, or replacement of the engine control unit, the counters may be reset simultaneously to ensure that the values remain fully synchronised.