STATUTORY RULES OF NORTHERN IRELAND

1996 No. 513

AGRICULTURE

**Fertilisers (Sampling and Analysis)
Regulations (Northern Ireland) 1996**

Made - - - - *31st October 1996*

Coming into operation *16th December 1996*

The Department of Agriculture in exercise of the powers conferred on it by sections 66(1), 74A, 75(1), 76(1), 77, 78(2), (4) and (6), 79(1), (2) and (9), 84 and 86(1), (2), (3), (5), (6), (7) and (9) of the Agriculture Act 1970⁽¹⁾ and of all other powers enabling it in that behalf, after consultation as required by section 84(1) of that Act with such persons or organisations as appear to it to represent the interests concerned, hereby makes the following Regulations:—

Title, commencement and interpretation

1.—(1) These Regulations may be cited as the Fertilisers (Sampling and Analysis) Regulations (Northern Ireland) 1996 and shall come into operation on 16th December 1996.

(2) In these Regulations, “the Act” means the Agriculture Act 1970.

(3) Any reference in these Regulations to a numbered section shall, unless the reference is to a section of a specified Act, be construed as a reference to the section bearing that number in the Act.

(4) The Interpretation Act (Northern Ireland) 1954⁽²⁾ shall apply to these Regulations as it applies to a Measure of the Northern Ireland Assembly.

Prescribed amount for the purposes of the definition of sampled portion

2.—(1) The prescribed amount of material for the purposes of the definition of sampled portion in section 66(1) shall be determined in accordance with the provisions of this regulation.

(2) In relation to solid fertiliser in a single container, the prescribed amount shall be the contents of the container.

(3) In relation to solid fertiliser in more than one container—

(a) if all the containers together hold less than 5 tonnes, the prescribed amount shall be the contents of all the containers;

(1) 1970 c. 40; section 74A was inserted by s. 4(1) of, and paragraph 6 of Schedule 4 to the European Communities Act 1972 (c. 68) and there are other amendments not relevant to these Regulations

(2) 1954 c. 33 (N.I.)

- (b) if any container holds at least 5 tonnes, the prescribed amount shall be 5 tonnes; and
 - (c) if neither sub-paragraph (a) nor (b) applies, the prescribed amount shall be the contents of the lowest number of containers together holding at least 5 tonnes.
- (4) In relation to solid fertiliser which is loose in a single heap or bay, the prescribed amount shall be the contents of the heap or bay.
- (5) In relation to solid fertiliser which is loose in more than one heap or bay—
- (a) if all the heaps and bays together hold less than 5 tonnes, the prescribed amount shall be the contents of all the heaps and bays;
 - (b) if each heap and bay holds at least 5 tonnes, the prescribed amount shall be the contents of any one of the heaps or bays; and
 - (c) in a case where neither sub-paragraph (a) nor (b) applies, the prescribed amount shall be the contents of a number of the heaps or bays together holding at least 5 tonnes.
- (6) In relation to fluid fertiliser in a single container, the prescribed amount shall be the contents of the container.
- (7) In relation to fluid fertiliser in more than one container—
- (a) if all the containers together hold less than 5,000 litres, the prescribed amount shall be the contents of all the containers;
 - (b) if any container holds at least 5,000 litres, the prescribed amount shall be 5,000 litres; and
 - (c) if neither sub-paragraph (a) nor (b) applies, the prescribed amount shall be the contents of the lowest number of containers together holding at least 5,000 litres.

Manner of taking, marking, sealing and fastening up of samples

3. The manner in which samples are to be taken, marked, sealed and fastened up in cases where under Part IV of the Act they are taken in the prescribed manner shall be as set out in Schedule 1.

Methods of sending part of a sample

4. Any part of a sample required to be sent to any person in pursuance of subsection (1)(b) or (2) of section 77 shall be sent by registered post or by the recorded delivery service or be delivered or given by hand.

Application of the methods of analysis

5.—(1) The methods by which analysis of fertilisers shall be made for the purposes of the Act shall be those set out in Schedule 2 in accordance with the following provisions of this regulation.

(2) Analytical constituents of materials listed in Groups 1(a), 2(a) and 3(a) of Section A, Groups 1 to 4 of Section B, Groups 1(a), 1(b) and 2 of Section C, Section D and Section E, of the table in Schedule 1 to the Fertilisers Regulations (Northern Ireland) 1992(3) shall be determined by the appropriate methods of analysis prescribed in Part I of Schedule 2.

(3) Subject to paragraph (4), analytical constituents of any materials other than those referred to in paragraph (2) shall be determined by the appropriate methods of analysis prescribed in Part II of Schedule 2, save that the following analytical constituents shall be determined by the appropriate methods prescribed in Part I of Schedule 2:

- (a) the amount of total phosphorus soluble in mineral acids;
- (b) the amount of phosphorus soluble in 2% formic acid;

- (c) the amount of phosphorus soluble in 2% citric acid;
- (d) the amount of phosphorus in any fertiliser extract; and
- (e) the amount of any trace element in any fertiliser extract.

(4) In the case of “Basic slag medium concentration” and “Granular basic slag” in Group 2(b) of Section A of the table in Schedule 1 to the Fertilisers Regulations (Northern Ireland) 1992, fineness shall be determined by the appropriate method prescribed in Part I of Schedule 2.

Form of certificate of analysis

6. The certificate of an agricultural analyst of the analysis shall be in the form set out in Schedule 3.

Modification of the Agriculture Act 1970

7. In relation to any material to which these Regulations apply the operation of the provisions of sections 66(1) and 76(5) shall be modified as follows:—

- (a) in the definition of “sampled portion” in section 66(1) for the words “five tons or 1,000 gallons or the prescribed metric substitution” there shall be substituted the words “five tonnes or 5,000 litres”;
- (b) in section 76(5), for the words “fourteen pounds or the prescribed metric substitution” there shall be substituted the words “six kilograms”.

Revocations

8. The following Regulations are hereby revoked—

- (a) the Fertilisers (Sampling and Analysis) Regulations (Northern Ireland) 1991(4);
- (b) the Fertilisers (Sampling and Analysis) (Amendment) Regulations (Northern Ireland) 1992(5); and
- (c) the Fertilisers (Sampling and Analysis) (Amendment) Regulations (Northern Ireland) 1994(6).

Sealed with the Official Seal of the Department of Agriculture for Northern Ireland on

L.S.

31st October 1996.

L. G. McKibben
Assistant Secretary

(4) S.R. 1991 No. 540
(5) S.R. 1992 No. 235
(6) S.R. 1994 No. 166

SCHEDULE 1

Regulation 3

Manner of taking, marking, sealing and fastening up of samples

Part I

Definitions

In this Schedule:—

“sampled portion” means a quantity of a material constituting a unit and having characteristics presumed to be uniform;

“incremental sample” means a quantity taken from one point in the sampled portion;

“aggregate sample” means an aggregate of incremental samples taken from the same sampled portion;

“reduced sample” means a representative part of the aggregate sample obtained from the latter by a process of reduction; and

“final sample” means a representative part of the reduced sample or, where no intermediate reduction is required, of the aggregate sample.

Part II

General instructions for the taking of samples

1. In the case of fertiliser in containers, only unopened containers which appear to the inspector proposing to take the sample to be the original containers of the fertiliser shall be selected for the purpose of sampling.

2. The sample shall be taken and prepared as quickly as possible having regard to the precautions necessary to ensure that it remains representative of the sampled portion. Instruments, surfaces and containers used in sampling shall be clean and dry.

3. No sample shall be drawn from any part of the sampled portion which appears to be damaged.

4. When stones are naturally present in a fertiliser, they shall, if possible, be broken up and mixed with the quantity from which a sample is to be drawn. Failing this they shall be removed from the mixture from which a sample is to be drawn and the weight of the residue of that mixture and the weight of the stones ascertained and reported to the analyst. In addition, a representative sample of the stones shall be sent to the analyst with the final sample.

5. An inspector who intends to take a sample in accordance with the provisions of section 76(1) on premises (not being premises used only as a dwelling) on which he has reasonable cause to believe that there is any fertiliser which the occupier of the premises has purchased, shall:—

(a) satisfy himself that the conditions in which the fertiliser is stored are not such as might cause undue deterioration of the said fertiliser and that the fertiliser appears not to have been contaminated by any other material;

(b) where he has reasonable cause to believe that fertiliser in containers is only part of an original consignment, select the number of containers to be sampled as if not less than the whole consignment were still present, except that sampling shall not take place if fewer than the minimum number of containers prescribed in Table 1 of Part VI for the purposes of paragraph 2(a) and (c) of Part III are present.

The provisions of this paragraph shall not apply as respects any fertiliser purchased for the purpose of resale in the course of trade.

6. The sampling apparatus shall be made of materials which cannot affect the characteristics of the materials to be sampled.

7. In the case of a sampling spear its dimensions shall be appropriate to the characteristics of the sampled portion in all respects including dimensions of the container and particle size of the fertiliser.

8. Notwithstanding the provisions of these Regulations, a sampling spear shall not be used if, prior to the taking of a sample, objection is raised thereto by the manufacturer on the grounds that the material is unsuitable.

9. Mechanical apparatus may be used for the sampling of moving fertilisers, if the apparatus is capable of taking samples right across the flow of the product.

10. Apparatus designed to divide the sample into approximately equal parts may be used for taking incremental samples and for the preparation of reduced and final samples.

11. A sample taken in accordance with the methods described below shall be deemed to be representative of the sampled portion.

Part III

Quantitative requirements

Sampled portion

1. The sampled portion in compliance with regulation 2 shall be such that each of its constituent parts can be sampled in accordance with the requirements of this Schedule.

Incremental sample

2. The incremental samples shall be selected in the following manner:—

(a) in the case of solid fertilisers in containers—

(i) where the content of each of the containers in the sampled portion is greater than 1 kg in weight, the number of containers shall be selected in accordance with Table 1 in Part VI;

(ii) where the content of each of the containers in the sampled portion does not exceed 1 kg in weight, the number of containers shall be selected in accordance with Table 1 in Part VI, except that the number selected shall be not less than four;

(b) in the case of loose solid fertilisers the number of incremental samples shall be selected in accordance with Table 2 in Part VI;

(c) in the case of fluid fertilisers—

(i) where each container in the sampled portion contains not more than 100 litres the number of containers shall be selected in accordance with Table 3 in Part VI;

(ii) where each container in the sampled portion contains more than 100 litres an incremental sample shall be drawn from each container.

Aggregate sample

3. The weight or volume, as appropriate, of the aggregate sample shall be not less than the following:—

Status: This is the original version (as it was originally made). This item of legislation is currently only available in its original format.

(a)	(a) solid fertilisers in containers—	
(i)	containers of more than 1 kg	4 kg
(ii)	containers not exceeding 1 kg (subject to sub-paragraph (iii))	2 kg
(iii)	containers of ammonium nitrate sampled for testing in accordance with method 14 in Part I of Schedule 2	4 kg
(b)	(b) loose solid fertilisers	4 kg
(c)	(c) fluid fertilisers—	
(i)	containers exceeding 250,000 litres	5 litres
(ii)	containers exceeding 1 litre but not exceeding 250,000 litres	4 litres
(iii)	containers not exceeding 1 litre	2 litres

Final sample

4. The weight or volume, as appropriate, of each final sample shall not be less than the following:

(a)	(a) solid fertilisers (except as mentioned in sub-paragraph (b))	500 g
(b)	(b) ammonium nitrate fertilisers sampled for testing in accordance with method 14 in Part I of Schedule 2	1 kg
(c)	(c) fluid fertilisers	500 ml

Part IV

Taking and preparation of samples

Incremental samples

1. Incremental samples of approximately equal sizes shall be taken at random throughout the whole sampled portion in the following manner:—

- (a) in the case of solid fertilisers in containers—
 - (i) having selected the required number of containers for sampling in accordance with paragraph 2(a) of Part III, part of the content of each selected container shall be taken as the incremental sample, except in the case of material to which sub-paragraph (iv) applies;
 - (ii) where necessary, each selected container shall be emptied and worked up with a shovel separately and one shovelful taken as the incremental sample;
 - (iii) when the material is of a suitable nature the incremental sample may be taken from each selected container by means of a sampling spear or by divider;

Status: This is the original version (as it was originally made). This item of legislation is currently only available in its original format.

- (iv) when the material is so packed or of such a nature that a shovel or spear or divider cannot be used, or where the content of the container does not exceed 1 kg, the whole container shall be taken as the incremental sample;
 - (v) where the fertiliser is in a coarse or lumpy condition incremental samples shall be taken in accordance with sub-paragraph (ii) or (iv) of this paragraph as appropriate. These shall be crushed immediately and the whole passed through a sieve with meshes 31.8 mm square;
 - (vi) where the fertiliser consists of bulky material, uneven in character and likely to get matted together, each selected package shall be emptied separately and the matted portions torn up and the whole of the contents of each package shall be thoroughly mixed. The incremental samples shall then be taken in accordance with sub-paragraphs (ii) or (iv) as appropriate;
- (b) in the case of loose solid fertilisers—
- (i) an imaginary division shall be made of the sampled portion into a number of approximately equal parts, corresponding to the number of incremental samples required in accordance with Table 2 in Part VI and at least one incremental sample shall be taken at random from each of these parts;
 - (ii) when sampling is being carried out while the material comprising the sampled portion is in motion, the incremental samples shall be taken from the approximately equal parts as required in sub-paragraph (b)(i);
 - (iii) when a sampling spear is used the sample shall be taken at an angle to the base of the heap;
 - (iv) where the fertiliser is in a coarse or lumpy condition, or consists of bulky material, uneven in character and likely to get matted together, the incremental samples shall be taken in accordance with the relevant provisions of paragraph 1(a)(v) or 1(a)(vi), as appropriate;
 - (v) where it is not possible to comply with the requirements of paragraph 1 of Part III when sampling fertilisers in bulk, the sampling should be carried out when the sampled portion is loaded or unloaded. In this case samples shall be taken from the randomly selected notional parts, as defined in sub-paragraph (b)(i) while these are being moved;
- (c) in the case of fluid fertilisers in containers each containing not more than 100 litres, the number of containers to be selected shall be taken in accordance with Table 3 in Part VI and
- (i) where the containers each contain not more than 1 litre the entire contents of the selected containers shall be transferred into a clean dry vessel of suitable material;
 - (ii) where the containers each contain more than 1 litre and not more than 100 litres the selected containers shall be well shaken or the contents agitated or otherwise treated to ensure uniformity. An approximately equal proportion of fluid shall then be taken immediately from each of the selected containers and transferred into a clean dry vessel of suitable material;
- (d) in the case of fluid fertilisers in containers each containing more than 100 litres—
- (i) when a consignment is being withdrawn from the container and there is a tap in the outlet pipe from which it is suitable to draw a sample, a quantity of not less than 4 litres shall be drawn from the tap (after first withdrawing sufficient to remove any residues in the pipe) into a clean dry vessel of suitable material, made up of portions not less than 0.5 litres and of approximately equal size taken at regular intervals; otherwise

Status: This is the original version (as it was originally made). This item of legislation is currently only available in its original format.

- (ii) if the liquid is homogeneous, about 1 litre shall be drawn from a convenient outlet in the container (after first withdrawing sufficient to remove any residues in the outlet) into a clean dry vessel of suitable material, or
- (iii) if the liquid is not homogeneous, the contents shall be well stirred or otherwise agitated and sampling shall then proceed as in sub-paragraph (ii), but
- (iv) if it is not possible to make the liquid homogeneous, in the manner described in sub-paragraph (iii), or if the inspector considers that the procedure in sub-paragraphs (i), (ii) and (iii) may not be appropriate, the contents shall be sampled by lowering an open tube (which must be long enough to reach the bottom of the container) perpendicularly into the container. One or both ends of the tube shall then be closed and the contents transferred into a clean dry vessel of suitable material. If sampling by tube is impracticable, portions shall be taken from various levels of the container with a sampling bottle so as to obtain a quantity fairly representative of the whole. The appropriate process shall be repeated until a quantity of not less than 4 litres has been withdrawn;
- (v) where a sampled portion consists of two or more containers, incremental samples of approximately equal size shall be taken from each, drawn in the manner described in sub-paragraphs (i), (ii), (iii) or (iv), as appropriate, and shall be placed in a clean dry vessel of suitable material.

Aggregate sample

2. The incremental samples shall be thoroughly mixed to form a single aggregate sample. In the case of solid fertilisers the material in the aggregate sample shall be carefully mixed to obtain an homogenised sample. Any lumps inconsistent with the nature of the material shall be broken up (if need be by separating them out and returning them to the aggregate sample).

Reduced sample

- (a) (a) In the case of solid fertilisers the aggregate sample shall, if necessary, be reduced to not less than 2 kg, or 4 kg for ammonium nitrate fertilisers sampled for testing in accordance with method 14 in Part I of Schedule 2, in the following manner:—
 - (i) the material shall be heaped to form a “cone”, which shall then be flattened and quartered. Two diagonally opposite quarters shall be rejected and the remainder shall then be mixed and the quartering and rejection continued as necessary; or
 - (ii) the reduction method effected by the use of a mechanical device.
- (b) In the case of fluid fertilisers if the aggregate sample consists of approximately 2 litres this may be taken as the reduced sample. In all other cases the aggregate sample shall be thoroughly mixed and a quantity of at least 2 litres transferred immediately into a clean dry vessel of suitable material.

Final samples

- 4. The final samples shall be obtained in the following manner:—
 - (a) in the case of solid fertilisers, the reduced sample or where necessary the aggregate sample shall be thoroughly mixed and divided into three or, in the circumstances set out in section 77(2), four similar and approximately equal parts, and each part placed in an appropriate airtight container;
 - (b) in the case of fluid fertilisers the reduced sample or where necessary the aggregate sample shall be thoroughly mixed and at once divided into three or, in the circumstances set

Status: This is the original version (as it was originally made). This item of legislation is currently only available in its original format.

out in section 77(2), divided into four similar and approximately equal parts by pouring successive portions into appropriate airtight containers.

The containers used shall be such that the characteristics of the fertiliser at the time of sampling are preserved. In the case of a sample e.g. ammonium nitrate which is to be tested for particle size, precautions shall be taken to ensure that the physical condition of the sample does not change between sampling and testing. Where any void would occur within the sample container the sample may be placed in a plastic bag before being put in the final container and in that event the void shall be filled with a neutral product which will not affect either the physical or chemical composition of the sample. For the tests specified in Part I of Schedule 2, Methods 14 a-g, the final samples shall be kept at a temperature between 0° and 25°C.

Part V

Marking, sealing and fastening up of the final sample

1. Each container of a final sample shall be so secured and sealed by the person taking the sample that the container cannot be opened without breaking the seal; alternatively the container may be placed in a stout envelope or in a linen, cotton or plastic bag, and this further receptacle then secured and sealed in such a manner that the contents cannot be removed without breaking the seal or the receptacle.

2. A label shall be attached to the container or receptacle containing the final sample and sealed in such a manner that it cannot be removed without the seal being broken. The label shall be marked with the following particulars, which shall be visible without the seal being broken:—

- (a) name of the inspector as well as the department to which he belongs;
- (b) identification mark given by the inspector to the sample;
- (c) place of sampling;
- (d) date of sampling;
- (e) name of the material; and
- (f) identification code, batch reference number or consignment identification of the material sampled, where readily available.

3. The container or receptacle may also be sealed, or the label also signed or initialled, by the holder of the material sampled or person acting on his behalf.

Part VI

Sampling tables

TABLE 1

FERTILISERS IN CONTAINERS

Number of containers in the sampled portion	Number of containers to be selected for sampling
1 to 4	All containers
5 to 16	not less than 4
17 to 25	not less than 5

Status: This is the original version (as it was originally made). This item of legislation is currently only available in its original format.

Number of containers in the sampled portion	Number of containers to be selected for sampling
26 to 36	not less than 6
37 to 49	not less than 7
50 to 64	not less than 8
65 to 81	not less than 9
82 to 100	not less than 10
101 to 121	not less than 11
122 to 144	not less than 12
145 to 169	not less than 13
170 to 196	not less than 14
197 to 225	not less than 15
226 to 256	not less than 16
257 to 289	not less than 17
290 to 324	not less than 18
325 to 361	not less than 19
362 and above	not less than 20

TABLE 2

LOOSE SOLID FERTILISERS

Size of sampled portion in tonnes	Number of incremental samples required
Up to and including 2.5	not less than 7
Greater than 2.5 and up to and including 3	not less than 8
Greater than 3 and up to and including 4	not less than 9
Greater than 4 and up to and including 5	not less than 10
Greater than 5 and up to and including 6	not less than 11
Greater than 6 and up to and including 7	not less than 12
Greater than 7 and up to and including 8	not less than 13
Greater than 8 and up to and including 9	not less than 14
Greater than 9 and up to and including 11	not less than 15
Greater than 11 and up to and including 12	not less than 16
Greater than 12 and up to and including 14	not less than 17
Greater than 14 and up to and including 16	not less than 18
Greater than 16 and up to and including 18	not less than 19
Greater than 18 and up to and including 20	not less than 20
Greater than 20 and up to and including 22	not less than 21

Status: This is the original version (as it was originally made). This item of legislation is currently only available in its original format.

Size of sampled portion in tonnes	Number of incremental samples required
Greater than 22 and up to and including 24	not less than 22
Greater than 24 and up to and including 26	not less than 23
Greater than 26 and up to and including 28	not less than 24
Greater than 28 and up to and including 31	not less than 25
Greater than 31 and up to and including 33	not less than 26
Greater than 33 and up to and including 36	not less than 27
Greater than 36 and up to and including 39	not less than 28
Greater than 39 and up to and including 42	not less than 29
Greater than 42 and up to and including 45	not less than 30
Greater than 45 and up to and including 48	not less than 31
Greater than 48 and up to and including 51	not less than 32
Greater than 51 and up to and including 54	not less than 33
Greater than 54 and up to and including 57	not less than 34
Greater than 57 and up to and including 61	not less than 35
Greater than 61 and up to and including 64	not less than 36
Greater than 64 and up to and including 68	not less than 37
Greater than 68 and up to and including 72	not less than 38
Greater than 72 and up to and including 76	not less than 39
Greater than 76	not less than 40

TABLE 3

FLUID FERTILISERS

Number of containers in sampled portion	Number of containers to be selected for sampling
1 to 3	All containers
4 to 20	not less than 4
21 to 60	not less than 6
61 to 100	not less than 8
101 to 400	not less than 10
More than 400	not less than 20

SCHEDULE 2

Regulation 5

Methods of analysis

Part I

General

1. When two or more methods are prescribed in this Part to determine a component of a fertiliser the choice of the method shall, except where otherwise indicated, be left to the agricultural analyst concerned; the method used must however be indicated in the certificate of analysis.

Reagents

2. Except where otherwise specified in the method of analysis, all reagents shall be of analytical quality. Where trace elements are to be determined, the purity of the reagents used shall be checked by means of a blank test.

Water

- (a) (a) Except where otherwise specified, a reference in this Part to water shall be a reference to demineralized or distilled water.
- (b) For the determination of any form of nitrogen, water shall be free of all nitrogenous compounds and carbon dioxide.
- (c) Except where the method of analysis specifies a particular solvent or diluent, all dissolution, dilution, rinsing and washing operations mentioned in the methods of analysis shall be carried out using water.

Apparatus

- (a) (a) Only special instruments and apparatus and specifically required apparatus and equipment are mentioned in the methods of analysis.
- (b) Apparatus and equipment shall be clean.
- (c) The accuracy of graduated glassware shall be assured by reference to the appropriate standards.

Methods of Analysis

- 5.—(1) Preparation of the sample for analysis
- (2) Determination of ammoniacal nitrogen
 - (a) (3) (a) Determination of nitrate and ammoniacal nitrogen — Ulsch method
 - (b) Determination of nitrate and ammoniacal nitrogen — Arnd method
 - (c) Determination of nitrate and ammoniacal nitrogen — Devarda method
- (a) (4) (a) Determination of the total nitrogen in calcium cyanamide — in the absence of nitrate
- (b) Determination of the total nitrogen in calcium cyanamide — in the presence of nitrate
- (5) Determination of total nitrogen in urea
- (6) Determination of cyanamide nitrogen

- (7) Determination of biuret in urea
 - (a) (8) (a) Determination of different forms of nitrogen in the same sample — in the presence of cyanamide nitrogen
 - (b) Determination of different forms of nitrogen in the same sample — in the absence of cyanamide nitrogen
 - (a) (9) (a) Extraction of total phosphorus — by mineral acids
 - (b) Extraction of phosphorus — by 2% formic acid
 - (c) Extraction of phosphorus — by 2% citric acid
 - (d) Extraction of phosphorus — by neutral ammonium citrate
 - (e) Extraction of phosphorus — by alkaline ammonium citrate (Petermann's method) at 65°C
 - (f) Extraction of phosphorus — by alkaline ammonium citrate (Petermann's method) at ambient temperature
 - g Extraction of phosphorus — by alkaline ammonium citrate (Joulié's method)
 - (h) Extraction of phosphorus — by water
- (10) Determination of extracted phosphorus
- (11) Determination of water-soluble potassium
- (12) Determination of chlorides in the absence of organic matter
 - (a) (13) (a) Determination of fineness of grinding — dry method
 - (b) (13) (b) Determination of fineness of grinding of soft natural phosphates
- (14) Methods of analysis and test procedures for ammonium nitrate fertiliser containing more than 28% nitrogen by weight
 - (a) Method for the application of thermal cycles
 - (b) Determination of the oil retention value
 - (c) Determination of combustible ingredients
 - (d) Determination of the pH value
 - (e) Determination of the particle size
 - (f) Determination of the chlorine content (as chloride ion)
 - (g) Determination of copper
- (15) Extraction of total calcium, total magnesium, total sodium and total sulfur in the form of sulfates
- (16) Extraction of total sulfur
- (17) Extraction of water-soluble calcium, magnesium, sodium and sulfur (in the form of sulfates)
- (18) Extraction of water-soluble sulfur
- (19) Extraction and determination of elemental sulfur
- (20) Manganimetric determination of extracted calcium following precipitation in the form of oxalate
- (21) Determination of magnesium by atomic absorption spectrometry
- (22) Determination of magnesium by complexometry
- (23) Determination of sulfates
- (24) Determination of the sodium extracted
- (25) Trace elements at a concentration less than 10%

Status: This is the original version (as it was originally made). This item of legislation is currently only available in its original format.

- (a) Extraction of total trace elements
 - (b) Extraction of water-soluble trace elements
 - (c) Removal of organic compounds from fertiliser extracts
 - (d) Determination of trace elements in fertiliser extracts by atomic absorption spectrometry (general procedure)
 - (e) Determination of boron in fertiliser extracts by means of spectrometry with azomethine-h
 - (f) Determination of cobalt in fertiliser extracts by atomic absorption spectrometry
 - (g) Determination of copper in fertiliser extracts by atomic absorption spectrometry
 - (h) Determination of iron in fertiliser extracts by atomic absorption spectrometry
 - (i) Determination of manganese in fertiliser extracts by atomic absorption spectrometry
 - (j) Determination of molybdenum in fertiliser extracts by spectrometry of a complex with ammonium thiocyanate
 - (k) Determination of zinc in fertiliser extracts by atomic absorption spectrometry
- (26) Trace elements at a concentration greater than 10%
- (a) Extraction of total trace elements
 - (b) Extraction of water-soluble trace elements
 - (c) Removal of organic compounds from fertiliser extracts
 - (d) Determination of trace elements in fertiliser extracts by atomic absorption spectrometry (general procedure)
 - (e) Determination of boron in fertiliser extracts by means of acidimetric titration
 - (f) Determination of cobalt in fertiliser extracts by the gravimetric method with 1-nitroso-2-naphthol
 - (g) Determination of copper in fertiliser extracts by the titrimetric method
 - (h) Determination of iron in fertiliser extracts by atomic absorption spectrometry
 - (i) Determination of manganese in fertiliser extracts by titration
 - (j) Determination of molybdenum in fertiliser extracts by the gravimetric method with 8-hydroxyquinoline
 - (k) Determination of zinc in fertiliser extracts by atomic absorption spectrometry

1.

PREPARATION OF THE SAMPLE FOR ANALYSIS

SCOPE

1. The following procedure is to be used for the preparation of the sample for analysis, taken from the final sample.

PRINCIPLE

2.—(2.1) Solid fertilisers: the preparation of a final sample received at the laboratory is a series of operations, usually sieving, grinding and mixing, carried out in such a way that:—

- (a) the smallest amount weighed out laid down by the methods of analysis is representative of the laboratory sample; and
- (b) the fineness of the fertiliser has not been changed by the preparation to the extent that its solubility in the various extraction reagents is appreciably affected.

(2.2) Fluid fertilisers: the final sample is mixed by shaking to ensure that any insoluble matter, particularly crystalline material, is thoroughly dispersed before each test portion is taken.

APPARATUS

- 3.—(3.1) Sample divider (optional).
- (3.2) Sieves with apertures of 0.2 mm and 0.5 mm.
- (3.3) 250 ml flasks, stoppered.
- (3.4) Porcelain pestle and mortar or grinder.

CHOICE OF TREATMENT TO BE USED

4. *Preliminary remark:* if the product is suitable, only a representative part of the final sample need be kept.

Final samples which must not be ground

(4.1) Calcium nitrate, calcium magnesium nitrate, sodium nitrate, Chile nitrate, calcium cyanamide, nitrogenous calcium cyanamide, ammonium sulfate, ammonium nitrates of over 30% N, urea, basic slag, natural phosphate rendered partially soluble, precipitated dihydrated dicalcium phosphate, calcined phosphate, aluminium calcium phosphate, soft ground rock phosphate.

Final samples which must be divided and part of which must be ground

(4.2) These are products in respect of which certain determinations are carried out without previous grinding (fineness of grinding for example) and other determinations after grinding. They include all compound fertilisers containing the following phosphate ingredients: basic slag, aluminium calcium phosphate, calcined phosphate, soft ground rock phosphate and natural phosphate rendered partially soluble. To that end, divide the final sample into two parts, which are as identical as possible, using a sample divider or by quartering.

Final samples in respect of which all determinations are carried out on a ground product

These are all the other fertilisers on the list which are not to be found under 4.1 and 4.2. The whole final sample shall be ground.

METHOD

5. The part of the final sample referred to under 4.2 and 4.3 is sieved rapidly through a sieve with apertures of 0.5 mm. The residue is ground roughly as to obtain a product in which there is a minimum of fine particles, and it is then sieved. The grinding must be done in conditions such that the substance is not appreciably heated. The operation is repeated as many times as is necessary until there is no residue, and it must be effected as quickly as possible in order to prevent any gain or loss of constituents (water, ammonia). The whole ground and sieved product is placed in a non-corrodable container provided with an air-tight closure.

Before any weighing is carried out for the analysis, the whole sample must be thoroughly mixed.

SPECIAL CASES

Fertilisers comprising a blend of several categories of crystals

- (a) In this case, separation frequently occurs. It is therefore absolutely essential to crush and pass the sample through a sieve with apertures of 0.2 mm (for example, mixtures

Status: This is the original version (as it was originally made). This item of legislation is currently only available in its original format.

of ammonium phosphate and potassium nitrate). The grinding of the whole of the final sample is recommended in the case of these products.

Residue which is difficult to grind and does not contain fertilising substances

(b) Weigh the residue and take account of its mass when calculating the final result.

Products which decompose on heating

(c) Grinding must be carried out in such a way as to avoid any heating. It is preferable in this case to use a mortar for grinding (for example, compound fertilisers containing calcium cyanamide and urea).

Products which are abnormally moist or made into a paste by grinding

(d) To ensure homogeneity, a sieve is to be chosen which has the smallest apertures compatible with the destruction of lumps by hand or with the pestle. This may be the case for mixtures, certain ingredients of which contain water of crystallisation.

FLUID FERTILISERS

7. Mix thoroughly by shaking, ensuring that any insoluble matter, particularly crystalline material, is thoroughly dispersed, immediately before drawing a portion of the sample of analysis.

2.

DETERMINATION OF AMMONIACAL NITROGEN

SCOPE

1. This method is for the determination of ammoniacal nitrogen.

FIELD OF APPLICATION

2. All nitrogenous fertilisers, including compound fertilisers, in which nitrogen is found exclusively either in the form of ammonium salts, or ammonium salts together with nitrates.

It is not applicable to fertilisers containing urea, cyanamide or other organic nitrogenous compounds.

PRINCIPLE

3. Displacement of ammonia by means of an excess of sodium hydroxide; distillation; determination of the ammonia absorbed by a given volume of a standard sulfuric acid and titration of the excess acid with a standard solution of sodium or potassium hydroxide.

REAGENTS

4.—(4.1) Hydrochloric acid solution, 50% (V/V): dilute an appropriate volume of hydrochloric acid ($\rho = 1.18 \text{ g/ml}$) with an equal volume of water.

(4.2) Sulfuric acid, 0.05 M solution } for variant (a) (see page 21)

(4.3) Sodium or potassium hydroxide, 0.1 M solution, carbonate free } for variant (a) (see page 21)

(4.4) Sulfuric acid, 0.1 M solution } for variant (b) (see page 21)

(4.5) Sodium or potassium hydroxide, 0.2 M solution, carbonate free } for variant (b) (see page 21)

- (4.6) Sulfuric acid, 0.25 M solution } for variant (c) (see page 21)
- (4.7) Sodium or potassium hydroxide, 0.5 M solution, carbonate free } for variant (c) (see page 21)
- (4.8) Sodium hydroxide solution, 30 g per 100 ml, ammonia free
- (4.9) Indicator solutions:
 - (4.9.1) Mixed indicator:

Solution A: dissolve 1 g methyl red in 37 ml sodium hydroxide 0.1 M solution and make up to 1 litre with water.

Solution B: dissolve 1 g methylene blue in water and make up to 1 litre. Mix 1 volume of solution A and 2 volumes of solution B.

This indicator is violet in acid solution, grey in neutral solution and green in alkaline solution. Use 0.5 ml (10 drops) of this indicator solution.
 - (4.9.2) Methyl red indicator solution:

Dissolve 0.1 g methyl red in 50 ml ethanol (95%) make up to 100 ml with water and filter if necessary. This indicator may be used (4 to 5 drops) instead of the preceding one.
- (4.10) Anti-bump granules of pumice stone, washed in hydrochloric acid and ignited.
- (4.11) Ammonium sulfate.

APPARATUS

- 5.—(5.1) Distillation apparatus consisting of a round-bottomed flask of suitable capacity connected to a condenser by means of a splash head.

Examples of the different types of equipment recommended for this determination are reproduced in Figures 1, 2, 3 and 4 in the Appendix.
- (5.2) Rotary shaker, 35 to 40 turns per minute.

PREPARATION OF SAMPLE

- 6. See Method 1.

PROCEDURE

Solubility test

- (7.1.1) Carry out a solubility test on the sample in water at room temperature in the proportion of 2 g per 100 ml.

Preparation of the solution

- (7.1.2) Weigh 5, 7 or 10 g of the sample to the nearest 0.001 g, as shown in the Table, and place in a 500 ml graduated flask. From the result of the solubility test, proceed as follows:
 - (a) *Products completely soluble in water*

Add sufficient water to dissolve the sample; shake, and when completely dissolved, make up to volume and mix thoroughly.
 - (b) *Products not completely soluble in water*

Add 50 ml water and then 20 ml hydrochloric acid solution (4.1). Swirl and leave undisturbed until the evolution of carbon dioxide has ceased. Add 400 ml water and

Status: This is the original version (as it was originally made). This item of legislation is currently only available in its original format.

shake for half an hour on the rotary shaker (5.2). Make up to volume with water, mix and filter through a dry paper into a dry receiver. Discard the first portion of the filtrate.

Determination

(7.2) According to the variant chosen, place in the collecting flask a measured quantity of standard sulfuric acid as indicated in the Table on page 21. Add the appropriate quantity of the chosen indicator solution (4.9.1 to 4.9.2) and, if necessary, water to obtain a volume of at least 50 ml. The condenser outlet must be below the surface of the standard acid in the collecting flask.

Transfer by pipette, according to the details given in the Table, an aliquot portion of the clear solution into the distillation flask of the apparatus. Add water to obtain a volume of about 350 ml and several grains of pumice to control the boiling.

Assemble the distillation apparatus and, taking care to avoid any loss of ammonia, add to the contents of the distillation flask 10 ml of concentrated sodium hydroxide solution (4.8) or 20 ml of the reagent in the cases where 20 ml hydrochloric acid (4.1) have been used in order to dissolve the sample. Warm the flask gently and when boiling commences distil at such a rate that about 200 ml are obtained in 30 minutes.

When no more ammonia is likely to be evolved, lower the receiving flask so that the tip of the condenser is above the surface of the liquid.

Test the subsequent distillate by means of an appropriate reagent to ensure that all the ammonia has been completely distilled. Wash the condenser with a little water and titrate the excess acid with the standard solution of sodium or potassium hydroxide prescribed for the variant adopted (see Note).

Note:

Standard solutions of different strengths may be used for the titration provided that the volumes used do not, as far as possible, exceed 40 to 45 ml.

Blank

(7.3) Carry out a blank test under the same conditions (omitting only the sample) and allow for this in the calculation of the final result.

Control test

(7.4) Before carrying out analyses, check that the apparatus is working properly and that the correct application of the method is used by taking an aliquot portion of a freshly prepared solution of ammonium sulfate (4.11) containing the maximum quantity of nitrogen prescribed for the chosen variant.

EXPRESSION OF RESULT

8. Express the result of the analysis as the percentage of ammoniacal nitrogen in the fertiliser as received for analysis using the formula

$$\%N = (50 - A) \times F \text{ for variants (a) and (b) and}$$

$$\%N = (35 - A) \times F \text{ for variant (c)}$$

where

50 (or 35 where variant (c) applies) = millilitres of standard solution of sulfuric acid in the receiving flask.

A = millilitres of sodium or potassium hydroxide used for the titration.

Status: This is the original version (as it was originally made). This item of legislation is currently only available in its original format.

F = factor taking into account the weight of sample, the dilution, the volume of the aliquot portion distilled and the volumetric equivalent.

TABLE FOR METHOD 2

Determination of the ammoniacal nitrogen and of the ammoniacal and nitrate nitrogen in fertilisers. Table of the weighing, dilution and calculation to be carried out for each of the variants (a), (b) and (c) of the method. *Variant (a)*—Approximate maximum quantity of nitrogen to be distilled = 50 mg Sulfuric acid 0.05 M to be placed in the receiving flask = 50 ml Titration with sodium or potassium hydroxide, 0.1 M solution

Declaration N%	Amount to be weighed (g)	(Volume) Dilution (ml)	Volume of sample solution to be distilled (ml)	Factor F
0-5	10	500	50	0.14
5-10	10	500	25	0.28
10-15	7	500	25	0.40
15-20	5	500	25	0.56
20-40	7	500	10	1.00

Variant (b)—Approximate maximum quantity of nitrogen to be distilled = 100 mg Sulfuric acid 0.1 M to be placed in the receiving flask = 50 ml Titration with sodium or potassium hydroxide, 0.2 M solution

Declaration N%	Amount to be weighed (g)	(Volume) Dilution (ml)	Volume of sample solution to be distilled (ml)	Factor F
0-5	10	500	100	0.14
5-10	10	500	50	0.28
10-15	7	500	50	0.40
15-20	5	500	50	0.56
20-40	7	500	50	1.00

Variant (c)—Approximate maximum quantity of nitrogen to be distilled = 200 mg Sulfuric acid 0.25 M to be placed in the receiving flask = 35 ml Titration with sodium or potassium hydroxide, 0.5 M solution

Declaration N%	Amount to be weighed (g)	(Volume) Dilution (ml)	Volume of sample solution to be distilled (ml)	Factor F
0-5	10	500	200	0.175
5-10	10	500	100	0.350
10-15	7	500	100	0.500
15-20	5	500	100	0.700
20-40	5	500	50	1.400

Status: This is the original version (as it was originally made). This item of legislation is currently only available in its original format.

3a.

DETERMINATION OF NITRIC AND AMMONIACAL NITROGEN-ULSCH METHOD

SCOPE

1. This method is for the determination of nitric and ammoniacal nitrogen with reduction according to Ulsch.

FIELD OF APPLICATION

2. All nitrogenous fertilisers, including compound fertilisers, in which nitrogen is found exclusively in nitrate form, or in ammoniacal and nitrate form.

PRINCIPLE

3. Reduction of nitrates and nitrites to ammonia by means of metallic iron in an acidic medium and displacement of the ammonia thus formed by the addition of an excess of sodium hydroxide: distillation of the ammonia and determination of the ammonia absorbed in a known volume of standard sulfuric acid solution. Titration of the excess sulfuric acid with a standard solution of sodium or potassium hydroxide.

REAGENTS

4.—(4.1) Hydrochloric acid solution, 50% (V/V): dilute an appropriate volume of hydrochloric acid ($\rho = 1.18 \text{ g/ml}$) with an equal volume of water.

(4.2) Sulfuric acid, 0.05 M solution.

(4.3) Sodium or potassium hydroxide, 0.1 M solution, carbonate free.

(4.4) Sulfuric acid solution, approximately 30% H_2SO_4 (W/V), ammonia free.

(4.5) Powdered iron reduced in hydrogen. (The prescribed quantity of iron must be able to reduce at least 0.05 g nitrate nitrogen.)

(4.6) Sodium hydroxide solution, 30 g per 100 ml, ammonia free.

(4.7) Indicator solutions:

Mixed indicator:

(4.7.1) Solution A: dissolve 1 g methyl red in 37 ml 0.1 M sodium hydroxide solution and make up to 1 litre with water.

Solution B: dissolve 1 g methylene blue in water and make up to 1 litre. Mix 1 volume of solution A and 2 volumes of solution B.

This indicator is violet in acid solution, grey in neutral solution and green in alkaline solution; use 0.5 ml (10 drops).

Methyl red indicator solution:

(4.7.2) Dissolve 0.1 g methyl red in 50 ml 95% ethanol, make up to 100 ml with water and filter if necessary.

This indicator may be used (4-5 drops) instead of the preceding one.

(4.8) Anti-bump granules of pumice stone, washed in hydrochloric acid and ignited.

(4.9) Sodium nitrate.

APPARATUS

5. See Method 2.

PREPARATION OF SAMPLE

6. See Method 1.

PROCEDURE

Preparation of the solution

Preparation of the solution

- 7.—(7.1) See Method 2.

Determination

(7.2) Place in the receiving flask an exactly measured quantity of standard sulfuric acid (4.2) as indicated in the Table of Method 2 (variant (a)) and add the appropriate quantity of indicator solution (4.7.1 or 4.7.2).

The end of the extension tube of the condenser must be below the surface of the standard acid in the receiving flask.

Using a pipette, transfer an aliquot part of the clear solution as indicated in the Table of Method 2 (variant (a)) to the distillation flask of the apparatus. Add 350 ml water, 20 ml 30% sulfuric acid solution (4.4), stir, and add 5 g of reduced iron (4.5). Wash the neck of the flask with several ml of water, and place a small, long-stemmed funnel in the neck of the flask. Heat in a boiling water bath for an hour and then wash the stem of the funnel with a few ml of water. Allow to cool to room temperature.

Taking care to avoid any loss of ammonia, add 50 ml concentrated sodium hydroxide solution (4.6) to the contents of the distillation flask, or in the cases where 20 ml of hydrochloric acid (4.1) has been used to dissolve the sample, add 60 ml of concentrated sodium hydroxide solution (4.6). Assemble the distillation apparatus. Distil the ammonia according to the procedure given in Method 2. Titrate the excess acid with the standard solution of sodium or potassium hydroxide (4.3).

Blank test

(7.3) Carry out a blank test (omitting only the sample) under the same conditions and allow for this in the calculation of the final result.

Control test

(7.4) Before analysis check that the apparatus is working properly and that the correct application of the method is used by taking an aliquot portion of a freshly prepared solution of sodium nitrate (4.9) containing 0.045 g to 0.05 g of nitrogen.

EXPRESSION OF RESULTS

8. Express the results of analysis as a percentage of nitric nitrogen, or combined ammoniacal and nitric nitrogen, contained in the fertiliser as received for analysis.

Status: This is the original version (as it was originally made). This item of legislation is currently only available in its original format.

3b.

DETERMINATION OF NITRIC AND AMMONIACAL NITROGEN-ARND METHOD

SCOPE

1. This method is for the determination of nitric and ammoniacal nitrogen with reduction according to Arnd (modified for each of the variants (a), (b) and (c)).

FIELD OF APPLICATION

2. See Method 3a.

PRINCIPLE

3. Reduction of nitrates and nitrites to ammonia in a neutral aqueous solution by means of a metallic alloy composed of 60% Cu and 40% Mg (Arnd's alloy) in the presence of magnesium chloride.

Distillation of the ammonia and absorption in a known volume of standard sulfuric acid solution. Titration of the excess acid with a standard solution of sodium or potassium hydroxide.

REAGENTS

4.—(4.1) Hydrochloric acid solution, 50% (V/V): dilute an appropriate volume of hydrochloric acid ($\rho = 1.18 \text{ g/ml}$) with an equal volume of water.

(4.2) Sulfuric acid, 0.05 M solution } for variant (a) (see page 21)

(4.3) Sodium or potassium hydroxide, 0.1 M solution, carbonate free } for variant (a) (see page 21)

(4.4) Sulfuric acid, 0.1 M solution } for variant (b) (see page 21)

(4.5) Sodium or potassium hydroxide, 0.2 M solution, carbonate free } for variant (b) (see page 21)

(4.6) Sulfuric acid, 0.25 M solution } for variant (c) (see page 21)

(4.7) Sodium or potassium hydroxide, 0.5 M solution, carbonate free } for variant (c) (see page 21)

(4.8) Sodium hydroxide solution, approximately 2 M.

(4.9) Arnd's alloy — powdered to pass through a sieve with square apertures less than 1.00 mm.

(4.10) Magnesium chloride solution, 20% (W/V):

Dissolve 200 g magnesium chloride ($\text{MgCl}_2 \cdot 6\text{H}_2\text{O}$) in approximately 600-700 ml water in a one litre flat bottomed flask. To prevent frothing, add 15 g magnesium sulfate ($\text{MgSO}_4 \cdot 7\text{H}_2\text{O}$). After dissolution add 2 g magnesium oxide and a few anti-bump granules of pumice stone and concentrate the suspension to 200 ml by boiling, thus expelling any trace of ammonia from the reagents. Cool, make up the volume to 1 litre and filter.

(4.11) Indicator solutions:

Mixed indicator:

(4.11.1) Solution A: dissolve 1 g methyl red in 37 ml 0.1 M sodium hydroxide solution and make up to 1 litre with water.

Solution B: dissolve 1 g methylene blue in water and make up to 1 litre. Mix 1 volume of A with 2 volumes of B.

Status: This is the original version (as it was originally made). This item of legislation is currently only available in its original format.

This indicator is violet in acid solution, grey in neutral solution and green in alkaline solution. Use 0.5 ml (10 drops).

Methyl red indicator solution:

- (4.11.2) Dissolve 0.1 g methyl red in 50 ml 95% ethanol, make up to 100 ml with water and filter if necessary. This indicator may be used (4 to 5 drops) instead of the preceding one.

Congo red indicator solution:

- (4.11.3) Dissolve 3 g Congo red in 1 litre warm water and filter if necessary after cooling. This indicator may be used, instead of the two described above, in the neutralisation of acid extracts before distillation, using 0.5 ml per 100 ml of liquid to be neutralised.
- (4.12) Anti-bump granules of pumice stone, washed in hydrochloric acid and ignited.
- (4.13) Sodium nitrate.

APPARATUS

5. See Method 2

PREPARATION OF SAMPLE

6. See Method 1.

PROCEDURE

Preparation of the solution for analysis

Preparation of the solution for analysis

- 7.—(7.1) See Method 2.

Determination

(7.2) According to the chosen variant, place in the receiving flask a measured quantity of standard sulfuric acid as indicated in the Table of Method 2. Add the appropriate quantity of chosen indicator solution (4.11.1 or 4.11.2) and if necessary water to give a volume of at least 50 ml. The end of the extension tube of the condenser must be below the surface of the solution.

Using a pipette, take, according to the Table, an aliquot part of the clear solution and place in the distillation flask. Add sufficient water to obtain a total volume of about 350 ml (see Note), 10 g Arnd's alloy (4.8), 50 ml magnesium chloride solution (4.10) and a few fragments of pumice stone (4.12). Rapidly connect the flask to the distillation apparatus. Heat gently for about 30 minutes. Then increase the heating to distil the ammonia. Continue the distillation for about an hour.

After this time, the residue in the flask ought to have a syrupy consistency. When the distillation has finished, titrate the quantity of excess acid in the receiving flask according to the procedure in Method 2.

Note:

When the sample solution is acidic (addition of 20 ml hydrochloric acid (4.1) to dissolve the sample) the aliquot part taken for analysis is neutralised in the following way: to the distillation flask containing the aliquot part add about 250 ml water, the necessary quantity of one of the indicators (4.11.1, 4.11.2, 4.11.3) and swirl or mix carefully. Neutralise with 2 M sodium hydroxide solution (4.8) and acidify again with a drop of hydrochloric acid (4.1). Then proceed as indicated in 7.2.

Status: This is the original version (as it was originally made). This item of legislation is currently only available in its original format.

Blank test

(7.3) Carry out a blank test under the same conditions (omitting only the samples) and allow for this in the calculation of the final result.

Control test

(7.4) Before analysis, check that the apparatus is working properly and that the correct technique is applied using a freshly prepared solution of sodium nitrate (4.13) containing 0.050 g to 0.150 g nitrogen depending on the variant chosen.

EXPRESSION OF RESULTS

8. Express the results of the analysis as a percentage of nitric nitrogen, or combined ammoniacal and nitric nitrogen, contained in the fertiliser as received for analysis.

3c.

DETERMINATION OF NITRIC AND AMMONIACAL NITROGEN-DEVARDA METHOD

SCOPE

1. This method is for the determination of nitric and ammoniacal nitrogen with reduction according to Devarda (modified for each of the variants (a), (b) and (c)).

FIELD OF APPLICATION

2. See Method 3a.

PRINCIPLE

3. Reduction of nitrates and nitrites to ammonia in a strongly alkaline solution by means of a metallic alloy composed of 45% Al, 5% Zn and 50% Cu (Devarda's alloy). Distillation of the ammonia and absorption in a known volume of standard sulfuric acid; titration of the excess sulfuric acid with a standard solution of sodium or potassium hydroxide.

REAGENTS

4.—(4.1) Hydrochloric acid solution, 50% (V/V): dilute an appropriate volume of hydrochloric acid ($\rho = 1.18$ g/ml) with an equal volume of water.

(4.2) Sulfuric acid, 0.05 M solution. } for variant (a) (see page 21)

(4.3) Sodium or potassium hydroxide, 0.1 M solution, carbonate free. } for variant (a) (see page 21)

(4.4) Sulfuric acid, 0.1 M solution. } for variant (b) (see page 21)

(4.5) Sodium or potassium hydroxide, 0.2 M solution, carbonate free. } for variant (b) (see page 21)

(4.6) Sulfuric acid, 0.25 M solution. } for variant (c) (see page 21)

(4.7) Sodium or potassium hydroxide, 0.5 M solution, carbonate free. } for variant (c) (see page 21)

(4.8) Devarda's alloy — powdered so that 90 to 100% will pass through a sieve with apertures less than 0.25 mm square, 50 to 75% will pass through a sieve with apertures of less than 0.075 mm square. (Pre-packed bottles containing a maximum of 100 g are recommended.)

(4.9) Sodium hydroxide solution, 30 g per 100 ml, ammonia free.

(4.10) Indicator solutions:

(4.10.1) Mixed indicator:

Solution A: dissolve 1 g methyl red in 37 ml 0.1M sodium hydroxide solution and make up to 1 litre with water.

Solution B: dissolve 1 g methylene blue in water and make up to 1 litre. Mix 1 volume of A with 2 volumes of B.

This indicator is violet in acid solution, grey in neutral solution and green in alkaline solution. Use 0.5 ml (10 drops).

(4.10.2) Methyl red indicator solution:

Dissolve 0.1 g methyl red in 50 ml 95% ethanol, make up to 100 ml with water and filter if necessary. This indicator (4 to 5 drops) may be used instead of the preceding one.

(4.11) Ethanol, 95%.

(4.12) Sodium nitrate.

APPARATUS

5.—(5.1) Distillation apparatus consisting of a round bottomed flask of suitable capacity, connected to a condenser by means of a splash head, equipped, in addition, with a bubble trap on the receiving flask to prevent any loss of ammonia.

An example of the type of apparatus recommended for this determination is reproduced in Figure 5 in the Appendix.

PREPARATION OF SAMPLE

6. See Method 1.

PROCEDURE

Preparation of the solution for analysis

Preparation of the solution for analysis

7.—(7.1) See Method 2.

Determination

(7.2) According to the variant chosen, place in the receiving flask an exactly measured quantity of standard sulfuric acid as indicated in the Table of Method 2. Add the appropriate quantity of the chosen indicator solution (4.10.1 or 4.10.2) and sufficient water to give a volume of 50 ml. The end of the extension tube of the condenser must be below the surface of the solution. Fill the bubble trap with distilled water.

Using a pipette, take an aliquot part of the clear solution as indicated in the Table of Method 2 and place in the distillation flask. Add sufficient water to the distillation flask to obtain a volume of 250-300 ml, then add 5 ml ethanol (4.11) and 4 g Devarda's alloy (4.8).

Note:

In the presence of calcium salts such as calcium nitrate and calcium ammonium nitrate, it is necessary to add 0.7 g disodium hydrogen phosphate ($\text{Na}_2\text{HPO}_4 \cdot 2\text{H}_2\text{O}$) before distillation for each gram of sample present in the aliquot, to prevent the formation of calcium hydroxide.

Status: This is the original version (as it was originally made). This item of legislation is currently only available in its original format.

Taking the necessary precautions to avoid loss of ammonia, add to the flask about 30 ml of 30% sodium hydroxide solution (4.9) and finally, in the case of acid-soluble samples, an additional quantity sufficient to neutralise the quantity of hydrochloric acid (4.1) present in the aliquot part taken for the analysis. Connect the distillation flask to the apparatus, ensuring the tightness of connections. Carefully swirl the flask to mix the contents.

Warm gently, so that the release of hydrogen decreases appreciably over about half an hour and the liquid begins to boil. Continue the distillation, increasing the heat so that at least 200 ml of liquid distils in about 30 minutes. (Do not prolong the distillation beyond 45 minutes.)

When the distillation is complete, disconnect the receiving flask from the apparatus, carefully wash the extension tube and bubble trap, collecting the rinsings in the titration flask. Titrate the excess acid according to the procedure in Method 2.

Blank test

(7.3) Carry out a blank test under the same conditions omitting only the sample and allow for this in the calculation of the final results.

Control test

(7.4) Before carrying out the analysis, check that the apparatus is working properly and that the correct application of the method is used, by taking an aliquot portion of a freshly prepared solution of sodium nitrate (4.12) containing, according to the variant chosen, 0.050 g to 0.150 g.

EXPRESSION OF RESULTS

8. Express the results of analysis of a percentage of nitric nitrogen, or combined ammoniacal and nitric nitrogen, contained in the fertiliser as received for analysis.

4a.

DETERMINATION OF TOTAL NITROGEN IN CALCIUM CYANAMIDE — IN THE ABSENCE OF NITRATE

SCOPE

1. This method is for the determination of total nitrogen in nitrate-free calcium cyanamide.

FIELD OF APPLICATION

2. Exclusively to calcium cyanamide (nitrate free).

PRINCIPLE

3. After digestion using the Kjeldahl method, the ammoniacal nitrogen formed is displaced by sodium hydroxide and collected in a standard solution of sulfuric acid. The excess sulfuric acid is titrated with a standard solution of sodium or potassium hydroxide.

REAGENTS

4.—(4.1) Sulfuric acid solution 50% (V/V): dilute an appropriate volume of sulfuric acid ($\rho = 1.84$ g/ml) with an equal volume of water.

(4.2) Potassium sulfate.

(4.3) Copper oxide (CuO), 0.3-0.4 g for each determination or an equivalent quantity of copper sulfate pentahydrate (0.95 to 1.25 g) for each determination.

- (4.4) Sodium hydroxide solution 30 g per 100 ml, ammonia free.
- (4.5) Sulfuric acid, 0.05 M solution. } for variant (a) (see page 21)
- (4.6) Sodium or potassium hydroxide, 0.1 M solution, carbonate free. } for variant (a) (see page 21)
- (4.7) Sulfuric acid, 0.1 M solution. } for variant (b) (see page 21)
- (4.8) Sodium or potassium hydroxide, 0.2 M solution, carbonate free. } for variant (b) (see page 21)
- (4.9) Sulfuric acid, 0.25 M solution. } for variant (c) (see page 21)
- (4.10) Sodium or potassium hydroxide, 0.5 M solution, carbonate free. } for variant (c) (see page 21)
- (4.11) Indicator solutions:
 - (4.11.1) Mixed indicator:
 - Solution A: dissolve 1 g methyl red in 37 ml 0.1 M sodium hydroxide solution and make up to 1 litre with water.
 - Solution B: dissolve 1 g methylene blue in water and make up to 1 litre. Mix 1 volume of A with 2 volumes of B.
 - This indicator is violet in acid solution, grey in neutral solution and green in alkaline solution. Use 0.5 ml (10 drops).
 - (4.11.2) Methyl red indicator solution:
 - Dissolve 0.1 g methyl red in 50 ml 95% ethanol, make up to 100 ml with water and filter if necessary. This indicator (4 to 5 drops) may be used instead of the preceding one.
- (4.12) Anti-bump granules of pumice stone, washed in hydrochloric acid and ignited.
- (4.13) Potassium thiocyanate.

APPARATUS

- 5.—(5.1) Distillation apparatus. See Method 2.

PREPARATION OF SAMPLE

- 6. See Method 1.

PROCEDURE

Preparation of the solution

Preparation of the solution

7.—(7.1) Weigh to the nearest 0.001 g, 1 g of the prepared sample and place it in the Kjeldahl flask. Add 50 ml 50% sulfuric acid (4.1), 10-15 g potassium sulfate (4.2) and one of the prescribed catalysts (4.3). Heat slowly to drive off the water, boil gently for two hours, allow to cool, and dilute with 100-150 ml water. Cool again, transfer the suspension quantitatively to a 250 ml graduated flask, make up to volume with water, shake and filter through a dry filter into a dry flask. Discard the first portion of the filtrate.

Determination

Status: This is the original version (as it was originally made). This item of legislation is currently only available in its original format.

(7.2) According to the variant chosen (see Method 2) transfer with a pipette 50, 100 or 200 ml of the solution to the distillation apparatus and add sufficient sodium hydroxide solution (4.4) to ensure a considerable excess. Distil the ammonia and titrate the excess acid as described in Method 2.

Blank test

(7.3) Make a blank test (omitting only the sample) under the same conditions and allow for this in the calculation of the final result.

Control test

(7.4) Before carrying out the analysis, check that the apparatus is working properly and that the correct application of the method is used, by taking an aliquot portion of a standard solution of potassium thiocyanate (4.13), approximating to the concentration of nitrogen in the sample.

EXPRESSION OF RESULT

8. The result of the analysis must be expressed as the result of the percentage of nitrogen (N) contained in the fertiliser as received for analysis.

Variant (a): $N\% = (50 - A) \times 0.7$

Variant (b): $N\% = (50 - A) \times 0.7$

Variant (c): $N\% = (35 - A) \times 0.875$

Where A = millilitres of sodium or potassium hydroxide used for the titration.

4b.

DETERMINATION OF TOTAL NITROGEN IN CALCIUM CYANAMIDE — IN THE PRESENCE OF NITRATE

SCOPE

1. This method is for the determination of total nitrogen in calcium cyanamide.

FIELD OF APPLICATION

2. The method is applicable to calcium cyanamide containing nitrates.

PRINCIPLE

3. The direct application of Kjeldahl's method cannot be applied to calcium cyanamides containing nitrates. For this reason the nitric nitrogen is reduced to ammonia with metallic iron and stannous chloride before Kjeldahl digestion. The ammoniacal nitrogen is then determined as in Method 4a.

REAGENTS

- 4.—(4.1) Sulfuric acid ($\rho = 1.84$ g/ml).
- (4.2) Powdered iron reduced in hydrogen.
- (4.3) Potassium sulfate, finely pulverised.
- (4.4) Sulfuric acid, 0.05 M solution. } for variant (a) (see page 21)
- (4.5) Sodium or potassium hydroxide, 0.1 M solution, carbonate free. } for variant (a) (see page 21)

- (4.6) Sulfuric acid, 0.1 M solution. for variant (b) } for variant (b) (see page 21)
- (4.7) Sodium or potassium hydroxide, 0.2 M solution, carbonate free. } for variant (b) (see page 21)
- (4.8) Sulfuric acid, 0.25 M solution. } for variant (c) (see page 21)
- (4.9) Sodium or potassium hydroxide, 0.5 M solution, carbonate free. } for variant (c) (see page 21)
- (4.10) Indicator solutions:

Mixed indicator:

- (4.10.1) Solution A: dissolve 1 g methyl red in 37 ml 0.1 M sodium hydroxide solution and make up to 1 litre with water.

Solution B: dissolve 1 g methylene blue in water and make up to 1 litre. Mix 1 volume of A with 2 volumes of B.

This indicator is violet in acid solution, grey in neutral solution and green in alkaline solution. Use 0.5 ml (10 drops) of this indicator solution.

Methyl red indicator:

- (4.10.2) Dissolve 0.1 g methyl red in 50 ml 95% ethanol, make up to 100 ml with water and filter if necessary. This indicator (4 to 5 drops) may be used instead of the preceding one.

Solution of stannous chloride:

- (4.11) Dissolve 120 g of stannous chloride ($\text{SnCl}_2 \cdot 2\text{H}_2\text{O}$) in 400 ml concentrated hydrochloric acid ($\rho = 1.18 \text{ g/ml}$) and make up to 1 litre with water. The solution must be completely clear and prepared immediately before use.

It is essential to check the reducing power of the stannous chloride. Dissolve 0.5 g of stannous chloride in 2 ml concentrated hydrochloric acid ($\rho = 1.18 \text{ g/ml}$) and make up to 50 ml with water. Then add 5 g of Rochelle salt (potassium sodium tartrate) and a sufficient quantity of sodium bicarbonate for the solution to show an alkaline reaction to a litmus paper test.

Titrate with 0.1 M iodine solution in the presence of a starch solution as an indicator.

1 ml of 0.1 M iodine solution corresponds to 0.01128 g $\text{SnCl}_2 \cdot 2\text{H}_2\text{O}$.

At least 80% of the total tin present in the solution thus prepared must be in the bivalent form. For the titration at least 35 ml of 0.1 M iodine solution should be used.

- (4.12) Sodium hydroxide solution, 30 g per 100 ml, ammonia free.

- (4.13) Standard nitrate-ammoniacal solution:

Weigh out 2.500 g of potassium nitrate and 10.160 g of ammonium sulfate into a 250 ml graduated flask. Dissolve in water and make up to 250 ml. 1 ml of this solution contains 0.010 g of nitrogen.

- (4.14) Anti-bump granules of pumice stone, washed in hydrochloric acid and ignited.

APPARATUS

- 5. Distillation apparatus. See Method 2.

PREPARATION OF SAMPLE

- 6. See Method 1.

Status: This is the original version (as it was originally made). This item of legislation is currently only available in its original format.

PROCEDURE

Preparation of the solution

Preparation of the solution

7.—(7.1) Weigh to the nearest 0.001 g, 1 g of the prepared sample into the Kjeldahl flask. Add 0.5 g of powdered iron (4.2) and 50 ml of the stannous chloride solution (4.11), stir and leave standing for half an hour. During the time it is left standing, stir again after 10 and 20 minutes. Then add 10 g of potassium sulfate (4.3) and 30 ml of sulfuric acid (4.1). Boil and continue for an hour after the appearance of white fumes. Leave to cool and dilute with 100-150 ml of water. Transfer the suspension quantitatively into a 250 ml graduated flask, cool and make up to volume with water, mix and filter through a dry paper into a dry container. Discard the first portion of the filtrate.

Determination

(7.2) According to the variant chosen (see Method 2) transfer with a pipette 50, 100 or 200 ml of the solution to the distillation apparatus and add sufficient sodium hydroxide solution (4.12) to ensure a considerable excess. Distil the ammonia and titrate the excess acid as described in Method 2.

Blank test

(7.3) Make a blank test (omitting only the sample) under the same conditions and allow for this in the calculation of the final result.

Control test

(7.4) Before carrying out the analysis, check that the apparatus is working properly and that the correct application of the method is used with a standard solution containing quantities of ammoniacal and nitrate nitrogen comparable to the quantities of cyanamide and nitrate nitrogen contained in nitrated calcium cyanamide.

EXPRESSION OF RESULT

8. The result of the analysis must be expressed as the percentage of total nitrogen (N) contained in the fertiliser as received for analysis.

Variant (a): $N\% = (50 - A) \times 0.7$

Variant (b): $N\% = (50 - A) \times 0.7$

Variant (c): $N\% = (35 - A) \times 0.875$

Where A = millilitres of sodium or potassium hydroxide used for the titration.

5.

DETERMINATION OF TOTAL NITROGEN IN UREA

SCOPE

1. This method is for the determination of total nitrogen in urea.

FIELD OF APPLICATION

2. The method is applied exclusively to urea fertilisers which are nitrate free.

PRINCIPLE

3. Urea is transformed quantitatively into ammonia by boiling in the presence of sulfuric acid. The ammonia thus obtained is distilled from an alkaline medium and collected in an excess of standard sulfuric acid. The excess acid is titrated by means of a standard alkaline solution.

REAGENTS

- 4.—(4.1) Sulfuric acid, concentrated ($\rho = 1.84$ g/ml).
(4.2) Sodium hydroxide solution, 30 g per 100 ml, ammonia free.
(4.3) Sulfuric acid, 0.05 M solution. } for variant (a) (see page 21)
(4.4) Sodium or potassium hydroxide, 0.1 M solution, carbonate free. } for variant (a) (see page 21)
(4.5) Sulfuric acid, 0.1 M solution. } for variant (b) (see page 21)
(4.6) Sodium or potassium hydroxide, 0.2 M solution, carbonate free. } for variant (b) (see page 21)
(4.7) Sulfuric acid, 0.25 M solution. } for variant (c) (see page 21)
(4.8) Sodium or potassium hydroxide, 0.5 M solution, carbonate free. } for variant (c) (see page 21)
(4.9) Indicator solutions:

Mixed indicator:

- (4.9.1) Solution A: dissolve 1 g methyl red in 37 ml 0.1 M sodium hydroxide solution and make up to 1 litre with water.

Solution B: dissolve 1 g methylene blue in water and make up to 1 litre. Mix 1 volume of A with 2 volumes of B.

This indicator is violet in acid solution, grey in neutral solution and green in alkaline solution. Use 0.5 ml (10 drops).

Methyl red indicator:

- (4.9.2) Dissolve 0.1 g methyl red in 50 ml 95% ethanol, make up to 100 ml with water. Filter if necessary. This indicator (4 to 5 drops) may be used instead of the preceding one.
(4.10) Anti-bump granules of pumice stone, washed in hydrochloric acid and ignited.
(4.11) Urea.

APPARATUS

- 5.—(5.1) Distillation apparatus. See Method 2.

PREPARATION OF SAMPLE

6. See Method 1.

PROCEDURE

Preparation of the solution

Preparation of the solution

Status: This is the original version (as it was originally made). This item of legislation is currently only available in its original format.

7.—(7.1) Weigh to the nearest 0.001 g, 2.5 g of the prepared sample into a 300 ml Kjeldahl flask and moisten with 20 ml water. Add with care 20 ml concentrated sulfuric acid (4.1) and a few anti-bump granules (4.10). To prevent splashing, place a long-stemmed glass funnel in the neck of the flask. Heat slowly at first, then increase the heat until white fumes are observed (30-40 minutes).

Cool and dilute with 100-150 ml water. Transfer quantitatively to a 500 ml graduated flask, discarding any sediment. Allow to cool to room temperature. Make up to volume with water, mix and, if necessary, filter through a dry paper into a dry receptacle. Discard the first portion of the filtrate.

Determination

(7.2) According to the variant chosen (see Method 2) transfer with a pipette 25, 50 or 100 ml of the solution to the distillation apparatus and add sufficient sodium hydroxide solution (4.2) to ensure a considerable excess. Distil the ammonia and titrate the excess acid as described in Method 2.

Blank test

(7.3) Carry out a blank test (omitting only the sample) under the same conditions and allow for this in the calculation of the final result.

Control test

(7.4) Before carrying out the analysis, check that the apparatus is working properly and that the correct application of the method is used, with an aliquot portion of a freshly prepared solution of urea (4.11).

EXPRESSION OF RESULT

8. Express the result as the percentage of total nitrogen (N) contained in the fertiliser as received for analysis.

Variant (a): $N\% = (50 - A) \times 1.12$

Variant (b): $N\% = (50 - A) \times 1.12$

Variant (c): $N\% = (35 - A) \times 1.40$

Where A = millilitres of sodium or potassium hydroxide used for the titration.

6.

DETERMINATION OF CYANAMIDE NITROGEN

SCOPE

1. This method is for the determination of cyanamide nitrogen.

FIELD OF APPLICATION

2. Calcium cyanamide and calcium cyanamide/nitrate mixtures.

PRINCIPLE

3. Cyanamide nitrogen is precipitated as a silver complex and estimated in the precipitate by Kjeldahl's method.

REAGENTS

4.—(4.1) Glacial acetic acid.

(4.2) Ammonia solution: dilute one volume of ammonia ($\rho = 0.88$ g/ml) with 3 volumes of water.

(4.3) Ammoniacal silver solution, according to Tollens, freshly prepared: mix 500 ml silver nitrate solution (10 g per 100 ml) with 500 ml ammonia solution (4.2).

Do not expose unnecessarily to light, heat or air.

Safety precaution: when handling ammoniacal silver nitrate solution, safety goggles must be worn.

(4.4) Concentrated sulfuric acid ($\rho = 1.84$ g/ml).

(4.5) Potassium sulfate.

(4.6) Copper oxide (CuO), 0.3-0.4 g for each determination or an equivalent quantity of copper sulfate pentahydrate (0.95-1.25 g) for each determination.

(4.7) Sodium hydroxide solution, 30 g per 100 ml, ammonia free.

(4.8) Sulfuric acid, 0.05 M solution.

(4.9) Sodium or potassium hydroxide, 0.1 M solution.

(4.10) Indicator solutions:

Mixed indicator:

(4.10.1) Solution A: dissolve 1 g methyl red in 37 ml 0.1 M sodium hydroxide solution and make up to 1 litre with water.

Solution B: dissolve 1 g methylene blue in water and make up to 1 litre. Mix 1 volume of A with 2 volumes of solution B.

This indicator is violet in acid solution, grey in neutral solution and green in alkaline solution. Use 0.5 ml (10 drops).

Methyl red indicator:

(4.10.2) Dissolve 0.1 g methyl red in 50 ml 95% ethanol, make up to 100 ml with water. Filter if necessary. This indicator (4 to 5 drops) may be used instead of the preceding one.

(4.11) Anti-bump granules of pumice stone, washed in hydrochloric acid and ignited.

(4.12) Potassium thiocyanate.

APPARATUS

5.—(5.1) Distillation apparatus. See Method 2.

(5.2) 500 ml graduated flask (e.g. Stohmann).

(5.3) Rotary shaker, 35-40 turns per minute.

PREPARATION OF SAMPLE

6. See Method 1.

PROCEDURE

Preparation of the solution for analysis

Preparation of the solution for analysis

Status: This is the original version (as it was originally made). This item of legislation is currently only available in its original format.

7.—(7.1) Weigh to the nearest 0.001 g, 2.5 g of the prepared sample into a small glass mortar. Grind the sample three times with water, pouring off the water after each grinding into the 500 ml graduated flask (5.2). Transfer the sample quantitatively into the flask, washing the mortar, pestle and funnel with water. Make up with water to approximately 400 ml. Add 15 ml acetic acid (4.1). Shake on the rotary shaker (5.3) for two hours.

Make up to 500 ml with water, mix and filter. Discard the first portion of the filtrate.

Proceed immediately to 7.2.

Determination

(7.2) Transfer 50.0 ml of the filtrate to a 250 ml beaker. Add ammonia solution (4.2) until slightly alkaline and add 30 ml warm ammoniacal silver nitrate (4.3) to precipitate the yellow silver complex of cyanamide. Leave overnight, filter and wash the precipitate with cold water until completely free of ammonia.

Place the filter paper and the precipitate, still moist, in a Kjeldahl flask, add 10-15 g potassium sulfate (4.5), the catalyst (4.6) in the prescribed proportion, then 50 ml water and 25 ml concentrated sulfuric acid (4.4). Warm the flask slowly, whilst shaking it gently until the contents come to the boil. Increase the heat, boil until the contents of the flask become either colourless or pale green. Continue boiling for one hour, then leave to cool.

Transfer the liquid quantitatively from the Kjeldahl flask to the distillation flask, add a few anti-bump granules of pumice stone (4.11) and make up with water to a total volume of approximately 350 ml. Mix and cool. Add sufficient sodium hydroxide solution (4.7) to ensure a considerable excess.

Distil the ammonia and titrate the excess acid as described in Method 2 (variant (a)).

Blank test

(7.3) Make a blank test (omitting only the sample) under the same conditions and allow for this in the calculation of the final result.

Control test

(7.4) Before carrying out the analysis, check that the apparatus is working properly and that the correct application of the method is used, with an aliquot portion of a standard solution of potassium thiocyanate (4.12), corresponding to 0.05 g of nitrogen.

EXPRESSION OF RESULT

8. Express the result as the percentage of cyanamide nitrogen contained in the fertiliser as received for analysis.

$$N\% = (50 - A) \times 0.56$$

Where A = millilitres of sodium or potassium hydroxide used for the titration.

7.

DETERMINATION OF BIURET IN UREA

SCOPE

1. This method is for the determination of biuret in urea.

FIELD OF APPLICATION

2. The method is applied exclusively to urea.

PRINCIPLE

3. In an alkaline medium, in the presence of potassium sodium tartrate, biuret and bivalent copper form a violet cupric compound, the absorbance of which is measured at 546 nm.

REAGENTS

4.—(4.1) Methanol.

(4.2) Sulfuric acid solution, approximately 0.05 M.

(4.3) Sodium hydroxide solution, approximately 0.1 M.

(4.4) Alkaline solution of potassium sodium tartrate:

In a 1 litre graduated flask dissolve 40 g of sodium hydroxide in 500 ml of water and leave to cool. Add 50 g of potassium sodium tartrate ($\text{KNaC}_4\text{H}_4\text{O}_6 \cdot 4\text{H}_2\text{O}$). Make up to the mark and mix. Leave standing 24 hours before use.

(4.5) Copper sulfate solution:

In a 1 litre graduated flask dissolve 15 g of copper sulfate ($\text{CuSO}_4 \cdot 5\text{H}_2\text{O}$) in 500 ml of water. Make up to the mark and mix.

(4.6) Biuret standard solution:

In a 250 ml graduated flask, dissolve 0.250 g of pure biuret(7) in water. Make up to the mark and mix. 1 ml of this solution contains 0.001 g of biuret. This solution should be freshly prepared.

(4.7) Methyl red indicator solution:

Dissolve 0.1 g methyl red in 50 ml 95% ethanol and make up to 100 ml with water. Filter if necessary.

APPARATUS

5.—(5.1) Spectrophotometer.

PREPARATION OF SAMPLE

6. See Method 1.

PROCEDURE

Preparation of the standard curve

Preparation of the standard curve

7.—(7.1) Transfer 2, 5, 10, 20, 25 and 50 ml aliquot portions of biuret standard solution (4.6) into a series of six 100 ml graduated flasks. Make up the volumes to about 50 ml with water, add one drop of indicator solution (4.7) and neutralise, if necessary, with 0.05 M sulfuric acid (4.2). Add with swirling 20.0 ml of the alkaline tartrate solution (4.4) and then 20.0 ml copper sulfate solution (4.5). Make up to the mark with water, mix and allow to stand at $30 \pm 2^\circ\text{C}$ for fifteen minutes.

At the same time prepare a reagent blank as follows. Place 50 ml water in a 100 ml graduated flask and proceed as described above from ‘... add one drop of indicator solution ...’

Measure the absorbance of each solution at 546 nm against the reagent blank as reference, using cells of suitable path length. Plot the calibration curve, using the absorbances as the ordinates and the corresponding quantities of biuret in milligrams, as the abscissae.

(7) Biuret can be purified beforehand by washing with 10% ammonia solution, then with acetone and drying under vacuum at room temperature.

Status: This is the original version (as it was originally made). This item of legislation is currently only available in its original format.

Preparation of solution for analysis

(7.2) Weigh to the nearest 0.001 g, 10 g of the prepared sample; dissolve in about 150 ml of water in a 250 ml graduated flask and make up to the mark and mix. Filter if necessary.

Note 1:

If the sample for analysis contains more than 0.015 g of ammoniacal nitrogen, dissolve in 50 ml methanol (4.1) in a 250 ml beaker. Reduce by evaporation to a volume of about 25 ml. Transfer quantitatively to a graduated 250 ml flask. Make up to the mark with water. Filter, if necessary, through a dry fluted paper into a dry receiver.

Note 2:

Elimination of the opalescence: if any colloidal substance is present difficulties may arise during filtration. In that case the solution for analysis is prepared as follows:

Dissolve the sample in 150 ml of water, add 2 ml 1 M hydrochloric acid, and filter the solution into a 250 ml graduated flask. Wash the filters with water and make up to volume. Continue the process according to the method described in 7.3.

Determination

(7.3) According to the presumed biuret content, transfer with a pipette 25 or 50 ml from the solution prepared in 7.2, to a 100 ml graduated flask and neutralise if necessary with 0.05 M sulfuric acid or sodium hydroxide solution (4.2 or 4.3) as required, using methyl red indicator (4.7). Add 20.0 ml of the alkaline solution of potassium sodium tartrate (4.4) and 20.0 ml of the copper solution (4.5). Make up to volume, mix thoroughly and leave standing for 15 minutes at $30^{\circ}\text{C} \pm 2$. Measure the absorbance of the solution as described in 7.1.

EXPRESSION OF RESULTS

$$\% \text{ biuret} = \frac{C \times 2.5}{V}$$

where:

C = mass, in mg, of biuret read from the standard curve;

V = volume of the aliquot used for the determination.

8a.

DETERMINATION OF DIFFERENT FORMS OF NITROGEN IN THE SAME SAMPLE — IN THE PRESENCE OF CYANAMIDE NITROGEN

SCOPE

1. This method is for the determination of any one form of nitrogen in the presence of any other form.

FIELD OF APPLICATION

2. Any fertiliser in Group 1(a) of Section A, and Groups 1, 2 and 3 of Section B of the Table in Schedule 1 to the Fertilisers Regulations (Northern Ireland) 1992(8) containing nitrogen in various forms.

(8) S.R. 1992 No. 187

PRINCIPLE

Total soluble and insoluble nitrogen

Total soluble and insoluble nitrogen

(3.1.1) 3. (3.1) (3.1.1) *In the absence of nitrates*, the sample is subjected to direct Kjeldahl digestion.

(3.1.2) *In the presence of nitrates*, the sample is subjected to Kjeldahl digestion after reduction with the aid of metallic iron and stannous chloride. In both cases, the ammonia is determined according to Method 2.

If analysis shows an insoluble nitrogen content of more than 0.5%, it is presumed that the fertiliser contains other forms of insoluble nitrogen not specified for fertilisers covered by the list in paragraph 2.

Note:

If analysis shows an insoluble nitrogen content of more than 0.5%, it is presumed that the fertiliser contains other forms of insoluble nitrogen not specified for fertilisers covered by the list in paragraph 2.

Forms of soluble nitrogen

(3.2) The following are determined from different aliquot parts taken from the same solution of the sample:

Total soluble nitrogen

(3.2.1) (3.2.1.1) *In the absence of nitrates*, by direct Kjeldahl digestion.

(3.2.1.2) *In the presence of nitrates*, by Kjeldahl digestion on an aliquot portion taken from the solution after reduction according to Ulsch, the ammonia being determined in both cases as described in Method 2.

(3.2.2) *Total soluble nitrogen with the exception of nitric nitrogen*, by Kjeldahl digestion after elimination in an acid medium of nitric nitrogen with ferrous sulfate, the ammonia being determined as described in Method 2.

Nitric nitrogen by difference

(3.2.3) (3.2.3.1) *In the absence of calcium cyanamide*, between (3.2.1.2) and (3.2.2) or between total soluble nitrogen (3.2.1.2) and the sum of ammoniacal nitrogen and ureic nitrogen (3.2.4 + 3.2.5).

(3.2.3.2) *In the presence of calcium cyanamide*, between (3.2.1.2) and (3.2.2) and between (3.2.1.2) and the sum of (3.2.4 + 3.2.5 + 3.2.6).

Ammoniacal nitrogen

(3.2.4) (3.2.4.1) *Solely in the presence of ammoniacal nitrogen and ammoniacal + nitric nitrogen*, by applying Method 2.

(3.2.4.2) *In the presence of ureic nitrogen and/or cyanamide nitrogen*, by cold distillation after making slightly alkaline, the ammonia being absorbed in a standard solution of sulfuric acid and determined as described in Method 2.

Ureic nitrogen

(3.2.5) Either

Status: This is the original version (as it was originally made). This item of legislation is currently only available in its original format.

(3.2.5.1) *By conversion using urease* into ammonia which is titrated with a standard solution of hydrochloric acid.

or:

(3.2.5.2) *By gravimetry with xanthydrol*, although biuret will also be precipitated by xanthydrol, this should not give rise to a significant error in the determination since its level is generally low in absolute value in compound fertilisers.

or:

(3.2.5.3) *By difference*, according to the following table:

Case	Nitric Nitrogen	Ammoniacal Nitrogen	Cyanamide Nitrogen	Difference
1	Absent	Present	Present	(3.2.1.1)- (3.2.4.2 + 3.2.6)
2	Present	Present	Present	(3.2.2)-(3.2.4.2 + 3.2.6)
3	Absent	Present	Absent	(3.2.1.1)- (3.2.4.2)
4	Present	Present	Absent	(3.2.2)-(3.2.4.2)

(3.2.6) *Cyanamide nitrogen*, by precipitation as a silver compound, the nitrogen being estimated in the precipitate by the Kjeldahl method.

REAGENTS

4.—(4.1) Potassium sulfate.

(4.2) Iron powder, reduced with hydrogen (the prescribed quantity of iron must be able to reduce at least 50 mg of nitric nitrogen).

(4.3) Potassium thiocyanate.

(4.4) Potassium nitrate.

(4.5) Ammonium sulfate.

(4.6) Urea.

(4.7) Sulfuric acid solution: dilute an appropriate volume of sulfuric acid ($\rho = 1.84$ g/ml) with an equal volume of water.

(4.8) Sulfuric acid, 0.1 M solution.

(4.9) Sodium hydroxide solution, 30 g per 100 ml, ammonia free.

(4.10) Sodium or potassium hydroxide, 0.2 M solution, free from carbonates.

(4.11) Stannous chloride solution:

Dissolve 120 g of stannous chloride ($\text{SnCl}_2 \cdot 2\text{H}_2\text{O}$) in 400 ml of concentrated hydrochloric acid ($\rho = 1.18$ g/ml) and make up to 1 litre with water. The solution must be perfectly clear and prepared immediately before use.

It is essential to check the reducing power of the stannous chloride: dissolve 0.5 g of stannous chloride in 2 ml of concentrated hydrochloric acid ($\rho = 1.18$ g/ml) and make up to 50 ml with water. Then add 5 g of Rochelle salt (potassium sodium tartrate) and a sufficient quantity of sodium bicarbonate for the solution to be alkaline to litmus paper.

Titrate with 0.1 M iodine solution in the presence of a starch solution as an indicator.

1 ml of 0.1 M iodine solution corresponds to 0.01128 g of $\text{SnCl}_2 \cdot 2\text{H}_2\text{O}$.

At least 80% of the total tin present in the solution thus prepared must be in bivalent form. For the titration, at least 35 ml of 0.1 M iodine solution must therefore be used.

(4.12) Sulfuric acid, concentrated ($\rho = 1.84$ g/ml).

(4.13) Hydrochloric acid solution: dilute an appropriate volume of hydrochloric acid ($\rho = 1.18$ g/ml) with an equal volume of water.

(4.14) Glacial acetic acid.

(4.15) Sulfuric acid solution, approximately 30% (W/V) H_2SO_4 .

(4.16) Ferrous sulfate, crystalline, $\text{FeSO}_4 \cdot 7\text{H}_2\text{O}$.

(4.17) Sulfuric acid, 0.05 M solution.

(4.18) Octan-1-ol.

(4.19) Potassium carbonate, saturated solution.

(4.20) Sodium or potassium hydroxide, 0.1 M solution, free from carbonate.

(4.21) Barium hydroxide, saturated solution.

(4.22) Sodium carbonate solution, 10 g per 100 ml.

(4.23) Hydrochloric acid, 2 M solution.

(4.24) Hydrochloric acid, 0.1 M solution.

(4.25) Urease solution:

Suspend 0.5 g of active urease in 100 ml of distilled water.

Using 0.1 M hydrochloric acid (4.24), adjust the pH to 5.4, measured by pH meter.

(4.26) Xanthidrol solution, 5 g per 100 ml in ethanol or methanol (4.31) (do not use products giving a high proportion of insoluble matter). The solution may be kept for three months in a well-stoppered bottle, away from the light.

(4.27) Copper oxide (CuO): 0.3 to 0.4 g per determination or an equivalent quantity of copper sulfate pentahydrate (0.95 to 1.25 g) per determination.

(4.28) Anti-bump granules washed in hydrochloric acid and ignited.

(4.29) Indicator solutions:

(4.29.1) Mixed indicator solution:

Solution A: dissolve 1 g methyl red in 37 ml 0.1 M sodium hydroxide solution and make up to one litre with water.

Solution B: dissolve 1 g methylene blue in water and make up to 1 litre. Mix 1 volume of solution A with 2 volumes of solution B.

This indicator is violet in acid solution, grey in neutral solution and green in alkaline solution. Use 0.5 ml (10 drops) of this indicator solution.

(4.29.2) Methyl red indicator solution:

Dissolve 0.1 g methyl red in 50 ml 95% ethanol, make up to 100 ml with water and filter if necessary. This indicator (4 to 5 drops) may be used instead of the preceding one.

(4.30) Indicator papers:

Litmus, bromothymol blue (or other papers sensitive in the range pH 6 to 8).

(4.31) Ethanol or methanol: solution 95%.

Status: This is the original version (as it was originally made). This item of legislation is currently only available in its original format.

APPARATUS

5.—(5.1) Distillation apparatus. See Method 2.

(5.2) Apparatus for the determination of ammoniacal nitrogen 7.2.5.3. An example of the recommended apparatus is reproduced in Figure 6 in the Appendix.

The apparatus is made up of a specially shaped receptacle with a ground glass neck, a side neck, a connecting tube with a splash head and a perpendicular tube for the introduction of air. The tubes can be connected to the receptacle by means of a simple perforated rubber bung. It is important to give a suitable shape to the end of the tubes introducing air, since the bubbles of gas must be evenly distributed throughout the solutions contained in the receptacle and the absorber. The best arrangement consists of small mushroom-shaped pieces with an external diameter of 20 mm and six openings of 1 mm around the periphery.

(5.3) Apparatus for the estimation of urea nitrogen (7.2.6.1).

It consists of a 300 ml Erlenmeyer flask, with a separating funnel and a small absorber. An example of the recommended apparatus is reproduced in Figure 7 in the Appendix.

(5.4) Rotary shaker, 35-40 turns per minute.

(5.5) pH meter.

(5.6) Laboratory oven.

(5.7) Sintered glass crucibles, diameter of pores 5 to 15 microns.

PREPARATION OF SAMPLE

6. See Method 1.

PROCEDURE

Total soluble and insoluble nitrogen

Total soluble and insoluble nitrogen

In the absence of nitrate

(7.1.1.1.1) *Digestion*

Weigh to the nearest 0.001 g, a quantity of the prepared sample containing not more than 100 mg of nitrogen. Place in the flask of the distillation apparatus (5.1). Add 10 to 15 g of potassium sulfate (4.1), the prescribed quantity of catalyst (4.27), and a few anti-bump granules (4.28). Then add 50 ml of dilute sulfuric acid (4.7), and mix thoroughly. First heat gently, mixing from time to time, until foaming ceases. Then heat so that the liquid boils steadily and keep it boiling for one hour after the solution has become clear, preventing any organic matter from sticking to the sides of the flask. Allow to cool. Carefully add about 350 ml of water, with mixing. Ensure that the dissolution is as complete as possible. Allow to cool and connect the flask to the distillation apparatus (5.1).

(7.1.1.2) *Distillation of ammonia*

Transfer with a pipette 50 ml of standard 0.1 M sulfuric acid (4.8) into the receiver of the apparatus. Add the indicator (4.29.1 or 4.29.2). Ensure that the tip of the condenser is at least 1 cm below the level of the solution.

Taking the necessary precautions to avoid any loss of ammonia, carefully add to the distillation flask enough of the concentrated sodium hydroxide solution (4.9) to make the liquid strongly alkaline (120 ml is generally sufficient: check

Status: This is the original version (as it was originally made). This item of legislation is currently only available in its original format.

by adding a few drops of phenolphthalein. At the end of the distillation the solution in the flask must still be clearly alkaline). Adjust the heating of the flask so as to distil 150 ml in half an hour. Test with indicator paper (4.30) that the distillation has been completed. If it has not, distil a further 50 ml and repeat the test until the supplementary distillate reacts neutrally to the indicator paper (4.30). Then lower the receiver, distil a few ml more and rinse the tip of the condenser. Titrate the excess acid with a standard solution of potassium or sodium hydroxide 0.2 M (4.10) to the end point of the indicator.

(7.1.1.3) *Blank test*

Make a blank test under the same conditions (omitting only the sample) and use this value in the calculation of the final result.

(7.1.1.4) *Expression of result*

$$\%N = \frac{(a - A) \times 0.2N}{M}$$

where:

a = ml of standard solution of sodium or potassium hydroxide (0.2 M) used for the blank.

A = ml of standard solution of sodium or potassium hydroxide (0.2 M) used for the analysis.

M = mass of the sample in grams.

In the presence of nitrate

(7.1.2.1) *Test sample*

Weigh to the nearest 0.001 g, a quantity of the sample containing not more than 40 mg of nitric nitrogen.

(7.1.2.2) *Reduction of the nitrate*

Mix the sample in a small mortar with 50 ml of water. Transfer with the minimum amount of distilled water into a 500 ml Kjeldahl flask. Add 5 g of reduced iron (4.2) and 50 ml of stannous chloride solution (4.11). Shake and leave to stand for half an hour. During this time shake again after 10 and 20 minutes.

(7.1.2.3) *Kjeldahl digestion*

Add 30 ml of sulfuric acid (4.12), 5 g of potassium sulfate (4.1), the prescribed quantity of catalyst (4.27) and some anti-bump granules (4.28). Heat gently with the flask slightly tilted. Increase the heat slowly and swirl the solution frequently to keep the mixture suspended; the liquid darkens and then clears with the formation of a yellow-green anhydrous iron sulfate suspension. After obtaining a clear solution simmer for one hour. Leave to cool. Cautiously take up the contents of the flask in a little water and add little by little 100 ml of water. Mix and transfer the contents of the flask into a 500 ml graduated flask. Rinse the flask several times with distilled water. Make up the volume with water and mix. Filter through a dry paper into a dry receiver. Discard the first portion of the filtrate.

(7.1.2.4) *Distillation of ammonia*

Transfer into the flask of the distillation apparatus (5.1), an aliquot part containing not more than 100 mg of nitrogen. Dilute to about 350 ml with distilled water, add a few anti-bump granules (4.28), connect the flask to the distillation apparatus and continue the determination as described in paragraph 7.1.1.2.

Status: This is the original version (as it was originally made). This item of legislation is currently only available in its original format.

(7.1.2.5) *Blank test*

See 7.1.1.3.

(7.1.2.6) *Expression of result*

$$\%N = \frac{(a - A) \times 0.28}{M}$$

where:

a = ml of standard solution of sodium or potassium hydroxide (0.2 M) used for the blank.

A = ml of standard solution of sodium or potassium hydroxide (0.2 M) used for the analysis.

M = mass of the sample, expressed in grams, present in the aliquot part taken for analysis.

Forms of soluble nitrogen

Preparation of the solution to be analysed

(7.2.1) Weigh to the nearest 0.001 g, 10 g of the sample and place it in a 500 ml graduated flask.

(7.2.1.1) *In the case of fertilisers not containing cyanamide nitrogen*

Add to the flask 50 ml of water and then 20 ml of dilute hydrochloric acid (4.13). Shake and leave it to stand until the evolution of carbon dioxide ceases. Then add 400 ml of water and shake for half an hour on the rotary shaker (5.4).

Make up to the volume with water, mix and filter through a dry filter into a dry receiver. Discard the first portion of the filtrate.

(7.2.1.2) *In the case of fertilisers containing cyanamide nitrogen*

Add to the flask 400 ml of water and a few drops of methyl red (4.29.2). If necessary make the solution acidic by using acetic acid (4.14). Add 15 ml of acetic acid (4.14). Shake on the rotary shaker (5.4) for 2 hours. If necessary, re-acidify the solution during the operation, using acetic acid (4.14). Make up to the volume with water, mix, filter immediately through a dry filter into a dry receiver and immediately determine the cyanamide nitrogen.

In both cases, determine the various soluble forms of nitrogen the same day the solution is made up, starting with cyanamide nitrogen and urea nitrogen, if they are present.

Total soluble nitrogen

(7.2.2.1) *In the absence of nitrate*

Transfer by pipette into a 300 ml Kjeldahl flask, an aliquot portion of the filtrate (7.2.1.1 or 7.2.1.2), containing not more than 100 mg of nitrogen. Add 15 ml of concentrated sulfuric acid (4.12), 0.4 g of copper oxide or 1.25 g of copper sulfate (4.27) and a few anti-bump granules (4.28). First heat gently to begin the digestion and then at a higher temperature until the liquid becomes colourless or slightly greenish and white fumes are clearly apparent. After cooling, quantitatively transfer the solution into the distillation flask, dilute to about 500 ml with water and add a few anti-bump granules (4.28). Connect the flask to the distillation apparatus (5.1) and continue the distillation as described in paragraph 7.1.1.2.

(7.2.2.2) *In the presence of nitrate*

Status: This is the original version (as it was originally made). This item of legislation is currently only available in its original format.

Transfer by pipette into a 500 ml Erlenmeyer flask, an aliquot portion of the filtrate (7.2.1.1 or 7.2.1.2) containing not more than 40 mg of nitric nitrogen. At this stage of the analysis the total quantity of nitrogen is not important. Add 100 ml of 30% sulfuric acid (4.15), 5 g of reduced iron (4.2) and immediately cover the Erlenmeyer flask with a watch glass. Heat gently until the reaction is steady but not vigorous. At this juncture stop the heating and allow the flask to stand for at least three hours at ambient temperature. With water, quantitatively transfer the liquid into a 250 ml graduated flask, leaving behind the undissolved iron and make up to the mark with water. Mix thoroughly, and transfer by pipette into a 300 ml Kjeldahl flask, an aliquot part containing not more than 100 mg of nitrogen. Add 15 ml of concentrated sulfuric acid (4.12), 0.4 g of copper oxide or 1.25 g of copper sulfate (4.27) and some anti-bump granules (4.28). First heat gently to begin the digestion and then at a higher temperature until the liquid becomes colourless or slightly greenish and white fumes are clearly apparent. After cooling transfer the solution quantitatively into the distillation flask, dilute to approximately 500 ml with water and add some anti-bump granules (4.28). Connect the flask to the distillation apparatus (5.1) and continue the determination as described in paragraph 7.1.1.2.

(7.2.2.3) *Blank test*

See 7.1.1.3.

(7.2.2.4) *Expression of result*

$$\%N = \frac{(a - A) \times 0.28}{M}$$

where:

a = ml of standard solution of sodium or potassium hydroxide (0.2 M) used for the blank.

A = ml of standard solution of sodium or potassium hydroxide (0.2 M) used for analysis.

M = mass of the sample, expressed in grams, present in the aliquot part taken for analysis.

Total soluble nitrogen with the exception of nitric nitrogen

(7.2.3) Transfer by pipette into a 300 ml Kjeldahl flask, an aliquot portion of the filtrate (7.2.1.1 or 7.2.1.2) containing not more than 50 mg of nitrogen. Dilute to 100 ml with water, add 5 g of ferrous sulfate (4.16), 20 ml of concentrated sulfuric acid (4.1) and some anti-bump granules (4.28). First heat gently and then increase the heat until white fumes appear. Continue the digestion for 15 minutes. Stop the heating, introduce the copper oxide (4.27) as a catalyst and keep it at a temperature such that white fumes are emitted for a further 10 to 15 minutes. After cooling, quantitatively transfer the contents of the Kjeldahl flask into the distillation flask of the apparatus (5.1). Dilute to approximately 500 ml with water and add a few anti-bump granules (4.28). Connect the flask to the distillation apparatus and continue the determination as described in paragraph 7.1.1.2.

(7.2.3.1) *Blank test*

See 7.1.1.3.

(7.2.3.2) *Expression of result*

$$\%N = \frac{(a - A) \times 0.28}{M}$$

Status: This is the original version (as it was originally made). This item of legislation is currently only available in its original format.

where:

a = ml of standard solution of sodium or potassium hydroxide (0.2 M) used for the blank.

A = ml of standard solution of sodium or potassium hydroxide (0.2 M) used for analysis.

M = mass of the sample, expressed in grams, present in the aliquot part taken for analysis.

(7.2.4) *Nitric nitrogen* is obtained:

(7.2.4.1) *In the absence of calcium cyanamide*

By the difference between the results obtained in paragraphs 7.2.2.4 and 7.2.3.2 and/or the result obtained in paragraph 7.2.2.4 and the sum of the results obtained in paragraphs 7.2.5.2 or 7.2.5.5 and 7.2.6.3 or 7.2.6.5 or 7.2.6.6.

(7.2.4.2) *In the presence of calcium cyanamid*

By the difference between the results obtained in paragraphs 7.2.2.4 and 7.2.3.2 and between the result obtained in paragraph 7.2.2.4 and the sum of the results obtained in paragraphs 7.2.5.5 and 7.2.6.3 or 7.2.6.5 or 7.2.6.6 and 7.2.7.

Ammoniacal nitrogen

(7.2.5) *2.5.1) Solely in the presence of ammoniacal nitrogen and ammoniacal + nitric nitrogen*

Transfer by pipette into the flask of the distillation apparatus (5.1) an aliquot portion of the filtrate (7.2.1.1) containing not more than 100 mg of ammoniacal nitrogen. Add water to obtain a total volume of about 350 ml and some anti-bump granules (4.28) to facilitate boiling. Connect the flask to the distillation apparatus, add 20 ml of sodium hydroxide solution (4.9) and distil as described in paragraph 7.1.1.2.

(7.2.5.2) *Expression of result*

$$\%N \text{ (ammoniacal)} = \frac{(a - A) \times 0.28}{M}$$

where:

a = ml of standard solution or potassium hydroxide (0.2 M) used for the blank.

A = ml of standard solution of sodium or potassium hydroxide (0.2 M) used for the analysis.

M = mass of the sample, expressed in grams, present in the aliquot part taken for analysis.

(7.2.5.3) *In the presence of urea and/or cyanamide nitroge*

Transfer by pipette into the dry flask of the apparatus (5.2), an aliquot portion of the filtrate (7.2.1.1 or 7.2.1.2) containing not more than 20 mg of ammoniacal nitrogen. Then assemble the apparatus. Transfer by pipette into the 300 ml Erlenmeyer flask 50 ml of the standard sulfuric acid solution 0.1 M (4.17) and enough distilled water for the level of the liquid to be approximately 5 cm above the opening of the delivery tube; add the indicator (4.29.1). Introduce, through the side neck of the reaction flask, distilled water to make up the volume to about 50 ml and mix. To avoid foaming during aeration, add a few drops of octan-1-ol (4.18). Make the solution alkaline by adding 50 ml of saturated potassium carbonate solution (4.19) and immediately begin to expel the ammonia thus liberated from the cold suspension. A strong current of air is necessary (flow of approximately 3 litres per minute) and should be purified

Status: This is the original version (as it was originally made). This item of legislation is currently only available in its original format.

beforehand by passing it through washing flasks containing dilute sulfuric acid and dilute sodium hydroxide. Instead of using pressurised air, it is also possible to use a vacuum (water pump) provided that the inflow tube is connected in a sufficiently airtight manner to the receiver used to collect the ammonia. The liberation of the ammonia is generally complete after three hours. It is nevertheless advisable to verify this by changing the receiving flask. When the operation is finished, disconnect the flask from the apparatus, rinse the tip of the tube and the sides of the flask with a little distilled water. Titrate the excess acid with standard sodium hydroxide solution (0.1 M) (4.20) to the end point of the indicator (4.29.1).

(7.2.5.4) *Blank test*

See 7.1.1.3.

(7.2.5.5) *Expression of result*

$$\%N = \frac{(a - A) \times 0.14}{M}$$

where:

a = ml of standard solution of sodium or potassium hydroxide (0.1 M) used for the blank.

A = ml of standard solution of sodium or potassium hydroxide (0.1 M) used for the analysis.

M = mass of the sample, expressed in grams, present in the aliquot part taken for analysis.

Ureic nitrogen

(7.2.6) 2.6.1) *Urease method*

Transfer by pipette into a 500 ml graduated flask, an aliquot portion of the filtrate (7.2.1.1 or 7.2.1.2) containing not more than 250 mg of ureic nitrogen. To remove phosphates add saturated barium hydroxide solution (4.21) until no further precipitation occurs. Eliminate the excess of barium ions and any dissolved calcium ions by adding 10% sodium carbonate solution (4.22). Allow the precipitate to settle and check whether total precipitation has occurred. Make up to the mark, mix and filter through a pleated filter. Transfer by pipette 50 ml of the filtrate into the 300 ml Erlenmeyer flask of the apparatus (5.3). Acidify the filtrate with 2 M hydrochloric acid (4.23), until a pH of 3.0 measured by the pH meter (5.5) is obtained. Then raise the pH to 5.4 with 0.1 M sodium hydroxide solution (4.20).

To avoid losses of ammonia during reaction with urease, close the Erlenmeyer flask with a stopper provided with a separating funnel and a small bubble trap containing exactly 2 ml of standard 0.1 M hydrochloric acid (4.24). Introduce through the separating funnel 20 ml of urease solution (4.25), and allow to stand for one hour at 20-25°C. Transfer by pipette 25 ml of standard 0.1 M hydrochloric acid (4.24) into the separating funnel, allow it to run through into the solution and then rinse with a little water. In the same way transfer quantitatively the contents of the bubble trap into the solution contained in the Erlenmeyer flask. Titrate the excess acid with the standard solution of sodium hydroxide (0.1 M) (4.20), until a pH of 5.4 is obtained, measured by the pH meter.

(7.2.6.2) *Blank test*

See 7.1.1.3.

Status: This is the original version (as it was originally made). This item of legislation is currently only available in its original format.

(7.2.6.3) *Expression of result*

$$\%N (\text{ureic}) = \frac{(a - A) \times 0.14}{M}$$

where:

a = ml of standard solution of sodium or potassium hydroxide (0.1 M) used for the blank, carried out exactly under the same conditions as the analysis.

A = ml of standard solution of sodium or potassium hydroxide (0.1 M) used for the analysis.

M = mass of the sample, expressed in grams, present in the aliquot part taken for analysis.

Remarks

- (1) After precipitation by the solutions of barium hydroxide and sodium carbonate, make up to the mark, filter and neutralise as rapidly as possible.
- (2) The titration may also be carried out with the indicator (4.29.2), but the end point is then more difficult to observe.

(7.2.6.4) *Gravimetric method with xanthydrol*

Transfer by pipette into a 250 ml beaker, an aliquot portion of the filtrate (7.2.1.1 or 7.2.1.2) containing not more than 20 mg of urea. Add 40 ml of acetic acid (4.14). Stir with a glass rod for one minute, allow any precipitate to settle for five minutes. Filter into a 100 ml beaker, wash with several ml of acetic acid (4.14), then add to the filtrate drop by drop, 10 ml of xanthydrol solution (4.16), stirring continuously with a glass rod. Allow to stand until the precipitate appears, then stir again for one or two minutes. Allow to stand for one and a half hours. Filter through a sintered glass crucible (5.7) which has been previously dried and weighed, using a slight reduction in pressure. Wash three times with 5 ml ethanol (4.31) without trying to remove all the acetic acid. Place it in the oven (5.6) at a temperature of 130°C for one hour (do not exceed 145°C). Allow to cool in a desiccator and weigh.

(7.2.6.5) *Expression of result*

$$\% (\text{ureic} + \text{biuret}) N = \frac{6.67 \times m}{M}$$

where:

m = mass of the precipitate obtained, in grams.

M = mass of the sample, in grams, present in the aliquot part taken for analysis. Correct for the blank.

(Note) Although biuret will also be precipitated by xanthydrol, this should not give rise to a significant error in the determination since its level is generally low.

(7.2.6.6) *Method of difference*

Ureic nitrogen may also be calculated according to the following table:—

Case	Nitric Nitrogen	Ammoniacal Nitrogen	Cyanamide Nitrogen	Ureic Nitrogen
1	Absent	Present	Present	(7.2.2.4)-(7.2.5.5 + 7.2.7)

Case	Nitric Nitrogen	Ammoniacal Nitrogen	Cyanamide Nitrogen	Ureic Nitrogen
2	Present	Present	Present	(7.2.3.2)-(7.2.5.5 + 7.2.7)
3	Absent	Present	Absent	(7.2.2.4)-(7.2.5.5)
4	Present	Present	Absent	(7.2.3.2)-(7.2.5.5)

Cyanamide Nitrogen

(7.2.7) Take an aliquot part of the filtrate (7.2.1.2), containing 10 to 30 mg of cyanamide nitrogen and place it in a 250 ml beaker. Continue the analysis according to Method 6.

VERIFICATION OF RESULTS

8.—(8.1) In certain cases, a difference may be found between the total nitrogen obtained directly from a weighed out sample (paragraph 7.1) and total soluble nitrogen (paragraph 7.2.2). Nevertheless, the difference should not be greater than 0.5%. If this is not the case, the fertiliser contains forms of insoluble nitrogen not specified for fertilisers covered by the list in paragraph 2.

(8.2) Before each analysis, check that the apparatus is working properly and that the correct application of the method is used, with a standard solution including the various forms of nitrogen in proportions similar to those of the test sample. This standard solution is prepared from solutions of potassium thiocyanate (4.3), potassium nitrate (4.4), ammonium sulfate (4.5) and urea (4.6).

8b.

DETERMINATION OF DIFFERENT FORMS OF NITROGEN IN THE
SAME SAMPLE — IN THE ABSENCE OF CYANAMIDE NITROGEN

SCOPE

1. This method is for the determination of any one form of nitrogen in the presence of any other form, but in the absence of cyanamide nitrogen.

FIELD OF APPLICATION

2. This method is applicable to all fertilisers in Group 1(a) of Section A and Groups 1, 2 and 3 of Section B of the Table in Schedule 1 to the Fertilisers Regulations (Northern Ireland) 1992(9) which contain exclusively nitric, ammoniacal or ureic nitrogen.

PRINCIPLE

3. The following determinations are made on different portions of a single sample solution.

Total soluble nitrogen

(3.1.1) (3.1) (3.1.1) *In the absence of nitrates*, by direct Kjeldahl digestion of the solution.

(3.1.2) *In the presence of nitrates*, by Kjeldahl digestion of a portion of the solution after reduction by the Ulsch method; ammonia is determined in both cases as described in Method 2.

(3.2) *Total soluble nitrogen except nitric nitrogen*, by Kjeldahl digestion after elimination of nitric nitrogen in acid medium by means of ferrous sulfate; ammonia is determined as described in Method 2.

Status: This is the original version (as it was originally made). This item of legislation is currently only available in its original format.

(3.3) *Nitric nitrogen*, by difference: between 3.1.2 and 3.2 and/or between total soluble nitrogen (3.1.2) and the sum of ammoniacal and ureic nitrogen (3.4 + 3.5).

(3.4) *Ammoniacal nitrogen*, by cold distillation of a weak alkaline solution; the ammonia is absorbed in a solution of sulfuric acid and determined as described in Method 2.

(3.5) *Ureic nitrogen*, either:

(3.5.1) *By conversion using urease*, into ammonia, which is determined by titration with a standard solution of hydrochloric acid;

or,

(3.5.2) *By gravimetry using xanthidrol*: although biuret will also be precipitated by xanthidrol, this should not give rise to a significant error in the determination since its level is generally low in absolute value in compound fertilisers,

or,

(3.5.3) *By difference*, according to the following table:

Case	Nitric nitrogen	Ammoniacal nitrogen	Difference
1	Absent	Present	(3.1.1)-(3.4)
2	Present	Present	(3.2)-(3.4)

REAGENTS

4.—(4.1) Potassium sulfate.

(4.2) Iron powder, reduced with hydrogen (the prescribed quantity of iron must be able to reduce at least 50 mg nitric nitrogen).

(4.3) Potassium nitrate.

(4.4) Ammonium sulfate.

(4.5) Urea.

(4.6) Sulfuric acid, 0.1 M solution.

(4.7) Sodium hydroxide solution 30 g per 100 ml, ammonia free.

(4.8) Sodium or potassium hydroxide, 0.2 M solution, free of carbonates.

(4.9) Sulfuric acid ($\rho = 1.84$ g/ml).

(4.10) Hydrochloric acid solution: dilute an appropriate volume of hydrochloric acid ($\rho = 1.18$ g/ml) with an equal volume of water.

(4.11) Glacial acetic acid.

(4.12) Sulfuric acid solution, approximately 30% (W/V) H_2SO_4 .

(4.13) Ferrous sulfate, crystalline $FeSO_4 \cdot 7H_2O$.

(4.14) Sulfuric acid, 0.05 M solution.

(4.15) Octan-1-ol.

(4.16) Potassium carbonate, saturated solution.

(4.17) Sodium or potassium hydroxide, 0.1 M solution.

(4.18) Barium hydroxide, saturated solution.

(4.19) Sodium carbonate solution, 10 g per 100 ml.

(4.20) Hydrochloric acid, 2 M solution.

(4.21) Hydrochloric acid, 0.1 M solution.

(4.22) Urease solution: suspend 0.5 g active urease in 100 ml distilled water. Using 0.1 M hydrochloric acid (4.21), adjust to pH 5.4, measured with pH meter.

(4.23) Xanthidrol solution, 5 g per 100 ml in ethanol or methanol (4.28) (do not use products giving a high proportion of insoluble material). The solution can be kept for 3 months in a carefully stoppered bottle in the dark.

(4.24) Catalyst: copper oxide (CuO), 0.3 to 0.4 g per determination, or an equivalent amount of copper sulfate pentahydrate (0.95 to 1.25 g).

(4.25) Anti-bump granules of pumice stone washed with hydrochloric acid and ignited.

(4.26) Indicator solutions:

(4.26.1) Mixed indicator:

Solution A: dissolve 1 g methyl red in 37 ml 0.1 M sodium hydroxide solution and make up to 1 litre with water.

Solution B: dissolve 1 g methylene blue in water and make up to 1 litre. Mix 1 volume of solution A and 2 volumes of solution B. This indicator is violet in acid solution, grey in neutral solution and green in alkaline solution; use 0.5 ml (10 drops) of this indicator.

(4.26.2) Methyl red indicator solution:

Dissolve 0.1 g methyl red in 50 ml 95% ethanol, make up to 100 ml with water and filter if necessary; 4-5 drops of this indicator can be used instead of the previous one.

(4.27) Indicator papers: litmus, bromothymol blue (or other papers sensitive in the range pH 6-8).

(4.28) Ethanol or methanol, 95% (V/V).

APPARATUS

5.—(5.1) Distillation apparatus. See Method 2.

(5.2) Apparatus for determination of ammoniacal nitrogen. An example of the recommended apparatus is reproduced in Figure 6 in the Appendix.

(5.3) Apparatus for determination of ureic nitrogen by the urease method (7.6.1). An example of the recommended apparatus is reproduced in Figure 7 in the Appendix.

(5.4) Rotary shaker: 35-40 turns per minute.

(5.5) pH meter.

(5.6) Sintered glass crucibles, diameter of pores 5 to 15 microns.

PREPARATION OF SAMPLE

6. See Method 1.

PROCEDURE

Preparation of solution for analysis

Preparation of solution for analysis

7.—(7.1) Weigh to the nearest 0.001 g, 10 g of the prepared sample and transfer to a 500 ml graduated flask. Add 50 ml water and then 20 ml dilute hydrochloric acid (4.10) and mix. Allow to stand until the evolution of carbon dioxide ceases. Add 400 ml water; shake for half an hour; make up to volume with water, mix, filter through a dry filter into a dry container.

Status: This is the original version (as it was originally made). This item of legislation is currently only available in its original format.

Total nitrogen

In the absence of nitrates

- (7.2.1) Transfer by pipette into a 300 ml Kjeldahl flask an aliquot portion of the filtrate (7.1) containing a maximum of 100 mg nitrogen. Add 15 ml concentrated sulfuric acid (4.9), 0.4 g copper oxide or 1.25 g copper sulfate (4.24) and a few glass beads to control boiling. Heat moderately at first in order to initiate the reaction, then more strongly until the liquid becomes colourless or slightly greenish and white fumes appear. After cooling, transfer the solution into the distillation flask, dilute to about 500 ml with water and add a few granules of pumice stone (4.25). Connect the flask to the distillation apparatus (5.1) and carry out the determination as described in Method 8a, 7.1.1.2.

In the presence of nitrates

- (7.2.2) Transfer by pipette into a 500 ml Erlenmeyer flask an aliquot portion of the filtrate (7.1) containing not more than 40 mg nitric nitrogen. At this stage of the analysis, the total quantity of nitrogen is unimportant. Add 10 ml of 30% sulfuric acid (4.12), 5 g reduced iron (4.2) and immediately cover the Erlenmeyer flask with a watch glass. Heat gently until the reaction becomes strong but not violent. Stop heating and allow to stand for at least 3 hours at ambient temperature. Transfer the liquid quantitatively to a 250 ml graduated flask, ignoring undissolved iron. Make up to the mark with water and mix carefully. Transfer by pipette a portion containing a maximum of 100 mg nitrogen into a 300 ml Kjeldahl flask. Add 15 ml concentrated sulfuric acid (4.9), 0.4 g copper oxide or 1.25 g copper sulfate (4.24) and a few glass beads.

Heat moderately at first in order to initiate the reaction, then more strongly until the liquid becomes colourless or slightly greenish and white fumes appear. After cooling, transfer the solution quantitatively to the distillation flask, dilute to about 500 ml with water and add a few granules of pumice stone (4.25). Connect the flask to the distillation apparatus (5.1) and continue the determination as described in Method 8a, 7.1.1.2.

Blank test

- (7.2.3) Carry out a blank test under the same conditions (omitting only the sample) and use this value in the calculation of the final result.

Expression of result

(7.2.4)

$$\%N \text{ (total)} = \frac{(a - A) \times 0.28}{M}$$

where:

a = ml of standard solution of sodium or potassium hydroxide (0.2 M) used for the blank, carried out under the same conditions as the analysis.

A = ml of standard solution of sodium or potassium hydroxide (0.2 M) used for the analysis.

M = mass of the sample, in grams, present in the aliquot part taken for analysis.

Total nitrogen excluding nitric nitrogen

- (7.3.1) (7.3) (7.3.1) Transfer by pipette into a 300 ml Kjeldahl flask an aliquot portion of the filtrate (7.1) containing not more than 50 mg of nitrogen. Dilute to 100 ml with water, add 5 g ferrous sulfate (4.13), 20 ml concentrated sulfuric acid (4.9) and a few glass beads

Status: This is the original version (as it was originally made). This item of legislation is currently only available in its original format.

to control boiling (4.25). Heat moderately at first then more strongly until white fumes appear. Continue the reaction for 15 minutes. Stop heating, introduce 0.4 g copper oxide or 1.25 g copper sulfate (4.24) as catalyst, resume heating and maintain production of white fumes for 10-15 minutes. After cooling, transfer the contents of the Kjeldahl flask quantitatively to the distillation flask (5.1). Dilute to about 500 ml with water and add a few granules of pumice stone (4.25). Connect the flask to the distillation apparatus and continue the determinations as in Method 8a, 7.1.1.2.

Blank test

(7.3.2) See 7.2.3.

Expression of result

(7.3.3)

$$\%N \text{ (total)} = \frac{(a - A) \times 0.28}{M}$$

where:

a = ml of standard solution of sodium or potassium hydroxide (0.2 M) used for the blank.

A = ml of standard solution of sodium or potassium hydroxide (0.2 M) used for the analysis.

M = mass of the sample, in grams, present in the aliquot part taken for analysis.

(7.4) Nitric nitrogen is obtained: by difference between

(7.2.4)-(7.5.3 + 7.6.3)

or (7.2.4)-(7.5.3 + 7.6.5)

or (7.2.4)-(7.5.3 + 7.6.6)

Ammoniacal nitrogen

In the presence of ureic nitrogen

(7.5.1) Transfer by pipette into the dry flask of the apparatus (5.2) an aliquot portion of the filtrate (7.1) containing a maximum of 20 mg ammoniacal nitrogen. Connect up the apparatus. Place in the 300 ml Erlenmeyer flask 50.0 ml standard 0.05 M sulfuric acid solution (4.14) and an amount of distilled water such that the level of the liquid is about 5 cm above the opening of the intake tube. Introduce through the side neck of the reaction flask distilled water so as to bring the volume to about 50 ml and mix. To avoid foaming during aeration add several drops of octan-1-ol (4.15). Add 50 ml saturated potassium carbonate solution (4.16) and immediately begin to expel the ammonia thus released from the cold suspension. A strong current of air is necessary (flow rate of about 3 litres per minute) and should be purified beforehand by passing it through washing flasks containing dilute sulfuric acid and dilute sodium hydroxide. Instead of using air under pressure, a vacuum may be used (water pump) provided that the connections between the apparatus are air tight. The liberation of ammonia is generally complete after three hours. However, it is desirable to make certain of this by changing the Erlenmeyer flask. When the process is finished, disconnect the Erlenmeyer flask from the apparatus, rinse the end of the intake tube and the walls of the Erlenmeyer flask with a little distilled water and titrate the excess acid against standard 0.1 M sodium hydroxide solution (4.17).

Blank test

Status: This is the original version (as it was originally made). This item of legislation is currently only available in its original format.

(7.5.2) See 7.2.3.

Expression of result

(7.5.3)

$$\%N \text{ (ammoniacal)} = \frac{(a - A) \times 0.14}{M}$$

where:

a = ml of standard solution of sodium or potassium hydroxide (0.1 M) (4.17) used for the blank.

A = ml of standard solution of sodium or potassium hydroxide (0.1 M) (4.17) used for the analysis.

M = mass of the sample, in grams, present in the aliquot part taken for analysis.

Ureic nitrogen

Urease method

(7.6.1) Transfer by pipette into a 500 ml graduated flask, an aliquot portion of the filtrate (7.1) containing not more than 250 mg of ureic nitrogen. To remove phosphates, add a suitable quantity of saturated barium hydroxide solution (4.18) until further addition does not cause the production of more precipitate. Eliminate excess barium ions (and any dissolved calcium ions) with 10% sodium carbonate solution (4.19). Allow to settle and check whether precipitation is complete. Make up to the mark, mix and filter through a fluted filter paper. Transfer by pipette 50 ml of filtrate into the 300 ml Erlenmeyer flask of the apparatus (5.3). Acidify with 2 M hydrochloric acid (4.20) to pH 3.0, measured by means of the pH meter (5.5). Raise the pH to 5.4 by the addition of 0.1 M sodium hydroxide (4.17). To avoid ammonia losses when hydrolysis by urease occurs, close the Erlenmeyer flask by means of a stopper provided with a dropping funnel and a small bubble trap containing exactly 2 ml standard 0.1 M hydrochloric acid solution (4.21). Introduce through the separating funnel, 20 ml urease solution (4.22). Allow to stand for one hour at 20-25°C. Place 25.0 ml of the standard 0.1 M hydrochloric acid solution (4.20) in the dropping funnel, allow to run into the solution, then rinse with a little water. Transfer quantitatively the contents of the bubble trap to the solution contained in the Erlenmeyer flask. Titrate the excess acid using standard 0.1 M sodium hydroxide solution (4.17), until a pH of 5.4 is obtained, measured on the pH meter.

Remarks

1. After precipitation by barium hydroxide and sodium carbonate solutions, make up to the mark, filter and neutralise as quickly as possible.
2. The titration may also be carried out using an indicator (4.26), although the change of colour is more difficult to observe.

Blank test

(7.6.2) See 7.2.3.

Expression of result

(7.6.3)

$$\%N \text{ (ureic)} = \frac{(a - A) \times 0.14}{M}$$

Status: This is the original version (as it was originally made). This item of legislation is currently only available in its original format.

where:

a = ml of standard solution of sodium or potassium hydroxide (0.1 M) (4.17) used for the blank, carried out in exactly the same conditions as the analysis.

A = ml of standard solution of sodium or potassium hydroxide (0.1 M) (4.17) used for the analysis.

M = mass of the sample, in grams, present in the aliquot part taken for analysis.

Gravimetric method using xanthydrol

- (7.6.4) Transfer by pipette into a 100 ml beaker an aliquot portion of the filtrate (7.1) containing not more than 20 mg urea. Add 40 ml acetic acid (4.11). Stir with a glass rod for one minute. Allow any precipitate to settle for five minutes. Filter, wash with a few ml acetic acid (4.11). Add 10 ml xanthydrol solution (4.23) to the filtrate drop by drop, stirring continuously with a glass rod. Allow to stand until the precipitate appears, then stir again for one or two minutes. Allow to stand for one and a half hours. Filter, using a slight reduction in pressure, through a sintered glass crucible (5.6) which has been previously dried and weighed. Wash three times with 5 ml ethanol (4.28), without trying to remove all the acetic acid. Place in an oven at a temperature of 130°C for one hour (do not exceed 145°C). Allow to cool in a desiccator and weigh.

Expression of result

$$(7.6.5) \quad \% \text{N (ureic)} = \frac{6.67 \times m}{M}$$

where:

m = mass of the precipitate in grams.

M = mass of the sample, in grams, present in the aliquot part taken for analysis.

Correct for the blank.

Although biuret will also be precipitated by xanthydrol, this should not give rise to a significant error in the determination since its level is generally low in absolute value in compound fertilisers.

Note:

Although biuret will also be precipitated by xanthydrol, this should not give rise to a significant error in the determination since its level is generally low in absolute value in compound fertilisers.

Difference method

- (7.6.6) Ureic N can also be calculated as indicated in the following table:

Case	Nitric N	Ammoniacal N	Ureic N
1	Absent	Present	(7.2.4)-(7.5.3)
2	Present	Present	(7.3.3)-(7.5.3)

VERIFICATION OF RESULTS

8.—(8.1) Before each analysis, check the functioning of the apparatus and the correct application of the methods used with a standard solution containing the different forms of nitrogen in proportions

Status: This is the original version (as it was originally made). This item of legislation is currently only available in its original format.

similar to those in the sample. This standard solution is prepared from solutions of potassium nitrate (4.3), ammonium sulfate (4.4) and urea (4.5).

9a.

EXTRACTION OF TOTAL PHOSPHORUS BY MINERAL ACIDS

SCOPE

1. This method is for the determination of phosphorus soluble in mineral acids.

FIELD OF APPLICATION

2. Subject to regulation 5(3), applicable only to the phosphatic fertilisers listed in Group 2(a) of Section A and Groups 1, 2 and 4 of Section B of the Table in Schedule 1 to the Fertilisers Regulations (Northern Ireland) 1992(10), and to phosphatic fertilisers listed in Groups 1(a), 1(b) and 2 of Section C of that Table which are not designated as “EEC fertiliser”.

PRINCIPLE

3. Extraction of the phosphorus in the fertiliser with a mixture of nitric acid and sulfuric acid.

REAGENTS

- 4.—(4.1) Sulfuric acid ($\rho = 1.84$ g/ml).
- (4.2) Nitric acid ($\rho = 1.40$ g/ml).

APPARATUS

5.—(5.1) A Kjeldahl flask, with a capacity of at least 500 ml, or a 250 ml round-bottomed flask with a glass tube forming a reflux condenser.

PREPARATION OF SAMPLE

6. See Method 1.

PROCEDURE

Extraction

Extraction

7.—(7.1) Weigh to the nearest 0.001 g, 2.5 g of the prepared sample and place it in a dry Kjeldahl flask. Add 15 ml water and swirl to suspend the substance. Add 20 ml nitric acid (4.2) and carefully add 30 ml sulfuric acid (4.1). When the initial violent reaction has ceased, slowly bring the contents of the flask to boiling and boil for 30 minutes. Allow to cool and then carefully add with mixing about 150 ml water and boil for 15 minutes.

Cool completely and transfer the liquid quantitatively to a 500 ml graduated flask. Make up to volume, mix and filter through a dry fluted filter, discarding the first portion of the filtrate.

Determination

- (7.2) Determine the phosphorus using Method 10 on an aliquot portion of the clear filtrate.

Note:

If the sample contains cellulose matter, the following procedure is suggested to avoid excessive frothing during digestion:

Weigh to the nearest 0.001 g, 2.5 g of the prepared sample and place it in a dry Kjeldahl flask. Add 30 ml sulfuric acid (4.1) and carefully boil until most of the organic matter has been destroyed. Allow to cool, add 15 ml water and 20 ml nitric acid (4.2); bring to the boil and continue boiling for 30 minutes. Continue as described in 7.1 from “Allow to cool and then ...”.

9b.

EXTRACTION OF TOTAL PHOSPHORUS BY MINERAL ACIDS

SCOPE

1. This method is for the determination of phosphorus soluble in 2% formic acid.

FIELD OF APPLICATION

2. Applicable only to soft natural phosphate.

PRINCIPLE

3. To differentiate between hard natural phosphates and soft natural phosphates, phosphorus soluble in formic acid is extracted under specified conditions.

REAGENTS

- 4.—(4.1) Formic acid, 2% (20 g per litre): dilute 82 ml formic acid (concentration 98-100%; $\rho = 1.22$ g/ml) to 5 litres with distilled water.

APPARATUS

- 5.—(5.1) 500 ml graduated flask with a wide neck (eg Stohmann).
(5.2) Rotary shaker, 35-40 turns per minute.

PREPARATION OF SAMPLE

6. See Method 1.

PROCEDURE

Extraction

Extraction

7.—(7.1) Weigh to the nearest 0.001 g, 5 g of the prepared sample and place it in a dry 500 ml graduated flask (5.1). While continuously rotating the flask by hand, add the formic acid (4.1) (at $20 \pm 1^\circ\text{C}$) until it is approximately 1 cm below the graduation mark. Then make up to the volume. Close the flask with a rubber stopper and shake for 30 minutes (5.2). Filter the solution through a dry fluted filter, into a dry receiver, discarding the first portion of the filtrate.

Determination

- (7.2) Determine the phosphorus using Method 10 on an aliquot portion of the clear filtrate.

Status: This is the original version (as it was originally made). This item of legislation is currently only available in its original format.

9c.

EXTRACTION OF PHOSPHORUS BY 2% CITRIC ACID

SCOPE

1. This method is for the determination of phosphorus soluble in 2% citric acid.

FIELD OF APPLICATION

2. Subject to regulation 5(3) only applicable to basic slag fertilisers in Group 2(a) of Section A and Groups 1, 2 and 4 of Section B of the Table in Schedule 1 to the Fertilisers Regulations (Northern Ireland) 1992.

PRINCIPLE

3. Extraction of the phosphorus in the fertiliser with a 2% citric acid solution under specified conditions.

REAGENT

- 4.—(4.1) 2% citric acid solution (20 g per litre), prepared from citric acid monohydrate.

Note:

Verify the concentration of this citric acid solution by titrating 10 ml with a 0.1 M sodium hydroxide standard solution using phenolphthalein as an indicator. If the concentration is correct, the titre should be 28.55 ml.

APPARATUS

- 5.—(5.1) Rotary shaker, 35-40 turns per minute.

PREPARATION OF SAMPLE

6. The analysis is carried out on the product as received, without grinding, after carefully mixing the original sample to ensure it is homogeneous. See Method 1.

PROCEDURE

Extraction

Extraction

7.—(7.1) Weigh to the nearest 0.001 g, 5 g of the mixed sample and place it in a dry flask with a sufficiently wide neck, with a capacity of 600 ml, to allow the liquid to be shaken thoroughly. Add 500 ml \pm 1 ml of the citric acid solution (4.1) at 20 \pm 1°C. When adding the first portion of the reagent shake vigorously by hand to stop the formation of lumps and to prevent the sample sticking to the sides. Close the flask with a rubber stopper and shake it on the rotary shaker (5.1) for exactly 30 minutes at a temperature of 20 \pm 2°C.

Filter immediately through a dry fluted filter, into a dry glass receiver and discard the first 20 ml of the filtrate. Continue the filtration until a sufficient quantity of filtrate is obtained to carry out the phosphorus determination.

Determination

(7.2) Determine the phosphorus using Method 10 on an aliquot portion of the clear filtrate.

9d.

EXTRACTION OF PHOSPHORUS BY NEUTRAL AMMONIUM CITRATE

SCOPE

1. This method is for the determination of phosphorus soluble in neutral ammonium citrate.

FIELD OF APPLICATION

2. Applicable to all fertilisers in Group 2(a) of Section A and Groups 1, 2 and 4 of Section B and Group 2 of Section C of the Table in Schedule 1 to the Fertilisers Regulations (Northern Ireland) 1992 for which the declaration of the solubility in neutral ammonium citrate is prescribed.

PRINCIPLE

3. Extraction of phosphorus at a temperature of 65°C using a neutral ammonium citrate solution (pH = 7.0) under specified conditions.

REAGENTS

4

Neutral ammonium citrate solution (pH = 7.0)

4.1 This solution must contain 185 g of citric acid monohydrate per litre and must have a specific gravity of 1.09 at 20°C and a pH of 7.0. The reagent is prepared as follows:

Dissolve 370 g citric acid monohydrate in about 1.5 litres of water and make an approximately neutral solution by adding 345 ml of ammonia solution (28-29% of NH₃). If the NH₃ concentration is lower than 28% add a correspondingly larger quantity of ammonia solution and dilute the citric acid in correspondingly smaller quantities of water.

Cool and make exactly neutral by adding the ammonia solution (28-29% of NH₃) drop by drop, stirring continuously (with a mechanical stirrer) until a pH of exactly 7.0 at 20°C is obtained, keeping the electrodes of the pH meter (5.1) immersed in the solution.

At this point make up the volume to 2 litres and test the pH again. Keep the reagent in a closed container and check the pH at regular intervals.

APPARATUS

5.—(5.1) pH meter.

(5.2) Water bath which can be set thermostatically at 65°C, equipped with a mechanically operated shaking tray (see Figure 8 in the Appendix).

PREPARATION OF SAMPLE

6. See Method 1.

PROCEDURE

Extraction

Status: This is the original version (as it was originally made). This item of legislation is currently only available in its original format.

Extraction

7.—(7.1) Transfer 1(11) or 3(12) grams, as appropriate, of the fertiliser to be analysed into a 200 or 250 ml Erlenmeyer flask containing 100 ml of ammonium citrate solution previously heated at 65°C. Stopper the Erlenmeyer flask and shake in order to suspend the fertiliser without forming lumps. Remove the stopper for an instant in order to balance the pressure and close the Erlenmeyer flask again. Place the flask in the water-bath (5.2) set to maintain the contents of the flask at exactly 65°C. Shake mechanically for one hour so as to ensure complete suspension of the sample(13). The level of suspension in the flask must stay constantly below that of the water in the bath. After exactly one hour remove the Erlenmeyer flask from the water-bath. Cool immediately under running water to ambient temperature and transfer the contents quantitatively from the Erlenmeyer flask into a graduated 500 ml flask with a jet of water. Make up the volume of water. Mix thoroughly and filter through a dry fluted filter (medium speed) into a dry container, discarding the first part of the filtrate (about 50 ml).

About 100 ml of clear filtrate should be collected.

Determination

(7.2) Determine the phosphorus using Method 10 in an aliquot portion of the clear filtrate.

9e.

EXTRACTION OF PHOSPHORUS BY ALKALINE AMMONIUM CITRATE (PETERMANN'S METHOD) AT 65°C

SCOPE

1. This method is for the determination of phosphorus soluble in alkaline ammonium citrate.

FIELD OF APPLICATION

2. Applicable only to precipitated dihydrated dicalcium phosphate ($\text{CaHPO}_4 \cdot 2\text{H}_2\text{O}$).

PRINCIPLE

3. Extraction of phosphorus at a temperature of 65°C with an alkaline solution of ammonium citrate (Petermann) under specified conditions.

REAGENTS

Petermann's solution

Petermann's solution

4.—(4.1)

Characteristics:

Citric acid monohydrate, 173 g per litre.

(11) Where the fertiliser is normal superphosphate or concentrated superphosphate in Group 2(a) of Section A, or NPK fertiliser in Group 1, NP fertiliser in Group 2, or PK fertiliser in Group 4 of Section B or NPK fertiliser suspension, NP fertiliser suspension or PK fertiliser suspension in Section C of the Table in Schedule 1 to the Fertilisers Regulations (Northern Ireland) 1992

(12) Where the fertiliser is triple superphosphate in Group 2(a) of Section A, or NPK fertiliser containing soft ground rock phosphate or partially solubilised rock phosphate in Group 1, or NP fertiliser containing soft ground rock phosphate or partially solubilised rock phosphate in Group 2, or PK fertiliser containing soft ground rock phosphate or partially solubilised rock phosphate in Group 4 of Section B of the Table in Schedule 1 to the Fertilisers Regulations (Northern Ireland) 1992

(13) If no mechanical shaker is available, the flask may be shaken by hand every 5 minutes

Ammonia, 42 g per litre ammoniacal nitrogen.
pH, between 9.4 and 9.7.

Preparation from diammonium citrate:

Dissolve 941 g diammonium citrate in about 3,500 ml water in a 5 litre graduated flask. Stand the flask in a bath of running water, mix and cool. Add, in small amounts, 430 ml of ammonia solution ($\rho = 0.880$ g/ml), from a freshly opened bottle (or an equivalent amount of diluted ammonia, for example if $\rho = 0.906$ g/ml then 502 ml are required). Adjust the temperature to 20°C, make up to volume with water and mix.

Preparation from citric acid and ammonia:

Dissolve 865 g citric acid monohydrate in about 2,500 ml distilled water in a container of about 5 litres capacity. Place the container in an ice bath and add in small amounts, shaking continually, 966 ml of ammonia solution ($\rho = 0.880$ g/ml), from a freshly opened bottle (or an equivalent amount of diluted ammonia, for example if $\rho = 0.906$ g/ml, then, 1,114 ml are required). Adjust the temperature to 20°C, transfer to a 5 litre graduated flask, make up to the mark with distilled water and mix.

Check the ammoniacal nitrogen content as follows:

Transfer 25 ml of the solution into a 250 ml graduated flask, make up to volume with distilled water and mix. Determine the ammoniacal nitrogen content on 25 ml of this solution using Method 2. If the solution is correct, 15 ml 0.25 M H₂SO₄ are required — Calculate the concentration of ammoniacal nitrogen in the reagent solution (1 ml 0.25 M H₂SO₄ = 0.007 g nitrogen).

If the concentration of ammoniacal nitrogen is greater than 42 g/litre, ammonia can be expelled by a stream of inert gas or by moderate heating to bring back the pH to 9.7. Carry out a second determination.

If the concentration of ammoniacal nitrogen is less than 42 g/litre, calculate the volume of ammonia solution required to achieve this level (1 ml ammonia solution, $\rho = 0.880$ g/ml contains approximately 0.22 g ammoniacal nitrogen). For each ml of ammonia solution required add 0.173 g of citric acid.

Whenever corrections are made to this reagent solution, it is imperative that the final concentration of both the citric acid and ammoniacal nitrogen are as specified.

APPARATUS

- 5.—(5.1) Water bath which can be maintained at a temperature of $65^{\circ} \pm 1^{\circ}\text{C}$.
- (5.2) 500 ml graduated flask with a wide neck (eg Stohmann).

PREPARATION OF SAMPLE

6. See Method 1.

PROCEDURE

Extraction

Extraction

7.—(7.1) Weigh to the nearest 0.001 g, 1 g of the prepared sample and transfer to the 500 ml graduated flask (5.2). Add 200 ml alkaline ammonium citrate solution (4.1). Stopper the flask and shake vigorously by hand to avoid the formation of lumps and to prevent any adherence of the sample to the sides.

Status: This is the original version (as it was originally made). This item of legislation is currently only available in its original format.

Place the flask in the water bath at 65°C and shake every 5 minutes during the first half an hour. After each shaking, raise the stopper to equilibrate the pressure. The level of water in the water bath should be above the level of solution in the flask. Allow the flask to remain in the water bath a further hour at 65°C and shake every ten minutes. Remove the flask, cool to a temperature of about 20°C, make up to volume of 500 ml with water. Mix and filter through a dry fluted filter paper, rejecting the first portion of filtrate.

Determination

(7.2) Determine the phosphorus using Method 10 on an aliquot portion of the clear filtrate.

9f.

EXTRACTION OF PHOSPHORUS BY ALKALINE AMMONIUM CITRATE (PETERMANN'S METHOD) AT AMBIENT TEMPERATURE

SCOPE

1. This method is for the determination of phosphorus soluble in alkaline ammonium citrate.

FIELD OF APPLICATION

2. Applicable only to disintegrated phosphates.

PRINCIPLE

3. Extraction of phosphorus at a temperature of 20°C with an alkaline solution of ammonium citrate (Petermann's solution) under specified conditions.

REAGENT

4. See Method 9e.

APPARATUS

5.—(5.1) 250 ml graduated flask with a wide neck (eg Stohmann).

(5.2) Rotary shaker, 35-40 turns per minute.

PREPARATION OF SAMPLE

6. See Method 1.

PROCEDURE

Extraction

Extraction

7.—(7.1) Weigh to the nearest 0.001 g, 2.5 g of the prepared sample and transfer to a 250 ml graduated flask (5.1). Add a little of Petermann's solution (4) at 20°C, shake very hard in order to stop the formation of lumps and to prevent any of the sample adhering to the side of the flask. Make up to the mark with Petermann's solution and close the flask with a rubber stopper.

Shake for two hours on the rotary shaker (5.2). Filter immediately through a dry fluted filter into a dry container, discarding the first portion of the filtrate.

Determination

(7.2) Determine the phosphorus using Method 10 on an aliquot portion of the clear filtrate.

9g.

EXTRACTION OF PHOSPHORUS BY ALKALINE AMMONIUM CITRATE (JOULIE'S METHOD)

SCOPE

1. This method is for the determination of phosphorus soluble in Joulie's alkaline ammonium citrate.

FIELD OF APPLICATION

2. Applicable to all the straight and compound phosphatic fertilisers, in which the phosphate occurs in an aluminocalcic form.

PRINCIPLE

3. Extraction by shaking vigorously with an alkaline solution of ammonium citrate of defined specification (and where appropriate in the presence of oxine), at about 20°C.

REAGENTS

Joulie's alkaline solution of ammonium citrate:

Joulie's alkaline solution of ammonium citrate:

4.—(4.1) This solution contains 400 g of citric acid monohydrate and 153 g of NH₃ per litre. Its free ammonia content is approximately 55 g per litre. It is prepared by one of the methods described below:

(4.1.1) In a 1 litre graduated flask, dissolve 400 g of citric acid monohydrate in approximately 600 ml ammonia solution ($\rho = 0.925$ g/ml), containing 200 g NH₃ per litre; this may be prepared by diluting 760 ml ammonia solution ($\rho = 0.880$ g/ml) from a freshly opened bottle with water to 1 litre. The citric acid is added successively in quantities of 50 to 80 g maintaining the temperature below 50°C. Make up the volume to 1 litre with ammonia solution ($\rho = 0.925$ g/ml).

(4.1.2) In a litre graduated flask, dissolve 432 g of diammonium citrate in 300 ml of water. Add 440 ml of ammonia solution ($\rho = 0.925$ g/ml) (see 4.1.1 above). Make up the volume to 1 litre with water.

Transfer a 10 ml sample of the citrate solution to a 250 ml flask. Make up the volume with distilled water. Determine the ammoniacal nitrogen content on 25 ml of this solution using Method 2. In these conditions the reagent is considered to be correct when the volume of 0.25 M sulfuric acid required is between 17.7 and 18.0 ml (1 ml 0.25 M H₂SO₄ = 0.008516 g NH₃). If the titre is too low add 4.25 ml of ammonia ($\rho = 0.925$ g/ml) per 0.1 ml below the 18 ml indicated above.

Verification of the total ammonia content:

Transfer a 10 ml sample of the citrate solution to a 250 ml flask. Make up the volume with distilled water. Determine the ammoniacal nitrogen content on 25 ml of this solution using Method 2. In these conditions the reagent is considered to be correct when the volume of 0.25 M sulfuric acid required

Status: This is the original version (as it was originally made). This item of legislation is currently only available in its original format.

is between 17.7 and 18.0 ml (1 ml 0.25 M H₂SO₄ = 0.008516 g NH₃). If the titre is too low add 4.25 ml of ammonia ($\rho = 0.925$ g/ml) per 0.1 ml below the 18 ml indicated above.

(4.2) 8-Hydroxyquinoline (oxine), powdered.

APPARATUS

5.—(5.1) Rotary shaker, 35-40 turns per minute.

(5.2) 500 ml graduated flask with a wide neck (Stohmann).

PREPARATION OF SAMPLE

6. See Method 1.

PROCEDURE

Extraction

Extraction

7.—(7.1) Weigh to the nearest 0.0005 g, 1 g of the prepared sample and place in a small glass or porcelain mortar. Add about 10 drops of ammonium citrate solution (4.1) to moisten it and then break it up very carefully with a pestle. Add 20 ml ammonium citrate solution (4.1), mix to a paste and leave to settle for about 1 minute.

Decant the liquid into a 500 ml graduated flask (5.2). Add 20 ml ammonium citrate solution (4.1) to the residue, grind as above and decant the liquid into the graduated flask. Repeat the process four times, so that by the end of the fifth time all the product can be poured into the flask. The total quantity of ammonium citrate solution used for these processes must be approximately 100 ml.

Rinse the residue from the pestle and mortar into the graduated flask with 40 ml of distilled water.

Stopper the flask and shake for three hours on the rotary shaker (5.1).

Leave the flask standing for fifteen to sixteen hours and then shake it again under the same conditions for three hours. The temperature during the whole process should be kept at $20^{\circ} \pm 2^{\circ}$ C.

Make up to volume with distilled water and mix. Filter through a dry filter, discard the first portion of the filtrate and collect the clear filtrate in a dry flask.

Determination

(7.2) Determine the phosphorus using Method 10 on an aliquot portion of the clear filtrate.

NOTE

8. The use of oxine makes it possible to apply this method to fertilisers containing magnesium. This is recommended when the ratio of magnesium to phosphorus pentoxide is higher than 0.03 (Mg/P₂O₅ > 0.03). If this is the case, add 3 g of oxine to the moistened sample for analysis. The use of oxine in the absence of magnesium is not, moreover, likely to interfere subsequently with the determination. In the known absence of magnesium, oxine may be omitted.

9h.

EXTRACTION OF PHOSPHORUS BY WATER

SCOPE

1. This method is for the determination of water-soluble phosphorus.

FIELD OF APPLICATION

2. Applicable to all fertilisers where water-soluble phosphorus is to be determined.

PRINCIPLE

3. Extraction in water by shaking under specified conditions.

APPARATUS

- 4.—(4.1) 500 ml graduated flask with a wide neck (eg Stohmann).
(4.2) Rotary shaker, 35-40 turns per minute.

PREPARATION OF SAMPLE

5. See Method 1.

PROCEDURE

Extraction

Extraction

6.—(6.1) Weigh to the nearest 0.001 g, 5 g of the prepared sample and place it in a 500 ml graduated flask (4.1). Add 450 ml of water, the temperature of which must be between 20°C and 25°C. Close the flask and shake on the rotary shaker (4.2) for 30 minutes. Then make up to the mark with water, mix thoroughly and filter through a dry fluted paper into a dry container.

Determination

- (6.2) Determine the phosphorus using Method 10, on an aliquot portion of the clear filtrate.

10.

DETERMINATION OF EXTRACTED PHOSPHORUS (Gravimetric method using quinoline phosphomolybdate)

SCOPE

1. This method is for the determination of phosphorus in extracts from fertilisers.

FIELD OF APPLICATION

2. This method is applicable to all extracts of fertilisers(14), for the determination of the different forms of phosphorus.

(14) 21 ml when the solution to be precipitated contains more than 15 ml of citrate solution (neutral citrate, Petermann or Joulie alkaline citrate).

Status: This is the original version (as it was originally made). This item of legislation is currently only available in its original format.

PRINCIPLE

3. After hydrolysis, phosphorus is precipitated in an acidic solution in the form of quinoline phosphomolybdate. The precipitate is collected, washed, dried at 250°C and weighed.

In the above conditions, compounds likely to be found in the solution (mineral and organic acids, ammonium ions, soluble silicates, etc...) will not interfere provided that a reagent based on sodium molybdate or ammonium molybdate is used in the precipitation.

REAGENTS

4.—(4.1) Concentrated nitric acid ($\rho = 1.40$ g/ml).

(4.2) Molybdate reagent:

Preparation of the reagent based on sodium molybdate

(4.2.1) Solution A: dissolve 70 g sodium molybdate dihydrate in 100 ml water.

Solution B: dissolve 60 g citric acid monohydrate in 100 ml water and 85 ml concentrated nitric acid (4.1).

Solution C: stir solution A into solution B to obtain solution C.

Solution D: to 50 ml water add 25 ml concentrated nitric acid (4.1), add 5 ml freshly distilled quinoline. Add this solution to solution C, mix thoroughly and leave standing overnight in the dark. Make up to 500 ml with water, mix again and filter through a sintered glass funnel (5.3).

Preparation of the reagent based on ammonium molybdate

(4.2.2) Solution A: dissolve 100 g ammonium molybdate in 300 ml water, heating gently and stirring from time to time.

Solution B: dissolve 120 g citric acid monohydrate in 200 ml water and add 170 ml of concentrated nitric acid (4.1).

Solution C: add 10 ml freshly distilled quinoline to 70 ml of concentrated nitric acid (4.1).

Solution D: slowly pour, stirring well, solution A into solution B. After thoroughly mixing, add solution C to this mixture and make up to 1 litre with water. Leave standing for two days in a dark place and filter through a sintered glass funnel (5.3).

The reagents 4.2.1 and 4.2.2 can be used in the same way; both must be kept in the dark in stoppered polyethylene bottles.

APPARATUS

5.—(5.1) Filter crucible with porosity of 5 to 20 microns.

(5.2) Drying oven regulated at 250°C \pm 10°C.

(5.3) Sintered glass funnel with porosity of 5 to 20 microns.

PROCEDURE

Treatment of the solution

Treatment of the solution

Status: This is the original version (as it was originally made). This item of legislation is currently only available in its original format.

6.—(6.1) Using a pipette take an aliquot portion of fertiliser extract (see the Table) containing about 0.01 g of P₂O₅ and transfer to a 500 ml Erlenmeyer flask. Add 15 ml concentrated nitric acid(14) (4.1) and dilute with water to about 100 ml.

Hydrolysis

(6.2) Bring the contents of the Erlenmeyer flask to the boil slowly and keep at this temperature until hydrolysis is completed (this usually takes 1 hour). Care must be taken to avoid losses by splashing and excessive evaporation which would reduce the initial volume by more than half, by fitting a reflux condenser. After hydrolysis make up to the initial volume with distilled water.

Weighing the crucible

(6.3) Dry the filter crucible (5.1) for at least 15 minutes in the drying oven (5.2). Cool the crucible in a desiccator and weigh.

Precipitation

(6.4) Heat the acid solution in the Erlenmeyer flask until it begins to boil and then precipitate the quinoline phosphomolybdate by adding 40 ml of the precipitating reagent (4.2.1 or 4.2.2)(15) drop by drop, stirring continuously. Place the Erlenmeyer flask in a steam bath for 15 minutes, shaking from time to time. The solution can be filtered immediately or after it has cooled down.

Filtering and washing

(6.5) Filter the solution under vacuum by decantation. Wash the precipitate in the Erlenmeyer flask with 30 ml water. Decant and filter the solution. Repeat this process five times. Quantitatively transfer the rest of the precipitate into the crucible washing it with water. Wash four times with 20 ml water, allowing the liquid to drain from the crucible before each addition.

Drying and weighing

(6.6) Wipe the outside of the crucible with a filter paper. Place the crucible in the drying oven (5.2) for approximately 15 minutes. Cool in a desiccator and weigh rapidly, repeat this process until a constant mass is attained.

Blank test

(6.7) For each series of determinations, make a blank test under the same conditions (omitting only the sample) and allow for this in the calculation of the final result.

Control test

(6.8) Carry out the determination using an aliquot portion of a potassium dihydrogen phosphate solution containing 0.01 g of P₂O₅.

EXPRESSION OF RESULTS

7. If the samples for analysis and dilutions shown in the Table are used the following formulae apply:

$$\% \text{ P}_2\text{O}_5 \text{ in the fertiliser} = (A - a) \times f$$

$$\% \text{ P in the fertiliser} = (A - a) \times f'$$

(14) 21 ml when the solution to be precipitated contains more than 15 ml of citrate solution (neutral citrate, Petermann or Joulie alkaline citrate).

(15) To precipitate phosphate solutions containing more than 15 ml citrate solution (neutral, Petermann or Joulie) which have been acidified with 21 ml concentrated nitric acid (see footnote to paragraph 6.1) use 80 ml of the precipitating reagent.

Status: This is the original version (as it was originally made). This item of legislation is currently only available in its original format.

where:

A = weight in g of the quinoline phosphomolybdate

a = mass in g of the quinoline phosphomolybdate obtained in the blank test

f and f' = factors given in the last two columns of the Table.

With samples for analysis and dilutions which differ from those of the Table the following formulae apply:

$$\% \text{ P}_2\text{O}_5 \text{ in the fertiliser} = \frac{(A - a) \times f \times D \times 100}{M}$$

$$\% \text{ P in the fertiliser} = \frac{(A - a) \times f' \times D \times 100}{M}$$

where:

f = conversion factor, quinoline phosphomolybdate into P₂O₅ = 0.0321

f' = conversion factor, quinoline phosphomolybdate into P = 0.0140

D = dilution factor

M = mass of the sample analysed.

TABLE FOR METHOD 10

% P ₂ O ₅ in the fertiliser	% P in the fertiliser	Sample for analysis ml	Dilution to ml	Sample ml	Dilution to ml	Sample to be precipitated ml	Quinoline phosphomolybdate conversion factor (f) in percentage P ₂ O ₅	Quinoline phosphomolybdate conversion factor (f') in percentage P	
1-5	0.44-2.2	1	500	—	—	100	16.04	7.00	
		2.5	500	—	—	50	12.83	5.60	
		5	500	—	—	25	12.83	5.60	
		5-10	2.2-4.4						
			1	500	—	—	50	32.07	14.00
			2.5	500	—	—	25	25.66	11.20
			3	500	—	—	25	21.38	9.33
			5	500	—	—	10	32.07	14.00
10-25	4.4-11.0	1	500	—	—	25	64.15	28.00	
		2.5	500	—	—	10	64.15	28.00	
		3	500	—	—	10	53.46	23.33	
		5	500	50	500	50	64.15	28.00	
+ 25	+ 11	1	500	—	—	10	160.40	70.01	
		2.5	500	50	500	50	128.30	55.99	

Status: This is the original version (as it was originally made). This item of legislation is currently only available in its original format.

% P ₂ O ₅ in the fertiliser	% P in the fertiliser	Sample for analysis ml	Dilution to ml	Sample ml	Dilution to ml	Sample to be precipitated ml	Quinoline phosphomolybdate conversion factor (f) in percentage P ₂ O ₅	Quinoline phosphomolybdate conversion factor (f') in percentage P
		3	500	50	500	50	106.90	46.66
		5	500	50	500	25	128.30	55.92

11.

DETERMINATION OF WATER-SOLUBLE POTASSIUM

SCOPE

1. This method is for the determination of water-soluble potassium.

FIELD OF APPLICATION

2. All the potassium fertilisers listed in Group 3(a) of Section A and Groups 1, 3 and 4 of Section B and Group 2 of Section C of the Table in Schedule 1 to the Fertilisers Regulations (Northern Ireland) 1992.

PRINCIPLE

3. The potassium is extracted with water and after the removal of interfering substances, the potassium is precipitated in a slightly alkaline medium in the form of potassium tetraphenylborate (KTPB).

REAGENTS

- 4.—(4.1) Formaldehyde, 25-35% solution, filter if necessary before use.
- (4.2) Potassium chloride.
- (4.3) Sodium hydroxide, 10 M solution. Care should be taken to ensure that the sodium hydroxide is free from potassium.
- (4.4) Indicator solution: dissolve 0.5 g phenolphthalein in 100 ml 90% ethanol.
- (4.5) EDTA solution: 4 g of the dihydrated disodium salt of ethylenediaminetetra-acetic acid (EDTA) per 100 ml. Store this reagent in a plastic container.
- (4.6) STPB solution: dissolve 32.5 g sodium tetraphenylborate in 480 ml of water, add 2 ml sodium hydroxide solution (4.3) and 20 ml of a magnesium chloride solution (100 g of MgCl₂.6H₂O per litre). Stir for fifteen minutes and filter through a fine, ashless filter paper. Store this reagent in a plastic container.
- (4.7) Wash liquid: dilute 20 ml of the STPB solution (4.6) to 1 litre with water.
- (4.8) Bromine water: saturated bromine solution in water.

APPARATUS

- 5.—(5.1) Filter crucibles with a porosity of 5 to 20 microns.
- (5.2) Oven regulated at 120 ± 10°C.

Status: This is the original version (as it was originally made). This item of legislation is currently only available in its original format.

PREPARATION OF SAMPLE

6. See Method 1.

In the case of potassium salts the sample must be ground finely enough to ensure that a representative sample is obtained for analysis. For these products, Method 1, paragraph 6(a) must be used.

PROCEDURE

Extraction

Extraction

7.—(7.1) Weigh to the nearest 0.001 g, 10 g of the prepared sample (5 g for potassium salts containing more than 50% of potassium oxide or 20 g for fertilisers containing less than 5% of potassium oxide) and place in a 600 ml beaker with approximately 400 ml of water. Bring to the boil and maintain heat for 30 minutes. Cool, transfer quantitatively into a 1 litre graduated flask, make up the volume, mix and filter into a dry receiver. Discard the first 50 ml of the filtrate.

Note:

If the filtrate is dark in colour, transfer by pipette, an aliquot portion containing at the most 100 mg of K_2O and place in a 100 ml beaker, add bromine water and bring to the boil to eliminate any surplus bromine. After cooling transfer quantitatively to a 100 ml graduated flask, make up to the volume, filter and determine the potassium in an aliquot portion of the filtrate.

Determination

(7.2) Transfer by pipette an aliquot portion of the filtrate containing 25-50 mg of potassium (see Table on page 70) into a 250 ml beaker; make up to 50 ml with water.

To remove interferences, add 10 ml of the EDTA solution (4.5), several drops of the phenolphthalein solution (4.4) and stir in, drop by drop, sodium hydroxide solution (4.3) until a red colour persists. Finally add a few more drops of sodium hydroxide to ensure an excess (usually 1 ml of sodium hydroxide is sufficient to neutralise the sample and ensure an excess).

Boil gently for 15 minutes to eliminate most of the ammonia. Add water to make the volume up to 60 ml.

Bring the solution to the boil, remove the beaker from the heat and add 10 ml formaldehyde (4.1). Add several drops of phenolphthalein solution (4.4) and, if necessary, more sodium hydroxide solution until a distinct red colour appears. Cover the beaker with a watch glass and place it on a steam bath for fifteen minutes.

Weighing the crucible

(7.3) Dry the filter crucible (5.1) to constant weight in the oven at 120°C (5.2) (about 15 minutes). Allow the crucible to cool in a desiccator and weigh it.

Precipitation

(7.4) Remove the beaker from the steam bath, stir in drop by drop 10 ml of the STPB solution (4.6). This addition should take about 2 minutes; allow to stand for at least 10 minutes before filtering.

(7.5) Filtering and washing

Filter under vacuum into the weighed crucible, rinse the beaker with the wash liquid (4.7), wash the precipitate three times with the wash liquid (60 ml in all of the wash liquid) and twice with 5 to 10 ml of water.

Drying and weighing

(7.6) Wipe the outside of the crucible with a filter paper and place in the oven (5.2) for one and a half hours at a temperature of 120°C. Allow the crucible to cool in a desiccator to ambient temperature and weigh rapidly.

Blank test

(7.7) Carry out a blank test under the same conditions (omitting only the sample) and allow for this in the calculation of the final result.

Control test

(7.8) Carry out the determination on an aliquot portion of an aqueous solution of potassium chloride, containing at the most 40 mg of K₂O.

EXPRESSION OF RESULTS

Method of calculation and formulae

Method of calculation and formulae

8.—(8.1) If the quantities and the dilutions shown in the Table are used, the following formulae apply:

$$\% \text{ K}_2\text{O in the fertiliser} = (A - a) \times f$$

or

$$\% \text{ K in the fertiliser} = (A - a) \times f'$$

where:

A = mass in grams of the precipitate from the sample

a = mass in grams of the precipitate from the blank

f and f' = factors — see Table.

With samples and dilutions which differ from those of the Table use the following formulae:

$$\% \text{ K}_2\text{O} = \frac{(A - a) \times F \times D \times 100}{M}$$

or

$$\% \text{ K} = \frac{(A - a) \times F' \times D \times 100}{M}$$

where:

F = conversion factor, KTPB into K₂O = 0.1314

F' = conversion factor, KTPB into K = 0.109

D = dilution factor

M = mass in grams of the sample for analysis.

Status: This is the original version (as it was originally made). This item of legislation is currently only available in its original format.

TABLE FOR METHOD 11

<i>% of K₂O in the fertiliser</i>	<i>% of K in the fertiliser</i>	<i>Sample for analysis (g)</i>	<i>Aliquot portion to be taken as a sample for precipitation (ml)</i>	<i>Conversion factor f% K₂O g KTPB</i>	<i>Conversion factor f' % K g KTPB</i>
1-5	0.8-4.2	20	50	13.14	10.91
5-10	4.2-8.3	10	50	26.28	21.81
10-20	8.3-16.6	10	25	52.56	43.62
20-50	16.6-41.5	10	10	131.40	109.10
more than 50	more than 41.5	5	10	262.80	218.10

12.

DETERMINATION OF CHLORIDES IN THE ABSENCE OF ORGANIC MATERIAL

SCOPE

1. This method is for the determination of chloride, in the absence of organic material.

FIELD OF APPLICATION

2. All fertilisers which are free from organic material, except ammonium nitrate fertilisers of a nitrogen content greater than 28% by weight.

PRINCIPLE

3. The chlorides, dissolved in water, are precipitated in an acid medium by an excess of standard solution of silver nitrate. The excess is titrated with a solution of ammonium thiocyanate in the presence of ferric ammonium sulfate (Volhard's method).

REAGENTS

- 4.—(4.1) Nitrobenzene or diethyl ether.
- (4.2) Nitric acid, 10 M solution.
- (4.3) Indicator solution: dissolve 40 g of ferric ammonium sulfate $[\text{Fe}_2(\text{SO}_4)_3 \cdot (\text{NH}_4)_2\text{SO}_4 \cdot 24\text{H}_2\text{O}]$ in water and make up to 1 litre.
- (4.4) Silver nitrate, 0.1 M solution.
- (4.5) Ammonium thiocyanate, 0.1 M solution.
Preparation: since this salt is hygroscopic and cannot be dried without risk of decomposition, it is advisable to weigh out approximately 9 g, dissolve in water and make up the volume to one litre. Standardise by titration against 0.1 M silver nitrate solution.
- (4.6) Potassium chloride solution: Dissolve 2.103 g of potassium chloride, previously dried at 130°C, for one hour, in water and make up to 500 ml.

APPARATUS

5.—(5.1) Rotary shaker, 35-40 turns per minute.

PREPARATION OF SAMPLE

6. See Method 1.

PROCEDURE

Extraction

Extraction

7.—(7.1) Weigh to the nearest 0.001 g, 5 g of the prepared sample and place in a 500 ml graduated flask and add 450 ml water. Shake for half an hour on the rotary shaker (5.1); make up to 500 ml with distilled water, mix and filter into a beaker, discarding the first part of the filtrate.

Determination

(7.2) Take an aliquot portion of the filtrate containing not more than 0.150 g of chloride. If the portion taken is smaller than 50 ml it is necessary to make up the volume to 50 ml with distilled water. Add 5 ml 10 M nitric acid (4.2), 20 ml indicator solution (4.3), and two drops of ammonium thiocyanate standard solution (taken from a burette adjusted to zero). From a burette then add silver nitrate solution (4.4) until there is an excess of 2 to 5 ml. Add 5 ml nitrobenzene or 5 ml diethyl ether (4.1) and shake well to agglomerate the precipitate. Titrate the excess silver nitrate with 0.1 M ammonium thiocyanate (4.5) until a red-brown colour just appears which remains after the flask has been shaken slightly.

Note:

Nitrobenzene or diethyl ether (especially the former) prevents the silver chloride from reacting with thiocyanate ions, thus a clear colour change is obtained.

Blank test

(7.3) Carry out a blank test under the same conditions (omitting only the sample) and allow for this in the calculation of the final result.

Control test

(7.4) Carry out the determination using 50 ml (equivalent to 0.100 g of chloride) of the potassium chloride solution (4.6).

EXPRESSION OF RESULT

8. Express the result of the analysis as a percentage of chloride contained in the sample as it has been received for analysis.

Calculation: calculate the percentage of chloride (Cl) with the formula:

$$\% \text{ Cl} = 0.003546 \times \frac{(V_z - V_{cz}) - (V_{..} - V_{..m}) \times 100}{M}$$

where:

V_z = number of millilitres of silver nitrate added

V_{cz} = number of millilitres of silver nitrate used in the blank test

Status: This is the original version (as it was originally made). This item of legislation is currently only available in its original format.

V_a = number of millilitres of ammonium thiocyanate used for the titration of the sample

V_{ca} = number of millilitres of ammonium thiocyanate used for the titration of the blank

M = mass in grams of the sample in aliquot volume taken for titration

13a.

DETERMINATION OF FINENESS OF GRINDING — DRY METHOD

SCOPE

1. This method is for the determination of the fineness of grinding by the dry method.

FIELD OF APPLICATION

2. All fertilisers in Schedule 1 to the Fertilisers Regulations (Northern Ireland) 1992(16) for which requirements are given of fineness of grinding using 0.630 mm and 0.160 mm sieves.

PRINCIPLE

3. By mechanical sieve shaking, the quantities of product with a granule size greater than 0.63 mm and those with a granule size between 0.16 mm and 0.63 mm are determined and the percentage of fineness of grinding is calculated.

APPARATUS

- 4.—(4.1) Mechanical sieve shaker.
- (4.2) Sieves with apertures of 0.160 mm and 0.630 mm respectively of standard ranges (diameter 20 cm, height 5 cm).

PROCEDURE

5. Weigh to the nearest 0.05 g, 50 g of the sample. Assemble the two sieves and the collecting container on the shaker (4.1), the sieve with the larger apertures being placed on top. Place the sample for analysis on the top. Sieve for ten minutes and remove the part collected on the bottom. Sieve again for one minute and check that the amount collected on the bottom during this time is not more than 250 mg. Repeat the process (for one minute each time) until the amount collected is less than 250 mg. Weigh the residual material on both sieves separately.

EXPRESSION OF RESULTS

$$\text{Percentage of material passing sieve of 0.630 mm apertures} = (50 - M_1) \times 2$$

$$\text{Percentage of material passing sieve of 0.160 mm apertures} = [50 - (M_1 + M_2)] \times 2$$

where:

M_1 = mass in g of residue on the sieve with 0.630 mm apertures

M_2 = mass in g of residue on the sieve with 0.160 mm apertures

The results are to be rounded up to the nearest unit.

13b.

DETERMINATION OF THE FINENESS OF GRINDING OF SOFT NATURAL PHOSPHATES

SCOPE

1. This method is for determining the fineness of grinding of soft natural phosphates.

FIELD OF APPLICATION

2. Soft natural phosphates.

PRINCIPLE

3. For samples of fine particle size, agglomeration may occur thus making dry sieving difficult. For this reason, wet sieving is normally used.

REAGENTS

4. Sodium hexametaphosphate solution, 1 g per 100 ml.

APPARATUS

5.—(5.1) Sieves with apertures of 0.063 mm and 0.125 mm respectively of standard ranges (diameter 20 cm, height 5 cm) and collecting containers.

(5.2) Glass funnel of 20 cm diameter mounted on a stand.

(5.3) Laboratory oven.

PROCEDURE

6. Wash both sides of the sieves with water and place the sieve with 0.125 mm apertures above the 0.063 mm sieve.

Weigh to the nearest 0.05 g, 50 g of the prepared sample and place on the top sieve. Sieve under a small jet of cold water (tap water can be used) until the water is practically clear when it passes through. Care should be taken to ensure that the flow of water is such that the lower sieve never fills with water. When the residue on the top sieve seems to remain more or less constant, remove this sieve, and place on a collecting container (5.1) for the time being.

Continue the wet sieving through the lower sieve for a few minutes, until the water passing through is nearly clear. Replace the 0.125 mm sieve over the 0.063 mm sieve. Transfer any deposit from the collecting container to the top sieve and begin sieving again under a small jet of water until this water becomes almost clear once more.

Transfer each of the residues quantitatively into a separate 250 ml beaker by means of the funnel. Suspend each residue by filling the beakers with water. Allow to stand for about 1 minute and then decant as much water as possible. Place the beakers in the oven (5.3) at 150°C for two hours. Allow them to cool to room temperature in a desiccator, detach the residues with a brush and weigh them.

EXPRESSION OF RESULTS

Percentage of material passing sieve of 0.125 mm apertures = $(50 - M_1) \times 2$

Percentage of material passing sieve of 0.063 mm apertures = $[50 - (M_1 + M_2)] \times 2$

Status: This is the original version (as it was originally made). This item of legislation is currently only available in its original format.

where:

M_1 = mass in g of the residue on the 0.125 mm sieve.

M_2 = mass in g of the residue on the 0.063 mm sieve.

The results are to be rounded up to the nearest unit.

REMARK

8. If the presence of lumps is observed after sieving, the analysis should be carried out again in the following way:

Slowly pour 50 g of the sample into a 1 litre flask containing 500 ml of the sodium hexametaphosphate solution, stirring continuously. Stopper the flask and shake vigorously by hand to break up the lumps. Transfer the whole suspension into the top sieve and wash the flask thoroughly. Continue the analysis as described under paragraph 6.

14.

METHODS OF ANALYSIS AND TEST PROCEDURES FOR AMMONIUM NITRATE FERTILISERS CONTAINING MORE THAN 28% NITROGEN BY WEIGHT

14a.

METHOD FOR THE APPLICATION OF THERMAL CYCLES

SCOPE

1. This method defines the procedure for the application of thermal cycles before carrying out the oil retention test on straight ammonium nitrate fertilisers containing more than 28% nitrogen by weight.

FIELD OF APPLICATION

2. This procedure is for thermal cycling prior to determining the oil retention value of the fertiliser.

PRINCIPLE AND DEFINITION

3. Heat the sample in an Erlenmeyer flask by immersing the flask in a water bath at 50°C and maintain at this temperature for two hours (phase at 50°C). Then cool the flask in water bath at 20°C and maintain at this temperature for two hours (phase at 25°C). The combination of the two phases, first at 50°C then at 25°C, forms one thermal cycle.

APPARATUS

4. Normal laboratory apparatus, in particular:

(4.1) Water baths thermostated at 25 (± 1) and 50 (± 1)°C respectively.

(4.2) Erlenmeyer flasks with an individual capacity of 150 ml.

PROCEDURE

5. Place each test sample of 70 (± 5) grams into an Erlenmeyer flask which is then closed with a stopper. Place the flask in the 50°C water bath for 2 hours, then transfer to the 25°C bath for a further 2 hours. Transfer the flask back into 50°C water bath for a further 2 hours and then return to the 25°C bath. Maintain the water in each bath at constant temperature, stir fairly rapidly and ensure that

the water level is above the level of the sample in the flask. Protect the stopper from condensation by a rubber cap or aluminium foil.

After two thermal cycles, keep the sample at $20 \pm 3^\circ\text{C}$ for the determination of the oil retention value.

14b.

DETERMINATION OF THE OIL RETENTION VALUE

SCOPE AND FIELD OF APPLICATION

1. This method defines the procedure for the determination of the oil retention value of straight ammonium nitrate fertilisers containing more than 28% nitrogen by weight.

The method is applicable to both prilled and granular fertilisers which do not contain oil-soluble materials.

DEFINITION

2. Oil retention value of a fertiliser: the quantity of oil retained by the fertiliser determined under the operating conditions specified and expressed as a percentage by mass.

PRINCIPLE

3. Total immersion of the test portion in gas oil for a specified period, followed by the draining away of surplus oil under specified conditions. Measurement of the increase in mass of the test portion.

REAGENT

4. Gas oil

Viscosity max: 5 mPas at 40°C

Density: 0.8 to 0.85 g/ml at 20°C

Sulfur content: $\leq 1.0\%$ (m/m)

Ash: $\leq 0.1\%$ (m/m)

APPARATUS

5.—(5.1) Balance, capable of weighing to the nearest 0.01 gram.

(5.2) Beakers, of capacity 500 ml.

(5.3) Funnel, plastic, preferably with a cylindrical wall at the upper end, diameter approximately 200 mm.

(5.4) Test sieve, aperture 0.5 mm, fitting into the funnel (5.3).

Note:

The size of the funnel and sieve is such as to ensure that only a few granules lie one above another and the oil is able to drain away.

(5.5) Filter paper, rapid filtering grade, creped, soft, weight 150 g/m^2 .

(5.6) Absorbent tissue (laboratory grade).

Status: This is the original version (as it was originally made). This item of legislation is currently only available in its original format.

PROCEDURE

6.—(6.1) Carry out two individual determinations in quick succession on separate portions of the same test sample.

(6.2) Remove particles smaller than 0.5 mm using the test sieve (5.4). Weigh to the nearest 0.01 gram approximately 50 grams of the sample into the beaker (5.2). Add sufficient gas oil (Section 4) to cover the prills completely and stir carefully to ensure that the surfaces of all the prills are fully wetted. Cover the beaker with a watch glass and leave to stand for one hour at 25 (± 2)°C.

(6.3) Filter the entire contents of the beaker through the funnel (5.3) containing the test sieve (5.4). Allow the portion retained by the sieve to remain there for one hour so that most of the excess oil can drain away.

(6.4) Lay two sheets of filter paper (5.5) (about 500 × 500 mm) on top of each other on a smooth surface; fold the four edges of both filter papers upwards to a width of about 40 mm to prevent the prills from rolling away. Place two layers of absorbent tissue (5.6) in the centre of the filter papers. Pour the entire contents of the sieve (5.4) over the absorbent tissues and spread the prills evenly with a soft, flat brush. After two minutes lift one side of the tissues to transfer the prills to the filter papers beneath and spread them evenly over these with the brush. Lay another sheet of filter paper, similarly with its edges turned upward, on the sample and roll the prills between the filter papers with circular movements while exerting a little pressure. Pause after every eight circular movements to lift the opposite edges of the filter papers and return to the centre the prills that have rolled to the periphery. Keep to the following procedure: make four complete circular movements, first clockwise and then anticlockwise. Then roll the prills back to the centre as described above. This procedure to be carried out three times (24 circular movements, edges lifted twice). Carefully insert a new sheet of filter paper between the bottom sheet and the one above it and allow the prills to roll onto the new sheet by lifting the edges of the upper sheet. Cover the prills with a new sheet of filter paper and repeat the same procedure as described above. Immediately after rolling, pour the prills into a tared dish and reweigh to the nearest 0.01 gram to determine the mass of the gas oil retained.

Repeating the rolling procedure and reweighing

(6.5) If the mass of gas oil retained in the portion is found to be greater than 2.00 grams, place the portion on a fresh set of filter papers and repeat the rolling procedure, lifting the corners in accordance with Section 6.3 (two times eight circular movements, lifting once). Then reweigh the portion.

EXPRESSION OF RESULTS

Method of calculation and formula

Method of calculation and formula

7.—(7.1) The oil retention, from each determination (6.1) expressed as a percentage by mass of the sieved test portion, is given by the equation:

$$\text{Oil retention} = \frac{m_2 - m_1}{m_1} \times 100$$

where:

m_1 is the mass, in grams, of the sieved test portion (6.2);

m_2 is the mass, in grams, of the test portion according to Section 6.4 or 6.5 respectively as the result of the last weighing.

Take as the result the arithmetic mean of the two individual determinations.

14c.

DETERMINATION OF COMBUSTIBLE INGREDIENTS

SCOPE AND FIELD OF APPLICATION

1. This method defines the procedure for the determination of the combustible content of straight ammonium nitrate fertilisers containing more than 28% nitrogen by weight.

PRINCIPLE

2. The carbon dioxide produced by inorganic fillers is removed in advance with an acid. The organic compounds are oxidised by means of a chromic acid/sulfuric acid mixture. Carbon dioxide formed is absorbed in a barium hydroxide solution. The precipitate is dissolved in a solution of hydrochloric acid and measured by back-titration with sodium hydroxide solution.

REAGENTS

3.—(3.1) Analytical-grade chromium VI oxide; $\text{Cr}^{\text{VI}}\text{O}_3$

(3.2) Sulfuric acid diluted to 60% by volume: pour 360 ml of water into a one litre beaker and carefully add 640 ml of sulfuric acid, density at 20°C $\rho = 1.83 \text{ g/ml}$.

(3.3) Silver nitrate: 0.1 M solution.

(3.4) Barium hydroxide: weigh out 15 grams of barium hydroxide ($\text{Ba}(\text{OH})_2 \cdot 8\text{H}_2\text{O}$), and dissolve completely in hot water. Allow to cool and transfer to a one-litre flask. Fill up to the mark and mix. Filter through a pleated filter paper.

(3.5) Hydrochloric acid: 0.1 M standard solution.

(3.6) Sodium hydroxide: 0.1 M standard solution.

(3.7) Bromophenol blue: solution of 0.4 grams per litre in water.

(3.8) Phenolphthalein: solution of 2 grams per litre in 60% by volume ethanol.

(3.9) Soda lime: particle dimensions, about 1.0 to 1.6 mm.

(3.10) Demineralised water, freshly boiled to remove carbon dioxide.

APPARATUS

4. Standard laboratory equipment, in particular:

(4.1) Filter crucible with a plate of sintered glass and a capacity of 15 ml, plate diameter: 20 mm, total height: 50 mm, porosity 4 (pore diameter from 5 to 15 μm);

(4.2) Compressed nitrogen supply.

(4.3) Apparatus made up of the following parts and assembled, if possible, by means of spherical ground joints (see Figure 9).

(4.3.1) Absorption tube (A) about 200 mm long and 30 mm in diameter filled with soda lime (3.9) kept in place by fibreglass plugs.

(4.3.2) 500 ml reaction flask (B) with side arm and a round bottom.

(4.3.3) Vigreux fractioning column about 150 mm long (C').

(4.3.4) Double-surface condenser (C), 200 mm long.

(4.3.5) Drechsel bottle (D) acting as a trap for any excess acid which may distil over.

(4.3.6) Ice bath (E) to cool the Drechsel bottle.

Status: This is the original version (as it was originally made). This item of legislation is currently only available in its original format.

- (4.3.7) Two absorption vessels (F_1) and (F_2), 32 to 35 mm in diameter, the gas distributor of which comprises a 10 mm disc of low-porosity sintered glass.
- (4.3.8) Suction pump and suction regulating device (G) comprising a T-shaped glass piece inserted into the circuit, the free arm of which is connected to a fine capillary tube by a short rubber tube fitted with a screw clamp.

Caution

The use of boiling chromic acid solution in an apparatus under reduced pressure is a hazardous operation and requires appropriate precautions.

PROCEDURE

Sample for analysis

Sample for analysis

- 5.—(5.1) Weigh approximately 10 grams of ammonium nitrate to the nearest 0.001 gram.

Removal of carbonates

(5.2) Place the sample for analysis in the reaction flask (B). Add 100 ml of sulfuric acid (3.2). The prills dissolve in about 10 minutes at ambient temperature. Assemble the apparatus as indicated in the diagram: connect one end of the absorption tube (A) to the nitrogen source (4.2) via a non-return flow device containing 5 to 6 mm of mercury and the other end to the feed tube which enters the reaction flask. Place the Vigreux fractioning column (C') and the condenser (C) with cooling water supply in position. Adjust the nitrogen to provide a moderate flow through the solution, bring the solution to boiling point and heat for two minutes. At the end of this time there should be no more effervescence. If effervescence is seen, continue heating for 30 minutes. Allow the solution to cool for at least 20 minutes with the nitrogen flowing through it.

Complete assembly of the apparatus as indicated in the diagram by connecting the condenser tube to the Drechsel bottle (D) and the bottle to the absorption vessel F_1 and F_2 . The nitrogen must continue to pass through the solution during the assembly operation. Rapidly introduce 50 ml of barium hydroxide solution (3.4) into each of the absorption vessels (F_1 and F_2).

Bubble a stream of nitrogen through for about 10 minutes. The solution in the absorbers must remain clear. If this does not happen, the carbonate removal process must be repeated with a fresh barium hydroxide solution.

Oxidation and absorption

(5.3) After withdrawing the nitrogen feed tube, rapidly introduce 20 grams of chromium trioxide (3.1) and 6 ml of silver nitrate solution (3.3) via the side arm of the reaction flask (B). Connect the apparatus to the suction pump and adjust the nitrogen flow so that a steady stream of gas bubbles passes through the sintered-glass absorbers (F_1) and (F_2).

Heat the reaction flask (B) until the liquid boils and keep it boiling for 90 minutes⁽¹⁷⁾. It may be necessary to adjust the suction-regulating valve (G) to control the nitrogen flow since it is possible that the barium carbonate precipitated during the test may block the sintered glass discs. The operation is satisfactory when the barium hydroxide solution in the absorber (F_2) remains clear. Otherwise repeat the test. Stop heating and dismantle the apparatus. Wash each of the distributors both inside and outside to remove barium hydroxide and collect the washings in the corresponding absorber. Place the distributors one after the other in a 600 ml beaker which will subsequently be used for the determination.

(17) A reaction time of 90 minutes is sufficient in the case of most of the organic substances in the presence of silver nitrate catalyst.

Status: This is the original version (as it was originally made). This item of legislation is currently only available in its original format.

Rapidly filter under vacuum firstly the contents of absorber F₂ and then absorber F₁ using the sintered glass crucible. Collect the precipitate by rinsing the absorbers with water (3.10) and wash the crucible with 50 ml of the same water. Place the crucible in the 600 ml beaker and add about 100 ml of boiled water (3.10). Introduce 50 ml of boiled water into each of the absorbers and pass nitrogen through the distributors for five minutes. Combine the water with that from the beaker. Repeat the operation once to ensure that the distributors are rinsed thoroughly.

Measurement of the carbonates originating from organic material

(5.4) Add five drops of phenolphthalein (3.8) to the contents of the beaker. The solution becomes red in colour. Add hydrochloric acid (3.5) drop by drop until the pink colour just disappears. Stir the solution well in the crucible to check the pink colour does not reappear. Add five drops of bromophenol blue and titrate with hydrochloric acid until the solution turns yellow. Add a further 10 ml of hydrochloric acid.

Heat the solution to boiling point and continue boiling for a maximum of one minute. Check carefully that no precipitate remains in the liquid.

Allow to cool and titrate with the sodium hydroxide solution (3.6).

BLANK TEST

6. Carry out a blank test following the same procedure, omitting the sample, and using the same quantities of all reagents.

EXPRESSION OF RESULTS

7. The content of combustible ingredients (C), expressed as carbon, as a percentage by mass of the sample, is given by the formula:

$$C\% = 0.06 \times \frac{V_1 - V_2}{E}$$

where:

E = the mass in grams of the test portion:

V₁ = the total volume in ml of 0.1 M hydrochloric acid added after the change in colour of the phenolphthalein;

V₂ = the volume in ml of the 0.1 M sodium hydroxide solution used in the titration.

14d.

DETERMINATION OF THE pH VALUE

SCOPE AND FIELD OF APPLICATION

1. This method defines the procedure for measuring the pH value of a solution of a straight ammonium nitrate fertiliser containing more than 28% nitrogen by weight.

PRINCIPLE

2. Measurement of the pH of an ammonium nitrate solution by means of a pH meter.

REAGENTS

3. Distilled or demineralised water, free from carbon dioxide.

Status: This is the original version (as it was originally made). This item of legislation is currently only available in its original format.

Buffer solution, pH 6.88 at 20°C

(3.1) Dissolve 3.40 ± 0.01 grams of potassium dihydrogen orthophosphate (KH_2PO_4) in approximately 400 ml of water. Then dissolve 3.55 ± 0.01 gram of disodium hydrogen orthophosphate (Na_2HPO_4) in approximately 400 ml of water. Transfer the two solutions without loss into a 1 litre graduated flask, make up to the mark and mix. Keep the solution in an airtight vessel.

Buffer solution, pH 4.00 at 20°C

(3.2) Dissolve 10.21 ± 0.01 grams of potassium hydrogen phthalate ($\text{KHC}_8\text{O}_4\text{H}_4$) in water, transfer without loss into a 1 litre standard flask, make up to the mark and mix.

Keep this solution in an airtight vessel.

(3.3) Commercially available pH standard solutions may be used.

APPARATUS

4. pH meter, equipped with glass and calomel electrodes or equivalent, sensitivity of 0.05 pH unit.

PROCEDURE

Calibration of the pH meter

Calibration of the pH meter

5.—(5.1) Calibrate the pH meter (4) at a temperature of $20 (\pm 1)^\circ\text{C}$, using the buffer solutions (3.1), (3.2) or (3.3). Pass a slow stream of nitrogen onto the surface of the solution and maintain this throughout the test.

Determination

(5.2) Pour 100.0 ml of water onto $10 (\pm 0.01)$ grams of the sample in a 250 ml beaker. Remove the insolubles by filtering, decanting or centrifuging the liquid.

Measure the pH value of the clear solution at a temperature of $20 (\pm 1)^\circ\text{C}$, according to the same procedure as for the calibration of the meter.

EXPRESSION OF RESULTS

6. Express the result in pH units, to the nearest 0.1 unit and state the temperature used.

14e.

DETERMINATION OF THE PARTICLE SIZE

SCOPE AND FIELD OF APPLICATION

1. This method defines the procedure for the test sieving of straight ammonium nitrate fertilisers containing more than 28% nitrogen by weight.

PRINCIPLE

2. The test sample is sieved on a nest of three sieves, either by hand or by mechanical means. The mass retained on each sieve is recorded and the percentage of material passing the required sieves is calculated.

APPARATUS

3.—(3.1) 200mm diameter woven-wire test sieves to BS 410 (1986) with apertures of 2.0 mm, 1.0 mm and 0.5 mm respectively of standard ranges. One lid and one receiver for these sieves.

(3.2) Balance to weigh to 0.1 gram.

(3.3) Mechanical sieve shaker (if available) capable of imparting both vertical and horizontal motion to the test sample.

PROCEDURE

4.—(4.1) The sample is divided representatively into portions of approximately 100 grams.

(4.2) Weigh one of these portions to the nearest 0.1 gram.

(4.3) Arrange the nest of sieves in ascending order (receiver, 0.5 mm, 1 mm, 2 mm) and place the weighed test portion on the top sieve. Fit the lid to the top of the nest of sieves.

(4.4) Shake by hand or machine, imparting both a vertical and horizontal motion and, if by hand, tapping occasionally. Continue this process for 10 minutes or until the quantity passing through each sieve in one minute is less than 0.1 gram.

(4.5) Remove the sieves from the nest in turn and collect the material retained, brush gently from the reverse side with a soft brush, if necessary.

(4.6) Weigh the material retained on each sieve and that collected in the receiver, to the nearest 0.1 gram.

EVALUATION OF RESULTS

5.—(5.1) Convert the fraction masses to a percentage of the total of the fraction masses (not of the original charge).

Calculate the percentage in the receiver (ie < 0.5 mm): A%

Calculate the percentage retained on the 0.5 mm sieve: B%

Calculate the percentage passing 1.0 mm, ie (A + B)%.

The sum of the fraction masses should be within 2% of the initial mass taken.

(5.2) At least two separate analyses should be carried out and the individual results for A should not differ by more than 1.0% absolute and for B by more than 1.5% absolute. Repeat the test if this is not the case.

EXPRESSION OF RESULTS

6. Report the mean of the two values for A on the one hand and for A + B on the other hand.

14f.

DETERMINATION OF THE CHLORINE CONTENT (AS CHLORIDE ION)

SCOPE AND FIELD OF APPLICATION

1. This method defines the procedure for the determination of the chlorine content (as chloride ion) of straight ammonium nitrate fertilisers containing more than 28% nitrogen by weight.

PRINCIPLE

2. Chloride ions dissolved in water are determined by potentiometric titration with silver nitrate in an acidic medium.

Status: This is the original version (as it was originally made). This item of legislation is currently only available in its original format.

REAGENTS

3. Distilled or demineralised water, free from chloride ions.

(3.1) Acetone AR.

(3.2) Concentrated nitric acid (density at 20°C $\rho = 1.40$ g/ml).

(3.3) Silver nitrate 0.1 M standard solution. Store this solution in a brown glass bottle.

(3.4) Silver nitrate 0.004 M standard solution — prepare this solution at the time of use.

(3.5) Potassium chloride 0.1 M standard reference solution. Weigh, to the nearest 0.1 mg, 3.7276 grams of analytical-grade potassium chloride, previously dried for one hour in an oven at 130°C and cooled in a desiccator to ambient temperature. Dissolve in a little water, transfer the solution without loss into a 500 ml standard flask, dilute to the mark and mix.

(3.6) Potassium chloride 0.004 M standard reference solution — prepare this solution at the time of use.

APPARATUS

4.—(4.1) Potentiometer with silver indicating electrode and calomel reference electrode, sensitivity 2 mV, covering the range -500 to $+500$ mV, or with silver and mercury (1) sulfate electrodes.

(4.2) Bridge, containing a saturated potassium nitrate solution, connected to the calomel electrode (4.1), fitted at the ends with porous plugs. This bridge is not necessary if silver and mercury (1) sulfate electrodes are used.

(4.3) Magnetic stirrer, with a Teflon-coated rod.

(4.4) Microburette with fine-pointed tip, graduated in 0.01 ml divisions.

PROCEDURE

Standardisation of the silver nitrate solution

Standardisation of the silver nitrate solution

5.—(5.1) Take 5.00 ml and 10.00 ml of the standard reference potassium chloride solution (3.6) and place in two low-form beakers of convenient capacity (for example 250 ml). Carry out the following titration of the contents of each beaker.

Add 5 ml of the nitric acid solution (3.2), 120 ml of acetone (3.1) and sufficient water to bring the total volume to about 150 ml. Place the rod of the magnetic stirrer (4.3) in the beaker and set the stirrer in motion. Immerse the silver electrode (4.1) and the free end of the bridge (4.2) in the solution. Connect the electrodes to the potentiometer (4.1) and, after verifying the zero of the apparatus, note the value of the starting potential.

Titrate, using the microburette (4.4), adding initially 4 or 9 ml respectively of the silver nitrate solution corresponding to the standard reference potassium chloride solution used. Continue the addition in 0.1 ml portions for the 0.004 M solutions and in 0.05 ml portions for the 0.1 M solutions. After each addition, await the stabilisation of the potential.

Record the volumes added and the corresponding value of the potential in the first two columns of a table.

In a third column of the table, record the successive increments (Δ_1E) of the potential E . In a fourth column, record the differences (Δ_2E) positive or negative, between the potential increments (Δ_1E). The end of the titration corresponds to the addition of the 0.1 or 0.05 ml portion (V_1) of the silver nitrate solution which gives the maximum value of Δ_1E .

In order to calculate the exact volume (V_{eq}) of the silver nitrate solution corresponding to the end of the reaction, use the formula:

$$V_{eq} = V_0 + \left(V_1 \times \frac{b}{B} \right)$$

where:

V_0 is the total volume, in ml, of the silver nitrate solution immediately lower than the volume which gives the maximum increment of Δ_1E ;

V_1 is the volume, in ml, of the last portion of the silver nitrate solution added (0.1 or 0.05 ml);

b is the last positive value of Δ_2E ;

B is the sum of the absolute values of the last positive values of Δ_2E and the first negative value of Δ_2E (see example in Table 1).

Blank test

(5.2) Calculate the blank value using the equation below and take account thereof when calculating the final result.

The result V_4 of the blank test on the reagents is given, in ml, by the formula:

$$V_4 = 2V_3 - V_2$$

where:

V_2 is the value, in ml, of the exact volume (V_{eq}) of the silver nitrate solution corresponding to the titration of 10 ml of the potassium chloride standard reference solution used;

V_3 is the value, in ml, of the exact volume (V_{eq}) of the silver nitrate solution corresponding to the titration of 5 ml of the potassium chloride standard reference solution used.

Check test

(5.3) The blank test can at the same time serve as a check that the apparatus is functioning satisfactorily and that the test procedure is being implemented correctly.

Determination

(5.4) Take a portion of sample in the range of 10 to 20 grams and weigh to the nearest 0.01 gram. Transfer quantitatively to a 250 ml beaker. Add 20 ml of water, 5 ml of nitric acid solution (3.2), 120 ml of acetone (3.1) and sufficient water to bring the total volume to about 150 ml.

Place the rod of the magnetic stirrer (4.3) in the beaker, place the beaker on the stirrer and set the stirrer in motion. Immerse the silver electrode (4.1) and the free end of the bridge (4.2) in the solution, connect the electrodes to the potentiometer (4.1) and, after having verified the zero of the apparatus, note the value of the starting potential.

Titrate with the silver nitrate solution, by additions from the microburette (4.4) in increments of 0.1 ml. After each addition, await the stabilisation of the potential.

Continue the titration as specified in 5.1, starting from the fourth paragraph: 'Record the volumes added and the corresponding values of the potential in the first two columns of a table ...'

Status: This is the original version (as it was originally made). This item of legislation is currently only available in its original format.

EXPRESSION OF RESULTS

6. Express the result of the analysis as the percentage of chlorine contained in the sample as received for analysis.

Calculate the percentage of chlorine (Cl) content from the formula:

$$Cl\% = \frac{0.03545 \times T \times (V_5 - V_4) \times 100}{m}$$

where:

- T is the molarity of silver nitrate solution used;
- V₄ is the result, in ml, of the blank test (5.2);
- V₅ is the value, in ml, of V_{eq} corresponding to the determination (5.4);
- m is the mass, in grams, of the test portion.

TABLE 1

Example

Volume of the silver nitrate solution V ml	Potential E mv	Δ ₁ E	Δ ₂ E
4.80	176		
		35	
4.90	211		+37
		72	
5.00	283		-49
		23	
5.10	306		-10
		13	
5.20	319		

$$V_{eq} = 4.9 + 0.1 \times \frac{37}{37 + 49} = 4.943$$

14g.

DETERMINATION OF COPPER

SCOPE AND FIELD OF APPLICATION

1. This method defines the procedure for the determination of the copper content of straight ammonium nitrate fertilisers containing more than 28% nitrogen by weight.

PRINCIPLE

2. The sample is dissolved in dilute hydrochloric acid and the copper content is determined by atomic absorption spectrometry.

REAGENTS

3.—(3.1) Hydrochloric acid (density at 20°C $\rho = 1.18$ g/ml).

(3.2) Hydrochloric acid, 6 M solution.

(3.3) Hydrochloric acid, 0.5 M solution.

(3.4) Ammonium nitrate.

(3.5) Hydrogen peroxide, 30%.

(3.6) Copper solution(18) (stock): weigh, to the nearest 0.001 gram, 1 gram of pure copper, dissolve in 25 ml of 6 M hydrochloric acid solution (3.2), add 5 ml of hydrogen peroxide (3.5) in portions and dilute to 1 litre with water. 1 ml of this solution contains 1,000 μg of copper (Cu).

(3.6.1) Copper solution (dilute): dilute 10 ml of stock solution (3.6) to 100 ml with water and then dilute 10 ml of the resulting solution to 100 ml with water. 1 ml of the final dilution contains 10 μg of copper (Cu).

Prepare this solution at the time of use.

APPARATUS

4. Atomic absorption spectrometer with a copper lamp (324.8 nm).

PROCEDURE

Preparation of the solution for analysis

Preparation of the solution for analysis

5.—(5.1) Weigh 25 grams, to the nearest 0.001 gram, of the sample into a 400 ml beaker, add carefully 20 ml of hydrochloric acid (3.1) (there may be a vigorous reaction due to carbon dioxide formation). Add more hydrochloric acid, if necessary. When effervescence has stopped, evaporate to dryness on a steam bath, stirring occasionally with a glass rod. Add 15 ml 6 M hydrochloric acid solution (3.2) and 120 ml of water. Stir with the glass rod, which should be left in the beaker, and cover the beaker with a watch glass. Boil the solution gently until dissolution is complete and then cool.

Transfer the solution quantitatively into a 250 ml graduated flask, by washing the beaker with 5 ml 6 M hydrochloric acid (3.2), and twice with 5 ml of boiling water, cool and make up to the mark with 0.5 M hydrochloric acid (3.3) and mix carefully.

Filter through a copper-free filter paper(19), discarding the first 50 ml.

Blank solution

(5.2) Prepare a blank solution from which only the sample has been omitted and allow for this in the calculation of the final result.

Determination

(18) Commercially available standard copper solution may be used.

(19) Whatman 541 or equivalent

Status: This is the original version (as it was originally made). This item of legislation is currently only available in its original format.

Preparation of sample and blank test solutions

- (5.3.1) Dilute the sample solution (5.1) and the blank test solution (5.2) with 0.5 M hydrochloric acid solution (3.3) to a concentration of copper within the optimal measuring range of the spectrometer. Normally no dilution is needed.

Preparation of the calibration solutions

- (5.3.2) By diluting the standard solution (3.6.1) with 0.5 M hydrochloric acid solution (3.3), prepare at least five standard solutions corresponding to the optimal measuring range of the spectrometer (0 to 5.0 µg/l Cu). Before making up to the mark, add ammonium nitrate (3.4) to every solution to give a final concentration of 100 mg per ml.

Measurement

(5.4) Set up the spectrometer (4) at a wavelength of 324.8 nm and use an oxidising air-acetylene flame. Spray, in triplicate, the calibration solutions (5.3.2), the sample solution and the blank solution (5.3.1), washing the instrument through with distilled water between each spraying. Plot the calibration curve using the mean absorbances of every standard used as the ordinates and the corresponding concentrations of copper in µg/ml as the abscissae.

Determine the concentration of copper in the final sample and blank solutions by reference to the calibration curve.

EXPRESSION OF RESULTS

6. Calculate the copper content of the sample taking into account the weight of the test sample, the dilutions carried out in the course of the analysis and the value of the blank. Express the result as mg Cu/kg.

15.

EXTRACTION OF TOTAL CALCIUM, TOTAL MAGNESIUM, TOTAL SODIUM AND TOTAL SULFUR IN THE FORM OF SULFATES

SCOPE

1. This method is for the extraction of total calcium, total sodium and total sulfur present in the form of sulfates.

FIELD OF APPLICATION

2. This method applies to all fertilisers, for which a declaration of the total calcium, total magnesium, total sodium and total sulfur in the form of sulfates is required.

PRINCIPLE

3. Dissolution by boiling in dilute hydrochloric acid.

REAGENTS

4.—(4.1) Diluted hydrochloric acid;

One volume of hydrochloric acid ($\rho = 1.18 \text{ g/ml}$) plus one volume of water.

APPARATUS

5. Electric hot plate with adjustable temperature.

PREPARATION OF SAMPLE

6. See Method 1.

PROCEDURE

Test sample

Test sample

7.—(7.1) Calcium, magnesium, sodium and sulfur in the form of sulfates are extracted from a test sample of 5 g weighed to within 1 mg. However, when the fertiliser contains more than 15% of sulfur (S) i.e. 37.5% SO₃, and more than 18.8% of calcium (Ca) i.e. 26.3% CaO, the extraction of calcium and sulfur is carried out on a test sample of 1 g, weighed to within 1 mg. Place the test sample in a 600 ml beaker.

Preparation of the solution

(7.2) Add approximately 400 ml of water and, taking care when the sample contains a significant quantity of carbonates, 50 ml of dilute hydrochloric acid (4.1) a small amount at a time. Bring to the boil and maintain for 30 minutes. Allow to cool, stirring occasionally. Transfer quantitatively into a 500 ml graduated flask. Make up to volume with water, and mix. Pass through a dry filter into a dry container, discarding the initial portion. The extract must be completely clear. Stopper if the filtrate is not used immediately.

16.

EXTRACTION OF TOTAL SULFUR

SCOPE

1. This method is for the extraction of total sulfur contained in fertilisers in elemental form and/or in other chemical combinations.

FIELD OF APPLICATION

2. This method applies to all fertilisers for which a declaration of the total sulfur present in various forms (elemental, thiosulfate, sulfite and sulfate) is required.

PRINCIPLE

3. Elemental sulfur is converted in an alkaline medium into polysulfides and thiosulfate; these, together with any sulfites which may be present, are then oxidised with hydrogen peroxide. The various forms of sulfur are thus converted into sulfate which is determined by precipitation as barium sulfate (method 23).

REAGENTS

4.—(4.1) Diluted hydrochloric acid;

One volume of hydrochloric acid ($\rho = 1.18$ g/ml) plus one volume of water.

(4.2) Sodium hydroxide solution, NaOH, 30% minimum ($\rho = 1.33$).

(4.3) Hydrogen peroxide solution, 30% w/w.

(4.4) Aqueous solution of barium chloride BaCl₂·2H₂O, 122 gram per litre.

Status: This is the original version (as it was originally made). This item of legislation is currently only available in its original format.

APPARATUS

5. Electric hot plate with adjustable temperature.

PREPARATION OF SAMPLE

6. See Method 1.

PROCEDURE

Test sample

Test sample

7.—(7.1) Weigh out to within 1 mg a quantity of fertiliser containing between 80 and 350 mg of sulfur (S) or 200 and 875 mg SO₃.

As a rule (where S<15%), weigh out 2.5 grams. Place the test sample in a 400 ml beaker.

Oxidation

(7.2) Add 20 ml of sodium hydroxide solution (4.2) and 20 ml of water. Cover with a watch glass. Boil for five minutes on the hot plate (5). Remove from the hot plate. Using a jet of hot water, collect any material sticking to the sides of the beaker and boil for 20 minutes. Leave to cool.

Add 2 ml increments of hydrogen peroxide (4.3) until no reaction is observed. Six to eight ml of hydrogen peroxide will be necessary. Allow oxidation to continue for one hour, then bring to the boil for half an hour. Leave to cool.

Preparation of the solution to be analysed

(7.3) Add approximately 50 ml of water and 50 ml of the hydrochloric acid solution (4.1).

— If the level of sulfur (S) is less than 5%:

filter into a 600 ml beaker. Wash the residue on the filter several times with cold water. After washing, check for the absence of sulfate in the last drops of the filtrate using the barium chloride solution (4.4). The filtrate must be perfectly clear. Sulfate is determined on the whole of the filtrate in accordance with method 23.

— If the level of sulfur (S) is at/above 5%:

transfer quantitatively into a 250 ml volumetric flask, make up to volume with water and mix. Filter through a dry filter into a dry container; the filtrate must be completely clear. Stopper if the solution is not to be used immediately. Determine sulfates in an aliquot portion of this solution by precipitation in the form of barium sulfate (method 23).

17.

EXTRACTION OF WATER-SOLUBLE CALCIUM, MAGNESIUM, SODIUM AND SULFUR (IN THE FORM OF SULFATES)

SCOPE

1. This method is for the extraction of water-soluble calcium, magnesium, sodium and sulfur (in the form of sulfates), so that the same extract can be used to determine each nutrient required.

2. FIELD OF APPLICATION

This method applies solely to fertilisers for which a declaration of the water-soluble calcium, magnesium, sodium and sulfur (in the form of sulfates) is required.

PRINCIPLE

3. The nutrients are dissolved in boiling water.

REAGENTS

4. Distilled or demineralised water of equivalent quality.

APPARATUS

5. Electric hot plate with adjustable temperature.

PREPARATION OF SAMPLE

6. See Method 1.

PROCEDURE

Test sample

Test sample

- (a) 7. (7.1) (a) Where fertilisers contain no sulfur or where they contain, at the same time, no more than 3% of sulfur (S) i.e. 7.5% SO₃, and no more than 4% of calcium (Ca) i.e. 5.6% CaO, weigh out 5 g of fertiliser to within 1 mg.
- (b) Where fertilisers contain more than 3% of sulfur (S) and more than 4% of calcium (Ca), weigh out 1 g of fertiliser to within 1 mg.

Place the test sample in a 600 ml beaker.

Preparation of the solution

(7.2) Add approximately 400 ml of water and boil for 30 minutes. Allow to cool, stirring occasionally, and transfer quantitatively into a 500 ml graduated flask. Make up to volume with water and mix.

Filter through a dry filter into a dry container.

Discard the initial portion of the filtrate. The filtrate must be completely clear.

Stopper if the solution is not to be used immediately.

18.

EXTRACTION OF WATER-SOLUBLE SULFUR

SCOPE

1. This method is for the extraction of water-soluble sulfur contained in fertilisers, in various forms.

FIELD OF APPLICATION

2. This method applies to all fertilisers for which a declaration of the water-soluble sulfur trioxide is required.

Status: This is the original version (as it was originally made). This item of legislation is currently only available in its original format.

PRINCIPLE

3. Soluble forms of sulfur are dissolved in cold water and converted into sulfate by oxidation with hydrogen peroxide in an alkaline medium.

REAGENTS

4.—(4.1) Diluted hydrochloric acid;

One volume of hydrochloric acid ($\rho = 1.18$ g/ml) plus one volume of water.

(4.2) Sodium hydroxide solution containing at least 30% NaOH ($\rho = 1.33$ g/ml).

APPARATUS

5.—(5.1) 500 ml graduated Stohmann flask.

(5.2) Rotary shaker, 30 to 40 turns per minute.

(5.3) Electric hot plate with adjustable temperature.

PREPARATION OF SAMPLE

6. See Method 1.

PROCEDURE

Test sample

Test sample

(a) 7. (7.1) (a) Where fertilisers contain a maximum of 3% of sulfur (S) i.e. 7.5% SO_3 , together with a maximum of 4% of calcium (Ca) i.e. 5.6% CaO, weigh out 5 g of fertiliser to within 1 mg.

(b) Where fertilisers contain more than 3% of sulfur (S) together with more than 4% of calcium (Ca), weigh out 1 g of fertiliser to within 1 mg.

Place the test sample in a 500 ml flask (5.1).

Preparation of the solution

(7.2) Add approximately 400 ml of water. Stopper. Shake on the rotary shaker (5.2) for 30 minutes. Make up to volume with water and mix. Pass through a dry filter into a dry container. Reject the first portion of the filtrate. Stopper if the solution is not to be used immediately.

Oxidation of the aliquot portion to be analysed

(7.3) Take an aliquot of the extraction solution not exceeding 50 ml and, if possible, containing between 20 and 100 mg of sulfur (S).

Make up the volume to 50 ml with water, if necessary. Add 3 ml of sodium hydroxide solution (4.2) and 2 ml of hydrogen peroxide solution (4.3). Cover with a watch glass and boil gently for one hour on the hot plate (5.3). Keep adding 1 ml increments of hydrogen peroxide solution for as long as the reaction continues (maximum quantity 5 ml).

Then leave to cool. Remove the watch glass and wash the underside into the beaker. Add approximately 20 ml of dilute hydrochloric acid (4.1). Make up to approximately 300 ml with water.

Determine the content of sulfates on the whole of the oxidised solution in accordance with method 23.

19.

EXTRACTION AND DETERMINATION OF ELEMENTAL SULFUR

WARNING

This method of analysis involves the use of carbon disulfide (CS₂). Special safety measures must therefore be taken, in particular with regard to:

- the storage of CS₂,
- protective equipment for staff,
- occupational hygiene,
- prevention of fires and explosions,
- disposal of the reagent.

This method requires highly skilled staff and a suitably equipped laboratory.

SCOPE

1. This method is for the extraction and determination of the elemental sulfur content of fertilisers.

FIELD OF APPLICATION

2. This method applies to all fertilisers for which a declaration of the total sulfur in elemental form is required.

PRINCIPLE

3. After the removal of soluble compounds, elemental sulfur is extracted by using carbon disulfide, followed by gravimetric determination of the sulfur extracted.

REAGENTS

4. Carbon disulfide.

APPARATUS

- 5.—(5.1) 100 ml extraction flask with ground glass stopper.
- (5.2) Soxhlet apparatus.
- (5.3) Vacuum rotary evaporator.
- (5.4) Electric oven, fan assisted, set at $90 \pm 2^\circ\text{C}$.
- (5.5) Petri dishes, five to seven centimetres in diameter, not exceeding five centimetres in height.
- (5.6) Electric hot plate with adjustable temperature.

PREPARATION OF SAMPLE

6. See Method 1.

Status: This is the original version (as it was originally made). This item of legislation is currently only available in its original format.

PROCEDURE

Test sample

Test sample

7.—(7.1) Weigh out 5-10 g of the sample to an accuracy of 1 mg and place in the thimble of the Soxhlet apparatus (5.2).

Extraction of the sulfur

(7.2) Wash thoroughly the contents of the thimble with hot water to remove all soluble compounds. Dry in the oven at 90°C (5.4) for at least one hour. Place the thimble in the Soxhlet apparatus (5.2).

Place a few glass beads in the flask of the apparatus (5.1) and weigh (P_0), then add 50 ml of carbon disulfide (4.1).

Connect the apparatus, switch on and leave for six hours. Switch off the heat and, after cooling, disconnect the flask. Connect the flask to the rotary evaporator (5.3) and evaporate until the contents of the flask have solidified in a spongy mass.

Dry the flask in the oven at 90°C (5.4) (generally one hour if necessary) until a constant weight is obtained (P_1).

Determination of the purity of the elemental sulfur

(7.3) Certain substances may have been extracted by the carbon disulfide at the same time as the elemental sulfur. The purity of the elemental sulfur is determined as follows:

homogenize the contents of the flask as thoroughly as possible and remove 2-3 g, weigh to an accuracy of 1 mg (n). Place in the petri dish (5.5). Weigh dish and contents together (P_2). Place on the hot plate (5.6), set at a temperature not exceeding 220°C so as not to cause combustion of the sulfur. Continue sublimation for three to four hours until a constant weight is obtained (P_3).

Note:

For some fertilisers, it may not be necessary to determine how pure the sulfur is. In this case, omit step 7.3.

EXPRESSION OF RESULTS

8. The percentage elemental sulfur (S) content of the fertiliser is as follows:

$$\text{Impure S (\%)} \text{ of the fertiliser} = \frac{P_1 - P_0}{m} \times 100$$

$$\text{Purity of sulfur extracted (\%)} = \frac{P_2 - P_3}{n} \times 100$$

$$\text{Pure S (\%)} \text{ of the fertiliser} = \frac{(P_1 - P_0)(P_2 - P_3)}{m \times n} \times 100$$

where:

m = the mass of the test sample of fertiliser in grams,

P_0 = the mass of the Soxhlet flask in grams,

P_1 = the mass of the Soxhlet flask and the impure sulfur after drying,

n = the mass of impure sulfur to be purified in grams,

P_2 = the mass of the Petri dish and the sample,

P_3 = the mass of the Petri dish after sublimation of the sulfur.

20.

MANGANIMETRIC DETERMINATION OF EXTRACTED CALCIUM FOLLOWING PRECIPITATION IN THE FORM OF OXALATE

SCOPE

1. This method is for the determination of calcium in fertiliser extracts.

FIELD OF APPLICATION

2. This method applies to all fertilisers for which a declaration of the total and/or water-soluble calcium is required.

PRINCIPLE

3. Precipitation of the calcium contained in an aliquot of the extraction solution in the form of an oxalate, which is determined by titration using potassium permanganate.

REAGENTS

- 4.—(4.1) Diluted hydrochloric acid:

One volume of hydrochloric acid ($\rho = 1.18$ g/ml) plus one volume of water.

- (4.2) 1:10 dilute sulfuric acid:

One volume of sulfuric acid ($\rho = 1.84$ g/ml) in ten volumes of water.

- (4.3) 1:1 dilute ammonia solution:

One volume of ammonia ($\rho = 0.88$ g/ml) and one volume of water.

- (4.4) Saturated solution of ammonium oxalate $[(\text{NH}_4)_2 \text{C}_2\text{O}_4 \cdot \text{H}_2\text{O}]$ at ambient temperature (approximately 40 g per litre).

- (4.5) Citric acid solution, 30% (m/v).

- (4.6) Ammonium chloride solution, 5% (m/v).

- (4.7) Solution of bromothymol blue in 95% ethanol, 0.1% (m/v).

- (4.8) Solution of bromocresol green in 95% ethanol, 0.04% (m/v).

- (4.9) Standard solution of potassium permanganate, 0.02 M.

APPARATUS

- 5.—(5.1) Filter crucible with 5 to 20 μ porosity sintered glass.

- (5.2) Hot water bath.

PREPARATION OF THE ALIQUOT PORTION TO BE ANALYSED

6. Using a pipette, take an aliquot portion of the extraction solution obtained by method 15 or 17, containing between 15 and 50 mg of Ca (= 21 to 70 mg of CaO). Let the volume of this aliquot be v_2 . Pour into a 400 ml beaker. If necessary, neutralise (change of indicator (4.7) from green to blue) with a few drops of the ammonia solution (4.3).

Status: This is the original version (as it was originally made). This item of legislation is currently only available in its original format.

Add 1 ml of the citric acid solution (4.5) and 5 ml of ammonium chloride solution (4.6).

PRECIPITATION OF THE CALCIUM OXALATE

7. Add approximately 100 ml of water. Bring to the boil, add 8 to 10 drops of indicator solution (4.8) and, slowly, 50 ml of the hot ammonium oxalate solution (4.4), stirring constantly. If a precipitate forms, dissolve by adding a few drops of hydrochloric acid (4.1). Neutralise very slowly with ammonia solution (4.3) while stirring continuously to a pH of 4.4 to 4.6 (change of indicator (4.8) from green to blue). Place the beaker in a boiling hot water bath (5.2) for approximately 30 minutes.

Remove the beaker from the bath, leave standing for an hour and filter through the crucible (5.1).

TITRATION OF THE OXALATE PRECIPITATE

8. Wash the beaker and crucible until the excess ammonium oxalate has been completely removed (this can be checked by the absence of chloride in the washing water). Place the crucible in the 400 ml beaker and dissolve the precipitate with 50 ml of hot sulfuric acid (4.2). Add water to the beaker in order to obtain a volume of approximately 100 ml. Bring to a temperature of 70° to 80°C and titrate drop by drop with the permanganate solution (4.9) until the pink colour lasts for a minute. Let this volume be n.

EXPRESSION OF RESULTS

9. The calcium (Ca) content of the fertiliser is as follows:

$$\text{Ca (\%)} = n \times 0.2004 \times \frac{1}{0.02} \times \frac{v_1}{v_2 \times m}$$

where:

n = the volume of 0.2 M permanganate used, in millilitres,

m = the mass of the test sample in grams,

v₂ = the aliquot volume in millilitres,

v₁ = the volume of the extraction solution in millilitres,

t = the molarity of the permanganate solution in moles per litre.

CaO (%) = Ca (%) × 1.400.

21.

DETERMINATION OF MAGNESIUM BY ATOMIC ABSORPTION SPECTROMETRY

SCOPE

1. This method is for the determination of magnesium in fertiliser extracts.

FIELD OF APPLICATION

2. This method applies to all fertiliser extracts obtained by methods 15 and 17, for which a declaration of the total magnesium and/or water-soluble magnesium is required, with the exception of kieserite, magnesium sulfate, magnesium chloride solution and kieserite with potassium sulfate to which method 22 applies.

PRINCIPLE

3. Determination of magnesium by atomic absorption spectrometry after appropriate dilution of the extract.

REAGENTS

4.—(4.1) Hydrochloric acid, 1 M solution.

(4.2) Hydrochloric acid, 0.5 M solution.

(4.3) Standard solution of magnesium, 1.00 mg per ml.

(4.3.1) Dissolve 1.013 g of magnesium sulfate ($\text{MgSO}_4 \cdot 7\text{H}_2\text{O}$) in 0.5 M in hydrochloric acid solution (4.2).

or:

(4.3.2) Weigh out 1.658 g of magnesium oxide (MgO), previously ashed to removed all traces of carbonate. Place in a beaker with 100 ml of water and 120 ml of 1 M hydrochloric acid (4.1). When it has dissolved, transfer quantitatively into a 1 litre graduated flask. Make up to the volume and mix.

or:

(4.3.3) Commercial standard solution.

The laboratory is responsible for testing such solutions.

(4.4) Strontium chloride solution.

Dissolve 75 g of strontium chloride ($\text{SrCl}_2 \cdot 6\text{H}_2\text{O}$) in the hydrochloric acid solution (4.2) and make up to 500 ml with the same acid solution.

APPARATUS

5.—(5.1) Spectrometer fitted for atomic absorption, with a magnesium lamp, set at 285.2 nm.

(5.2) Air-acetylene flame.

PREPARATION OF THE SOLUTION TO BE ANALYSED

6. See Methods 15 and 17.

PROCEDURE

7.—(7.1) If the fertiliser has a declared magnesium (Mg) content of more than 6% (i.e. 10% as MgO), take 25 ml (V_1) of the extraction solution (6). Transfer into a 100 ml graduated flask, and make up to volume with water and mix. The solution factor is $D_1 = 100/V_1$.

(7.2) Using a pipette, take 10 ml of the extraction solution (6) or the solution (7.1). Transfer into a 200 ml graduated flask. Make up to the volume with the 0.5 M hydrochloric acid solution (4.2) and mix. The dilution factor is 200/10.

(7.3) Dilute this solution (7.2) with the 0.5 M hydrochloric acid solution (4.2) so as to obtain a concentration in the optimum working field of spectrometer (5.1). V_2 is the volume of the sample in 100 ml. The dilution factor is $D_2 = 100/V_2$.

Preparation of blank solution

(7.4) Prepare a blank solution by repeating the whole procedure from the extraction (method 15 or 17), omitting only the test sample of fertiliser.

Status: This is the original version (as it was originally made). This item of legislation is currently only available in its original format.

Preparation of calibration solutions

(7.5) By diluting the standard solution (4.3) with 0.5 M hydrochloric acid, prepare at least five calibration solutions in increasing concentrations within the optimum measuring range of the apparatus (5.1).

These solutions should contain 10% v/v of the strontium chloride solution (4.4).

Measurement

(7.6) Set up the spectrometer (5.1) at a wavelength of 285.2 nm.

Spray, successively, the calibration solutions (7.5), the sample solution (7.3) and the blank solution (7.4), washing the instrument through with the solution to be measured next. Repeat this operation three times. Plot the calibration curve using the mean absorbances of each of the calibration solutions (7.5) as the ordinates and the corresponding concentration of magnesium in µg/ml as the abscissae. Determine the concentration of magnesium in the sample (7.3), x_s and blank (7.4), x_b , by reference to the calibration curve.

EXPRESSION OF RESULTS

8. Calculate the amount of magnesium (Mg) or magnesium oxide (MgO) in the sample by reference to the calibration solutions and taking into consideration the blank.

The percentage of magnesium (Mg) in the fertiliser is equal to:

$$\text{Mg (\%)} = \frac{(x_s - x_b) \times D_1 \times (200/10) \times D_2 \times 500 \times 100}{1000 \times 1000 \text{ M}}$$

where:

x_s = the concentration of the solution as calculated from the calibration curve, in µg/ml.

x_b = the concentration of the blank solution as calculated from the calibration curve, in µg/ml.

D_1 = the dilution factor if the solution is diluted (7.1). It is equal to four if 25 millilitres are taken. It is equal to one when the solution is not diluted.

D_2 = the dilution factor in 7.3.

M = the mass of the test sample taken for the extraction.

MgO (%) = Mg (%) / 0.6.

22.

DETERMINATION OF MAGNESIUM BY COMPLEXOMETRY

SCOPE

1. This method is for the determination of magnesium in fertiliser extracts.

FIELD OF APPLICATION

2. This method applies to the determination of total magnesium and/or water-soluble magnesium in the following fertilisers:

- Straight nitrogenous fertilisers (calcium magnesium nitrate, magnesium sulphonitrate, nitrogenous fertiliser with magnesium) and straight potassic fertilisers (enriched kainite, potassium chloride containing magnesium, potassium sulfate containing magnesium salt), kieserite, magnesium sulfate, magnesium chloride solution, and kieserite with potassium sulfate.

PRINCIPLE

3. The magnesium is extracted by methods 15 and/or 17. First titration: with EDTA and Ca and Mg in the presence of Eriochrome black T. Second titration: with EDTA of Ca in the presence of calcein or of calcon carbonic acid. Determination of magnesium by difference.

REAGENTS

Standard 0.05 M solution of magnesium:

Standard 0.05 M solution of magnesium:

(4.1.1) 4. (4.1) (4.1.1) Dissolve 1.232 g of magnesium sulfate ($\text{MgSO}_4 \cdot 7\text{H}_2\text{O}$) in the 0.5 M hydrochloric acid solution (4.11) and make up to 100 ml with the same acid.

or:

(4.1.2) Weigh out 2.016 g of magnesium oxide, previously calcined to remove all traces of carbonation. Place it in a beaker with 100 ml of water.

Stir in approximately 120 ml of approximately 1 M hydrochloric acid (4.12).

After dissolution, transfer quantitatively into a graduated 1 litre flask. Make up to volume and mix.

1 ml of these solutions should contain 1.216 mg of Mg (= 2.016 mg of MgO).

The laboratory is responsible for testing the strength of this standard solution.

0.05 M solution of EDTA

(4.2) Weigh out 18.61 g of the dihydrated disodium salt of ethylenediaminetetraacetic ($\text{C}_{10}\text{H}_{14}\text{Na}_2\text{O}_8 \cdot 2\text{H}_2\text{O}$), place it in a 1000 ml beaker and dissolve in 600 to 800 ml of water. Transfer the solution quantitatively into a graduated 1 litre flask. Make up the volume and mix. Check this solution with the standard solution (4.1) by taking a sample of 20 ml of the latter and by titration according to the analytical procedure described at 7.2.

0.05 molar standard solution of calcium

(4.3) Weigh out 5.004 g of dry calcium carbonate. Place it in a beaker with 100 ml of water. Progressively stir in 120 ml of approximately 1 M hydrochloric acid (4.12).

Bring to the boil in order to drive off the carbon dioxide, cool, transfer quantitatively into a graduated one-litre flask, make up the volume with water and mix. Check this solution against the EDTA solution (4.2) following analytical procedure (8.3). 1 ml of this solution should contain 2.004 mg of Ca (= 2.804 mg of CaO) and should correspond to 1 ml of the 0.05 M EDTA solution (4.2).

Calcium indicator

(4.4) Carefully mix in a mortar one gram of calcein with 100 g of sodium chloride. Use 10 mg of this mixture. This indicator changes colour from green to orange. Titration must be carried out until an orange colour free from green tinges is obtained.

Calcon carbonic acid indicator

(4.5) Dissolve 400 mg of calcon carbonic acid in 100 ml of methanol. This solution may only be kept for approximately four weeks. Use three drops of this solution. The indicator changes colour from red to blue. Titration must be carried out until a blue colour free from red tinges is obtained.

Eriochrome black-T indicator

Status: This is the original version (as it was originally made). This item of legislation is currently only available in its original format.

(4.6) Dissolve 300 mg of Eriochrome black-T in a mixture of 25 ml of propan-1-ol and 15 ml of triethanolamine. This solution may only be kept for approximately four weeks. Use three drops of this solution. This indicator changes colour from red to blue and titration must be carried out until a blue colour free from red tinges is obtained. It changes colour only when magnesium is present. If necessary add one millilitre of the standard solution (4.1).

When both calcium and magnesium are present the EDTA first forms a complex with the calcium and then the magnesium. In that case the two elements are determined concurrently.

Potassium cyanide solution

(4.7) Aqueous solution of KCN at 2%. (**CAUTION:** potassium cyanide is extremely poisonous, take suitable precautions and do not pipette by mouth. See also 10.7).

Solution of potassium hydroxide and potassium cyanide

(4.8) Dissolve 280 g of KOH and 66 g of KCN in water, make up the volume to one litre and mix.

Buffer solution, pH 10.5

(4.9) In a 500 ml graduated flask, dissolve 33 g of ammonium chloride in 200 ml of water, add 250 ml of ammonia ($\rho = 0.91$), make up the volume with water and mix. Check the pH of the solution regularly.

Diluted hydrochloric acid

(4.10) One volume of hydrochloric acid ($\rho = 1.18$ g/ml) plus one volume of water.

(4.11) Hydrochloric acid solution approximately 0.5 M.

(4.12) Hydrochloric acid solution approximately 1 M.

(4.13) Sodium hydroxide solution 5 M.

APPARATUS

5.—(5.1) Magnetic or mechanical stirrer.

(5.2) pH meter.

CONTROL TEST

6. Carry out a determination on aliquot portions of solutions (4.1 and 4.3) such that the Ca/Mg ratio is approximately equal to that of the solutions to be analysed. To this end take (a) of standard solution (4.3) and (b-a) of standard solution (4.1). (a) and (b) are the volumes of EDTA solution in millilitres used in the two titrations performed on the solution to be analysed. This procedure is correct only if the solutions of EDTA, calcium and magnesium are exactly equivalent. If this is not the case, it is necessary to make corrections.

PREPARATION OF THE SOLUTION TO BE ANALYSED

7. See Methods 15 and 17.

DETERMINATION

Aliquot portions to be taken

Aliquot portions to be taken

8.—(8.1) Take aliquot portions of the extracts which contain between 9 and 18 mg of magnesium (= 15 to 30 mg of MgO).

Titration in the presence of Eriochrome black-T

(8.2) Pipette an aliquot portion (8.1) of the solution to be analysed into a 400 ml beaker. Neutralise the excess acid with the 5 M sodium hydroxide solution (4.12) and check the pH. Dilute with water to approximately 100 ml. Add 5 ml of the buffer solution (4.9). The pH measured by meter must be 10.5 ± 0.1 . Add 2 ml of the potassium cyanide solution (4.7) and three drops of the Eriochrome black-T indicator (4.6). Titrate with the EDTA solution (4.2). Stirring gently with the stirrer (5.1) (see 10.2, 10.3 and 10.4). Let 'b' be the volume in millilitres of 0.05 molar EDTA solution used.

Titration in the presence of calcein or of calcon carbonic acid

(8.3) Pipette an aliquot portion of the solution to be analysed equal to that taken for the above titration and place it in a 400 ml beaker. Neutralise the excess acid with the 5 M sodium hydroxide solution (4.13) using the pH meter. Dilute with water to about 100 ml. Add 10 ml of KOH/KCN solution (4.8) and three drops of the indicator (4.4 or 4.5). Stirring gently with the stirrer (5.1) titrate with the EDTA solution (4.2) (see 10.2, 10.3 and 10.4). Let 'a' be the volume in millilitres of 0.05 M EDTA solution.

EXPRESSION OF RESULTS

9. For the EEC fertilisers to which the method is applicable (5 g of fertiliser in 500 ml of extract), the percentage content of the fertiliser is:

$$\text{MgO (\%)} \text{ in the fertiliser} = \frac{(b - a) \times T}{M}$$

$$\text{Mg (\%)} \text{ in the fertiliser} = \frac{(b - a) \times T1}{M}$$

where:

a = the volume in millilitres of 0.05 M EDTA solution used for the titration in the presence of calcein or calcon carbonic acid.

b = the volume in millilitres of 0.05 M EDTA solution used for the titration in the presence of Eriochrome black-T.

M = the mass of the sample present in the aliquot taken (in grams).

T = $0.2016 \times$ molarity of the EDTA solution/0.05 (see 4.2).

T1 = $0.1216 \times$ molarity of the EDTA solution/0.05 (see 4.2).

REMARKS

10.—(10.1) The stoichiometric EDTA-metal ratio in the complexometric analyses is always 1:1 whatever the valency of the metal and in spite of the fact that EDTA is quadrivalent. The EDTA titration solution and the standard solutions will therefore be molar and not normal.

(10.2) Complexometric indicators are often sensitive to air. The solution may lose colour during titration. In this case, one or two drops of indicator must be added. This is true particularly in the case of Eriochrome black-T and calcon carbonic acid.

(10.3) The metal-indicator complexes are often relatively stable and it may take some time for the colour to change. The last drops of EDTA must therefore be added slowly and a drop of 0.05 molar solution of magnesium (4.1) or calcium (4.3) added to ensure that the colour change has not already taken place. This is particularly true in the case of the Eriochrome-magnesium complex.

Status: This is the original version (as it was originally made). This item of legislation is currently only available in its original format.

(10.4) The colour change of the indicator must not be observed vertically, but horizontally across the solution and the beaker must be placed against a white background in a well-lit position. The colour change of the indicator may also be observed easily by placing the beaker on frosted glass lit moderately from below (25 watt lamp).

(10.5) This analysis requires a certain amount of experience. The task will involve, among other things, observing the colour changes of standard solutions 4.1 and 4.3. It is recommended that the determinations be carried out by the same laboratory chemist.

(10.6) If an EDTA solution of guaranteed strength is used (Titrisol, Normex, for example) this may simplify the control of the equivalence of standard solutions 4.1, 4.2 and 4.3.

(10.7) **The solutions containing potassium cyanide must not be poured down the sink until the cyanide has been converted into a harmless compound, for example, by oxidation with sodium hypochlorite after having been made alkaline.**

23.

DETERMINATION OF SULFATES

SCOPE

1. This method is for the determination of sulfur present in fertiliser extracts in the form of sulfates.

FIELD OF APPLICATION

2. This method applies to the determination of sulfates present in the extractions performed in methods 15, 16, 17 and 18.

PRINCIPLE

3. Gravimetric determination as barium sulfate.

REAGENTS

Diluted hydrochloric acid:

Diluted hydrochloric acid:

4.—(4.1) One volume of hydrochloric acid ($\rho = 1.18$ g/ml) and one volume of water.

(4.2) Barium chloride solution $\text{BaCl}_2 \cdot 2\text{H}_2\text{O}$: 122 grams per litre.

(4.3) Silver nitrate solution: 5 grams per litre.

APPARATUS

5.—(5.1) Crucibles.

(5.2) Hot water bath.

(5.3) Drying oven set at $105^\circ\text{C} \pm 1^\circ\text{C}$.

(5.4) Electric furnace set at $800^\circ\text{C} \pm 50^\circ\text{C}$.

PROCEDURE

Sampling of the solution

Sampling of the solution

6.—(6.1) Pipette an aliquot portion of one of the extraction solutions indicated at (2) containing between 20 and 100 mg of S or 50 and 250 mg of SO₃.

Place this aliquot portion in a beaker of suitable capacity. Add 20 ml of dilute hydrochloric acid (4.1). Make up to about 300 ml with water.

Preparation of the precipitate

(6.2) Bring the solution to the boil. Add, drop by drop, about 20 ml of the hot barium chloride solution (4.2) while stirring the solution vigorously. Boil for a few minutes.

Place the beaker, covered with a watch glass, in a boiling water bath (5.2) for an hour. Then leave standing hot (~60°C) until the supernatant liquor is clear. Decant the clear solution through a slow filtration ash-free filter. Wash the precipitate several times with hot water. Continue to wash the precipitate on the filter until the filtrate is chloride free. This can be checked by using silver nitrate solution (4.3).

Incineration and weighing of the precipitate

(6.3) Place the filter paper and precipitate in a crucible (5.1) previously weighed to the nearest 0.1 mg. Dry in the oven (5.3) and ash at approximately 800°C for half an hour (5.4). Allow to cool in a desiccator and weigh to within 0.1 mg.

EXPRESSION OF RESULTS

7. One mg of barium sulfate corresponds to 0.137 mg of S or to 0.343 mg of SO₃. The percentage S content of the fertiliser is obtained as follows:

$$S (\%) = w \times 0.0137 \times \frac{v_1}{v_2 \times m}$$

$$SO_3 (\%) = S (\%) \times 2.5$$

where:

w = the mass of the barium sulfate precipitate in milligrams,

v₁ = the volume of the extraction solution in millilitres,

v₂ = the aliquot volume in millilitres,

m = the mass of the test sample in grams.

24.

DETERMINATION OF THE SODIUM EXTRACTED

SCOPE

1. This method is for the determination of sodium in fertiliser extracts.

FIELD OF APPLICATION

2. This method applies to fertilisers for which a declaration of sodium is required.

PRINCIPLE

3. Following suitable dilution of the extract obtained via method 15 and/or 17 the sodium content of the solution is determined by flame-emission spectrometry.

Status: This is the original version (as it was originally made). This item of legislation is currently only available in its original format.

REAGENTS

Diluted hydrochloric acid:

Diluted hydrochloric acid:

4.—(4.1) One volume of hydrochloric acid ($\rho = 1.18$ g/ml) plus one volume of water.

(4.2) Aluminium nitrate $\text{Al}(\text{NO}_3)_3 \cdot 9\text{H}_2\text{O}$.

(4.3) Caesium chloride, CsCl.

(4.4) Anhydrous sodium chloride, NaCl.

Caesium chloride and aluminium nitrate solution

(4.5) Dissolve in water 50 g of caesium chloride (4.3) and 250 g of aluminium nitrate (4.2) in a 1 litre graduated flask. Make up to volume with water and mix.

Standard sodium solution of 1 mg/ml of Na

(4.6) Dissolve in water 2.542 g of sodium chloride (4.4) in a 1 litre graduated flask. Add 10 ml of hydrochloric acid (4.1). Make up to volume with water and mix.

APPARATUS

5. Spectrometer equipped for flame emission, set at 589.3 nm.

CALIBRATION SOLUTIONS

6.—(6.1) Pipette 10 ml of standard solution (4.6) into a 250 ml graduated flask. Make up to volume and mix. Concentration of solution: 40 $\mu\text{g}/\text{ml}$ of Na.

(6.2) Using a burette place 0, 5, 10, 15, 20, 25 ml of the intermediate solution (6.1) in 100 ml graduated flasks. Add 10 ml of the solution (4.5). Make up to volume and mix. Concentration of solutions: 0, 2, 4, 6, 8, 10 $\mu\text{g}/\text{ml}$ of Na.

PREPARATION OF SOLUTIONS TO BE MEASURED

7. Depending upon the expected sodium content of the extraction solution as in method 15 or 17 (5 g of fertiliser in 500 ml), carry out the dilutions in accordance with the following table:

Na ₂ O (%)	Na (%)	Intermediate dilution		Final dilution		Degree of dilution
		Sample (ml) (v ₂)	Dilution to ml (v ₃)	Sample (ml) (v ₄)	Dilution to ml	
3-5	2.2-3.7	10	50	10	100	50
5-10	3.7-7.4	10	100	10	100	100
10-20	7.4-15	10	100	5	100	200
20-38	15-28	5	100	5	100	400

Make up the intermediate dilution with water. For the final dilution add 10 ml of the solution (4.5) to the 100 ml graduated flask.

For a test sample of 1 g multiply the volume of the final dilution (v₄) by five.

DETERMINATION

8. Prepare the spectrometer (5) for the measurements at 589.3 nm. Calibrate the instrument by measuring the response of the calibration solutions (6.2). Then adjust the sensitivity of the instrument to use its entire scale when the most concentrated calibration solution is used. Then measure the response of the sample solution to be analysed (7). Repeat this operation twice.

CALCULATION OF RESULTS

9. Draw a calibration curve by plotting the average response for each calibration solution along the ordinate and the corresponding concentrations, expressed in µg per ml on the abscissa. Determine from this the sodium concentration of the test solution. Calculate the quantity of sodium from the standard solutions taking account of the levels of dilution. Express the results as a percentage of the sample.

The percentage sodium (Na) content of the fertiliser is as follows:

$$\text{Na (\%)} = X \times \frac{v_3}{v_4} \times \frac{v_1}{v_2} \times \frac{10^{-2}}{m}$$

$$\text{Na}_2\text{O (\%)} = \text{Na (\%)} \times 1.348$$

where:

X = the concentration of the solution introduced into the spectrometer in µg/ml,

v_1 = the volume of the extraction solution in millilitres,

v_2 = the aliquot volume in the intermediate dilution in millilitres,

v_3 = the volume of intermediate dilution in millilitres,

v_4 = the aliquot volume in ml of the final dilution (in 100 millilitres),

m = the mass of the test sample in grams.

25.

TRACE ELEMENTS AT A CONCENTRATION LESS THAN 10%

25a.

EXTRACTION OF TOTAL TRACE ELEMENTS

SCOPE

1. This method defines the procedure for extracting the following trace elements: total boron, total cobalt, total copper, total iron, total manganese, total molybdenum and total zinc. The aim is to carry out the minimum number of extractions, making use wherever possible of the same extract to determine the total level of each of the trace elements listed above.

FIELD OF APPLICATION

2. This procedure concerns fertilisers containing one or more of the following trace elements: boron, cobalt, copper, iron, manganese, molybdenum and zinc. It is applicable to each trace element the declared content of which is less than or equal to 10%.

PRINCIPLE

3. Dissolution in boiling dilute hydrochloric acid.

Status: This is the original version (as it was originally made). This item of legislation is currently only available in its original format.

Note:

The extraction is empirical and may not be quantitative depending on the product or the other constituents of the fertiliser. In particular, in the case of certain manganese oxides, the quantity extracted may be substantially smaller than the total quantity of manganese which the product contains. It is the responsibility of the fertiliser manufacturer to ensure that the declared content actually corresponds to the quantity extracted under the conditions pertaining to the method.

REAGENTS

Dilute hydrochloric acid (HCl) solution, about 6 M:

Dilute hydrochloric acid (HCl) solution, about 6 M:

4.—(4.1) Mix 1 volume of hydrochloric acid ($\rho = 1.18$ g/ml) with one volume of water.

(4.2) Concentrated ammonia solution (NH_4OH , $\rho = 0.9$ g/ml).

APPARATUS

5. Electric hot plate with variable temperature control.

Note:

Where the boron content of an extract is to be determined, do not use borosilicate glassware. As the method involves boiling, teflon or silica is preferable. Rinse the glassware thoroughly if it has been washed in detergents containing borates.

PREPARATION OF SAMPLE

6. See Method 1.

PROCEDURE

Test sample

Test sample

7.—(7.1) Take a quantity of fertiliser weighing between 2 and 10 g depending on the declared content of the element in the product. The following table shall be used to obtain a final solution which, after appropriate dilution, will be within the measuring range for each method. Samples should be weighed to within 1 mg.

Declared content of trace element in the fertiliser (%)	< 0.01	0.01-< 5	≥ 5 -10
Mass of test sample (g)	10	5	2
Mass of element in the sample (mg)	1	0.5-250	100-200
Volume of extract V (ml)	250	500	500
Concentration of element in extract (mg/l)	4	1-500	200-400

Place the sample in a 250 ml beaker.

Status: This is the original version (as it was originally made). This item of legislation is currently only available in its original format.

(7.2) Preparation of the solution

If necessary moisten the sample with a little water, add 10 ml of dilute hydrochloric acid (4.1) per gram of fertiliser carefully, in small amounts, then add about 50 ml of water. Cover the beaker with a watch glass and mix. Bring to the boil on the hot plate and boil for 30 minutes. Allow to cool, stirring occasionally. Transfer quantitatively to a 250 or 500 ml volumetric flask (see Table). Make up to volume with water and mix thoroughly. Filter through a dry filter into a dry container. Discard the first portion. The extract must be perfectly clear.

It is recommended that the determinations be carried out without delay on aliquot portions of the clear filtrate, if not the containers should be stoppered.

Note:

Extracts in which the boron content has to be determined: Adjust the pH to between 4 and 6 with concentrated ammonia (4.2).

DETERMINATION

8. The determination of each trace element is to be carried out on the aliquot portions indicated in the method for each individual trace element.

If necessary, remove organic chelating or complexing substances from an aliquot portion of the extract by using Method 25c. In the case of determination by atomic absorption spectrometry, such removal may not be necessary.

25b.

EXTRACTION OF WATER-SOLUBLE TRACE ELEMENTS

SCOPE

1. This method defines the procedure for extracting water-soluble forms of the following trace elements: boron, cobalt, copper, iron, manganese, molybdenum and zinc. The aim is to carry out the minimum number of extractions, making use wherever possible of the same extract to determine the level of each of the trace elements listed above.

FIELD OF APPLICATION

2. This procedure concerns fertilisers containing one or more of the following trace elements: boron, cobalt, copper, iron, manganese, molybdenum and zinc. It is applicable to each trace element the declared content of which is less than or equal to 10%.

PRINCIPLE

3. The trace elements are extracted by shaking the fertiliser in water at $20^{\circ}\text{C} \pm 2^{\circ}\text{C}$.

Note:

The extraction is empirical and may or may not be quantitative .

REAGENTS

Dilute hydrochloric acid (HCl) solution, above 6 M:

Dilute hydrochloric acid (HCl) solution, above 6 M:

4.—(4.1) Mix 1 volume of hydrochloric acid ($\rho = 1.18 \text{ g/ml}$) with one volume of water.

Status: This is the original version (as it was originally made). This item of legislation is currently only available in its original format.

APPARATUS

Rotary shaker set at about 35 to 40 rpm.

Rotary shaker set at about 35 to 40 rpm.

5.—(5.1)

(5.2) pH-meter.

Note:

Where the boron content of the extract is to be determined, do not use borosilicate glassware. Teflon or silica is preferable for this extraction. Rinse the glassware thoroughly if it has been washed in detergents containing borates.

PREPARATION OF THE SAMPLE

6. See Method 1.

PROCEDURE

Test sample

Test sample

7.—(7.1) Take a quantity of fertiliser weighing between 2 and 10 g depending on the declared content of the element in the product. The following table shall be used to obtain a final solution which, after appropriate dilution, will be within the measuring range for each method. The samples should be weighed to within 1 mg.

Declared content of trace element in the fertiliser (%)	< 0.01	0.01-< 5	≥ 5-10
Mass of test sample (g)	10	5	2
Mass of element in the sample (mg)	1	0.5-250	100-200
Volume of extract V (ml)	250	500	500
Concentration of element in extract (mg/l)	4	1-500	200-400

Place the sample in a 250 or 500 ml flask (according to the Table).

Preparation of the solution

(7.2) Add about 200 ml of water to the 250 ml flask or 400 ml of water to the 500 ml flask.

Stopper the flask well. Shake vigorously by hand to disperse the sample, then place the flask on the shaker and shake for 30 minutes.

Make up to volume with water and mix thoroughly.

Preparation of the test solution

(7.3) Filter immediately into a clean, dry flask. Stopper the flask. Carry out the determination immediately after filtering.

Note:

If the filtrate gradually becomes cloudy, make another extraction following 7.1 and 7.2 in a flask of volume V_e . Filter into a calibrated flask of volume W which has previously been dried and has received 5.00 ml of dilute hydrochloric acid (4.1). Stop the filtration at the exact moment when the calibration mark is reached. Mix thoroughly.

Under these conditions the value of V in the expression of results is:

$$V = V_e \times W / (W - 5).$$

The dilution in the expression of results depend on this value of V .

DETERMINATION

8. The determination of each trace element is carried out on the aliquot portions indicated in the method for each individual trace element.

If necessary, remove organic chelating or complexing substances from an aliquot portion by using Method 25c. In the case of determination by atomic absorption spectrometry, such removal may not be necessary.

25c.

REMOVAL OF ORGANIC COMPOUNDS FROM FERTILISER EXTRACTS

SCOPE

1. This method defines a procedure for removing organic compounds from fertiliser extracts.

FIELD OF APPLICATION

2. This procedure is applicable to analysing samples of fertilisers extracted by Methods 25a and 25b for which a declaration of total and/or water-soluble element is required.

Note:

The presence of small quantities of organic matter usually does not affect determination by means of atomic absorption spectrometry.

PRINCIPLE

3. The organic compounds in an aliquot proportion of the extract are oxidised with hydrogen peroxide.

REAGENTS

Dilute hydrochloric acid (HCl) solution, about 0.5 M:

Dilute hydrochloric acid (HCl) solution, about 0.5 M:

- 4.—(4.1) Mix 1 volume of hydrochloric acid ($\rho = 1.18$ g/ml) with 20 volumes of water.
- (4.2) Hydrogen peroxide solution (30% H_2O_2 $\rho = 1.11$ g/ml), free from trace elements.

Status: This is the original version (as it was originally made). This item of legislation is currently only available in its original format.

APPARATUS

5. Electric hot plate with variable temperature control.

PROCEDURE

6. Take 25 ml of the extract solution obtained by Method 25a or Method 25b and place in a 100 ml beaker. In the case of Method 25b add 5 ml of the dilute hydrochloric acid solution (4.1). Then add 5 ml of the hydrogen peroxide solution (4.2). Cover with a watch glass. Allow oxidation to occur at room temperature for about one hour, then bring gradually to boiling and boil for half an hour. If necessary, add a further 5 ml of the hydrogen peroxide to the solution once it has cooled. Then boil to remove the excess hydrogen peroxide. Allow to cool and transfer quantitatively to a 50 ml volumetric flask and make up to volume. Filter where necessary.

Account should be taken of this dilution when taking aliquot portions and calculating the amount of trace element in the product.

25d.

DETERMINATION OF TRACE ELEMENTS IN FERTILISER EXTRACTS BY ATOMIC ABSORPTION SPECTROMETRY (GENERAL PROCEDURE)

SCOPE

1. This method defines a general procedure for determining the levels of certain trace elements in fertiliser extracts by atomic absorption spectrometry.

FIELD OF APPLICATION

2. This procedure is applicable to analysing samples of fertilisers extracted by Methods 25a and 25b for which a declaration of total and/or water-soluble element is required.

Adaptations of this procedure for the various trace elements are detailed in the methods defined specifically for each element.

Note:

In most cases the presence of small quantities of organic matter will not affect determinations by atomic absorption spectrometry.

PRINCIPLE

3. After the extract has been treated where necessary to reduce or eliminate interfering chemical species, the extract is diluted so that its concentration is in the optimum range of the spectrometer at a wave-length suitable for the trace element to be determined.

REAGENTS

Dilute hydrochloric acid (HCl) solution, about 6 M:

Dilute hydrochloric acid (HCl) solution, about 6 M:

- 4.—(4.1) Mix one volume of hydrochloric acid ($\rho = 1.18$ g/ml) with 1 volume of water.

Dilute hydrochloric acid (HCl) solution, about 0.5 M:

- (4.2) Mix one volume of hydrochloric acid ($\rho = 1.18$ g/ml) with 20 volumes of water.

Status: This is the original version (as it was originally made). This item of legislation is currently only available in its original format.

(4.3) Lanthanum salt solutions (10 g of La per litre).

This reagent is used for determinations of cobalt, iron, manganese and zinc. Lanthanum is added to the extract to eliminate chemical interferences in the air-acetylene flame. It can be prepared either:

- (a) with lanthanum oxide dissolved in hydrochloric acid (4.1). Place 11.73 g of lanthanum oxide (La_2O_3) in 150 ml water in a 1 litre volumetric flask and add 120 ml of 6 M hydrochloric acid (4.1). Allow to dissolve and then make up to 1 litre with water and mix thoroughly. This solution is approximately 0.5 M in hydrochloric acid; or
- (b) with solutions of lanthanum chloride, sulfate or nitrate. Place 26.7 g of lanthanum chloride heptahydrate ($\text{LaCl}_3 \cdot 7\text{H}_2\text{O}$) or 31.2 g of lanthanum nitrate hexahydrate [$\text{La}(\text{NO}_3)_3 \cdot 6\text{H}_2\text{O}$] or 26.2 g of lanthanum sulfate nonahydrate [$\text{La}_2(\text{SO}_4)_3 \cdot 9\text{H}_2\text{O}$] in 150 ml of water in a 1 litre volumetric flask, then add 85 ml of 6 M hydrochloric acid (4.1). Allow to dissolve and then make up to 1 litre with water. Mix thoroughly. This solution is approximately 0.5 M in hydrochloric acid.

Calibration solutions

(4.4) For the preparation of these, see the individual method of determination for each trace element.

APPARATUS

5. Atomic absorption spectrometer fitted with sources emitting radiation characteristic of the trace elements to be determined.

The analyst must follow the manufacturer's instructions and be familiar with the apparatus. The apparatus must allow background correction so that it can be used whenever necessary (Co and Zn). The gases to be used are air and acetylene.

PREPARATION OF THE SOLUTION TO BE ANALYSED

Preparation of extract solutions of the trace elements to be determined

Preparation of extract solutions of the trace elements to be determined

6.—(6.1) See Method 25a and/or 25b and, if appropriate, 25c

Treatment of the test solution

(6.2) Dilute an aliquot portion of the extract obtained by Method 25a, 25b or 25c with water and/or hydrochloric acid (4.1 or 4.2) so as to obtain, in the final solution for measurement, a concentration of the element to be determined that is appropriate to the calibration range used (7.2) and a hydrochloric acid concentration of at least 0.5 M and not more than 2.5 M. This operation may require one or more successive dilutions.

Take an aliquot portion of the final solution obtained by dilution of the extract, let (a) be its volume in ml, and pour into a 100 ml volumetric flask. When determining the cobalt, iron, manganese or zinc content, add 10 ml of the lanthanum salt solution (4.3). Make up to volume with the 0.5 M hydrochloric acid solution (4.2) and mix thoroughly. This is the final solution for measurement. Let D be the dilution factor.

PROCEDURE

Preparation of a blank solution

Status: This is the original version (as it was originally made). This item of legislation is currently only available in its original format.

Preparation of a blank solution

7.—(7.1) Prepare a blank solution by repeating the whole procedure from the extraction stage, omitting only the test sample of fertiliser.

Preparation of calibration solutions

(7.2) From the working calibration solution prepared using the method given for each individual trace element, prepare in 100 ml volumetric flasks a series of at least five calibration solutions of increasing concentration within the optimum measuring range of the spectrometer. If necessary, adjust the concentration of hydrochloric acid to bring it as close as possible to that of the diluted test solution (6.2). For determining cobalt, iron, manganese or zinc add 10 ml of the same lanthanum salt solution (4.3) as used in 6.2. Make up to volume with the 0.5 M hydrochloric acid solution (4.2) and mix thoroughly.

Determination

(7.3) Prepare the spectrometer (5) for the determination and adjust to the wavelength given in the method for the individual trace element concerned.

Spray three times in succession the calibration solutions (7.2), and the test solution (6.2) and the blank solution (7.1), noting each result and flushing the instrument with distilled water between individual sprayings.

Construct the calibration curve by plotting the average spectrometer reading for each calibration solution (7.2) along the ordinate and the corresponding concentration of the element, expressed in µg per ml, along the abscissa.

From this curve, determine the concentrations of relevant trace element in the test solution x_s (6.2) and in the blank solution x_b (7.1), expressing these concentrations in µg per ml.

EXPRESSION OF RESULTS

8. The percentage of trace element (E) in the fertiliser is equal to:

$$E (\%) = [(x_s - x_b) \times V \times D] / (M \times 10^4)$$

If method (25c) has been used:

$$E (\%) = [(x_s - x_b) \times V \times 2D] / (M \times 10^4)$$

where:

E = the amount of the trace element determined, expressed as a percentage of the fertiliser;

x_s = the concentration of the test solution (6.2), in µg/ml;

x_b = the concentration of the blank solution (7.1), in µg/ml;

V = the volume of the extract obtained by Method 25a or 25b, in ml;

D = the factor corresponding to the dilution carried out in (6.2);

M = the mass of the test sample taken in accordance with Method 25a or 25b in grams.

Calculation of dilution factor D:

If (a_1) , (a_2) , (a_3) , . . . , (a_i) and (a) are the aliquot portions and (v_1) , (v_2) , (v_3) , . . . , (v_i) and (100) are the volumes in ml corresponding to their respective dilutions, the dilution factor D will be equal to:

$$D = (v_1/a_1) \times (v_2/a_2) \times (v_3/a_3) \times \dots \times (v_i/a_i) \times (100/a)$$

25e.

DETERMINATION OF BORON IN FERTILISER EXTRACTS
BY MEANS OF SPECTROMETRY WITH AZOMETHINE-H

SCOPE

1. This method describes a procedure for determining boron in fertiliser extracts.

FIELD OF APPLICATION

2. This procedure is applicable to analysing samples of fertilisers extracted by Methods 25a and 25b for which a declaration of total and/or water-soluble boron is required.

PRINCIPLE

3. In an azomethine-H solution, borate ions form a yellow complex the concentration of which is determined by molecular absorption spectrometry at 410 nm. Interfering ions are masked with EDTA.

REAGENTS

EDTA buffer solution

EDTA buffer solution

- 4.—(4.1) Place in a 500 ml volumetric flask containing 300 ml of water:
 - 75 g of ammonium acetate ($\text{NH}_4\text{OOCCH}_3$);
 - 10 g of disodium salt of ethylene diamine tetraacetic acid (Na_2EDTA);
 - 40 ml of acetic acid (CH_3COOH , $\rho = 1.05 \text{ g/ml}$).

Make up to volume with water and mix thoroughly. The pH of the solution, checked by means of a glass electrode, must be 4.8 ± 0.1 .

Azomethine-H solution

- (4.2) Place in a 200 ml volumetric flask
 - 10 ml of the buffer solution (4.1);
 - 400 mg of azomethine-H ($\text{C}_{17}\text{H}_{12}\text{NNaO}_8\text{S}_2$);
 - 2 g of ascorbic acid ($\text{C}_6\text{H}_8\text{O}_6$).

Make up to volume and mix thoroughly. Do not prepare large quantities of this reagent as it is stable for only a few days.

Boron calibration solutions

Boron stock solution (100 $\mu\text{g/ml}$)

- (4.3.1) Dissolve 0.5719 g of boric acid (H_3BO_3) in water in a 1000 ml volumetric flask. Make up to volume with water and mix thoroughly. Transfer to a plastic bottle for storage in a refrigerator.

Boron working solution (10 $\mu\text{g/ml}$)

Status: This is the original version (as it was originally made). This item of legislation is currently only available in its original format.

(4.3.2) Place 50 ml of stock solution (4.3.1) in a 500 ml volumetric flask. Make up to volume with water and mix thoroughly.

APPARATUS

5. Spectrometer fitted for molecular absorption with cells having a 10 mm optical path and set to a wavelength of 410 nm.

PREPARATION OF THE SOLUTION TO BE ANALYSED

Preparation of the boron solution

Preparation of the boron solution

6.—(6.1) See Methods 25a and/or 25b and, if appropriate, 25c.

Preparation of the test solution

(6.2) Dilute an aliquot portion of extract (6.1) to obtain a boron concentration as specified in 7.2. Two successive dilutions may be necessary. Let D be the dilution factor.

Preparation of the correction solution

(6.3) If the test solution (6.2) is coloured, prepare a corresponding correction solution by placing in a plastic flask 5 ml of test solution (6.2), 5 ml of EDTA buffer solution (4.1) and 5 ml of water and mix thoroughly.

PROCEDURE

Preparation of the blank solution

Preparation of the blank solution

7.—(7.1) Prepare a blank solution by repeating the whole procedure from the extraction stage, omitting only the test sample of fertiliser.

Preparation of the calibration solutions

(7.2) Transfer 0, 5, 10, 15, 20 and 25 ml of the working calibration solution (4.3.2) to a series of 100 ml volumetric flasks. Make up to 100 ml with water and mix thoroughly. These solutions contain between 0 and 2.5 µg/ml of boron.

Colour development

(7.3) Transfer 5 ml of the calibration solutions (7.2), test solutions (6.2) and blank (7.1) to a series of plastic flasks. Add 5 ml of the EDTA buffer solution (4.1). Add 5 ml of the azomethine-H solution (4.2).

Mix thoroughly and allow the colour to develop in the dark for 2½ to 3 hours.

Determination

(7.4) Measure the absorbance of the solutions obtained at 7.3 and if appropriate the correction solution (6.3) against water at a wavelength of 410 nm. Rinse the cells with water before each new reading.

EXPRESSION OF RESULTS

8. Plot a calibration curve of the concentration of the calibration solutions (7.2) along the abscissa and the absorbance given by the spectrophotometer (7.4) along the ordinate.

Read off the calibration curve the concentration of boron in the blank (7.1), the concentration of boron in the test solution (6.2) and, if the test solution is coloured, the corrected concentration of the test solution. To calculate the latter, subtract the absorbance of the correction solution (6.3) from the absorbance of the test solution (6.2) and determine the corrected concentration of the test solution. Note the concentration of the test solution (6.2), with or without correction, (x_s) and of the blank (x_b).

The percentage of boron in the fertiliser is given by:

$$B\% = [(x_s - x_b) \times V \times D] / (M \times 10^4)$$

If Method 25c is used:

$$B\% = [(x_s - x_b) \times V \times 2D] / (M \times 10^4)$$

where:

B is the quantity of boron expressed as a percentage of the fertiliser;

x_s is the concentration ($\mu\text{g/ml}$) in the test solution (6.2) with or without correction;

x_b is the concentration ($\mu\text{g/ml}$) in the blank (7.1);

V is the volume in ml of extract obtained in accordance with Method 25a or 25b;

D is the factor corresponding to the dilution carried out in 6.2;

M is the mass in grams of the test sample taken in accordance with Method 25a or 25b.

Calculation of the dilution factor D: if (a_1) and (a_2) are successive aliquot portions and (v_1) and (v_2) are the volumes corresponding to their respective dilutions, the dilution factor is given by:

$$D = (v_1/a_1) \times (v_2/a_2).$$

25f.

DETERMINATION OF COBALT IN FERTILISER EXTRACTS BY ATOMIC ABSORPTION SPECTROMETRY

SCOPE

1. This method describes a procedure for determining cobalt in fertiliser extracts.

FIELD OF APPLICATION

2. This procedure is applicable to analysing samples of fertilisers extracted by Methods 25a and 25b for which a declaration of total and/or water-soluble cobalt is required.

PRINCIPLE

3. After suitable treatment and dilution of the extracts, the cobalt content is determined by atomic absorption spectrometry.

REAGENTS

Hydrochloric acid solution, about 6M

Status: This is the original version (as it was originally made). This item of legislation is currently only available in its original format.

Hydrochloric acid solution, about 6M

4.—(4.1) See Method 25d (4.1).

Hydrochloric acid solution, about 0.5 M

(4.2) See Method 25d (4.2).

Lanthanum salt solutions (10 g of La per litre)

(4.3) See Method 25d (4.3).

Cobalt calibration solutions

Cobalt stock solution (1000 µg/ml)

(4.4.1) In a 250 ml beaker, weigh to the nearest 0.1 mg, 1 g of cobalt, add 25 ml of 6 M hydrochloric acid (4.1) and heat on a hot plate until the cobalt is completely dissolved. When cool, transfer quantitatively to a 1000 ml volumetric flask. Make up to volume with water and mix thoroughly.

Cobalt working solution (100 µg/ml)

(4.4.2) Place 10 ml of the stock solution (4.4.1) in a 100 ml volumetric flask. Make up to volume with 0.5 M hydrochloric acid solution (4.2) and mix thoroughly.

APPARATUS

5. Atomic absorption spectrometer: see Method 25d (5). The instrument must be equipped with a source of rays characteristic of cobalt (240.7 nm). The spectrometer must allow background correction to be made.

PREPARATION OF THE SOLUTION TO BE ANALYSED

Cobalt extract solution

Cobalt extract solution

6.—(6.1) See Methods 25a and/or 25b and, if appropriate, 25c.

Preparation of the test solution

(6.2) See Methods 25d (6.2). The test solution must contain 10% (v/v) of a lanthanum salt solution (4.3).

PROCEDURE

Preparation of the blank solution

Preparation of the blank solution

7.—(7.1) See Method 25d (7.1). The blank must contain 10% (v/v) of the lanthanum salt solution used in 6.2.

Preparation of the calibration solutions

(7.2) See Method 25d (7.2).

For an optimum determination range of 0 to 5 µg/ml of cobalt, place 0, 0.5, 1, 2, 3, 4 and 5 ml respectively of working solution (4.4.2) in a series of 100 ml volumetric flasks. If necessary adjust the hydrochloric acid concentration as closely as possible to that of the test solution. Add to each flask 10 ml of the lanthanum salt solution used in 6.2. Make up to 100 ml with 0.5 M hydrochloric acid solution (4.2) and mix thoroughly. These solutions contain 0, 0.5, 1, 2, 3, 4 and 5 µg/ml respectively of cobalt.

Determination

(7.3) See Method 25d (7.3). Prepare the spectrometer (5) for measurement at a wavelength of 240.7 nm.

EXPRESSION OF RESULTS

8. See Method 25d (8).

The percentage of cobalt in the fertiliser is given by:

$$\text{Co \%} = [(x_s - x_b) \times V \times D] / (M \times 10^4)$$

If Method 25c is used:

$$\text{Co \%} = [(x_s - x_b) \times V \times 2D] / (M \times 10^6)$$

where:

Co is the quantity of cobalt expressed as a percentage of the fertiliser;

x_s is the concentration in µg/ml of the Co in the test solution (6.2);

x_b is the concentration in µg/ml of the Co in the blank solution (7.1);

V is the volume in ml of extract obtained in accordance with Method 25a or 25b;

D is the factor corresponding to the dilution carried out in 6.2;

M is the mass in grams of the test sample taken in accordance with Method 25a or 25b.

Calculation of the dilution factor D: if $(a_1), (a_2), (a_3), \dots, (a_i)$ and (a) are aliquot portions and $(v_1), (v_2), (v_3), \dots, (v_i)$ and (100) are the volumes in ml corresponding to their respective dilutions, the dilution factor D is given by:

$$D = (v_1/a_1) \times (v_2/a_2) \times (v_3/a_3) \times \dots \times (v_i/a_i) \times (100/a).$$

25g.

DETERMINATION OF COPPER IN FERTILISER EXTRACTS BY ATOMIC ABSORPTION SPECTROMETRY

SCOPE

1. This method describes a procedure for determining copper in fertiliser extracts.

FIELD OF APPLICATION

2. This procedure is applicable to analysing samples of fertilisers extracted by Methods 25a and 25b for which a declaration of total and/or water-soluble copper is required.

Status: This is the original version (as it was originally made). This item of legislation is currently only available in its original format.

PRINCIPLE

3. After suitable treatment and dilution of the extracts, the copper content is determined by atomic absorption spectrometry.

REAGENTS

Hydrochloric acid solution, about 6 M

Hydrochloric acid solution, about 6 M

4.—(4.1) See Method 25d (4.1).

Hydrochloric acid solution, about 0.5 M

(4.2) See Method 25d (4.2).

(4.3) Hydrogen peroxide solution (30% H₂O, $\rho = 1.11$ g/ml), free from trace elements.

Copper calibration solutions

Copper stock solution (1000 $\mu\text{g/ml}$)

(4.4.1) In a 250 ml beaker, weigh to the nearest 0.1 mg, 1 g of copper, add 25 ml of 6 M hydrochloric acid (4.1), add 5 ml hydrogen peroxide solution (4.3) and heat on a hot plate until the copper is completely dissolved. Transfer quantitatively to a 1 litre volumetric flask. Make up to volume with water and mix thoroughly.

Copper working solution (100 $\mu\text{g/ml}$)

(4.4.2) Place 20 ml of the stock solution (4.4.1) in a 200 ml volumetric flask. Make up to volume with 0.5 M hydrochloric acid solution (4.2) and mix thoroughly.

APPARATUS

5. Spectrometer equipped for atomic absorption: see Method 25d (5). The instrument must be fitted with a source of rays characteristic of copper (324.8 nm).

PREPARATION OF THE SOLUTION TO BE ANALYSED

Copper extract solution

Copper extract solution

6.—(6.1) See Methods 25a and/or 25b and, if appropriate, 25c.

Preparation of the test solution

(6.2) See Method 25d (6.2).

PROCEDURE

Preparation of blank solution

Preparation of blank solution

7.—(7.1) See Method 25d (7.1).

Preparation of calibration solutions

(7.2) See Method 25d (7.2).

For an optimum determination range of 0 to 5 µg/ml of copper, place 0, 0.5, 1, 2, 3, 4 and 5 ml respectively of working solution (4.4.2) in a series of 100 ml volumetric flasks. If necessary adjust the hydrochloric acid concentration as closely as possible to that of the test solution (6.2). Make up to 100 ml with 0.5 M hydrochloric acid solution (4.2) and mix thoroughly. These solutions contain 0, 0.5, 1, 2, 3, 4 and 5 µg/ml respectively of copper.

Determination

(7.3) See Method 25d (7.3). Prepare the spectrometer (5) for measurement at a wavelength of 324.8 nm.

EXPRESSION OF RESULTS

8. See Method 25d (8).

The percentage of copper in the fertiliser is given by:

$$\text{Cu \%} = [(x_s - x_b) \times V \times D] / (M \times 10^4)$$

If Method 25c is used:

$$\text{Cu \%} = [(x_s - x_b) \times V \times 2D] / (M \times 10^4)$$

where:

Cu is the quantity of copper expressed as percentage of the fertiliser;

x_s is the concentration in µg/ml of Cu in the test solution (6.2);

x_b is the concentration in µg/ml of Cu in the blank solution (7.1);

V is the volume in ml of extract obtained in accordance with Method 25a or 25b;

D is the factor of the dilution carried out in 6.2;

M is the mass in grams of the test sample taken in accordance with Method 25a or 25b.

Calculation of the dilution factor D: if (a_1) , (a_2) , (a_3) , . . . , (a_i) and (a) are aliquot portions and (v_1) , (v_2) , (v_3) , . . . , (v_i) and (100) are the volumes in ml corresponding to their respective dilutions, the dilution factor D is given by:

$$D = (v_1/a_1) \times (v_2/a_2) \times (v_3/a_3) \times \dots \times (v_i/a_i) \times (100/a).$$

25h.

DETERMINATION OF IRON IN FERTILISER EXTRACTS BY ATOMIC ABSORPTION SPECTROMETRY

SCOPE

1. This method describes a procedure for determining iron in fertiliser extracts.

FIELD OF APPLICATION

2. This procedure is applicable to analysing samples of fertilisers extracted by Methods 25a and 25b for which a declaration of total and/or water-soluble iron is required.

Status: This is the original version (as it was originally made). This item of legislation is currently only available in its original format.

PRINCIPLE

3. After suitable treatment and dilution of the extracts, the iron content is determined by atomic absorption spectrometry.

REAGENTS

Hydrochloric acid solution, about 6 M

Hydrochloric acid solution, about 6 M

4.—(4.1) See Method 25d (4.1).

Hydrochloric acid solution, about 0.5 M

(4.2) See Method 25d (4.2).

(4.3) Hydrogen peroxide solution (30% H₂O₂ ρ = 1.11 g/ml) free from trace element.

Lanthanum salt solutions (10 g of La per litre)

(4.4) See Method 25d (4.3).

Iron calibration solutions

Iron stock solution (1000 µg/ml)

(4.5.1) In a 500 ml beaker, weigh to the nearest 0.1 mg, 1 g of pure iron wire, add 200 ml of 6 M hydrochloric acid (4.1) and 15 ml of hydrogen peroxide solution (4.3). Heat on a hotplate until the iron is completely dissolved. When cool, transfer quantitatively to a 1 litre volumetric flask. Make up to volume with water and mix thoroughly.

Iron working solution (100 µg/ml)

(4.5.2) Place 20 ml of the stock solution (4.5.1) in a 200 ml volumetric flask. Make up to volume with the 0.5 M hydrochloric acid solution (4.2) and mix thoroughly.

APPARATUS

5. Atomic absorption spectrometer: see Method 25d (5). The instrument must be fitted with a source of rays characteristic of iron (248.3 nm).

PREPARATION OF THE SOLUTION TO BE ANALYSED

Iron extract solution

Iron extract solution

6.—(6.1) See Methods 25a and/or 25b and, if appropriate, 25c.

Preparation of the test solution

(6.2) See Method 25d (6.2). The test solution must contain 10% (v/v) of a lanthanum salt solution.

PROCEDURE

Preparation of blank solution

Preparation of blank solution

7.—(7.1) See Method 25d (7.1). The test solution must contain 10% (v/v) of the lanthanum salt solution used in 6.2.

Preparation of calibration solutions

(7.2) See Method 25d (7.2).

For an optimum determination range of 0 to 10 µg/ml of iron, place 0, 2, 4, 6, 8 and 10 ml respectively of working solution (4.5.2) in a series of 100 ml volumetric flasks. If necessary adjust the hydrochloric acid concentration as closely as possible to that of the test solution. Add 10 ml of the lanthanum salt solution used in 6.2. Make up to volume with 0.5 M hydrochloric acid solution (4.2) and mix thoroughly. These solutions contain 0, 2, 4, 6, 8 and 10 µg/ml respectively of iron.

Determination

(7.3) See Method 25d (7.3). Prepare the spectrometer (5) for measurement at a wavelength of 248.3 nm.

EXPRESSION OF RESULTS

8. See Method 25d (8).

The percentage of iron in the fertiliser is given by:

$$\text{Fe } \% = [(x_s - x_b) \times V \times D] / (M \times 10^4)$$

If Method 27d is used:

$$\text{Fe } \% = [(x_s - x_b) \times V \times 2D] / (M \times 10^4)$$

where:

Fe is the quantity of iron expressed as a percentage of the fertiliser;

x_s is the concentration in µg/ml of Fe in the test solution (6.2);

x_b is the concentration in µg/ml of Fe in the blank solution (7.1);

V is the volume in ml of extract obtained in accordance with Method 25a or 25b;

D is the factor of the dilution carried out in 6.2;

M is the mass in grams of the test sample taken in accordance with Method 25a or 25b.

Calculation of the dilution factor D: if (a_1), (a_2), (a_3), . . . , (a_i) and (a) are aliquot portions and (v_1), (v_2), (v_3), . . . , (v_i) and (100) are the volumes in ml corresponding to their respective dilutions, the dilution factor D is given by:

$$D = (v_1/a_1) \times (v_2/a_2) \times (v_3/a_3) \times \dots \times (v_i/a_i) \times (100/a).$$

25i.

DETERMINATION OF MANGANESE IN FERTILISER
EXTRACTS BY ATOMIC ABSORPTION SPECTROMETRY

SCOPE

1. This method describes a procedure for determining manganese in fertiliser extracts.

Status: This is the original version (as it was originally made). This item of legislation is currently only available in its original format.

FIELD OF APPLICATION

2. This procedure is applicable to analysing samples of fertilisers extracted by Methods 25a and 25b for which a declaration of total and/or water-soluble manganese is required.

PRINCIPLE

3. After suitable treatment and dilution of the extracts, the manganese level is determined by atomic absorption spectrometry.

REAGENTS

Hydrochloric acid solution, about 6 M

Hydrochloric acid solution, about 6 M

4.—(4.1) See Method 25d (4.1).

Hydrochloric acid solution, about 0.5 M

(4.2) See Method 25d (4.2).

Lanthanum salt solutions (10 g of La per litre)

(4.3) See Method 25d (4.3).

Manganese calibration solutions

Manganese stock solution (1000 µg/ml)

(4.4.1) In a 250 ml beaker, weigh to the nearest 0.1 mg, 1 g of manganese, add 25 ml of 6 M hydrochloric acid solution (4.1). Heat on a hot plate until the manganese is completely dissolved. When cool, transfer quantitatively to a 1000 ml volumetric flask. Make up to volume with water and mix thoroughly.

Manganese working solution (100 µg/ml)

(4.4.2) Place 20 ml of the stock solution (4.4.1) in a 200 ml volumetric flask. Make up to volume with the 0.5 M hydrochloric acid solution (4.2) and mix thoroughly.

APPARATUS

5. Atomic absorption spectrometer: see Method 25d (5). The apparatus must be fitted with a source of rays characteristic of manganese (279.6 nm).

PREPARATION OF THE SOLUTION TO BE ANALYSED

Manganese extract solution

Manganese extract solution

6.—(6.1) See Methods 25a and/or 25b and, if appropriate, 25c.

Preparation of the test solution

(6.2) See Method 25d (6.2). The test solution must contain 10% by volume of lanthanum salt solution (4.3).

PROCEDURE

Preparation of the blank solution

Preparation of the blank solution

7.—(7.1) See Method 25d (7.1). The blank solution must contain 10% by volume of the lanthanum salt solution used in 6.2.

Preparation of the calibration solutions

(7.2) See Method 25d (7.2).

For an optimum interval of 0 to 5 µg/ml of manganese, place 0, 0.5, 1, 2, 3, 4 and 5 ml, respectively, of the working solution (4.4.2) in a series of 100 ml volumetric flasks. Where necessary, adjust the hydrochloric acid concentration to bring it as close as possible to that of the test solution. To each flask add 10 ml of the lanthanum salt solution used in 6.2. Make up to 100 ml with 0.5 M hydrochloric acid solution (4.2) and mix thoroughly. These solutions contain 0, 0.5, 1, 2, 3, 4 and 5 µg/ml manganese respectively.

Determination

(7.3) See Method 25d (7.3). Prepare the spectrometer (5) for measurements at a wavelength of 279.6 nm.

EXPRESSION OF RESULTS

8. See Method 25d (8).

The percentage of manganese in the fertiliser is as follows:

$$\text{Mn \%} = [(x_s - x_b) \times V \times D] / (M \times 10^4)$$

If Method 25c has been used:

$$\text{Mn \%} = [(x_s - x_b) \times V \times 2D] / (M \times 10^4)$$

where:

Mn is the quantity of manganese expressed as a percentage of the fertiliser;

x_s is the concentration in µg/ml of the Mn in the test solution (6.2);

x_b is the concentration in µg/ml of the Mn in the blank solution (7.1);

V is the volume in ml of extract obtained in accordance with Method 25a or 25b;

D is the factor corresponding to the dilution performed in 6.2;

M is the mass in g of the test sample taken using Method 25a or 25b.

Calculation of dilution factor D: where (a_1) , (a_2) , (a_3) , . . . , (a_i) and (a) are aliquot portions and (v_1) , (v_2) , (v_3) , . . . , (v_i) and (100) the volumes in ml corresponding to their respective dilutions, the dilution factor D will be equal to:

$$D = (v_1/a_1) \times (v_2/a_2) \times (v_3/a_3) \times \dots \times (v_i/a_i) \times (100/a).$$

Status: This is the original version (as it was originally made). This item of legislation is currently only available in its original format.

25j.

DETERMINATION OF MOLYBDENUM IN FERTILISER EXTRACTS BY SPECTROMETRY OF A COMPLEX WITH AMMONIUM THIOCYANATE

SCOPE

1. This method describes a procedure for determining molybdenum in fertiliser extracts.

FIELD OF APPLICATION

2. This procedure is applicable to analysing samples of fertilisers extracted by Methods 25a and 25b for which a declaration of total and/or water-soluble molybdenum is required.

PRINCIPLE

3. Molybdenum^(v); forms a complex $[\text{MoO}(\text{SCN})_5]^-$ – in an acid medium with SCN^- ions. The complex is extracted with n-butyl acetate. Interfering ions such as those of iron remain in the aqueous phase. The yellow-orange colour is determined by molecular absorption spectrometry at 470 nm.

REAGENTS

Dilute hydrochloric acid solution (HCl), about 6 M

Dilute hydrochloric acid solution (HCl), about 6 M

- 4.—(4.1) See Method 25d (4.1).

Copper solution (70 mg/l) in 1.5 M hydrochloric acid

(4.2) Dissolve 275 mg of copper sulfate ($\text{CuSO}_4 \cdot 5\text{H}_2\text{O}$) weighed to within 0.1 mg in 250 ml of the 6 M hydrochloric acid solution (4.1) in a 1000 ml volumetric flask. Make up to volume with water and mix thoroughly.

Ascorbic acid solution (50 g/l)

(4.3) Dissolve 50 g of ascorbic acid ($\text{C}_6\text{H}_8\text{O}_6$) in water in a 1000 ml volumetric flask. Make up to volume with water, mix thoroughly and keep in a refrigerator.

n-butyl acetate

- (4.4)

Ammonium thiocyanate solution, 0.2 M

(4.5) Dissolve 15.224 g of NH_4SCN in water in a 1000 ml volumetric flask. Make up to volume with water; mix thoroughly and store in a dark-coloured bottle.

Stannous chloride solution (50 g/l) in 2 M hydrochloric acid

(4.6) This solution must be perfectly clear and prepared immediately before use. Very pure stannous chloride must be used otherwise the solution will not be clear.

To prepare 100 ml of solution, dissolve 5 g of $\text{SnCl}_2 \cdot 2\text{H}_2\text{O}$ in 35 ml of 6 M HCl solution (4.1). Add 10 ml of the copper solution (4.2). Make up to volume with water and mix thoroughly.

Molybdenum calibration solutions

Molybdenum stock solution (500 mg/ml)

- (4.7.1) Dissolve 0.920 g of ammonium molybdate $[(\text{NH}_4)_6\text{Mo}_7\text{O}_{24}\cdot 4\text{H}_2\text{O}]$; weighed to within 0.1 mg in the 6 M hydrochloric acid (4.1) in a 1 litre volumetric flask. Make up to volume with that solution and mix thoroughly.

molybdenum intermediate solution (25 mg/ml)

- (4.7.2) Place 25 ml of the stock solution (4.7.1) in a 500 ml volumetric flask. Make up to volume with 6M hydrochloric acid (4.1) and mix thoroughly.

Molybdenum working solution (2.5 mg/ml)

- (4.7.3) Place 10 ml of the intermediate solution (4.7.2) in a 100 ml volumetric flask. Make up to volume with 6 M hydrochloric acid (4.1) and mix thoroughly.

APPARATUS

5.—(5.1) Spectrometer fitted for molecular absorption with cells having a 20 mm optical path and set to a wavelength of 470 nm.

(5.2) 200 or 250 ml separating funnels.

PREPARATION OF THE SOLUTION TO BE ANALYSED

Molybdenum extract solution

Molybdenum extract solution

6.—(6.1) See Methods 25a and/or 25b and, if appropriate, 25c.

Preparation of the test solution

(6.2) Dilute an aliquot portion of the extract (6.1) with 6 M hydrochloric acid solution (4.1) so as to obtain an appropriate molybdenum concentration. Let D be the dilution factor.

Take an aliquot portion (a) from the extract solution containing 1 to 12 mg molybdenum and place it in the separating funnel (5.2). Make up to 50 ml with the 6 M hydrochloric acid solution (4.1).

PROCEDURE

Preparation of the blank solution

Preparation of the blank solution

7.—(7.1) Prepare a blank solution by repeating the whole procedure from the extraction stage, omitting only the test sample of fertiliser.

Preparation of the series of calibration solutions

(7.2) Prepare a series of at least six calibration solutions of increasing concentration corresponding to the optimum response range of the spectrometer.

For the interval 0-12.5 μg molybdenum, place 0, 1, 2, 3, 4 and 5 ml, respectively, of the working solution (4.7.3) in the separating funnels (5.2). Make up to 50 ml with 6 M hydrochloric acid (4.1). The funnels contain, respectively, 0, 2.5, 5, 7.5, 10 and 12.5 mg molybdenum.

Development and separation of the complex

Status: This is the original version (as it was originally made). This item of legislation is currently only available in its original format.

(7.3) To each separating funnel (6.2, 7.1 and 7.2), add in the following order:

- 10 ml of the copper solution (4.2);
- 20 ml of the ascorbic acid solution (4.3);

mix thoroughly and wait for two or three minutes. Then add:

- 10 ml of n-butyl acetate (4.4), using a precision pipette;
- 20 ml of the thiocyanate solution (4.5).

Shake for one minute to extract the complex into the organic phase; allow to separate; after the separation of the two phases, draw off the entire aqueous phase and discard it; then wash the organic phase with:

- 10 ml of the stannous chloride solution (4.6).

Shake for one minute. Allow to separate and draw off the entire aqueous phase. Remove the organic phase in a test tube; this will make it possible to collect the drops of water in suspension.

Determination

(7.4) Measure the absorbencies of the solutions obtained at 7.3 at a wavelength of 470 nm using the 0 mg/ml molybdenum calibration solution (7.2) as a reference.

EXPRESSION OF RESULTS

8. Construct the calibration curve by plotting the corresponding masses of molybdenum in the calibration solutions (7.2) expressed in mg along the abscissa and the corresponding values of the absorbencies (7.4) given by the spectrometer reading along the ordinate.

From this curve determine the mass of molybdenum in the test solution (6.2) and the blank solution (7.1). These masses are designated (x_s) and (x_b) respectively.

The percentage of molybdenum in the fertiliser is:

$$\text{Mo } \% = [(x_s - x_b) \times V/a \times D]/(M \times 10^4)$$

If Method 25c has been used:

$$\text{Mo } \% = [(x_s - x_b) \times V/a \times 2D]/(M \times 10^4)$$

where:

Mo is the quantity of molybdenum expressed as a percentage of the fertiliser;

a is the volume in ml of the aliquot taken from the last dilute solution (6.2);

x_s is the mass in μg of Mo in the test solution (6.2);

x_b is the mass in μg of Mo in the blank solution (7.1) the volume of which corresponds to the volume (a) of the aliquot of the test solution (6.2);

V is the volume in ml of the extract solution obtained in accordance with Method 25a or 25b;

D is the factor corresponding to the dilution performed in 6.2;

M is the mass in g of the test sample taken in accordance with Method 25a or 25b.

Calculation of the dilution factor D: where (a_1), (a_2) are successive aliquot portions and (v_1), (v_2) are the volumes corresponding to their respective dilutions, the dilution factor D will be:

$$D = (v_1/a_1) \times (v_2/a_2).$$

25k.

Determination of ZINC in Fertiliser Extracts by ATOMIC ABSORPTION SPECTROMETRY

SCOPE

1. This method describes a procedure for determining zinc in fertiliser extracts.

FIELD OF APPLICATION

2. This procedure is applicable to analysing samples of fertilisers extracted by Methods 25a and 25b for which a declaration of total and/or water-soluble zinc is required.

PRINCIPLE

3. After suitable treatment and dilution of the extracts, the zinc level is determined by atomic absorption spectrometry.

REAGENTS

Hydrochloric acid solution, about 6 M

Hydrochloric acid solution, about 6 M

- 4.—(4.1) See Method 25d (4.1).

Hydrochloric acid solution, about 0.5 M

- (4.2) See Method 25d (4.2).

Lanthanum salt solutions (10 g of La per litre)

- (4.3) See Method 25d (4.3).

Zinc calibration solutions

Zinc stock solution (1000 mg/ml)

- (4.4.1) In a 1 litre volumetric flask dissolve 1 g of zinc powder or flakes weighed to within 0.1 mg in 25 ml of 6 M hydrochloric acid (4.1). When completely dissolved, make up to volume with water and mix thoroughly.

Zinc working solution (100 mg/ml)

- (4.4.2) Place 20 ml of the stock solution (4.4.1) in a 200 ml volumetric flask. Make up to volume with 0.5 M hydrochloric acid solution (4.2) and mix thoroughly.

APPARATUS

5. Atomic absorption spectrometer: see Method 25d (5). The apparatus must be fitted with a source of rays characteristic of zinc (213.8 nm). The spectrometer must allow background correction to be made.

PREPARATION OF THE SOLUTION TO BE ANALYSED

Zinc extract solution

Status: This is the original version (as it was originally made). This item of legislation is currently only available in its original format.

Zinc extract solution

6.—(6.1) See Methods 25a and/or 25b and, if appropriate, 25c.

Preparation of the test solution

(6.2) See Method 25d (6.2). The test solution must contain 10% by volume of lanthanum salt solution.

PROCEDURE

Preparation of the blank solution

Preparation of the blank solution

7.—(7.1) See Method 25d (7.1). The blank solution must contain 10% by volume of the lanthanum salt solution used in 6.2.

Preparation of the calibration solutions

(7.2) See Method 25d (7.2).

For an optimum interval of 0 to 5 mg/ml of zinc, place 0, 0.5, 1, 2, 3, 4 and 5 ml, respectively, of the working solution (4.4.2) in a series of 100 ml volumetric flasks. Where necessary, adjust the concentration of hydrochloric acid to bring it as close as possible to that of the test solution. Add 10 ml of the lanthanum salt solution used in (6.2) to each volumetric flask. Make up to 100 ml with the 0.5 M hydrochloric acid solution (4.2) and mix thoroughly. These solutions contain, respectively, 0, 0.5, 1, 2, 3, 4 and 5 mg/ml of zinc.

Determination

(7.3) See Method 25d (7.3). Prepare the spectrometer (5) for measurements at a wavelength of 213.8 nm.

EXPRESSION OF RESULTS

8. See Method 25d (8).

The percentage of zinc in the fertiliser is:

$$\text{Zn \%} = [(x_s - x_b) \times V \times D] / (M \times 10^4)$$

If Method 25c has been used:

$$\text{Zn \%} = [(x_s - x_b) \times V \times 2D] / (M \times 10^4)$$

where:

Zn is the quantity of zinc expressed as a percentage of the fertiliser;

x_s is the mass in μg of Zn in the test solution (6.2);

x_b is the mass in μg of Zn in the blank solution (7.1);

V is the volume in ml of the extract solution obtained in accordance with Method 25a or 25b;

D is the factor corresponding to the dilution performed in 6.2;

M is the mass in g of the test sample taken in accordance with Method 25a or 25b.

Calculation of the dilution factor D: where (a_1) , (a_2) , (a_3) , . . . , (a_i) and (a) are successive aliquot portions and (v_1) , (v_2) , (v_3) , . . . , (v_i) and (100) are volumes corresponding to their respective dilutions, the dilution factor D will be:

$$D = (v_1/a_1) \times (v_2/a_2) \times (v_3/a_3) \times \dots \times (v_n/a_n) \times (100/a)$$

26.

TRACE ELEMENTS AT A CONCENTRATION GREATER THAN 10%

26a.

Extraction of Total Trace Elements

SCOPE

1. This method defines the procedure for extracting the following trace elements: total boron, total cobalt, total copper, total iron, total manganese, total molybdenum and total zinc. The aim is to carry out the minimum number of extractions, making use wherever possible of the same extract to determine the total level of each of the trace elements listed above.

FIELD OF APPLICATION

2. This procedure concerns fertilisers containing one or more of the following trace elements: boron, cobalt, copper, iron, manganese, molybdenum and zinc. It is applicable to each trace element, the declared content of which is more than 10%.

PRINCIPLE

3. Dissolution in boiling diluted hydrochloric acid.

Note:

The extraction is empirical and may not be quantitative depending on the product or the other constituents of the fertiliser. In particular, in the case of certain manganese oxides, the quantity extracted may be substantially smaller than the total quantity of manganese which the product contains. It is the responsibility of the fertiliser manufacturers to ensure that the declared content actually corresponds to the quantity extracted under the conditions pertaining to the method.

REAGENTS

Diluted hydrochloric acid (HCl) solution, about 6 M

Diluted hydrochloric acid (HCl) solution, about 6 M

4.—(4.1) Mix 1 volume of hydrochloric acid ($r = 1.18 \text{ g/ml}$) with one volume of water.

Concentrated ammonia solution (NH_4OH , $r = 0.9 \text{ g/ml}$)

(4.2)

APPARATUS

5.—(5.1) Electric hotplate with variable temperature control.

(5.2) pH meter

Note:

Status: This is the original version (as it was originally made). This item of legislation is currently only available in its original format.

Where the boron content of an extract is to be determined, do not use borosilicate glassware. As the method involves boiling, teflon or silica is preferable. Rinse the glassware thoroughly if it has been washed in detergents containing borates.

PREPARATION OF SAMPLE

6. See Method 1.

PROCEDURE

Test sample

Test sample

7.—(7.1) Take a quantity of fertiliser weighing 1 or 2 g depending on the declared content of element in the product. The following table shall be used to obtain a final solution which, after appropriate dilution, will be within the measuring range for each method. Samples should be weighed to within 1 mg.

Declared content of trace element in the fertiliser (%)	> 10-< 25	≥ 25
Mass of test sample (g)	2	1
Mass of element in the sample (mg)	> 200-< 500	≥ 250
Volume of extract V (ml)	500	500
Concentration of element in extract (mg/l)	> 400-<1000	≥ 500

Place the sample in a 250 ml beaker.

Preparation of the solution

(7.2) If necessary moisten the sample with a little water, add 10 ml of dilute hydrochloric acid (4.1) per gram of fertiliser carefully, in small amounts, then add about 50 ml of water. Cover the beaker with a watchglass and mix. Bring to the boil on the hotplate and boil for 30 minutes. Allow to cool, stirring occasionally. Transfer quantitatively to a 500 ml volumetric flask. Make up to volume with water and mix thoroughly. Filter through a dry filter into a dry container. Discard the first portion. The extract must be perfectly clear.

It is recommended that the determinations be carried out without delay on aliquot portions of the clear filtrate, if not the containers should be stoppered.

Note:

Extracts in which the boron content has to be determined.

Adjust the pH to between 4 and 6 with concentrated ammonia solution (4.2).

DETERMINATION

8. The determination of each trace element is to be carried out on the aliquot portions indicated in the method for each individual trace element.

Methods 26e, 26f, 26g, 26i and 26j cannot be used to determine elements present in a chelated or complexed form. In such cases Method 26c must be used prior to the determination.

In case of determinations by atomic absorption spectrometry (Methods 26h and 26k) such treatment may not be necessary.

26b.

Extraction of Water-Soluble Trace Elements

SCOPE

1. This method defines the procedure for extracting water-soluble forms of the following trace elements: boron, cobalt, copper, iron, manganese, molybdenum and zinc. The aim is to carry out the minimum number of extractions, making use wherever possible of the same extract to determine the level of each of the elements listed above.

FIELD OF APPLICATION

2. This procedure concerns fertilisers containing one or more of the following trace elements: boron, cobalt, copper, iron, manganese, molybdenum and zinc. It is applicable to each trace element, the declared content of which is more than 10%.

PRINCIPLE

3. The trace elements are extracted by shaking the fertiliser in water at $20 \pm 2^\circ\text{C}$.

Note:

The extraction is empirical and may not be quantitative.

REAGENTS

4.—(4.1) Diluted hydrochloric acid (HCl) solution, about 6 M

Mix 1 volume of hydrochloric acid ($r = 1.18 \text{ g/ml}$) with 1 volume of water.

APPARATUS

5.—(5.1) Rotary shaker set at about 35 to 40 rpm.

Note:

Where the boron content of an extract is to be determined, do not use borosilicate glassware. Teflon or silica is preferable for this extraction. Rinse the glassware thoroughly if it has been washed in detergents containing borates.

PREPARATION OF SAMPLE

6. See Method 1.

PROCEDURE

7.—(7.1) Test sample

Take a quantity of fertiliser weighing 1 or 2 g depending on the declared content of the product. The following table shall be used to obtain a final solution which, after appropriate dilution,

Status: This is the original version (as it was originally made). This item of legislation is currently only available in its original format.

will be within the measuring range for each method. The samples should be weighed to within 1 mg.

Declared content of trace element in the fertiliser (%)	> 10-< 25	≥ 25
Mass of test sample (g)	2	1
Mass of element in the sample (mg)	> 200-< 500	≥ 250
Volume of extract V (ml)	500	500
Concentration of element in extract (mg/l)	> 400-<1000	≥ 500

Place the sample in a 500 ml flask.

Preparation of the solution

(7.2) Add about 400 ml of water.

Stopper the flask well. Shake vigorously by hand to disperse the sample, then place the flask on the shaker and shake for 30 minutes.

Make up to volume with water and mix thoroughly.

Preparation of the test solution

(7.3) Filter immediately into a clean, dry flask. Stopper the flask. Carry out the determination immediately after filtering.

Note:

If the filtrate gradually becomes cloudy, make another extraction following 7.1 and 7.2 in a flask of volume V_e . Filter into a calibrated flask of volume W which has previously been dried and has received 5 ml of dilute hydrochloric acid (4.1). Stop the filtration at the exact moment when the calibration mark is reached. Mix thoroughly.

Under these conditions the value of V in the expression of results is:

$$V = V_e \times W / (W - 5)$$

The dilutions in the expression of results depend on this value of V .

DETERMINATION

8. The determination of each trace element is carried out on the aliquot portions indicated in the method for each individual trace element.

Methods 26e, 26f, 26g, 26i and 26j cannot be used to determine elements present in a chelated or complexed form. In such cases Method 26c must be used prior to the determination.

In the case of determinations by atomic absorption spectrometry (Methods 26h and 26k) such treatment may not be necessary.

26c.

REMOVAL OF ORGANIC COMPOUNDS FROM FERTILISER EXTRACTS

SCOPE

1. This method defines a procedure for removing organic compounds from fertiliser extracts.

FIELD OF APPLICATION

2. This procedure is applicable to analysing samples of fertilisers extracted by Methods 26a and 26b for which a declaration of total and/or water-soluble element is required.

Note:

The presence of small quantities of organic matter usually does not affect determinations by means of atomic absorption spectrometry.

PRINCIPLE

3. The organic compounds in an aliquot portion of the extract are oxidized with hydrogen peroxide.

REAGENTS

Diluted hydrochloric acid solution, about 0.5 M

Diluted hydrochloric acid solution, about 0.5 M

- 4.—(4.1) Mix 1 volume of hydrochloric acid ($\rho = 1.18 \text{ g/ml}$) with 20 volumes of water.

Hydrogen peroxide solution (30% H_2O_2 , $\rho = 1.11 \text{ g/ml}$), free from trace elements

- (4.2)

APPARATUS

5. Electric hotplate with variable temperature control.

PROCEDURE

6. Take 25 ml of extract solution obtained by Method 26a or 26b and place in a 100 ml beaker. In the case of Method 26b, add 5 ml of the dilute hydrochloric acid solution (4.1). Then add 5 ml of the hydrogen peroxide solution (4.2). Cover with a watchglass. Allow oxidation to occur at room temperature for about one hour, then bring gradually to boiling and boil for half an hour. If necessary, add a further 5 ml of the hydrogen peroxide to the solution once it has cooled. Then boil to remove the excess hydrogen peroxide. Allow to cool and transfer quantitatively to a 50 ml volumetric flask and make up to volume. Filter where necessary.

Account should be taken of this dilution when taking aliquot portions and calculating the percentage of trace element in the product.

Status: This is the original version (as it was originally made). This item of legislation is currently only available in its original format.

26d.

Determination of Trace Elements in Fertiliser Extracts by Atomic Absorption Spectrometry (General Procedure)

SCOPE

1. This method defines a general procedure for determining the levels of iron and zinc in fertiliser extracts by atomic absorption spectrometry.

FIELD OF APPLICATION

2. This procedure is applicable to analysing samples of fertiliser extracts obtained by Methods 26a and 26b for which a declaration of total and/or water-soluble iron or zinc is required. Adaptations of this procedure for the various trace elements are detailed in the methods defined specifically for each element.

Note:

In most cases the presence of small quantities of organic matter will not affect determinations by means of atomic absorption spectrometry.

PRINCIPLE

3. After the extract has been treated where necessary to reduce or eliminate interfering chemical species, the extract is diluted so that its concentration is in the optimum range of the spectrometer at a wavelength suitable for the trace element to be determined.

REAGENTS

Diluted hydrochloric acid solution (HCl), about 6 M

Diluted hydrochloric acid solution (HCl), about 6 M

4.—(4.1) Mix one volume of hydrochloric acid ($\rho = 1.18 \text{ g/ml}$) with 1 volume of water.

Diluted hydrochloric acid solution (HCl), about 0.5 M

(4.2) Mix one volume of hydrochloric acid ($\rho = 1.18 \text{ g/ml}$) with 20 volumes of water.

Lanthanum salt solutions (10 g of La per litre).

(4.3) This reagent is used for determinations of iron and zinc. Lanthanum is added to the extract to eliminate chemical interferences in the air-acetylene flame. It can be prepared either:

- (a) with lanthanum oxide dissolved in hydrochloric acid (4.1). Place 11.73 g of lanthanum oxide (La_2O_3) in 150 ml of water in a 1 litre volumetric flask and add 120 ml of 6 M hydrochloric acid (4.1). Allow to dissolve and then make up to 1 litre with water and mix thoroughly. This solution is approximately 0.5 M in hydrochloric acid; or
- (b) with solutions of lanthanum chloride, sulfate or nitrate.

Place 26.7 g of lanthanum chloride heptahydrate ($\text{LaCl}_3 \cdot 7\text{H}_2\text{O}$) or 31.2 g of lanthanum nitrate hexahydrate ($\text{La}(\text{NO}_3)_3 \cdot 6\text{H}_2\text{O}$) or 26.2 g of lanthanum sulfate nonahydrate ($\text{La}_2(\text{SO}_4)_3 \cdot 9\text{H}_2\text{O}$) in 150 ml of water in a 1 litre volumetric flask, then add 85 ml of 6 M hydrochloric acid (4.1). Allow to dissolve and then make up to 1 litre with water. Mix thoroughly. This solution is approximately 0.5 M in hydrochloric acid.

Calibration solutions

(4.4) For the preparation of these, see the individual methods of determination for each trace element.

APPARATUS

5. Atomic absorption spectrometer fitted with sources emitting radiation characteristic of trace elements to be determined.

The analyst must follow the manufacturer's instructions and be familiar with the apparatus. The apparatus must allow background correction so that it can be used whenever necessary (e.g. Zn). The gases to be used are air and acetylene.

PREPARATION OF THE SOLUTION TO BE ANALYSED

Preparation of extract solutions containing the elements to be determined

Preparation of extract solutions containing the elements to be determined

6.—(6.1) See Method 26a and/or 26b and, if appropriate, 26c.

Treatment of the test solution

(6.2) Dilute an aliquot portion of the extract obtained by Method 26a, 26b or 26c with water and/or hydrochloric acid (4.1) or (4.2) so as to obtain, in the final solution for measurement, a concentration of the element to be determined that is appropriate to the calibration range used (7.2) and a hydrochloric acid concentration of at least 0.5 M and not more than 2.5 M. This operation may require one or more successive dilutions.

The final solution has to be obtained by placing an aliquot portion of the diluted extract in a 100 ml volumetric flask. Let the volume of this aliquot portion be (a) ml. Add 10 ml of the lanthanum salt solution (4.3). Make up to volume with 0.5 M hydrochloric acid solution (4.2) and mix thoroughly. Let D be the dilution factor.

PROCEDURE

Preparation of a blank solution

Preparation of a blank solution

7.—(7.1) Prepare a blank solution by repeating the whole procedure from the extraction stage, omitting only the test sample of fertiliser.

Preparation of calibration solutions

(7.2) From the working calibration solution prepared using the method given for each individual trace element, prepare in 100 ml volumetric flasks a series of at least five calibration solutions of increasing concentration within the optimum measuring range of the spectrometer. If necessary, adjust the concentration of hydrochloric acid to bring it as close as possible to that of the diluted test solution (6.2). Add 10 ml of the same lanthanum salt solution (4.3) as used in (6.2). Make up to volume with the 0.5 M hydrochloric acid solution (4.2) and mix thoroughly.

Determination

(7.3) Prepare the spectrometer (5) for the determination and adjust to the wavelength given in the method for the individual trace element concerned.

Status: This is the original version (as it was originally made). This item of legislation is currently only available in its original format.

Spray three times in succession the calibration solutions (7.2), the test solution (6.2) and the blank solution (7.1), noting each result and flushing the instrument with distilled water between individual sprayings.

Construct the calibration curve by plotting the average spectrometer reading for each calibration solution (7.2) along the ordinate and the corresponding concentration of the element, expressed in mg/ml, along the abscissa.

From this curve, determine the concentrations of the relevant trace element in the test solution x_s (6.2) and in the blank solution x_b (7.1), expressing these concentrations in μg per ml.

EXPRESSION OF RESULTS

8. The percentage of trace element (E) in the fertiliser is given by:

$$E (\%) = [(x_s - x_b) \times V \times D] / (M \times 10^4)$$

If Method 26c has been used:

$$E (\%) = [(x_s - x_b) \times V \times 2D] / (M \times 10^4)$$

where:

E is the amount of the trace element determined, expressed as a percentage of the fertiliser;

x_s is the concentration of the Fe or Zn in the test solution (6.2), in $\mu\text{g}/\text{ml}$;

x_b is the concentration of the Fe or Zn in the blank solution (7.1), in $\mu\text{g}/\text{ml}$;

V is the volume of the extract obtained by Method 26a or 26b, in ml;

D is the factor corresponding to the dilution carried out in (6.2);

M is the mass of the test sample taken in accordance with Method 26a or 26b in grams.

Calculation of dilution factor D:

If (a_1) , (a_2) , (a_3) , . . . , (a_i) and (a) are the aliquot portions and (v_1) , (v_2) , (v_3) , . . . , (v_i) and (100) are the volumes in ml corresponding to their respective dilutions, the dilution factor D will be equal to:

$$D = (v_1/a_1) \times (v_2/a_2) \times (v_3/a_3) \times \dots \times (v_i/a_i) \times (100/a).$$

26e.

Determination of BORON in Fertiliser ExtrACTS BY MEANS OF ACIDIMETRIC TITRATION

SCOPE

1. This method defines a procedure for determining the boron content in fertiliser extracts.

FIELD OF APPLICATION

2. This procedure is applicable to extracts from samples of fertilisers obtained by Method 26a or Method 26b and for which a declaration of total and/or water-soluble boron content is required.

PRINCIPLE

3. A mannitoboric complex is formed by the following reaction of the borate with mannitol:

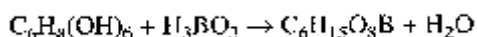

The complex is titrated with sodium hydroxide solution to a pH of 6.3.

REAGENTS

Methyl red indicator solution

Methyl red indicator solution

4.—(4.1) Dissolve 0.1 g of methyl red ($C_{15}H_{15}N_3O_2$) in 50 ml of ethanol (95% in a 100 ml) volumetric flask. Make up the volume to 100 ml with water. Mix thoroughly.

Diluted hydrochloric acid solution, about 0.5 M

(4.2) Mix 1 volume of hydrochloric acid HCl ($\rho = 1.18$ g/ml) with 20 volumes of water.

Sodium hydroxide solution, about 0.5 M

(4.3) Must be free of carbon dioxide. Dissolve 20 g of sodium hydroxide (NaOH) in pellet form in a 1 litre volumetric flask containing about 800 ml of boiled water. When the solution has cooled, make up to 1000 ml with boiled water and mix thoroughly.

Standard sodium hydroxide solution, about 0.025 M

(4.4) Must be free of carbon dioxide. Dilute the 0.5 M sodium hydroxide solution (4.3) 20 times with boiled water and mix thoroughly. The value of the solution expressed as boron (B) is to be determined (see paragraph 9).

Boron calibration solution (100 mg/ml B)

(4.5) Dissolve 0.5719 g of boric acid (H_3BO_3), weighed to the nearest 0.1 mg, in water in a 1 litre volumetric flask. Make up to volume with water and mix thoroughly. Transfer to a plastic bottle for storage in a refrigerator.

(4.6) D-mannitol ($C_6H_{14}O_6$) powder.

(4.7) Sodium chloride (NaCl).

APPARATUS

5.—(5.1) pH meter with glass electrode.

(5.2) Magnetic stirrer.

(5.3) 400 ml beaker with teflon rod.

PREPARATION OF THE SOLUTION TO BE ANALYSED

Preparation of the boron solution

Preparation of the boron solution

6.—(6.1) See Methods 26a, 26b and, if appropriate, 26c.

PROCEDURE

Determination

Determination

7.—(7.1) Place in a 400 ml beaker (5.3) an aliquot portion (a) of the extract (6.1) containing 2 to 4 mg B. Add 150 ml of water.

Status: This is the original version (as it was originally made). This item of legislation is currently only available in its original format.

Add several drops of the methyl red indicator solution (4.1).

In the case of extraction with Method 26b, acidify by adding 0.5 M hydrochloric acid (4.2) up to the point of change of the indicator solution, then add a further 0.5 ml of 0.5 M hydrochloric acid (4.2).

After adding 3 g of sodium chloride (4.7), bring to boiling to drive off the carbon dioxide. Allow to cool. Place the beaker on the magnetic stirrer (5.2) and insert the precalibrated pH meter electrodes (5.1).

Adjust the pH to exactly 6.3, first with the 0.5 M sodium hydroxide solution (4.3), then with the 0.025 M solution (4.4).

Add 20 g of D-mannitol (4.6), dissolve completely and mix thoroughly. Titrate with the 0.025 M sodium hydroxide solution (4.4) to pH 6.3 (at least 1 minute stability). Let x_1 be the volume required.

BLANK SOLUTION

8. Prepare a blank solution by repeating the whole procedure from the preparation of solution stage, omitting only the fertiliser. Let x_0 be the volume required.

BORON (B) VALUE OF THE SODIUM HYDROXIDE SOLUTION (4.4)

9. Transfer by pipette 20 ml (2.0 mg B) of the calibration solution (4.5), into a 400 ml beaker and add several drops of methyl red indicator solution (4.1). Add 3 g of sodium chloride (4.7) and the hydrochloric acid solution (4.2) up to the point of change of the indicator solution (4.1).

Make up the volume to about 150 ml and bring gradually to the boil so as to eliminate carbon dioxide. Allow to cool. Place the beaker on the magnetic stirrer (5.2) and insert the precalibrated pH meter electrodes (5.1). Adjust the pH to exactly 6.3, first with the 0.5 M sodium hydroxide solution (4.3), then with the 0.025 M solution (4.4).

Add 20 g of D-mannitol (4.6), dissolve completely and mix thoroughly. Titrate with the 0.025 M sodium hydroxide solution (4.4) to pH 6.3 (at least 1 minute stability). Let x_1 be the volume required.

Prepare a blank solution in the same way, substituting 20 ml of water for the calibration solution. Let V_0 be the volume required.

The boron value (F) in mg/ml of the standard NaOH solution (4.4) is as follows:

$$F \text{ (in mg/ml)} = 2/(V_1 - V_0)$$

1 ml of exactly 0.025 M sodium hydroxide solution corresponds to 0.27025 mg B.

EXPRESSION OF RESULTS

10. The percentage of boron in fertiliser is given by:

$$B\% = \frac{(x_1 - x_0) \times F \times V}{10 \times a \times M}$$

where:

B% is the percentage of boron in the fertiliser;

x_1 is the volume, in ml, of the 0.025 M sodium hydroxide solution (4.4);

x_0 is the volume, in ml, of the 0.025 M sodium hydroxide solution M (4.4);

F is the boron (B) value, in mg/ml, of the 0.025 M sodium hydroxide solution (4.4);

V is the volume, in ml, of the extract solution obtained in accordance with Method 26a or 26b;

a is the volume, in ml, of the aliquot (7.1) taken from the extract solution (6.1);

M is the mass, in grams, of the test sample taken in accordance with Method 26a or 26b.

26f.

Determination of COBALT in Fertiliser Extracts by THE GRAVIMETRIC METHOD WITH 1-NITROSO-2-NAPHTHOL

SCOPE

1. This method defines a procedure for determining cobalt in fertiliser extracts.

FIELD OF APPLICATION

2. This procedure is applicable to extracts from samples of fertilisers obtained by Method 26a or Method 26b for which a declaration of cobalt content is required.

PRINCIPLE

3. Cobalt^{III} combines with 1-nitroso-2-naphthol to give a red precipitate $\text{Co}(\text{C}_{10}\text{H}_6\text{ONO})_3 \cdot 2\text{H}_2\text{O}$. After the cobalt present in the extract has been brought to the cobalt^{III} state, the cobalt is precipitated in an acetic acid medium by a solution of 1-nitroso-2-naphthol. After filtration, the precipitate is washed and dried to constant weight and then weighed as $\text{Co}(\text{C}_{10}\text{H}_6\text{ONO})_3 \cdot 2\text{H}_2\text{O}$.

REAGENTS

- 4.—(4.1) Hydrogen peroxide solution (H_2O_2 $\rho = 1.11$ g/ml) 30%.

Sodium hydroxide solution, about 2 M

- (4.2) Dissolve 8 g of sodium hydroxide in pellet form in 100 ml of water.

Diluted hydrochloric acid solution, about 6 M

- (4.3) Mix one volume of hydrochloric acid ($\rho = 1.18$ g/ml) with 1 volume of water.

4.4

Acetic acid (99.7% CH_3COOH) ($\rho = 1.05$ g/ml)

Acetic acid solution (1:2), about 6 M

- (4.5) Mix one volume of acetic acid (4.4) with 2 volumes of water.

(4.6) Solution of 1-nitroso-2-naphthol in 100 ml of acetic acid (4.4). Add 100 ml of lukewarm water. Mix thoroughly. Filter at once. The solution obtained must be used immediately.

APPARATUS

- 5.—(5.1) Filter crucible P 16/ISO 4793, porosity 4, capacity 30 or 50 ml.

- (5.2) Drying oven at $130 \pm 2^\circ\text{C}$.

PREPARATION OF THE SOLUTION TO BE ANALYSED

Preparation of the cobalt solution

Status: This is the original version (as it was originally made). This item of legislation is currently only available in its original format.

Preparation of the cobalt solution

6.—(6.1) See Methods 26a or 26b.

Preparation of the solution to be analysed

(6.2) Place the aliquot portion of the extract containing not more than 20 mg Co in a 400 ml beaker. If the extract is obtained according to Method 26b, acidify with five drops of hydrochloric acid (4.3). Add about 10 ml of the hydrogen peroxide solution (4.1). Allow the oxidant to react in the cold state for 15 minutes, then make up to about 100 ml with water. Cover the beaker with a watchglass. Bring the solution to boiling point and allow to boil for about 10 minutes. Cool. Make alkaline with the sodium hydroxide solution (4.21) drop by drop until black cobalt hydroxide begins to precipitate.

PROCEDURE

7. Add 10 ml of acetic acid (4.4) and make up the solution with water to about 200 ml. Heat until boiling. Using a burette, add 20 ml of the 1-nitroso-2-naphthol solution (4.6) drop by drop, stirring constantly. Complete by vigorous stirring to make the precipitate coagulate.

Filter through a previously weighed filter crucible (5.1), taking care not to clog up the crucible. With this in mind, ensure that liquid is left above the precipitate throughout the filtration process.

Wash the beaker with dilute acetic acid (4.5) to remove all the precipitate, wash the precipitate on the filter with dilute acetic acid (4.5) and then three times with hot water.

Dry in an oven (5.2) at $130 \pm 2^\circ\text{C}$ until constant weight is achieved.

EXPRESSION OF RESULTS

8. 1 mg of Co $(\text{C}_{10}\text{H}_6\text{ONO})_3 \cdot 2\text{H}_2\text{O}$ precipitate corresponds to 0.096381 mg Co.

The percentage of cobalt (Co) in the fertiliser is given by:

$$\text{Co (\%)} = X \times 0.096381 \times \frac{V \times D}{a \times M}$$

where:

X is the mass in mg of the precipitate;

V is the volume in ml of the extract solution obtained in accordance with Method 26a or Method 26b;

a is the volume in ml of the aliquot taken from the last dilution;

D is the dilution factor of this aliquot;

M is the mass in g of the test sample.

26g.

Determination of COPPER in Fertiliser Extracts by THE TITRIMETRIC METHOD

SCOPE

1. This method defines a procedure for determining copper in fertiliser extracts.

FIELD OF APPLICATION

2. This procedure is applicable to extracts from samples of fertilisers obtained by Method 26a or Method 26b for which a declaration of copper content is required.

PRINCIPLE

3. The cupric ions are reduced in an acidic medium with potassium iodide:



The iodine released in this way is titrated with a standard sodium thiosulfate solution in the presence of starch as an indicator in accordance with:

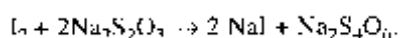

REAGENTS

4.—(4.1) Nitric acid (HNO_3 $\rho = 1.40$ g/ml).

(4.2) Urea [$(\text{NH}_2)_2\text{CO}$].

Ammonium bifluoride (NH_4HF_2) solution (10% w/v)

(4.3) Keep the solution in a plastic container.

Ammonium hydroxide solution (1 + 1)

(4.4) Mix 1 volume of ammonia (NH_4OH , $\rho = 0.9$ g/ml) with 1 volume of water.

Sodium thiosulfate standard solution

(4.5) Dissolve 7.812 g of sodium thiosulfate pentahydrate ($\text{Na}_2\text{S}_2\text{O}_3 \cdot 5\text{H}_2\text{O}$) with water in a litre volumetric flask. This solution must be prepared so that 1 ml = 2 mg Cu. For stabilization, add several drops of chloroform. The solution must be kept in a glass container and protected from direct light.

(4.6) Potassium iodide (KI).

Potassium thiocyanate (KSCN) solution (25% w/v)

(4.7) Keep this solution in a plastic flask.

Starch solution (about 0.5%)

(4.8) Place 2.5 g of starch in a 600 ml beaker. Add about 500 ml of water. Boil while stirring. Cool to ambient temperature. The solution has a short preservation period. Its preservation can be extended by adding about 10 mg of mercury iodide.

PREPARATION OF THE SOLUTION TO BE ANALYSED

5. Preparation of the copper solution.

See Methods 26a and 26b.

PROCEDURE

Preparation of the solution for titration

Preparation of the solution for titration

Status: This is the original version (as it was originally made). This item of legislation is currently only available in its original format.

6.—(6.1) Place an aliquot portion of the solution containing not less than 20 mg Cu in a 500 ml Erlenmeyer flask.

Drive off any excess oxygen present by boiling briefly. Make up to volume of about 100 ml water. Add 5 ml of nitric acid (4.1), bring to boiling and allow to boil for about half a minute.

Remove the Erlenmeyer flask from the heating apparatus, add about 3 g of urea (4.2) and resume boiling for about half a minute.

Remove from the heating apparatus and add 200 ml of cold water. Where necessary, cool the contents of the Erlenmeyer flask to ambient temperature.

Gradually add ammonium hydroxide solution (4.4) until the solution becomes blue, then add 1 ml in excess.

Add 50 ml of ammonium bifluoride solution (4.3) and mix.

Add 10 g of potassium iodide (4.6) and allow it to dissolve.

Titration of the solution

(6.2) Place the Erlenmeyer flask on a magnetic stirrer. Insert the rod into the Erlenmeyer flask and adjust the stirrer to the desired speed.

Using a burette, add standard sodium thiosulfate solution (4.5) until the brown colour of the iodine released from the solution becomes less intense.

Add 10 ml of the starch solution (4.8).

Continue to titrate with the sodium thiosulfate solution (4.5) until the purple colour has almost disappeared.

Add 20 ml of the potassium thiocyanate solution (4.7) and continue titration until the violet blue colour has completely disappeared.

Note the volume of thiosulfate solution employed.

EXPRESSION OF RESULTS

7. 1 ml of standard sodium thiosulfate solution (4.5) corresponds to 2 mg Cu.

The percentage of copper in the fertiliser is given by:

$$\text{Cu (\%)} = X \times \frac{V}{a \times M \times 5}$$

where:

X is the volume in ml of the sodium thiosulfate solution used;

V is the volume in ml of the extract solution in accordance with Methods 26a and 26b;

a is the volume in ml of the aliquot portion;

M is the mass in g of the test sample treated in accordance with Methods 26a or 26b.

26h.

Determination of IRON in Fertiliser Extracts by ATOMIC ABSORPTION Spectrometry

SCOPE

1. This method describes a procedure for determining iron in fertiliser extracts.

FIELD OF APPLICATION

2. This procedure is applicable to extracts from samples of fertilisers obtained by Methods 26a and 26b for which a declaration of total and/or water-soluble iron is required.

PRINCIPLE

3. After suitable treatment and dilution of the extract, the iron content is determined by atomic absorption spectrometry.

REAGENTS

Hydrochloric acid solution, about 6 M

Hydrochloric acid solution, about 6 M

4.—(4.1) See Method 26d (4.1).

Hydrochloric acid solution, about 0.5 M

(4.2) See Method 26d (4.2).

(4.3) Hydrogen peroxide solution (30% H₂O₂ ρ = 1.11 g/ml) free from trace elements.

Lanthanum salt solutions (10 g of La per litre)

(4.4) See Method 26d (4.3).

Iron calibration solution

Iron stock solution (1000 µg/ml)

(4.5.1) In a 500 ml beaker, weigh to the nearest 0.1 mg, 1 g of pure iron wire, add 200 ml of 6 M hydrochloric acid (4.1) and 15 ml of hydrogen peroxide solution (4.3). Heat on a hotplate until the iron is completely dissolved. When cool, transfer quantitatively to a 1 litre volumetric flask. Make up to volume with water and mix thoroughly.

Iron working solution (100 µg/ml)

(4.5.2) Place 20 ml of the stock solution (4.5.1) in a 200 ml volumetric flask. Make up to volume with the 0.5 M hydrochloric acid solution (4.2) and mix thoroughly.

APPARATUS

5. Atomic absorption spectrometer: see Method 26d (5). The instrument must be fitted with a source of rays characteristic of iron (248.3 nm).

PREPARATION OF THE SOLUTION TO BE ANALYSED

Iron extract solution

Iron extract solution

6.—(6.1) See Methods 26a and/or 26b and, if appropriate, 26c.

Preparation of the test solution

(6.2) See Method 26d (6.2). The test solution must contain 10% (v/v) of a lanthanum salt solution.

Status: This is the original version (as it was originally made). This item of legislation is currently only available in its original format.

PROCEDURE

Preparation of the blank solution

Preparation of the blank solution

7.—(7.1) See Method 26d (7.1). The blank solution must contain 10% (v/v) of the lanthanum salt solution used in 6.2.

Preparation of calibration solutions

(7.2) See Method 26d (7.2).

For an optimum determination range of 0 to 10 µg/ml of iron, place 0, 2, 4, 6, 8 and 10 ml respectively of working solution (4.5.2) in a series of 100 ml volumetric flasks. If necessary adjust the hydrochloric acid concentration as closely as possible to that of the test solution. Add 10 ml of the lanthanum salt solution used in 6.2. Make up to volume with 0.5 M hydrochloric acid solution (4.2) and mix thoroughly. These solutions contain 0, 2, 4, 6, 8 and 10 µg/ml respectively of iron.

Determination

(7.3) See Method 26d (7.3). Prepare the spectrometer (5) for measurement at a wavelength of 248.3 nm.

EXPRESSION OF RESULTS

8. See Method 26d (8).

The percentage of iron in the fertiliser is given by:

$$\text{Fe } \% = [(X_s - X_b) \times V \times D] / (M \times 10^4)$$

If Method 26c is used:

$$\text{Fe } \% = [(X_s - X_b) \times V \times 2D] / (M \times 10^4)$$

where:

Fe is the quantity of iron expressed as a percentage of the fertiliser;

X_s is the concentration in µg/ml of the test solution (6.2);

X_b is the concentration in µg/ml of the blank solution (7.1);

V is the volume in ml of extract obtained in accordance with Method 26a or 26b;

D is the factor of the dilution carried out in 6.2;

M is the mass in grams of the test sample taken in accordance with Method 26a or 26b.

Calculation of the dilution factor D: if (a_1) , (a_2) , (a_3) , . . . , (a_i) and (a) are aliquot portions and (v_1) , (v_2) , (v_3) , . . . , (v_i) and (100) are the volumes in ml corresponding to their respective dilutions, the dilution factor D is given by:

$$D = (v_1/a_1) \times (v_2/a_2) \times (v_3/a_3) \times \dots \times (v_i/a_i) \times (100/a).$$

26i.

Determination of MANGANESE in Fertiliser Extracts by TITRATION

SCOPE

1. This method describes a procedure for determining manganese in fertiliser extracts.

FIELD OF APPLICATION

2. This procedure is applicable to extracts from samples of fertilisers obtained by Methods 26a and 26b for which a declaration of manganese is required.

PRINCIPLE

3. If chloride ions are present in the extract, they are driven off by boiling with sulfuric acid. The manganese is oxidized by sodium bismuthate in a nitric acid medium. The permanganate formed is reduced by an excess of ferrous sulfate. This excess is titrated with a potassium permanganate solution.

REAGENTS

- 4.—(4.1) Concentrated sulfuric acid (H_2SO_4 , $\rho = 1.84 \text{ g/ml}$).

Sulfuric acid, about 9 M

- (4.2) Carefully mix 1 volume of concentrated sulfuric acid (4.1) with 1 volume of water.

Nitric acid, 6 M

- (4.3) Mix 3 volumes of nitric acid (HNO_3 , $\rho = 1.40 \text{ g/ml}$) with 4 volumes of water.

Nitric acid, 0.3 M

- (4.4) Mix 1 volume of 6 M nitric acid with 19 volumes of water.

- (4.5) Sodium bismuthate (NaBiO_3) (85%).

- (4.6) Kieselguhr.

- (4.7) Orthophosphoric acid, 15 M (H_3PO_4 , $\rho = 1.71 \text{ g/ml}$).

Ferrous sulfate solution, 0.15 M

- (4.8) Dissolve 41.6 g of ferrous sulfate heptahydrate ($\text{FeSO}_4 \cdot 7 \text{ H}_2\text{O}$) in a 1 litre volumetric flask.

Add 25 ml of concentrated sulfuric acid (4.1) and 25 ml phosphoric acid (4.7). Make up to 1000 ml. Mix.

Potassium permanganate solution, 0.02 M

- (4.9) Weigh out 3.160 g of potassium permanganate (KMnO_4) to within 0.1 mg. Dissolve and make up 1000 ml with water.

Silver nitrate solution, 0.1 M

- (4.10) Dissolve 1.7 g of silver nitrate (AgNO_3) in water and make up to 100 ml.

Status: This is the original version (as it was originally made). This item of legislation is currently only available in its original format.

APPARATUS

5.—(5.1) Filter crucible P16/ISO 4793, porosity 4, capacity 50 ml, mounted on a 500 ml filtration flask.

(5.2) Magnetic stirrer.

PREPARATION OF THE SOLUTION TO BE ANALYSED

Manganese extract solution

Manganese extract solution

6.—(6.1) See Methods 26a and 26b. If it is not known whether chloride ions are present, perform a test on the solution with one drop of the silver nitrate solution (4.10).

(6.2) *In the absence of chloride ions*, place an aliquot portion of the extract containing 10 to 20 mg of manganese in a tall form 400 ml beaker. Bring to a volume of about 25 ml either by evaporation or by adding water. Add 2 ml of concentrated sulfuric acid (4.1).

If chloride ions are present, it is necessary to remove them as follows:

(6.3) Place an aliquot portion of the extract containing 10 to 20 mg of manganese in a tall form 400 ml beaker. Add 5 ml of 9 M sulfuric acid (4.2). Under a fume hood, bring to boiling on a hotplate and allow to boil until copious white fumes are released. Continue until the volume is reduced to about 2 ml (thin film of syrupy liquid at the bottom of the beaker). Allow to cool to ambient temperature.

Carefully add 25 ml of water and once again test for the presence of chlorides with one drop of the silver nitrate solution (4.10). If chlorides still remain, repeat the operation after adding 5 ml of 9 M sulfuric acid (4.2).

PROCEDURE

7. Add 25 ml of 6 M nitric acid (4.3) and 2.5 g of sodium bismuthate (4.5) to the 400 ml beaker containing the test solution. Stir vigorously for three minutes on the magnetic stirrer (5.2).

Add 50 ml of 0.3 M nitric acid (4.4) and stir again. Filter in vacuo through a crucible (5.1), the bottom of which is covered with Keiselguhr (4.6). Wash the crucible several times with the 0.3 M nitric acid (4.4) until a colourless filtrate is obtained.

Transfer the filtrate and the washing solution into a 500 ml beaker. Mix and add 25 ml of 0.15 M ferrous sulfate solution (4.8). If the filtrate turns yellow after the addition of ferrous sulfate, add 3 ml of 15 M orthophosphoric acid (4.7).

Using a burette, titrate the excess ferrous sulfate with 0.02 M potassium permanganate solution (4.9) until the mixture turns pink, the colour remaining stable for one minute. Perform a blank test under the same conditions, omitting only the test sample.

Note:

The oxidized solution must not come into contact with rubber.

EXPRESSION OF RESULTS

8. 1 ml of 0.02 M potassium permanganate solution corresponds to 1.099 mg of manganese (Mn). The percentage of manganese in the fertiliser is given by:

$$\text{Mn (\%)} \text{ where } = (x_p - x_v) \times 0.1099 \times \frac{V}{a \times M}$$

where:

x_b is the volume in ml of the permanganate used for the blank;

x_s is the volume in ml of the permanganate used for the test sample;

V is the volume in ml of the extract solution in accordance with Methods 26a and 26b;

a is the volume in ml of the aliquot portion taken from the extract (6.2) or (6.3);

M is the mass in g of the test sample.

26j.

Determination of MOLYBDENUM in Fertiliser Extracts by THE GRAVIMETRIC METHOD WITH 8-HYDROXYQUINOLINE

SCOPE

1. This method describes a procedure for determining molybdenum in fertiliser extracts.

FIELD OF APPLICATION

2. This procedure is applicable to extracts from samples of fertilisers obtained by Methods 26a and 26b for which a declaration of molybdenum is required.

PRINCIPLE

3. The molybdenum level is determined by precipitation as molybdenyl oxinate under specific conditions.

REAGENTS

Sulfuric acid solution, approximately 1M

Sulfuric acid solution, approximately 1M

4.—(4.1) Carefully pour 55 ml of sulfuric acid (H_2SO_4 , $\rho = 1.84$ g/ml) into a 1 litre volumetric flask containing 800 ml of water. Mix. After cooling, make up to one litre. Mix again.

Diluted ammonia solution (1:3)

(4.2) Mix 1 volume of concentrated ammonia solution (NH_4OH , $\rho = 0.9$ g/ml) with 3 volumes of water.

Diluted acetic acid solution (1:3)

(4.3) Mix 1 volume of concentrated acetic acid (99.7% CH_3COOH , $\rho = 1.049$ g/ml) with 3 volumes of water.

Solution of disodium salt of ethylene diamine tetraacetic acid (EDTA)

(4.4) Dissolve 5 g of Na_2EDTA in water in a 100 ml volumetric flask. Make up to the calibration mark and mix.

Buffer solution

(4.5) In a 100 ml volumetric flask, dissolve 15 ml of concentrated acetic acid and 30 g of ammonium acetate in water. Make up to 100 ml.

Status: This is the original version (as it was originally made). This item of legislation is currently only available in its original format.

8-hydroxyquinoline (oxine) solution

(4.6) In a 100 ml volumetric flask dissolve 3 g of 8-hydroxyquinoline in 5 ml of concentrated acetic acid. Add 80 ml of water. Add the ammonia solution (4.2) drop by drop until the solution becomes cloudy and then add the acetic acid (4.3) until the solution becomes clear again.

Make up to 100 ml with water.

APPARATUS

5.—(5.1) Filter crucible P16/ISO 4793, porosity 4, capacity 30 ml.

(5.2) pH meter with glass electrode.

(5.3) Drying oven at 130 to 135°C.

PREPARATION OF THE SOLUTION TO BE ANALYSED

6.—(6.1) Preparation of the molybdenum solution. See Methods 26a and 26b.

PROCEDURE

Preparation of the test solution

Preparation of the test solution

7.—(7.1) Place an aliquot portion containing 25 to 100 mg Mo in a 250 ml beaker. Make up the volume to 50 ml with water.

Adjust this solution to pH 5 by adding the sulfuric acid solution (4.1) drop by drop. Add 15 ml of EDTA solution (4.4) and then 5 ml of buffer solution (4.5). Make up to about 80 ml with water.

Obtaining and washing the precipitate

(7.2) Obtaining the precipitate:

Heat the solution slightly. Stirring constantly, add the oxine solution (4.6). Continue the precipitation until formation of a deposit is no longer observed. Add further reagent until the supernatant solution turns slightly yellow. A quantity of 20 ml should normally be sufficient. Continue to heat the precipitate slightly for two to three minutes.

Filtration and washing:

Filter through a filter crucible (5.1). Rinse several times with 20 ml of hot water. The rinse water should gradually become colourless indicating that oxine is no longer present.

Weighing the precipitate

(7.3) Dry the precipitate at 130 to 135°C to constant weight (at least one hour).

Allow to cool in a desiccator and then weigh.

EXPRESSION OF RESULTS

8. 1 mg of molybdenyl oxinate, $\text{MoO}_2(\text{C}_9\text{H}_6\text{ON})_2$, corresponds to 0.02305 mg Mo.

The percentage of molybdenum in the fertiliser is given by:

$$\text{Mo (\%)} = \frac{V \times D}{a \times M} \times 0.02305$$

where:

- X is the mass in mg of the molybdenyl oxinate precipitate;
- V is the volume in ml of the extract solution in accordance with Methods 26a or 26b;
- a is the volume in ml of the aliquot portion taken from the last dilution;
- D is the dilution factor of the aliquot portion;
- M is the mass in g of the test sample.

26k.

Determination of ZINC in Fertiliser Extracts by ATOMIC ABSORPTION Spectrometry

SCOPE

1. This method describes a procedure for determining zinc in fertiliser extracts.

FIELD OF APPLICATION

2. This procedure is applicable to extracts from samples of fertilisers obtained by Methods 26a and 26b for which a declaration of zinc is required.

PRINCIPLE

3. After suitable treatment and dilution of the extracts, the zinc level is determined by atomic absorption spectrometry.

REAGENTS

Hydrochloric acid solution, about 6 M

Hydrochloric acid solution, about 6 M

- 4.—(4.1) See Method 26d (4.1).

Hydrochloric acid solution, about 0.5 M

- (4.2) See Method 26d (4.2).

Lanthanum salt solutions (10 g of La per litre)

- (4.3) See Method 26d (4.3).

Zinc calibration solutions

Zinc stock solution (1000 mg/ml)

- (4.4.1) In a 1 litre volumetric flask dissolve 1 g of zinc powder or flakes weighed to within 0.1 mg in 25 ml of 6 M hydrochloric acid (4.1). When completely dissolved, make up to volume with water and mix thoroughly.

Zinc working solution (100 mg/ml)

- (4.4.2) In a 200 ml volumetric flask, dilute 20 ml of the stock solution (4.4.1) in 0.5 M hydrochloric acid solution (4.2). Make up to volume with the 0.5 M hydrochloric acid solution and mix thoroughly.

Status: This is the original version (as it was originally made). This item of legislation is currently only available in its original format.

APPARATUS

5. Atomic absorption spectrometer.

See Method 26d (5). The apparatus must be fitted with a source of rays characteristic of zinc (213.8 nm). The spectrometer must allow background correction to be made.

PREPARATION OF THE SOLUTION TO BE ANALYSED

Zinc extract solution

Zinc extract solution

6.—(6.1) See Methods 26a and/or 26b.

Preparation of the test solution

(6.2) See Method 26d (6.2). The test solution must contain 10% by volume of lanthanum salt solution (4.3).

PROCEDURE

Preparation of the blank solution

Preparation of the blank solution

7.—(7.1) See Method 26d (7.1). The blank solution must contain 10% by volume of the lanthanum salt solution used in 6.2.

Preparation of the calibration solutions

(7.2) See Method 26d (7.2). For an optimum interval of 0 to 5 mg/ml of zinc, place 0, 0.5, 1, 2, 3, 4 and 5 ml, respectively, of the working solution (4.4.2) in a series of 100 ml volumetric flasks. Where necessary, adjust the concentration of hydrochloric acid to bring it as close as possible to that of the test solution. Add 10 ml of the lanthanum salt solution used in (6.2) to each volumetric flask. Make up to 100 ml with the 0.5 M hydrochloric acid solution (4.2) and mix thoroughly.

These solutions contain, respectively, 0, 0.5, 1, 2, 3, 4 and 5 mg/ml of zinc.

Determination

(7.3) See Method 26d (7.3). Prepare the spectrometer (5) for measurements at a wavelength of 213.8 nm.

EXPRESSION OF RESULTS

8. See Method 26d (8).

The percentage of zinc in the fertiliser is given by:

$$Zn (\%) = [(x_s - x_h) \times V \times D] / (M \times 10^4)$$

If Method 26c has been used:

$$Zn (\%) = [(x_s - x_h) \times V \times 2D] / (M \times 10^4)$$

where:

Zn is the quantity of zinc expressed as a percentage of the fertiliser;

x_s is the concentration in $\mu\text{g/ml}$ of the test solution;

Status: This is the original version (as it was originally made). This item of legislation is currently only available in its original format.

x_b is the concentration in $\mu\text{g/ml}$ of the blank solution;

V is the volume in ml of the extract solution obtained in accordance with Methods 26a or 26b;

D is the factor corresponding to the dilution performed in (6.2);

M is the mass in g of the test sample taken in accordance with Methods 26a or 26b.

Calculation of the dilution factor D : if $(a_1), (a_2), (a_3), \dots, (a_i)$ and (a) are successive aliquot portions and $(v_1), (v_2), (v_3), \dots, (v_i)$ and (100) are the volumes in ml corresponding to their respective dilutions, the dilution factor D will be:

$$D = (v_1/a_1) \times (v_2/a_2) \times (v_3/a_3) \times \dots \times (v_i/a_i) \times (100/a).$$

Part II

General

1. When two or more methods are prescribed in this Part to determine a component of a fertiliser the choice of the method shall, except where otherwise indicated, be left to the agricultural analyst concerned; the method used must however be indicated in the certificate of analysis.

Reagents

2. Except where otherwise specified in the method of analysis, all reagents shall be of analytical quality. Where trace elements are to be determined, the purity of the reagents used shall be checked by means of a blank test.

Water

- (a) (a) Except where otherwise specified, a reference in this Part to water shall be a reference to demineralized or distilled water.
- (b) For the determination of any form of nitrogen, water shall be free of all nitrogenous compounds and carbon dioxide.
- (c) Except where the method of analysis specifies a particular solvent or diluent, all dissolution, dilution, rinsing and washing operations mentioned in the methods of analysis shall be carried out using water.

Apparatus

- (a) (a) Only special instruments and apparatus and specifically required apparatus and equipment are mentioned in the methods of analysis.
- (b) Apparatus and equipment shall be clean.
- (c) The accuracy of graduated glassware shall be assured by reference to the appropriate standards.

Methods of Analysis

- 5.—(1) Preparation of the sample for analysis
- (2) Determination of moisture
- (3) Determination of total nitrogen — chromium powder reduction method
- (4) Determination of urea

Status: This is the original version (as it was originally made). This item of legislation is currently only available in its original format.

- (5) Determination of potassium — gravimetric method
- (6) Determination of the neutralising value in liming materials
- (7) Determination of fineness of products other than potassic basic slag
- (8) Determination of fineness of potassic basic slag
- (9) Determination of fineness of certain lime products by wet sieving.

1.

PREPARATION OF THE SAMPLE FOR ANALYSIS

INTRODUCTION

1. The preparation of a sample for analysis from the final sample received at the laboratory is a series of operations, usually sieving, grinding and mixing, carried out in such a way that the smallest amount weighed, as prescribed by the method of analysis chosen, is representative of the final sample. The sample should be ground to the fineness required by the method of analysis. (Over grinding must be avoided in cases where this will affect the solubility in various reagents). With some materials, fine grinding may lead to loss or gain of moisture and allowance for this must be made.

SCOPE AND FIELD OF APPLICATION

2. This method is applicable to fertilisers in Groups 1(b), 1(c), 2(b), 2(c), 2(d), 3(b), 3(c), 4(a), 4(b), 4(c) and 5(b) of Section A and Group 5 and 6 of Section B of the Table in Schedule 1 to the Fertilisers Regulations (Northern Ireland) 1992(20).

This method is also applicable to fluid fertilisers.

The determination of the fineness of fertilisers is carried out on the sample as received.

PRINCIPLE

Solid fertilisers:

Solid fertilisers:

3.—(3.1) the whole final sample is ground to the required fineness. All the ground sample is thoroughly mixed before each test portion is taken.

Fluid fertilisers:

(3.2) the final sample is thoroughly mixed before each test portion is taken.

APPARATUS

4.—(4.1) Sample grinder capable of grinding the fertiliser to pass the specified sieve.

(4.2) Mortar and pestle of suitable material and size.

(4.3) Sieves having square apertures of 0.18 mm, 0.5 mm and 1.0 mm. Test sieves conforming to British Standard 410: 1986 are suitable.

(4.4) Sample containers of non-corrodible materials, with air-tight closures.

PROCEDURE

5

WARNING

ALL OPERATIONS CONNECTED WITH THIS PROCEDURE SHOULD BE CARRIED OUT AS QUICKLY AS POSSIBLE TO MINIMISE ABSORPTION OR LOSS OF WATER. CARE SHOULD BE TAKEN DURING GRINDING THAT THE TEMPERATURE of the fertiliser does not rise above 45°C to avoid loss of volatile constituents. Grinding beyond the fineness required must in all cases be avoided.

Grinding and sieving

(5.1) The procedure in 5.1.1 should be followed except when a grinding machine is not available, in which case 5.1.2 is applicable.

(5.1.1) Grind the final sample until all the sample has passed through, or for the specified time, depending on the type of grinder (4.1). To check that the grinding has been adequate, sieve a small portion of the ground sample through a 0.5 mm sieve (4.3) and discard it. If the whole of this portion does not pass the sieve, return the remainder of the sample to the grinder and repeat the grinding until satisfactory grinding is achieved.

(5.1.2) Sieve the whole final sample through the 0.5 mm sieve (4.3). Grind the residue on the sieve, using the pestle and mortar (4.2), until all the material passes through the sieve. Carefully mix the sample.

(5.2) Place the prepared sample in a clean container (4.4) and seal it until required for analysis.

(5.3) Before taking each test portion for analysis, the whole sample must be well mixed. Form the material into a flattened cone and using a spatula take the required test portion at random in small increments.

(5.4) If the sample contains foreign matter which cannot be ground this shall be removed, weighed and allowed for in the results of the analysis. This material shall be retained and if possible its nature recorded.

SPECIAL CASES

Samples not to be ground

Samples not to be ground

6.—(6.1) For those samples where the fineness of grinding is to be determined it shall be carried out on an unground sample. The sample should be well mixed (soft lumps may be disintegrated by lightly crushing) and divided into two parts, which are as identical as possible. All other determinations shall be carried out on the sample prepared in accordance with the directions in paragraph 5.1.

Products which may be difficult to grind mechanically, including products with abnormal moisture or products which become doughy through grinding

(6.2) Some products such as superphosphates may become doughy if ground mechanically. In these cases crush the sample in a mortar (4.2) so that all the material passes through a 1.0 mm sieve (4.3). Place the material so crushed in a clean container (4.4) and seal it until required for analysis.

Organic materials

Status: This is the original version (as it was originally made). This item of legislation is currently only available in its original format.

(6.3) Some organic materials may be of such a nature that the procedures given above cannot be used (for example fresh guano, leather, wool and animal residues). In these cases the analyst should use the best practicable means to obtain a representative sample.

Fertilisers comprising several different materials

(6.4) These fertilisers include materials with marked differences in texture or mechanical properties (hardness, density, etc). They may be difficult to grind entirely (for example mixtures of organic and inorganic materials) or they may segregate during handling (for example “Kalimagnesia”). Special procedures are necessary in these cases:

- (6.4.1) for mixtures other than those in 6.4.2, follow the procedure in 5.1.1, replacing the 0.5 mm sieve by one with apertures of 0.18 mm. A grinding machine, capable of grinding the whole of the sample to the required fineness in one pass, is strongly recommended;
- (6.4.2) in the case of mixtures containing one or more very hard components, or mixtures containing organic materials, it may be difficult to grind and homogenise all the components. To avoid overgrinding some of the softer components proceed as follows:—
grind the sample as in 5.1.1 or 5.1.2 to pass a 0.5 mm sieve. Re-sieve the sample through a 0.18 mm sieve and reduce the residue to a convenient size by further grinding or other practical means. Thoroughly remix the sample and place in a clean container (4.4).

FLUID FERTILISERS

7. Mix thoroughly by shaking, ensuring that any insoluble matter, particularly crystalline material, is thoroughly dispersed, immediately before drawing a portion of the sample for analysis.

2.

DETERMINATION OF MOISTURE

SCOPE AND FIELD OF APPLICATION

1. This method is applicable to fertilisers where a correction for moisture is necessary.

PRINCIPLE

2. The sample is dried to constant weight in an oven at 100°C. The loss in weight corresponds to the moisture content of the sample.

APPARATUS

3.—(3.1) Suitable containers with lids ensuring air-tight closure; the dimensions should allow the sample to be spread at about 0.3 g per cm².

(3.2) Electrically heated oven, suitably ventilated and capable of being maintained at 100 ± 2°C.

PREPARATION OF SAMPLE

6. See Method 1.

PROCEDURE

5. Weigh to the nearest 0.001 g, 5 g of the prepared sample and transfer to a previously weighed container (3.1). Place the uncovered container and the lid in the oven (3.2) for 2 to 3 hours. Replace the lid on the container, remove from the oven and allow to cool in a desiccator and weigh. Reheat

for another hour, cool and reweigh. If the difference in weight exceeds 0.01 g continue the heating and cooling procedure until a weight constant within 0.01 g is attained.

EXPRESSION OF RESULT

6. Calculate the total loss of weight and express it as a percentage of the original weight.

3.

DETERMINATION OF TOTAL NITROGEN CHROMIUM POWDER REDUCTION METHOD

SCOPE AND FIELD OF APPLICATION

1. This method is applicable to fertilisers in Groups 1(b), 1(c), 3(b), 4(a) and 4(c) of Section A, Group 5 and 6 of Section B and Groups 1(c) and 1(d) of Section C of the Table in Schedule 1 to the Fertilisers Regulations (Northern Ireland) 1992 in respect of which a declaration of total nitrogen is required.

PRINCIPLE

2. The nitrate is reduced to ammonia by chromium powder in an acid medium. Organic and ureic nitrogen are converted into ammonium sulfate by digestion with concentrated sulfuric acid using a catalyst. The ammonia is distilled from an alkaline solution and absorbed in a standard acid. The excess acid is titrated with standard alkali.

REAGENTS

- 3.—(3.1) Sodium hydroxide solution: 40 g per 100 ml, ammonia free.
- (3.2) Sulfuric acid, 0.05 M solution.
- (3.3) Sulfuric acid, 0.1 M solution.
- (3.4) Sulfuric acid, 0.25 M solution.
- (3.5) Sodium hydroxide, 0.2 M solution, carbonate free.
- (3.6) Chromium metal powder, 100 mesh, low nitrogen content.
- (3.7) Anti-bump granules of pumice stone, washed in hydrochloric acid and ignited.
- (3.8) Anti-foaming agent, paraffin wax.
- (3.9) sulfuric acid ($\rho = 1.84$ g/ml).
- (3.10) Hydrochloric acid ($\rho = 1.18$ g/ml).
- (3.11) Catalyst mixture: 1000 g potassium sulfate and 50 g copper sulfate pentahydrate. The ingredients must be ground and thoroughly mixed.

Indicator solutions

Mixed indicator:

- (3.12.1) Mix 50 ml of 2 g/litre ethanolic solution of methyl red with 50 ml of 1 g/litre ethanolic solution of methylene blue.

Methyl red indicator:

- (3.12.2) Dissolve 0.1 g methyl red in 50 ml ethanol. This indicator may be used instead of the preceding one.
- (3.13) pH indicator paper, wide range.

Status: This is the original version (as it was originally made). This item of legislation is currently only available in its original format.

APPARATUS

4. Apparatus for mineral acid digestion and distillation according to Kjeldahl's method.

PREPARATION OF SAMPLE

5. See Method 1.

PROCEDURE

Reduction

Reduction

6.—(6.1) Weigh, to the nearest 0.001 g, between 0.5 and 2.0 g of the prepared sample, containing not more than 0.06 g nitric nitrogen and 0.235 g total nitrogen and transfer to a Kjeldahl flask. Add sufficient water to make the total volume 35 ml. Allow the flask to stand for 10 minutes with occasional gentle swirling to ensure solution of all nitrate salts.

Add 1.2 g chromium powder (3.6) and 7 ml hydrochloric acid (3.10), mix well and allow the flask to stand for at least 5 minutes but not more than 10 minutes at ambient temperature. Heat the flask gently so that the contents just begin to boil in about 7 minutes. Continue boiling gently for 10 minutes. Remove the flask from the heat and allow to cool.

Hydrolysis, when the fertiliser is known not to contain organic matter

(6.2) Place the flask (6.1) in a fume cupboard, add a small quantity of anti-bump granules (3.7) and then carefully add 25 ml sulfuric acid (3.9). Mix the contents of the flask and heat gently until boiling. Continue heating until dense white fumes of sulfuric acid are evolved for at least 15 minutes. Allow the mixture to cool and then carefully add 250 ml water. Allow to cool to room temperature and continue as described in 6.4.

Digestion, when the fertiliser is known to contain organic matter

(6.3) Add a small quantity of anti-bump granules (3.7), 10 g of the catalyst mixture (3.11) and then carefully add 25 ml sulfuric acid (3.9) (see Note). Add 0.5 g paraffin wax (3.8) to reduce foaming and mix. Heat the flask moderately at first, shaking from time to time until frothing ceases and the liquid is practically colourless. Continue the digestion for at least a further 60 minutes. Allow the mixture to cool and then carefully add 250 ml water. Allow to cool to room temperature, and continue as described in 6.4.

Note:

If organic matter other than urea exceeds 1.0 g add an additional 1.0 ml sulfuric acid for each 0.1 g organic matter in excess of 1.0 g.

Distillation

(6.4) Transfer an appropriate volume of 0.1 M, 0.2 M or 0.5 M sulfuric acid (3.2, 3.3, 3.4) to the collecting flask of the distillation apparatus, according to the presumed level of nitrogen; add a few drops of indicator solution (3.12.1 or 3.12.2). Taking precautions against the loss of ammonia, carefully add to the contents of the Kjeldahl flask (6.2 or 6.3) 100 ml sodium hydroxide solution (3.1). Mix well and connect immediately to the distillation apparatus. Heat the flask so that approximately 150 ml of the liquid are distilled in 30 minutes. At the end of this time, lower the collecting flask so that the tip of the condenser is above the surface of the liquid. Test the subsequent distillate by means of the indicator paper (3.13) to ensure that all the ammonia is completely distilled. Remove

the source of heat. Titrate the excess acid with 0.2 M sodium hydroxide solution (3.5) to the end point of the indicator.

Blank test

(6.5) Carry out a blank test (omitting only the sample) under the same conditions and allow for this in the calculation of the final results.

EXPRESSION OF RESULTS

7. Determine the quantity of sulfuric acid consumed.

1 ml 0.05 M sulfuric acid = 0.0014 g nitrogen.

1 ml 0.1 M sulfuric acid = 0.0028 g nitrogen.

1 ml 0.25 M sulfuric acid = 0.0070 g nitrogen.

Express the result as the percentage of nitrogen (N) contained in the fertiliser as received for analysis.

4.

DETERMINATION OF UREA

SCOPE AND FIELD OF APPLICATION

1. This method is applicable to fertilisers in Group 1(c), of Section A, Group 5 and 6 of Section B and Group 1(d) of Section C of the Table in Schedule 1 to the Fertilisers Regulations (Northern Ireland) 1992.

PRINCIPLE

2. The sample is suspended in acid solution with a clarifying agent and filtered. The urea content of the filtrate is determined after the addition of 4-dimethylaminobenzaldehyde (4-DMAB) by measuring the absorbance at 435 nm.

REAGENTS

3.—(3.1) Activated charcoal.

Carrez solution I:

(3.2) dissolve 21.9 g zinc acetate dihydrate in water, add 3 ml glacial acetic acid and dilute to 100 ml with water.

Carrez solution II:

(3.3) 10.6 g potassium ferrocyanide per 100 ml.

(3.4) Hydrochloric acid solution, 0.02 M.

(3.5) Sodium acetate solution, 136 g sodium acetate trihydrate per litre.

4-dimethylaminobenzaldehyde solution:

(3.6) dissolve 1.6 g of 4-dimethylaminobenzaldehyde (4-DMAB) in 100 ml 96% ethanol and add 10 ml of hydrochloric acid ($\rho = 1.18$ g/ml).

(3.7) Urea standard solution: 1.0 g per 100 ml (1 ml of this solution = 10 mg urea).

Status: This is the original version (as it was originally made). This item of legislation is currently only available in its original format.

APPARATUS

- 4.—(4.1) Mechanical shaker.
- (4.2) Spectrometer with 10 mm cells.

PREPARATION OF SAMPLE

5. See Method 1.

PROCEDURE

Preparation of the solution for analysis

Preparation of the solution for analysis

6.—(6.1) Weigh to the nearest 0.001 g, 2 g of the prepared sample, or a suitable amount expected to contain between 50 and 500 mg of urea and transfer it to a 500 ml graduated flask. Add 150 ml 0.02 M hydrochloric acid solution (3.4), shake for 30 minutes using a mechanical shaker (4.1) then add 10 ml sodium acetate solution (3.5) and mix well. Add 2 g activated charcoal (3.1) to the flask, shake well and allow to stand for a further 15 minutes. Add 5 ml Carrez solution I (3.2), followed by 5 ml Carrez solution II (3.3), mixing well between additions. Dilute to volume with water and mix well. Filter a portion of the solution through a dry filter paper into a clean dry 250 ml beaker.

Determination

(6.2) Transfer 10 ml of the filtrate (6.1) to a 50 ml graduated flask, add 10 ml 4-DMAB solution (3.6), dilute to 50 ml with water, mix well and allow to stand for 10 minutes. Measure the absorbance of the solution at 435 nm, in a 10 mm cell against a reference solution prepared by diluting 10 ml 4-DMAB solution (3.6) to 50 ml with water.

Calibration curve

(6.3) Transfer amounts of standard urea solution (3.7) corresponding to 50, 100, 150 and 250 mg of urea into a series of 250 ml graduated flask; add 75 ml 0.02 M hydrochloric acid solution (3.4) and proceed as described above (6.1) commencing at “. . . shake for 30 minutes . . .”. Measure the absorbance of the solutions and construct a calibration graph relating the absorbances to the amounts of urea present.

EXPRESSION OF RESULTS

7. Determine the amount of urea in the sample by reference to the calibration graph. Express the result in terms of percentage ureic nitrogen of the sample:

(mg urea \times 0.4665 = mg ureic nitrogen).

5.

DETERMINATION OF POTASSIUM-GRAVIMETRIC METHOD

SCOPE AND FIELD OF APPLICATION

1. This method is applicable to fertilisers in Groups 3(b), 3(c), 3(d) and 4(c) of Section A and Group 5 and 6 of Section B of the Table in Schedule 1 to the Fertilisers Regulations (Northern Ireland) 1992 in respect of which an indication of total potassium is required.

PRINCIPLE

2. The sample is ashed and dissolved in dilute hydrochloric acid or, if it contains no organic substances, it is dissolved directly in dilute hydrochloric acid. After the removal of interfering substances the potassium is precipitated in a slightly alkaline medium in the form of potassium tetraphenylborate (KTPB).

REAGENTS

3.—(3.1) Formaldehyde, 25-35% solution, filtered if necessary before use.

(3.2) Potassium chloride.

(3.3) Sodium hydroxide, 10 M solution. Care should be taken to ensure that the sodium hydroxide is free from potassium.

(3.4) Indicator solution: dissolve 0.5 g phenolphthalein in 100 ml 90% ethanol.

(3.5) EDTA solution: 4 g of the dihydrated disodium salt of ethylenediaminetetraacetic acid (EDTA) per 100 ml. Store this reagent in a plastic container.

(3.6) STPB solution: dissolve 32.5 g sodium tetraphenylborate in 480 ml of water, add 2 ml of sodium hydroxide solution (3.3) and 20 ml of a magnesium chloride solution (100 g of $MgCl_2 \cdot 6H_2O$ per litre). Stir for fifteen minutes and filter through a fine, ashless filter. Store this reagent in a plastic container.

(3.7) Liquid for washing: dilute 20 ml of the STPB solution (3.6) to 1 litre with water.

(3.8) Hydrochloric acid ($\rho = 1.18$ g/ml).

APPARATUS

4.—(4.1) Filter crucibles with a porosity of 5 to 20 microns.

(4.2) Oven regulated to $120^\circ C \pm 10^\circ C$.

PREPARATION OF SAMPLE

5. See Method 1.

PROCEDURE

Preparation of the solution for analysis

Preparation of the solution for analysis

Fertilisers containing little or no organic matter

(6.1.1) Weigh to the nearest 0.001 g, 2.5 g of the prepared sample and transfer to a 400 ml beaker. Add 50 ml water and 5 ml hydrochloric acid (3.8) and evaporate to dryness on a steam bath. Add 5 ml hydrochloric acid (3.8) and 50 ml water. Bring the contents to the boiling point, breaking down any crystals or lumps with a glass rod. Dilute the solution with water to about 100 ml and boil gently for a few minutes. Allow to cool, transfer to a 250 ml graduated flask, dilute to the mark with water and mix; filter through a dry paper.

Fertilisers containing organic matter

(6.1.2) Weigh to the nearest 0.01 g, 10 g of the prepared sample into a suitable crucible and place in a cold muffle furnace. Gradually raise the temperature to about $475^\circ C$ (do not exceed $500^\circ C$). Maintain at this temperature for at least 16 hours and then open the furnace and

Status: This is the original version (as it was originally made). This item of legislation is currently only available in its original format.

allow the crucible to cool. Grind the residue to eliminate any lumps, add 50 ml water and 10 ml hydrochloric acid (3.8) and evaporate to dryness on a steam bath. Proceed as in 6.1.1, commencing "Add 5 ml hydrochloric acid (3.8) and 50 ml water."

Determination

- (6.2.1) (6.2) (6.2.1) Transfer by pipette an aliquot portion of the filtrate (6.1.1 or 6.1.2), containing 25-50 mg of potassium (30-60 mg K_2O) into a 250 ml beaker; make up to 50 ml with water.
- (6.2.2) To remove interferences, add 10 ml of the EDTA solution (3.5), several drops of the phenolphthalein solution (3.4) and stir in sodium hydroxide solution (3.3), drop by drop, until the solution turns red, then finally add a few more drops of sodium hydroxide to ensure an excess (usually 1 ml of sodium hydroxide is sufficient to neutralise the sample and ensure an excess).
- (6.2.3) To eliminate most of the ammonia boil gently for 15 minutes. Add water to make the volume up to 60 ml. Bring the solution to the boil, remove the beaker from the heat and add 10 ml formaldehyde (3.1). Add several drops of phenolphthalein solution (3.4) and, if necessary, more sodium hydroxide solution until a distinct red colour appears. Cover the beaker with a watch glass and place it on a steam bath for fifteen minutes.

Weighing the crucible

- (6.3) Dry the filter crucible (4.1) to constant weight in the oven at 120°C (4.2) (about 15 minutes).
Allow the crucible to cool in a desiccator and weigh.

Precipitation

- (6.4) Remove the beaker from the steam bath and stir in drop by drop 10 ml of the STPB solution (3.6). This addition should take about 2 minutes; allow to stand for at least 10 minutes before filtering.

Filtering and washing

- (6.5) Filter under vacuum into the weighed crucible; rinse the beaker with the liquid for washing (3.7), wash the precipitate three times with the liquid for washing (60 ml in all) and twice with 5 to 10 ml of water.

Drying and weighing

- (6.6) Wipe the outside of the crucible with a filter paper and place in the oven (4.2) for one and a half hours at a temperature of 120°C. Allow the crucible to cool in a desiccator to ambient temperature and weigh rapidly.

Blank test

- (6.7) Make a blank test under the same conditions (omitting only the sample) and allow for this in the calculation of the final result.

Control test

- (6.8) Carry out the determination on an aliquot portion of an aqueous solution of potassium chloride, containing at the most 40 mg of K_2O .

EXPRESSION OF RESULTS

7. Calculate the percentage potassium content of the samples as K_2O , taking into account the weight of the test sample, the volume of the aliquot portion taken for the determination and the value of the blank determination. (Conversion factor, KTPB to $K_2O = 0.1314$).

6.

DETERMINATION OF THE NEUTRALISING VALUE IN LIMING MATERIALS

SCOPE AND FIELD OF APPLICATION

1. This method is applicable to products in Groups 5(a) and 5(b) of Section A of the Table in Schedule 1 to the Fertilisers Regulations (Northern Ireland) 1992.

PRINCIPLE

2. The sample is dissolved in a measured quantity of standard hydrochloric acid, the excess of which is titrated with standard solution of sodium hydroxide.

REAGENTS

3.—(3.1) Hydrochloric acid, 0.5 M solution.

(3.2) Sodium hydroxide, 0.5 M solution (carbonate free).

(3.3) Phenolphthalein indicator solution: dissolve 0.25 g phenolphthalein in 150 ml 95% ethanol and dilute with water to 250 ml.

PREPARATION OF SAMPLE

4. Rapidly grind 50 g of the representative lime sample to pass through a 1 mm sieve.

PROCEDURE

Determination

Determination

5.—(5.1) Weigh to the nearest 0.001 g, 0.5 g of the prepared sample and transfer to a 300 ml conical flask. Add 50 ml of 0.5 M hydrochloric acid (3.1), cover the flask with a watch glass and boil the contents gently for five minutes. Cool the mixture to room temperature, add two or three drops of the phenolphthalein indicator (3.3) and titrate with 0.5 M sodium hydroxide solution (3.2) to the end point of the indicator.

EXPRESSION OF RESULTS

6. Determine the amount of hydrochloric acid consumed by the sample. 1 ml 0.5 M hydrochloric acid = 0.01402 g calcium oxide (CaO).

The neutralising value is expressed as a percentage by weight of calcium oxide (CaO) and refers to the undried sample as received.

Status: This is the original version (as it was originally made). This item of legislation is currently only available in its original format.

7.

DETERMINATION OF FINENESS OF PRODUCTS OTHER THAN POTASSIC BASIC SLAG

SCOPE AND FIELD OF APPLICATION

1. This method is applicable to “Rock phosphate” in Group 2(b) and to products in Groups 4(c), 5(a) and 5(b) of Section A of the Table in Schedule 1 to the Fertilisers Regulations (Northern Ireland) 1992.

PRINCIPLE

2. By hand sieve shaking, the proportion of material passing through the prescribed sieve is determined.

APPARATUS

3. Sieves having square apertures of 45 mm, 6.7 mm, 6.3 mm, 5 mm, 3.35 mm, 1.0 mm and 150 microns; lower receiver to fit sieve. Test sieves conforming to British Standard 410: 1986 are suitable.

PROCEDURE

For sieving through 3.5 mm, 1.0 mm and 150 micron sieves

For sieving through 3.5 mm, 1.0 mm and 150 micron sieves

4.—(4.1) Thoroughly mix the sample and quarter down until a portion of about 100 g is obtained. Heat this portion at 100°C until dry and thoroughly mix. Weigh to the nearest 0.01 g, 20 g and transfer to the sieve with the lower receiver attached. Proceed as described in 4.4.

For sieving through 6.7 mm, 6.3 mm and 5 mm sieves

(4.2) Oven dry the sample of 100°C for 24 hours and thoroughly mix. Weigh to the nearest 0.1 g, 200 g and transfer to the sieve with the lower receiver attached. Proceed as described in 4.4.

For sieving through a 45 mm sieve

(4.3) If the sample appears moist or damp, oven dry at 100°C for 24 hours, but if the sample appears dry, heating is not necessary. Thoroughly mix the sample and weigh to the nearest 0.1 g, 500 g and transfer to the sieve with the lower receiver attached. Proceed as in 4.4.

Sieving

(4.4) Shake the sieve for 5 minutes, frequently tapping the side. Disintegrate soft lumps such as can be caused to crumble by the application of the fibres of a soft brush, taking care that the hard part of the brush does not make contact with the sieve and that the brush is not used to brush particles through the sieve. Brush out the powder in the lower receiver and weigh. Replace the receiver and repeat the shaking and tapping procedure for 2 minutes. Add the powder in the receiver to the first portion and weigh. Repeat the process until not more than 0.04 g passes through the sieve during 2 minutes.

EXPRESSION OF RESULTS

5. Calculate the fineness by expressing the weight of the material passing through the sieve as a percentage of the weight of the portion of the dried (or as the case may be, undried) sample taken for sieving.

8.

DETERMINATION OF FINENESS OF POTASSIC BASIC SLAG

SCOPE AND FIELD OF APPLICATION

1. Exclusively to “Potassic basic slag” in Group 3(b) of Section A of the Table in Schedule 1 to the Fertilisers Regulations (Northern Ireland) 1992.

PRINCIPLE

2. By hand sieve shaking and dissolution of the soluble salts, the proportion of slag passing through the prescribed sieve is determined.

APPARATUS

3. Sieve having square apertures of 0.5 mm (500 microns); lower receiver to fit sieve. Test sieves conforming to British Standard 410: 1986 are suitable.

PROCEDURE

Preparation of the sample

Preparation of the sample

4.—(4.1) Thoroughly mix the sample and quarter down until a portion of about 100 g is obtained. Heat this portion at 100°C until dry and thoroughly mix.

Sieving

(4.2) Weigh to the nearest 0.1 g, 20 g of the dry sample and transfer to the sieve with the lower receiver attached. Shake the sieve for five minutes, frequently tapping the sides. Disintegrate soft lumps that can be caused to crumble by the application of a soft brush, taking care that the hard part of the brush does not make contact with the sieve and that the brush is not used to brush particles through the sieve.

Transfer the finer portion from the container into a 500 ml beaker and add 200 ml of previously boiled water. Stir and then filter through a weighed glass sintered crucible. Thoroughly wash the residue with water, dry and re-weigh the crucible. Calculate the weight of slag in the mixture with a particle size of less than 0.5 mm (A).

Weigh to the nearest 0.01 g, about 20 g of the dry sample and transfer to a 500 ml conical flask. Add 200 ml previously boiled water and shake for 30 minutes. Filter through a weighed, sintered glass crucible, wash the residue thoroughly with water, dry and re-weigh the crucible. Calculate the total weight of slag in the mixture (B).

EXPRESSION OF RESULTS

5. Express the fineness of the slag as

Status: This is the original version (as it was originally made). This item of legislation is currently only available in its original format.

Express the fineness of the slag as $\frac{A}{B} \times 100$.

9.

DETERMINATION OF FINENESS OF CERTAIN LIME PRODUCTS BY WET SIEVING

SCOPE

1. This method is applicable to products in Groups 5(b) of Section A of the Table in Schedule 1 to the Fertilisers Regulations (Northern Ireland) 1992(21) which are susceptible to clogging, caking, electrostatic changes or agglomeration on pre-drying. The method is not applicable to burnt and hydrated lime products.

PRINCIPLE

2. The liming material is suspended in water. The suspension is sieved under continuous water spraying or using a mechanical wet-sieving machine. The fractions retained on the sieves are collected and dried.

APPARATUS

3. Usual laboratory apparatus and in particular:

(3.1) Balance, capable of weighing to the nearest 0.01 g.

(3.2) Stainless steel woven wire test sieves 100 mm diameter, complying with ISO 3310-1, with nominal apertures of 5.00 mm, 3.35 mm and 150 microns.

(3.3) Stainless steel woven wire test sieving complying with ISO 3310-1, with nominal apertures of 10.00 mm.

(3.4) Oven capable of being controlled at $105^{\circ}\text{C} \pm 2$.

(3.5) Rotating end over end shaker: 35-40 turns per minute.

SAMPLING

Procedure for samples with dry matter content $\geq 60\%$

Procedure for samples with dry matter content $\geq 60\%$

4.—(4.1) Pass the laboratory sample through a sieve with nominal apertures of 10.00 mm (3.3). If necessary, lightly crush any lumps by means of a soft brush. Remove any lumps which cannot be crushed in this way and record the weight of the residue and the weight of the lumps. Take account of these lumps when recording the final results. Thoroughly mix the sieved sample and quarter down until a representative sample portion of about 50 g is obtained.

Procedure for samples with dry matter content $< 60\%$ which cannot be treated as per 4.1 due to the nature of the material

(4.2) Empty the whole of the sample onto a clean dry surface and flatten to form a regular shape about 25 mm thick. Divide into four approximately equal portions and reject two opposite quarters. Take small portions from random places on all the exposed surfaces to give a sample portion of about 50 g.

(21) S.R. 1992 No. 187

PROCEDURE

5. Weigh the sample portion (4.1 or 4.2) to the nearest 0.01 g and transfer to a 500 ml flask. Add approximately 300 ml of de-mineralized water, stopper and shake vigorously by hand for 30 seconds. Remove the stopper for an instant to relieve the pressure and replace the stopper. Place the flask in the rotating end over end shaker (3.5) and shake for 60 minutes to ensure the complete suspension of the sample.

Assemble the three sieves (3.2) in ascending order of aperture size on top of the receiver.

Rinse the sample quantitatively onto the top sieve and wash under a flow of water up to 2.5 litres/min until no more material passes each sieve, or up to a maximum time period of 10 minutes.

Remove the sieves and rinse the residue on each sieve quantitatively into a separate 250 ml beaker. Decant most of the water from the top of the material and dry each of the oversize fractions in an oven set at 105°C and weigh each fraction separately.

DRY MATTER CONTENT

6. Determine the dry matter content of a portion of the original sample using the method given in Method 2.

EXPRESSION OF RESULTS

Original dry mass

Original dry mass

7.—(7.1) Calculate the original dry mass (M_d) of material, using the following formula.

$$M_d = M \times DM$$

where:

M is the mass of the test portion taken for the sieving test.

DM is the percentage dry matter obtained in 6.

Sieve fraction

(7.2) Calculate the percentage of material retained on each sieve, using the following formula:

$$X_r = M_n / M_d \times 100$$

where:

X_n is the percentage by mass retained on sieve n.

M_n is the dry mass retained on sieve n.

M_d is the dry mass of the test portion.

Report the percentages of material ($100 - X_n$) which will pass through each sieve.

Carry out two single tests on separate test portions prepared from the same original sample. Record the mean of the two individual results for each sieve as the result (corrected if necessary for the presence of lumps (4.1)).

Status: This is the original version (as it was originally made). This item of legislation is currently only available in its original format.

APPENDIX TO SCHEDULE 2

Part I,

Method 2

Figure 1 KEY TO FIGURE 1

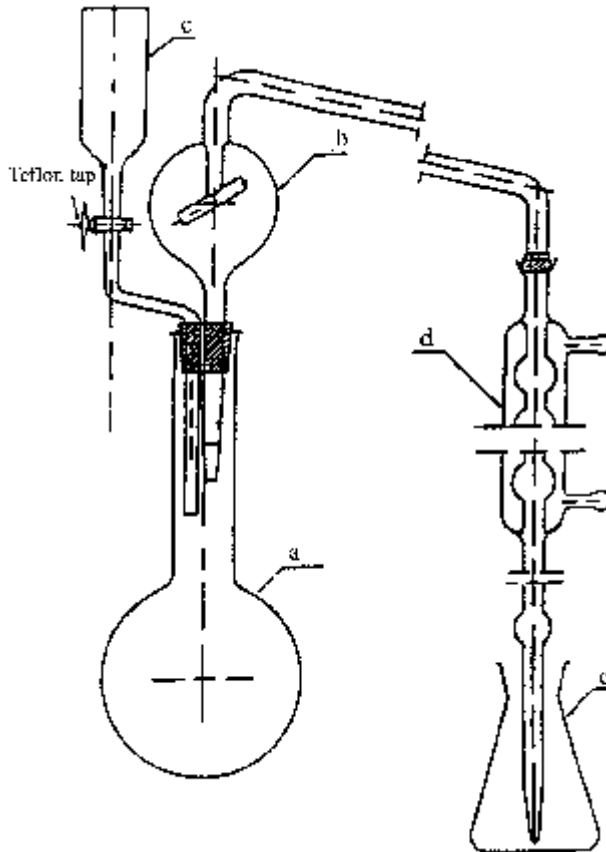

- (a) A round-bottomed, long-necked flask of 1,000 ml capacity.
- (b) Distillation tube with a splash head, connected to the condenser by means of a spherical joint (the spherical joint for the connection to the condenser may be replaced by an appropriate rubber connection).
- (c) Funnel with teflon tap for the addition of sodium hydroxide (the tap may likewise be replaced by a rubber connection with a clip).
- (d) A six-bulb condenser with a spherical joint, fitted with a glass extension tube. (The connection to the distillation tube may be effected by means of a rubber bung instead of a spherical joint.)
- (e) A 500 ml flask in which the distillate is collected.

The equipment is made of borosilicate glass.

Part I,

Method 2

Figure 2KEY TO FIGURE 2

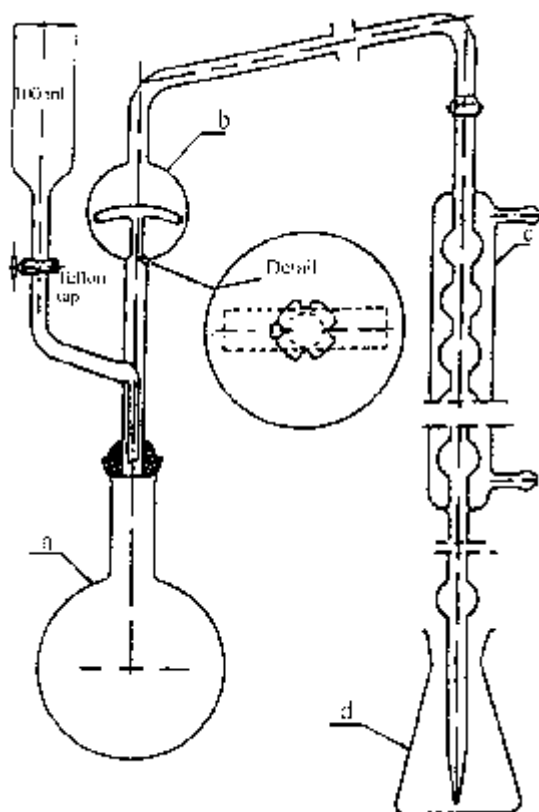

- (a) A round-bottomed, short-necked flask of 1,000 ml capacity with a spherical joint.
- (b) Distillation tube with a splash head, fitted with spherical joints, connected at the side to a funnel with a teflon tap for the addition of sodium hydroxide.
- (c) A six-bulb condenser with a spherical joint, fitted with a glass extension tube.
- (d) A 500 ml flask in which the distillate is collected.

The equipment is made of borosilicate glass.

Part I,

Status: This is the original version (as it was originally made). This item of legislation is currently only available in its original format.

Method 2

FIGURE 3 KEY TO FIGURE 3

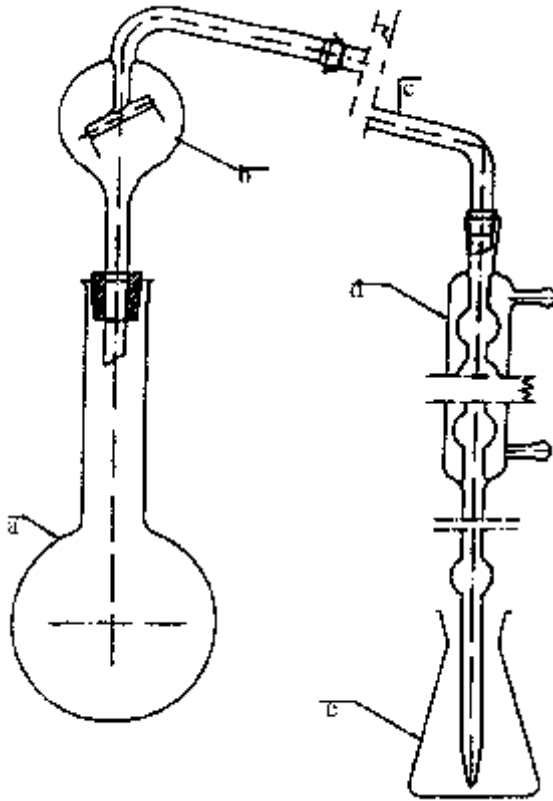

- (a) A round-bottomed, long-necked flask of 750 or 1,000 ml capacity with a bell mouth.
- (b) Distillation tube with a splash head and a spherical joint.
- (c) An elbow tube with a spherical joint and a drip cone (the connection to the distillation tube may be effected by means of a rubber tube instead of a spherical joint).
- (d) A six-bulb condenser with a glass extension tube.
- (e) A 500 ml flask in which the distillate is collected.

The equipment is made of borosilicate glass.

Part I,

Method 2

FIGURE 4 KEY TO FIGURE 4

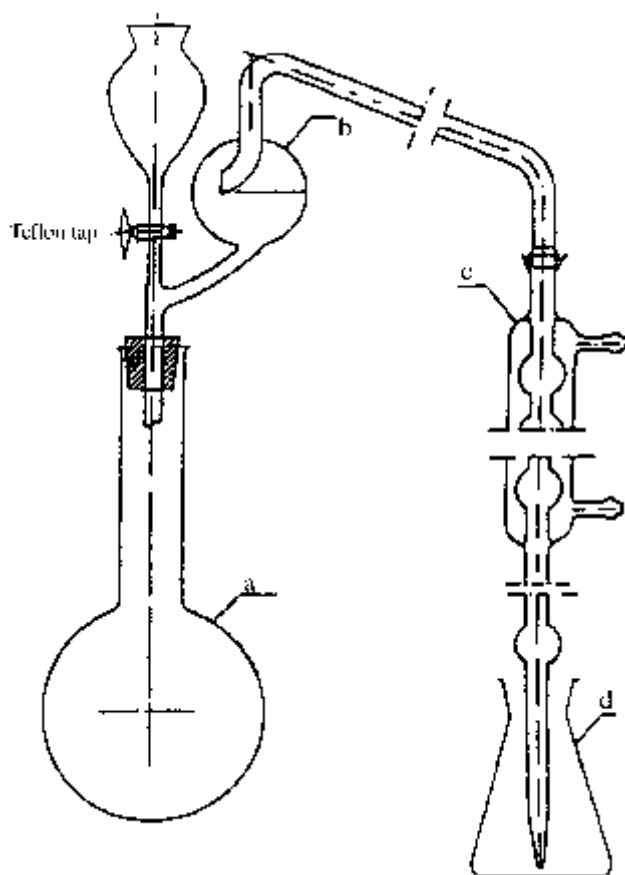

- (a) A round-bottomed, long-necked flask of 1,000 ml capacity with a bell mouth.
- (b) Distillation tube with a splash head and a spherical joint connected at the side to a funnel with a teflon tap for the addition of sodium hydroxide (a suitable rubber bung may be used instead of the spherical joint; the tap may be replaced by a rubber connection with an appropriate clip).
- (c) A six-bulb condenser with a spherical joint, fitted with a glass extension tube. (The connection to the distillation tube may be effected by means of a rubber bung instead of a spherical joint).
- (d) A 500 ml flask for the collection of the distillate.

The equipment is made of borosilicate glass.

Part I,

Status: This is the original version (as it was originally made). This item of legislation is currently only available in its original format.

Method 3c

Figure 5KEY TO FIGURE 5

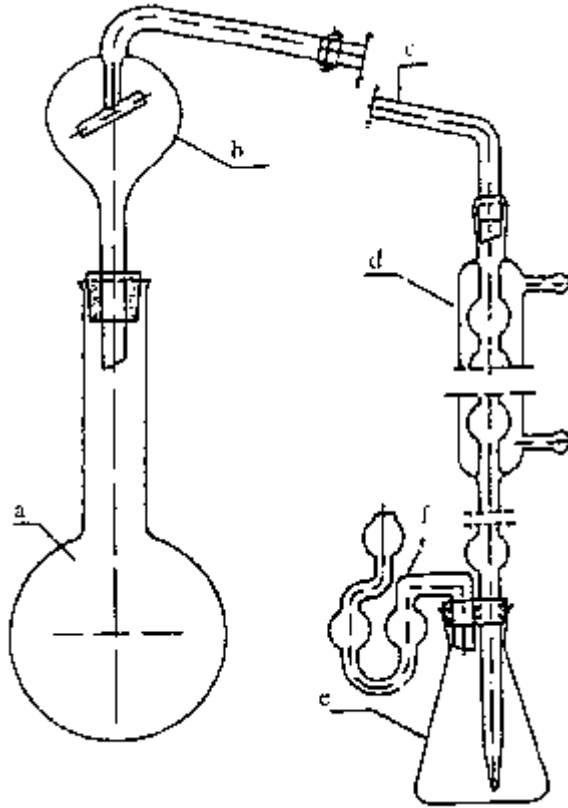

- (a) A round-bottomed, long-necked flask of 750 or 1,000 ml capacity with a bell mouth.
- (b) Distillation tube with a splash head and a spherical joint.
- (c) Elbow tube with a spherical joint and a drip cone. (A suitable connection may be used instead of the spherical joint).
- (d) A six-bulb condenser with an extension tube mounted on a rubber bung holding a bubble trap.
- (e) 1750 ml receiving flask.
- (f) A bubble trap to prevent loss of ammonia.

The equipment is made of borosilicate glass.

Part I,

Method 8a & b

Figure 6 KEY TO FIGURE 6

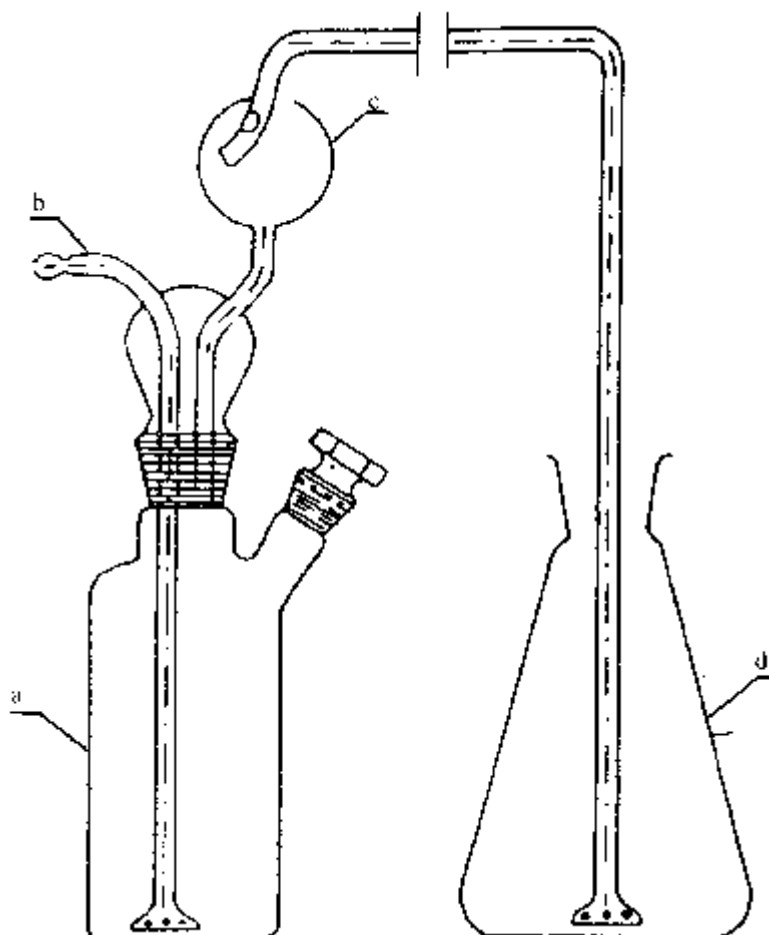

(a) Reaction vessel, 350-400 ml capacity.

(b) Tube for introduction of air.

(c) Delivery tube with splash head.

(d) Conical flask, 300 ml capacity.

Part I,

Status: This is the original version (as it was originally made). This item of legislation is currently only available in its original format.

Method 8a & b

Figure 7KEY TO FIGURE 7

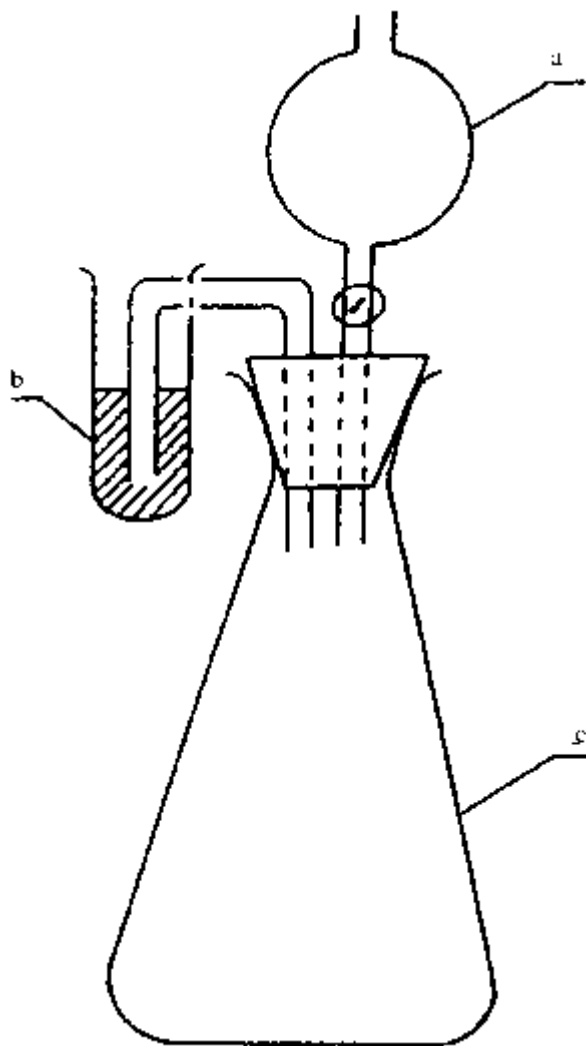

- (a) Separating funnel.
- (b) Bubble trap.
- (c) Conical flask, 300 ml capacity.

Part I,

Method 9d

Figure 8KEY TO FIGURE 8

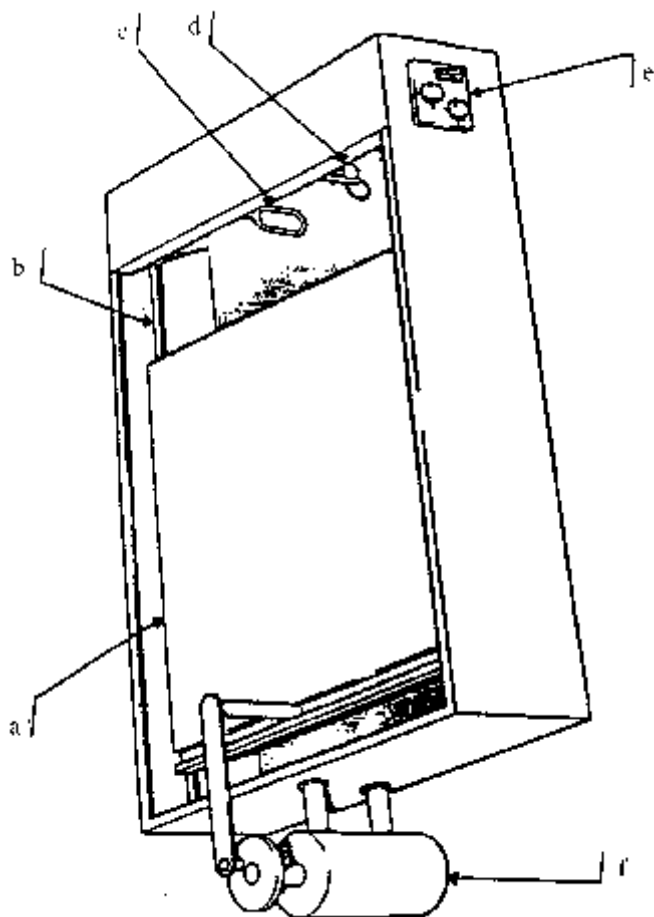

- (a) Tray for flask.
- (b) Tray support.
- (c) Heater.
- (d) Stirrer.
- (e) Controls for heater, stirrer and electric motor.
- (f) Electric motor.

Part I,

Status: This is the original version (as it was originally made). This item of legislation is currently only available in its original format.

Method 14c

Figure 9 KEY TO FIGURE 9

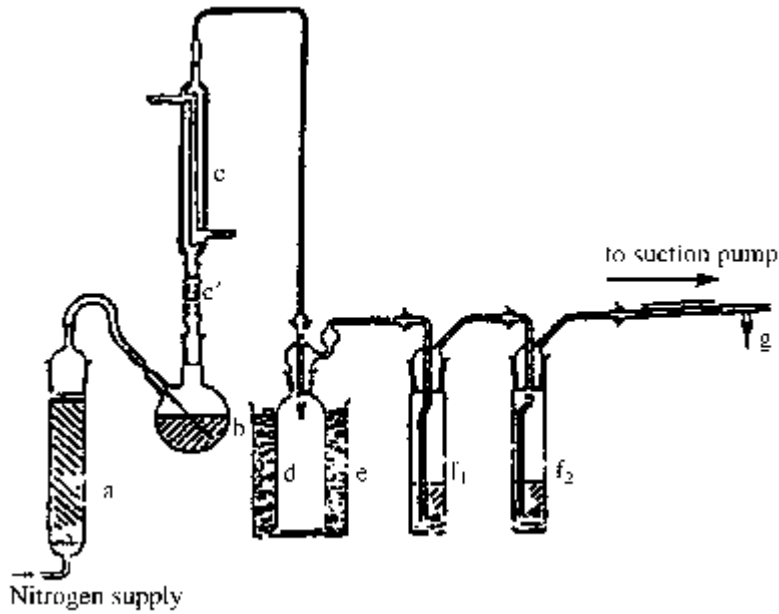

- (a) Absorption tube with soda lime.
- (b) Reaction flask.
- (c) Vigreux fractionating column 150 mm long.
- (c) Double surface condenser 200 mm long.
- (d) Drechsel bottle 250 ml.
- (e) Ice bath.
- (f1 f2) Absorption vessels 32 to 35 mm diameter assembled with spherical ground joints. Gas distributor with 10 mm disc of low-porosity sintered glass.
- (g) Suction-regulating device.

SCHEDULE 3

Regulation 6

FORM OF CERTIFICATE OF ANALYSIS

Status: This is the original version (as it was originally made). This item of legislation is currently only available in its original format.

CERTIFICATE OF ANALYSIS OF FERTILISER⁽¹⁾

in the form prescribed by Schedule 3 of the Fertilisers (Sampling and Analysis) Regulations (Northern Ireland) 1996.

I, the undersigned, agricultural analyst for the Department of Agriculture, in pursuance of the provisions of Section 79 of the Agriculture Act 1970, Part IV and Regulation 6 of the Fertilisers (Sampling and Analysis) Regulations (Northern Ireland) 1996, hereby certify that I received on the day of , 19 , from⁽²⁾ one part of the sample of⁽³⁾ for analysis; which was duly sealed and fastened up and marked⁽⁴⁾ and was accompanied by a⁽⁵⁾ , as follows:—⁽⁶⁾

and also by a signed statement that the sample was taken in the prescribed manner, and that the said part has been analysed by me, or under my direction, and I declare the results of analysis to be as follows:—⁽⁷⁾

• 8 •

and I am of the opinion that⁽⁸⁾

The analysis was made in accordance with the relevant provisions of the Fertilisers (Sampling and Analysis) Regulations (Northern Ireland) 1996.

As witness my hand this day of , 19 ,

(Signature and address of analyst)

.....

Status: This is the original version (as it was originally made). This item of legislation is currently only available in its original format.

Notes

- (1) Statements made in certificates are to be confined to matters which are necessary to verify compliance with the Act.
- (2) Here insert the name of the inspector who submitted the sample for analysis and also the mode of transit, for example, "by hand", "by registered post", as the case may be.
- (3) Here insert the name or description applied to the material.
- (4) Here insert the distinguishing mark on the sample.
- (5) Here insert either "statutory statement", "copy of statutory statement", "copy of particulars marked on the material" or "copy of particulars indicated by a mark applied to the material", or as the case may be.
- (6) Here insert the analytical particulars contained in the statutory statement, or particulars marked on or indicated by a mark applied to the material, or as the case may be.
- (7) Insert relevant results under the appropriate headings, ie percentage or milligrams per kilogram.
- (8) In the case of analysis of a substance for which no analytical method is prescribed in Regulation 5 and Schedule 2 here indicate the method used. If analysis cannot be carried out because no suitable method exists then the certificate should state this.
- (9) Here enter information as follows: --
 - (a) whether the material was correctly named in accordance with the requirements of the Fertilisers Regulations (Northern Ireland) 1992 and whether it accords with the meaning corresponding to that name; and if not, in what respect;
 - (b) if the composition of the material agrees with or differs by no more than the limits of variation specified in the Fertilisers Regulations (Northern Ireland) 1992 from the statement of particulars contained in the statutory statement or the particulars marked on or indicated by a mark associated with the material, state that the particulars are correct within the limits of variation;
 - (c) if the composition of the material differs by more than the limits of variation specified in the Fertilisers Regulations (Northern Ireland) 1992 from the particulars contained in the statutory statement, or the particulars marked on or indicated by a mark associated with the material, state the difference between the amount found and the amount stated and that the difference is outside the limits of variation; and that the difference is to the prejudice of the purchaser, if such is believed to be the case.
- (10) Only the tests carried out need be listed.

(These notes and the numbers referring to them are for guidance only and do not form part of, and need not appear on, the certificate.)

EXPLANATORY NOTE

(This note is not part of the Regulations.)

1. These Regulations revoke and replace the Fertilisers (Sampling and Analysis) Regulations (Northern Ireland) 1992, the Fertilisers (Sampling and Analysis) (Amendment) Regulations (Northern Ireland) 1992 and the Fertilisers (Sampling and Analysis) (Amendment) Regulations (Northern Ireland) 1994. They implement as respects Northern Ireland the Directives listed in paragraph 2.

2. The Directives implemented are:

- Commission Directive [77/535/EEC](#) (O.J. No. L213, 22.8.77) on the approximation of the laws of the Member States relating to methods of sampling and analysis for fertilisers;
- Commission Directive [79/138/EEC](#) (O.J. No. L39, 14.2.79, p. 3) amending Directive [77/535/EEC](#) in respect of methods of analysis for magnesium;
- Commission Directive [87/94/EEC](#) (O.J. No. L38, 7.2.87) on the approximation of the laws of Member States relating to procedures for the control of characteristics of, limits for and, resistance to detonation of straight ammonium nitrate fertilisers of high nitrogen content;
- Commission Directive [87/566/EEC](#) (O.J. No. L342, 4.12.87, p. 32) amending Directive [77/535/EEC](#) in respect of methods of sampling for fluid fertilisers;
- Commission Directive [88/126/EEC](#) (O.J. No. L63, 9.3.88, p. 12) amending Directive [87/94/EEC](#), in respect only of its date for implementation by the Member States;
- Commission Directive [89/519/EEC](#) (O.J. No. L265, 12.9.89, p. 30) supplementing and amending Directive [77/535/EEC](#) (O.J. No. L213, 22.8.77, p. 1) on the approximation of the laws of the Member States relating to methods of sampling and analysis of fertilisers;
- Commission Directive [93/1/EEC](#) (O.J. No. L113, 7.5.93, p. 17) which amends Commission Directive [77/535/EEC](#) (O.J. No. L213, 22.8.77, p. 1) on the approximation of the laws of the Member States relating to methods of sampling and analysis of fertilisers;
- Commission Directive [95/8/EC](#) (O.J. No. L86, 20.4.95, p. 41) amending Directive [77/535/EEC](#) (O.J. No. L213, 22.8.77, p. 1) on the approximation of the laws of Member States relating to methods of sampling and analysis of fertilisers.

3. The Regulations provide for a number of matters concerning the sampling and analysis of fertilisers including:

- (a) the amounts of fertilisers from which samples are to be taken (regulation 2);
- (b) the manner of taking, marking, sealing and fastening up of samples (regulation 3 and Schedule 1);
- (c) the methods of sending part of a sample (regulation 4);
- (d) the methods by which analyses are to be carried out (regulation 5 and Schedule 2) and the form of certificate of analysis (regulation 6 and Schedule 3).

4. The principal changes are the introduction of sampling procedures for trace elements in fertilisers at a concentration greater than 10%, (Method 26 in Part 1 of Schedule 2) and of a method for the determination of fineness by wet sieving of certain lime products (Method 9 in Part 2 of Schedule 2) and the deletion of certain otiose methods (5a and b, 6, 7b, 8, 9a and b, and 10-14 in Part 2 of Schedule 2).

Status: This is the original version (as it was originally made). This item of legislation is currently only available in its original format.

5. The Regulations come into operation on 16th December 1996.