



Maritime &
Coastguard
Agency

MERCHANT SHIPPING NOTICE

MSN 1676(M) Amendment 1

The Merchant Shipping (Life-Saving Appliances and Arrangements) Regulations 2020 The Merchant Shipping (Life-Saving Appliances for Ships of Classes III to VI(A)) Regulations 1999

Notice to all Shipowners and Operators, Recognised Organisations, Certifying Authorities, Shipbuilders, Ship Repairers, Masters and Officers, and Surveyors

Summary

This Merchant Shipping Notice (MSN) forms an integral part of the Merchant Shipping (Life-Saving Appliances and Arrangements) Regulations 2020 (S.I. 2020/501) and the Merchant Shipping (Life-Saving Appliances For Passenger Ships Of Classes III to VI(A)) Regulations 1999 (S.I. 1999/2723) and is made mandatory by way of references to it in both sets of Regulations.

This Notice provides the reader with the technical requirements referred to in the Merchant Shipping (Life-Saving Appliances and Arrangements) Regulations 2020, which apply to ships of all Classes other than Classes III to VI(A), and bring UK law up to date in terms of the requirements in Chapter III of the Convention for the Safety of Life at Sea, 1974 (SOLAS). The carriage requirements in Part B of SOLAS Chapter III are incorporated into the 2020 Regulations and these (SOLAS) requirements can now be directly referred to.

This Notice contains the carriage requirements for life-saving appliances for UK ships which are not within the scope of SOLAS Chapter III and which were previously contained in the Merchant Shipping (Life-Saving Appliances For Ships Other Than Ships of Classes III to VI(A)) Regulations 1999.



1. Contents and List of Schedules

Section 1: Contents and list of schedules

Section 2: Introduction, definitions and classification of ships

Section 3: General instructions on the working arrangements for the Merchant Shipping (Life-Saving Appliances and Arrangements) Regulations 2020

Section 4: Carriage requirements for existing ships¹ constructed before 1st July 1986 in relation to life-saving appliances and arrangements on ships other than ships of Classes III to VI(A)

- 4.1 Carriage requirements for existing ships constructed² before 1st July 1986 (compliance)
- 4.2 Ships of Class I
- 4.3 Ships of Class II
- 4.4 Ships of Class II(A)
- 4.5 Ships of Class VII
- 4.6 Ships of Class VII(A)
- 4.7 Ships of Class VII(T)
- 4.8 Ships of Class VIII
- 4.9 Ships of Class VIII(T)
- 4.10 Ships of Class VIII(A)
- 4.11 Ships of Class VIII(A)(T)
- 4.12 Ships of Class IX
- 4.13 Ships of Class IX(A)
- 4.14 Ships of Class IX(A)(T)
- 4.15 Ships of Class XI
- 4.16 Ships of Class XII

General Requirements

- 4.17 Inflated boats
- 4.18 Lifebuoys
- 4.19 Lifebuoy lights, smoke signals and lines
- 4.20 Line-throwing appliances
- 4.21 Retro-reflective material
- 4.22 Stowage and handling of life-saving appliances
- 4.23 Stowage and handling of lifeboats, Class C boats, inflated boats and other boats
- 4.24 Stowage and handling of liferafts, buoyant apparatus, lifebuoys and lifejackets
- 4.25 Embarkation into lifeboats, Class C boats, inflated boats and other boats, and liferafts, and assembly stations
- 4.26 Manning of survival craft
- 4.27 Portable radio equipment
- 4.28 Electrically operated signals
- 4.29 Electric lighting
- 4.30 Ships' distress signals
- 4.31 Operational instructions for survival craft and their launching controls

¹ In this Notice, “**existing ships**” includes ships constructed before 1st July 1986 and ships constructed on or after 1st July 1986 but before 1st July 1998. All other ships are **new ships**.

² In this Notice, “**constructed**” means that the keel was laid, or was at a similar stage of construction, on a named date, and “similar stage of construction” means (i) construction identifiable with a specific ship begins, and (ii) assembly of that ship has commenced comprising at least 50 tons or one per cent of the estimated mass of all structural material, whichever is less.



- 4.32 Replacement of life-saving appliances
- 4.33 Immersion suits and anti-exposure suits
- 4.34 Servicing of Life-Saving Appliances

Section 5: Carriage requirements for existing ships in relation to life-saving appliances and arrangements on ships other than ships of Classes III to VI(A) constructed on or after 1st July 1986 and before 1st July 1998

- 5.1 Carriage requirements for existing ships in relation to life-saving appliances and arrangements on ships other than ships of Classes III to VI(A) constructed on or after 1st July 1986 and before 1st July 1998 (compliance)
- 5.2 Ships of Class I
- 5.3 Ships of Class II and II(A)
- 5.4 Ships of Class VII, VIII, VIII(A) and IX
- 5.5 Ships of Class VII(T), VIII(T) and VIII(A)(T)
- 5.6 Ships of Class IX(A) and IX(A)(T)
- 5.7 Ships of Class XI
- 5.8 Ships of Class XII

General requirements

- 5.9 Operating instructions for survival craft and their launching controls
- 5.10 Survival craft assembly and embarkation arrangements
- 5.11 Stowage of survival craft, rescue boats and inflated boats
- 5.12 Launching stations
- 5.13 Survival craft launching arrangements
- 5.14 Marine escape systems
- 5.15 Rescue boat embarkation, launching and recovery arrangements
- 5.16 Stowage of lifebuoys
- 5.17 Stowage of lifejackets
- 5.18 Stowage of two-way radiotelephone sets
- 5.19 Stowage and packing of pyrotechnic distress signals and line-throwing appliances
- 5.20 Immersion suits and anti-exposure suits
- 5.21 Manning of survival craft
- 5.22 Servicing of life-saving appliances
- 5.23 Replacement of life-saving appliances

Section 6 New ship carriage requirements for life-saving appliances for ships other than ships of Classes III to VI(A) constructed on or after 1st July 1998 and which are engaged on international voyages

- 6.1 Guidance on new ship carriage requirements for life-saving appliances for ships other than ships of classes III to VI(A) which are engaged on international voyages (application)
- 6.2 Guidance of LSA which is to be to the satisfaction of the Administration
- 6.3 Guidance on performance standards which are to the satisfaction of the Administration
- 6.4 Classes VII, VII(T), VIII, VIII(T), IX, XI and XII

Section 7: New ship carriage requirements for life-saving appliances for ships other than ships of Classes III to VI(A) constructed on or after 1st July 1998 which are engaged on non-international voyages or are otherwise not in scope of SOLAS

- 7.1 Carriage requirements for all new ships not in scope of SOLAS (compliance)
- 7.2 Class II(A)



- 7.3 Classes VIII(A)
- 7.4 Class VIII(A)(T)
- 7.5 Classes IX(A)
- 7.6 Class IX(A)(T)
- 7.7 Class XI
- 7.8 Class XII
- 7.9 Class VII
- 7.10 Class VII(T)
- 7.11 Class VIII
- 7.12 Class VIII(T)
- 7.13 Class IX

General requirements

- 7.14 Operating instructions for survival craft and their launching controls
- 7.15 Survival craft assembly and embarkation arrangements
- 7.16 Stowage of survival craft, fast rescue boats, marine evacuation systems, means of rescue, rescue boats and inflated boats
- 7.17 Launching station
- 7.18 Survival craft launching arrangements
- 7.19 Marine evacuation systems
- 7.20 Fast rescue boat and rescue boat embarkation, launching and recovery arrangements

Stowage and handling of life-saving appliances

- 7.21 Stowage of lifebuoys
- 7.22 Stowage of lifejackets
- 7.23 Stowage of two-way radiotelephone sets
- 7.24 Stowage and packing of pyrotechnic distress signals and line-throwing appliances
- 7.25 Servicing of life-saving appliances

Miscellaneous provision

- 7.26 Immersion suits and anti-exposure suit
- 7.27 Manning of survival craft

Section 8 Carriage requirements for life-saving appliances and arrangements for passenger ships of Classes III to VI(A)

Schedule 1: General requirements for all life-saving appliances

Schedule 2: Lifeboats, rigid rescue boats and fast rescue boats

- Part 1 General
- Part 2 Lifeboats
- Part 3 Partially enclosed lifeboats
- Part 4 Totally enclosed lifeboats
- Part 5 Lifeboats with self-contained air support system
- Part 6 Fire-protected lifeboats
- Part 7 Rigid rescue boats
- Part 8 Rigid inflated rescue boats
- Part 9 Free-fall lifeboats
- Part 10 Fast rescue boats, rigid and rigid inflated



Schedule 3: Inflated rescue boats and inflated boats

- Part 1 General
- Part 2 Inflated rescue boats
- Part 3 Inflated boats (non-SOLAS)

Schedule 4: Liferafts

- Part 1 General
- Part 2 Inflatable liferafts
- Part 3 Rigid liferafts
- Part 4 Open reversible liferafts
- Part 5 Inflatable liferafts (non-SOLAS)
- Part 6 Liferaft equipment (SOLAS)
- Part 7 Automatic release hooks
- Part 8 Float free arrangements
- Part 9 Liferaft lights

Schedule 5: Marine escape systems and means of rescue system

- Part 1 Marine evacuation system
- Part 2 Training
- Part 3 Means of rescue system

Schedule 6: Launching appliances and embarkation ladders

- Part 1 General
- Part 2 Lifeboat and rescue boat launching appliances
- Part 3 Liferaft launching appliances
- Part 4 Inflated boat launching appliances
- Part 5 Embarkation ladders

Schedule 7: Pyrotechnic signals and line throwing appliances

- Part 1 General
- Part 2 Rocket parachute flares
- Part 3 Hand flares
- Part 4 Buoyant smoke signals
- Part 5 Line throwing appliances
- Part 6 Information, instruction and stowage

Schedule 8: Lifebuoys and attachments

- Part 1 General
- Part 2 Lifebuoys (SOLAS)
- Part 3 Lifebuoys (610 millimetres)
- Part 4 Lifebuoy self-igniting lights
- Part 5 Lifebuoy self-activating smoke signals
- Part 6 Lifebuoy buoyant lifelines

Schedule 9: Lifejackets and attachments

- Part 1 General
- Part 2 Inherently buoyant lifejackets (over 32 kilogrammes)
- Part 3 Inherently buoyant lifejackets (under 32 kilogrammes)
- Part 4 Inflatable lifejackets



Part 5 Inflatable Civil Aviation Authority lifejacket

Part 6 Buoyancy aids

Schedule 10: Requirements for immersion suits, anti-exposure suits and thermal protective aids

Part 1 Immersion suits

Part 2 Anti-exposure suits

Part 3 Thermal protective aids

Schedule 11: General emergency alarm systems and public address systems

Part 1 General emergency alarm systems

Part 2 Public address systems

Schedule 12: Buoyant apparatus

Schedule 13: Survival craft equipment and rations

Part 1 First aid outfits

Part 2 Food rations

Part 3 Fresh water

Part 4 Sea-anchors

Schedule 14: Training manuals and instructions for on-board maintenance

Part 1 Training manuals

Part 2 Instructions for on-board maintenance

Schedule 15: Carriage of two-way VHF radiotelephone sets - exempting conditions

Schedule 16: Symbols relating to life-savings appliances and arrangements

2. Introduction, Definitions and Classification of Ships

2.1 In this Notice:

2.1.1 Unless a term is defined in paragraph 2.2, it has the same meaning as the interpretation in regulation 2 of the 1999 or 2020 Regulations respectively;

2.1.2 a reference to a numbered paragraph is, unless otherwise stated, a reference to a numbered paragraph in this Notice;

2.1.3 a reference to a numbered section is, unless otherwise stated, a reference to the relevant section in this Notice;

2.1.4 a reference to a numbered Schedule, is, unless otherwise stated, a reference to the relevant Schedule in this Notice;

2.1.5 a reference to a numbered Part of a Schedule is, unless otherwise stated, a reference to the relevant Part of the Schedule being referred to in this Notice;

2.1.6 a reference to 'the 1999 Regulations' means a reference to the Merchant Shipping (Life-Saving Appliances for Ships Other Than Ships of Classes III to VI(A)) Regulations 1999 (SI 1999/2721); and



2.1.7 a reference to ‘the 2020 Regulations’ means a reference to the Merchant Shipping (Life-Saving Appliances and Arrangements) Regulations 2020 (SI 2020/501).

2.2 The following definitions are used in this Notice:

“anti-exposure suit” means a protective suit designed for use by rescue boat crews and marine evacuation system parties, complying with the requirements of Schedule 10, Part 2;

“assembly station” and “muster station” have the same meaning;

“automatic self-righting liferaft” means a liferaft complying with the applicable requirements of Schedule 4, Part 2 or 3;

“buoyant apparatus” means flotation equipment (other than lifebuoys and lifejackets) designed to support persons who are in the water and complying with the requirements of Schedule 12;

“buoyant lifeline” means a line complying with the requirements of Schedule 8, Part 6;

“buoyant smoke signal” means a pyrotechnic signal complying with the requirements of Schedule 7, Part 4;

“canopied reversible liferaft” means a liferaft complying with the applicable requirements of Schedule 4, Part 2 or 3;

“certified person” means a member of the crew who holds either:

- (a) a certificate of proficiency in survival craft and rescue boats under the Merchant Shipping (Standards of Training, Certification and Watchkeeping) Regulations 2015 (S.I. 2015/782) or such certificate issued by or under the authority of any government outside the United Kingdom as is accepted by the Secretary of State as being the equivalent to a certificate issued under those Regulations; or
- (b) a certificate of proficiency as a lifeboatman issued before 28th April 1984 by or under the authority of the Secretary of State or such certificate issued before 28th April 1984 by or under the authority of any government outside the United Kingdom as is accepted by the Secretary of State as being the equivalent of such a certificate issued by or under the authority of the Secretary of State;

“certified” means certified by a certificate issued under regulation 13 or 14 of the Merchant Shipping (Survey and Certification) Regulations 2015;

“chemical tanker” means a cargo ship constructed or adapted and used for the carriage in bulk of any liquid product listed in Chapter 17 of the 2016 edition of the International Code for the Construction and Equipment of Ships Carrying Dangerous Chemicals in Bulk published by the IMO;

“Class C boat” means a boat complying with the requirements in Schedule 3;

“Convention” means the International Convention for the Safety of Life at Sea, 1974 (SOLAS), and all amendments which have entered force;

“date of expiry” in relation to any product referred to in Schedules 7 and 8 means a date within four years from the date of manufacture of that product;

“detection” means the determination of the location of survivors or survival craft;



“EEA agreement” means the agreement on the European Economic Area signed at Oporto on 2nd May 1992, together with the Protocol adjusting that Agreement signed at Brussels on 17th March 1993, as modified or supplemented from time to time;

“EEA State” means:

(a) a state which at that time is a member State, or

(b) any other state which at that time is a party to the EEA agreement;

“effective clearing of the ship” is the ability of a free-fall lifeboat to move away from the ship after free-fall launching without using its engine;

“embarkation ladder” means a ladder complying with the requirements of Schedule 6, Part 5 provided at survival craft embarkation stations to permit safe access to survival craft after launching;

“fast rescue boat” means a rescue boat complying with the requirements of Schedule 2, Part 10;

“fast rescue boat launching appliance” means an appliance complying with the requirements of Schedule 6, Part 2 designed to launch and recover a fast rescue boat;

“favourable weather” means fine, clear, settled weather with a sea state such as to cause only moderate rolling and/or pitching;

“free-fall acceleration” is the rate of change of velocity experienced by the occupants during launching of a free-fall lifeboat;

“free-fall certification height” is the greatest launching height for which a free-fall lifeboat is to be approved, measured from the still water surface to the lowest point on the free-fall lifeboat when the lifeboat is in the launch configuration;

“free-fall launching” means that method of launching a survival craft whereby the craft with its complement of persons and equipment on board is released and allowed to fall into the sea without any restraining apparatus;

“gas carrier” means a cargo ship constructed or adapted and used for the carriage in bulk of any liquefied gas or other product listed in Chapter 19 of the 2016 edition of the International Code for the Construction and Equipment of Ships Carrying Liquefied Gases in Bulk published by the IMO;

“general emergency alarm system” means a system complying with the requirements of Schedule 11, Part 1;

“hand flare” means a pyrotechnic signal complying with the requirements of Schedule 7, Part 3;

“IAMSAR” means the International Aeronautical and Maritime Search and Rescue Manual published by IMO;

“immersion suit” means a protective suit which reduces the body heat-loss of a person wearing it in cold water and complies with the requirements of Schedule 10, Part 1;

“IMO” means the International Maritime Organization;



“inflatable appliance” means an appliance which depends upon non-rigid, gas-filled chambers for buoyancy and which is normally kept uninflated until ready for use;

“inflatable lifejacket” means a lifejacket complying with the requirements of Schedule 9, Part 4;

“inflated boat” means a boat complying with the requirements of Schedule 3, Part 3 or Schedule 4;

“instructions for on-board maintenance” means the instructions for complying with the requirements of Schedule 14, Part 2;

“international voyage” means a voyage from a country to which the Convention applies to a port outside that country, or conversely;

“launching appliance” means an appliance complying with the applicable requirements of Schedule 6;

“launching ramp angle” means the angle between the horizontal and the launch rail of a free-fall lifeboat in its launching position with the ship on an even keel;

“launching ramp length” is the distance between the stern of a free-fall lifeboat and the lower end of the launching ramp;

“length” in relation to a registered ship means registered length, and in relation to an unregistered ship means the length from the fore part of the stem to the aft side of the head of the stern post or, if no stern post is fitted to take the rudder, to the fore side of the rudder stock at the point where the rudder passes out of the hull;

“lifeboat” means a boat complying with the applicable requirements of Schedule 2 of this Notice or MSN 1677(M);

“lifebuoy” means a lifebuoy complying with the requirements of Schedule 8, Part 2;

“lifeboat radiotelegraph installation” means an installation complying with regulation 48 of the Merchant Shipping (Radio Installations) Regulations 1998 (SI 1998/2070);

“lifejacket” means a lifejacket complying with the requirements in Schedule 8 of MSN 1677(M) or Schedule 9 of this Notice;

“lifejacket light” means a light complying with the relevant requirements of Schedule 9, Part 1;

“liferaft” means a liferaft complying with the requirements of either Schedule 4 of this Notice or Schedule 5 of MSN 1677(M);

“lightest sea-going condition” is the loading condition with the ship on an even keel, without cargo, with 10 per cent stores and fuel remaining and, in the case of a passenger ship, with the full number of passengers and crew and their luggage;

“line-throwing appliance” means an appliance complying with the requirements of Schedule 7, Part 5;

“long international voyage” means an international voyage which is not a short international voyage;



“LSA Code” means the International Life-Saving Appliance Code adopted by the Maritime Safety Committee of the International Maritime Organization in IMO Resolution MSC.48(66) and made mandatory by IMO Resolution MSC.47(66);

“marine evacuation system” means a system complying with the requirements of Schedule 5, Part 1;

“Maritime and Coastguard Agency” or “MCA” means the Maritime and Coastguard Agency, an Executive Agency of the Department for Transport;

“means of rescue” means equipment and arrangements complying with the requirements of Schedule 5, Part 3 designed to assist the recovery of survivors at sea;

“mechanically propelled lifeboat” means a lifeboat (other than a motor lifeboat) complying with the requirements of Schedule 2, Part 4 of MSN 1677(M);

“Merchant Shipping Notice” (or “MSN”) means a Notice described as such and issued by the MCA;

“motor lifeboat” means a lifeboat complying with the requirements of Schedule 2 of this Notice or MSN 1677(M);

“moulded depth” in relation to a ship means the vertical distance measured from the top of the keel to the top of the freeboard deck beam at side, except that:

- (a) in the case of a wood or composite ship, it is measured from the lower edge of the keel rabbet;
- (b) if the form at the lower part of the midship section of the ship is of a hollow character or if thick garboards are fitted, it is measured from the point where the line of the flat of the bottom continued inwards cuts the side of the keel;
- (c) in the case of a ship having rounded gunwales it is measured to the point of intersection of the moulded lines of the deck and side shell plating, the lines extending as though the gunwale were of angular design; and
- (d) if the freeboard deck is stepped and the raised part of the deck extends over the point at which the moulded depth is to be determined, it is measured to a line of reference extending from the lower part of the deck along a line parallel to the raised part of the deck;

“non-United Kingdom ship” means a ship other than a United Kingdom ship;

“periodical survey” with regard to life-saving appliances and arrangements means a periodical survey pursuant to regulation 6 or 7 of the Merchant Shipping (Survey and Certification) Regulations 2015 being conducted:

- (a) for a passenger ship, every 12 months; and
- (b) for a cargo ship, every 24 months;

“person” means a person over the age of one year;

“radar transponder” means a radar transponder, for use in survival craft, the emissions of which are intended to facilitate location of a survival craft in search and rescue operations;



“retro-reflective material” means a material which reflects in the opposite direction a beam of light directed on it and complies with the provisions of IMO resolution A.658(16);

“relevant standard of an EEA State”, in relation to a reference to a British Standard means:

- (a) a relevant standard or code of practice of a national standards body or equivalent body of an EEA State;
- (b) a relevant international standard recognised for use in an EEA State; or
- (c) a relevant specification acknowledged for use as a standard by a public authority of an EEA State,

being a standard, code of practice or specification which provides in use, levels of safety, suitability and fitness for purpose equivalent to those provided by the British Standard;

“relevant standard of a member State other than the United Kingdom”, in relation to a reference to a British Standard means:

- (a) a relevant standard or code of practice of a national standards body or equivalent body of a EEA State other than the United Kingdom;
- (b) a relevant international standard recognised for use in a EEA State other than the United Kingdom; or
- (c) a relevant specification acknowledged for use as a standard by a public authority of an EEA State other than the United Kingdom;

being a standard, code of practice or specification which provides in use, levels of safety, suitability and fitness for purpose equivalent to those provided by the International Standard or the British Standard;

“required free-fall height” means the greatest distance measured from the still water surface to the lowest point on the free-fall lifeboat when the free-fall lifeboat is in the launch configuration and the ship is in its lightest seagoing condition;

“rescue boat” means a boat complying with the applicable requirements of Schedule 2 or 3 and designed to rescue persons in distress and to muster liferafts;

“restricted period” means a period falling wholly within the following limits:

- (a) from 1st April to 31st October, both dates inclusive; and
- (b) between one hour before sunrise and one hour after sunset in the case of ships fitted with navigation lights conforming to regulations, and between sunrise and sunset in the case of any other ship;

“retrieval” means the safe recovery of survivors;

“rocket parachute flare” means a pyrotechnic signal complying with the requirements of Schedule 7, Part 2;

“ro-ro passenger ship” means a passenger ship provided with cargo or vehicle spaces not normally sub-divided in any way and extending to either a substantial length or the entire length of the ship in which vehicles or cargo can be loaded or unloaded in a horizontal direction;



“sailing ship” includes a ship provided with sufficient sail area for navigation under sails alone, whether or not fitted with mechanical means of propulsion;

“satellite EPIRB” means an emergency position-indicating radio beacon, being an earth station in the mobile-satellite service, the emissions of which are intended to facilitate search and rescue operations, and which is capable of:

- (a) floating free if the ship sinks;
- (b) being automatically activated when afloat;
- (c) being manually activated; and
- (d) being carried by one person;

“sea anchor” means an anchor complying with the requirements of Part 4 of Schedule 13, Part 4;

“self-activating smoke signal” means a signal complying with the requirements of Schedule 8, Part 5;

“self-igniting light” means a light complying with the requirements of Schedule 8, Part 4;

“service space” includes galleys, pantries containing cooking appliances, lockers and storerooms, paint rooms, baggage rooms, workshops other than those forming part of machinery spaces, mail rooms and similar spaces and trunks to such spaces;

“short international voyage” means an international voyage:

- (a) in the course of which a ship is not more than 200 miles from a port or place in which the passengers and crew could be placed in safety; and
- (b) which does not exceed 600 nautical miles in distance between the last port of call in the country in which the voyage begins and the final port of destination,

and, for the purposes of paragraph (b), the final port of destination is the last port of call in the scheduled voyage at which the ship commences its return voyage to the country in which the voyage began;

“survival craft” means a craft capable of sustaining the lives of persons in distress from the time of abandoning the ship;

“tanker” means a cargo ship constructed or adapted for the carriage in bulk of liquid cargoes of a flammable nature and also means a chemical tanker or gas carrier constructed or adapted to carry cargoes emitting toxic vapours or gases, or cargoes having a flash point not exceeding 60°C (closed cup test);

“thermal protective aid” means a bag or suit complying with the requirements of Schedule 10, Part 2;

“tons” means gross tons and a reference to tons:

- (a) in relation to a ship having alternative gross tonnages under paragraph 13 of Schedule 5 of the Merchant Shipping (Tonnage) Regulations 1982 permitted to be



used pursuant to regulation 12(1) of the Merchant Shipping (Tonnage) Regulations 1997, is a reference to the larger of those tonnages; and

- (b) in relation to a ship having its gross tonnage determined both under Part II and regulation 12(2) of those Regulations is a reference to its gross tonnage as determined under regulation 12(2);

“toxic vapours or gases” means the vapours or gases associated with products for which in the event of escape, respiratory and eye protection is required in Chapter 17 of the 2016 Edition of the International Code for the Construction and Equipment of Ships Carrying Dangerous Chemicals in Bulk published by IMO and in Chapter 19 of the International Code for the Construction and Equipment of Ships Carrying Liquefied Gases in Bulk published by IMO;

“training manual” means a manual complying with the requirements of Schedule 14, Part 1;

“two-way VHF radiotelephone apparatus” means a two-way VHF radiotelephone apparatus in survival craft for communication between survival craft, between survival craft and ship and between ship and rescue boat, complying with, in the case of equipment installed before 23rd November 1996, performance standards adopted by IMO contained in IMO Resolution A.762(18) and, in the case of equipment installed on or after 23rd November 1996, performance standards adopted by the organisation in IMO Resolution A.809(19);

“voyage” includes an excursion;

“water-entry angle” is the angle between the horizontal and the launch rail of a free-fall lifeboat when it first enters the water; and

“waterproofed” means protected as far as is practicable from the ingress of water.

2.3 Any reference in this Notice to:

- (a) the Code for the Construction and Equipment of Ships Carrying Dangerous Chemicals in Bulk;
- (b) the International Code for the Construction and Equipment of Ships Carrying Dangerous Chemicals in Bulk;
- (c) the Code for the Construction and Equipment of Ships Carrying Liquefied Gases in Bulk;
- (d) the International Code for the Construction and Equipment of Ships Carrying Liquefied Gases in Bulk;
- (e) a British Standard;
- (f) a Merchant Shipping Notice or a Marine Guidance Note;
- (g) any other specified Code or guidelines; and
- (h) Life-Saving Signals for Ships, Aircraft and Persons in distress; and
- (i) IAMSAR;



includes:

- (a) a reference to any document amending or replacing that publication; and
- (b) as respects a reference to a British Standard, a reference to a relevant standard of an EEA State other than the United Kingdom.

2.4 This Notice identifies the carriage requirements for life-saving appliances and arrangements on United Kingdom ships and specifies the technical performance standards associated with the carriage requirement. For ships on international voyages where the requirements are derived from SOLAS, the requirements are to be read as those in SOLAS Chapter III with any future amendments to the Convention being automatically incorporated into the 2020 Regulations by virtue of the ambulatory reference provision in those Regulations. Where the UK regulatory framework references this Notice in place of the international technical performance standards, the relevant specifications are those in the international technical performance standards and a reference to a Schedule of MSN 1676 should be read as a reference to a Schedule in this Notice.

2.5 Classification of Ships

2.5.1 For the purposes of this Notice and the associated UK Regulations, ships are arranged in Classes as follows:

2.5.2 Passenger Ships:

Class I: ships engaged on voyages any of which are long international voyages;

Class II: ships engaged only on short international voyages;

Class II(A): ships engaged on voyages of any kind other than international voyages, which are not:

(i) ships of Classes III to VI(A) as defined in the Merchant Shipping (Passenger Ship Construction: Ships of Classes III to VI(A)) Regulations 1998 (SI 1998/2515);

(ii) ships of Classes A, B, C or D as defined in the Merchant Shipping (Passenger Ships on Domestic Voyages) Regulations 2000 (SI 2000/2687) and engaged on domestic voyages for the purposes of those Regulations;

Class III: ships engaged only on voyages in the course of which they are at no time more than 70 miles by sea from their point of departure nor more than 18 miles from the coast of the United Kingdom, and which are at sea only in favourable weather and during restricted periods;

Class IV: ships engaged only on voyages in Category A, B, C or D waters;

Class V: ships engaged only on voyages in Category A, B, or C waters;

Class VI: ships engaged only on voyages with not more than 250 passengers on board, to sea, or in Category A, B, C or D waters, in all cases in favourable weather and during restricted periods, in the course of which the ships are at no time more than 15 miles, exclusive of any Category A, B, C or D waters, from their point of departure nor more than 3 miles from land;



Class VI(A): ships carrying not more than 50 passengers for a distance of not more than 6 miles on voyages to or from isolated communities on the islands or coast of the United Kingdom, and which do not proceed for a distance of more than 3 miles from land;

2.5.3 Ships other than Passenger Ships:

Class VII: ships, other than ships of Classes I, VII(A), VII(T), XI and XII, engaged on voyages any of which are long international voyages;

Class VII(A): ships employed as fish processing or canning factory ships, and ships engaged in the carriage of persons employed in the fish processing or canning industries;

Class VII(T): tankers engaged on voyages any of which are long international voyages;

Class VIII: ships, other than ships of Classes II, VIII(T), IX, XI and XII, engaged only on short international voyages;

Class VIII(A): ships, other than ships of Classes II(A) to VI(A) inclusive, VIII(A)(T), IX, IX(A), IX(A)(T), XI and XII, engaged only on voyages which are not international voyages;

Class VIII(T): tankers engaged on voyages any of which are short international voyages;

Class VIII(A)(T): tankers engaged only on voyages which are not international voyages;

Class IX: tugs and tenders, other than ships of Classes II, II(A), III, VI and VI(A), which proceed to sea but are not engaged on long international voyages;

Class IX(A): ships, other than ships of Classes IV to VI inclusive, which do not proceed to sea;

Class IX(A)(T): tankers which do not proceed to sea;

Class XI: sailing ships, other than fishing vessels and ships of Class XII, which proceed to sea; and

Class XII: pleasure vessels of 13.7 metres in length or over.

3. General instructions on the working arrangements for the Merchant Shipping (Life-Saving Appliances and Arrangements) Regulations 2020

3.1 The 2020 Regulations implement into UK law the requirements of SOLAS Chapter III. These requirements were previously implemented by the Merchant Shipping (Life-Saving Appliances For Ships Other Than Ships Of Classes III to VI(A)) Regulations 1999 (S.I. 1999/2721), the Merchant Shipping (Musters, Training and Decision Support Systems) Regulations 1999 (S.I. 1999/2722) and (in one respect) the Merchant Shipping (Entry into Dangerous Spaces) Regulations 1988 (S.I. 1988/1638). The provisions of Part B of Chapter III are specifically referenced in the Regulations and apply directly to ships within the scope of Chapter III. The Regulations also carry over the requirements of the 1999 Regulations for ships to which Chapter III does not apply and these requirements are now contained in this Notice; they are referenced in the 2020 Regulations and are therefore mandatory.



- 3.2 With the exception of ships of Classes III to VI(A), **new ships which are on international voyages** and are either:
- 3.2.1 a passenger ship;
- 3.2.2 a cargo ship of 500 tons or over; or
- 3.2.3 a cargo ship of 300 tons or over (in relation to LSA radio communications) must follow the requirements in the Convention and the LSA Code. This captures the following classes of ship: I, II, VII, VII(T), VIII, VIII(T) and IX. In accordance with the general exceptions in regulation 3 in SOLAS Chapter I, the 2020 Regulations exempt ships of Classes XI and XII from the requirement to comply with the Convention but the Regulations, and this Notice, do apply to these classes of ship.
- 3.3 For **other new** ships in scope of the 2020 Regulations (which are):
- 3.3.1 Cargo ships of Classes VII, VII(T), VIII, VIII(T) and IX of less than 500 tons (or less than 300 tons for the purpose of LSA radio communications); and
- 3.3.2 Classes II(A), VIII(A), VIII(A)(T), IX, IX(A), IX(A)(T), XI and XII,
- both the carriage requirements and performance standards are contained in this Notice.
- 3.4 For passenger ships of Classes III to VI(A), the carriage requirements continue to be in the Merchant Shipping (Life-Saving Appliances for Passenger Ships of Classes III to VI(A)) Regulations 1999, with the supporting performance standards being contained in this Notice.
- 3.5 This Notice includes the **existing** ship (pre 1st July 1998) carriage requirements which were previously set out in the 1999 Regulations. The requirements for ships to which Chapter III does not apply are unchanged since those Regulations were last amended but may be updated following further consultation. It also includes guidance on the requirements of Chapter III of SOLAS (carriage requirements) regarding instances where a requirement is “to the satisfaction of the Administration”, which relate to new ships (constructed on or after 1st July 1998). This Notice contains technical performance standards for existing ships, which are in Schedules using the same references as were previously used in the 1999 Regulations.
- 3.6 Some requirements in Chapter III apply to **existing** ships as well as to new ships, and owners of existing ships that are subject to Part 2 of the 2020 Regulations should comply with these Chapter III requirements as well as the requirements in this Notice. The Chapter III requirements that are relevant to existing ships are those that are expressed to apply to ‘all ships’ (which includes all passenger ships and all cargo ships) or are otherwise specifically applied to existing ships. The provisions in Chapter III that are directly applicable to such existing ships are explained below:
- Paragraph 2 of regulation 6 (radio life-saving appliances). This provision applies to all passenger ships and cargo ships of 300 gross tons and upwards.
 - Paragraph 5.3 of regulation 6 (public address system on passenger ships). This provision applies to certain existing ships, i.e. passenger ships constructed on or after 1st July 1997. Paragraphs 5.4 and 5.5 are also relevant and, pursuant to paragraph 5.5, ships constructed before 1st July



1997 which are already fitted with an approved public address system which are compliant with the LSA Code need not change their system.

- Regulation 8 (muster list and emergency instructions). This regulation applies to all ships.
- Regulation 9 (operating instructions). This regulation applies to all ships.
- Regulation 10 (manning of survival craft and supervision). This regulation applies to all ships.
- Regulation 17-1 (recovery of persons from the water). This regulation applies to all ships.
- Regulation 19 (emergency training and drills). This regulation applies to all ships.
- Regulation 20 (operational readiness, maintenance and inspections). This regulation applies to all ships.
- Paragraphs 3 and 4 of regulation 22 (personal life saving appliances). These provisions (relating to lifejacket lights, and immersion suits and thermal protection aids) apply to all passenger ships.
- Regulation 26 (additional requirements for ro-ro passenger ships). This regulation applies to all ro-ro passenger ships.
- Paragraph 1 of regulation 27 (information on passengers). This provision applies to all passenger ships.
- Paragraph 1 of regulation 28 (helicopter landing areas and pick-up areas). This provision applies to all ro-ro passenger ships.
- Regulation 29 (decision support system for masters of passenger ships). This regulation applies to ball passenger ships.
- Regulation 30 (drills). This regulation applies to all passenger ships.
- Paragraph 3 of regulation 31 (survival craft and rescue boats). This provision applies to all cargo ships.
- Paragraphs 2 and 3 of regulation 32 (personal life-saving appliances). These provisions (relating to lifejacket lights and immersion suits) apply to all cargo ships.
- Regulation 35 (training manual and on-board training aids). This regulation applies to all ships.
- Regulation 37 (muster list and emergency instructions). Regulation 37 itself does not directly apply to all ships; however, since regulation 8 requires compliance with regulation 37, the requirements of regulation 37 must also be met by all ships.

3.7 Supplementing regulations 8 and 37 of Chapter III relating to the muster list, the following requirements apply—



- (i) the master must maintain the muster list for the duration of the voyage;
- (ii) the muster list must specify '*other emergency signals and action to be taken by the crew hearing such signals*'; and
- (iii) the muster list must specify the location of assembly (or muster) stations.

3.8 The requirements that relate to mustering, training and decision support systems for ships to which Chapter III does **not** apply (that is, ships on non-international voyages and ships on international voyages but to which the Convention doesn't apply by virtue of the size of the ship), are still contained in the Merchant Shipping (Musters, Training and Decision Support Systems) Regulations 1999 rather than in this Notice. These Regulations have been amended to remove from their scope ships to which Chapter III **does** apply (both new and existing ships of Convention size engaged on international voyages) and which are now subject to the 2020 Regulations (Parts 2 and 4). MGN 71 (M) gives further guidance on the requirements that relate to mustering, training and decision support systems.

3.9 As all the requirements in the Merchant Shipping (Musters, Training and Decision Support Systems) Regulations 1999 implemented provisions that applied to 'all ships' (in some cases just 'all passenger ships' or 'all cargo ships'), these are not repeated in this Notice because Chapter III is applied to such ships (by virtue of regulation 10(2) of the 2020 Regulations). Owners of existing ships of Convention size engaged on international voyages should therefore look directly to Chapter III for the applicable requirements. The requirements that were previously implemented in the Merchant Shipping (Musters, Training and Decision Support Systems) Regulations 1999 are contained in the following regulations in Chapter III:

- paragraph 4.2 of regulation 6 (general emergency alarm systems) – note that paragraph 7.2.1 of the LSA Code must also be complied with;
- paragraphs 4.2 and 5 of regulation 6 (public address system) – note that paragraph 7.2.2 of the LSA Code must also be complied with;
- regulations 8 and 37 (muster list and emergency instructions) – note that regulation 37 must be complied with by virtue of regulation 8;
- regulation 19 (emergency training and drills) except for provision in relation to drills for enclosed spaces, which were previously implemented in the Merchant Shipping (Entry into Dangerous Spaces) Regulations 1988 (S.I. 1988/1638) – see below;
- regulation 29 (decision support systems);
- regulation 30 (drills).

3.10 The requirements that relate to enclosed spaces drills for ships to which Chapter III does **not** apply are contained in regulation 6 of the Merchant Shipping (Entry into Dangerous Spaces) Regulations 1988 (S.I. 1988/1638). Regulation 6 has been amended to remove from its scope ships to which Chapter III **does** apply (both new and existing ships of Convention size engaged on international voyages) and which are now subject to the 2020 Regulations (Parts 2 and 4). The requirements for these ships **to which Chapter III applies** are those in paragraphs 3.3, 3.6, 4.2.5 and 5 of regulation 19 in Chapter III and, again, owners of existing ships of Convention size engaged on international voyages should look directly to the Convention requirements rather than this Notice.



4. Carriage requirements for existing ships constructed before 1st July 1986 in relation to life-saving appliances and arrangements on ships other than ships of Classes III to VI(A)

4.1 Compliance

4.1.1 As per Part 2 of the 2020 Regulations, ships (other than existing ships of Classes III to VI(A)) constructed before 1st July 1998, must comply with the requirements carried over from the 1999 Regulations. These Regulations contained specific provisions, which are now set out in this Notice, for ships constructed before 1st July 1986 as they apply to the relevant ship class. Notwithstanding the general application of Part 2 of the 2020 Regulations, Chapter III of SOLAS contains requirements which are applicable to 'all ships' (irrespective of construction date). Where such a requirement applies to a ship within the scope of Part 2, the relevant requirement of Chapter III must be met (see regulation 10(2) of the 2020 Regulations). The requirement for existing ships constructed before 1st July 1986 to comply with Chapter III in certain respects also means that updates to the referenced Convention provisions are ambulatory (as a consequence of regulation 5 in the 2020 Regulations). The applicable Chapter III requirements for existing ships include the requirements that were previously implemented by the Merchant Shipping (Musters, Training and Decision Support Systems) Regulations 1999 and the Merchant Shipping (Entry into Dangerous Spaces) Regulations 1988 – see paragraphs 3.6 to 3.8 above.

4.1.2 Where life-saving appliances or arrangements are of a novel nature, or subject to significant design changes, or the specifications or testing requirements are not considered to be sufficiently developed, or experience of their usage is limited, the MCA must be contacted regarding the undertaking of the necessary approval procedure. For this purpose, the contact details at the end of this Notice should be used. In the case of novel life-saving arrangements, an engineering analysis must be carried out and provided to the MCA for consideration and approval.

4.2 Ships of Class I

4.2.1 Section 4.2 of this Notice applies to ships of Class I, the keels of which were laid, or which were at a similar stage of construction, before 1st July 1986.

4.2.2 Every ship must carry:

- (a) on each side of the ship, lifeboats of sufficient aggregate capacity to accommodate one half of the total number of persons which the ship is certified to carry; or
- (b) lifeboats and liferafts together providing sufficient aggregate capacity to accommodate the total number of persons which the ship is certified to carry, provided that there must never be less than sufficient lifeboats on each side of the ship to accommodate 37.5 per cent of the total number of persons which the ship is certified to carry; except that in the case of any ship constructed before 25th May 1980, this provision applies only if the total number of persons on board is not treated as increased as a result of the provision of liferafts.

4.2.3 Subject to paragraph 4.2.4, on every ship, two of the lifeboats required by paragraph 4.2.2 must be kept ready, one on each side of the ship, for immediate use in an emergency while the ship is at sea. These lifeboats must be not more than 8.5 metres in length and each of them must be a motor lifeboat.

4.2.4 On ships which are certified to carry not more than 30 persons at least one of the lifeboats required by paragraph 4.2.2 must be a motor lifeboat of not more than 8.5



metres in length which is kept ready for immediate use in an emergency while the ship is at sea.

4.2.5 Every ship must be provided with the following equipment:

- (a) a satellite EPIRB;
- (b) at least 3 waterproofed two-way VHF radiotelephone apparatus, complying with standards not inferior to those contained in IMO Resolution A.762(18) or subsequent IMO Resolution on performance standards for survival craft two-way VHF Radiotelephone Apparatus; and
- (c) on each side of the ship, at least one radar transponder stowed in such a location that it can be rapidly placed in any survival craft or, alternatively, one radar transponder stowed in each survival craft.

4.2.6 Every motor lifeboat carried in compliance with these Regulations must be provided with the equipment specified in Schedule 12, Part 4 of MSN 1677.

4.2.7 The lifeboats carried in compliance with this section must be not less than 7.3 metres in length.

4.2.8 In every ship, each lifeboat must be attached to a separate set of davits which must be of the gravity type, except that luffing-type davits may be fitted for operating lifeboats weighing not more than 2,300 kgs in their turning out condition.

4.2.9 The liferafts carried in compliance with paragraph 4.2.2(b) must be served by launching appliances. There must never be less than one such appliance on each side of the ship and the difference in the number of appliances fitted on each side must not exceed one.

4.2.10 Every ship must carry liferafts, which need not be served by launching appliances, of sufficient capacity to accommodate 25 per cent of the total number of persons the ship is certified to carry together with buoyant apparatus for 3 per cent of that number, provided that:

- (a) if liferafts are also carried in compliance with paragraph 4.2.2(b), all liferafts carried must be of a type capable of being launched by the appliances fitted in compliance with paragraph 4.2.9; and
- (b) ships which have a factor of subdivision of 0.33 or less may carry, in lieu of liferafts for 25 per cent of the total number of persons which the ship is certified to carry and buoyant apparatus for 3 per cent of that number, buoyant apparatus for 25 per cent of that number.

4.2.11 Every ship must carry at least the number of lifebuoys determined in accordance with the following table:

Length of ship in metres	Minimum number of lifebuoys
Under 61	8
61 or more but less than 122	12
122 or more but less than 183	18
183 or more but less than 244	24
244 or more but over	30

4.2.12 Lifejackets:



- (a) Every ship must carry a lifejacket appropriate for every person on board.
- (b) In addition to lifejackets carried in compliance with subparagraph (a), every ship must carry lifejackets for at least 5 per cent of the number of persons which the ship is certified to carry and such lifejackets must comply with the requirements of Schedule 8, Part 1 of MSN 1677 and must be stowed in a conspicuous place on deck or at the assembly place.
- (c) Each lifejacket required to be carried by subparagraphs (a) and (b) must be fitted with a lifejacket light complying with the requirements of Schedule 9, Part 1.

4.2.13 Every ship must carry a line-throwing appliance.

4.2.14 Immersion Suits:

- (a) Every ship must carry for each lifeboat on the ship at least 3 immersion suits and, in addition, a thermal protective aid for every person to be accommodated in the lifeboats not provided with an immersion suit except that immersion suits and thermal protective aids need not be carried for persons to be accommodated in totally or partially enclosed lifeboats or on a ship which is constantly engaged on voyages between the parallels of latitude of 20° North and South.
- (b) Every ship must carry, for every person assigned to a marine evacuation system party, an immersion suit or an anti-exposure suit of an appropriate size complying with paragraph 4.33.

4.2.15 Public Address System:

- (a) Subject to sub-paragraph (b), every ship must be provided with a public address system complying with Schedule 11, Part 2.
- (b) Ships which are already fitted with a public address system which complies substantially with the requirements of Schedule 11, Part 2, paragraphs 1, 2, 3, 4, 6 and 7 of MSN 1677 are not required to change their system

4.2.16 **Additional Carriage Requirements for Ro-Ro Passenger Ships of Class I**

- (a) Ro-ro passenger ships of Class I which were constructed before 1st July 1986 must comply with the requirements of subparagraphs (b), (c) and (d).
- (b) Liferrafts must:
 - (i) be served by marine evacuation systems complying with the requirements of Schedule 5, Part 1 or launching appliances complying with the requirements of Schedule 6, Part 3, equally distributed on each side of the ship;
 - (ii) be provided with float-free launching arrangements complying with the requirements of Schedule 4, Part 8;
 - (iii) be fitted with a semi-rigid boarding ramp capable of supporting a person weighing 100 kgs; and



- (iv) either be an automatic self-righting liferaft or be a canopied reversible liferaft which is stable in a seaway and is capable of operating safely whichever way up it is floating. Alternatively, and providing the existing liferafts comply with Schedule 4, the ship must carry automatic self-righting liferafts or canopied reversible liferafts, in addition to its normal complement of liferafts, of such aggregate capacity as will accommodate at least 50 per cent of the persons not accommodated in lifeboats. This additional liferaft capacity must be determined on the basis of the difference between the total number of persons on board and the number of persons accommodated in lifeboats.
 - (aa) The liferafts carried on a ro-ro passenger ship must be fitted with sufficient radar transponders so that there is one radar transponder for every four liferafts.
 - (bb) Subject to sub-paragraph (cc), a radar transponder fitted to a liferaft carried by a ro-ro passenger ship must be capable of:
 - (i) being mounted inside the liferaft so that the antenna of the radar transponder is more than one metre above sea level, and
 - (ii) being erected manually, after the liferaft is deployed.
 - (cc) Where a radar transponder is fitted to a canopied reversible liferaft, the radar transponder must be fitted so that those using the liferaft can readily gain access to and erect the radar transponder.
 - (dd) Every container of a liferaft which is fitted with a radar transponder must be clearly marked to indicate that the liferaft is so fitted.
- (c) Fast rescue boats:
 - (i) At least one of the motor lifeboats provided pursuant to paragraph 4.2.3 or 4.2.4 must be a fast rescue boat complying with the requirements of Schedule 2, Part 10, except that ships having a rescue boat that is substantially in compliance with Schedule 2, Part 10 must not be required to replace their rescue boat;
 - (ii) each fast rescue boat must be served by a suitable launching appliance complying with the requirements of Schedule 6, Part 1 and 2, and such launching appliances must take into account that the fast rescue boat is intended to be launched and retrieved even under severe adverse weather conditions;
 - (iii) at least two crews of each fast rescue boat must be trained, certified and drilled regularly having regard to the Merchant Shipping (Standards of Training, Certification and Watchkeeping) Regulations 2015 (S.I. 2015/782) including all aspects of rescue, handling, manoeuvring, operating these craft in various conditions, and righting them after capsizing; and
 - (iv) if the arrangement or size of the ship is such as to prevent the installation of the fast rescue boat required by subparagraph (c)(i), the fast rescue boat may be installed in place of an existing lifeboat which is accepted as respects a United Kingdom ship by the Secretary of State and as respects a non-United Kingdom ship by the Administration of the Government of the State whose flag the ship is entitled to fly, as a boat for use in an emergency, provided that all of the following conditions are met:



- (aa) the fast rescue boat installed is served by a launching appliance complying with the provisions of (c)(ii);
 - (bb) the capacity of the survival craft lost by the above substitution is compensated by the installation of liferafts capable of carrying at least an equal number of persons served by the lifeboat replaced;
 - (cc) such liferafts are served by the existing launching appliances or marine evacuation systems; and
 - (dd) every ship must carry, for every person assigned to crew of a fast rescue boat, an immersion suit or anti-exposure suit of an appropriate size and complying with paragraph 4.33, as appropriate to the Class of ship.
- (d) Means of rescue:
- (i) Each ro-ro passenger ship must be equipped with an efficient means of rescue complying with the requirements of Schedule 5, Part 3 for rapidly recovering survivors from the water and transferring survivors from rescue units or survival craft to the ship;
 - (ii) the means of transfer of survivors to the ship may be part of a marine evacuation system, or may be part of a system designed for rescue purposes;
 - (iii) if the inclined passage of a marine evacuation system is intended to provide the means of transfer of survivors to the deck of the ship, the inclined passage must be equipped with handlines or ladders to aid in climbing up the inclined passage; and
 - (iv) a fast rescue boat launching and recovery appliance may be used as part of a means of rescue system.
- (e) A sufficient number of lifejackets must be stowed in the vicinity of the assembly stations so that passengers do not have to return to their cabins to collect their lifejacket.
- (f) A helicopter emergency pick-up area must be provided on a ro-ro ship complying with the requirements of IAMSAR.

4.3 Ships of Class II

- 4.3.1 Section 4.3 of this Notice applies to ships of Class II, the keels of which were laid, or which were at a similar stage of construction, before 1st July 1986.
- 4.3.2 Every ship must, subject to the provisions of paragraph 4.3.8, be fitted in accordance with its length with the number of sets of davits specified in Column A of the table set out in Schedule 1 to MSN 1677: provided that no ship is required to be fitted with more sets of davits than the number of lifeboats required to accommodate the total number of persons which the ship is certified to carry.
- 4.3.3 A lifeboat must be attached to every such set of davits and the lifeboats so attached must, subject to the provisions of paragraph 4.3.8, together provide at least the capacity specified in Column C of the table set out in Schedule 1 of MSN 1677 or the capacity required to accommodate the total number of persons which the ship is certified to carry, if this is less.



- 4.3.4 Subject to paragraph 4.3.5, on every ship, two of the lifeboats required by paragraph 4.3.3 must be kept ready, one on each side of the ship, for immediate use in an emergency while the ship is at sea. These lifeboats must be not more than 8.5 metres in length and each of them must be a motor lifeboat, and one of them must be provided with the equipment specified in Part 4 of Schedule 12 of MSN 1677.
- 4.3.5 On ships which are certified to carry not more than 30 persons, at least one of the lifeboats required by paragraph 4.3.3 must be a motor lifeboat of not more than 8.5 metres in length which is kept ready for immediate use in an emergency while the ship is at sea and which is provided with the equipment specified in Part 4 of Schedule 12 of MSN 1677.
- 4.3.6 Subject to the provisions of paragraphs 4.3.7 and 4.3.8, when lifeboats carried in compliance with the foregoing provisions of this section will not accommodate the total number of persons which the ship is certified to carry, additional sets of davits with a lifeboat attached to each must be fitted to make up the deficiency in such accommodation.
- 4.3.7 If the volume of traffic so requires, the Secretary of State may permit any ship subdivided in accordance with the requirements of Schedule 2, Section 3 of MSN 1698(M) to carry persons in excess of the lifeboat capacity provided in compliance with paragraph 4.3.3, on condition that:
- (a) liferafts must be carried so that the total number of lifeboats together with such liferafts must be sufficient to accommodate the total number of persons which the ship is certified to carry; and
 - (b) in any such ship in which a two-compartment standard of subdivision is not achieved throughout by virtue of the application of the provisions of paragraph (9) of Schedule 2 to MSN 1698(M), there must be provided liferafts of sufficient aggregate capacity to accommodate 10 per cent of the total number of persons which the ship is certified to carry, such liferafts being additional to those required to be provided in compliance with subparagraph (a), paragraph 4.3.8(b) and with paragraph 4.3.12.
- 4.3.8 Where it can be shown that it is impracticable to stow satisfactorily the liferafts carried pursuant to paragraph 4.3.7 without reducing the number of lifeboats, the Secretary of State may permit the number of sets of davits required to be fitted under paragraph 4.3.2 and the number of lifeboats attached to davits required under paragraph 4.3.3 to be reduced, provided that:
- (a) the number of lifeboats must, in the case of ships of 58 metres in length or over, never be less than four, two of which must be carried on each side of the ship, and in the case of ships of less than 58 metres in length must never be less than two, one of which must be carried on each side of the ship;
 - (b) the number of lifeboats and liferafts must always be sufficient to accommodate the total number of persons which the ship is certified to carry; and
 - (c)
 - (i) where the total capacity of the lifeboats is less than that required by Column C of the table set out in Schedule 1 of MSN 1677, liferafts of a type capable of being launched by the appliances referred to in paragraph 4.18, as appropriate to the Class of ship must be provided;
 - (ii) the total carrying capacity of the liferafts must be at least the number obtained by dividing by 0.283 the difference between the aggregate cubic capacity of the lifeboats and the capacity required by Column C;



- (iii) the liferafts must together be sufficient for at least forty persons; and
- (iv) there is at least one launching appliance on each side of the ship and that the difference in the number of such appliances fitted on each side must not exceed one.

4.3.9 The lifeboats required by section 4.3 must not be less than 7.3 metres in length.

4.3.10 The lifeboat davits required to be carried in compliance with the requirements for Class II ships, must be of the gravity type, except that luffing type davits may be fitted for operating lifeboats weighing not more than 2,300 kgs in their turning out condition.

4.3.11 Every ship must be provided with the following equipment:

- (a) a satellite EPIRB;
- (b) at least 3 waterproofed two-way VHF radiotelephone apparatus, complying with standards not inferior to those contained in IMO Resolution A.762(18) or subsequent IMO Resolution on performance standards for survival craft two-way VHF Radiotelephone Apparatus; and
- (c) on each side of the ship, at least one radar transponder stowed in such a location that it can be rapidly placed in any survival craft or, alternatively, one radar transponder stowed in each survival craft.

4.3.12 Every ship must carry, in addition to any liferafts that may be carried in pursuance of paragraphs 4.3.7 and 4.3.8, liferafts sufficient to accommodate 10 per cent of the total number of persons for whom there is accommodation in lifeboats.

4.3.13 Every ship must carry buoyant apparatus, sufficient to support 5 per cent of the total number of persons which the ship is certified to carry.

4.3.14 Every ship must carry at least the number of lifebuoys determined in accordance with the following table:

Length of ship in metres	Minimum number of lifebuoys
Under 61	8
61 or more but less than 122	12
122 or more but less than 183	18
183 or more but less than 244	24
244 or more but over	30

4.3.15 Lifejackets:

- (a) Every ship must carry a lifejacket appropriate for every person on board.
- (b) In addition to lifejackets carried in compliance with subparagraph (a), every ship must carry lifejackets for at least 5 per cent of the number of persons which the ship is certified to carry and such lifejackets must comply with the requirements of Schedule 8, Part 1 of MSN 1677 and must be stowed in a conspicuous place on deck or at assembly stations.
- (c) Each lifejacket required to be carried by subparagraphs (a) and (b) must be fitted with a lifejacket light complying with the requirements of Schedule 9, Part 1.



4.3.16 Every ship must carry a line-throwing appliance.

4.3.17 Immersion Suits:

- (a) Every ship must carry for each lifeboat on the ship at least 3 immersion suits and, in addition, a thermal protective aid for every person to be accommodated in the lifeboats not provided with an immersion suit except that immersion suits and thermal protective aids need not be carried for persons to be accommodated in totally or partially enclosed lifeboats or on a ship which is constantly engaged on voyages between the parallels of latitude of 20° North and South.
- (b) Every ship must carry, for every person assigned to a marine evacuation system party, an immersion suit or an anti-exposure suit of an appropriate size complying with paragraph 4.33 as appropriate to the Class of ship.

4.3.18 Public Address System:

- (a) Subject to sub-paragraph (b) every ship must be provided with a public address system complying with Schedule 11, Part 2.
- (b) Ships which are already fitted with a public address system which complies substantially with the requirements of paragraphs 1, 2, 3, 4, 6 and 7 of Part 2 of Schedule 11, are not required to change their system.

4.3.19 **Additional Carriage Requirements for Ro-Ro Passenger Ships of Class II**

- (a) Ro-ro passenger ships of Class II which were constructed before 1st July 1986 must comply with the requirements of sub-paragraphs (b), (c) and (d) and with the requirements of sub-paragraphs (aa), (bb), (cc) and (dd).
- (b) Liferafts on ro-ro ships must:
 - (i) be served by marine evacuation systems complying with the requirements of Schedule 5, Part 1 or launching appliances complying with the requirements of Schedule 6, Part 3, equally distributed on each side of the ship;
 - (ii) be provided with float-free launching arrangements complying with the requirements of Schedule 4, Part 8;
 - (iii) be fitted with a semi-rigid boarding ramp capable of supporting a person weighing 100 kgs; and
 - (iv) either be an automatic self-righting liferaft or be a canopied reversible liferaft which is stable in a seaway and is capable of operating safely whichever way up it is floating. Alternatively, and providing the existing liferafts comply with Schedule 4, the ship must carry automatic self-righting liferafts or canopied reversible liferafts, in addition to its normal complement of liferafts, of such aggregate capacity as will accommodate at least 50 per cent of the persons not accommodated in lifeboats. This additional liferaft capacity must be determined on the basis of the difference between the total number of persons on board and the number of persons accommodated in lifeboats.
- (aa) The liferafts carried on a ro-ro passenger ship must be fitted with sufficient radar transponders so that there is one radar transponder for every four liferafts.



- (bb) Subject to sub-paragraph (cc), a radar transponder fitted to a liferaft carried by a ro-ro passenger ship must be capable of:
 - (i) being mounted inside the liferaft so that the antenna of the radar transponder is more than one metre above sea level; and
 - (ii) being erected manually, after the liferaft is deployed.
 - (cc) Where a radar transponder is fitted to a canopied reversible liferaft, the radar transponder must be fitted so that those using the liferaft can readily gain access to and erect the radar transponder.
 - (dd) Every container of a liferaft which is fitted with a radar transponder must be clearly marked to indicate that the liferaft is so fitted.
- (c) Fast rescue boats:
- (i) At least one of the motor lifeboats provided pursuant to paragraph 4.3.4 or 4.3.5 must be a fast rescue boat complying with the requirements of Schedule 2, Part 10 except that ships having a rescue boat that is substantially in compliance with Schedule 2, Part 10 are not required to replace their rescue boat;
 - (ii) each fast rescue boat must be served by a suitable launching appliance complying with the requirements of Schedule 6, Part 1 and 2, and such launching appliances must take into account that the fast rescue boat is intended to be launched and retrieved even under severe adverse weather conditions;
 - (iii) at least two crews of each fast rescue boat must be trained, certified and drilled regularly having regard to the Merchant Shipping (Standards of Training, Certification and Watchkeeping) Regulations 2015 (S.I. 2015/782) including all aspects of rescue, handling, manoeuvring, operating these craft in various conditions, and righting them after capsizing; and
 - (iv) if the arrangement or size of the ship is such as to prevent the installation of the fast rescue boat required by sub-paragraph (c)(i), the fast rescue boat may be installed in place of an existing lifeboat which is accepted as a boat for use in an emergency, provided that all of the following conditions are met:
 - (aa) the fast rescue boat installed is served by a launching appliance complying with the provisions of sub-paragraph (c)(ii);
 - (bb) the capacity of the survival craft lost by the above substitution is compensated by the installation of liferafts capable of carrying at least an equal number of persons served by the lifeboat replaced;
 - (cc) such liferafts are served by the existing launching appliances or marine evacuation systems; and
 - (dd) every ship must carry, for every person assigned to crew of a fast rescue boat, an immersion suit or anti-exposure suit of an appropriate size and complying with paragraph 5.20.
- (d) Means of rescue:



- (i) Each ro-ro passenger ship must be equipped with an efficient means of rescue complying with the requirements of Schedule 5, Part 3 for rapidly recovering survivors from the water and transferring survivors from rescue units or survival craft to the ship;
 - (ii) the means of transfer of survivors to the ship may be part of a marine evacuation system, or may be part of a system designed for rescue purposes;
 - (iii) if the inclined passage of a marine evacuation system is intended to provide the means of transfer of survivors to the deck of the ship, the inclined passage must be equipped with handlines or ladders to aid in climbing up the inclined passage; and
 - (iv) a fast rescue boat launching and recovery appliance may be used as part of a means of rescue system.
- (e) A sufficient number of lifejackets must be stowed in the vicinity of the assembly stations so that passengers do not have to return to their cabins to collect their lifejacket.
- (f) A helicopter emergency pick-up area must be provided on a ro-ro ship complying with the requirements of IAMSAR

4.4 Ships of Class II(A)

- 4.4.1 Section 4.4 of this Notice applies to ships of Class II(A) the keels of which were laid, or which were at a similar stage of construction, before 1st July 1986.
- 4.4.2 Section 4.3 of this Notice (ships of Class II) applies to passenger ships of Class II(A) which were constructed before 1st July 1986 as it applies to ships of Class II.

4.5 Ships of Class VII

- 4.5.1 Section 4.5 of this Notice applies to ships of Class VII the keels of which were laid, or which were at a similar stage of construction, before 1st July 1986.
- 4.5.2 Subject to paragraph 4.5.5, every ship of 500 tons or over must carry on each side of the ship one or more lifeboats of sufficient aggregate capacity to accommodate all persons on board.
- 4.5.3 In every ship of 1,600 tons or over the lifeboats must be not less than 7.3 metres in length.
- 4.5.4 Subject to paragraph 4.5.5, every ship of 500 tons or over must carry liferafts of sufficient aggregate capacity to accommodate at least the total number of persons on board. At least two of the liferafts must be of approximately the same capacity.
- 4.5.5 In lieu of complying with paragraphs 4.5.2 and 4.5.4, every ship of 500 tons or over but under 1,600 tons, must carry:
- (a) liferafts on each side of the ship capable of being launched readily, and of sufficient aggregate capacity to accommodate the total number of persons on board; the liferaft capacity being approximately evenly divided. If these liferafts cannot be readily launched on each side of the ship, there must be provided additionally the



liferrafts prescribed in paragraph 4.5.4 stowed in accordance with paragraph 4.5.9; and

(b)

- (i) a motor lifeboat;
- (ii) a Class C boat fitted with a motor complying with Schedule 2, Part 3 of MSN 1677, if over 4.3 metres in length, or with Schedule 2, Part 4 of MSN 1677, if under 4.3 metres in length; or
- (iii) an inflated boat fitted with a motor complying with Schedule 4, Part 3 of MSN 1677.

The boat prescribed in sub-paragraph (b)(i), (ii) or (iii) must be capable of being launched on one side of the ship with its equipment and a launching crew of two persons when the ship is upright or listed up to 15 degrees towards the side on which the boat is fitted, and must be launched and recovered by a davit complying with the requirements of Schedule 10 or Schedule 11 of MSN 1677; where a winch is provided, it must comply with Schedule 10 of MSN 1677.

4.5.6 In every ship provided with the liferafts prescribed in paragraph 4.5.5(a), where the distance from the embarkation position to the water in the lightest sea-going condition exceeds 4.5 metres, the rafts must be of a type designed for use with a launching appliance. The launching appliances must comply with the requirements of paragraphs 4.24 of this Notice as appropriate to the class of ship and Schedule 11 of MSN 1677; at least one launching appliance must be provided on each side of the ship and not more than two liferafts must be allocated to each launching appliance.

4.5.7 Every ship of under 500 tons must carry either:

- (a) the lifeboats prescribed in paragraph 4.5.2 for ships of 500 tons or over and liferafts of sufficient aggregate capacity to accommodate all persons on board. Such ships with 16 persons or more on board must carry at least two liferafts; or
- (b) a lifeboat or Class C boat or inflated boat which must be capable of being launched on one side of the ship and at least two liferafts of sufficient aggregate capacity to accommodate twice the total number of persons on board.

4.5.8 Every ship where survival craft are stowed in a position which is more than 100 metres from the stem or stern must carry, in addition to the liferafts required by paragraph 4.5.4, a liferaft stowed as far forward or aft, or one as far forward and another as far aft, as is reasonable and practicable.

4.5.9 Liferafts carried pursuant to the requirements of paragraph 4.5, except those liferafts fitted in compliance with paragraph 4.5.5 (a), must be so stowed that they can be readily transferred to the water on either side of the ship.

4.5.10 In every ship to which paragraph 4.5.2 applies, each lifeboat must be attached to a separate set of davits which must be of the gravity type except that luffing davits may be fitted for operating lifeboats weighing not more than 2,300 kgs in their turning out condition.

4.5.11 In every ship of 1,600 tons or over, one of the lifeboats carried in compliance with paragraph 4.5.2 must be a motor lifeboat.

4.5.12 Every ship must be provided with the following equipment:



- (a) a satellite EPIRB;
- (b) in the case of a ship of 500 tons or over, at least 3 waterproofed two-way VHF radiotelephone apparatus; and in the case of a ship of under 500 tons, at least 2 waterproofed two-way VHF radiotelephone apparatus, in either case complying with standards not inferior to those contained in IMO Resolution A.762(18) or subsequent IMO Resolution on performance standards for survival craft two-way VHF Radiotelephone Apparatus); and
- (c) in the case of a ship of 500 tons or over, on each side of the ship at least one radar transponder; and in the case of a ship of 300 tons or over but under 500 tons, at least one radar transponder. The radar transponders must be stowed in such locations that they can rapidly be placed in any survival craft other than the liferaft or liferafts required by paragraph 4.5.8. Alternatively, one radar transponder must be stowed in each survival craft other than those required by paragraph 4.5.8.

4.5.13 Every ship of 500 tons or over must carry at least eight lifebuoys.

4.5.14 Every ship of less than 500 tons must carry at least four lifebuoys.

4.5.15 Lifejackets:

- (a) Every ship must carry a lifejacket appropriate for every person on board.
- (b) A sufficient number of additional lifejackets must be carried for the use of persons on watch and at remotely located survival craft stations, provided that there must be at least 4 additional lifejackets on ships where the number of persons on board is 16 or less, and at least an additional 25 per cent of the number of lifejackets required to be carried by subparagraph (a) in the case of ships where the number on board is more than 16, provided that the number of additional lifejackets need not exceed the number of persons on board.
- (c) Each lifejacket required to be carried by subparagraphs (a) and (b) must be fitted with a lifejacket light complying with the requirements of Schedule 9, Part 1.

4.5.16 Every ship must carry a line-throwing appliance.

4.5.17 Every ship, except a ship which complies with either sub-paragraphs 4.5.5(b) or 4.5.7(b), must carry for each lifeboat on the ship at least three immersion suits and, in addition, a thermal protective aid for every person on board not provided with an immersion suit, provided that immersion suits and thermal protective aids need not be carried if:

- (a) the lifeboats required under paragraph 4.5.2 and paragraph 4.5.7(a) are totally enclosed;
- (b) a totally enclosed lifeboat capable of free-fall launching is carried in lieu of the lifeboats required under paragraph 4.5.2 and paragraph 4.5.7(a); or
- (c) the ship is constantly engaged on voyages between the parallels of latitude of 20° North and South.

4.5.18 Every ship which complies either with paragraph 4.5.5(b) or 4.5.7(b) must be provided with an immersion suit for every person on board unless the ship is provided with davit-launched liferafts or a marine evacuation system, or is constantly engaged on voyages between parallels of latitude of 20° North and South



4.6 Ships of Class VII(A)

- 4.6.1 Section 4.6 of this Notice applies to ships of Class VII(A) the keels of which were laid, or which were at a similar stage of construction, before 1st July 1986.
- 4.6.2 Every ship must carry:
- (a) lifeboats on each side of the ship of sufficient aggregate capacity to accommodate one half of the total number of persons on board; or
 - (b) lifeboats and liferafts together providing sufficient aggregate capacity to accommodate the total number of persons on board, providing that there must never be less than sufficient lifeboats on each side of the ship to accommodate 37.5 per cent of the total number of persons on board.
- 4.6.3 Two of the lifeboats must be kept ready, one on each side of the ship, for immediate use in an emergency while the ship is at sea. These lifeboats must not be more than 8.5 metres in length and each of them may be a motor lifeboat and may be counted for the purpose of compliance with paragraph 4.6.4.
- 4.6.4 Every ship must carry on each side of the ship at least one motor lifeboat.
- 4.6.5 Every ship must be provided with the following equipment:
- (a) a satellite EPIRB;
 - (b) at least 2 waterproofed two-way VHF radiotelephone apparatus, complying with standards not inferior to those contained in IMO Resolution A.762(18) or subsequent IMO Resolution on performance standards for survival craft two-way VHF Radiotelephone Apparatus); and
 - (c) on each side of the ship, at least one radar transponder stowed in such a location that it can be rapidly placed in any survival craft or, alternatively, one radar transponder stowed in each survival craft.
- 4.6.6 Every motor lifeboat carried must be provided with the equipment specified in Schedule 12, Part 4 of MSN 1677.
- 4.6.7 In every ship of 1,600 tons or over the lifeboats must be not less than 7.3 metres in length.
- 4.6.8 Each lifeboat must be attached to a separate set of davits, which must be of the gravity type.
- 4.6.9 The liferafts carried in compliance with paragraph 4.6.2(b) must be served by launching appliances. There must never be less than one on each side of the ship, and the difference in the number of appliances fitted on each side must not exceed one.
- 4.6.10 Every ship must carry liferafts, which are not required to be served by launching devices, of sufficient aggregate capacity to accommodate at least half the total number of persons on board, provided that if liferafts in addition to those carried in compliance with this paragraph are carried in compliance with paragraph 4.6.2(b), all liferafts carried must be of a type capable of being launched by the appliances fitted in compliance with paragraph 4.6.9.



4.6.11 Every ship must carry at least eight lifebuoys.

4.6.12 Lifejackets:

- (a) Every ship must carry a lifejacket appropriate for every person on board.
- (b) A sufficient number of additional lifejackets must be carried for the use of persons on watch and at remotely located survival craft stations, provided that:
 - (i) there must be at least four additional lifejackets on ships where the number of persons on board is 16 or less, and at least an additional 25 per cent of the number of lifejackets required to be carried by subparagraph (a) in the case of ships where the number on board is more than 16;
 - (ii) the number of additional lifejackets need not exceed the number of persons on board.
- (c) Each lifejacket required to be carried by subparagraphs (a) and (b) must be fitted with a lifejacket light complying with the requirements of Schedule 9, Part 1.

4.6.13 Every ship must carry a line-throwing appliance.

4.6.14 Every ship must carry for each lifeboat on the ship at least three immersion suits and, in addition, a thermal protective aid for every person on board not provided with an immersion suit. Immersion suits and thermal protective aids need not be carried for persons to be accommodated in totally or partially enclosed lifeboats or on a ship which is constantly engaged on voyages between parallels of latitude of 20° North and South.

4.7 Ships of Class VII(T)

4.7.1 Section 4.7 of this Notice applies to ships of Class VII(T) the keels of which were laid, or which were at a similar stage of construction, before 1st July 1986.

4.7.2 Paragraphs 4.5.2, 4.5.3, 4.5.4, 4.5.7, 4.5.8, 4.5.9, 4.5.12, 4.5.13, 4.5.14, 4.5.15, 4.5.16, 4.5.17 and 4.5.18 apply to ships of Class VII(T) as they apply to ships of Class VII.

4.7.3 Every ship of 3,000 tons or over must carry on each side of the ship at least two lifeboats of sufficient aggregate capacity to accommodate the total number of persons on board. Two lifeboats must be carried aft and two amidships, except that in ships which have no amidships superstructure all lifeboats must be carried aft, unless it is impracticable to carry four lifeboats aft, in which case one lifeboat on each side of the ship may be permitted, on condition that:

- (a) each lifeboat must not exceed 8.5 metres in length;
- (b) each lifeboat must be stowed as far forward as practicable and so stowed that the aft end of the lifeboat is at least one-and-a-half times the length of the lifeboat forward of the ship's propeller; and
- (c) each lifeboat must be stowed as near the sea level as is safe and practicable.

4.7.4 In every ship to which paragraph 4.7.2 or 4.7.3 applies, each lifeboat must be attached to a separate set of davits, which must be of the gravity type, except that in ships of less than 1,600 tons luffing davits may be fitted for operating lifeboats weighing not more than 2,300 kgs in their turning out condition.



4.7.5 In every ship of 1,600 tons or over at least one of the lifeboats carried on each side of the ship in compliance with paragraph 4.5.2 or paragraph 4.7.3 must be a motor lifeboat.

4.8 Ships of Class VIII

4.8.1 Section 4.8 of this Notice applies to ships of Class VIII the keels of which were laid, or which were at a similar stage of construction, before 1st July 1986.

4.8.2 Section 4.5 of this Notice applies to ships of Class VIII as it applies to ships of Class VII.

4.9 Ships of Class VIII(T)

4.9.1 Section 4.9 of this Notice applies to ships of Class VIII(T) the keels of which were laid, or which were at a similar stage of construction, before 1st July 1986.

4.9.2 Section 4.7 of this Notice applies to ships of Class VIII(T) as it applies to ships of Class VII(T).

4.10 Ships of Class VIII(A)

4.10.1 Section 4.10 of this Notice applies to ships of Class VIII(A) the keels of which were laid, or which were at a similar stage of construction, before 1st July 1986.

4.10.2 Paragraphs 4.5.2, 4.5.4, 4.5.8 and 4.5.9 apply to ships of Class VIII(A) of 1,600 tons or over as they apply to ships of Class VII of 500 tons or over. Each lifeboat required through the application of those provisions must be not less than 7.3 metres in length.

4.10.3 Paragraphs 4.5.7 and 4.5.9 apply to ships of Class VIII(A) of under 1,600 tons as they apply to ships of Class VII of under 500 tons.

4.10.4 Paragraphs 4.5.12, 4.5.13, 4.5.14, 4.5.15, 4.5.16, 4.5.17 and 4.5.18 apply to ships of Class VIII(A) as they apply to ships of Class VII and paragraph 4.5.10 applies to such ships which carry lifeboats as required by paragraph 4.5.2.

4.11 Ships of Class VIII(A)(T)

4.11.1 This section applies to ships of Class VIII(A)(T) the keels of which were laid, or which were at a similar stage of construction, before 1st July 1986.

4.11.2 Paragraphs 4.5.2, 4.5.4, 4.5.8 and 4.5.9 apply to ships of Class VIII(A)(T) of 1,600 tons or over as they apply to ships of Class VII of 500 tons or over. Each lifeboat required through the application of those provisions must be not less than 7.3 metres in length.

4.11.3 Paragraphs 4.5.7 and 4.5.9 apply to ships of Class VII(T)(A) of under 1,600 tons as they apply to ships of Class VII of under 500 tons.

4.11.4 Paragraphs 4.7.2, 4.7.3 and 4.7.4 apply to ships of Class VIII(A)(T) as they apply to ships of Class VII(T).

4.11.5 Paragraphs 4.5.12, 4.5.13, 4.5.14, 4.5.15, 4.5.16, 4.5.17 and 4.5.18 applies to ships of Class VIII(A)(T) as they apply to ships of Class VII.

4.12 Ships of Class IX



- 4.12.1 Section 4.12 of this Notice applies to ships of Class IX the keels of which were laid, or which were at a similar stage of construction, before 1st July 1986.
- 4.12.2 Paragraphs 4.5.2, 4.5.4, 4.5.5, 4.5.6, 4.5.10 and 4.5.11 of this Notice apply to ships of Class IX of 500 tons or over, engaged on an international voyage, as they apply to ships of Class VII of 500 tons or over. Each lifeboat required through the application of those provisions must be not less than 7.3 metres in length.
- 4.12.3 Every ship, other than a ship of 500 tons or over engaged on an international voyage, must carry:
- (a) a lifeboat of Class C boat or inflated boat which must be capable of being launched on one side of the ship;
 - (b) one or more liferafts of sufficient aggregate capacity to accommodate the total number of persons on board, and in the case of a ship with 16 or more persons on board, at least two liferafts; and
 - (c) buoyant apparatus sufficient to support the total number of persons on board.
- 4.12.4 In every ship, liferafts (other than those fitted in compliance with paragraph 4.5.5(b)(i)) of this Notice must be so stowed that they can be readily transferred to the water on either side of the ship.
- 4.12.5 Paragraphs 4.5.12, 4.5.13, 4.5.14, 4.5.15, 4.5.16, 4.5.17 and 4.5.18 of this Notice apply to ships of Class IX as they apply to ships of Class VII.

4.13 Ships of Class IX(A)

- 4.13.1 Section 4.13 of this Notice applies to ships of Class IX(A) the keels of which were laid, or which were at a similar stage of construction, before 1st July 1986.
- 4.13.2 Every ship of 12.2 metres in length or over must, when in Category A, B, C and D waters, carry:
- (a) a boat or liferaft in either case sufficient to accommodate the total number of persons on board; and
 - (b) in the case of ships of 21.3 metres in length or over, at least four lifebuoys; and,
 - (c) in the case of ships of less than 21.3 metres in length but of not less than 12.2 metres in length, at least two lifebuoys.
- 4.13.3 Every ship of 12.2 metres in length or over when in Category A, B and C waters, and every such ship of less than 12.2 metres in length, must carry lifebuoys of a number at least equal in number to half the total number of persons on board, provided that ships of 21.3 metres in length or over carry at least four lifebuoys and ships of less than 21.3 metres in length carry at least two lifebuoys.
- 4.13.4 Every tug and tender must carry, in addition to the equipment required by paragraphs 4.13.2 and 4.13.3, buoyant apparatus sufficient to support the total number of persons on board.
- 4.13.5 Every ship of 12.2 metres in length or over must carry a lifejacket appropriate for every person on board.



4.13.6 Liferrafts carried in accordance with this section must be so stowed that they can be readily transferred to the water on either side of the ship.

4.14 Ships of Class IX(A)(T)

4.14.1 Section 4.14 of this Notice applies to ships of Class IX(A)(T) the keels of which were laid, or which were at a similar stage of construction, before 1st July 1986.

4.14.2 Section 4.13 of this Notice applies to ships of Class IX(A)(T) as it applies to ships of Class IX(A).

4.15 Ships of Class XI

4.15.1 Section 4.15 of this Notice applies to ships of Class XI the keels of which were laid, or which were at a similar stage of construction, before 1st July 1986.

4.15.2 Every ship must carry either:

(a)

(i) at least two lifeboats, attached to davits, so arranged that there is at least one lifeboat on each side of the ship, the lifeboats on each side of the ship being of sufficient aggregate capacity to accommodate one half of the total number of persons on board the ship; and

(ii) at least two liferafts on ships with 16 or more persons on board or at least one liferaft on ships with fewer than 16 persons on board, of sufficient aggregate capacity to accommodate the total number of persons on board; or

(b) a lifeboat of Class C boat or inflated boat which must be capable of being launched on one side of the ship and at least two liferafts of sufficient aggregate capacity to accommodate twice the total number of persons on board.

4.15.3 Liferrafts carried in accordance with this section must be so stowed that they can be readily transferred to the water on either side of the ship.

4.15.4 In every ship to which paragraph 4.15.2(a) applies, the lifeboat davits must be of the gravity type except that luffing davits may be fitted for operating lifeboats weighing not more than 2,300 kgs in their turning out condition.

4.15.5 Every ship must carry at least four lifebuoys.

4.15.6 Lifejackets:

(a) Every ship must carry a lifejacket appropriate for every person on board.

(b) A sufficient number of additional lifejackets must be carried for the use of persons on watch and at remotely located survival craft stations, and there must be at least four additional lifejackets on ships where the number of persons on board is 16 or less, and at least an additional 25 per cent of the number of lifejackets required to be carried by subparagraph (a) in the case of ships where the number on board is more than 16, provided that the number of additional lifejackets need not exceed the number of persons on board.

(c) Each lifejacket required to be carried by paragraphs (a) and (b) must be fitted with a lifejacket light complying with the requirements of Schedule 9, Part 1.



- 4.15.7 Every ship must carry a line-throwing appliance.
- 4.15.8 Every ship must be provided with the following equipment:
- (a) a satellite EPIRB;
 - (b) in the case of a ship of 500 tons or over, but under 1,600 tons at least 3 waterproofed two-way VHF radiotelephone apparatus and in the case of a ship of under 500 tons, at least 2 waterproofed two-way VHF radiotelephone apparatus of which at least one must be portable, in either case complying with standards not inferior to those contained in IMO Resolution A.762(18) or subsequent IMO Resolution on performance standards for survival craft two-way VHF Radiotelephone Apparatus; and
 - (c) in the case of a ship of 500 tons or over, but under 1,600 tons, on each side of the ship at least one radar transponder, and in the case of a ship of under 500 tons at least one radar transponder, and any such radar transponders must be stowed in such locations that they can rapidly be placed in any survival craft or, alternatively, one radar transponder must be stowed in each survival craft.
- 4.15.9 Every ship must carry for each lifeboat on the ship at least 3 immersion suits and, in addition, a thermal protective aid for every person on board not provided with an immersion suit. In the case of a ship which complies with paragraph 4.15.2(b) an immersion suit must be carried for every person on board. Immersion suits and thermal protective aids need not be carried if:
- (a) totally enclosed lifeboats are carried;
 - (b) davit-launched liferafts are carried; or
 - (c) the ship is constantly engaged on voyages between the parallels of latitude of 20° North and South.

4.16 Ships of Class XII

4.16.1 Section 4.16 of this Notice applies to ships of Class XII the keels of which were laid, or which were at a similar stage of construction, before 1st July 1986.

4.16.2 Every ship of 21.3 metres in length or over must carry:

- (a) at least two liferafts of sufficient aggregate capacity to accommodate twice the total number of persons on board;
- (b) at least four lifebuoys; and
- (c) a line-throwing appliance;

and every ship of 25.9 metres in length or over must carry in addition a lifeboat, Class C boat or inflated boat which must be capable of being launched on one side of the ship.

4.16.3 Every ship of less than 21.3 metres in length which is engaged on either a voyage to sea in the course of which it is more than 3 miles from the coast of the United Kingdom or a voyage to sea during the months of November to March inclusive, must carry:

- (a) one or more liferafts of sufficient aggregate capacity to accommodate the total number of persons on board; and



(b) at least two lifebuoys.

4.16.4 Every ship of less than 21.3 metres in length which does not proceed to sea or which only proceeds to sea during the months of April to October inclusive, on voyages in the course of which it is not more than 3 miles from the coast of the United Kingdom, must carry lifebuoys at least equal in number to half the total number of persons on board, provided that such ships must carry at least two lifebuoys and that any such ship which operates only in Category A, B and C waters must not be required to carry more than two lifebuoys.

4.16.5 Every ship of less than 21.3 metres in length must be provided with a buoyant line of at least 18 metres in length.

4.16.6 Liferrafts carried in accordance with this section must be so stowed that they can be readily transferred to the water on either side of the ship.

4.16.7 Lifejackets:

(a) Every ship must carry either:

- (i) a lifejacket appropriate for every person on board; or
- (ii) for every person on board, a lifejacket which complies with British Standard Specification BS 3595; 1981 or BS EN 394 and BS EN 3961994, provided it does not depend wholly upon oral inflation. If such lifejacket is of the partially inherently buoyant type, the buoyancy of the jacket in the uninflated state must be not less than 89 Newtons for every lifejacket for a person weighing 32 kilogrammes or more; and

(b) Each lifejacket required to be carried by sub-paragraphs (a) and (b) must be fitted with a lifejacket light complying with the requirements of Schedule 9, Part 1.

General Requirements

4.17 Inflated Boats

4.17.1 Where inflated boats are carried pursuant to the requirements of this Notice, the boats must be stowed in the inflated condition.

4.17.2 The lifting arrangements fitted on inflated boats must comply with the requirements of Schedule 4, Part 2 of MSN 1677.

4.18 Lifebuoys

4.18.1 Lifebuoys must comply with the requirements of Schedule 8, Part 2, except in those vessels described in paragraph 4.18.2.

4.18.2 Lifebuoys carried in ships of less than 16.8 metres in length, of Classes VIII, VIIIA(A)(T), IX, IX(A), IX(A)(T), XI and XII, must comply with the requirements of Schedule 8, Part 2 or Part 3. Lifebuoys carried must not be so mixed as to comprise at any one time lifebuoys complying with Part 2 and lifebuoys complying with Part 3 of Schedule 8 of MSN 1677.

4.18.3 If, in a ship described in paragraph 4.18.2, the lifebuoys comply with Schedule 8, Part 3, and the ship is one to which paragraphs 4.13.3 (Class IX(A)) or paragraph 4.16.4 (Class



XII) applies, lifebuoys must be carried equal in number to the total number of persons on board, but at no time less than two lifebuoys.

4.19 Lifebuoy Lights, Smoke Signals and Lines

4.19.1 Lifebuoys carried in ships (except ships of Classes IX(A) and IX(A)(T)) of less than 12.2 metres in length, must have attached to them self-igniting lights on the following scale:

- (a) in ships of Classes I, II and II(A), on at least half the lifebuoys and in no case on less than six;
- (b) in ships of Classes VII, VII(T), VIII, VIII(T), VIII(A), VIII(A)(T), IX and XI and in ships of Class VII(A) of 21.3 metres in length or over, on at least half the lifebuoys and in no case on less than two;
- (c) in ships of Classes IX(A), IX(A)(T) and XII of 21.3 metres in length or over, on two lifebuoys; and
- (d) in ships of Classes VII(A), IX(A), IX(A)(T) and XII of less than 21.3 metres in length, on one lifebuoy.

4.19.2

- (a) In every ship (except ships of Classes VII(A), IX(A), IX(A)(T) and XII of less than 21.3 metres in length) one lifebuoy on each side of the ship must have attached to it a buoyant line of at least 27.3 metres in length.
- (b) In ships of Classes VII(A), IX(A) and IX(A)(T) of less than 21.3 metres in length, one lifebuoy must have attached to it a buoyant line of at least 18.3 metres in length.
- (c) The lifebuoys having lines attached to them in compliance with this section must not have self-igniting lights attached.

4.19.3 Two of the lifebuoys to which self-igniting lights are attached in accordance with paragraphs 4.19.1(a), (b) and (c) and the lifebuoy to which a self-igniting light is attached in accordance with paragraph 4.19.1(d), must be provided with a self-activating smoke signal complying with the requirements of Schedule 8, Part 5.

4.19.4 Two of the lifebuoys provided with self-igniting lights in accordance with subparagraphs 4.19.1(a), (b) and (c) and self-activating smoke signals in accordance with paragraph 4.19.3, must be carried on each side of the ship and be capable of quick release from the navigating bridge.

4.20 Line-Throwing Appliances

4.20.1 Ships of less than 12 metres in length need not comply with the requirements for throwing appliances contained in paragraphs 4.2.13, 4.3.16, 4.5.16, 4.6.13 and 4.16.7.

4.21 Retro-reflective Material

4.21.1 Life-saving appliances carried on ships of Classes I to XI inclusive, and ships of Class XII which proceed to sea, must be fitted with retro-reflective material, and the dimensions and location of the retro-reflective material must be in accordance with Schedule 16.



4.22 Stowage and Handling of Life-Saving Appliances

- 4.22.1 The arrangement of each lifeboat, Class C boat, inflated boat, other boat, liferaft and article of buoyant apparatus must be such that it will not interfere with the operation of other life-saving appliances or impede in any way their prompt handling or the marshalling of persons at the launching stations or their embarkation.
- 4.22.2 Lifeboats, Class C boats, inflated boats, other boats, liferaft and buoyant apparatus must be so stowed that they can all be launched safely in the shortest possible time, and the overall launching period must not exceed 30 minutes in the case of:
- (a) ships of Classes I, II and II(A); and
 - (b) ships of Class VII(A) which carry liferafts under launching appliances.

4.23 Stowage and Handling of Lifeboats, Class C Boats, Inflated Boats and Other Boats

- 4.23.1 Subject to the provisions of paragraphs 4.23.2, 4.23.3 and 4.23.4, every lifeboat attached to a set of davits, other than a lifeboat which is carried as an alternative to a Class C boat, inflated boat or other boat, must be so arranged that, even under unfavourable conditions of trim and of up to 15 degrees of list either way, it can be put into the water when loaded with its full complement of persons and equipment required by these Regulations.
- 4.23.2 Any lifeboat which is carried as an alternative to a Class C boat, inflated boat or other boat, and any Class C boat, inflated boat or other boat which is attached to a davit or set of davits other than a mechanically controlled single arm davit, must be so arranged that when loaded with its equipment required by these Regulations and a launching crew of two persons, it can be put into the water on one side of the ship when the ship is upright or is listed to 15 degrees towards that side.
- 4.23.3 Every lifeboat, Class C boat, inflated boat, or other boat attached to a mechanically controlled single-arm davit must be so arranged that when loaded with its equipment required by this Notice, and a launching crew of two persons, it can be put into the water on one side of the ship when the ship is upright or is listed up to 15 degrees towards that side.
- 4.23.4 Every lifeboat or Class C boat carried in compliance with paragraph 4.5.5(b) or 4.5.7(b), 4.15.2, 4.17.3(a), 4.20.2(b) or 4.21.2, and every boat carried in compliance with paragraph 4.15.2, if not attached to a davit or set of davits, must be attached to a device which must be provided primarily for the purpose of launching the boat, and which must be capable of putting the boat into the water on one side of the ship when it is loaded with its equipment required by these Regulations and a launching crew of two persons, and when the ship is upright or is listed up to 15 degrees towards that side.
- 4.23.5 Every inflated boat carried in compliance with paragraph 4.5.5(b) or 4.5.7(b), 4.15.2, 4.17.3(a), 4.20.2(b) or 4.21.2 must be attached to a launching appliance, which must be capable of launching and recovering the inflated boat when the ship is upright or listed to 15 degrees towards the side on which the appliance is fitted, provided that the boat is so stowed that it is capable of being manhandled overboard without the use of the launching device.
- 4.23.6 Not more than one lifeboat, Class C boat, inflated boat or other boat must be attached to any davit, set of davits or other means of launching.



- 4.23.7 Lifeboats may be stowed on more than one deck on condition that proper measures are taken to prevent lifeboats on lower decks being fouled by those stowed on the decks above.
- 4.23.8 Lifeboats must be positioned as close to accommodation and service spaces as possible. They must be stowed in such positions as to ensure safe launching, having particular regard to clearance from the propeller, steeply overhanging portions of the hull, and the ability, so far as practicable, to be launched down the straight side of the ship. If positioned forward they must be stowed abaft the collision bulkhead in a sheltered position and the strength of the davits must be adequate for the location.
- 4.23.9 Davits must be suitably placed on the ship.
- 4.23.10 Davits, winches, falls, blocks and all other launching gear provided in accordance with this Notice must comply with the requirements of Schedule 10 or 11 of MSN 1677.
- 4.23.11
- (a) Subject to the proviso below, all lifeboats, Class C boats, inflated boats or other boats attached to davits must be served by wire rope falls and winches in the following cases:
 - (i) when they are attached to gravity davits;
 - (ii) when they are attached to mechanically controlled single-arm davits;
 - (iii) when they are fitted in any ship of Classes I or II, or in any ship of Class VII(A) in compliance with paragraph 4.6.2;
 - (iv) when they are fitted in any ship of Classes VII, VII(T), VIII, VIII(T) or IX in compliance with paragraphs 4.5.2, 4.5.5 or 4.5.7 (including those paragraphs as applied to such Classes); or
 - (v) when the weight of the attached lifeboat, Class C boat, inflated boat or other boat in the lowering condition exceeds 2,300 kgs.

The Secretary of State may permit other types of falls to be fitted, with or without winches, in cases other than emergency lifeboats, where satisfied that such falls are an adequate alternative.
 - (b) In every ship in which lifeboats, Class C boats, inflated boats or other boats are served by wire rope falls, winches must be provided for handling such falls.
 - (c) Emergency lifeboats carried in compliance with paragraphs 4.2.3, 4.3.4 or 4.6.3 must be served by winches which are capable of recovering them at a speed of not less than 0.3 metres per second when the lifeboat is loaded with its equipment required by this Notice and a distributed load equal to 1,000 kgs.
- 4.23.12 Efficient hand gear must be provided for the recovery of all lifeboats, Class C boats, inflated boats or other boats which are served by winches.
- 4.23.13 Where davits or other launching devices are recovered by action of the falls by power, safety devices must be fitted which will automatically cut off the power, if necessary, before the davits come against the stops to ensure that the wire rope falls or davits are not over-stressed.



4.23.14 Except in the case of lifeboats required by paragraphs 4.2.3, 4.3.4 and 4.6.3, to facilitate the launching of lifeboats against a list of 15 degrees, skates or other suitable means must be provided for any lifeboat stowed under davits which are of such strength that the lifeboat can be lowered with its full complement of persons and its equipment required by this Notice.

4.23.15 Means must be provided for bringing the lifeboats, which are required to be capable of being lowered in the fully loaded condition, against the ship's side and for holding them there for the safe embarkation of persons.

4.23.16 In ships other than ships in which the lifeboat, Class C boat, inflated boat or other boat is attached to a mechanically controlled single-arm davit, the davits must be fitted with a wire rope span so positioned that when the boat is in the lowering position the span is as near as practicable over the centre line of the boat. There must be at least two lifelines fitted to the span long enough to reach water with the ship at her lightest seagoing draught and listed to 15 degrees either way.

4.23.17

(a) Lifeboats, Class C boats, inflated boats and other boats attached to davits must have the falls ready for service, and the falls must be at least long enough to reach the water with the ship at her lightest sea-going draught and listed to 15 degrees either way.

(b) Means must be provided for detaching the lifeboats, Class C boats, inflated boats or other boats from the falls.

(c) Lower fall blocks, if provided, must be fitted with a suitable ring or long link for attaching to the sling hooks, unless disengaging gear complying with Schedule 2, Part 6 of MSN 1677 is fitted.

(d) The points of attachment of the Lifeboats, Class C boats, inflated boats and other boats to the falls must be at such height above the gunwale as to ensure stability when lowering the lifeboats, Class C boats, inflated boats or other boats.

4.23.18 Every emergency lifeboat carried in compliance with paragraph 4.2.3, 4.3.4 and 4.6.3 must be provided with means for facilitating the attachment of the lower fall blocks to the lifting arrangements of the boat when the boat is recovered from the sea in adverse weather conditions. For this purpose, a pendant of adequate strength and suitable length must be provided for each davit and one end of the pendant must be attached to the lower fall block and the other end to the lifting arrangement on the boat. Additionally, means must be provided for hanging off the boat after hoisting to enable the lower fall block to be attached directly to the lifting hook.

4.23.19 When:

(a) a lifeboat is attached to a davit, set of davits or other launching device which is not of sufficient strength for the lifeboat to be safely lowered into the water loaded with its full complement of persons and equipment required by this Notice under the conditions of trim and specified for the Class of ship, or

(b) a Class C boat, inflated boat or other boat is not of sufficient strength to be safely lowered into the water loaded with its full complement of persons and equipment required by this Notice, the davit or the launching device must be conspicuously marked with a red band 150 millimetres wide painted on a white background.

4.24 Stowage and Handling of Liferrafts, Buoyant Apparatus, Lifebuoys and Lifejackets



4.24.1 Liferrafts and buoyant apparatus must be stowed so that they can be put into the water safely even under unfavourable conditions of trim and of up to 15 degrees of list either way.

4.24.2

- (a) Launching appliances must be provided in every ship of Classes I, II, II(A) and VII(A) which carry liferafts in accordance with paragraphs 4.2.2(b), 4.3.8(c) or 4.6.2(b).
- (b) Every liferaft launching appliance must be so arranged that even under unfavourable conditions of trim and of up to 15 degrees of list either way each liferaft which is designed for use with such an appliance can be launched when loaded with its full complement of persons and equipment.
- (c) The requirements of paragraphs 4.23.8 apply to liferafts for which approved launching devices are required to be carried, as they apply to lifeboats.
- (d) Means must be provided for bringing liferafts for which launching appliances are provided against the ship's side and for holding them there for the safe embarkation of persons.

4.24.3

- (a) Lifebuoys must be so distributed as to be readily available on both sides of the ship and as far as practicable on all open decks extending to the ship's side. At least one lifebuoy must be placed in the vicinity of the stern.
- (b) Lifebuoys must be so stowed as to be capable of being rapidly cast loose, and must not be permanently secured in any way.
- (c) Except as otherwise provided, lifebuoys with lights and those with lights and smoke signals must be equally distributed on both sides of the ship.

4.24.4 Lifejackets must be so stowed as to be readily accessible to all persons on board. Their position must be clearly and permanently indicated.

4.25 Embarkation into Lifeboats, Class C Boats, Inflated Boats and Other Boats, and Liferrafts, and Assembly Stations

4.25.1 Arrangements must be made to ensure that it is possible to effect embarkation into the lifeboats, Class C boats, inflated boats and other boats, and liferafts rapidly and in good order.

4.25.2 In every ship, arrangements must be made for warning the passengers and crew when the ship is about to be abandoned.

4.25.3

- (a) In ships of Classes VII, VII(T), VIII, VIII(T), VIII(A)(T), IX, XI and XII one ladder must be carried at each set of lifeboat davits where the davits are capable of lowering the lifeboat when loaded with its full complement of persons and its equipment.
- (b) In ships of Classes I, II and II(A) and Class VII(A) similar provision must be made, except that in such ships such ladders may be replaced by suitable mechanical devices, provided that there must not be less than one ladder on each side of the ship,



- (c) In ships of Classes VII, VII(A), VII(T), VIII, VIII(A), VIII(A)(T), IX, XI and XII which carry a Class B boat or a lifeboat which is not capable of being lowered into the water when loaded with its full complement of persons and its equipment, suitable means must be provided for embarking persons into the boat.
- (d) In ships of Classes I, II, II(A) and VII(A) and in ships of Classes VII, VII(T), VIII, VIII(T) and IX of 500 tons or over, sufficient ladders or suitable mechanical devices must be provided to facilitate embarkation into the liferafts when waterborne.
- (e) Ladders provided in compliance with this paragraph must be of sufficient length to reach the water line with the ship at her lightest sea-going draught and listed to 15 degrees either way.

4.25.4 Ships of Classes I, II, II(A), VII, VII(A), VII(T), VIII, VIII(A), VIII(A)(T) and IX must be provided with means situated outside the engine room whereby any discharge of water into the lifeboats or into liferafts at fixed launching positions, including those under launching appliances, can be prevented.

4.25.5 For ro-ro passenger ships of Classes I, II and II(A), the term "muster station" must be replaced with "assembly station" on all signs and in all emergency procedure instructions.

4.26 Manning of Survival Craft

4.26.1 Section 4.26 of this Notice applies to ships of Classes I, II, II(A), VII, VII(A), VII(T), VIII, VIII(T) and ships of Classes IX and XI engaged on international voyages, the keels of which were laid, or which were at a similar stage of construction, before 1st July 1986.

4.26.2 There must be sufficient members of the crew to operate the survival craft and the launching arrangements when evacuating all on board. The minimum number of deck officers, certified persons and others for this purpose are determined in accordance with MSN 1682.

4.26.3 A deck-officer or certified person must be placed in charge, and a deck officer or certified person must be nominated second-in-command of each lifeboat to be used.

4.26.4 A deck officer or certified person must be placed in charge of each liferaft to be used. In ships of Class II and II(A), the person in charge may be a crew member practised in the handling and operation of liferafts.

4.26.5 The person in charge of survival craft must have a list of the survival craft crew and must ensure that the crew under his command are acquainted with their duties. In lifeboats the second-in-command must also have a list of the lifeboat crew.

4.26.6 In ships carrying liferafts served by launching appliances a deck officer or certified person must be assigned to each launching appliance.

4.26.7 In ships carrying liferafts not served by launching appliances a deck officer or certified person must be assigned to each launching position.

4.26.8 A person capable of operating the engine and carrying out minor adjustments must be assigned to every motor lifeboat.

4.26.9 A person capable of operating a radiotelegraph installation must be assigned to every lifeboat required to carry such equipment.



- 4.26.10 There must be a sufficient number of trained persons on board for mustering and assisting untrained persons.
- 4.26.11 The master must ensure the equitable distribution of persons referred to in paragraphs 4.26.2, 4.26.3, 4.26.4 and 4.26.10 when compiling the muster list referred to in—
- regulation 5(2) of the Merchant Shipping (Musters, Training and Decision Support Systems) Regulations 1999 (SI 1999/2722), for ships to which SOLAS does **not** apply; and
 - regulations 8.3 and 37 in Chapter III (muster list and emergency instructions), for ships to which SOLAS **does** apply.

4.27 Portable Radio Equipment

- 4.27.1 The two-way VHF radiotelephone apparatus required to be carried in compliance with paragraphs 4.2.5, 4.3.11, 4.5.12 and 4.15.5, which are not stowed in survival craft, must be kept in a suitable place ready to be moved into survival craft in case of emergency.
- 4.27.2 In ships where there is substantial fore and aft separation between superstructures or deck houses, the two-way VHF radiotelephone apparatus must not all be located in any one superstructure or deck house.

4.28 Electrically Operated Signals

- 4.28.1 Every ship of Class I must be provided throughout the ship with electrically operated signals controlled from the bridge for summoning passengers to assembly stations.

4.29 Electric Lighting

- 4.29.1 In every ship of Class I, II or II(A), an electric lighting system, operated from the ship's main generating plant and from the emergency source of power referred to in the Merchant Shipping (Passenger Ship Construction: Ships of Classes I, II and II(A)) Regulations 1998, must be provided throughout the ship and in particular so as to be capable of illuminating:
- (a) the decks from which lifeboats and liferafts are embarked;
 - (b) launching gear and lifeboats, and liferaft launching appliances where provided and the liferafts which they serve during the preparation for and process of launching;
 - (c) the water into which the lifeboats and liferafts are launched until the process of launching is completed; and
 - (d) the stowage position of those liferafts for which launching appliances are not provided.
- 4.29.2 In every ship of Class I, II or II(A), the exit from every main compartment occupied by passengers or crew must be continuously lighted by an emergency electric lamp, operated from the ship's main generating plant and from the emergency source of power referred to in the Merchant Shipping (Passenger Ship Construction: Ships of Classes I, II and II(A)) Regulations 1998.
- 4.29.3



- (a) In every ship of Classes VII, VII(A), VII(T), VIII and VIII(T) of 500 tons or over and in every ship of Class IX of such tonnage engaged on international voyages, provision must be made for electric lighting. In particular, during the preparation for and process of evacuation, electric lighting must illuminate the:
- (i) lifeboat davits and launching appliances;
 - (ii) lifeboats and liferafts;
 - (iii) the stowage position of liferafts for which launching appliances are not provided; and
 - (iv) the water into which lifeboats and liferafts are launched.
- (b) In every ship of Classes VII, VII(A), VII(T), VIII and VIII(T) of 1,600 tons or over and in every ship of Class IX of such tonnage engaged on international voyages, provision must be made for electric lighting of the alleyways, stairways and exits so as to ensure that access of all persons on board to the launching stations and stowage positions of lifeboats and liferafts is not impeded.
- (c) The lighting required by subparagraphs (a) and (b) must be operated from the ship's main electric generating plant and, in addition, must be capable of being operated in every such ship of 1,600 tons or over from an emergency source of electric power which must be provided for such lighting or in the case of a ship to which the Merchant Shipping (Cargo Ship Construction) Regulations 1997 (SI 1997/1509) applies, from the emergency source of electric power required by those Regulations.
- (d) In every ship of 500 tons or over but of under 1,600 tons, the lighting required by subparagraph (a) must be operated from the ship's main electric generating plant and in addition must be capable of being operated from:
- (i) an emergency source of electric power which must be provided for such lighting; or
 - (ii) in the case of any such ship to which the Merchant Shipping (Cargo Ship Construction) Regulations 1997 applies, from the emergency source of electric power required by those Regulations; or
 - (iii) if the Secretary of State permits, the reserve source of electrical energy required by the Merchant Shipping (Radio Installations) Regulations 1998 on condition that the lighting circuits can be readily disconnected and the said reserve source is capable of supplying the additional load or loads without falling below the capacity required by those Regulations.

4.29.4 In every ship of Classes VII, VII(A), VII(T), VIII, VIII(T) and IX to which paragraph 4.29.3 does not apply and in every ship of Classes VIII(A), VIII(A)(T), IX(A) and XI, means must be provided for the electric lighting of the launching gear and lifeboats or boats during the preparation for and process of launching and also for the lighting of the stowage position of the liferafts.

4.30 Ships' Distress Signals

4.30.1 Every ship, except ships of Classes IX(A) and IX(A)(T) and ships of Class XII, must carry not less than twelve parachute distress rocket signals.

4.30.2 Ships of Class IX(A) and IX(A)(T) operating in Category A, B, C and D waters must carry not less than six parachute distress rocket signals.



4.30.3 Ships of Class XII operating in Category A, B, C and D waters or which proceed to sea must carry not less than six parachute distress rocket signals.

4.31 Operational Instructions for Survival Craft and their Launching Controls

4.31.1 Except as otherwise provided in paragraph 4.31.3(a), paragraph 4.31 applies to ships of Classes I, II, II(A), VII, VII(A), VII(T), VIII, VIII(T), VIII(A), VIII(AO(T)), IX, IX(A), IX(A)(T), XI and XII which carry one or more lifeboats, Class C boats, other boats or liferafts.

4.31.2 Every ship must be provided:

- (a) on or in the vicinity of survival craft and their launching controls, with posters or signs illustrating the purpose of controls, the procedures for operating the appliance and giving relevant operating instructions;
- (b) with a training manual complying with the requirements of Schedule 14, Part 1 in each crew messroom and recreation room or in each crew cabin;
- (c) as far as practicable, with instructions complying with the requirements of Schedule 14, Part 2 for on-board maintenance of life-saving appliances or a shipboard planned maintenance programme which includes the maintenance of life-saving appliances.

4.31.3

- (a) Posters and signs must be easily able to be seen under emergency lighting conditions on ships of Classes I, II, II(A), VII, VII(A), VII(T), VIII, VIII(T) and IX to which paragraph 4.29.1, 4.29.2 or 4.29.3 applies, and where applicable they must use symbols which are specified in Schedule 16.
- (b) in ships of under 500 tons at least one training manual must be provided appropriate to the life-saving appliances carried and to the type and size of ship on which it is provided.

4.32 Replacement of Life-Saving Appliances

4.32.1 The requirements relating to the replacement of life-saving appliances for ships the keel of which was laid, or was at a similar stage of construction, on or before 1st July 1986, are contained in regulations 6 and 11 of the 2020 Regulations. Regulation 6 applies to all ships, whether engaged on international or non-international voyages, and regulation 11 applies solely to ships engaged on international voyages.

4.32.2 In addition to the requirements in the 2020 Regulations, paragraph 5 of regulation 1 in Chapter III of SOLAS requires all ships engaged on international voyages (which includes ships constructed before 1st July 1986), to replace all lifeboat on-load release mechanisms which do not comply with paragraphs 4.4.7.6.4 to 4.4.7.6.6 of the LSA Code with on-load release mechanisms that do comply with these paragraphs of the Code. This provision required all ships to comply with the requirement by 1st July 2019 and all ships must, therefore, now comply.

4.33 Immersion Suits and Anti-Exposure Suits

4.33.1 Immersion suits and anti-exposure suits required to be carried by this section may be of the insulated or uninsulated type, provided that immersion suits of the insulated type are carried on ships which make voyages:

- (a) north of latitude 65°N in the Atlantic Ocean;



- (b) north of latitude 55°C in the Pacific Ocean;
- (c) south of latitude 50°S; or
- (d) east of longitude 10°E in the Kattegat and Baltic Sea between 1st December and 30th April, both dates inclusive.

4.34 Servicing of Life-Saving Appliances

- 4.34.1 Every inflatable liferaft, inflatable lifejacket, hydrostatic release unit (other than a disposable unit) and marine evacuation system must be serviced at a service station accepted by the Secretary of State, at intervals not exceeding twelve months: provided that in any case where this is impracticable, such interval may be extended by a period not exceeding five months with the consent of the Secretary of State on application to the Maritime and Coastguard Agency at Spring Place, 105 Commercial Road, Southampton SO15 5EG.
- 4.34.2 Guidance is provided in Marine Guidance Notes 548 (M+F) and 553 (M+F) on servicing of life-saving appliances which are installed on board UK ships regarding how and when life-saving appliances must be serviced

5. Carriage requirements for existing ships in relation to life-saving appliances and arrangements on ships other than ships of Classes III to VI(A) constructed on or after 1st July 1986 and before 1st July 1998

5.1 Compliance

- 5.1.1 As per Part 2 of the 2020 Regulations, ships (other than those of Classes III to VI(A) constructed before 1st July 1998), must comply with the requirements carried over from the 1999 Regulations. These Regulations contained specific provisions (which are now set out in this Notice) for ships constructed on or after 1st July 1986 and before 1st July 1998 as they apply to the relevant ship class. Notwithstanding the general application of Part 2 of the 2020 Regulations, Chapter III of SOLAS contains requirements which are applicable to 'all ships' (irrespective of construction date). Where such a requirement applies to a ship within the scope of Part 2, the relevant requirement of Chapter III must be met (see regulation 10(2) of the 2020 Regulations).

The requirement for existing ships constructed on or after 1st July 1986 and before 1st July 1998 to comply with Chapter III in certain respects also means that updates to the referenced Convention provisions are ambulatory (as a consequence of regulation 5 in the 2020 Regulations). The applicable Chapter III requirements for existing ships include the requirements that were previously implemented by the Merchant Shipping (Musters, Training and Decision Support Systems) Regulations 1999 and the Merchant Shipping (Entry into Dangerous Spaces) Regulations 1988 – see paragraphs 3.6 to 3.8 above.

- 5.1.2 Where life-saving appliances or arrangements are of a novel nature, or subject to significant design changes, or the specifications or testing requirements are not considered to be sufficiently developed or experience of their usage is limited, the MCA must be contacted regarding the undertaking of the necessary approval procedure. For this purpose, the contact details at the end of this Notice should be used. In the case of novel life-saving arrangements, an engineering analysis must be carried out and provided to the MCA for consideration and approval.

5.2 Ships of Class I



5.2.1 Section 5.2 of this Notice applies to ships of Class I, the keels of which were laid, or which were at a similar state of construction, on or after 1st July 1986 and before 1st July 1998. As per Part 2 of the 2020 Regulations, ships (other than existing ships of Classes III to VI(A)) which were constructed before 1st July 1998, are required to comply with requirements which are carried over from the 1999 Regulations, which contained the following specific provisions for ships constructed on or after 1st July 1986 and before 1st July 1998, as they apply to the relevant ship class. Notwithstanding the general application of Part 2 of the 2020 Regulations, Chapter III of SOLAS contains requirements which are applicable to 'all ships' (irrespective of construction date). Where such a requirement applies to a ship within the scope of Part 2, the relevant requirement of SOLAS must be met. This requirement is implemented in regulation 10(2) of the 2020 Regulations. The requirement for existing ships constructed on or after 1st July 1986 and before 1st July 1998 to comply with SOLAS in certain respects also means that updates to the referenced Convention provisions are ambulatory (as a consequence of regulation 5 in the 2020 Regulations). The applicable SOLAS requirements for existing ships include the requirements that were previously implemented by the Merchant Shipping (Musters, Training and Decision Support Systems) Regulations 1999 and the Merchant Shipping (Entry into Dangerous Spaces) Regulations 1988 – see paragraphs 3.6 to 3.8 above.

5.2.2 Every ship must carry:

- (a) on each side of the ship lifeboats complying with the requirements of Schedule 2, Parts 3 and 4 of sufficient aggregate capacity to accommodate 50 per cent of the total number of persons which the ship is certified to carry; or
- (b) lifeboats and liferafts together providing sufficient aggregate capacity to accommodate the total number of persons which the ship is certified to carry, provided that there must never be less than sufficient lifeboats on each side of the ship to accommodate 37.5 per cent of the total number of persons which the ship is certified to carry; the liferafts must be served by launching appliances equally distributed on each side of the ship; and
- (c) in addition to the survival craft carried in compliance with subparagraph (a) or (b), liferafts of sufficient aggregate capacity to accommodate 25 per cent of the total number of persons which the ship is certified to carry. These liferafts must be served by at least one launching appliance on each side of the ship (which may be the appliances provided to comply with subparagraph (b)), or, if it is to be used on both sides, by appliances so approved.

5.2.3

- (a)
 - (i) Every ship of less than 500 tons carrying less than 200 persons may, in lieu of carrying the lifeboats and liferafts required by paragraph 5.2.2, carry on each side of the ship liferafts of sufficient aggregate capacity to accommodate the total number of persons the ship is certified to carry.
 - (ii) If these liferafts cannot be readily launched on either side of the ship, additional liferafts must be provided so that the total capacity available on each side will accommodate 150 per cent of the total number of persons which the ship is certified to carry.
 - (iii) All liferafts must be served by at least one launching appliance on each side of the ship.



- (b) If the rescue boat required by paragraph 5.2.4(b) is also a lifeboat it may be included in the aggregate capacity referred to in subparagraph (a).
- (c) The number and arrangement of survival craft must be such that in the event of any one survival craft being lost or rendered unserviceable, there must still be sufficient survival craft available for use on each side of the ship to accommodate the total number of persons the ship is certified to carry.

5.2.4

- (a) Every ship of 500 tons and over must carry at least one rescue boat on each side of the ship.
- (b) Every ship of less than 500 tons must carry at least one rescue boat.
- (c) A lifeboat may be accepted as a rescue boat provided it also complies with the requirements for a rescue boat.
- (d) Every ship must carry sufficient lifeboats and rescue boats to ensure that when evacuating the total number of persons the ship is certified to carry, a lifeboat or rescue boat should not need to marshal more than six liferafts.

5.2.5 Each lifeboat and rescue boat must be served by its own launching appliance.

5.2.6 Every ship must be provided with the following equipment:

- (a) a satellite EPIRB;
- (b) at least three waterproofed two-way VHF radiotelephone apparatus, complying with standards not inferior to those contained in IMO Resolution A.762(18) or subsequent IMO Resolution on performance standards for survival craft two-way VHF Radiotelephone Apparatus; and
- (c) on each side of the ship, at least one radar transponder stowed in such locations that it can be rapidly placed in any survival craft or, alternatively, one radar transponder stowed in each survival craft.

5.2.7

- (a) Every ship must carry at least the number of lifebuoys determined in accordance with the following table:

Length of ship in metres	Minimum number of lifebuoys
Under 60	8
60 or more but less than 120	12
120 or more but less than 180	18
180 or more but less than 240	24
240 and over	30

- (b) At least one lifebuoy on each side of the ship must be fitted with a buoyant lifeline. Not less than 50 per cent of the total number of lifebuoys, and on every ship of less than 60 metres in length not less than 6 lifebuoys, must be provided with self-igniting lights and not less than two of the lifebuoys provided with such lights must also be provided with self-activating smoke signals and be capable of quick release from the navigating bridge.

5.2.8 Every ship must carry:



- (a) for each person the ship is certified to carry, a lifejacket suitable for a person weighing 32 kilogrammes or more;
- (b) a lifejacket suitable for a person weighing less than 32 kilogrammes for each such person on board or for 10 per cent of the number of passengers the ship is certified to carry, whichever is the greater;
- (c) in addition to the lifejackets carried in compliance with subparagraphs (a) and (b), lifejackets suitable for persons weighing 32 kilogrammes or more for not less than 5 per cent of the total number of persons the ship is certified to carry which must be stowed in conspicuous places on the deck or at assembly stations; and
- (d) a sufficient number of lifejackets for persons on watch and for use at remotely located survival craft stations.

5.2.9 Included in the number of lifejackets required to be carried by paragraph 5.2.8 there must be at least sufficient inflatable lifejackets for the crew of each rescue boat and, for those crew members whose emergency duties require it, a lifejacket which will not unduly hinder them during the execution of these duties.

5.2.10 Each lifejacket required to be carried by paragraphs 5.2.8 and 5.2.9 must be fitted with a lifejacket light complying with the requirements of Schedule 9, Part 1.

5.2.11 Every ship must carry, for every person assigned to crew a rescue boat or assigned to the marine evacuation system party, an immersion suit or an anti-exposure suit of an appropriate size and comply with paragraph 5.20.

5.2.12 Every ship must carry not less than 12 rocket parachute flares.

5.2.13 Every ship must carry a line-throwing appliance.

5.2.14 Every ship must be provided with:

- (a) an emergency means for two-way communication (which may be fixed or portable equipment, or both) between emergency control stations, assembly and embarkation stations and strategic positions on board. This may be the equipment carried to comply with subparagraph 5.2.6(a);
- (b) a general emergency alarm system and, in addition, either a public address system or other suitable means of communication; and
- (c) lighting as specified in paragraphs 5.10.4, 5.10.5 and 5.13.8.

5.2.15 Every ship must be provided with:

- (a) posters or signs showing operating instructions on or in the vicinity of survival craft and their launching controls;
- (b) a training manual in each crew messroom and recreation room or in each crew cabin;
- (c) instructions for on-board maintenance of life-saving appliances or a shipboard planned maintenance programme which includes the maintenance of life-saving appliances; and
- (d) on the bridge, a copy of the table "Life-Saving Signals for Ships, Aircraft and Persons in distress" published by the Maritime and Coastguard Agency.



- 5.2.16 Every ship must be provided with a public address system complying with Schedule 11, Part 2 except that:
- (a) subject to the provisions of subparagraph (c), in ships constructed before 1st July 1997, only the requirements of Schedule 11, Part 2, paragraphs 1, 2, 3, 4, 6 and 7;
 - (b) in ships constructed on or after the 1st July 1997, the requirements of Schedule 11, Part 2 apply; and
 - (c) ships constructed before 1st July 1997 which are already fitted with a public address system which complies substantially with the requirements of Schedule 11, Part 2, paragraphs 1, 2, 3, 4, 6 and 7 are not required to change their system.

5.2.17

- (a) This paragraph applies to ro-ro passenger ships.
- (b) Liferafts on ro-ro ships must:
 - (i) be served by marine evacuation systems complying with the requirements of Schedule 5, Part 1 or launching appliances complying with the requirements of Schedule 6, Part 3 equally distributed on each side of the ship;
 - (ii) be provided with float-free launching arrangements complying with the requirements of Schedule 4, Part 8;
 - (iii) be of a type fitted with a semi-rigid boarding ramp, capable of supporting a person weighing 100 kgs;
 - (iv) must either be an automatic self-righting liferaft or be a canopied reversible liferaft which is stable in a seaway and is capable of operating safely whichever way up it is floating. Alternatively, the ship must carry automatic self-righting liferafts or canopied reversible liferafts, in addition to its normal complement of liferafts, of such aggregate capacity as will accommodate at least 50 per cent of the persons not accommodated in lifeboats. This additional liferaft capacity must be determined on the basis of the difference between the total number of persons on board and the number of persons accommodated in lifeboats.
 - (aa) The liferafts carried on a ro-ro passenger ship must be fitted with sufficient radar transponders so that there is one radar transponder for every four liferafts.
 - (bb) Subject to paragraph 5.2.17(cc), a radar transponder fitted to a liferaft carried by a ro-ro passenger ship must be capable of:
 - (i) being mounted inside the liferaft so that the antenna of the radar transponder is more than one metre above sea level, and
 - (ii) being erected manually,
 - (iii) after the liferaft is deployed.
 - (cc) Where a radar transponder is fitted to a canopied reversible liferaft, the radar transponder must be fitted so that those using the liferaft can readily gain access to and erect the radar transponder.



- (dd) Every container of a liferaft which is fitted with a radar transponder must be clearly marked to indicate that the liferaft is so fitted.
- (c) Fast rescue boats:
- (i) At least one of the rescue boats must be a fast rescue boat complying with the requirements of Schedule 2, Part 10 but where the ship already has a rescue boat that is substantially in compliance with Schedule 2, Part 10, it is not required to replace the rescue boat;
 - (ii) each fast rescue boat must be served by a suitable launching appliance complying with the requirements of Schedule 6, Parts 1 and 2; such launching appliances must take into account that the fast rescue boat is intended to be launched and retrieved even under severe adverse weather conditions;
 - (iii) at least two crews of each fast rescue boat must be trained and drilled regularly having regard to the Merchant Shipping (Standards of Training, Certification and Watchkeeping) Regulations 2015 including all aspects of rescue, handling, manoeuvring, operating these craft in various conditions, and righting them after capsizing; and
 - (iv) in the case where the arrangement or size of a ship constructed before 1st July 1997 is such as to prevent the installation of the fast rescue boat required by paragraph 5.2.17(c)(i), the fast rescue boat may be installed in place of an existing lifeboat which is accepted as a rescue boat on condition that:
 - (aa) the fast rescue boat installed is served by a launching appliance complying with the provisions of paragraph 5.2.17(c)(ii);
 - (bb) the capacity of the survival craft lost by the above substitution is compensated by the installation of liferafts capable of carrying at least an equal number of persons served by the liferaft replaced; and
 - (cc) such liferafts are served by the existing launching appliances or marine evacuation systems;
 - (dd) every ship must carry, for every person assigned to crew of a fast rescue boat, an immersion suit or anti-exposure suit of an appropriate size and complying with paragraph 5.20.
- (d) Means of rescue:
- (i) Each ro-ro passenger ship must be equipped with an efficient means of rescue complying with the requirements of Schedule 5, Part 3 for rapidly recovering survivors from the water and transferring survivors from rescue units or survival craft to the ship;
 - (ii) the means of transfer of survivors to the ship may be part of a marine evacuation system, or may be part of a system designed for rescue purposes;
 - (iii) if the inclined passage of a marine evacuation system is intended to provide the means of transfer of survivors to the deck of the ship, the inclined passage must be equipped with handlines or ladders to aid in climbing up the inclined passage;
 - (iv) a fast rescue boat launching and recovery appliance may be used as part of a means of rescue system.



- (e) A sufficient number of lifejackets must be stowed in the vicinity of the assembly stations so that passengers do not have to return to their cabins to collect their lifejacket.
- (d) A helicopter emergency pick-up area must be provided complying with the requirements of IAMSAR

5.3 Ships of Class II and II(A)

5.3.1 Section 5.3 of this Notice applies to ships of Classes II and II(A), the keels of which were laid, or which were at a similar state of construction, on or after 1st July 1986 and before 1st July 1998.

5.3.2 Every ship which is subdivided in accordance with the requirement of Schedule 2, Section 3 of MSN 1698(M) must carry:

- (a) lifeboats of sufficient aggregate capacity to accommodate at least 30 per cent of the total number of persons which the ship is certified to carry. Such lifeboats must be equally distributed, as far as practicable, on each side of the ship; and
- (b) liferafts of sufficient aggregate capacity that, together with the lifeboat capacity required by subparagraph (a), will accommodate the total number of persons which the ship is certified to carry. The liferafts must be served by launching appliances equally distributed on each side of the ship.

5.3.3 Every ship which is subdivided in accordance with the requirements of Schedule 2, Section 2 of MSN 1698(M) must carry:

- (a) on each side of the ship lifeboats of sufficient aggregate capacity to accommodate 50 per cent of the total number of persons which the ship is certified to carry; or
- (b) lifeboats complying with the requirements of Parts 3 and 4 of Schedule 2 and liferafts together providing sufficient aggregate capacity to accommodate the total number of persons which the ship is certified to carry, provided that there must never be less than sufficient lifeboats on each side of the ship to accommodate 37.5 per cent of the total number of persons which the ship is certified to carry. The liferafts must be served by launching appliances equally distributed on each side of the ship.

5.3.4 Every ship must carry, in addition to the survival craft carried in compliance with paragraph 5.3.2 or 5.3.3, liferafts of sufficient aggregate capacity to accommodate 25 per cent of the total number of persons which the ship is certified to carry. These liferafts must be served by at least one launching appliance on each side of the ship which may be the appliances carried in compliance with paragraph 5.3.2(b) or 5.3.3(b), or equivalent approved appliances capable of being used on both sides.

5.3.5

- (a)
 - (i) Every ship of less than 500 tons carrying less than 200 persons may, in lieu of carrying the lifeboats and liferafts required by paragraphs 5.3.2, 5.3.3 or 5.3.4 may carry on each side of the ship liferafts of sufficient aggregate capacity to accommodate the total number of persons the ship is certified to carry.
 - (ii) If these liferafts cannot be readily launched on either side of the ship additional liferafts must be provided so that the total capacity available on each side will



accommodate 150 per cent of the total number of persons which the ship is certified to carry.

- (iii) All liferafts must be served by at least one launching appliance on each side of the ship.
- (b) If the rescue boat required by paragraph 5.3.6(b) is also a lifeboat it may be included in the aggregate capacity referred to in subparagraph (a).
- (c) The number and arrangements of survival craft must be such that in the event of any one survival craft being lost or rendered unserviceable, there must still be sufficient survival craft available for use on each side of the ship to accommodate the total number of persons the ship is certified to carry.

5.3.6

- (a) Every ship of 500 tons and over must carry at least one rescue boat on each side of the ship.
- (b) Every ship of less than 500 tons must carry at least one rescue boat.
- (c) A lifeboat may be accepted as a rescue boat provided it also complies with the requirements for a rescue boat.
- (d) Every ship which is subdivided in accordance with the Merchant Shipping (Passenger Ship Construction: Ships of Classes I, II and II(A)) Regulations 1998 must carry sufficient lifeboats and rescue boats to ensure that when evacuating the total number of persons the ship is certified to carry, no lifeboat or rescue boat needs to marshal more than six liferafts.

5.3.7 Each lifeboat and rescue boat must be served by its own launching appliance.

5.3.8 Every ship must be provided with the following equipment:

- (a) a satellite EPIRB;
- (b) at least 3 waterproofed two-way VHF radiotelephone apparatus, complying with standards not inferior to those contained in IMO Resolution A.762(18) or subsequent IMO Resolution on performance standards for survival craft two-way VHF Radiotelephone Apparatus
- (c) on each side of the ship, at least one radar transponder stowed in such a location that it can be rapidly placed in any survival craft or, alternatively, one radar transponder stowed in each survival craft.

5.3.9

- (a) Every ship must carry at least the number of lifebuoys determined in accordance with the following table

Length of ship in metres	Minimum number of lifebuoys
Under 60	8
60 or more but less than 120	12
120 or more but less than 180	18
180 or more but less than 240	24
240 and over	30



- (b) At least one lifebuoy on each side of the ship must be fitted with a buoyant lifeline. Not less than 50 per cent of the total number of lifebuoys, and on every ship of less than 60 metres in length not less than 6 lifebuoys, must be provided with self-igniting lights and not less than two of the lifebuoys provided with such lights must also be provided with self-activating smoke signals and be capable of quick release from the navigating bridge.

5.3.10 Every ship must carry:

- (a) for each person the ship is certified to carry, a lifejacket suitable for a person weighing 32 kilogrammes or more;
- (b) a lifejacket suitable for a person weighing less than 32 kilogrammes for each such person on board or for 10 per cent of the number of passengers the ship is certified to carry, whichever is the greater;
- (c) in addition to the lifejackets carried in compliance with subparagraphs (a) and (b) lifejackets suitable for persons weighing 32 kilogrammes or more for not less than 5 per cent of the total number of persons the ship is certified to carry which must be stowed in conspicuous places on deck or at assembly stations;
- (d) a sufficient number of lifejackets for persons on watch and for use at remotely located survival craft stations; and
- (e) each lifejacket required to be carried by subparagraphs (a) and (b) must be fitted with a lifejacket light complying with the requirements of Schedule 9, Part I.

5.3.11 Included in the number of lifejackets required to be carried by paragraph 5.3.10, there must be at least sufficient inflatable lifejackets for the crew of each rescue boat and for those crew members whose emergency duties require a lifejacket which will not unduly hinder them during the execution of these duties.

5.3.12 Every ship must carry, for every person assigned to crew a rescue boat or assigned to the marine evacuation system party, an immersion suit or an anti-exposure suit of an appropriate size complying with paragraph 5.20.

5.3.13 Every ship must carry not less than 12 rocket flares.

5.3.14 Every ship must carry a line-throwing appliance.

5.3.15 Every ship must be provided with:

- (a) an emergency means for two-way communication (which may be fixed or portable) between emergency control stations, assembly and embarkation stations and strategic positions on board. This may be the equipment which is carried in compliance with paragraph 5.3.8(a);
- (b) a general emergency alarm system and, in addition, either a public address system or other suitable means of communication; and
- (c) lighting as specified in paragraphs 5.10.4, 5.10.5 and 5.13.8.

5.3.16 Every ship must be provided:

- (a) with posters or signs showing operating instructions; on or in the vicinity of survival craft and their launching controls;



- (b) with a training manual in each crew messroom and recreation room or in each crew cabin;
- (c) with instructions for on-board maintenance of life-saving appliances or a shipboard planned maintenance programme which includes the maintenance of life-saving appliances; and
- (d) on the bridge, with a copy of the table "Life-Saving Signals for Ships, Aircraft and Persons in distress" published by the Maritime and Coastguard Agency.

5.3.17 Every ship must be provided with a public address system complying with Schedule 11, Part 2, except that ships constructed before 1st July 1997 which are already fitted with a public address system which complies substantially with the requirements of Schedule 11, Part 2, paragraphs 1, 2, 3, 4, 6 and 7 are not required to change their system.

5.3.18

(a) This paragraph applies to ro-ro passenger ships. Such ships must comply with the requirements of sub-paragraphs (b), (c) and (d).

(b) Liferafts must:

(i) be served by marine evacuation systems complying with the requirements of Schedule 5, Part 1 or launching appliances complying with the requirements of Schedule 6, Part 3 equally distributed on each side of the ship;

(ii) be provided with float-free launching arrangements complying with the requirements of Schedule 4, Part 8;

(iii) be fitted with a semi-rigid boarding ramp capable of supporting a person weighing 100 kgs; and

(iv) either be an automatic self-righting liferaft or be a canopied reversible liferaft which is stable in a seaway and is capable of operating safely whichever way up it is floating. Alternatively, and providing the existing liferafts comply with Schedule 4, the ship must carry automatic self-righting liferafts or canopied reversible liferafts, in addition to its normal complement of liferafts, of such aggregate capacity as will accommodate at least 50 per cent of the persons not accommodated in lifeboats. This additional liferaft capacity must be determined on the basis of the difference between the total number of persons on board and the number of persons accommodated in lifeboats.

(aa) The liferafts carried on a ro-ro passenger ship must be fitted with sufficient radar transponders so that there is one radar transponder for every four liferafts.

(bb) Subject to paragraph 5.3.18(cc), a radar transponder fitted to a liferaft carried by a ro-ro passenger ship must be capable of:

(i) being mounted inside the liferaft so that the antenna of the radar transponder is more than one metre above sea level, and

(ii) being erected manually,

after the liferaft is deployed.



- (cc) Where a radar transponder is fitted to a canopied reversible liferaft, the radar transponder must be fitted so that those using the liferaft can readily gain access to and erect the radar transponder.
 - (dd) Every container of a liferaft which is fitted with a radar transponder must be clearly marked to indicate that the liferaft is so fitted.
- (c) Fast rescue boats:
- (i) At least one of the rescue boats provided pursuant to paragraph 5.3.6 must be a fast rescue boat complying with the requirements of Schedule 2, Part 10, except that ships having a rescue boat that is substantially in compliance with Schedule 2, Part 10 are not required to replace their rescue boats;
 - (ii) each fast rescue boat must be served by a suitable launching appliance complying with the requirements of Schedule 6, Part 1 and 2, such launching appliances must take into account that the fast rescue boat is intended to be launched and retrieved even under severe adverse weather condition;
 - (iii) at least two crews of each fast rescue boat must be trained, certified and drilled regularly having regard to the Merchant Shipping (Standards of Training, Certification and Watchkeeping) Regulations 2015 including all aspects of rescue, handling, manoeuvring, operating these craft in various conditions, and righting them after capsize; and
 - (iv) if the arrangement or size of the ship is such as to prevent the installation of the fast rescue boat required by subparagraph (c)(i), the fast rescue boat may be installed in place of an existing lifeboat which is accepted as a boat for use in an emergency, provided that all of the following conditions are met:
 - (aa) the fast rescue boat installed is served by a launching appliance complying with the provisions of paragraph 5.3.18(c)(ii);
 - (bb) the capacity of the survival craft lost by the above substitution is compensated by the installation of liferafts capable of carrying at least an equal number of persons served by the lifeboat replaced;
 - (cc) such liferafts are served by the existing launching appliances or marine evacuation systems; and
 - (dd) every ship must carry, for every person assigned to crew of a fast rescue boat, an immersion suit or anti-exposure suit of an appropriate size and complying with paragraph 5.20.
- (d) Means of rescue:
- (i) Each ship must be equipped with an efficient means of rescue complying with the requirements of Schedule 5, Part 3 for rapidly recovering survivors from the water and transferring survivors from rescue units or survival craft to the ship;
 - (ii) the means of transfer of survivors to the ship may be part of a marine evacuation system, or may be part of a system designed for rescue purposes;
 - (iii) if the inclined passage of a marine evacuation system is intended to provide the means of transfer of survivors to the deck of the ship, the inclined passage must be equipped with handlines or ladders to aid in climbing up the inclined passage; and



- (iv) a fast rescue boat launching and recovery appliance may be used as part of a means of rescue system.
- (e) Lifejackets.

A sufficient number of lifejackets must be stowed in the vicinity of the assembly stations so that passengers do not have to return to their cabins to collect their lifejacket.
- (f) Helicopter emergency pick-up area.

A helicopter emergency pick-up area must be provided on a ro-ro ship complying with the requirements of IAMSAR.

5.4 Ships of Classes VII, VIII, VIII(A) and XI

5.4.1 Section 5.4 of this Notice applies to ships of Classes VII, VIII, VIII(A) and IX the keels of which were laid, or were at a similar stage of construction, on or after 1st July 1986 and before 1st July 1998.

5.4.2 Every ship must carry:

- (a) on each side of the ship one or more lifeboats complying with the requirements of Schedule 2, Part 4 of sufficient aggregate capacity to accommodate the total number of persons on board: provided that the Secretary of State may permit the carriage of lifeboats complying with the requirements of Schedule 2, Part 3 in lieu of Part 4 on ships operating solely under favourable climatic conditions and in suitable areas; and
- (b) one or more liferafts capable of being launched on either side of the ship and of sufficient aggregate capacity to accommodate the total number of persons on board; if the liferaft or liferafts cannot be readily transferred for launching on either side of the ship, the total capacity available on each side must be sufficient to accommodate the total number of persons on board.

5.4.3 In lieu of complying with the requirements of paragraph (2) ships may carry:

- (a) one or more lifeboats complying with the requirements of Schedule 2, Part 9, capable of free-fall launching over the stern of the ship of sufficient aggregate capacity to accommodate the total number of persons on board; and
- (b) on each side of the ship one or more liferafts of sufficient aggregate capacity to accommodate the total number of persons on board. The liferafts on at least one side of the ship must be served by launching appliances.

5.4.4

- (a) Every ship of less than 85 metres in length may, in lieu of carrying the lifeboats and liferafts required by paragraph 5.4.2 or 5.4.3, carry on each side of the ship one or more liferafts of sufficient aggregate capacity to accommodate the total number of persons on board.
- (b) If these liferafts cannot be readily transferred for launching on either side of the ship, the total capacity available on each side must be sufficient to accommodate 150 per cent of the total number of persons on board.



- (c) If the rescue boat required by paragraph 5.4.6 is also a totally enclosed lifeboat complying with the requirements of Schedule 2, Parts 3 or 4, its capacity may be included in the aggregate capacity required by sub-paragraph (a), provided that the total capacity available on either side of the ship is at least 150% of the total number of persons on board.
- (d) The number and arrangement of survival craft must be such that in the event of any one survival craft being lost or rendered unserviceable there must be sufficient survival craft available for use on each side of the ship to accommodate the total number of persons on board.

5.4.5 Where survival craft are stowed in a position which is more than 100 metres from the stem or stern there must be carried, in addition to the liferafts required by paragraph 5.4.2(b) or 5.4.3(b), a liferaft stowed as far forward or aft, or one as far forward and another as far aft, as is reasonable and practicable.

5.4.6 Every ship of 500 tons or over must carry at least one rescue boat. Every ship of less than 500 tons must carry at least one rescue boat, or inflated boat fitted with an engine. A lifeboat may be accepted as a rescue boat, provided that it also complies with the requirements for a rescue boat.

5.4.7 Each lifeboat, rescue boat and inflated boat must be served by its own launching appliance.

5.4.8 Every tug of Class IX other than a tug of 500 tons or over engaged on an international voyage, must in addition to complying with the requirements of paragraphs 5.4.2, 5.4.3 or 5.4.4, and with the requirements of paragraph 5.4.6, carry buoyant apparatus sufficient to support the total number of persons on board.

5.4.9 Every ship must be provided with the following equipment:

- (a) a satellite EPIRB;
- (b) in the case of a ship of 500 tons or over, at least 3 waterproofed two-way VHF radiotelephone apparatus and, in the case of a ship of under 500 tons, at least 2 waterproofed two-way VHF radiotelephone apparatus, complying with standards not inferior to those contained in IMO Resolution A.762(18) or subsequent IMO Resolution on performance standards for survival craft two-way VHF Radiotelephone Apparatus; and
- (c) in the case of a ship of 500 tons or over, on each side of the ship at least one radar transponder and, in the case of a ship of 300 tons and under 500 tons, at least one radar transponder. The radar transponder must be stowed in such a location that it can be rapidly placed in any survival craft other than the liferaft or liferafts required by paragraph 5.4.5 or, alternatively, one radar transponder must be stowed in each survival craft other than those required by paragraph 5.4.5.

5.4.10

- (a) Every ship must carry at least the number of lifebuoys determined in accordance with the following table:

Length of ship in metres	Minimum number of lifebuoys
Under 100	8
100 or more but less than 150	10
150 or more but less than 200	12



provided that in ships under 100 metres in length and less than 500 tons, not more than 4 lifebuoys need to be carried.

- (b) at least one lifebuoy on each side of the ship must be fitted with a buoyant lifeline. Not less than 50 per cent of the total number of lifebuoys must be provided with self-igniting lights and not less than two of the lifebuoys provided with such lights must also be provided with self-acting smoke signals and be capable of quick release from the navigating bridge.

5.4.11 Every ship must carry:

- (a) for each person on board, a lifejacket suitable for a person weighing 32 kilogrammes or more;
- (b) a lifejacket suitable for a person weighing less than 32 kilogrammes for each such person on board, provided that there must never be less than 2 such lifejackets on any ship which ever carries children; and
- (c) additional lifejackets for the use of persons on watch and at remotely located survival craft stations. There must be at least 4 additional lifejackets on ships where the number of persons on board is 16 or less, and at least an additional 25 per cent of the number of lifejackets required to be carried by subparagraph (a) in the case of ships where the number on board is more than 16; provided that the number of additional lifejackets need not exceed the number of persons on board.

5.4.12 Included in the number of lifejackets required by paragraph 5.4.11 to be carried there must be at least sufficient inflatable lifejackets for the crew of the rescue boat and for those crew members whose emergency duties require a lifejacket which will not unduly hinder them during the execution of these duties.

5.4.13 Each lifejacket required to be carried by paragraphs 5.4.11 and 5.4.12 must be fitted with a lifejacket light complying with the requirements of Schedule 9, Part 1.

5.4.14 Every ship must carry, for every person assigned to crew the rescue boat or inflated boat, an immersion suit or anti-exposure of an appropriate size complying with paragraph 5.20.

5.4.15

- (a) Every ship which carries survival craft as prescribed in paragraph 5.4.4(a) must carry an immersion suit as specified in paragraph 5.20 for every person on board unless:
 - (i) the liferafts are served by launching appliances;
 - (ii) the liferafts are served by equivalent appliances capable of being used on both sides of the ship and which do not require entry into the water to board the liferaft; or,
 - (iii) the ship is constantly engaged on voyages between the parallels of latitude of 20° North and South.
- (b) The immersion suits required by this paragraph may be used to comply with the requirements of paragraph 5.4.14.

5.4.16 Every ship must carry not less than 12 rocket parachute flares.



- 5.4.17 Every ship of 12 metres in length and over must carry a line-throwing appliance.
- 5.4.18 Every ship must be provided with:
- (a) an emergency means for two-way communication (which may be fixed or portable equipment or both) between emergency control stations, assembly and embarkation stations and strategic positions on board. This may be the equipment carried in compliance with paragraph 5.4.9(a);
 - (b) a general emergency alarm system, except that in ships of less than 45.7 metres in length the additional electrically operated means referred to in Schedule 11, Part 1 need not be provided; in addition, in ships of 500 tons or over, either a public address system or other suitable means of communication; and
 - (c) lighting as specified in paragraphs 5.10.4, 5.10.5 and 5.13.8, provided that in ships of less than 500 tons such lighting need only be provided from one source of electrical power.
- 5.4.19 Every ship must be provided:
- (a) with posters or signs showing operating instructions, in the vicinity of survival craft and their launching controls;
 - (b) with a training manual in each crew messroom and recreation room or in each crew cabin;
 - (c) with instructions for on-board maintenance of life-saving appliances or a shipboard planned maintenance programme which includes the maintenance of life-saving appliances; and
 - (d) on the bridge, with a copy of the table, "Life-Saving Signals for Ships, Aircraft and Persons in distress" published by the Maritime and Coastguard Agency.

5.5 Ships of Classes VII(T), VIII(T) and VIII(A)(T)

- 5.5.1 Section 5.5 of this Notice applies to ships of Classes VII(T), VIII(T) and VIII(A)(T) the keels of which were laid, or were at a similar stage of construction, on or after 1st July 1986 and before 1st July 1998.
- 5.5.2 Every ship carrying cargo which emits toxic vapours or gases must carry on each side of the ship one or more lifeboats complying with the requirements of Schedule 2, Part 5 of sufficient aggregate capacity to accommodate the total number of persons on board.
- 5.5.3 Every ship carrying cargo having a flashpoint not exceeding 60°C (closed cup test) must carry on each side of the ship one or more lifeboats complying with the requirements of Part 6 of Schedule 2 of sufficient aggregate capacity to accommodate the total number of persons on board.
- 5.5.4 Every ship must carry, in addition to the lifeboats required by paragraph 5.5.2 or 5.5.3, one or more liferafts capable of being launched on either side of the ship of sufficient capacity to accommodate the total number of persons on board. If the liferaft or liferafts cannot be readily launched on either side of the ship, the total capacity available on each side must be sufficient to accommodate the total number of persons on board.
- 5.5.5 In lieu of complying with the requirements of paragraphs 5.5.2 and 5.5.4, ships carrying cargoes emitting toxic vapours or gases may carry:



- (a) one or more lifeboats complying with the requirements of Schedule 2, Part 5, capable of free-fall launching over the stern of the ship of sufficient capacity to accommodate the total number of persons on board; and
- (b) one or more liferafts on each side of the ship of sufficient capacity to accommodate the total number of persons on board. The liferafts on at least one side of the ship must be served by launching appliances.

5.5.6 In lieu of complying with the requirements of paragraphs 5.5.3 and 5.5.4, ships carrying cargoes having a flashpoint not exceeding 60°C (closed cup test) may carry:

- (a) one or more lifeboats complying with the requirements of Schedule 2, Part 6 capable of free-fall launching over the stern of the ship of sufficient capacity to accommodate the total number of persons on board; and
- (b) one or more liferafts on each side of the ship of sufficient capacity to accommodate the total number of persons on board. The liferafts on at least one side of the ship must be served by launching appliances.

5.5.7

- (a) Every ship of less than 500 tons may, in lieu of carrying the lifeboats and liferafts required by paragraphs 5.5.2, 5.5.3, 5.5.4, 5.5.5 or 5.5.6, carry one or more liferafts on each side of the ship of sufficient capacity to accommodate the total number of persons on board.
- (b) If such liferafts cannot be readily launched on either side of the ship, the total capacity available on each side must be sufficient to accommodate 150 per cent of the total number of persons on board.
- (c) If the rescue boat required by paragraph 5.5.9 is also a lifeboat complying with the requirements of Schedule 2, Part 5 or 6, it may be included in the capacity referred to in subparagraph (a): provided that the total capacity available on either side of the ship is at least 150 per cent of the total number of persons on board.
- (d) The number and arrangement of survival craft must be such that in the event of any one survival craft being lost or rendered unserviceable, there must be sufficient survival craft available for use on each side to accommodate the total number of persons on board.

5.5.8 Where survival craft are stowed in a position which is more than 100 metres from the stem to stern, there must be carried, in addition to the liferafts required by paragraph 5.5.4 or paragraph 5.5.5(b) or 5.5.6(b), a liferaft stowed as far forward or aft as is reasonable and practicable.

5.5.9 Every ship of 500 tons or over must carry at least one rescue boat. Every ship of less than 500 tons must carry at least one rescue boat, or inflated boat fitted with an engine. A lifeboat may be accepted as a rescue boat, provided that it also complies with the requirements for a rescue boat.

5.5.10 Each lifeboat, rescue boat and inflated boat must be served by its own launching appliance.

5.5.11 Every ship must be provided with the following equipment:

- (a) a satellite EPIRB;



- (b) in the case of a ship of 500 tons or over, at least 3 waterproofed two-way VHF radiotelephone apparatus and, in the case of a ship of under 500 tons, at least 2 waterproofed two-way VHF radiotelephone apparatus, in neither case inferior to those contained in IMO Resolution A.762(18) or subsequent IMO Resolution on performance standards for survival craft two-way VHF Radiotelephone Apparatus; and
- (c) in the case of a ship of 500 tons or over, on each side of the ship at least one radar transponder, and in the case of a ship of 300 tons or over and under 500 tons at least one radar transponder. Each radar transponder must be stowed in such a location that it can be rapidly placed in any survival craft other than the liferaft or liferafts required by paragraph 5.5.8 or, alternatively, one radar transponder must be stowed in each survival craft other than those required by paragraph 5.5.8.

5.5.12

- (a) Every ship must carry at least the number of lifebuoys determined in accordance with the following table:

Length of ship in metres	Minimum number of lifebuoys
Under 100	8
100 or more but less than 150	10
150 or more but less than 200	12
200 and over	14

provided that in ships under 100 metres in length and less than 500 tons, not more than 4 lifebuoys need to be carried.

- (b) At least one lifebuoy on each side of the ship must be fitted with a buoyant lifeline. Not less than 50 per cent of the total number of lifebuoys must be provided with self-igniting lights of an electric battery type and not less than two of the lifebuoys provided with such lights must also be provided with self-activating smoke signals and be capable of quick release from the navigating bridge.

5.5.13

Every ship must carry:

- (a) for each person on board, a lifejacket suitable for a person weighing 32 kilogrammes or more;
- (b) a lifejacket suitable for a person weighing less than 32 kilogrammes for each such person on board, provided that there must never be less than 2 such lifejackets on any ship which ever carries children; and
- (c) additional lifejackets for the use of persons on watch and at remotely located survival craft stations. There must be at least 4 additional lifejackets on ships where the number of persons on board is 16 or less, and at least an additional 25 per cent of the number of lifejackets required to be carried by subparagraph (a) in the case of ships where the number on board is more than 16: provided that the number of additional lifejackets need not exceed the number of persons on board.

5.5.14

Included in the number of lifejackets required by paragraph 5.5.13 to be carried there must be at least sufficient inflatable lifejackets for the crew of the rescue boat and for those crew members whose emergency duties require a lifejacket which will not unduly hinder them during the execution of those duties.

5.5.15

Each lifejacket required to be carried by paragraphs 5.5.13 and 5.5.14 must be fitted with a lifejacket light complying with the requirements of Schedule 9, Part 1.



- 5.5.16 Every ship must carry, for every person assigned to crew the rescue boat or inflated boat, an anti-exposure suit or immersion suit of an appropriate size and complying with paragraph 5.20.
- 5.5.17
- (a) Every ship which carries survival craft as prescribed in paragraph 5.5.7(a), must carry an immersion suit complying with paragraph 5.20 for every person on board unless:
 - (i) the liferafts are served by launching appliances;
 - (ii) the liferafts are served by equivalent appliances capable of being used on both sides of the ship and which do not require entry into the water to board the liferaft; or,
 - (iii) the ship is constantly engaged on voyages between the parallels of latitude of 20° North and South.
 - (b) The immersion suits required by this paragraph may be used to comply with the requirements of paragraph 5.5.16.
- 5.5.18 Every ship must carry not less than 12 rocket parachute flares.
- 5.5.19 Every ship must carry a line-throwing appliance.
- 5.5.20 Every ship must be provided with:
- (a) an emergency means for two-way communication (which may be fixed or portable equipment or both) between emergency control stations, assembly and embarkation stations and strategic positions on board. This may be the equipment carried in compliance with paragraph 5.5.11(a);
 - (b) a general emergency alarm system, except that in ships of less than 45.7 metres in length the additional electrically operated means referred to in Schedule 11, Part 1 need not be provided; in addition, in ships of 500 tons or over, either a public address system or other suitable means of communication; and
 - (c) lighting as specified in paragraphs 5.10.4, 5.10.5 and 5.13.8, provided that in ships of less than 500 tons such lighting need only be provided from one source of electrical power.
- 5.5.21 Every ship must be provided:
- (a) with posters or signs showing operating instructions, on or in the vicinity of survival craft and their launching controls;
 - (b) with a training manual in each crew messroom and recreation room or in each crew cabin;
 - (c) with instructions for on-board maintenance of life-saving appliances or a shipboard planned maintenance programme which includes the maintenance of life-saving appliances; and
 - (d) on the bridge, with a copy of the table "Life-Saving Signals for Ships, Aircraft and Persons in distress" published by the Maritime and Coastguard Agency



5.6 Ships of Classes IX(A) and IX(A)(T)

5.6.1 Section 5.6 of this section applies to ships of Classes IX(A) and IX(A)(T) the keels of which were laid, or were at a similar stage of construction, on or after 1st July 1986 and before 1st July 1998.

5.6.2 Every ship must, when engaged in a voyage in only Category A, B or C waters, be equipped as follows:

- (a) ships of less than 12 metres in length must carry either one lifebuoy complying with Schedule 8, Part 2 for each two persons on board or one lifebuoy complying with Schedule 8, Part 3 for each person, provided that at least two lifebuoys are carried and that all are the same type. One lifebuoy must be fitted with a buoyant lifeline at least 18 metres in length and one lifebuoy with a self-igniting light and self-activating smoke signal;
- (b) ships of 12 metres in length and over but less than 20 metres in length must carry:
 - (i) one lifebuoy for each two persons on board, provided that at least two lifebuoys are carried; one lifebuoy must be fitted with a buoyant lifeline at least 18 metres in length and one lifebuoy with a self-igniting light and self-activating smoke signal;
 - (ii) a lifejacket suitable for a person weighing 32 kilogrammes or more for each person on board; and
 - (iii) a lifejacket suitable for a person weighing less than 32 kilogrammes for each such person on board;
- (c) ships of 20 metres in length and over must carry:
 - (i) one lifebuoy for each two persons on board, provided that at least four lifebuoys are carried; one lifebuoy on each side of the ship must be fitted with a buoyant lifeline and one lifebuoy on each side of the ship with a self-igniting light and self-activating smoke signal;
 - (ii) a lifejacket suitable for a person weighing 32 kilogrammes or more for each person on board; and
 - (iii) a lifejacket suitable for a person weighing less than 32 kilogrammes for each such person on board;
- (d) in ships of Class IX(A)(T) lifebuoy self-igniting lights must be of an electric battery type.

5.6.3 Every ship must, when engaged in a voyage which is in part in Category A, B or C waters and which is also in part in Category D waters, be equipped as follows:

- (a) ships of less than 12 metres in length must carry:
 - (i) either one lifebuoy complying with Schedule 8, Part 2 for each two persons on board or one lifebuoy complying with Schedule 8, Part 3 for each person; provided that at least two lifebuoys are carried and are all of the same type; one lifebuoy must be fitted with a buoyant lifeline at least 18 metres in length and one lifebuoy with a self-igniting light and self-activating smoke signal; and



- (ii) six rocket parachute flares;
- (b) ships of 12 metres in length and over but less than 20 metres in length must carry:
- (i) one or more liferafts complying with the requirements of Schedule 4, Part 2, 3 or 5, of sufficient aggregate capacity to accommodate the total number of persons on board; if the liferaft or liferafts cannot be readily launched on either side of the ship, the total capacity available on each side must be sufficient to accommodate the total number of persons on board;
 - (ii) two lifebuoys, one of which must be fitted with a buoyant lifeline at least 18 metres in length and the other with a self-igniting light and self-activating smoke signal;
 - (iii) a lifejacket suitable for a person weighing 32 kilogrammes or more for each person on board;
 - (iv) a lifejacket suitable for a person weighing less than 32 kilogrammes for each such person on board; and
 - (v) six distress rocket parachute flares;
- (c) ships of 20 metres in length and over must carry:
- (i) one or more liferafts complying with the requirements of Schedule 4, Part 2, 3 or 5, of sufficient aggregate capacity to accommodate the total number of persons on board; if the liferaft or liferafts cannot be readily launched on either side of the ship, the total capacity available on each side must be sufficient to accommodate the total number of persons on board;
 - (ii) four lifebuoys, two of which must be fitted with buoyant lifelines and two with self-igniting lights and self-activating smoke signals;
 - (iii) a lifejacket suitable for a person weighing 32 kilogrammes or more for each person on board;
 - (iv) a lifejacket suitable for a person weighing less than 32 kilogrammes for each such person on board; and
 - (v) six rocket parachute flares;
- (d) in ships of Class IX(A)(T) lifebuoy self-igniting lights must be of an electric battery type.

5.6.4 Every tug and tender to which paragraphs 5.6.2 and 5.6.3 apply must, in addition to the equipment required by these paragraphs, carry buoyant apparatus of sufficient capacity to accommodate the total number of persons on board.

5.6.5 Every ship to which paragraph 5.6.3(b) or (c) or paragraph 5.6.4 applies must be provided:

- (a) with lighting as specified in paragraphs 5.10.4, 5.10.5 and 5.13.8, provided from at least one source of electrical power;
- (b) with posters and signs showing operating instructions, on or in the vicinity of the liferafts and their launching controls;



- (c) with a training manual; and
- (d) with instructions for on-board maintenance of life-saving appliances or a shipboard planned maintenance programme which includes the maintenance of life-saving appliances.

5.7 Ships of Class XI

5.7.1 This section applies to ships of Class XI the keels of which were laid, or were at a similar stage of construction, on or after 1st July 1986 and before 1st July 1998.

5.7.2 Every ship must carry:

- (a) one or more liferafts on each side of the ship of sufficient aggregate capacity to accommodate the total number of persons on board, provided that:
 - (i) if the liferafts cannot be readily launched on either side of the ship, the total capacity available on each side must be sufficient to accommodate 150 per cent of the total number of persons on board;
 - (ii) if the rescue boat required by subparagraph (b) is also a lifeboat it may be included in the aggregate capacity provided the total capacity available on either side of the ship is at least 150 per cent of the total number of persons on board; and
 - (iii) the number and arrangement of survival craft must be such that in the event of any one survival craft being lost or rendered unserviceable, there must be sufficient survival craft available for use on each side to accommodate the total number of persons on board;
- (b) at least one rescue boat: provided that in ships of less than 500 tons an inflated boat fitted with an engine may be carried in lieu of a rescue boat; a lifeboat may be accepted as a rescue boat, provided that it also complies with the requirements for a rescue boat. The lifeboat, rescue boat or inflated boat must be served by its own launching appliance.

5.7.3 Every ship to which this section applies, must be provided with the following equipment:

- (a) a satellite EPIRB;
- (b) in the case of a ship of 500 tons or over, at least 3 waterproofed two-way VHF radiotelephone apparatus and, in the case of a ship of under 500 tons, at least 2 waterproofed two-way VHF radiotelephone apparatus, in either case complying with standards not inferior to those contained in IMO Resolution A.762(18) or subsequent IMO Resolution on performance standards for survival craft two-way VHF Radiotelephone Apparatus; and
- (c) in the case of a ship of 500 tons or over, on each side of the ship at least one radar transponder, and in the case of a ship of 300 tons or over and under 500 tons at least one radar transponder. The radar transponders must be stowed in such locations that they can rapidly be placed in any survival craft or, alternatively, one radar transponder must be stowed in each survival craft.

5.7.4

- (a) Every ship must carry at least the number of lifebuoys in accordance with the following table:



Length of ship in metres	Minimum number of lifebuoys
Under 50	6
50 and over	8

- (b) Ships of less than 12 metres in length may carry, in lieu of lifebuoys complying with Schedule 8, Part 2, lifebuoys complying with Schedule 8, Part 3, provided that all are of the same type.
- (c) At least one lifebuoy on each side of the ship must be fitted with a buoyant lifeline. Not less than 50 per cent of the total number of lifebuoys must be provided with self-igniting lights and not less than two of the lifebuoys provided with such lights must also be provided with self-activating smoke signals and be capable of quick release from the navigating bridge/steering position. On ships of less than 12 metres in length the buoyant lifelines must be at least 18 metres in length.

5.7.5 Every ship must carry:

- (a) for each person on board, a lifejacket suitable for a person weighing 32 kgs or more;
- (b) a lifejacket suitable for a person weighing less than 32 kgs for each such person on board; provided that there must never be less than 2 such lifejackets on any ship which is ever likely to carry children; and
- (c) a sufficient number of additional lifejackets for the use of persons on watch and for use at remotely located survival craft stations, provided that there must be at least 4 additional lifejackets on ships where the number of persons on board is 16 or less, and at least an additional 25 per cent of the number of lifejackets required to be carried by subparagraph (a) in the case of ships where the number on board is more than 16. The number of additional lifejackets need not exceed the number of persons on board.

5.7.6 Included in the number of lifejackets required to be carried by paragraph 5.7.5 there must be at least sufficient inflatable lifejackets for the crew of the rescue boat and for those crew members whose emergency duties require a lifejacket which will not unduly hinder them during the execution of these duties.

5.7.7 Each lifejacket required to be carried by paragraphs 5.7.5 and 5.7.6 must be fitted with a lifejacket light complying with the requirements of Schedule 9, Part 1.

5.7.8 Every ship must carry, for every person assigned to crew the rescue boat or inflated boat, an anti-exposure or immersion suit of an appropriate size complying with paragraph 5.20.

5.7.9

- (a) Every ship must carry an immersion suit complying with paragraph 5.20 for every person on board unless:
 - (i) the liferafts are served by launching appliances;
 - (ii) the liferafts are served by equivalent appliances capable of being used on both sides of the ship and which do not require entry into the water to board the liferaft; or,
 - (iii) the ship is constantly engaged on voyages between the parallels of latitude of 20° North and South.



- (b) The immersion suits required by this paragraph may be used to comply with the requirements of paragraph (8).

5.7.10 Every ship must carry not less than 12 rocket parachute flares.

5.7.11 Every ship of 12 metres in length and over must carry a line-throwing appliance.

5.7.12 Every ship must be provided with:

- (a) a general emergency alarm system except that in ships of less than 45.7 metres in length the additional electrically operated means referred to in Schedule 11, Part 1 need not be provided; and
- (b) lighting as specified in paragraphs 5.1.4, 5.10.5 and 5.13.8, provided that such lighting need only be provided from one source of electrical power.

5.7.13 Every ship must be provided with:

- (a) posters or signs showing operating instructions, on or in the vicinity of survival craft and their launching controls;
- (b) a training manual in each crew messroom and recreation room or in each crew cabin;
- (c) instructions for on-board maintenance of life-saving appliances or a shipboard planned maintenance programme which includes a maintenance programme, which includes a maintenance of life-saving appliances; and
- (d) on the bridge, with a copy of the table, "Life-Saving Signals for Ships, Aircraft and Persons in distress" published by the Maritime and Coastguard Agency".

5.8 Ships of Class XII

5.8.1 This section applies to ships of Class XII the keels of which were laid, or were at a similar stage of construction, on or after 1st July 1986 and before 1st July 1998.

5.8.2 Every ship of 21.3 metres in length and over must carry:

- (a) at least two liferafts so stowed that they can be readily transferred to the water on either side of the ship, of sufficient aggregate capacity to accommodate twice the total number of persons on board;
- (b) four lifebuoys, two of which must be fitted with buoyant lifelines and two with self-igniting lights and self-activating smoke signals;
- (c) a lifejacket suitable for a person weighing 32 kgs or more for each person on board;
- (d) a lifejacket suitable for a person weighing less than 32 kgs for each such person on board;
- (e) a lifejacket light fitted on each of the lifejackets required by subparagraphs (c) and (d) complying with the requirements of Schedule 9, Part 1;
- (f) six rocket parachute flares;
- (g) a line-throwing appliance;



- (h) posters or signs showing operating instructions on or in the vicinity of survival craft and their launching controls;
- (i) a training manual;
- (j) instructions for on-board maintenance of life-saving appliances; and
- (k) on the bridge, with a copy of the table "Life-Saving Signals for Ships, Aircraft and Persons in distress" published by the Maritime and Coastguard Agency;

and any such ship of 25.9 metres in length or over must carry, in addition, a rescue boat or inflated boat. A lifeboat may be accepted as a rescue boat, provided that it also complies with the requirements for a rescue boat. The lifeboat, rescue boat or inflated boat must be served by a launching appliance.

5.8.3 Every ship of 13.7 metres in length or over but less than 21.3 metres in length and engaged on either a voyage to sea in the course of which it is more than three miles from the coast of the United Kingdom or a voyage to sea during the months of November to March, inclusive, must carry:

- (a) one or more liferafts complying with the requirements of Schedule 4, Part 2, 3 or 5, so stowed as to be readily transferable to the water on either side of the ship and of sufficient aggregate capacity to accommodate the total number of persons on board;
- (b) two lifebuoys, one of which must be fitted with a self-igniting light and self-activating smoke signal;
- (c) a buoyant lifeline at least 18 metres in length;
- (d) a lifejacket suitable for a person weighing 32 kgs or more for each person on board;
- (e) a lifejacket suitable for a person weighing less than 32 kgs for each such person on board;
- (f) a lifejacket light fitted on each of the lifejackets required by subparagraphs (d) and (e) complying with the requirements of Schedule 9, Part 1;
- (g) six rocket parachute flares;
- (h) posters or signs showing operating instructions on or in the vicinity of survival craft and their launching controls;
- (i) a training manual;
- (j) instructions for on-board maintenance of life-saving appliances; and
- (k) on the bridge, with a copy of the table "Life-Saving Signals for Ships, Aircraft and Persons in distress" published by the Maritime and Coastguard Agency;

5.8.4 Every ship of 13.7 metres in length or over but less than 21.3 metres in length which does not proceed to sea or which only proceeds to sea during the months of April to October, inclusive on voyages in the course of which it is not more than 3 miles from the coast of the United Kingdom must carry:

- (a) one lifebuoy for each two persons on board, provided that at least two lifebuoys are carried; such ships which operate in only Category A, B or C waters are not required



to carry more than two lifebuoys. One lifebuoy must be fitted with a self-igniting light and self-activating smoke signal;

- (b) a buoyant lifeline at least 18 metres in length;
- (c) a lifejacket suitable for a person weighing 32 kgs or more for each person on board;
- (d) a lifejacket suitable for a person weighing less than 32 kgs for each such person on board;
- (e) a lifejacket light on each lifejacket required by subparagraphs (c) and (d) complying with the requirements of Schedule 9, Part 1;
- (f) six rocket parachute flares;
- (g) on the bridge, with a copy of the table " Life-Saving Signals for Ships, Aircraft and Persons in distress" published by the Maritime and Coastguard Agency.

5.8.5 In lieu of carrying lifejackets complying with the requirements of Schedule 9, Part 2 or 3, every such ship may carry lifejackets complying with British Standard Specification BS 3595; 1981 or BS 394 and BS EN 396 1994, provided that such lifejackets do not depend wholly upon oral inflation. Lifejackets of the partially inherently buoyant type for persons weighing 32 kilogrammes or more must have buoyancy in the uninflated state of not less than 89 Newtons.

General Requirements

5.9 Operating Instructions for Survival Craft and their Launching Controls

- 5.9.1 Posters and signs provided on or in the vicinity of survival craft and their launching controls must:
- (a) illustrate the purpose of controls and the procedures for operating the appliance and give relevant instructions;
 - (b) be easily seen under emergency lighting conditions on ships of Classes I, II and II(A) and of Classes VII, VII(T), VIII, VIII(T) and IX; and
 - (c) where applicable, use symbols which are specified in Schedule 16.

5.10 Survival Craft Assembly and Embarkation Arrangements

- 5.10.1 Lifeboats and liferafts for which launching appliances are required must be stowed as close to accommodation and service spaces as possible.
- 5.10.2 Assembly stations must be provided close to the embarkation stations. Each assembly station must have sufficient space to accommodate all persons assigned to muster at that station. In ships of Classes I, II and II(A) passenger assembly stations must have ample room for the marshalling and instruction of the passengers and there must be ready access between assembly stations and the embarkation station.
- 5.10.3 Assembly and embarkation stations must be readily accessible from accommodation and work areas.



- 5.10.4 In ships of Classes I, II and II(A) and in ships of Classes VII, VII(T), VIII, VIII(T), VIII(A), VIII(A)(T) and IX of 500 tons or over, assembly and embarkation stations must be adequately illuminated by lighting supplied from the emergency source of electrical power required by the Merchant Shipping (Passenger Ship Construction: Ships of Classes I, II and II(A)) Regulations 1998 or the Merchant Shipping (Cargo Ship Construction) Regulations 1997, as appropriate.
- 5.10.5 Alleyways, internal and external stairways and exits giving access to the assembly and embarkation stations must be lighted. In ships of the Classes referred to in paragraph 5.10.4 such lighting must be capable of being supplied by the emergency source of electrical power required by the Merchant Shipping (Passenger Ship Construction: Ships of Classes I, II and II(A)) Regulations 1998 or the Merchant Shipping (Cargo Ship Construction) Regulations 1997, as appropriate.
- 5.10.6 Davit-launched survival craft assembly and embarkation stations must be so arranged as to enable stretcher cases to be placed in survival craft.
- 5.10.7 In ships of Classes I, II, II(A), VII, VII(T), VIII, VIII(T), VIII(A), VIII(A)(T), IX, XI and XII an embarkation ladder must be provided at each launching station or at every two adjacent launching stations, extending, in a single length, from the deck to the waterline in the lightest seagoing condition under unfavourable conditions of trim and with the ship listed not less than 15 degrees either way and where such distance exceeds 1 metre. Such ladders may be replaced by devices to afford access to survival craft when waterborne, provided that there must be at least one embarkation ladder on each side of the ship. Handholds must be provided to assist in a safe passage from the deck to the ladder and vice-versa. Other means of embarkation may be permitted for the liferafts required to be carried in compliance with paragraphs 5.4.5 and 5.5.8.
- 5.10.8 Means must be provided for bringing davit-launched survival craft against the ship's side and holding them alongside so that persons can be safely embarked.
- 5.10.9 On ships of Classes I, II and II(A) survival craft embarkation arrangements must be so designed that:
- (a) all lifeboats can be boarded and launched either directly from the stowed position or from an embarkation deck but not both; and
 - (b) davit-launched liferafts can be boarded and launched from a position immediately adjacent to the stowed position or from a position to which, in compliance with the requirements of paragraph 5.11.5, the liferaft is transferred prior to launching.
- Notwithstanding the requirements of subparagraph (a), if the rescue boat is also a lifeboat and the other lifeboats are boarded and launched from an embarkation deck, the arrangements must be such that the rescue boat can also be boarded and launched from the embarkation deck.
- 5.10.10 On every ship provided with a rescue boat, arrangements must be such that the rescue boat can be boarded and launched directly from the stowed position with the number of persons assigned to crew the rescue boat on board.
- 5.10.11 On ships of Classes VII, VII(T), VIII, VIII(T), VIII(A), VIII(A)(T), IX, and XI embarkation arrangements for survival craft must be so designed that lifeboats can be boarded and launched directly from the stowed position and davit-launched liferafts can be boarded and launched from a position immediately adjacent to the stowed position or from a position to which the liferaft is transferred prior to launching in compliance with the requirements of paragraph 5.11.5.



5.10.12 For ro-ro passenger ships of Classes I, II and II(A) the term "muster station" must be replaced with "assembly station" on all signs and in all emergency procedure instructions.

5.11 Stowage of Survival Craft, Rescue Boats and Inflated Boats

5.11.1 Each survival craft must be stowed:

- (a) so that neither the survival craft nor its stowage arrangements will interfere with the operation of any other survival craft or rescue boat at any other launching station;
- (b) as near the water surface as is safe and practicable and, in the case of a survival craft other than a liferaft intended for throw-overboard launching, in such a position that the survival craft in the embarkation position is not less than two metres above the waterline with the ship in the fully loaded condition under unfavourable conditions of trim and listed up to 20 degrees either way, or to the angle at which the ship's weatherdeck edge becomes submerged, whichever is less;
- (c) in a state of continuous readiness so that two crew members can carry out preparations for embarkation and launching in less than 5 minutes;
- (d) fully equipped as set out in Schedule 2, Part 2 or Schedule 4, Part 6; and
- (e) as far as practicable, in a secure and sheltered position and protected from damage by fire and explosion.

5.11.2 Lifeboats for lowering down the ship's side must be stowed as far forward of the propeller as practicable. On ships of Classes VII, VII(T), VIII, VIII(T), VIII(A), VIII(A)(T) and IX of 80 metres in length or more but less than 120 metres in length, each lifeboat must be so stowed that the after end of the lifeboat is not less than the length of the lifeboat forward of the propeller. On such ships of 120 metres in length or more and on ships of Classes I, II and II(A) of 80 metres in length or more, each lifeboat must be so stowed that the after end of the lifeboat is not less than 1.5 times the length of the lifeboat forward of the propeller. Where appropriate, the ship must be so arranged that lifeboats, in their stowed positions, are protected from damage by heavy seas.

5.11.3 Lifeboats must be stowed attached to launching appliances.

5.11.4 In addition to meeting the requirements of paragraph 5.11.7 or 5.11.8, liferafts must be so stowed as to permit manual release from their securing arrangements.

5.11.5 Davit-launched liferafts, other than those required to be carried by paragraphs 5.2.2(c) and 5.3.4, must be stowed within reach of the lifting hooks unless some means of transfer is provided which is not rendered inoperable within the limits of trim and list prescribed in paragraph 5.11.1(b) or by ship motion or power failure.

5.11.6 Liferafts intended for throw-overboard launching must be so stowed as to be readily transferable for launching on either side of the ship unless liferafts, of the aggregate capacity required by paragraphs 5.4.2(b), 5.5.4, 5.6.3(b)(i), 5.6.3(c)(i) and 5.7.2(a)(i) to be capable of being launched on either side, are stowed on each side of the ship.

5.11.7 On ships of Classes I, II and II(A) every liferaft must be stowed with its painter permanently attached to the ship and with a float-free arrangement complying with the requirements of Schedule 4, Part 8 so that, as far as practicable, the liferaft floats free and, if inflatable, inflates automatically when the ship sinks.



5.11.8 On ships of Classes VII, VII(T), VIII, VIII(T), VIII(A), VIII(A)(T), IX, XI and XII every liferaft, other than the liferafts required by paragraph 5.4.5 and 5.5.8 must be stowed with its painter permanently attached to the ship and with a float-free arrangement complying with the requirements of Schedule 4, Part 8 so that the liferaft floats free and, if inflatable, inflates automatically when the ship sinks. The liferafts required by regulations 5.4.5 and 5.5.8 if securely fastened must have provision for manual release.

5.11.9 Rescue boats must be stowed:

- (a) in a state of continuous readiness for launching in not more than five minutes;
- (b) in a position suitable for launching and recovery;
- (c) so that neither the rescue boat nor its stowage arrangements will interfere with the operation of any survival craft at any other launching station; and
- (d) if it is also a lifeboat, in compliance with the requirements of this section for the stowage of lifeboats.

5.11.10 Inflated boats must be stowed:

- (a) in a state of continuous readiness for launching in the shortest possible time;
- (b) in a position suitable for launching and recovery; and
- (c) so that neither the inflated boat nor its stowage arrangements will interfere with the operation of any survival craft at any other launching station.

5.12 Launching Stations

5.12.1 Launching stations must be in such positions as to ensure safe launching having particular regard to clearance from the propeller and steeply overhanging portions of the hull with the object of ensuring that so far as practicable survival craft, except survival craft specially designed for free-fall launching, can be launched down the straight side of the ship. If positioned forward survival craft must be stowed abaft the collision bulkhead in a sheltered position.

5.13 Survival Craft Launching Arrangements

5.13.1 Launching appliances complying with the requirements of Schedule 6, Parts 1 and 3, must be provided for all liferafts except:

- (a) liferafts which are boarded from a position which is less than 4.5 metres above the waterline in the lightest seagoing condition and which either:
 - (i) have a mass of not more than 185 kilogrammes; or
 - (ii) are stowed for launching directly from the stowed position under unfavourable conditions of trim of up to 10 degrees and with the ship listed not less than 20 degrees either way;
- (b) liferafts having a mass of not more than 185 kilogrammes and which are carried in excess of the survival craft for 200 per cent of the total number of persons on board the ship; and
- (c) the liferafts stowed as far forward or aft as required by paragraph 5.4.5.



- 5.13.2 Each lifeboat must be provided with an appliance which is capable of launching and recovering the lifeboat.
- 5.13.3 Only one type of release mechanism must be used for similar survival craft carried on board the ship.
- 5.13.4 On ships of Classes I, II and II(A) all survival craft required to provide for abandonment by the total number of persons on board must be capable of being launched with their full complement of persons and equipment within a period of 30 minutes from the time the abandon ship signal is given.
- 5.13.5 On ships of Classes VII, VII(T), VIII(T), VIII(A), VIII(A)(T), IX and XI, with the exception of the survival craft referred to in subparagraph (1)(a), all survival craft required to provide for abandonment by the total number of persons on board must be capable of being launched with their full complement of persons and equipment within a period of 10 minutes from the time the abandon ship signal is given.
- 5.13.6 On ships of Classes VII, VII(T), VIII, VIII(T), VIII(A), VIII(A)(T) and IX of 20,000 tons and upwards, lifeboats must be capable of being launched, where necessary utilising painters, with the ship making headway at speeds up to 5 knots in calm water.
- 5.13.7 Preparation and handling of survival craft at any one launching station must not interfere with the prompt preparation and handling of any other survival craft or rescue boat at any other station.
- 5.13.8 During preparation and launching, each survival craft, its launching appliance, and the area of water into which it is to be launched must be adequately illuminated by lighting supplied from the emergency source of electrical power required by the Merchant Shipping (Passenger Ship Construction: Ships of Classes I, II and II(A)) Regulations 1998 or the Merchant Shipping (Cargo Ship Construction) Regulations 1997, as appropriate.
- 5.13.9 Means must be available to prevent any over-board discharge of water on to survival craft during abandonment.
- 5.13.10 If there is a danger of a survival craft being damaged by the ship's stabiliser fins, means must be available, powered by an emergency source of energy, to bring the stabiliser fins inboard. Indicators operated by an emergency source of energy must be available on the navigating bridge to show the position of the stabiliser fins.

5.14 Marine Escape Systems

- 5.14.1 A marine evacuation system or systems complying with the requirements of Schedule 5, Part 1 may be substituted on ships of Classes II and II(A) for some or all of the liferafts and launching appliances required by paragraph 5.3.2(b) or 5.3.3(b). The liferafts included in such system or systems, together with any other liferafts served by launching appliances other than the liferafts referred to in regulation 5.3.4, must provide the same aggregate capacity as that required by regulation 5.3.2(b) or 5.3.3(b).
- 5.14.2 Where marine evacuation systems are provided on a ship, at least all the systems on one side must be subjected to a trial deployment after installation.
- 5.14.3 Where marine evacuation systems are provided, provision for training the crew in its use must be made which must include the arrangements specified in Schedule 5, Part 3.



5.15 Rescue Boat Embarkation, Launching and Recovery Arrangements

- 5.15.1 The rescue boat embarkation and launching arrangements must be such that the rescue boat can be boarded and launched in the shortest possible time and in any case in not more than five minutes.
- 5.15.2 If the rescue boat is one of the ship's survival craft, the embarkation arrangements and launching station must comply with the requirements of paragraphs 5.10 and 5.12.
- 5.15.3 Launching arrangements must comply with the requirements of paragraph 5.13 and rescue boat launching appliances must comply with the requirements of Schedule 6, Parts 1 and 2. All rescue boats must be capable of being launched, where necessary utilising painters, with the ship making headway at speeds up to 5 knots in calm water.
- 5.15.4 Rapid recovery of the rescue boat must be possible:
- (a) when the boat is loaded with its full complement of persons and equipment; and
 - (b) if the rescue boat is also a lifeboat, when it is loaded with its lifeboat equipment, and the approved rescue boat complement or six persons, whichever is the greater.

5.16 Stowage of Lifebuoys

- 5.16.1 Lifebuoys must be so distributed as to be readily available on both sides of the ship and as far as practicable on all open decks extending to the ship's side. At least one lifebuoy must be placed in the vicinity of the stern.
- 5.16.2 Lifebuoys must not be permanently secured in any way and must be stowed so as to be capable of being rapidly thrown overboard.
- 5.16.3 Except as otherwise provided, one lifebuoy on each side of the ship must be fitted with a buoyant lifeline.
- 5.16.4 Except as otherwise provided, lifebuoys with lights and lifebuoys with both lights and smoke signal must be equally distributed on both sides of the ship.

5.17 Stowage of lifejackets

- 5.17.1 Lifejackets must be so stored as to be readily accessible and their position must be plainly indicated. Where, due to the particular arrangements of the ship, lifejackets stored in remote positions may become inaccessible, the number of lifejackets carried elsewhere must be suitably increased.
- 5.17.2 Lifejackets providing the additional 5 per cent required on passenger ships of Classes I, II and II(A) must be stowed in conspicuous places on deck or at assembly stations.

5.18 Stowage of two-way radiotelephone sets

- 5.18.1 The two-way radiotelephone sets carried in accordance with Section 5 of this Notice and which are not stowed in survival craft, must be kept in a suitable place ready to be moved into survival craft in case of emergency.
- 5.18.2 In ships where there is substantial fore and aft separation between superstructure or deck houses, the two-way radiotelephone sets must all not be located in any one superstructure or deck house.



5.19 Stowage and packing of pyrotechnic distress signals and line-throwing appliances

- 5.19.1 Pyrotechnic distress signals provided for use on board ship must be stowed on or near the navigating bridge.
- 5.19.2 All pyrotechnic distress signals provided for use on board ships or for use in a lifeboat must be packed in a watertight container which must not be a plastic envelope.
- 5.19.3 In the case of a line-throwing appliance, which includes a pistol, the pistol, line and rockets together with the means of ignition must be stowed in a container, which provides protection from the weather.

5.20 Immersion suits and anti-exposure suits

- 5.20.1 Immersion suits and anti-exposure suits required to be carried by this Part of these Regulations, may be of the insulated or uninsulated type but immersion suits of the insulated type must be carried on ships which make voyage:
 - (a) north of latitude 65°N in the Atlantic Ocean;
 - (b) north of latitude 55°N in the Pacific Ocean;
 - (c) south of latitude 50°S; or
 - (d) east of longitude 10°E in the Kattegat and Baltic Sea between 1st December and 30th April, both dates inclusive.

5.21 Manning of survival craft

- 5.21.1 Section 5.21 of this Notice applies to ships of Classes I, II, II(A), VII, VII(T), VIII, VIII(T) and ships of Classes IX and XI engaged on international voyages.
- 5.21.2 There must be a sufficient number of crew members to operate the survival craft and launching arrangements required for evacuating the total number of persons on board. The minimum number of deck officers, certified persons and other crew members required to be carried must be determined in accordance with MSN 1682 (M).
- 5.21.3 A deck officer or certified person must be placed in charge of each lifeboat to be used. In addition, a deck officer or certified person must be nominated to be second-in-command of such lifeboat.
- 5.21.4 A deck officer or certified person must be placed in charge of each liferaft to be used. However, in ships of Classes II and II(A) the person placed in charge may be a crew member practised in the handling and operation of liferafts.
- 5.21.5 The person in charge of a survival craft must have a list of the survival craft crew and must ensure that the crew under his command are acquainted with their duties. In lifeboats the second-in-command must also have a list of the lifeboat crew.
- 5.21.6 In ships carrying liferafts served by launching appliances a deck officer or certified person must be assigned to each launching appliance.
- 5.21.7 In ships carrying liferafts not served by launching appliances a deck officer or certified person must be assigned to each launching position.
- 5.21.8 A person capable of operating the engine and carrying out minor adjustments must be assigned to every lifeboat.



- 5.21.9 A person capable of operating a radiotelegraph installation must be assigned to every lifeboat required to carry such equipment.
- 5.21.10 There must be a sufficient number of trained persons on board for mustering and assisting untrained persons.
- 5.21.11 The master must ensure the equitable distribution of persons referred to in paragraphs 5.21.2, 5.21.3, 5.21.4 and 5.21.10 when compiling the muster list referred to in—
- regulation 5(2) of the Merchant Shipping (Musters, Training and Decision Support Systems) Regulations 1999 (SI 1999/2722), for ships to which SOLAS does **not** apply; and
 - regulations 8.3 and 37 in Chapter III (muster list and emergency instructions), for ships to which SOLAS **does** apply.

5.22 Servicing of Life-Saving Appliances

- 5.22.1 Every inflatable liferaft, inflatable lifejacket, hydrostatic release unit (other than a disposable unit) and marine evacuation system must be serviced at a service station accepted by the Secretary of State, at intervals not exceeding twelve months: provided that in any case where this is impracticable, such interval may be extended by a period not exceeding five months with the consent of the Secretary of State on application to the Maritime and Coastguard Agency at Spring Place, 105 Commercial Road, Southampton SO15 5EG.
- 5.22.2 Guidance is provided in Marine Guidance Notes 548 (M+F) and 553 (M+F) on servicing of life-saving appliances which are installed on board UK regarding how and when life-saving appliances must be serviced.

5.23 Replacement of Life-Saving Appliances

- 5.23.1 The requirements relating to the replacement of life-saving appliances for ships the keel of which was laid, or was at a similar stage of construction, on or after 1st July 1986 and before 1st July 1998, are contained in regulations 6 and 11 of the 2020 Regulations. Regulation 6 applies to all ships, whether engaged on international or non-international voyages, and regulation 11 applies solely to ships engaged on international voyages.
- 5.23.2 In addition to the requirements in the 2020 Regulations, paragraph 5 of regulation 1 in Chapter III of SOLAS requires all ships engaged on international voyages (which includes ships constructed on or after 1st July 1986 and before 1st July 1998), to replace all lifeboat on-load release mechanisms which do not comply with paragraphs 4.4.7.6.4 to 4.4.7.6.6 of the LSA Code with on-load release mechanisms that do comply with these paragraphs of the Code. The provision required all ships to comply with the requirement by 1st July 2019 and all ships must therefore now comply.

6. New ship carriage requirements for life-saving appliances for ships other than ships of Classes III to VI(A) constructed on or after 1st July 1998 and which are engaged on international voyages

- 6.1 This section provides guidance for the carriage requirements for all new ships which are Classes I, II, VII, VII(T), VIII, VIII(T) and IX.
- 6.1.1 As per Part 4 of the 2020 Regulations:



- (a) passenger ships of Classes I and II; and
- (b) non-passenger ships of 500 gross tons or more (and in some cases cargo ships of 300 gross tons but under 500 gross tons) of Classes VII, VII(T), VIII, VIII(T) and IX,

which are new ships and engaged on international voyages, are required to comply with the requirements contained in the provisions of Part B of Chapter III of SOLAS as they apply to the ship type. Where a provision of Part B of SOLAS Chapter III applies to such a ship, the provision must be met.

6.2 In addition to the carriage requirements in Chapter III of SOLAS, there are several occasions where the Administration is to decide on either the carriage of an appliance or how an arrangement should be made for specific ships. For UK ships, the MCA on behalf of the Secretary of State for Transport is the Administration. Below are a list of the relevant provisions of Chapter III and advice on what the MCA will accept:

- (a) SOLAS regulation III/4.3 provides: “Before giving approval to novel life-saving appliances or arrangements, the Administration shall ensure that such .1 appliances provide safety standards at least equivalent to the requirements of this chapter and the Code and have been evaluated and tested on the guidelines developed by the Organization; or .2 arrangements have been successfully undergone an engineering analysis, evaluation and approval in accordance with regulation 38.” In such case, the MCA must be contacted regarding the undertaking of the necessary approval procedure. For this purpose, the contact details at the end of this Notice should be used.
- (b) SOLAS regulation III/4.6 provides: “Life-saving appliances required by this chapter for which detailed specifications are not included in the Code shall be to the satisfaction of the Administration.”

Regulation 6 of the 2020 Regulations provides for approvals of life-saving appliances and arrangements. MSN 1874 Annex 2 lists appliances for which detailed specifications are not included in the Code and how they should be approved. MSN 1874 describes the procedure for approval of such appliances by a UK Nominated Body which conducts the conformity assessment of such appliances on the MCA’s behalf. For any specific enquiries one of the UK Nominated Bodies listed in MSN 1874 able to approve Life-Saving Appliances should be consulted.

- (c) SOLAS regulation III/7.2.2 provides: “Lifejackets shall be so placed as to be readily accessible and their position shall be plainly indicated. Where, due to the particular arrangements of the ship, the lifejackets provided in compliance with the requirements of paragraph 2.1 may become inaccessible, alternative provisions shall be made to the satisfaction of the Administration which may include an increase in the number of lifejackets to be carried.”

MGN 76 (M) gives general guidance on the storage of lifejackets on board passenger ships. Where an operator of a UK ship considers that the particular arrangements of a UK ship would lead to inaccessibility of lifejackets, the operator must conduct and document a risk assessment as part of their Safety Management System (SMS) with the intent of assessing the probability of lifejackets becoming inaccessible during an emergency and mitigate these risks accordingly by storing the lifejackets in a suitable location and / or supplying additional lifejackets.

- (d) SOLAS regulations III/7.3, III/22.4.1.2 and III/32.3.2 allow for immersion suits or anti-exposure suits to not be carried where the Administration considers that the ship is constantly engaged in warm climates.



In this context, the MCA on behalf of the Secretary of State deems that ships constantly engaged in voyages between the parallels of latitude of 20° North and South as warm climates and need not carry immersion suits or anti-exposure suits.

- (e) SOLAS regulations III/38.2.2 provides “When alternative design or arrangements deviate from the prescriptive requirements of part B, an engineering analysis, evaluation and approval of the design and arrangements shall be carried out in accordance with this regulation.” In such case, the MCA must be contacted regarding the undertaking of the necessary approval procedure. For this purpose, the contact details at the end of this Notice should be used.

6.3 In addition to the performance standards in the LSA Code there are several occasions where the Administration is to be satisfied with the standard of appliance or arrangement provided. For UK ships, the MCA on behalf of the Secretary of State for Transport is the Administration. Below is a list of the relevant provisions of the LSA Code and advice on what the MCA will accept as satisfactory:

- (a) Paragraph 1.2.2 of the LSA Code sets out prescriptive general requirements for life-saving appliances, and provides for the Administration to make other requirements where a particular voyage would warrant other requirements.

Should an operator of a UK ship believe that a UK ship operates continually on a specific voyage type that would call for alternative requirements for life-saving appliances, application should be made via the relevant UK Ship’s Customer Service Manager.

- (b) Paragraph 4.1.5.3 of the LSA Code allows passenger ships engaged on short international voyages of such nature and duration to carry liferafts without some of the equipment specified in paragraph 4.1.5 of the LSA Code which is known as a “SOLAS B PACK” liferaft.

UK Ships of Class II are permitted to carry the equipment specified in paragraphs 4.1.5.1.1 to 4.1.5.1.6 inclusive, 4.1.5.1.8, 4.1.5.1.9, 4.1.5.1.13 to 4.1.5.1.16 inclusive of the LSA Code, and 4.1.5.1.21 to 4.1.5.1.24 inclusive and one half of the equipment specified in paragraphs 4.1.5.1.10 to 4.1.5.1.12 inclusive of the LSA Code provided they are marked in accordance with paragraphs 4.1.5.3 and 4.3.6.7 (“SOLAS B PACK”).

- (c) Paragraph 4.4.6.2 of the LSA Code specifies the minimum temperature (-15 degrees Celsius) in which an engine of a lifeboat must start and gives the Administration flexibility to allow for a differing temperature to be considered where a ship operates exclusively in a certain geographical area.

MGN 34 (M) gives guidance on the starting of engines of emergency generators and lifeboats in extreme temperatures. This guidance clarifies that UK ships engaged continuously in the tropics can consider a differing starting temperature for such engines. Where an operator of a UK ship considers such a ship to be operating in such region and wishes to use lifeboats with a differing start up temperature to -15C, application should be made to the ship’s Customer Service Manager.

- (d) Paragraph 4.4.8.32 of the LSA Code allows the Administration to dispense of fishing tackle and certain rations for liferafts on ships engaged on specific voyage types that the duration between abandon ship and rescue would not call for such items.



An operator of a UK ship which believes a UK ship operates exclusively on such a voyage should make application to the ship's Customer Service Manager for such a dispensation.

- (e) Paragraph 4.5.4 of the LSA Code provides: "If a fixed two-way VHF radiotelephone apparatus is fitted in the lifeboat, it shall be installed in a cabin large enough to accommodate both the equipment and the person using it. No separate cabin is required if the construction of the lifeboat provides a sheltered space to the satisfaction of the Administration."

The approval of specific life-saving appliances to be placed on board a UK ship is conducted by one or more EU Notified Bodies for Marine Equipment in accordance with the Merchant Shipping (Marine Equipment) Regulations 2016. Any lifeboat manufacturer considering alternate arrangements wishing to supply UK ships with such lifeboats should contact an EU Notified Body for Marine Equipment as soon as possible and in any event before production.

- (f) Paragraph 5.1.1.4 of the LSA Code provides: "Rescue boats which are a combination of rigid and inflated construction shall comply with the appropriate requirements of this section to the satisfaction of the Administration."

The approval of specific life-saving appliances to be placed on board a UK ship is conducted by one or more EU Notified Bodies for Marine Equipment in accordance with the Merchant Shipping (Marine Equipment) Regulations 2016. Any rescue boat manufacturer designing a boat which is a combination of rigid and inflatable construction wishing to supply UK ships with such rescue boats should contact an EU Notified Body for Marine Equipment as soon as possible and in any event before production.

- (g) Paragraph 5.1.3.8 of the LSA Code provides: Underneath the bottom and on vulnerable places on the outside of the inflated rescue boat, rubbing strips shall be provided to the satisfaction of the Administration.

The approval of specific life-saving appliances to be placed on board a UK ship is conducted by one or more EU Notified Bodies for Marine Equipment in accordance with the Merchant Shipping (Marine Equipment) Regulations 2016. Any rescue boat manufacturer designing an inflated boat wishing to supply UK ships with such rescue boats should contact an EU Notified Body for Marine Equipment as soon as possible and in any event before production.

- (h) Paragraph 6.1.2.9 of the LSA Code provides: The lowering speed of a fully equipped liferaft without persons onboard shall be to the satisfaction of the Administration.

The approval of specific life-saving appliances to be placed on board a UK ship is conducted by one or more EU Notified Bodies for Marine Equipment in accordance with the Merchant Shipping (Marine Equipment) Regulations 2016. Davit Launched Liferafts are serviced by davits which themselves are approved. During the approval of davits consideration is given to the rafts etc. that they are compatible with the risks associated with lowering speeds for differing arrangements. Any conditions should be stated on the approval documentation and in any event the manufacturer and Notified Body conducting the type approval should agree on the test regime.

- (i) Paragraph 6.2.1.2 of the LSA Code specifies that the strength and construction of the passage and platform of a marine evacuation system (MES) shall be to the satisfaction of the Administration.



The approval of specific life-saving appliances to be placed on board a UK ship is conducted by one or more EU Notified Bodies for Marine Equipment in accordance with the Merchant Shipping (Marine Equipment) Regulations 2016. The strength requirements of MES are determined by the Notified Body during conformity assessment and harmonised standards within the Marine Equipment Directive. Manufacturers should contact an EU Notified Body for Marine Equipment as soon as possible and in any event before production for guidance on strength and construction standards.

- (j) Paragraph 6.2.1.3.6 of the LSA Code requires MES to be fitted with a stabilising system to the satisfaction of the Administration.

The approval of specific life-saving appliances to be placed on board a UK ship is conducted by one or more EU Notified Bodies for Marine Equipment in accordance with the Merchant Shipping (Marine Equipment) Regulations 2016. The stabilising system for MES is controlled by the Notified Body during conformity assessment and harmonised standards within the Marine Equipment Directive. Manufacturers should contact an EU Notified Body for Marine Equipment as soon as possible and in any event before production for guidance on these requirements.

7. New ship carriage requirements for life-saving appliances for ships other than ships of Classes III to VI(A) constructed on or after 1st July 1998 which are engaged on non-international voyages or are otherwise not in scope of SOLAS

7.1 Compliance

- 7.1.1 This section applies to all new ships which are Classes II(A), VIII(A), VIII(A)(T), IX, IX(A), IX(A)(T), XI and XII and engaged on non-international voyages. It also applies to ships of Classes XI and XII engaged on international voyages, and to Classes VII, VII(T), VIII, VIII(T) and IX which are below 500 tons.
- 7.1.2 The applicable requirements for these ships include the requirements in the Merchant Shipping (Musters, Training and Decision Support Systems) Regulations 1999 and the Merchant Shipping (Entry into Dangerous Spaces) Regulations 1988 – see paragraphs 3.6 to 3.8 above.
- 7.1.3 As per Part 5 of the 2020 Regulations, all new ships which are Classes II(A), VIII(A), VIII(A)(T), IX, IX(A), IX(A)(T), XI and XII engaged on non-international voyages and ships which are Classes XI and XII engaged on international voyages, and VII, VII(T), VIII, VIII(T) and IX which are below 500 tons must comply with the requirements in this section.
- 7.1.4 Where life-saving appliances or arrangements are of a novel nature, or subject to significant design changes, or the specifications or testing requirements are not considered to be sufficiently developed or experience of their usage is limited, the MCA must be contacted regarding the undertaking of the necessary approval procedure. For this purpose, the contact details at the end of this Notice should be used. In the case of novel life-saving arrangements, an engineering analysis must be carried out and provided to the MCA for consideration and approval.

7.2 Ships of Class II(A)

- 7.2.1 This section applies to ships of Class II(A) which are engaged on non-international voyages and the keels of which were laid, or which were at a similar stage of construction on or after 1st July 1998.



- 7.2.2 Every ship which is subdivided in accordance with the requirements of Schedule 2 Section 3 of MSN 1698(M) must carry:
- (a) partially or totally enclosed lifeboats of sufficient aggregate capacity to accommodate at least 30 per cent of the total number of persons which the ship is certified to carry. Such lifeboats must be equally distributed, as far as practicable, on each side of the ship; and
 - (b) inflatable or rigid liferafts of sufficient aggregate capacity that, together with the lifeboat capacity required by subparagraph (a), will accommodate the total number of persons which the ship is certified to carry; the liferafts must be served by launching appliances equally distributed on each side of the ship.
- 7.2.3 Every ship which is subdivided in accordance with the requirements of Schedule 2 Section 2 of MSN 1698(M) must carry:
- (a) on each side of the ship partially or totally enclosed lifeboats of sufficient aggregate capacity to accommodate 50 per cent of the total number of persons which the ship is certified to carry; or
 - (b) partially or totally enclosed lifeboats and inflatable or rigid liferafts together providing sufficient aggregate capacity to accommodate the total number of persons which the ship is certified to carry: provided that there must never be less than sufficient lifeboats on each side of the ship to accommodate 37.5 per cent of the total number of persons which the ship is certified to carry; the liferafts must be served by launching appliances equally distributed on each side of the ship.
- 7.2.4 Every ship must carry, in addition to the survival craft carried in compliance with paragraph 7.2.2 or 7.2.3, liferafts of sufficient aggregate capacity to accommodate 25 per cent of the total number of persons which the ship is certified to carry. These liferafts must be served by at least one launching appliance on each side of the ship, which may be the appliance carried in compliance with subparagraph 7.2.2(b) or 7.2.3(b), or, if it is to be used on both sides, by appliances so approved.
- 7.2.5
- (a)
 - (i) Every ship of less than 500 tons carrying less than 200 persons may, in lieu of carrying the lifeboats and liferafts required by paragraph 7.2.2, 7.2.3 or 7.2.4 carry on each side of the ship liferafts of sufficient aggregate capacity to accommodate the total number of persons the ship is certified to carry.
 - (ii) If these liferafts cannot be readily launched on either side of the ship additional liferafts must be provided so that the total capacity available on each side will accommodate 150 per cent of the total number of persons which the ship is certified to carry.
 - (iii) All liferafts must be served by at least one launching appliance on each side of the ship.
 - (b) If the rescue boat required by subparagraph 7.2.7(b) is also a lifeboat it may be included in the aggregate capacity referred to in subparagraph (a).
 - (c) The number and arrangement of survival craft must be such that in the event of any one survival craft being lost or rendered unserviceable, there must still be sufficient survival craft available for use on each side of the ship to accommodate the total number of persons the ship is certified to carry.



7.2.6 A marine evacuation system may be substituted for the equivalent capacity of liferafts and launching appliances required by paragraph 7.2.2(b) or 7.2.3(b).

7.2.7

- (a) Every ship of 500 tons and over must carry at least one rescue boat on each side of the ship.
- (b) Every ship of less than 500 tons must carry at least one rescue boat.
- (c) A lifeboat may be accepted as a rescue boat provided it also complies with the requirements for a rescue boat.
- (d) Every ship which is subdivided in accordance with the Merchant Shipping (Passenger Ship Construction: Ships of Classes I, II and II(A)) Regulations 1998 (SI 1998/2514) must carry sufficient lifeboats and rescue boats to ensure that when evacuating the total number of persons the ship is certified to carry the lifeboat or rescue boat should not need to marshal more than 6 liferafts.

7.2.8 Each lifeboat and rescue boat must be served by its own launching appliance.

7.2.9 Every ship must be provided with the following equipment:

- (a) a satellite EPIRB;
- (b) at least 3 waterproofed two-way VHF radiotelephone apparatus; and
- (c) on each side of the ship, at least one radar transponder stowed in such a location that it can be rapidly placed in any survival craft or, alternatively, one radar transponder stowed in each survival craft.

7.2.10 Every ship must be provided with the following equipment:

- (a) Every ship must carry at least the number of lifebuoys determined in accordance with the following table:

Length of ship in metres	Minimum number of lifebuoys
Under 60	8
60 or more but less than 120	12
120 or more but less than 180	18
180 or more but less than 240	24
240 and over	30

- (b) At least one lifebuoy on each side of the ship must be fitted with a buoyant lifeline. Not less than 50 per cent of the total number of lifebuoys, and on every ship of less than 60 metres in length not less than 6 lifebuoys, must be provided with self-igniting lights and not less than two of the lifebuoys provided with such lights must also be provided with self-activating smoke signals and be capable of quick release from the navigating bridge.

7.2.11 Every ship must carry:

- (a) for each person the ship is certified to carry a lifejacket suitable for a person weighing 32 kilogrammes or more;



- (b) a lifejacket suitable for a person weighing less than 32 kilograms for each such person on board or for 10 per cent of the number of passengers the ship is certified to carry, whichever is the greater;
- (c) in addition to the lifejackets carried in compliance with subparagraphs (a) and (b) lifejackets suitable for persons weighing 32 kilograms or more for not less than 5 per cent of the total number of persons the ship is certified to carry; and
- (d) a sufficient number of lifejackets for persons on watch and for use at remotely located survival craft stations.

7.2.12 The lifejackets used in totally enclosed lifeboats must not impede entry into the lifeboat or seating, including operation of the seat belts in the lifeboat.

7.2.13 Included in the number of lifejackets required to be carried by paragraph 7.2.11 there must be at least sufficient inflatable lifejackets for the crew of each rescue boat and, for those crew members whose emergency duties require it, a lifejacket which will not unduly hinder them during the execution of these duties.

7.2.14 Each lifejacket required to be carried by paragraphs 7.2.11 and 7.2.13 must be fitted with a lifejacket light complying with the requirements of Schedule 9, Part 1.

7.2.15 Every ship must carry, for every person assigned to crew a rescue boat or assigned to the marine evacuation system party, an immersion suit or an anti-exposure suit of an appropriate size and as specified in section 7.26.

7.2.16 Every ship must carry not less than 12 rocket parachute flares.

7.2.17 Every ship must carry a line-throwing appliance.

7.2.18 Every ship must be provided with:

- (a) an emergency means for two-way communication (which may be fixed or portable equipment, or both) between emergency control stations, assembly and embarkation stations and strategic positions on board. This may be the equipment which is carried in compliance with paragraph 7.2.9;
- (b) on ships fitted with a marine evacuation system, communication between the embarkation station and the platform or the survival craft;
- (c) a general emergency alarm system, complying with the requirements of Schedule 11, Part 1;
- (d) a public address system complying with the requirements of Schedule 11, Part 2; and
- (e) lighting as specified in sections 7.15.4, 7.15.5 and 7.18.8.

7.2.19 Every ship must be provided with:

- (a) posters or signs showing operating instructions, on or in the vicinity of survival craft and their launching controls;
- (b) a training manual in each crew messroom and recreation room or in each crew cabin;
- (c) instructions for on-board maintenance of life-saving appliances or a shipboard planned maintenance programme which includes the maintenance of life-saving appliances; and



- (d) on the bridge, with a copy of the table "Life-Saving Signals for Ships, Aircraft and Persons in distress" published by the Maritime and Coastguard Agency.

7.2.20

- (a) Section 7.2.20 applies to ro-ro passenger ships.
- (b) Liferrafts on ro-ro passenger ships must:
 - (i) be served by marine evacuation systems complying with the requirements of Schedule 5, Part 1 or launching appliances complying with the requirements of Schedule 6, Part 3 equally distributed on each side of the ship;
 - (ii) be provided with float-free launching arrangements complying with the requirements of Schedule 4, Part 8;
 - (iii) be fitted with a semi-rigid boarding ramp capable of supporting a person weighing 100 kgs; and
 - (iv) either be an automatic self-righting liferaft or be a canopied reversible liferaft which is stable in a seaway and is capable of operating safely whichever way up it is floating. Alternatively, and providing the existing liferafts comply with Schedule 4, the ship must carry automatic self-righting liferafts or canopied reversible liferafts, in addition to its normal complement of liferafts, of such aggregate capacity as will accommodate at least 50 per cent of the persons not accommodated in lifeboats. This additional liferaft capacity must be determined on the basis of the difference between the total number of persons on board and the number of persons accommodated in lifeboats.
 - (aa) The liferafts carried on a ro-ro passenger ship must be fitted with sufficient radar transponders so that there is one radar transponder for every four liferafts.
 - (bb) Subject to sub-paragraph (cc), a radar transponder fitted to a liferaft carried by a ro-ro passenger ship must be capable of:
 - (i) being mounted inside the liferaft so that the antenna of the radar transponder is more than one metre above sea level, and
 - (ii) being erected manually, after the liferaft is deployed.
 - (cc) Where a radar transponder is fitted to a canopied reversible liferaft, the radar transponder must be fitted so that those using the liferaft can readily gain access to and erect the radar transponder.
 - (dd) Every container of a liferaft which is fitted with a radar transponder must be clearly marked to indicate that the liferaft is so fitted.
- (c) Fast rescue boats:
 - (i) At least one of the rescue boats provided pursuant to paragraph 7.2.7 must be a fast rescue boat complying with the requirements of Schedule 2, Part 10 except that ships having a rescue boat that is substantially in compliance with Schedule 2, Part 10 shall not be required to replace their rescue boat:



- (ii) each fast rescue boat must be served by a suitable launching appliance complying with the requirements of Schedule 6, Part 1 and 2: such launching appliances must take into account that the fast rescue boat is intended to be launched and retrieved even under severe adverse weather condition;
 - (iii) at least two crews of each fast rescue boat must be trained, certified and drilled regularly having regard to the Merchant Shipping (Standards for Training, Certification and Watchkeeping) Regulations 2015 including all aspects of rescue, handling, manoeuvring, operating these craft in various conditions, and righting them after capsize; and
 - (iv) if the arrangement or size of the ship is such as to prevent the installation of the fast rescue boat required by subparagraph (c)(i), the fast rescue boat may be installed in place of an existing lifeboat which is accepted as a boat for use in any emergency, provided that all of the following conditions are met:
 - (aa) the fast rescue boat installed is served by a launching appliance complying with the provisions of (c)(ii);
 - (bb) the capacity of the survival craft lost by the above substitution is compensated by the installation of liferafts capable of carrying at least an equal number of persons served by the lifeboat replaced;
 - (cc) such liferafts are served by the existing launching appliances or marine evacuation systems; and
 - (dd) every ship must carry, for every person assigned to crew of a fast rescue boat, an immersion suit or anti-exposure suit of an appropriate size and complying with section 7.26.
- (d) Means of rescue:
- (i) Each ro-ro passenger ship must be equipped with an efficient means of rescue complying with the requirements of Schedule 5, Part 3 for rapidly recovering survivors from the water and transferring survivors from rescue units or survival craft to the ship;
 - (ii) the means of transfer of survivors to the ship may be part of a marine evacuation system, or may be part of a system designed for rescue purposes;
 - (iii) if the inclined passage of a marine evacuation system is intended to provide the means of transfer of survivors to the deck of the ship, the inclined passage must be equipped with handlines or ladders to aid in climbing up the inclined passage; and
 - (iv) a fast rescue boat launching and recovery appliance may be used as part of a means of rescue system.
- (e) Lifejackets:
- A sufficient number of lifejackets must be stowed in the vicinity of the assembly stations so that passengers do not have to return to their cabins to collect their lifejackets.
- (f) Helicopter emergency pick-up or landing area:
- (i) Subject to paragraph (ii) below, a helicopter emergency pick-up area must be provided on a ship complying with the requirements of IAMSAR.



- (ii) A ro-ro ship of 130 metres or over in length constructed on or after 1st July 1999 shall not be required to be provided with a helicopter emergency pick-up area but must be fitted with a helicopter emergency landing area complying with the requirements of MSN 1737 (M).

7.3 Ships of Class VIII(A)

7.3.1 This section applies to ships of Class VIII(A) the keels of which were laid, or which were at a similar stage of construction on or after 1st July 1998.

7.3.2 Every ship must carry:

- (a) on each side of the ship one or more totally enclosed lifeboats complying with the requirements of Schedule 2, Part 4 of sufficient aggregate capacity to accommodate the total number of persons on board; and
- (b) one or more inflatables or rigid liferafts stowed in a position providing for easy side-to-side transfer at a single open deck level and capable of being launched on either side of the ship and of sufficient aggregate capacity to accommodate the total number of persons on board; if the liferaft or liferafts cannot be readily transferred for launching on either side of the ship, the total capacity available on each side must be sufficient to accommodate the total number of persons on board.

7.3.3 In lieu of complying with the requirements of paragraph 7.3.2 ships may carry:

- (a) one or more lifeboats complying with the requirements of Schedule 2, Part 9 capable of free-fall launching over the stern of the ship of sufficient aggregate capacity to accommodate the total number of persons on board; and
- (b) on each side of the ship one or more inflatable liferafts of sufficient aggregate capacity to accommodate the total number of persons on board. The liferafts on at least one side of the ship must be served by launching appliances.

7.3.4

- (a) Every ship of less than 85 metres in length may, in lieu of carrying the lifeboats and liferafts required by paragraph 7.3.2 or 7.3.3, carry on each side of the ship one or more inflatable or rigid liferafts of sufficient aggregate capacity to accommodate the total number of persons on board.
- (b) If these liferafts are not stowed in a position providing for each side-to-side transfer at a single open deck level and cannot be readily transfers for launching on either side of the ship, the total capacity available on each side must be sufficient to accommodate 150 per cent of the total number of persons on board.
- (c) If the rescue boat required by paragraph 7.3.6 is also a totally enclosed lifeboat complying with the requirements of Schedule 2 Part 4, its capacity may be included in the aggregate capacity required by sub-paragraph (a), provided that the total capacity available on either side of the ship is at least 150% of the total number of persons on board.
- (d) The number and arrangement of survival craft must be such that in the event of any one survival craft being lost or rendered unserviceable there must still be sufficient survival craft available for use on each side of the ship including any which are stowed in a position providing for easy side-to-side transfer at a single open deck level, to accommodate the total number of persons on board.



7.3.5 Where survival craft are stowed in a position where the horizontal distance from the extreme end of the stem or stern of the ship to the nearest end of the survival craft is more than 100 metres there must be carried, in addition to the liferafts required by paragraph 7.3.2(b) or 7.3.3(b), a liferaft stowed as far forward or aft, or one as far forward and another as far aft, as is reasonable and practicable.

7.3.6 Every ship of 500 tons or over must carry at least one rescue boat. Every ship of less than 500 tons must carry at least one rescue boat, or inflated boat fitted with an engine. A lifeboat may be accepted as a rescue boat, provided that it also complies with the requirements for a rescue boat.

7.3.7 Each lifeboat, rescue boat and inflated boat must be served by its own launching appliance.

7.3.8 Every tug of Class IX other than a tug of 500 tons or over engaged on an international voyage, must, in addition to complying with the requirements of paragraph 7.3.2, 7.3.3 or 7.3.4 and with the requirements of paragraph 7.3.6, carry buoyant apparatus sufficient to support the total number of persons on board.

7.3.9 Every ship must be provided with the following equipment:

- (a) a satellite EPIRB;
- (b) in the case of a ship of 500 tons or over, at least 3 waterproofed two-way VHF radiotelephone apparatus and in the case of ship of under 500 tons, at least 2 waterproofed two-way VHF radiotelephone apparatus; and
- (c) in the case of a ship of 500 tons or over, on each side of the ship at least one radar transponder, and in the case of a ship of over 300 tons and under 500 tons at least one radar transponder. The radar transponder must be stowed in such a location that it can be rapidly placed in any survival craft other than the liferaft or liferafts required by paragraph 7.3.5 or, alternatively, one radar transponder must be stowed in each survival craft other than those required by paragraph 7.3.5. On ships carrying at least two radar transponders and equipped with free-fall lifeboats one of the radar transponders must be stowed in a free-fall lifeboat and the other located in the immediate vicinity of the navigation bridge so that it can be utilised on board and be ready for transfer to any of the other survival craft.

7.3.10

- (a) Every ship must carry at least the number of lifebuoys determined in accordance with the following table:

Length of ship in metres	Minimum number of lifebuoys
Under 100	8
100 or more but less than 150	10
150 or more but less than 200	12



provided that in ships under 100 metres in length and less than 500 tons, not more than 4 lifebuoys need to be carried.

- (b) At least one lifebuoy on each side of the ship must be fitted with a buoyant lifeline. Not less than 50 per cent of the total number of lifebuoys must be provided with self-igniting lights and not less than two of the lifebuoys provided with such lights must also be provided with self-activating smoke signals and be capable of quick release from the navigating bridge.

7.3.11 Every ship must carry:

- (a) for each person on board, a lifejacket suitable for a person weighing 32 kilogrammes or more;
- (b) a lifejacket suitable for a person weighing less than 32 kilograms for each such person on board: provided that there must never be less than 2 such lifejackets on any ship which carries children;
- (c) a sufficient number of additional lifejackets for the use of persons on watch and at remotely located survival craft stations: provided that there must be at least 4 additional lifejackets on ships where the number of persons on board is 16 or less, and at least an additional 25 per cent of the number of lifejackets required to be carried by subparagraph (a) in the case of ships where the number on board is more than 16: provided that the number of additional lifejackets need not exceed the number of persons on board. Lifejackets used in totally enclosed lifeboats must not impede entry into the lifeboat or seating, including operation of the seat belts.

7.3.12 Included in the number of lifejackets required by paragraph 7.3.11 to be carried there must be at least sufficient inflatable lifejackets:

- (a) for the crew of the rescue boat and for those crew members whose emergency duties require a lifejacket which will not unduly hinder them during the execution of those duties; and
- (b) on ships fitted with free-fall lifeboats, to provide one for each person on board; these inflatable lifejackets must be stowed adjacent to the free-fall lifeboat embarkation area.

7.3.13 Each lifejacket required to be carried by paragraphs 7.3.11 and 7.3.12 must be fitted with a lifejacket light complying with the requirements of Schedule 9, Part 1.

7.3.14 Every ship must carry, for every person assigned to crew the rescue boat or inflated boat, an immersion suit or an anti-exposure suit of an appropriate size and as specified in section 7.26.

7.3.15

- (a) Every ship which carries survival craft as prescribed in paragraph 7.3.4(a) must carry an immersion suit as specified in section 7.26 for every person on board unless:
 - (i) the liferafts are served by launching appliances; or
 - (ii) the liferafts are served by equivalent approved appliances capable of being used on both sides of the ship and which do not require entry into the water to board



the liferaft.

- (b) The immersion suits required by this paragraph may be used to comply with the requirements of paragraph 7.3.14.

7.3.16 Every ship must carry not less than 12 rocket parachute flares.

7.3.17 Every ship of 12 metres in length and over must carry a line-throwing appliance.

7.3.18 Every ship must be provided with:

- (a) an emergency means for two-way communication (which may be fixed or portable equipment or both) between emergency control stations, assembly and embarkation stations and strategic positions on board. This may be the equipment carried in compliance with paragraph 7.3.9;
- (b) a general emergency alarm system, except that in ships of less than 45.7 metres in length the additional electrically operated means referred to in Schedule 11, Part 1 need not be provided; in addition, in ships of 500 tons or over, either a public address system or other suitable means of communication; and
- (c) lighting as specified in sections 7.15.4, 7.15.5 and 7.18.8: provided that in ships of less than 500 tons such lighting need only be provided from one source of electrical power.

7.3.19 Every ship must be provided with:

- (a) posters or signs showing operating instructions on or in the vicinity of survival craft and their launching controls;
- (b) a training manual in each crew messroom and recreation room or in each crew cabin;
- (c) instructions for on-board maintenance of life-saving appliances or a shipboard planned maintenance programme which includes the maintenance of life-saving appliances; and
- (d) on the bridge, with a copy of the table "Life-Saving Signals for Ships, Aircraft and Persons in distress" published by the Maritime and Coastguard Agency.

7.4 Ships of Class VIII(A)(T)

7.4.1 This section applies to ships of Class VIII(A)(T) the keels of which were laid, or which were at a similar stage of construction on or after 1st July 1998.

7.4.2 Every ship carrying cargo which emits toxic vapours or gasses must carry on each side of the ship one or more lifeboats with a self-contained air support system complying with the requirements of Schedule 2, Part 5 of sufficient aggregate capacity to accommodate the total number of persons on board.

7.4.3 Every ship carrying cargo having a flashpoint not exceeding 60°C (closed cup test) must carry on each side of the ship one or more fire protected lifeboats complying with the requirements of Schedule 2, Part 6 of sufficient aggregate capacity to accommodate the total number of persons on board.

7.4.4 Every ship must carry, in addition to the lifeboats required by paragraph 7.4.2 or 7.4.3, one or more inflatables or rigid liferafts stowed in a position providing for easy side-to-side transfer at a single open deck level and capable of being launched on either side of the



ship of sufficient aggregate capacity to accommodate the total number of persons on board. If the liferaft or liferafts cannot be readily launched on either side of the ship, the total capacity available on each side must be sufficient to accommodate the total number of persons on board.

7.4.5 In lieu of complying with the requirements of paragraphs 7.4.2 and 7.4.4 ships carrying cargoes emitting toxic vapours or gases may carry:

- (a) one or more lifeboats with a self-contained air support system complying with the requirements of Schedule 2, Parts 5 and 9, capable of free-fall launching over the stern of the ship of sufficient aggregate capacity to accommodate the total numbers of persons on board; and
- (b) one or more liferafts on each side of the ship of sufficient aggregate capacity to accommodate the total number of persons on board. The liferafts on at least one side of the ship must be served by launching appliances.

7.4.6 In lieu of complying with the requirements of paragraphs 7.4.3 and 7.4.4 ships carrying cargoes having a flashpoint not exceeding 60°C (closed cup test) may carry:

- (a) one or more lifeboats complying with the requirements of Schedule 2, Parts 5, 6 and 9 capable of free-fall launching over the stern of the ship of sufficient aggregate capacity to accommodate the total number of persons on board; and
- (b) one or more liferafts on each side of the ship of sufficient aggregate capacity to accommodate the total number of persons on board. The liferafts on at least one side of the ship must be served by launching appliances.

7.4.7

- (a) Every ship of less than 500 tons may, in lieu of carrying the lifeboats and liferafts required by paragraph 7.4.2, 7.4.3, 7.4.4, 7.4.5 or 7.4.6, carry one or more liferafts on each side of the ship of sufficient aggregate capacity to accommodate the total number of persons on board.
- (b) If such liferafts are not stowed in a position providing for easy side-to-side transfer at a single open deck level and cannot be readily launched on either side of the ship, the total capacity available on each side must be sufficient to accommodate 150 per cent of the total number of persons on board.
- (c) If the rescue boat required by paragraph 7.4.9 is also a lifeboat complying with the requirements of Schedule 2, Parts 5 or 6, it may be included in the aggregate capacity referred to in subparagraph (a): provided that the total capacity available on either side of the ship is at least 150 per cent of the total number of persons on board.
- (d) The number and arrangement of survival craft must be such that in the event of any one survival craft being lost or rendered unserviceable, there must be sufficient survival craft available for use on each side, including any which are stowed in a position providing for easy side-to-side transfer at a single open deck level to accommodate the total number of persons on board.

7.4.8 Where survival craft are stowed in a position where the horizontal distance from the extreme end of the stem or stern of the ship to the nearest end of the survival craft is more than 100 metres from the stem or stern, there must be carried, in addition to the liferafts required by paragraph 7.4.4 or paragraph 7.4.5(b) or 7.4.6(b) a liferaft stowed as far forward or aft as is reasonable and practicable.



7.4.9 Every ship of 500 tons or over must carry at least one rescue boat. Every ship of less than 500 tons must carry at least one rescue boat, or inflated boat fitted with an engine. A lifeboat may be accepted as a rescue boat: provided that it also complies with the requirements for a rescue boat.

7.4.10 Each lifeboat, rescue boat and inflated boat must be served by its own launching appliance.

7.4.11 Every ship must be provided with the following equipment:

- (a) a satellite EPIRB;
- (b) in the case of a ship of 500 tons or over, at least 3 waterproofed two-way VHF radiotelephone apparatus and in the case of a ship of under 500 tons, at least 2 waterproofed two-way VHF radio telephone apparatus; and
- (c) in the case of a ship of 500 tons or over, on each side of the ship at least one radar transponder, and in the case of a ship of over 300 tons and under 500 tons at least one radar transponder. Each radar transponder must be stowed in such a location that it can be rapidly placed in any survival craft other than the liferaft or liferafts required by paragraph 7.4.8 or, alternatively, one radar transponder must be stowed in each survival craft other than those required by paragraph 7.4.8. On ships carrying at least two radar transponders and equipped with free-fall lifeboats, one of the radar transponders must be stowed in a free-fall lifeboat and the other located in the immediate vicinity of the navigation bridge so that it can be utilised on board and ready for transfer to any of the other survival craft.

7.4.12

- (a) Every ship must carry at least the number of lifebuoys determined in accordance with the following table:

Length of ship in metres	Minimum number of lifebuoys
Under 100	8
100 or more but less than 150	10
150 or more but less than 200	12
200 and over	14

provided that in ships under 100 metres in length and less than 500 tons, not more than 4 lifebuoys need to be carried.

- (b) At least one lifebuoy on each side of the ship must be fitted with a buoyant lifeline. Not less than 50 per cent of the total number of lifebuoys must be provided with self-igniting lights of an electric battery type and not less than two of the lifebuoys provided with such lights must also be provided with self-activating smoke signals and be capable of quick release from the navigating bridge.

7.4.13 Every such ship must carry:

- (a) for each person on board, a lifejacket suitable for a person weighing 32 kilograms or more;



- (b) a lifejacket suitable for a person weighing less than 32 kilograms for each such person on board: provided that there must never be less than 2 such lifejackets on any ship whichever carries children;
- (c) a sufficient number of additional lifejackets for the use of persons on watch and at remotely located survival craft stations: provided that there must be at least 4 additional lifejackets on ships where the number of persons on board is 16 or less and at least an additional 25 per cent of the number of lifejackets required to be carried by subparagraph (a) in the case of ships where the number on board is more than 16: provided that the number of additional lifejackets need not exceed the number of persons on board, lifejackets used in totally enclosed lifeboats must not impede entry into the lifeboat or seating, including operation of the seat belts.

7.4.14 Included in the number of lifejackets required by paragraph 7.4.13 to be carried there must be at least sufficient inflatable lifejackets:

- (a) for the crew of the rescue boat and for those crew members whose emergency duties require a lifejacket which will not unduly hinder them during the execution of these duties; and
- (b) on ships fitted with free-fall lifeboats, to provide one for each person on board, these inflatable lifejackets must be stowed adjacent to the free-fall lifeboat embarkation area.

7.4.15 Each lifejacket required to be carried by paragraphs 7.4.13 and 7.4.14 must be fitted with a lifejacket light complying with the requirements of Schedule 9.

7.4.16 Every ship must carry, for every person assigned to crew the rescue boat or inflated boat, an immersion suit or an anti-exposure suit of an appropriate size and as specified in section 7.26.

7.4.17

- (a) Every ship which carries survival craft pursuant to paragraph 7.4.7(a) must carry an immersion suit as specified in section 7.26 for every person on board unless:
 - (i) the liferafts are served by launching appliances; or
 - (ii) the liferafts are served by equivalent approved appliances capable of being used on both sides of the ship and which do not require entry into the water to board the liferaft.
- (b) The immersion suits required by this paragraph may be used to comply with the requirements of paragraph 7.4.16.

7.4.18 Every ship must carry not less than 12 rocket parachute flares.

7.4.19 Every ship of 12 metres in length and over must carry a line-throwing appliance.

7.4.20 Every ship must be provided with:

- (a) an emergency means for two-way communication (which may be fixed or portable equipment or both) between emergency control stations, assembly and embarkation stations and strategic positions on board. This may be the equipment carried in compliance with paragraph 7.4.11(b);



- (b) a general emergency alarm system, except that in ships of less than 45.7 metres in length the additional electrically operated means referred to in Schedule 11, Part 1, need not be provided; in addition, in ships of 500 tons or over, either a public address system or other suitable means of communication; and
- (c) lighting as specified in sections 7.15.4, 7.15.5 and 7.18.8: provided that in ships of less than 500 tons such lighting need only be provided from one source of electrical power.

7.4.21 Every ship must be provided with:

- (a) posters or signs showing operating instructions, on or in the vicinity of survival craft and their launching controls;
- (b) a training manual in each crew messroom and recreation room or in each crew cabin;
- (c) instructions for on-board maintenance of life-saving appliances or a shipboard planned maintenance programme which includes the maintenance of life-saving appliances; and
- (d) on the bridge, with a copy of the table "Life-Saving Signals for Ships, Aircraft and Persons in distress" published by the Maritime and Coastguard Agency.

7.5 Ships of Class IX(A)

7.5.1 This section applies to ships of Class IX(A) the keels of which were laid, or which were at similar stage of construction on or after 1st July 1998.

7.5.2 Every ship must, when engaged in a voyage in only Category A, B or C waters, be equipped as follows:

- (a) ships of less than 12 metres in length must carry either one lifebuoy complying with Schedule 8, Part 2 for each two persons on board or one lifebuoy complying with Schedule 8, Part 3 for each person: provided that at least two lifebuoys are carried and that all are the same type. One lifebuoy must be fitted with a buoyant lifeline at least 18 metres in length and one lifebuoy with a self-igniting light and self-activating smoke signal;
- (b) ships of 12 metres in length and over but less than 20 metres in length must carry:
 - (i) one lifebuoy for each two persons on board: provided that at least two lifebuoys are carried; one lifebuoy must be fitted with a buoyant lifeline at least 18 metres in length and one lifebuoy with a self-igniting light and self-activating smoke signal;
 - (ii) a lifejacket suitable for a person weighing 32 kilogrammes or more for each person on board; and
 - (iii) a lifejacket suitable for a person weighing less than 32 kilogrammes for each such person on board; and
 - (iv) each lifejacket required to be carried by this subparagraph must be fitted with a lifejacket light complying with the requirements of Schedule 9, Part 1;
- (c) ships of 20 metres in length and over must carry:



- (i) one lifebuoy for each two persons on board: provided that at least four lifebuoys are carried; one lifebuoy on each side of the ship must be fitted with a buoyant lifeline and one lifebuoy on each side of the ship with a self-igniting light and self-activating smoke signal;
 - (ii) a lifejacket suitable for a person weighing 32 kilogrammes or more for each person on board; and
 - (iii) a lifejacket suitable for a person weighing less than 32 kilogrammes for each such person on board; and
 - (iv) each lifejacket required to be carried by this subparagraph shall be fitted with a lifejacket light complying with the requirements of Schedule 9, Part 1;
- (d) in ships of Class IX(A)(T) lifebuoy self-igniting lights must be of an electric battery type.

7.5.3 Every ship must when engaged in a voyage which is in part in Category A, B or C waters and which is also in part in Category D waters, must be equipped as follows:

- (a) ships of less than 12 metres in length must carry:
 - (i) either one lifebuoy complying with Schedule 8, Part 2 for each two persons on board or one lifebuoy complying with Schedule 8, Part 3 for each person: provided that at least two lifebuoys are carried and all are of the same type; one lifebuoy must be fitted with a buoyant lifeline at least 18 metres in length and one lifebuoy with a self-igniting light and self-activating smoke signal; and
 - (ii) six rocket parachute flares;
- (b) ships of 12 metres in length and over but less than 20 metres in length must carry:
 - (i) one or more liferafts stowed in a position providing for easy side-to-side transfer at a single open deck level and complying with the requirements of Schedule 4, Part 2, 3 or 5, of sufficient aggregate capacity to accommodate the total number of persons on board; if the liferaft or liferafts cannot be readily launched on either side of the ship, the total capacity available on each side must be sufficient to accommodate the total number of persons on board;
 - (ii) two lifebuoys, one of which must be fitted with a buoyant lifeline at least 18 metres in length and the other with a self-igniting light and self-activating smoke signal;
 - (iii) a lifejacket suitable for a person weighing 32 kilogrammes or more for each person on board;
 - (iv) a lifejacket suitable for a person weighing less than 32 kilogrammes for each such person on board;
 - (v) each lifejacket required to be carried by this subparagraph must be fitted with a lifejacket light complying with the requirements of Schedule 9, Part 1; and
 - (vi) six distress rocket parachute flares;
- (c) ships of 20 metres in length and over must carry:
 - (i) one or more liferafts stowed in a position providing for easy side-to-side transfer at a single open deck level and complying with the requirements of Schedule 4,



Part 2, 3 or 5, of sufficient aggregate capacity to accommodate the total number of persons on board; if the liferaft or liferafts cannot be readily launched on either side of the ship the total capacity available on each side must be sufficient to accommodate the total number of persons on board;

- (ii) four lifebuoys, two of which must be fitted with buoyant lifelines and two with self-igniting lights and self-activating smoke signals;
 - (iii) a lifejacket suitable for a person weighing 32 kilogrammes or more for each such person on board;
 - (iv) a lifejacket suitable for a person weighing less than 32 kilogrammes for each such person on board;
 - (v) each lifejacket required to be carried by this subparagraph must be fitted with a lifejacket light complying with the requirements of Schedule 9, Part 1; and
 - (vi) six rocket parachute flares;
- (d) in ships of Class IX(A)(T) lifebuoy self-igniting lights must be of an electric battery type.

7.5.4 Every tug and tender which paragraphs 7.5.2 or 7.5.3 apply must, in addition to the equipment required by these paragraphs, carry buoyant apparatus of sufficient aggregate capacity to accommodate the total number of persons on board.

7.5.5 Every ship to which paragraph 7.5.3 (b) or (c) or paragraph 7.5.4 applies must be provided with:

- (a) lighting as specified in sections 7.15.4, 7.15.5 and 7.18.8 provided from at least one source of electrical power;
- (b) posters and signs showing operating instructions on or in the vicinity of the liferafts and their launching controls, where provided;
- (c) a training manual; and
- (d) with instructions for on-board maintenance of life-saving appliances or a shipboard planned maintenance programme which includes the maintenance of life-saving appliances.

7.6 Ships of Class IX(A)(T)

7.6.1 This section applies to ships of Class IX(A)(T) the keels of which were laid, or which were at a similar stage of construction on or after 1st July 1998.

7.6.2 Section 7.5 applicable to ships of Class IX(A) applies to ships of Class IX(A)(T) as it applies to ships of Class IX(A).

7.7 Ships of Class XI

7.7.1 This section applies to ships of Class XI the keels of which were laid, or which were at a similar stage of construction on or after 1st July 1998.

7.7.2 Every ship must carry:



- (a) one or more inflatable or rigid liferafts stowed in a position providing for easy side-to-side transfer at a single open deck level on each side of the ship of sufficient aggregate capacity to accommodate the total number of persons on board, provided that:
 - (i) if the liferafts cannot be readily launched on either side of the ship, the total capacity available on each side must be sufficient to accommodate 150 per cent of the total number of persons on board;
 - (ii) if the rescue boat required by subparagraph (b) is also a lifeboat it may be included in the aggregate capacity provided the total capacity available on either side of the ship is at least 150 per cent of the total number of persons on board; and
 - (iii) the number and arrangement of survival craft must be such that in the event of any one survival craft being lost or rendered unserviceable, there must be sufficient survival craft available for use on each side to accommodate the total number of persons on board;
- (b) at least one rescue boat: provided that in ships of less than 500 tons an inflated boat fitted with an engine may be carried in lieu of a rescue boat; a lifeboat may be accepted as a rescue boat; provided that it also complies with the requirements for a rescue boat. The lifeboat, rescue boat or inflated boat must be served by its own launching appliance.

7.7.3 Every ship to which this section applies must be provided with the following equipment:

- (a) a satellite EPIRB;
- (b) in the case of a ship of 500 tons or over, at least 3 waterproofed two-way VHF radiotelephone apparatus and in the case of a ship of under 500 tons, at least 2 waterproofed two-way VHF radiotelephone apparatus; and
- (c) in the case of a ship of 500 tons or over, on each side of the ship at least one radar transponder, and in the case of a ship of 300 tons and under 500 tons at least one radar transponder. The radar transponders must be stowed in such locations that they can rapidly be placed in any survival craft or, alternatively, one radar transponder must be stowed in each survival craft.

7.7.4

- (a) Every ship must carry at least the number of lifebuoys determined in accordance with the following table:

Length of ship in metres	Minimum number of lifebuoys
Under 50	6
50 and over	8

- (b) Ships of less than 12 metres in length may carry, in lieu of lifebuoys complying with Schedule 8, Part 2, lifebuoys complying with Schedule 8, Part 3: provided that all are of the same type.

At least one lifebuoy on each side of the ship must be fitted with a buoyant lifeline. Not less than 50 per cent of the total number of lifebuoys must be provided with self-igniting lights and not less than two of the lifebuoys provided with such lights must also be provided with self-activating smoke signals and be capable of quick release from the navigating bridge/steering position. On ships of less than 12 metres in length the buoyant lifelines must be at least 18 metres in length.



- 7.7.5 Every ship must carry:
- (a) for each person on board, a lifejacket suitable for a person weighing 32 kilograms or more;
 - (b) a lifejacket suitable for a person weighing less than 32 kilograms for each such person on board; provided that there must never be less than 2 such lifejackets on any ship whichever carries children; and
 - (c) a sufficient number of additional lifejackets for the use of persons on watch and for use at remotely located survival craft stations: provided that there must be at least 4 additional lifejackets on ships where the number of persons on board is 16 or less, and at least an additional 25 per cent of the number of lifejackets required to be carried by subparagraph (a) in the case of ships where the number on board is more than 16: provided that the number of additional lifejackets need not exceed the number of persons on board.
- 7.7.6 Included in the number of lifejackets required to be carried by paragraph 7.7.5 there must be at least sufficient inflatable lifejackets for the crew of the rescue boat and for those crew members whose emergency duties require a lifejacket which will not unduly hinder them during the execution of these duties.
- 7.7.7 Each lifejacket required to be carried by paragraphs 7.7.5 and 7.7.6 must be fitted with a lifejacket light complying with the requirements of Schedule 9, Part 1.
- 7.7.8 Every ship must carry, for every person assigned to crew the rescue boat or inflated boat, an immersion suit or an anti-exposure suit of an appropriate size and as specified in section 7.26.
- 7.7.9
- (a) Every ship must carry an immersion suit complying as specified in section 7.26 for every person on board unless:
 - (i) the liferafts are served by launching appliances; or
 - (ii) the liferafts are served by equivalent approved appliances capable of being used on both sides of the ship and which do not require entry into the water to board the liferaft.
 - (b) The immersion suits required by this paragraph may be used to comply with the requirements of paragraph 7.7.8.
- 7.7.10 Every ship must carry not less than 12 rocket parachute flares.
- 7.7.11 Every ship of 12 metres in length and over must carry a line-throwing appliance.
- 7.7.12 Every ship must be provided with:
- (a) a general emergency alarm system except that in ships of less than 45.7 metres in length the additional electrically operated means referred to in Schedule 11, Part 1 need not be provided; in addition, in ships of 500 tons or over, either a public address system or other suitable means of communication; and
 - (b) lighting as specified in sections 7.15.4, 7.15.5 and 7.18.8: provided that such lighting need only be provided from one source of electrical power.
- 7.7.13 Every ship must be provided with:



- (a) posters or signs showing operating instructions on or in the vicinity of survival craft and their launching controls;
- (b) a training manual in each crew messroom and recreation room or in each crew cabin;
- (c) instructions for on-board maintenance of life-saving appliances or a shipboard planned maintenance programme which includes the maintenance of life-saving appliances; and
- (d) on the bridge, with a copy of the table "Life-Saving Signals for Ships, Aircraft and Persons in distress" published by the Maritime and Coastguard Agency.

7.8 Ships of Class XII

7.8.1 This section applies to ships of Class XII the keels of which were laid, or which were at a similar stage of construction on or after 1st July 1998.

7.8.2 Every ship of 21.3 metres in length and over must carry:

- (a) at least two inflatable or rigid liferafts stowed in a position providing for easy side-to-side transfer at a single open deck level so that they can be readily transferred to the water on either side of the ship, of sufficient aggregate capacity to accommodate twice the total number of persons on board;
- (b) four lifebuoys, two of which must be fitted with buoyant lifelines and two with self-igniting lights and self-activating smoke signals;
- (c) a lifejacket suitable for a person weighing 32 kilogrammes or more for each person on board;
- (d) a lifejacket suitable for a person weighing less than 32 kilogrammes for each person on board;
- (e) 6 rocket parachute flares;
- (f) a line-throwing appliance;
- (g) posters or signs showing operating instruction on or in the vicinity of survival craft and their launching controls;
- (h) a training manual;
- (i) instructions for on-board maintenance of life-saving appliances; and
- (j) a copy of the table "Life-Saving Signals for Ships, Aircraft and Persons in distress" published by the Maritime and Coastguard Agency;

and any such ship of 25.9 metres in length or over must carry in addition a rescue boat or inflated boat. A lifeboat may be accepted as a rescue boat; provided that it also complies with the requirements for a rescue boat. The lifeboat, rescue boat or inflated boat must be served by a launching appliance. Each lifejacket required to be carried by subparagraphs (c) and (d) must be fitted with a lifejacket light complying with the requirements of Schedule 9, Part 1.

7.8.3 Every ship of 13.7 metres in length or over but less than 21.3 metres in length and engaged on either a voyage to sea in the course of which it is more than 3 miles from the



coast of the United Kingdom or a voyage to sea during the months of November to March, inclusive, must carry:

- (a) one or more liferafts complying with the requirements of Schedule 4, Part 2, 3 or 5, stowed in a position providing for easy side-to-side transfer at a single open deck level as to be readily transferable to the water on either side of the ship and of sufficient aggregate capacity to accommodate the total number of persons on board;
- (b) two lifebuoys, one of which must be fitted with a self-igniting light and self-activating smoke signal;
- (c) a buoyant lifeline at least 18 metres in length;
- (d) a lifejacket suitable for a person weighing 32 kilogrammes or more for each person on board;
- (e) a lifejacket suitable for a person weighing less than 32 kilogrammes for each such person on board;
- (f) each lifejacket required to be carried by subparagraphs (d) and (e) must be fitted with a lifejacket light complying with the requirements of Schedule 9, Part 1;
- (g) 6 rocket parachute flares;
- (h) posters or signs showing operating instructions on or in the vicinity of survival craft and their launching controls;
- (i) a training manual;
- (j) instructions for on-board maintenance of life-saving appliances; and
- (k) a copy of the table "Life-Saving Signals for Ships, Aircraft and Persons in distress" published by the Maritime and Coastguard Agency.

7.8.4 Every such ship of 13.7 metres in length or over but less than 21.3 metres in length which does not proceed to sea or which only proceeds to sea during the months of April to October, inclusive on voyages in the course of which it is not more than 3 miles from the coast of the United Kingdom must carry:

- (a) one lifebuoy for each two persons on board; provided that at least two lifebuoys are carried; such ships which operate only in Category A, B or C waters must not be required to carry more than two lifebuoys. One lifebuoy must be fitted with a self-igniting light and self-activating smoke signal;
- (b) a buoyant lifeline at least 18 metres in length;
- (c) a lifejacket suitable for a person weighing 32 kilogrammes or more for each person on board;
- (d) a lifejacket suitable for a person weighing less than 32 kilogrammes for each such person on board;
- (e) each lifejacket required to be carried by subparagraphs (c) and (d) in the case of ships which proceed to sea must be fitted with a lifejacket light complying with the requirements of Schedule 9, Part 1;



- (f) 6 rocket parachute flares; and
- (g) a copy of the table "Life-Saving Signals for Ships, Aircraft and Persons in distress" published by the Maritime and Coastguard Agency.

7.9 Ships of Class VII

- 7.9.1 This section applies to ships of Class VII the keels of which were laid, or which were at a similar stage of construction on or after 1st July 1998 and the ship size is such that one or all of the provision(s) of Part B of Chapter III do not apply to it. In such cases the relevant provision(s) contained in section 7.3 (which apply to ships of Class VIII(A)) must be complied with.

7.10 Ships of Class VII(T)

- 7.10.1 This section applies to ships of Class VII(T) the keels of which were laid, or which were at a similar stage of construction on or after 1st July 1998 and the ship size is such that one or all of the provision(s) of Part B of Chapter III do not apply to it. In such cases the relevant provision(s) contained in section 7.3 (which apply to ships of Class VIII(A)) must be complied with.

7.11 Ships of Class VIII

- 7.11.1 This section applies to ships of Class VIII the keels of which were laid, or which were at a similar stage of construction on or after 1st July 1998 and the ship size is such that one or all of the provision(s) of Part B of Chapter III do not apply to it. In such cases the relevant provision(s) contained in section 7.3 (which apply to ships of Class VIII(A)) must be complied with.

7.12 Ships of Class VIII(T)

- 7.12.1 This section applies to ships of Class VIII(T) the keels of which were laid, or which were at a similar stage of construction on or after 1st July 1998 and the ship size is such that one or all of the provision(s) of Part B of Chapter III do not apply to it. In such cases the relevant provision(s) contained in section 7.3 (which apply to ships of Class VIII(A)) must be complied with.

7.13 Ships of Class IX

- 7.13.1 This section applies to ships of Class IX the keels of which were laid, or which were at a similar stage of construction on or after 1st July 1998 and the ship size is such that one or all of the provision(s) of Part B of Chapter III do not apply to it. In such cases the relevant provision(s) contained in section 7.3 (which apply to ships of Class VIII(A)) must be complied with

General Requirements

7.14 Operating Instructions for Survival Craft and their Launching Controls

- 7.14.1 Posters and signs provided on or in the vicinity of survival craft and their launching controls must:
- (a) illustrate the purpose of controls and the procedures for operating the appliance and give relevant instructions;



- (b) be easily seen under emergency lighting conditions on ships of Class II(A), and of Classes VII, VII(T), VIII, VIII(T), VIII(A), VIII(A)(T) and IX; and
- (c) where applicable, use symbols which are specified in Schedule 16.

7.15 Survival Craft Assembly and Embarkation Arrangements

- 7.15.1 Lifeboats and liferafts for which launching appliances are required must be stowed as close to accommodation and service spaces as possible.
- 7.15.2 Assembly stations must be provided close to the embarkation stations. Each assembly station must have sufficient clear deck space of at least 0.35 square metres per person, to accommodate all persons assigned to assemble at that station. In ships of Class II(A) passenger assembly stations must have ample room for the marshalling and instruction of the passengers and there must be ready access between assembly stations and the embarkation station.
- 7.15.3 Assembly and embarkation stations must be readily accessible from accommodation and work areas.
- 7.15.4 In ships of Class II(A) assembly and embarkation stations must be adequately illuminated by lighting supplied from the emergency source of electrical power required by the Merchant Shipping (Passenger Ship Construction: Ships of Classes I, II and II(A)) Regulations 1998 or the Merchant Shipping (Cargo Ship Construction) Regulations 1997, as appropriate.
- 7.15.5 Alleyways, internal and external stairways and exits giving access to the assembly and embarkation stations must be lighted. In ships of Class II(A) such lighting must be capable of being supplied by the emergency source of electrical power required by the Merchant Shipping (Passenger Ship Construction: Ships of Classes I, II and II(A)) Regulations 1998 or the Merchant Shipping (Cargo Ship Construction) Regulations 1997, as appropriate. In addition to, and as part of the markings required by the Merchant Shipping (Fire Protection: Large Ships) Regulation 1998, routes to assembly stations shall be indicated with the assembly station symbol intended for that purpose; where applicable use symbols which are specified in Schedule 16.
- 7.15.6 Davit-launched and free-fall launched craft assembly and embarkation stations must be so arranged as to enable stretcher cases to be placed in survival craft.
- 7.15.7
 - (a) In ships of Classes II(A), VII, VII(T), VIII, VIII(T), VIII(A), VIII(A)(T), IX, XI and XII an embarkation ladder must be provided at each embarkation station or at every two adjacent embarkation stations, extending, in a single length, from the deck to the waterline in the lightest seagoing condition under unfavourable conditions of trim of up to 10 degrees and with the ship listed not less than 20 degrees either way and where such distance exceeds 1 metre.
 - (b) Such ladders may be replaced by approved devices to afford access to survival craft when waterborne: provided that there must be at least one embarkation ladder on each side of the ship.
 - (c) Handholds must be provided to assist in a safe passage from the deck to the ladder and vice-versa.



(d) Other means of embarkation may be permitted for the liferafts carried in compliance with paragraph 7.3.5 and 7.4.8.

7.15.8 Where necessary, means must be provided for bringing davit-launched survival craft against the ship's side and holding them alongside so that persons can be safely embarked.

7.15.9 On ships of Class II(A) survival craft embarkation arrangements must be so designed that:

(a) all lifeboats can be boarded and launched either directly from the stowed position or from an embarkation deck, but not both; and

(b) davit-launched liferafts can be boarded and launched from a position immediately adjacent to the stowed position or from a position to which, in compliance with the requirements of regulation 7.12.5, the liferaft is transferred prior to launching.

Notwithstanding the requirements of subparagraph 7.11.9(a), if the rescue boat or fast rescue boat is also a lifeboat and the other lifeboats are boarded and launched from an embarkation deck, the arrangements must be such that they can also be boarded and launched from the embarkation deck.

7.15.10 On every ship provided with a rescue boat or fast rescue boat, arrangements must be such that they can be boarded and launched directly from the stowed position with the number of persons assigned to crew the boats on board.

7.15.11 On ships of Classes VII, VII(T), VIII, VIII(T), VIII(A), VIII(A)(T), IX and XI survival craft embarkation arrangements must be so designed that lifeboats can be boarded and launched directly from the stowed position and davit-launched liferafts can be boarded and launched from a position immediately adjacent to the stowed position or from a position to which the liferaft is transferred prior to launching in compliance with the requirements of paragraph 7.12.5.

7.16 Stowage of Survival Craft, Fast Rescue Boats, Marine Evacuation Systems, Means of Rescue, Rescue Boats and Inflated Boats

7.16.1 Each survival craft must be stowed:

(a) so that neither the survival craft nor its stowage arrangements will interfere with the operation of any other survival craft or rescue boat at any other launching station;

(b) as near the water surface as is safe and practicable and, in the case of a survival craft other than a liferaft intended for throw-overboard launching, in such a position that the survival craft in the embarkation position is not less than 2 metres above the waterline with the ship in the fully loaded condition under unfavourable conditions of trim of up to 10 degrees and listed up to 20 degrees either way, or to the angle at which the ship's weatherdeck edge becomes submerged, whichever is less;

(c) in a state of continuous readiness so that two crew members can carry out preparations for embarkation and launching in less than 5 minutes;

(d) fully equipped as prescribed in Schedule 2, or Part 2 or Schedule 4, of Part 6; and

(e) as far as practicable, in a secure and sheltered position and protected from damage by fire and explosion. In particular, survival craft on tankers, other than the liferafts



required by paragraphs 7.3.5 and 7.4.8 must not be stowed on or above a cargo tank, slop tank, or other tank containing explosive or hazardous cargoes.

- 7.16.2 Lifeboats for lowering down the ship's side shall be stowed as far forward of the propeller as practicable. On ships of Classes VII, VII(T), VIII, VIII(T), VIII(A), VIII(A)(T) and IX of 80 metres in length and upwards but less than 120 metres in length, each lifeboat must be so stowed that the after end of the lifeboat is not less than the length of the lifeboat forward of the propeller. On such ships of 120 metres in length and upwards and on ships of Class II(A) of 80 metres in length and upwards, each lifeboat shall be so stowed that the after end of the lifeboat is not less than 1.5 times the length of the lifeboat forward of the propeller. Where appropriate, the ship must be so arranged that lifeboats, in their stowed positions, are protected from damage by heavy seas.
- 7.16.3 Lifeboats must be stowed attached to launching appliances.
- 7.16.4
- (a) Marine evacuation and means of rescue systems must be stowed in a state of continuous readiness for launching in the shortest possible time:
 - (i) so that the ship's side does not have any openings between the embarkation station of the marine evacuation and means of rescue systems and the waterline in the lightest seagoing condition and means must be provided to protect the systems from any projections;
 - (ii) in such positions as to ensure safe launching having particular regard to clearance from the propeller and steeply overhanging portions of the hull and so that, as far as practicable, the system can be launched down the straight side of the ship;
 - (iii) so that neither the passage nor platform nor its stowage or operational arrangements will interfere with the operation of any other life-saving appliance at any other launching station.
 - (b) Where appropriate, the ship must be so arranged that the marine evacuation and means of rescue systems in their stowed positions are protected from damage by heavy seas.
- 7.16.5 Davit-launched liferafts must be stowed within reach of the lifting hooks unless some means of transfer is provided which is not rendered inoperable within the limits of trim and list prescribed in paragraph 7.12.1(b) or by ship motion or power failure: provided that the liferafts required to be carried by paragraph and 7.2.4 need not be so stowed.
- 7.16.6 Canopied reversible liferafts and automatic self-righting liferafts carried on ro-ro passenger ships in accordance with paragraph 7.2.21(b)(iv) do not need to be arranged for easy side-to-side transfer and are therefore not subject to the 185 kilogramme mass limitation of Schedule 4.
- 7.16.7 Liferafts intended for throw-overboard launching must be stowed in a position providing for easy side-to-side transfer at a single open deck level so as to be readily transferable for launching on either side of the ship unless liferafts, of the aggregate capacity required by paragraphs 7.3.4(a), 7.4.4, 7.6.3(c)(i), 7.8.2(a) and 7.9.2(a) to be capable of being launched on either side, are stowed on each side of the ship.
- 7.16.8 On ships of Class II(A) every liferaft must be stowed with its painter permanently attached to the ship and with a float-free arrangement complying with the requirements of



Schedule 4, Part 8 so that, as far as practicable, the liferaft floats free and, if inflatable, inflates automatically when the ship sinks.

- 7.16.9 On ships of Classes VII, VII(T), VIII, VIII(T), VIII(A), VIII(A)(T), IX, XI and XII every liferaft, other than the liferafts required by paragraphs 7.3.5 and 7.4.8 must be stowed with its painter permanently attached to the ship and with a float-free arrangement complying with the requirements of Schedule 4, Part 8 so that the liferaft floats free and if inflatable, inflates automatically when the ship sinks. The liferafts required by paragraphs 7.3.5 and 7.4.8 if securely fastened must have provision for manual release.
- 7.16.10 On all ships operating on fixed routes in shallow water, the requirement that liferafts be arranged as to ensure that the liferafts are not dragged under by the sinking ship can be achieved by using a liferaft painter with a length of at least the maximum depth of the water plus an additional 10 metres.
- 7.16.11 In addition to meeting the requirements of paragraph 7.16.8 or 7.16.9 liferafts must be stowed as to permit manual release of one raft or container at a time from their securing arrangements.
- 7.16.12 Rescue boats and fast rescue boats must be stowed:
- (a) in a state of continuous readiness for launching in not more than 5 minutes;
 - (b) in a position suitable for launching and recovery;
 - (c) so that neither the boat nor its stowage arrangements will interfere with the operation of any survival craft at any other launching station; and
 - (d) if it is also a lifeboat, in compliance with the requirements of this section for the stowage of lifeboats.
- 7.16.13 The stowage height of a survival craft on a passenger ship must take into account the requirements of this section, the assembly, means of escape and evacuation procedures for the ship in accordance with the Merchant Shipping (Fire Protection: Large Ships) Regulations 1998, the size of the ship and the weather conditions likely to be encountered in its area of operation. For a davit launched survival craft, the height of the davit head with the survival craft in the embarkation position, must, as far as practicable, not exceed 15 metres to the waterline when the ship is in its lightest sea going condition.

7.17 Launching Stations

- 7.17.1 Launching stations must be in such positions as to ensure safe launching having particular regard to clearance from the propeller and steeply overhanging portions of the hull with the object of ensuring that so far as practicable survival craft, except survival craft specially designed for free-fall launching, can be launched down the straight side of the ship. If positioned forward survival craft must be stowed abaft the collision bulkhead in a sheltered position.

7.18 Survival Craft Launching Arrangements

- 7.18.1 Launching appliances complying with the requirements of Schedule 6, Parts 1 and 3, must be provided for all liferafts except:
- (a) liferafts which are boarded from a position which is less than 4.5 metres above the waterline in the lightest seagoing condition and which either:



- (i) have a mass of not more than 185 kilogrammes; or
- (ii) are stowed for launching directly from the stowed position under unfavourable conditions of trim of up to 10 degrees and with the ship listed not less than 20 degrees either way;

(b) liferafts having a mass of not more than 185 kilogrammes and which are carried in excess of the survival craft for 200 per cent of the total number of persons on board the ship;

(c) liferafts carried in excess of the survival craft for 200 per cent of the total number of persons on board the ship, are stowed for launching directly from the stowed position under unfavourable conditions of trim of up to 10 degrees and list of up to 20 degrees either way;

(d) liferafts provided for use in conjunction with a marine evacuation system, complying with Schedule 5, Part 1 and stowed for launching directly from the stowed position under unfavourable conditions of trim of up to 10 degrees and list of up to 20 degrees either way.

7.18.2 Each lifeboat must be provided with an appliance complying with the requirement of Schedule 6, which is capable of launching and recovering the lifeboat. In addition, there must be provision for hanging-off the lifeboat to free the release gear for maintenance.

7.18.3 Only one type of release mechanism must be used for similar survival craft carried on board the ship.

7.18.4 On ships of Class II(A) all survival craft required to provide for abandonment by the total number of persons on board must be capable of being launched with their full complement of persons and equipment within a period of 30 minutes from the time the abandon ship signal is given.

7.18.5 On ships of Classes VII, VII(T), VIII, VIII(T), VIII(A), VIII(A)(T), IX and XI, with the exception of the survival craft referred to in subparagraph 7.18.1(a), all survival craft required to provide for abandonment by the total number of persons on board must be capable of being launched with their full complement of persons and equipment within a period of 10 minutes from the time the abandon ship signal is given.

7.18.6 On ships of Classes VII, VII(T), VIII, VIII(T), VIII(A), VIII(A)(T), and IX of 20,000 tones and upwards, lifeboats must be capable of being launched where necessary utilising painters, with the ship making headway at speeds up to 5 knots in calm water.

7.18.7 Preparation and handling of survival craft at any one launching station must not interfere with the prompt preparation and handling of any other survival craft or rescue boat at any other station.

7.18.8 During preparation and launching, each survival craft, its launching appliance, and the area of water into which it is to be launched must be adequately illuminated by lighting supplied from the emergency source of electrical power required by the Merchant Shipping (Passenger Ship Construction: Ships of Classes I, II and II(A)) Regulations 1998 or the Merchant Shipping (Cargo Ship Construction) Regulations 1997, as appropriate.

7.18.9 Means must be available to prevent any overboard discharge of water on to survival craft during abandonment or man overboard operations.



- 7.18.10 If there is a danger of a survival craft being damaged by the ship's stabiliser fins, means must be available, powered by an emergency source of energy, to bring the stabiliser fins inboard. Indicators operated by an emergency source of energy shall be available on the navigating bridge to show the position of the stabiliser fins.

7.19 Marine Evacuation Systems

- 7.19.1 A marine evacuation system or systems complying with the requirements of Schedule 5 may be substituted on ships of Class II(A) for some or all of the liferafts and launching appliances required by paragraphs 7.3.2(b) or 7.3.3(b). The liferafts included in such system or systems, together with any other liferafts served by launching appliances other than the liferafts referred to in paragraphs 7.3.4 must provide the same aggregate capacity as that required by paragraphs 7.3.2(b) or 7.3.3(b), as appropriate.
- 7.19.2 Where marine evacuation systems are provided on a ship, at least all the systems on one side must be subjected to a trial deployment after installation; the remainder of the systems are to be satisfactorily deployed within 12 months of the installation date.
- 7.19.3 Where a marine evacuation system is provided, provision for training the crew in its use must be made which must include the arrangements specified in Schedule 5.

7.20 Fast Rescue Boat and Rescue Boat Embarkation, Launching and Recovery Arrangements

- 7.20.1 The rescue boat embarkation and launching arrangements must be such that the rescue boat can be boarded and launched in the shortest possible time and in any case in not more than 5 minutes.
- 7.20.2 If the rescue boat is one of the ship's survival craft, the embarkation arrangements and launching station must comply with the requirements of sections 7.15 and 7.17.
- 7.20.3 Launching arrangements must comply with the requirements of section 7.18 and rescue boat launching appliances must comply with the requirements of Schedule 6, Parts 1 and 2. All rescue boats must be capable of being launched, where necessary utilising painters, with the ship making headway at speeds up to 5 knots in calm water.
- 7.20.4 Recovery time of the rescue boat must be not more than five minutes in moderate sea conditions when loaded with its full complement of persons and equipment. If the rescue boat is also a lifeboat, this recovery time must be possible when loaded with its lifeboat equipment, and the approved rescue boat complement or 6 persons, whichever is the greater.
- 7.20.5 Rescue boat embarkation and recovery arrangements must allow for safe and efficient handling of a stretcher case. Foul weather recovery strops must be provided for safety if heavy blocks constitute a danger.
- 7.20.6 Fast rescue boat launching and recovery arrangements must comply with the requirements of paragraphs 7.20.2 and 7.20.5 inclusive of this paragraph; in addition the launching and recovery arrangements must comply with the requirements of Schedule 6, Parts 1 and 2.

Stowage and Handling of Life-Saving Appliances

7.21 Stowage of Lifebuoys



- 7.21.1 Lifebuoys must be so distributed as to be readily available on both sides of the ship and as far as practicable on all open decks extending to the ship's side. At least one lifebuoy must be placed in the vicinity of the stern.
- 7.21.2 Lifebuoys must not be permanently secured in any way and must be stowed so as to be capable of being rapidly cast loose.
- 7.21.3 Except as otherwise provided, one lifebuoy on each side of the ship must be fitted with a buoyant lifeline.
- 7.21.4 Except as otherwise provided, lifebuoys with lights and lifebuoys with both lights and smoke signals must be equally distributed on both sides of the ship.

7.22 Stowage of Lifejackets

- 7.22.1 Lifejackets must be so stowed as to be readily accessible and their position must be clearly indicated. Where, due to the particular arrangements of the ship, lifejackets stowed in remote positions may become inaccessible, the number of lifejackets carried elsewhere must be suitably increased.
- 7.22.2 Lifejackets carried for persons on watch must be stowed on the bridge, in the engine control room and at any other manned watch station.
- 7.22.3 Lifejackets providing the additional 5 per cent required on passenger ships of Class II(A) must be stowed in conspicuous places on deck or at assembly stations. On ro-ro ships an extra number of lifejackets must be provided in the vicinity of the assembly stations so that passengers do not have to return to their cabins to collect their lifejackets.
- 7.22.4 Inflatable lifejackets for use in free-fall lifeboats must be stowed adjacent to the lifeboat embarkation position.

7.23 Stowage of Two-Way Radiotelephone Sets

- 7.23.1 The two-way radiotelephone sets carried in accordance with this Notice which are not stowed in survival craft must be kept in a suitable place ready to be moved into survival craft in case of emergency.
- 7.23.2 In ships where there is substantial fore and aft separation between superstructure or deck houses, the two-way radiotelephone sets should not all be located in any one superstructure or deck house.

7.24 Stowage and Packing of Pyrotechnic Distress Signals and Line-Throwing Appliances

- 7.24.1 Pyrotechnic distress signals provided for use on board ship must be stowed on or near the navigating bridge.
- 7.24.2 All pyrotechnic distress signals provided for use on board ships or for use in a lifeboat must be packed in watertight containers which must not be plastic envelopes.
- 7.24.3 In the case of a line-throwing appliance which includes a pistol, the pistol, line and rockets, together with the means of ignition, must be stowed in a container which provides protection from the weather.

7.25 Servicing of Life-Saving Appliances

- 7.25.1 Every inflatable liferaft, inflatable lifejacket, hydrostatic release unit (other than a disposable unit) and marine evacuation system must be serviced at a service station accepted by the Secretary of State, at intervals not exceeding twelve months: provided



that in any case where this is impracticable, such interval may be extended by a period not exceeding five months with the consent of the Secretary of State on application to the Maritime and Coastguard Agency at Spring Place, 105 Commercial Road, Southampton SO15 5EG.

- 7.25.2 Guidance is provided in Marine Guidance Notes 548 (M+F) and 553 (M+F) on servicing of life-saving appliances which are installed on board UK regarding how and when life-saving appliances must be serviced.

Miscellaneous Provisions

7.26 Immersion Suits and Anti-Exposure Suits

- 7.26.1 Immersion suits or anti-exposure suits required to be carried by section 7 of this Notice may be of the insulated or uninsulated type but immersion suits of the insulated type must be carried on ships which make voyages:

- (a) north of latitude 65°N in the Atlantic Ocean;
- (b) north of latitude 55°N in the Pacific Ocean;
- (c) south of latitude 50°S; or
- (d) east of longitude 10°E in the Kattegat and Baltic Sea between 1st December and 30th April, both dates inclusive.

- 7.26.2 Immersion suits or anti-exposure suits required to be carried by section 7 of this Notice may be dispensed with if the ship is constantly engaged on voyages between the parallels of latitude of 20° North and South.

7.27 Manning of Survival Craft

- 7.27.1 This section applies to ships of Class II(A), VII, VII(T), VIII, VIII(T) and ships of Classes IX and XI engaged on international voyages.

- 7.27.2 There must be a sufficient number of crew members to operate the survival craft and launching arrangements required for evacuating the total number of persons on board. The minimum number of deck officers, certified persons and other crew members required to be carried shall be determined in accordance with The Merchant Shipping (Standards of Training, Certification and Watchkeeping) Regulations 2015.

- 7.27.3 A deck officer or certified person must be placed in charge of each lifeboat to be used. In addition, a deck officer or certified person must be nominated to be second-in-command of such lifeboat.

- 7.27.4 A deck officer or certified person must be placed in charge of each liferaft to be used. However, in ships of Class II(A) the person placed in charge may be a crew member practised in the handling and operation of liferafts.

- 7.27.5 The person in charge of a survival craft must have a list of the survival craft crew and that person must ensure that the crew are acquainted with their duties. In lifeboats the second-in-command must also have a list of the lifeboat crew.



- 7.27.6 In ships carrying liferafts served by launching appliances a deck officer or certified person must be assigned to each launching appliance.
- 7.27.7 In ships carrying liferafts not served by launching appliances a deck officer or certified person must be assigned to each launching position.
- 7.27.8 A person capable of operating the engine and carrying out minor adjustments must be assigned to every lifeboat.
- 7.27.9 A person capable of operating a radiotelegraph installation must be assigned to every lifeboat required to carry such equipment.
- 7.27.10 There must be a sufficient number of trained persons on board for assembling and assisting untrained persons.
- 7.27.11 The master must ensure the equitable distribution of persons referred to in paragraphs 7.27.2, 7.27.3, 7.27.4 and 7.27.10 when compiling the muster list referred to in regulation 5(2) of the Merchant Shipping (Musters, Training and Decision Support Systems) Regulations 1999 (SI 1999/2722).

8. Carriage Requirements for Life-Saving Appliances for Passenger Ships of Classes III to VI(A)

- 8.1 The carriage requirements for passenger ships of Classes III to VI(A) are set out in the Merchant Shipping (Life-Saving Appliances For Passenger Ships of III to VI(A)) Regulations 1999 (S.I. 1999/2723). The Merchant Shipping (Musters, Training and Decision Support Systems) Regulations 1999 (S.I. 1999/2722) also apply to these ships (except in relation to ships which operate solely in categorised waters and subject to the particular application provisions in S.I. 1999/2722). Regulation 6 of the Merchant Shipping (Entry into Dangerous Spaces) Regulations (S.I. 1988/1638) is also applicable. The technical performance standards of the life-saving appliances for passenger ships of Classes III to VI(A) are provided in the Schedules to this Notice and references to the Schedules of this Notice are made in the Merchant Shipping (Life-Saving Appliances For Passenger Ships of III to VI(A)) Regulations 1999 with respect to each class of ship.



SCHEDULE 1

GENERAL REQUIREMENTS FOR ALL LIFE-SAVING APPLIANCES

1. Unless expressly provided otherwise, all life-saving appliances must:
 - 1.1 be constructed with proper workmanship and materials;
 - 1.2 not be damaged in stowage in the air temperature range -30°C to +65°C;
 - 1.3 be capable of operating in the sea water temperature range of -1°C to +30°C;
 - 1.4 be rot-proof, corrosion-resistant, and not be unduly affected by seawater, oil or fungal attack;
 - 1.5 be resistant to deterioration from exposure to sunlight;
 - 1.6 be of a highly visible colour on all parts where this will assist detection;
 - 1.7 be fitted with retro-reflective material where it will assist in detection and the dimensions and location of the material must be sufficient for this purpose;
 - 1.8 be capable of satisfactory operation in a sea environment;
 - 1.9 be clearly marked with approval information including the Administration which approved it, and any operational restrictions;
 - 1.10 where applicable, be provided with electrical short circuit protection to prevent damage or injury; and
 - 1.11 life-saving appliances which are subject to deterioration with age must be marked with a means for determining their age or the date by which they must be replaced. Permanent marking with a date of expiry is the preferred method of establishing the period of acceptability. Batteries not marked with an expiry date may be used if they are replaced annually, or in the case of a secondary battery or accumulator, if the condition of the electrolyte can be readily checked.



SCHEDULE 2

LIFEBOATS, RIGID RESCUE BOATS AND FAST RESCUE BOATS

PART 1 - GENERAL

Definitions

1. In this Schedule the following definition applies:

“Length of lifeboat or rigid rescue boat or fast rescue boat” means the length of the boat in metres from the inside of the shell at the top of the stem to the corresponding point at the top of the stern post; in the case of a boat with a square stern the length is measured to the inside of the top of the transom.

General

2. Lifeboats, rigid rescue and fast rescue boats must comply with the requirements of Schedule 1 and, in addition, with the requirements of this Part.

Construction

- 3.1 Boats must be properly constructed and must be of such form and proportions that they have ample stability in a seaway and sufficient freeboard when loaded with their full complement of persons and equipment. Boats must have rigid hulls and must be capable of maintaining positive stability when in an upright position in calm water and loaded with their full complement of persons and equipment and holed in any one location below the waterline, assuming no loss of buoyancy material and no other damage.
- 3.2 Boats must be of sufficient strength to:
 - 3.2.1 enable them to be safely lowered into the water when loaded with their full complement of persons and equipment; and
 - 3.2.2 be capable of being launched and towed when the ship is making headway at a speed of 5 knots in calm water.
- 3.3 Hulls and rigid covers must be fire-retardant or non-combustible.
- 3.4 Seating must be provided on thwarts, benches or fixed chairs which are constructed so as to be capable of supporting:
 - 3.4.1 a static load equivalent to the number of persons each weighing 100 kilogrammes for which spaces are provided in compliance with the requirements of Part 2 paragraph 2.3, Part 5 paragraph 2 or Part 8 paragraph 2.1 as appropriate;
 - 3.4.2 a load of 100 kilogrammes in any single seat location when a lifeboat to be launched by falls is dropped into the water from a height of at least 3 metres; and
 - 3.4.3 a load of 100 kilogrammes in any single seat location when a free-fall lifeboat is launched from a height of at least 1.3 times its free-fall certification height.
- 3.5 Except for free-fall lifeboats, each boat must be of sufficient strength to withstand a load, without residual deflection on removal of that load:
 - 3.5.1 in the case of boats with metal hulls, 1.25 times the total mass of the boat when loaded



- with its full complement of persons and equipment; or
- 3.5.2 in the case of other boats, twice the total mass of the boat when loaded with its full complement of persons and equipment.
- 3.6 Except for free-fall lifeboats, each boat must be of sufficient strength to withstand, when loaded with its full complement of persons and equipment and fitted, where applicable, with skates or fenders:
- 3.6.1 a lateral impact against the ship's side at an impact velocity of at least 3.5 metres per second; and
- 3.6.2 also a drop into the water from a height of at least 3 metres.
- 3.7 Each seating position must be clearly indicated in the boat.
- 3.8 Boats must have a boarding ladder that can be used on either side of the boat to enable persons in the water to board the boat. The lowest step of the ladder must be not less than 0.4 metres below the boat's light waterline and must be weighted if of buoyant material.
- 3.9 The boat must be so arranged that helpless people can be brought on board either from the sea or on stretchers.
- 3.10 Surfaces on which persons might walk must have a non-skid finish.
- 3.11 Boats must have inherent buoyancy or must be fitted with inherently buoyant material, which must not be adversely affected by seawater, oil or oil-products, sufficient to float the boat with all its equipment on board when flooded and open to the sea. Additional inherently buoyant material, equal to 280 newtons of buoyant force per person must be provided for the number of persons the boat is permitted to accommodate. Buoyant material, unless in addition to that required above, must not be installed externally to the hull of the boat.
- 3.12 All lifeboats must be stable and have a positive GM value when loaded with 50 per cent of the number of persons the lifeboat is permitted to accommodate in their normal positions to one side of the centreline.
- 3.13 Under the condition of loading in paragraph 3.12:
- 3.13.1 each lifeboat with side openings near the gunwale must have a freeboard, measured from the waterline to the lowest opening through which the lifeboat may become flooded, of at least 1.5 per cent of the lifeboat's length or 100 millimetres, whichever is the greater; and
- 3.13.2 each lifeboat without side openings near the gunwale must not exceed an angle of heel of 20 degrees and must have a freeboard, measured from the waterline to the lowest opening through which the lifeboat may become flooded, of at least 1.5 per cent of the lifeboat's length or 100 millimetres, whichever is the greater.

Propulsion

- 4.1 Except as permitted by paragraph 3.2 of Part 7 (for rigid rescue boats) every boat must be powered by a compression ignition engine. No engine must be used for any boat if its fuel has a flashpoint of 43°C or less (closed cup-test) and the engine must:
- 4.1.1 be provided with either a manual starting system, or a power starting system with two independent rechargeable energy sources. Any necessary starting aids must also be



provided. The engine starting systems and starting aids must start the engine at an ambient temperature of -15°C within 2 minutes of commencing the start procedure unless, having regard to the particular voyages in which the ship carrying the boat is constantly engaged, a different temperature is appropriate. The starting systems must not be impeded by the engine casing, thwarts or other obstructions;

- 4.1.2 be capable of operating for not less than 5 minutes after starting from cold with the boat out of the water; and
- 4.1.3 be capable of operating when the boat is flooded up to the centreline of the crankshaft;
- 4.2 Unless the propeller is arranged so as to avoid its rotation constituting a danger to people in the water adjacent to it, the drive arrangement between the prime mover and the propeller must be such that the propeller can be brought to rest without stopping the prime mover. Provision must be made for ahead and astern propulsion of the craft.
- 4.3 The exhaust pipe must be so arranged as to prevent water from entering the engine in normal operation and insulated as necessary.
- 4.4 Boats must be designed with due regard to the safety of persons in the water and to the possibility of damage to the propulsion system by floating debris.
- 4.5 The engine, transmission and engine accessories must be enclosed in a fire-retardant casing or other suitable arrangements providing similar protection. Such arrangements must also protect persons from coming into accidental contact with hot or moving parts and protect the engine from exposure to weather and sea. Adequate means must be provided to reduce engine noise. Starter batteries must be provided with casings which form a watertight enclosure around the bottom and sides of the batteries. The battery casings must have tight fitting tops which provide for necessary gas venting.
- 4.6 The engine and accessories must be designed to limit electromagnetic emissions so that engine operation does not interfere with the operation of radio life-saving appliances used in the boat.
- 4.7 Means must be provided for recharging all engine-starting, radio and searchlight batteries. Radio batteries must not be used to provide power for engine starting. Means must be provided for recharging boat batteries from the ship's power supply. The electric power supply connection from the ship to any boat must be at a voltage not exceeding 55 volts direct current or 55 volts root mean square alternating current and must be capable of being disconnected automatically at the embarkation station. Charging current may be supplied by means of a solar battery charger.
- 4.8 Water-resistant instructions for starting and operating the engine must be provided and mounted in a conspicuous place near the engine starting controls.

Fittings

- 5.1 Boats must be provided with at least one drain valve fitted near the lowest point in the hull, which must automatically open to drain water from the hull when the boat is not waterborne and must automatically close to prevent entry of water when the boat is waterborne. Each drain valve must be provided with a cap or plug to close the valve, which must be attached to the boat by a lanyard, a chain, or other suitable means. Drain valves must be readily accessible from inside the boat and their positions must be clearly indicated.
- 5.2 Boats must be provided with a rudder and tiller or other suitable means of steering. When



a wheel or other remote steering mechanism is also provided the tiller or this means must be capable of steering the boat in the case of failure of the steering mechanism. Except where the rudder and the tiller form part of an outboard engine the rudder must be permanently attached to the boat and any tiller must be permanently installed on or linked to the rudder stock. However if the boat has a remote steering mechanism the tiller may be removable and securely stowed near the rudder stock. The steering arrangements must be arranged so as not to be damaged by operation of the release mechanism or the propeller.

- 5.3 Except in the vicinity of the rudder, propeller or outboard engine, suitable handholds must be provided or a buoyant line must be becketed around the outside of the boat, above the waterline and within reach of a person in the water.
- 5.4 Boats which are not self-righting when capsized must have suitable handholds on the underside of the hull to enable persons to cling to the boat. The handholds must be fastened to the boat in such a way that, when subjected to an impact sufficient to cause them to break away from the boat, they break away without damaging the boat.
- 5.5 Every boat to be launched by a fall or falls must be fitted with a release mechanism complying with section 8.
- 5.6 Every lifeboat must be fitted with a device to a secure painter near its bow. The device must be such that the lifeboat does not exhibit unsafe or unstable characteristics when being towed by the ship making headway at speeds up to 5 knots in calm water. Except for free- fall lifeboats, the painter securing device must include a release device to enable the painter to be released from inside the lifeboat, with the ship making headway at speeds up to 5 knots in calm water.
- 5.7 Boats intended for launching down the side of a ship must have skates and fenders as necessary to facilitate launching and prevent damage to the boat.
- 5.8 Unless expressly provided otherwise, every boat must be provided with effective means of bailing or be automatically self-bailing.

Markings

- 6.1 Each lifeboat must be fitted with an identity plate endorsed by the Administration, containing at least the following items:
 - 6.1.1 manufacturer's name and address;
 - 6.1.2 lifeboat model and serial number;
 - 6.1.3 month and year of manufacture;
 - 6.1.4 number of persons the lifeboat is approved to carry; and
 - 6.1.5 the approval information required under Schedule 1 paragraph 1.9.
- 6.2 The certifying organization must provide the lifeboat with a certificate of approval which, in addition to the above items, specifies:
 - 6.2.1 number of certificate of approval;
 - 6.2.2 material of hull construction, in such detail as to ensure that compatibility problems in repair should not occur;



- 6.2.3 total mass fully equipped and fully manned; and
- 6.2.4 statement of approval as to Parts 3, 4, 5, 6, 7, 8, 9 or 10 of Schedule 2.
- 6.3 The name and port of registry of the ship to which the boat belongs must be marked on each side of the boat's bow in block capitals.
- 6.4 Means of identifying the ship to which the boat belongs and the number of the boat must be marked in such a way that they are visible from above.

Instructions and Information

- 7.1 Instructions and information required for inclusion in the training manual and in the instructions for on-board maintenance specified in Schedule 14 must be in a suitable form. Instructions and information must be in English, in a clear and concise form, and must include:
 - 7.1.1 a general description of the boat and its equipment;
 - 7.1.2 the installation arrangements;
 - 7.1.3 operational instructions including use of associated survival equipment;
 - 7.1.4 survival instructions;
 - 7.1.5 emergency repair instructions;
 - 7.1.6 deployment, boarding and launching instructions;
 - 7.1.7 the method of launching from within the boat;
 - 7.1.8 the release from launching appliance;
 - 7.1.9 the on-board maintenance requirements;
 - 7.1.10 the servicing requirements;
 - 7.1.11 the use of engine and accessories; and
 - 7.1.12 the recovery of boat including stowage and securing.

Disengaging Gears

- 8.1 Except in the case of single point suspension a boat disengaging gear must be so arranged that all hooks are released simultaneously on the operation of the control mechanism.
- 8.2 The means of effecting release must be placed near the coxswain's position.
- 8.3 The gear must have two release capabilities:
 - 8.3.1 a normal release capability which will release the boat only when it is waterborne or when there is no load on the hook; and
 - 8.3.2 an on-load release capability which will release the boat with a load on the hook(s). This



release must be so arranged as to release the boat under any condition of loading from no-load with the boat waterborne to a load of 1.1 times the total mass of the boat when loaded with its full complement of persons and equipment. This release must be adequately protected against accidental or premature use. Adequate protection must include special mechanical protection not normally required for offload release, in addition to a danger sign. To prevent an accidental release during recovery of the boat, the mechanical protection interlock should only engage when the release mechanism is properly and completely reset. To prevent a premature on-load release, on-load operation of the release mechanism should require a deliberate and sustained action by the operator. The release mechanism must be so designed that crew members in the lifeboat can clearly observe when the release mechanism is properly and completely reset and ready for lifting. Clear operating instructions should be provided with a suitable worded warning notice;

- 8.3.3 where a single fall and hook system is used for launching a lifeboat or rescue boat in combination with a suitable painter, the requirements of paragraph 8.3 need not be applicable; in such an arrangement a single capability to release the lifeboat or rescue boat, only when it is fully waterborne, will be adequate.
- 8.4 The means of connection between the hook, safety device and the operating lever or release unit must:
 - 8.4.1 be arranged and led so as to ensure the efficient operation of the gear;
 - 8.4.2 wherever necessary be properly cased in for the safety or efficient action of the gear or for the protection of persons from injury; and
 - 8.4.3 where cased in, means must be provided for lubricating this equipment.
- 8.5 The release control must be clearly marked in a colour that contrasts with its surroundings, and a suitably worded instruction plate indicating the method of safe operation of the gear must be provided.
- 8.6 Such parts of the gear as would otherwise be likely to be set fast by rust or corrosion must be made of non-corrodible metal.
- 8.7 The mechanism must be designed with a factor of safety of 6 based on the ultimate strength of the materials used, assuming that the mass of the lifeboat is equally distributed.

PART 2 - LIFEBOATS

General

- 1. Lifeboats must comply with the requirements of Part 1, and in addition must comply with the requirements of this Part.

Construction

- 2.1 The vertical distance between the floor surface and the interior of the enclosure or canopy over 50 per cent of the floor area must be:
 - 2.1.1 not less than 1.3 metres for a lifeboat permitted to accommodate 9 persons or less;
 - 2.1.2 not less than 1.7 metres for a lifeboat permitted to accommodate 24 persons or more; and



- 2.1.3 not less than the distance determined by linear interpolation between 1.3 metres and 1.7 metres for a lifeboat permitted to accommodate between 9 and 24 persons.
- 2.2 No lifeboat must be deemed fit to accommodate more than 150 persons.
- 2.3 The number of persons which a lifeboat must be permitted to accommodate must be equal to the lesser of:
 - 2.3.1 the number of persons having an average mass of 75 kilogrammes, all wearing lifejackets, that can be seated in a normal position without interfering with the means of propulsion or the operation of any of the lifeboat's equipment; or
 - 2.3.2 the number of spaces that can be provided on the seating arrangements in accordance with figure 1. The shapes may be overlapped as shown, provided footrests are fitted and there is sufficient room for legs, and the vertical separation between the upper and lower seats is not less than 350 millimetres.

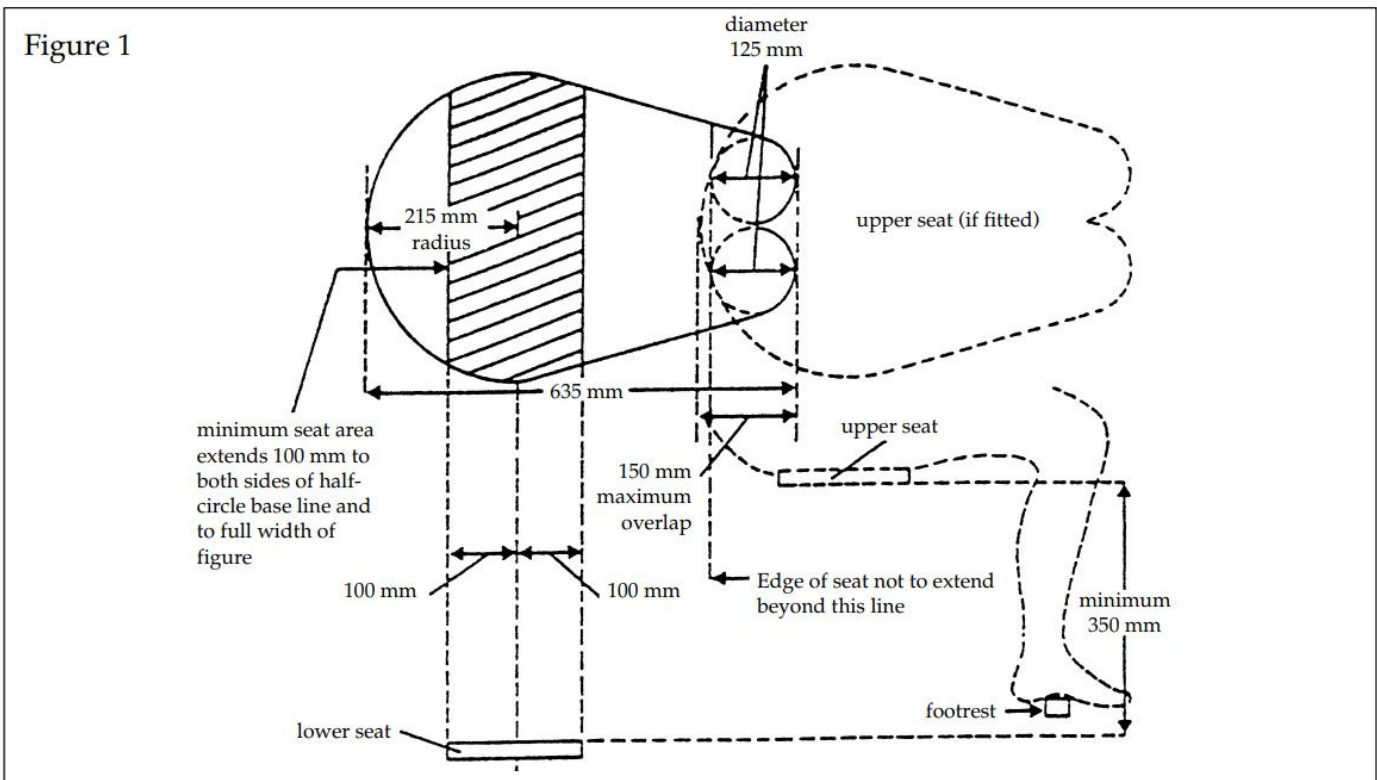

- 2.4 Every passenger ship lifeboat must be so arranged that it can be rapidly boarded by its full complement of persons. Rapid disembarkation must also be possible.
- 2.5 Every cargo ship lifeboat must be so arranged that it can be boarded by its full complement of persons in not more than 3 minutes from the time the instruction to board is given. Rapid disembarkation must also be possible.

Propulsion

- 3.1 Every lifeboat engine must be capable of operating when the lifeboat is listed 10 degrees either way or trimmed 10 degrees either way.
- 3.2 The speed of a lifeboat when proceeding ahead in calm water, when loaded with its full complement of persons and equipment and with all engine-powered auxiliary equipment



in operation, must be at least 6 knots and at least 2 knots when towing a 25-person liferaft loaded with its full complement of persons and equipment or its equivalent. Sufficient fuel, suitable for use in the temperature range expected in the area in which the ship operates, must be provided to run the fully loaded lifeboat at 6 knots for a period of not less than 24 hours.

Fittings

- 4.1 Lifeboats must be fitted with sufficient watertight lockers or compartments to provide for the storage of the small items of equipment, water and provisions required by section 5. Means must be provided for the storage of collected rainwater.
- 4.2 Every lifeboat which is fitted with a fixed, two-way VHF radiotelephone apparatus with an antenna which is separately mounted must be provided with arrangements for siting and securing the antenna effectively in its operating position.
- 4.3 A manually controlled lamp complying with the requirements of section 7 must be fitted to the top of the cover or enclosure.
- 4.4 A lamp or source of light complying with the requirements of section 7 must be fitted inside the lifeboat; however, oil lamps must not be permitted for this purpose.
- 4.5 Every lifeboat must be so arranged that an adequate view forward, aft and to both sides is provided from the control and steering position for safe launching and manoeuvring.

Equipment

- 5.1 All items of lifeboat equipment, whether required by this paragraph or elsewhere in this Schedule, with the exception of boat-hooks which must be kept available for fending off purposes, must be secured within the lifeboat by lashings, storage in lockers or compartments, storage in brackets or similar mounting arrangements or other suitable means. The equipment must be secured in such a manner as not to interfere with any abandonment procedures. All items of lifeboat equipment must be as small and of as little mass as possible and must be packed in a suitable and compact form. Except as stated in paragraph 5.2, the normal equipment of every lifeboat must consist of:
 - 5.1.1 except for free-fall liferafts, sufficient buoyant oars to make headway in calm seas; thole pins, crutches or equivalent arrangements must be provided for each oar provided; thole pins or crutches must be attached to the boat by lanyards or chains;
 - 5.1.2 two boat-hooks;
 - 5.1.3 a buoyant bailer and two buckets;
 - 5.1.4 a survival manual;
 - 5.1.5 an operational compass which is luminous or provided with suitable means of illumination. In a totally enclosed lifeboat the binnacle must be permanently fitted at the steering position; in any other lifeboat, it must be provided with suitable mounting arrangements;
 - 5.1.6 a sea-anchor;
 - 5.1.7 two efficient painters of a length equal to not less than twice the distance from the stowage position of the lifeboat to the waterline in the lightest seagoing condition or 15 metres whichever is the greater. On free-fall lifeboats both painters must be stowed near



the bow ready for use. On other lifeboats, one painter attached to the release device required by paragraph 5.6 of Part 1 must be placed at the forward end of the lifeboat and the other must be stored at or near the bow of the lifeboat ready for use;

- 5.1.8 two hatchets, one at each end of the lifeboat;
- 5.1.9 watertight receptacles complying with the requirements of Schedule 13 and containing a total of 3 litres of fresh water for each person the lifeboat is permitted to accommodate, of which 1 litre per person may be replaced by a de-salting apparatus capable of producing an equal amount of fresh water in 2 days or 2 litres per person may be replaced by a manually powered reverse osmosis desalinator capable of producing an equal amount of fresh water in 2 days;
- 5.1.10 three rustproof graduated drinking vessels, one suitably graduated in millilitres;
- 5.1.11 food rations totalling not less than 10,000 kilojoules for each person the lifeboat is permitted to accommodate; these rations must be kept in airtight packaging and be stowed in a watertight container;
- 5.1.12 four rocket parachute flares;
- 5.1.13 six hand flares;
- 5.1.14 two buoyant smoke signals;
- 5.1.15 one waterproof electric torch suitable for Morse signalling together with one spare set of batteries and one spare bulb in a waterproof container;
- 5.1.16 one daylight signalling mirror with instructions for its use for signalling to ships and aircraft;
- 5.1.17 one copy of the Department of Transport's Rescue Signal Table published by Her Majesty's Stationery Office;
- 5.1.18 one whistle or equivalent sound signal;
- 5.1.19 a first-aid outfit complying with the requirements of Schedule 13;
- 5.1.20 anti-seasickness medicine sufficient for 48 hours and one seasickness bag for each person;
- 5.1.21 a jack-knife to be kept attached to the boat by a lanyard;
- 5.1.22 three tin openers;
- 5.1.23 two buoyant rescue quoits, attached to not less than 30 metres of buoyant line;
- 5.1.24 if the lifeboat is not automatically self-bailing, a manual pump complying with the requirements of section 6;
- 5.1.25 one set of fishing tackle;
- 5.1.26 sufficient tools for minor adjustments to the engine and its accessories;
- 5.1.27 two portable fire extinguishers suitable for extinguishing oil fires;



- 5.1.28 a searchlight with a horizontal and vertical sector of at least 6 degrees and a measured luminous intensity of 2500 candela which can work continuously for not less than 3 hours;
 - 5.1.29 an efficient radar reflector unless a radar transponder is stowed in the lifeboat; and
 - 5.1.30 thermal protective aids sufficient for 10 per cent of the number of persons the lifeboat is permitted to accommodate or two, whichever is the greater.
- 5.2 In the case of ships engaged on voyages solely within the Limited European Area the items specified in paragraphs 5.1.11 and 5.1.25 need not be carried and, in the case of passenger ships of Classes III to VI(A), equipment specified in paragraph 5.1.5, 5.1.16, 5.1.17, 5.1.28, 5.1.29 and 5.1.30 need not be provided.

("Limited European Trading Area" means "an area bounded by a line from a point on the Norwegian coast in latitude 62° North to a point 62° North 02° West; thence to a point 58° North 10° West; thence to a point 54° North 14° West; thence to a point 51° North 14° West; thence to a point 38° 40' North 10° West; thence to Cape St Vincent; but excluding all waters which lie to the northward and eastward of a line between Kalmar on the East coast of Sweden and a point on the West coast of Oland in latitude 56° 40' North and from the southern tip of Oland to Gdansk, except between the dates of 1st May and 30th November when the remaining waters of the Baltic Sea are included.)

Manual Pump

- 6.1 Every lifeboat manual pump must comply with the requirements of this section.
- 6.2 The capacity of the pump when operated at not more than 60 double strokes per minute at 1.2 metres suction head, must be not less than:
 - 6.2.1 30 litres per minute in lifeboats of 7 metres in length or over; or
 - 6.2.2 20 litres per minute in lifeboats of less than 7 metres in length;
- 6.3 In its normal dry state (excluding internal grease or other assistance) the pump must be self-priming when operated at a suction head of not less than 1.2 metres.
- 6.4 All parts of the pump must be of a material unaffected by the corrosive effects of sea water.
- 6.5 The interior of the pump, including valves, must be readily accessible for emergency cleaning and the cover for access must be capable of being easily removed without the use of a spanner or other special tool.
- 6.6 The pump branches must be suitable for use with rubber hose connections of at least 30 millimetres bore. The metal part of the operating handle must be suitably sheathed by material other than wood to ensure that the hands of the operator are protected when the pump is used in extreme cold. The spindle gland must be of the spring-loaded seal ring type.

Internal and External Lights

General

- 7.1.1 Internal and external lights provided in accordance with paragraph 4.3. and 4.4 must have a manually operated switch.
- 7.1.2 Each light must be connected independently to its own power source unless it is operated



from the lifeboat's battery system.

Construction

- 7.2.1 Each complete light unit must be constructed with proper workmanship and materials.
- 7.2.2 It must be capable of withstanding the drop test for a lifeboat.
- 7.2.3 It must be capable of withstanding a drop of 2 metres onto a rigidly mounted steel plate or concrete surface.
- 7.2.4 It must be rot proof, corrosion resistant and not unduly affected by sea-water, oil or fungal growth.
- 7.2.5 It must not deteriorate due to damp or humidity when stowed in or on a lifeboat.
- 7.2.6 Its power source must be proofed against leakage of any chemicals which could damage or cause deterioration of the lifeboat.
- 7.2.7 Its connection between light and power must be suitably protected.
- 7.2.8 Its lamp, lamp holder and lens must be so constructed as to prevent the ingress of water.
- 7.2.9 If an external light is a flashing light, it must not be fitted with a lens or curved reflector to concentrate the beam.

Performance

- 7.3.1 Each light must have an operational endurance of not less than 12 hours.
- 7.3.2 It must not be damaged in stowage in the air temperature range -30°C to $+65^{\circ}\text{C}$.
- 7.3.3 It must operate in a satisfactory manner in a seawater temperature range of -1°C to $+30^{\circ}\text{C}$.
- 7.3.4 Each internal light must be of sufficient luminous intensity to enable survival and equipment instructions to be read.
- 7.3.5 Each external light must be white and be capable of operating continuously with a luminous intensity of not less than 4.3 candela.
- 7.3.6 Each external light must be visible through 360 degrees in a horizontal direction and in all directions of the upper hemisphere.
- 7.3.7 If the external light is a flashing light it must flash at a rate of not less than 50 flashes or more than 70 flashes per minute for the 12 hours operating period with an equivalent effective luminous intensity as required by 7.3.5 above.

Markings

- 7.4.1 The power source, if independent of the lifeboat's battery system, must be marked externally with:
 - 7.4.1.1 the manufacturer's name or trade mark;
 - 7.4.1.2 the type and batch number; and
 - 7.4.1.3 the date of manufacture and expiry.



- 7.4.2 If the power source is a chemical pressurised cell it must be clearly marked with a suitable warning notice.

PART 3 – PARTIALLY ENCLOSED LIFEBOATS

General

- 1.1 Partially enclosed lifeboats must comply with the requirements of Part 1 and 2 and in addition must comply with the requirements of this Part.
- 1.2 Every partially enclosed lifeboat must be provided with effective means of bailing or be automatically self-bailing.

Enclosure

- 2.1 Permanently attached rigid covers must be provided extending over not less than 20 per cent of the length of the lifeboat from the stem and not less than 20 per cent of the length of the lifeboat from the aftermost part of the lifeboat.
- 2.2 The rigid covers must form two shelters. The interior height of the shelters must be sufficient to permit persons easy access to their seats in the bow and stern of the lifeboat.
- 2.3 The rigid covers must be so arranged that they include windows or translucent panels to admit sufficient daylight to the inside of the lifeboat with the openings or canopies closed so as to make artificial light unnecessary.
- 2.4 The rigid covers must have railings to provide a secure handhold for persons moving about the exterior of the lifeboat.
- 2.5 Open parts of the lifeboat must be fitted with a permanently attached foldable canopy so arranged that:
- 2.5.1 it can be easily erected by not more than 2 persons; and
- 2.5.2 it is insulated to protect the occupants against cold by means of not less than two layers of material separated by an air gap or other equally efficient means; means must be provided to prevent accumulation of water in the air gap.
- 2.6 The enclosure formed by the rigid covers and canopy must be so arranged:
- 2.6.1 as to allow launching and recovery operations to be performed without any occupant having to leave the enclosure;
- 2.6.2 that it has entrances at both ends and on each side, provided with efficient adjustable closing arrangements which can be easily and quickly opened and closed from inside or outside so as to permit ventilation but exclude seawater, wind and cold. Means must be provided for holding the entrances securely in the open and in the closed position;
- 2.6.3 that with the canopy erected and all entrances closed sufficient air is admitted for the occupants at all times;
- 2.6.4 that it has means for collecting rainwater;
- 2.6.5 that the exterior of the rigid covers and canopy and the interior of that part of the lifeboat covered by the canopy is of a highly visible colour. The interior of the shelters must be of



a colour which does not cause discomfort to the occupants; and

2.6.6 that it is possible to row the lifeboat.

Communications

3.1 Any radiotelegraph installation or any fixed two-way VHF radiotelephone set required by these Regulations must be installed in a cabin large enough to accommodate both the equipment and the person using it; except that no separate cabin is required if the construction of the lifeboat provides a sheltered space.

PART 4 – TOTALLY ENCLOSED LIFEBOATS

General

1. Totally enclosed lifeboats must comply with the requirements of Parts 1 and 2 of this Schedule and in addition must comply with the requirements of this Part.

Enclosure

2.1 Every totally enclosed lifeboat must be provided with a rigid watertight enclosure which completely encloses the lifeboat.

2.2 The enclosure must be so arranged that:

2.2.1 it provides shelter for the occupants;

2.2.2 access to the lifeboat is provided by hatches which can be closed to make the lifeboat watertight;

2.2.3 except for free-fall lifeboats, hatches are positioned so as to allow launching and recovery operations to be performed without any occupant having to leave the enclosure;

2.2.4 access hatches are capable of being opened and closed from both inside and outside and are equipped with means to hold them securely in open positions;

2.2.5 except for free-fall lifeboats, it is possible to row the lifeboat;

2.2.6 it is capable, when the lifeboat is in the capsized position with the hatches closed and without significant leakage, of supporting the entire mass of the lifeboat, including all equipment, machinery and its full complement of persons;

2.2.7 it includes windows or translucent panels on both sides which admit sufficient daylight to the inside of the lifeboat with the hatches closed to make artificial light unnecessary;

2.2.8 its exterior is of a highly visible colour and its interior of a colour which does not cause discomfort to the occupants;

2.2.9 handrails provide a secure handhold for persons moving about the exterior of the lifeboat and aid embarkation and disembarkation;

2.2.10 persons have access to their seats from an entrance without having to climb over thwarts or other obstructions; and

2.2.11 the occupants are protected from the effects of dangerous sub-atmospheric pressures which might be created by the lifeboat's engine, during operation of the engine with entrances closed, the atmospheric pressure inside the lifeboat must never be above the



outside atmospheric pressure or fall below it by more than 20 millibar.

Capsizing and Re-righting

- 3.1 Except in free-fall lifeboats, a four-point safety belt and head protection must be fitted at each indicated seating position. The safety belt must be designed to hold a person of a mass of 100 kilogrammes securely in place when the lifeboat is in a capsized position. Each set of safety belts for a seat must be of a colour which contrasts with the belts for seats immediately adjacent. Free-fall lifeboats must be fitted with a safety harness at each seat in contrasting colour designed to hold a person with a mass of 100 kilogrammes securely in place during a free-fall launch as well as with the lifeboat in capsized position.
- 3.2 The stability of the lifeboat must be such that it is inherently or automatically self-righting when loaded with its full or partial complement of persons and equipment and all entrances and openings are closed watertight and the persons are secured with safety belts.
- 3.3 The lifeboat must be capable of supporting its full complement of persons and equipment when the lifeboat is in the damaged condition prescribed in paragraph 3.1 of Part 1 and its stability must be such that in the event of capsizing, it will automatically attain a position that will provide an above-water escape for its occupants. When the lifeboat is in the stable flooded condition, the water level inside the lifeboat, measured along the seatback, must not be more than 500 millimetres above the seat pan at any occupant seating position.
- 3.4 The design of all engine exhaust pipes, air ducts and other openings must be such that water is excluded from the engine when the lifeboat capsizes and re-rights.

Propulsion

- 4.1 The engine and transmission must be controlled from the helmsman's position.
- 4.2 The engine installation must be capable of running in any position during capsize and continue to run after the lifeboat returns to the upright or must automatically stop on capsizing and be easily restarted after the lifeboat returns to the upright. The design of the fuel and lubricating systems must prevent the loss of fuel and the loss of more than 250 millilitres of lubricating oil from the engine during capsize.
- 4.3 Air-cooled engines must have a duct system to take in cooling air from, and exhaust it to, the outside of the lifeboat. Manually operated dampers must be provided to enable cooling air to be taken in from, and exhausted to, the interior of the lifeboat.

Construction and Fendering

5. Notwithstanding the requirements of paragraph 3.6 of Part 1, a totally enclosed lifeboat except a free-fall lifeboat must be so constructed and fendered as to ensure that the lifeboat renders protection to its occupants against harmful accelerations when, loaded with its full complement of persons and equipment, it impacts against the ship's side with a velocity of not less than 3.5 metres per second.

PART 5 – LIFEBOATS WITH A SELF-CONTAINED AIR SUPPORT SYSTEM

General

- 1.1 Lifeboats with a self-contained air support system must comply with the requirements of



Parts 1, 2 and 4 and if a free-fall lifeboat, comply with Part 9 and in addition must comply with the requirements of this Part.

- 1.2 Every lifeboat with a self-contained air supply system must be so arranged that, when proceeding with all entrances and openings closed, the air in the lifeboat remains safe and breathable and the engine runs normally for a period of not less than 10 minutes. During this period the atmospheric pressure inside the lifeboat must never fall below the outside atmospheric pressure nor must it exceed it by more than 20 millibar. The system must have visual indicators to indicate the pressure of the air supply at all times.

PART 6 – FIRE-PROTECTED LIFEBOATS

General

- 1.1 Fire-protected lifeboats must comply with the requirements of Parts 1, 2, 4 and 5 and if a free-fall lifeboat, comply with Part 9 and in addition must comply with the requirements of this Part.
- 1.2 Every fire-protected lifeboat when waterborne must be capable of protecting the number of persons it is permitted to accommodate when subjected to a continuous oil fire that envelops the lifeboat for a period of not less than 8 minutes.

Water Spray System

- 2.1 A lifeboat which has a water spray fire-protection system must comply with the following:
 - 2.1.1 water for the system must be drawn from the sea by a self-priming motor pump. It must be possible to turn on and turn off the flow of water over the exterior of the lifeboat;
 - 2.1.2 the seawater intake must be so arranged as to prevent the intake of flammable liquids from the sea surface;
 - 2.1.3 the system must be arranged for flushing with fresh water and allowing complete drainage; and
 - 2.1.4 when an external light is fitted to a fire-protected lifeboat it must be protected by the water-spray system.

PART 7 – RIGID RESCUE BOATS

General

- 1.1 Rigid rescue boats must comply with the requirements of Part 1 and in addition must comply with the requirements of this Part.
- 1.2 A lifeboat may be accepted as a rigid rescue lifeboat provided it also complies with the requirements of this Part and its stowage, launching and recovery arrangements meet all the requirements for a rescue boat.

Construction



- 2.1 The number of persons which a boat must be permitted to accommodate must be equal to the lesser of:
- 2.1.1 the number of persons having an average mass of 75 kilogrammes, all wearing lifejackets, that can be seated in a normal position plus one person lying down on a stretcher without interfering with the means of propulsion or the operation of any of the boat's equipment; or
- 2.1.2 the number of spaces that can be provided on the seating arrangements in accordance with figure 2, plus one person lying down on a stretcher, seating except for the helmsman may be provided on the floor provided that the seating space analysis uses shapes similar to figure 2 but altered to an overall length of 1190 millimetres to provide for extended legs, no part of a seating space must be on the gunwale, transom or on inflated buoyancy at the side of a boat.

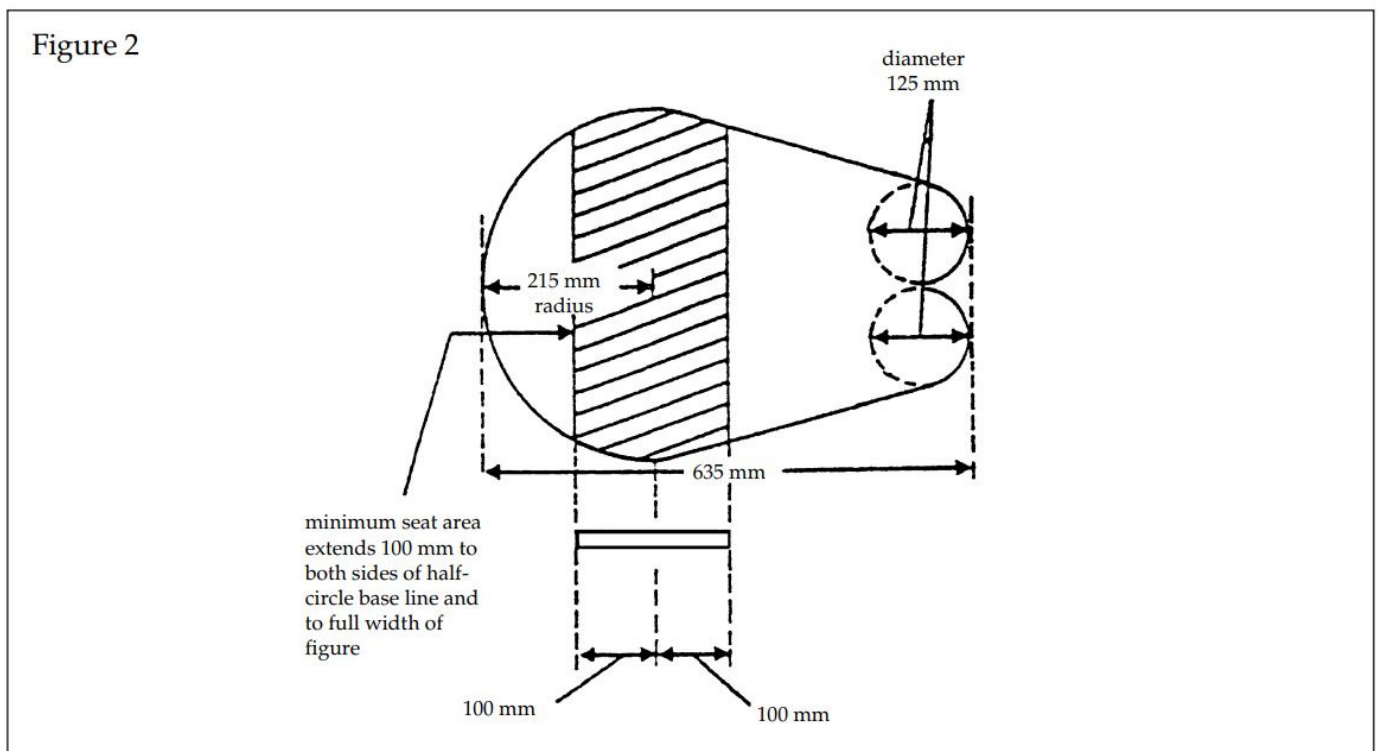

- 2.2 Boats must be:
- 2.2.1 not less than 3.8 metres and not more than 8.5 metres in length; and
- 2.2.2 capable of carrying at least 5 seated persons and a person lying down.
- 2.3 Unless the boat has adequate sheer it must be provided with a bow cover extending for not less than 15 per cent of its length.
- 2.4 Boats must be capable of manoeuvring at speeds of at least 6 knots and maintaining a speed of 6 knots for a period of at least 4 hours.
- 2.5 Boats must have sufficient mobility and manoeuvrability in a seaway to enable persons to be retrieved from the water, marshal liferafts and tow the largest liferaft carried on the ship when loaded with its full complement of persons and equipment or its equivalent at a speed of at least 2 knots.
- 2.6 Boats must be fitted with an inboard or outboard engine complying with the relevant parts



of section 3.

- 2.7 Arrangements for towing must be permanently fitted and must be sufficiently strong to marshal or tow liferafts as required by paragraph 2.5.
- 2.8 Boats must be fitted with weathertight stowage for small items of equipment.
- 2.9 Boats must be fitted with a protective stowage cover and must be kept covered at all times when the boat is not in use. The cover must be arranged for quick removal in an emergency.
- 2.10 Boats must be fitted with a protective stowage cover and must be kept covered at all times when the boat is not in use. The cover must be arranged for quick removal in an emergency.
- 2.11 Unless expressly provided otherwise, every rescue boat must be provided with effective means of bailing or be automatically self-bailing.
- 2.12 Buoyant material for rescue boats may be installed external to the hull, provided it is adequately protected against damage and is capable of withstanding exposure conditions described in Part 8 paragraph 2.6.

Propulsion

- 3.1 Where a boat is powered by an inboard engine it must be of the compression ignition type complying with the requirements of paragraph 4.1 of Part 1.
- 3.2 Outboard engines using petrol or diesel oil as fuel must be fitted with approved fuel systems. Petrol storage tanks must be specially protected against fire and explosion. A starting system, which must not be impeded by the engine casing, thwarts or other obstructions and which may include starting aids, must be fitted and be capable of starting the engine:
 - 3.2.1 at the ambient temperature and, within 2 minutes of commencing the starting procedure, at an ambient temperature of -15°C , by manual means; or
 - 3.2.2 at the ambient temperature by manual means and, within 2 minutes of commencing the starting procedure, by a powered starting system at an ambient temperature of -15°C : except that if the ship on which the boat and its engine are carried, is constantly engaged on voyages where a different temperature is appropriate, that temperature may be substituted for -15°C .

Equipment

- 4.1 All items of rescue boat equipment, with the exception of the boat hook which must be kept available for fending off purposes, must be secured within the boat by lashings, storage in lockers or compartments, storage in brackets or similar mounting arrangements, or other suitable means. The equipment must be secured in such a manner as not to interfere with any launching or recovery procedures. All items of boat equipment must be as small and of little mass as possible and must be packed in suitable and compact form.
- 4.2 The equipment of every boat must consist of:
 - 4.2.1 sufficient buoyant oars or paddles to make headway in calm seas; thole pins, crutches or equivalent arrangements must be provided for each oar; thole pins or crutches must be attached to the boat by lanyards or chains;



- 4.2.2 a buoyant bailer;
- 4.2.3 a binnacle containing an efficient compass which is luminous or provided with suitable means of illumination;
- 4.2.4 a sea-anchor;
- 4.2.5 a painter of sufficient length and strength, attached to the release device complying with the requirements of paragraph 5.6 of Part 1 and placed at the forward end of the boat;
- 4.2.6 one buoyant line, not less than 50 metres in length, of sufficient strength to tow a liferaft as required by paragraph 2.5;
- 4.2.7 one waterproof electric torch suitable for Morse signalling, together with one spare set of batteries and one spare bulb in a waterproof container;
- 4.2.8 one whistle or equivalent sound signal;
- 4.2.9 a first-aid outfit complying with the requirements of Schedule 13;
- 4.2.10 two buoyant rescue quoits, attached to not less than 30 metres of buoyant line with a breaking strain of at least 1.0 kilonewton;
- 4.2.11 a searchlight with a horizontal and vertical sector of at least 6 degrees and a measured luminous intensity of 2500 candela which can work continuously for not less than 3 hours;
- 4.2.12 an efficient radar reflector;
- 4.2.13 thermal protective aids sufficient for 10 per cent of the number of persons the rescue boat is permitted to accommodate, or two, whichever is greater;
- 4.2.14 a boat hook;
- 4.2.15 a bucket;
- 4.2.16 a knife or hatchet;
- 4.2.17 a portable fire extinguisher suitable for extinguishing oil fires; and
- 4.2.18 a manually controlled lamp complying with the requirement of Part 2 Section 6.

In passenger ships of Classes III to VI(A) the equipment specified in paragraphs 4.2.3, 4.2.11, 4.2.12 and 4.2.13 need not be provided.

Access into Boats

- 5.1 Every passenger ship rigid rescue boat must be so arranged that it can be rapidly boarded by its rescue complement of persons. Rapid disembarkation must also be possible.
- 5.2 Every cargo ship rigid rescue boat must be so arranged that it can be boarded by its rescue complement of persons in not more than 3 minutes from the time the instruction is given. Rapid disembarkation must also be possible.

PART 8 – RIGID INFLATED RESCUE BOATS



General

- 1.1 A rigid inflated rescue boat is a composite craft combining a rigid lower hull and inflated tubes fitted at the edge of the lower hull forming a watertight boundary.
- 1.2 Rigid inflated rescue boats must comply with all the requirements of Part 1 with the exception of paragraph 3.11, and with Part 7 with the exception of paragraph 1.2, and in addition with the requirements of this Part.

Construction

- 2.1 The buoyancy of the boat must be a combination of inherent and inflated buoyancy.
- 2.2 The inflated buoyancy tube must be a single tube sub-divided into at least five separate compartments of approximately equal volume.
- 2.3 Boats must have adequate inherent buoyancy or inherently buoyant material together with the inflatable compartments on one side (excluding the forward compartment) when inflated, sufficient to float the boat with all its equipment on board when flooded and open to the sea.
- 2.4 Additional inherent buoyancy equal to 140 newtons of buoyancy force per person must be provided for the number of persons the boat is permitted to accommodate. This additional buoyancy may be installed externally to the rigid hull of the boat provided it is adequately protected against damage and is capable of withstanding exposure conditions described in paragraph 2.6.
- 2.5 Inherently buoyant material must not be adversely affected by seawater, oil or oil products.
- 2.6 Boats must be so constructed as to be capable of withstanding exposure:
- 2.6.1 when stowed on an open deck on a ship at sea;
- 2.6.2 for 30 days afloat in all sea conditions.
- 2.7 The buoyancy tubes forming the boundary of the boat must on inflation provide a volume of not less than 0.17 cubic metres for each person the boat is permitted to accommodate and the diameter of the main buoyancy chamber must be at least 0.43 metres.
- 2.8 Each buoyancy compartment must be fitted with a non-return valve for manual inflation and means for deflation. A safety relief valve must also be fitted to each buoyancy compartment.
- 2.9 The inflated buoyancy tubes must be maintained at all times in a fully inflated condition.

Markings

- 3.1 If any of the markings required by section 6 of Part 1 are marked on the buoyancy tubes, the materials used to mark them must be of a type which is compatible with the boat's coated fabric and approved by the boat manufacturer.

Equipment

- 4.1 In addition to the equipment required by section 4.2 of Part 7 the following items are



required:

- 4.1.1 an efficient manually operated bellows or pump; and
- 4.1.2 a repair kit in a suitable container for repairing punctures to the coated fabric of the buoyancy tubes.

PART 9 – FREE-FALL LIFEBOATS

General

- 1.1 Free-fall lifeboats must comply with the requirements of Part 4 and in addition must comply with the requirements of this Part.

Carrying Capacity of a Free-fall Lifeboat

- 2.1 The carrying capacity of a free-fall lifeboat is the number of persons that can be provided with a seat without interfering with the means of propulsion or the operation of any of the lifeboat's equipment.
- 2.2 The width of the seat must be at least 430 millimetres. Free clearance in front of the backrest must be at least 635 millimetres. The backrest must extend at least 1,000 millimetres above the seatpan.

Performance Requirements

- 3.1 Each free-fall lifeboat must make positive headway immediately after water entry and must not come into contact with the ship after a free-fall launching against a trim of up to 10 degrees and a list of up to 20 degrees either way from the certification height when fully equipped and loaded with:
 - 3.1.1 its full complement of persons;
 - 3.1.2 occupants so as to cause the centre of gravity to be in the most forward position;
 - 3.1.3 occupants so as to cause the centre of gravity to be in the most aft position, and
 - 3.1.4 its operating crew only.
- 3.2 For oil tankers, chemical tankers and gas carriers with a final angle of heel greater than 20 degrees calculated in accordance with the requirements of Part 1, Schedule 6, paragraph 1.2, as applicable, a lifeboat must be capable of being free-fall launched at the final angle of heel and on the base of the final waterline of that calculation.
- 3.3 The required free-fall height must never exceed the free-fall certification height.

Construction

- 4.1 Each free-fall lifeboat must be of sufficient strength to withstand, when loaded with its full complement of persons and equipment, a free-fall launch from a height of at least 1.3 times the free-fall certification height.

Protection Against Harmful Acceleration

- 5.1 Each free-fall lifeboat must be so constructed as to ensure that the lifeboat is capable of



rendering protection resulting from being launched from the height for which it is to be certified in calm water under unfavourable conditions of trim up to 10 degrees and list of up to 20 degrees either way when it is fully equipped and loaded with:

- 5.1.1 its full complement of persons;
- 5.1.2 one half of its full complement of persons distributed so as to cause the centre of gravity to be in the most forward position;
- 5.1.3 one half of its full complement of persons distributed so as to cause the centre of gravity to be in the most aft position; and
- 5.1.4 the operating crew only.

Lifeboat Fittings

- 6.1 Each free-fall lifeboat must be fitted with a release system which must:
 - 6.1.1 have two independent activation systems for the release mechanisms which may only be operated from inside the lifeboat and be marked in a colour that contrasts with its surroundings;
 - 6.1.2 be so arranged as to release the boat under any condition of loading from no load up to at least 200 per cent of the normal load caused by the fully equipped lifeboat when loaded with the number of persons for which it is to be approved;
 - 6.1.3 be adequately protected against accidental or premature use;
 - 6.1.4 be designed to test the release system without launching the lifeboat; and
 - 6.1.5 be designed with a factor of safety of 6 based on the ultimate strength of the materials used.

Certificate of Approval

- 7.1 In addition to the requirements of this Schedule, Part 1, paragraph 6.1 the certificate of approval for a free-fall lifeboat must also state:
 - 7.1.1 free-fall certification height;
 - 7.1.2 required launching ramp length; and
 - 7.1.3 launching ramp angle for the free-fall certification height.

PART 10 – FAST RESCUE BOATS, RIGID AND RIGID INFLATED

General

- 1.1 Except as provided by this Part, all fast rescue boats must comply with the applicable requirements of:
 - 1.1.1 Part 7 – Rigid Rescue Boats; and
 - 1.1.2 Part 8 – Rigid Inflated Rescue Boats; and with the following requirements.
- 1.2 Fast rescue boats must be not less than 6 metres in length and not more than 8 metres.



- 1.3 Fast rescue boats must be capable of manoeuvring, for at least 4 hours, at a speed of at least 20 knots in calm water with a suitably qualified crew of 3 persons and at least 8 knots with a full complement of persons and equipment.
- 1.4 Fast rescue boats must be self-righting or capable of being readily righted by their crew.
- 1.5 Fast rescue boats must be self-bailing or be capable of being rapidly cleared of water.
- 1.6 Fast rescue boats must be steered by a wheel at a helmsman's position remote from the tiller. An emergency steering system providing direct control of the rudder, water jet, or outboard motor must also be provided.
- 1.7 Engines in fast rescue boats must stop automatically or be stopped by the helmsman's emergency release switch should the rescue boat capsize. When the rescue boat has righted, each engine or motor should be capable of being restarted, provided the helmsman's emergency release, if fitted, has been reset. The design of the fuel and lubricating systems must prevent the loss of more than 250 ml of fuel or lubricating oil from the propulsion system should the rescue boat capsize.
- 1.8 Fast rescue boats must, if possible, be equipped with an easily operated fixed single-point suspension arrangement or equivalent.



SCHEDULE 3

INFLATED RESCUE BOATS AND INFLATED BOATS

PART 1 – GENERAL

General

- 1.1 Inflated rescue boats and inflated boats are craft combining a flexible lower hull and inflated tubes fitted at the edge of the lower hull, together with forming a watertight boundary and which rely solely on the buoyancy of the inflated tubes as the inherent buoyancy of the craft.
- 1.2 Inflated rescue boats and inflated boats must comply with the requirements of Schedule 1 and of this Part.

Construction

- 2.1 Boats must be properly constructed and be of such form and proportion that they have ample stability in a seaway and sufficient freeboard when loaded with their full complement of persons and equipment. Boats must be capable of maintaining positive stability in an upright position in calm water when loaded with their full complement of persons and equipment and fully swamped.
- 2.2 Each boat must be of sufficient strength to withstand, when loaded with its full complement of persons and equipment and with, where applicable, skates or fenders in position, a lateral impact against the ship's side at an impact velocity of at least 3.5 metres per second and also a drop into the water from a height of at least 3 metres.
- 2.3 The number of persons which a boat must be permitted to accommodate must be equal to the lesser of:
 - 2.3.1 The number of persons having an average mass of 75 kilogrammes, all wearing lifejackets, that can be seated inboard of the buoyancy tubes in a normal position plus one person lying down without interfering with the means of propulsion or the operation of any of the boat's equipment; or
 - 2.3.2 the number of spaces that can be provided on the seating arrangements in accordance with figure 2 in Part 7 of Schedule 2 plus one person lying down on a stretcher. Seating, except for the helmsman, may be provided on the floor provided that the seating space analysis uses shapes similar to figure 2 in Part 7 but altered to an overall length of 1190 millimetres to provide for extended legs, no part of a seating space must be on the gunwale, transom or on inflated buoyancy at the sides of the boat.
- 2.4 Each seating position must be clearly indicated in the boat.
- 2.5 Boats must have a boarding ladder that can be used on either side of the boat to enable persons in the water to board the boat. The lowest step of the ladder must be weighted and float at a level not less than 0.4 metres below the boat's light waterline.
- 2.6 The boat must be so arranged that helpless people can be brought on board either from the sea or on stretchers.
- 2.7 Surfaces on which persons might walk must have a non-skid finish.



- 2.8 Boats, when loaded with 50 per cent of the number of persons they are permitted to accommodate seated in their normal positions to one side of the centreline, must have a freeboard measured from the waterline to the lowest opening through which the boat may become flooded, of at least 1.5 per cent of the boat's length or 100 millimetres, whichever is the greater.
- 2.9 Boats without adequate sheer, must be provided with a bow cover of highly visible colour extending for not less than 15 per cent of their length and angled upwards to deflect water and spray.
- 2.10 Boats must have sufficient mobility and manoeuvrability in a seaway to enable persons to be retrieved from the water, marshal liferafts and tow the largest liferaft carried on the ship, when loaded with their full complement of persons and equipment, or its equivalent, at a speed of at least 2 knots.
- 2.11 Arrangements for towing must be permanently fitted in boats and must be sufficiently strong to marshal or tow liferafts as required by paragraph 2.10.
- 2.12 Boats must be fitted with weathertight stowage for small items of equipment.
- 2.13 A boat must be so constructed as to be capable of withstanding exposure:
- 2.13.1 when stowed on an open deck on a ship at sea; and
- 2.13.2 for 30 days afloat in all sea conditions.
- 2.14 Buoyancy must be provided by either a single tube subdivided into at least five separate compartments of approximately equal volume or two separate tubes neither exceeding 60 per cent of the total volume. Buoyancy tubes must be so arranged that, in the event of any one of the compartments being damaged, the intact compartments must be able to support, with positive freeboard over the boat's entire periphery, the number of persons which the boat is permitted to accommodate, each having a mass of 75 kilogrammes, and seated in their normal positions under the following conditions:
- 2.14.1 with the forward buoyancy compartment deflated;
- 2.14.2 with the entire buoyancy on one side of the rescue boat deflated; and
- 2.14.3 with the entire buoyancy on one side and the bow compartment deflated.
- 2.15 Buoyancy tubes forming the boundary of the boat must on inflation provide a volume of not less than 0.17 cubic metres for each person the boat is permitted to accommodate and the diameter of the main buoyancy chamber must be at least 0.43 metres.
- 2.16 Each buoyancy compartment must be fitted with a non-return valve for manual inflation and means for deflation. A safety relief valve must also be fitted to each buoyancy compartment which in the case of an inflated boat must be designed to operate at a pressure not exceeding 125 per cent of the designed working pressure of the buoyancy chamber.
- 2.17 When inverted in the water a boat must be capable of being righted by not more than 2 persons.
- 2.18 Rubbing strips must be provided underneath the bottom and on vulnerable places on the outside of the boat.



- 2.19 Where a transom is fitted it must not be inset by more than 20 per cent of the overall length of the boat.
- 2.20 Suitable patches must be provided for securing painters forward and aft and becketed lifelines inside and outside the boat.
- 2.21 Boats must be maintained at all times in a fully inflated condition.
- 2.22 Boats must be fitted with a protective stowage cover and must be kept covered at all times when not in use. The cover must be arranged for quick removal in an emergency.

Propulsion

- 3.1 Unless the propeller is so arranged so as to avoid its rotation constituting a danger to people in the water adjacent to it the drive arrangement between the prime mover and the propeller must be such that the propeller can be brought to rest without stopping the prime mover. Provision must be made for ahead and astern propulsion of the craft.
- 3.2 The exhaust pipe must be so arranged as to prevent water from entering the engine in normal operation.
- 3.3 Boats must be designed with due regard to the safety of persons in the water and to the possibility of damage to the propulsion system by floating debris.
- 3.4 The boat engine and accessories must be designed to limit electromagnetic emissions so that engine operation does not interfere with the operation of radio life-saving appliances used in the boat.
- 3.5 Water-resistant instructions for starting and operating the engine must be provided and mounted in a conspicuous place near the engine starting controls.

Fittings

- 4.1 Boats must be provided with at least one drain valve fitted near the lowest point in the hull, which must automatically open to drain water from the hull when the boat is not waterborne and must automatically close to prevent entry of water when the boat is waterborne. Each drain valve must be provided with a cap or plug to close the valve, which must be readily attached to the boat by a lanyard, chain, or other suitable means. Drain valves must be readily accessible and capable of being closed from inside the boat and their position must be clearly indicated.
- 4.2 Boats which are not self-righting when capsized must have suitable handholds on the underside of the hull to enable persons to cling to the boat. The handholds must be fastened to the boat in such a way that, when subjected to an impact sufficient to cause them to break away from the boat, they break away without damaging the boat.
- 4.3 Every boat to be launched by a fall or falls must be fitted with a release mechanism complying with section 8, Part 1 of Schedule 2 except those which are launched by a single suspension which may have an approved release mechanism which is operable when the boat is waterborne.
- 4.4 Unless expressly provided otherwise, every boat must be provided with effective means of bailing or be automatically self-bailing.



Markings

- 5.1 The dimensions of the boat, the number of persons which it is permitted to accommodate, the maker's serial number, name or trade mark and the date of manufacture must be marked on the boat in clear permanent characters.
- 5.2 The name and port of registry of the ship to which the boat belongs must be marked on each side of the boat's bow in block capitals.
- 5.3 Means of identifying the ship to which the boat belongs and the number of the boat must be marked in such a way that they are visible from above.
- 5.4 All materials used to mark a boat must be of a type which is compatible with the boat's coated fabric and approved by the boat manufacturer.

Equipment

- 6.1 All items of boat equipment, with the exception of the boat-hook which must be kept available for fending off purposes, must be secured within the boat by lashings, storage lockers or compartments, storage in brackets or similar mounting arrangements, or other suitable means. The equipment must be secured in such a manner as not to interfere with any launching or recovery procedures. All items of boat equipment must be as small and of as little mass as possible and must be packed in suitable and compact form.
- 6.2 The equipment of every boat must consist of:
 - 6.2.1 a buoyant bailer;
 - 6.2.2 a sea-anchor;
 - 6.2.3 one buoyant line, not less than 50 metres in length, of sufficient strength to tow a liferaft as required by paragraph 2.10;
 - 6.2.4 one waterproof electric torch suitable for Morse signalling, together with one spare set of batteries and one spare bulb in a waterproof container;
 - 6.2.5 one whistle or equivalent sound signal;
 - 6.2.6 a first-aid outfit complying with the requirements of Schedule 13;
 - 6.2.7 two buoyant rescue quoits, attached to not less than 30 metres of buoyant line with a breaking strain of at least 1.0 kilonewtons;
 - 6.2.8 a buoyant safety knife;
 - 6.2.9 two sponges;
 - 6.2.10 an efficient manually operated bellows or pump;
 - 6.2.11 a puncture repair kit in a suitable container;
 - 6.2.12 a safety boat hook;
 - 6.2.13 a portable fire extinguisher suitable for extinguishing oil fires; and



6.2.14 a manually controlled lamp complying with the requirements of Part 2, Section 7.

Instructions and Information

7.1 Instructions and information required for inclusion in the training manual and in the instructions for on-board maintenance specified in Schedule 14 must be in a form suitable for inclusion in such training manual and instructions for on-board maintenance. Instructions and information must be in English in a clear and concise form and must include, as appropriate, the following:

7.1.1 a general description of the boat and its equipment;

7.1.2 the installation arrangements;

7.1.3 operational instructions including use of associated survival equipment;

7.1.4 survival instructions;

7.1.5 emergency repair instructions;

7.1.6 deployment, boarding and launching instructions;

7.1.7 the method of launching from within the boat;

7.1.8 the release from launching appliance;

7.1.9 on-board maintenance requirements;

7.1.10 servicing requirements;

7.1.11 the use of engine and accessories; and

7.1.12 the recovery of boat including stowage and securing.

PART 2 – INFLATED RESCUE BOAT

General

1.1 Inflated rescue boats must comply with the requirements of Part 1 and in addition with the requirements of this Part.

Construction

2.1 Boats must be of sufficient strength to:

2.1.1 enable them to be safely lowered into the water when loaded with their full complement of persons and equipment; and

2.1.2 be capable of being launched and towed when the ship is making headway at a speed of 5 knots in calm water.

2.2 An inflated rescue boat must be constructed in such a way that, when suspended by its bridle or lifting hook:

2.2.1 it is of sufficient strength and rigidity to enable it to be lowered and recovered with its full



complement of persons and equipment;

- 2.2.2 it is of sufficient strength to withstand a load of 1.1 times the mass of its full complement of persons and equipment at an ambient temperature of -30°C with all relief valves operative; and
- 2.2.3 it is of sufficient strength to withstand a load of 4 times the mass of its full complement of persons and equipment at an ambient temperature of $20\pm 3^{\circ}\text{C}$ with all relief valves inoperative.
- 2.3 Seating must be provided on thwarts, benches or fixed chairs fitted as low as practicable in the boat and constructed so as to be capable of supporting the number of persons each weighing 100 kilogrammes for which spaces are provided in compliance with the requirements of paragraph 2.3.2 of Part 1.
- 2.4 Boats must:
 - 2.4.1 be not less than 3.8 metres and not more than 8.5 metres in length; and
 - 2.4.2 be capable of carrying at least 5 seated persons and a person lying down on a stretcher.
- 2.5 Boats must be capable of manoeuvring at speeds of at least 6 knots and maintaining a speed of 6 knots for a period of at least 4 hours.
- 2.6 Boats must be fitted with an inboard or outboard engine complying with the relevant parts of section 3 below.

Propulsion - Inboard Engine

- 3.1 Where a boat is powered by an inboard engine it must be of the compression ignition type. No engine must be used for any boat if its fuel has a flashpoint of 43°C or less (Closed Cup Test), and the engine must:
 - 3.1.1 be provided with either a manual starting system, or a power starting system with two independent rechargeable energy sources. Any necessary starting aids must also be provided; the engine starting systems and starting aids must start the engine at an ambient temperature of -15°C within 2 minutes of commencing the start procedure unless, having regard to the particular voyages in which the ship carrying the boat is constantly engaged, a different temperature is appropriate; the starting systems must not be impeded by the engine casing, thwarts or other obstructions;
 - 3.1.2 be capable of operating for not less than 5 minutes after starting from cold with the boat out of the water;
 - 3.1.3 be capable of operating when the boat is flooded up to the centreline of the crank shaft.

Propulsion - Outboard Engine

- 3.2 Outboard engines using petrol or diesel oil as fuel must be fitted with approved fuel systems. Petrol storage tanks must be specially protected against fire and explosion. A starting system, which must not be impeded by the engine casing, thwarts or other obstructions and which may include starting aids, must be fitted and be capable of starting the engine:
 - 3.2.1 at the ambient temperature and, within 2 minutes of commencing the starting procedure, at an ambient temperature of -15°C , by manual means; or



- 3.2.2 at the ambient temperature by manual means and, within 2 minutes of commencing the starting procedure, by a powered starting system at an ambient temperature of -15°C : except that if the ship on which the boat and its engine are carried, is constantly engaged on voyages where a different temperature is appropriate, that temperature may be substituted for -15°C .
- 3.3 The boat engine, transmission and engine accessories must be enclosed in a fire-retardant casing or other suitable arrangements providing similar protection. Such arrangements must also protect persons from coming into accidental contact with hot or moving parts and protect the engine from exposure to weather and sea. Adequate means must be provided to reduce the engine noise. Starter batteries must be provided with casings which form a watertight enclosure around the bottom and sides of the batteries. Battery casings must have tight fitting tops which provide for necessary gas venting.
- 3.4 Means must be provided for recharging all engine-starting, searchlight and, when fitted, radio batteries. Radio batteries must not be used to provide power for engine starting. Means must be provided for recharging rescue boat batteries from the ship's power supply. The electric power supply connection from the ship to any inflated rescue boat must be at a voltage not exceeding 55 volts direct current or 55 volts root mean square alternating current and must be capable of being disconnected automatically at the inflated rescue boat embarkation station.

Fittings

- 4.1 Boats must be provided with a rudder and tiller or other suitable means of steering. When a wheel or other remote steering mechanism is also provided the alternative means must be capable of steering the boat in the case of failure of the steering mechanism. Except where the rudder forms part of an outboard engine a rudder must be permanently attached to the boat and a tiller must be permanently installed on or linked to the rudder stock. However, if the boat has a remote steering mechanism the tiller may be removable and securely stowed near the rudder stock. The steering arrangements must be so arranged so not to be damaged by operation of the release mechanism or the propeller.
- 4.2 Except in the vicinity of the rudder and propeller, a buoyant lifeline must be becketed around the inside and outside of the boat.
- 4.3 Every boat must be fitted with a release device to enable the forward painter to be released when under tension.
- 4.4 Boats intended for launching down the side of a ship must have skates and fenders as necessary to facilitate launching and prevent damage to the boat.

Equipment

- 5.1 In addition to the equipment required under Part 1 every inflated rescue boat must be provided with:
- 5.1.1 sufficient buoyant oars or paddles to make headway in calm seas; thole pins, crutches or equivalent arrangements must be provided for each oar; thole pins or crutches must be attached to the boat by lanyards or chains;
- 5.1.2 a binnacle containing an efficient compass which is luminous or provided with suitable means of illumination;
- 5.1.3 a painter of sufficient length and strength, attached to the release device complying with the requirements of paragraph 4.3 and placed at the forward end of the boat;



- 5.1.4 a searchlight with a horizontal and vertical sector of at least 6 degrees and a measured luminous intensity of 2500 candela which can work continuously for 3 hours;
- 5.1.5 an efficient radar reflector;
- 5.1.6 thermal protective aids sufficient for 10 per cent of the number of persons the boat is permitted to accommodate or two whichever is the greater; and
- 5.1.7 a manually controlled lamp complying with the requirements of Part 2, paragraph 7.
- 5.2 Every cargo ship inflated rescue boat must be so arranged that it can be boarded by its rescue complement of persons in not more than 3 minutes from the time the instruction to board is given. Rapid disembarkation must also be possible.

Access into Boats

- 6.1 In every passenger ship the boats must be so arranged that they can be rapidly boarded by their rescue complement of persons. Rapid disembarkation must also be possible.
- 6.2 In every cargo ship the boats must be so arranged that they can be boarded by their rescue complement of persons in not more than 3 minutes from the time the instruction to board is given. Rapid disembarkation must also be possible.

Disengaging Gears

- 7. Disengaging gear for inflated rescue boats must comply with the requirements of section 8, Part 1 of Schedule 2.

PART 3 – INFLATED BOATS (NON-SOLAS)

General

- 1.1 Inflated boats must comply with the requirements of Part 1 and in addition with the requirements of this Part.

Construction

- 2.1 A boat must be constructed in such a way that, when suspended by its bridle or lifting hook:
 - 2.1.1 it is of sufficient strength and rigidity to enable it to be lowered and recovered with all its equipment and a crew of 2 persons;
 - 2.1.2 it is of sufficient strength to withstand a load of 1.1 times the mass of its equipment and a crew of 2 persons at an ambient temperature of -30°C with relief valves operative; and
 - 2.1.3 it is of sufficient strength to withstand a load of 4 times the mass of its equipment and a crew of 2 persons at an ambient temperature of $20\pm 3^{\circ}\text{C}$ with all relief valves inoperative.
- 2.2 Boats must be of sufficient strength to enable them to be safely lowered into the water when loaded with all their equipment and a crew of 2 persons.
- 2.3 At least one portable thwart must be fitted to enable the boat to be rowed satisfactorily.



- 2.4 A boat must:
- 2.4.1 be not less than 3.8 metres and not more than 8.5 metres in length; and
 - 2.4.2 be capable of carrying at least 3 persons and a person lying down on a stretcher.
- 2.5 Boats must be capable of manoeuvring at speeds of at least 6 knots in calm water with 2 persons on board and maintaining a speed of 6 knots for a period of at least 2 hours.
- 2.6 The boat must be fitted with an outboard engine having a maximum power of 10 horsepower complying with the requirements of section 3.

Propulsion

- 3.1 A petrol-driven outboard engine with an approved fuel system may be fitted, provided the tank is specially protected against fire and explosion.
- 3.2 A petrol engine must be provided with a manual starting system. The engine starting system must start the engine at an ambient temperature of -15°C within 2 minutes of commencing the start procedure. The starting system must not be impeded by the engine casing, thwarts or other obstructions.

Fittings

4. Except in the vicinity of an outboard engine, a buoyant lifeline must be becketed around the inside and outside of the boat.

Lifting Arrangements

- 5.1 Bridle slinging arrangements must be fitted to enable the boat to be lowered or raised from the water. The bridle sling must comprise of at least four legs which should be joined at the top in the form of an eye or be connected to a lifting ring or shackle. The arrangement must be such that the boat is stable when suspended and either:
- 5.1.1 the length of the legs are of equal length; or
 - 5.1.2 the bridle is permanently attached; or
 - 5.1.3 it is not possible to connect any of the bridle legs to the wrong position in the boat.
- 5.2 The bridle must be manufactured of a material which will not adversely affect the material of the boat and, if necessary, must be sheathed to prevent abrasion of the fabric.
- 5.3 The forward lifting attachments must be securely fastened to the hull and may be bands passing under the hull to the tops of the buoyancy tubes terminating in "D" rings or eyes to take bridle slings.
- 5.4 The after lifting attachments must be similar to the forward attachments or may be made directly to the transom.
- 5.5 The bridle slinging arrangements used for lowering and recovering the boat must be such that the breaking tensile strength is at least 6 times the sum of the mass of the boat, its full equipment and a crew of 2 persons each having a mass of 75 kilogrammes.



- 5.6 The bridle sling lifting arrangements must be proof tested to not less than 4 times their respective working loads. The proof testing can be carried out either:
- 5.6.1 individually on each item associated with the lifting arrangements; or
 - 5.6.2 on the assembly of a structurally completed boat with its lifting arrangements and particular bridle sling. In each case, fabric webbings and cordages forming part of the lifting arrangements must have a breaking strength of not less than 6 times their respective working loads.

Equipment

6. In addition to the equipment required by Part 1, every inflated boat must be provided with:
- 6.1 at least two buoyant oars or paddles to make headway in calm seas; crutches or equivalent arrangements must be provided for each oar and must be permanently attached to the boat.
 - 6.2 a painter 20 metres in length; and
 - 6.3 thermal protective aids sufficient for 10 per cent of the number of persons the boat is permitted to accommodate or two, whichever is greater.

In boats on passenger ships of Classes III to VI(A) the equipment specified in paragraph 6.3 need not be provided.



SCHEDULE 4

LIFERAFTS

PART 1 – GENERAL

General

- 1.1 Inflatable liferafts and rigid liferafts must comply with the requirements of Schedule 1 and in addition must comply with the requirements of this Part.

Construction

- 2.1 Every liferaft must be so constructed as to be capable of withstanding exposure for 30 days afloat in all sea conditions without such deterioration as would involve any loss of seaworthiness.
- 2.2 The liferaft must be so constructed that when it is dropped into the water in its container from a height of 18 metres, the liferaft and its equipment will operate satisfactorily. If the liferaft is to be stowed at a height of more than 18 metres above the waterline in the lightest seagoing condition, it must be of a type which has been satisfactorily drop-tested from at least that height.
- 2.3 The floating liferaft must be capable of withstanding repeated jumps on to it from a height of at least 4.5 metres above its floor both with and without the canopy erected.
- 2.4 The liferaft and its fittings must be so constructed as to enable it to be towed at a speed of 3 knots in calm water when loaded with its full complement of persons and equipment and with one of its sea-anchors streamed.
- 2.5 The liferaft must have a canopy to protect the occupants from exposure which is automatically set in place when the liferaft is launched and waterborne. The canopy must comply with the following:
- 2.5.1 it must provide insulation against heat and cold by means of either two layers of material separated by an air gap or other equally efficient means; means must be provided to prevent accumulation of water in the air gap;
- 2.5.2 its interior must be of a colour that does not cause discomfort to the occupants;
- 2.5.3 each entrance must be clearly indicated and be provided with efficient adjustable closing arrangements which can be easily and quickly opened from inside and outside the liferaft so as to permit ventilation but exclude seawater, wind and cold; liferafts accommodating more than 8 persons must have at least two diametrically opposite entrances;
- 2.5.4 it must admit sufficient air for the occupants at all times, even with the entrances closed;
- 2.5.5 it must be provided with at least one viewing port if the liferaft is to accommodate less than 25 persons and at least two diametrically opposite viewing ports if it is to accommodate more than 25 persons;
- 2.5.6 it must be provided with means for collecting rain water;
- 2.5.7 it must have sufficient headroom for seated occupants under all parts of the canopy; and
- 2.5.8 it must be provided with means to mount a survival craft radar transponder at a height of at least one metre above the sea.



- 2.6 No liferaft must be approved which has a carrying capacity of less than 6 persons calculated in accordance with the requirements of paragraph 2.5 of Part 2 and of paragraph 2.2 of Part 3: except that in ships of Classes VIII(A), VIII(A)(T) and XI, in ships of Classes VIII and VIII(T) of less than 500 tons, in ships of class IX not being ships of 500 tons or over engaged on an international voyage and in ships of Class XII of 21.3 metres in length or over, the minimum carrying capacity of liferafts may be 4 persons, if the total number of persons on board is less than 5.
- 2.7 Unless the liferaft is to be launched by an approved launching appliance complying with the requirements of Part 3 of Schedule 6 or is not required to be stowed in a position providing for easy side to side transfer, and not required to be portable, the total mass of the liferaft, its container and its equipment must not be more than 185 kilogrammes.

Fittings

- 3.1 Lifelines must be securely becketed around the inside and outside of the liferaft.
- 3.2 The liferaft must be provided with arrangements for adequately siting and securing in the operating position the antenna provided with the portable radio apparatus where this is to be carried.
- 3.3 The liferaft must be fitted with an efficient painter of length not less than 10 metres plus the distance from the stowed position to the waterline in the lightest seagoing condition, or 15 metres whichever is the greater.
- 3.4 The breaking strength of the painter system including its means of attachment to the liferaft except the weak link required by Part 8 must be:
- 3.4.1 7.5 kilonewtons for liferafts accommodating up to 8 persons;
- 3.4.2 10.0 kilonewtons for liferafts accommodating 9 to 25 persons; and
- 3.4.3 15.0 kilonewtons for liferafts accommodating more than 25 persons or have a factor of safety of 3 in association with the requirement of paragraph 2.4 above whichever is the greater.
- 3.5 Entrances not provided with a boarding ramp must have a boarding ladder, the lowest step of which must be weighted and float at a level not less than 0.4 metres below the liferaft's light waterline.
- 3.6 There must be means inside the liferaft to assist persons to pull themselves into the liferaft from the ladder.
- 3.7 The stability of the liferaft when loaded with its full complement of persons and equipment must be such that it can be towed at speeds of up to 3 knots in calm water.
- 3.8 At least one manually controlled lamp complying with the requirements of Part 9 must be fitted outside at the top of the liferaft canopy.
- 3.9 A manually controlled lamp complying with the requirements of Part 9 must be fitted inside the liferaft.
- 3.10 Each inflatable liferaft must be fitted with equipment complying with the relevant requirements of Part 6.



Markings

- 4.1 The liferaft must be marked with the:
 - 4.1.1 maker's name or trade mark;
 - 4.1.2 serial number;
 - 4.1.3 date of manufacture (month and year);
 - 4.1.4 name and place of servicing station where it was last serviced; and
 - 4.1.5 number of persons it is permitted to accommodate over each entrance in characters not less than 100 millimetres in height, of a colour contrasting with that of the liferaft canopy.
- 4.2 Provision must be made for marking each liferaft with the name and port of registry of the ship to which it is to be fitted, in such a form that the ship identification can be changed at any time without opening the container.

Instructions and Information

- 5.1 Instructions and information must be in a form suitable for the training manual and the instructions for on-board maintenance referred to in Schedule 14. Instructions and information must be in English in a clear and concise form and must include, as appropriate:
 - 5.1.1 a general description of the liferaft and its equipment;
 - 5.1.2 the installation arrangements;
 - 5.1.3 operational instructions including use of associated survival equipment;
 - 5.1.4 survival instructions;
 - 5.1.5 emergency repair instructions;
 - 5.1.6 deployment, boarding and launching instructions;
 - 5.1.7 the method of release from within davit launched raft;
 - 5.1.8 the release from launching appliance;
 - 5.1.9 on-board maintenance requirements; and
 - 5.1.10 servicing requirements.

PART 2 – INFLATABLE LIFERAFTS

General

- 1.1 Every inflatable liferaft must comply with the requirements of Part 1 and in addition must comply with the requirements of this Part.



Construction

- 2.1 The main buoyancy chamber must be divided into:
 - 2.1.1 not less than two separate compartments, each inflated through a non-return inflation valve on each compartment;
 - 2.1.2 the buoyancy chambers must be so arranged that in the event of one of the compartments being damaged or failing to inflate, the intact compartment must be able to support, with positive freeboard over the liferaft's entire periphery, the number of persons which the liferaft is permitted to accommodate, each having a mass of 75 kilogrammes, and seated in their normal positions.
- 2.2 The floor of the liferaft must be waterproof and must be capable of being sufficiently insulated against cold either:
 - 2.2.1 by means of one or more compartments which the occupants can inflate, or which inflate automatically and can be deflated and reinflated by the occupants; or
 - 2.2.2 by other equally efficient means not dependent on inflation.
- 2.3 The liferaft must be capable of being inflated by one person. The liferaft must be inflated with a non-toxic gas by an inflation system. Inflation must be completed within 1 minute at an ambient temperature of between 18°C and 20°C and within 3 minutes at an ambient temperature of –30°C. After inflation the liferaft must maintain its form when loaded with its full complement of persons and equipment.
- 2.4 Each inflatable compartment must be capable of withstanding a pressure at least 3 times the working pressure and must be prevented from reaching a pressure exceeding twice the working pressure either by means of relief valves or by a limited gas supply. Means must be provided for connecting the topping-up pump or bellows required by Part 6 so that the working pressure can be maintained.
- 2.5 The number of persons which a liferaft must be permitted to accommodate must be equal to the lesser of:
 - 2.5.1 the greatest whole number obtained by dividing by 0.096 the volume, measured in cubic metres, of the main buoyancy tubes (which for this purpose must include neither the arches nor the thwarts if fitted) when inflated;
 - 2.5.2 the greatest whole number obtained by dividing by 0.372 the inner horizontal cross sectional area of the liferaft, measured in square metres, (which for this purpose may include the thwart or thwarts, if fitted) measured to the innermost edge of the buoyancy tubes; or
 - 2.5.3 the number of persons having an average mass of 75 kilogrammes, all wearing either immersion suits and lifejackets or, in the case of davit-launched liferafts, that can be seated with sufficient comfort and headroom without interfering with the operation of any of the liferaft's equipment.

Fittings

- 3.1 At least one entrance must be fitted with a semi-rigid boarding ramp capable of supporting a person weighing 100 kilogrammes to enable persons to board the liferaft



from the sea. The boarding ramp must be so arranged as to prevent significant deflation of the liferaft if the ramp is damaged. Liferafts accommodating more than 25 persons must have at least two diametrically opposite entrances fitted with semi-rigid boarding ramps. In the case of davit-launched liferafts a boarding ramp must not be fitted at the entrance where bowing lines and embarkation facilities are fitted

- 3.2 The stability of liferafts capable of accommodating 25 persons or less when in the inverted position must be such that they can be righted in a sea-way and in calm water by one person. Liferafts in excess of 25 persons capacity must have righting facilities. The righting position of the liferaft must be suitably marked and have a non-skid surface.
- 3.3 The liferaft must be fitted with water pockets complying with the following requirements:
 - 3.3.1 the cross-sectional area of the pockets must be in the shape of an isosceles triangle with the base of the triangle attached to the underside of the liferaft;
 - 3.3.2 the design must be such that the pockets fill to approximately 60 per cent of capacity within 15 to 25 seconds of deployment;
 - 3.3.3 the pockets must have an aggregate capacity of at least 220 litres for inflatable liferafts up to and including the 10 person size;
 - 3.3.4 the pockets to be fitted on liferafts certified to carry more than 10 persons must have an aggregate capacity of $(20 \times N)$ litres, where N = number of persons the liferaft is certified to carry;
 - 3.3.5 the pockets must be attached on all of their sides to the underside of the liferaft;
 - 3.3.6 the pockets must be distributed symmetrically round the circumference of the liferaft either side of the carbon dioxide bottle with sufficient separation between each pocket to enable air to escape readily; and
 - 3.3.7 the pockets must be of a highly visible colour.

Davit-Launched Inflatable Liferafts

- 4.1 In addition to the above requirements, a liferaft for use with an approved launching appliance complying with Part 3 of Schedule 6 must:
 - 4.1.1 when the liferaft is loaded with its full complement of persons and equipment, be capable of withstanding a lateral impact against the ship's side at an impact velocity of not less than 3.5 metres per second and also a drop into the water from a height of not less than 3 metres without damage that will affect its function;
 - 4.1.2 be provided with means for bringing the liferaft alongside the embarkation deck and holding it securely during embarkation. The distance between the liferaft and the bowing line securing point must be kept to a minimum to restrict movement of the liferaft during boarding; and
 - 4.1.3 when suspended from its lifting hook or bridle, withstand a load of:
 - 4.1.3.1 4 times the mass of its full complement of persons and equipment, at an ambient temperature and a stabilised liferaft temperature of $20 \pm 3^{\circ}\text{C}$ with all relief valves inoperative; and
 - 4.1.3.2 1.1 times the mass of its full complement of persons and equipment at an ambient



temperature and a stabilised liferaft temperature of –30°C with all relief valves operative.

- 4.2 Rigid containers for liferafts to be launched by a launching appliance must be so secured that the container or parts of it are prevented from falling into the sea during inflation and launching of the liferaft.
- 4.3 Every passenger ship davit-launched liferaft must be so arranged that it can be rapidly boarded by its full complement of persons.
- 4.4 Every cargo ship davit-launched, inflated liferaft must be so arranged that it can be boarded by its full complement of persons in not more than 3 minutes from the time the instruction to board is given.

Automatic Self-Righting Inflatable Liferafts

- 5.1 Automatic self-righting inflatable liferafts must comply with the requirements of Part 1 and of this Part except for the requirements of paragraphs 3.2, 4.1, 6.1 and 7.2.
- 5.2 The liferaft with all of its equipment and no persons on board must automatically turn from a capsized position to an upright position on the surface of the water, regardless of whether it inflates in the inverted position underwater or on the surface of the water or capsizes for any reason following inflation.

Canopied Reversible Inflatable Liferafts

- 6.1 Canopied reversible inflatable liferafts must comply with the requirements of Part 1 and of this Part except for the requirements of paragraphs 3.2, 3.3, 4.1, 5.1 and 7.2.
- 6.2 The liferaft must:
 - 6.2.1 be capable of being safely used at all times by untrained persons;
 - 6.2.2 be capable of operating safely whichever way up it is floating. The liferaft must have a canopy on both sides of the main body, if applicable, of the liferaft, which must be set in place when the liferaft is launched and waterborne. Both canopies must meet the requirements of Part 1 paragraphs 2.5, 3.8 and 3.9.
 - 6.2.3 ensure that the equipment required under Part 6 must be readily accessible whichever way up the canopied reversible liferaft is floating, either by use of an equipment container which is accessible from either side, or by duplication of equipment on each side of the liferaft; and
 - 6.2.4 ensure that the fully equipped canopied reversible liferaft with one person of 75 kilogrammes on board, must float in a stable upright position in a seaway.

Containers for Inflatable Liferafts

- 7.1 The liferaft must be packed in a container that is:
 - 7.1.1 so constructed as to withstand conditions encountered at sea;
 - 7.1.2 of sufficient inherent buoyancy, when packed with the liferaft and its equipment, to pull the painter from within and to operate the inflation mechanism should the ship sink; and
 - 7.1.3 as far as practicable watertight, except for drain holes in the container bottom.



- 7.2 The liferaft must be packed in its container in such a way as to ensure, as far as possible, that the waterborne liferaft inflates in an upright position on breaking free from its container.
- 7.3 The container must be marked with the:
- 7.3.1 maker's name or trade mark;
 - 7.3.2 serial number;
 - 7.3.3 number of persons it is permitted to carry;
 - 7.3.4 words "SOLAS 98";
 - 7.3.5 type of emergency pack enclosed;
 - 7.3.6 date when last serviced;
 - 7.3.7 length of painter;
 - 7.3.8 maximum permitted height of stowage above waterline (depending on drop-test height and length of painter); and
 - 7.3.9 launching instructions.

PART 3 – RIGID LIFERAFTS

General

- 1.1 Every rigid liferaft must comply with the requirements of Part 1 and in addition with the requirements of this Part.

Construction

- 2.1 The buoyancy of the liferaft must be provided by approved inherently buoyant material placed as near as possible to the periphery of the liferaft. The buoyant material must be fire retardant or be protected by a fire-retardant covering.
- 2.2 The number of persons which a liferaft must be permitted to accommodate must be equal to the lesser of:
- 2.2.1 the greatest whole number obtained by dividing by 0.096 the volume, measured in cubic metres, of the buoyancy material multiplied by a factor of 1 minus the specific gravity of that material;
 - 2.2.2 the greatest whole number obtained by dividing by 0.372 the horizontal cross-sectional area of the floor of the liferaft, measured in square metres; or
 - 2.2.3 the number of persons having an average mass of 75 kilogrammes, all wearing immersion suits and lifejackets, that can be seated with sufficient comfort and headroom without interfering with the operation of any of the liferaft's equipment.
- 2.3 The floor of the liferaft must prevent the ingress of water and must effectively support the occupants out of the water and insulate them from the cold.



Fittings

- 3.1 At least one entrance must be fitted with a rigid boarding ramp to enable persons to board the liferaft from the sea. In the case of a davit-launched liferaft having more than one entrance, the boarding ramp must not be fitted at the entrance where bowing lines and embarkation facilities are fitted.
- 3.2 Unless the liferaft is capable of operating safely whichever way up it is floating, its strength and stability must be such that it is either self-righting or can be readily righted in a sea-way and in calm water by one person.
- 3.3 The stability of a liferaft when loaded with its full complement of persons and equipment must be such that it can be towed at speeds of up to 3 knots in calm water.

Markings

- 4.1 In addition to the markings required by section 4 of Part 1, rigid liferafts must be marked with the:
 - 4.1.1 name and port of registry of the ship to which it belongs;
 - 4.1.2 words "SOLAS 98";
 - 4.1.3 type of emergency pack enclosed;
 - 4.1.4 length of painter;
 - 4.1.5 date of manufacture (month and year);
 - 4.1.6 maximum permitted height of stowage above waterline (depending on drop-test height and length of painter); and
 - 4.1.7 launching instructions.

Davit-Launched Rigid Liferafts

- 5.1 A rigid liferaft for use with an approved launching appliance complying with Part 3 of Schedule 6 must:
 - 5.1.1 when suspended from its lifting hook or bridle, withstand a load of 4 times the mass of its full complement of persons and equipment;
 - 5.1.2 when the liferaft is loaded with its full complement of persons and equipment, be capable of withstanding a lateral impact against the ship's side at an impact velocity of not less than 3.5 metres per second and also a drop into the water from a height of not less than 3 metres without damage that will affect its function; and
 - 5.1.3 be provided with means for bringing the liferaft alongside the embarkation deck and holding it securely during embarkation. The distance between the liferaft and the bowing line securing point must be kept to a minimum to restrict movement of the liferaft during boarding.
- 5.2 Every passenger ship davit-launched liferaft must be so arranged that it can be rapidly



boarded by its full complement of persons.

- 5.3 Every cargo ship davit-launched liferaft must be so arranged that it can be boarded by its full complement of persons in not more than 3 minutes from the time the instruction to board is given.

Automatic Self-Righting Rigid Liferafts

- 6.1 Automatic self-righting rigid liferafts must comply with the requirements of Part 1 and of this Part, except for the requirements of paragraphs 3.2, 5.1 and 7.1
- 6.2 The liferaft with all of its equipment and no persons on board must automatically turn from a capsized position to an upright position on the surface of the water, regardless of whether it lands in the inverted position or capsizes for any reason following inflation.

Canopied Reversible Rigid Liferafts

- 7.1 Canopied reversible rigid liferafts must comply with the requirements of Part 1 and of this Part except for the requirements of paragraphs 3.2, 5.1 and 6.1.
- 7.2 The liferaft must:
- 7.2.1 be capable of being safely used at all times by untrained persons.
- 7.2.2 be capable of operating safely whichever way up it is floating. The liferaft must have a canopy on both sides of the main body, if applicable, of the liferaft, which must be set in place when the liferaft is launched and waterborne. Both canopies must meet the requirements of Part 1 paragraphs 2.5, 3.8 and 3.9.
- 7.2.3 ensure that the equipment required under Part 6 must be readily accessible whichever way up the canopied reversible liferaft is floating, either by use of an equipment container which is accessible from either side, or by duplication of equipment on each side of the liferaft; and
- 7.2.4 ensure that the fully equipped canopied reversible liferaft with one person of 75 kilogrammes on board, must float in a stable upright position in a seaway.

PART 4 – OPEN REVERSIBLE LIFERAFTS

General

- 1.1 Liferafts must:
- 1.1.1 be constructed with proper workmanship and materials;
- 1.1.2 not be damaged in stowage in the air temperature range of -18°C to $+65^{\circ}\text{C}$;
- 1.1.3 be capable of operating in the air temperature range of -18°C to $+65^{\circ}\text{C}$, and a sea water temperature range of -1°C to $+30^{\circ}\text{C}$;
- 1.1.4 be rot-proof, corrosion-resistant, and not be unduly affected by sea-water, oil or fungal attack; and
- 1.1.5 be stable and maintain their shape when inflated and fully laden.



Construction

- 2.1 The liferaft must be so constructed that when it is dropped into the water in its container from a height of 10 metres, the liferaft and its equipment will operate satisfactorily. If the liferaft is to be stowed at a height of more than 10 metres above the waterline in the lightest seagoing condition, it must be of a type which has been satisfactorily drop-tested from at least that height.
- 2.2 The floating liferaft must be capable of withstanding repeated jumps on to it from a height of at least 4.5 metres.
- 2.3 The liferaft and its fittings must be so constructed as to enable it to be towed at a speed of 3 knots in calm water when loaded with its full complement of persons and equipment, with the sea anchor deployed.
- 2.4 The liferaft when fully inflated must be capable of being boarded from the water whichever way up it inflates.
- 2.5 The main buoyancy chamber must be divided into:
- 2.5.1 not less than two separate compartments, each inflated through a non-return inflation valve on each compartment; and
- 2.5.2 the buoyancy chambers must be so arranged that in the event of one of the compartments being damaged or failing to inflate, the intact compartment must be able to support, with positive freeboard over the liferaft's entire periphery, the number of persons which the liferaft is permitted to accommodate, each having a mass of 75 kilogrammes, and seated in their normal positions.
- 2.6 The floor of the liferaft must be waterproof.
- 2.7 The liferaft must be inflated with a non-toxic gas by an inflation system. Inflation must be completed within 1 minute at an ambient temperature of between 18°C and 20°C and within 3 minutes at an ambient temperature of -18°C. After inflation the liferaft must maintain its form when loaded with its full complement of persons and equipment.
- 2.8 Each inflatable compartment must be capable of withstanding a pressure equal to at least 3 times the working pressure and must be prevented from reaching a pressure exceeding twice the working pressure either by means of relief valves or by a limited gas supply. Means must be provided for fitting the topping-up pump or bellows.
- 2.9 At least 25 per cent of the buoyancy tubes are to be of a highly visible colour. In this respect it will be acceptable if the water pockets required by paragraph 3.5 are manufactured in a highly visible colour.
- 2.10 The number of persons which a liferaft must be permitted to accommodate must be equal to the lesser of:
- 2.10.1 the greatest whole number obtained by dividing by 0.075 the volume, measured in cubic metres, of the main buoyancy tubes (which for this purpose must not include the thwarts if fitted) when inflated;
- 2.10.2 the greatest whole number obtained by dividing by 0.304 the inner horizontal cross-



sectional area of the liferaft, measured in square metres (which for this purpose may include the thwart or thwarts, if fitted) to the innermost edge of the buoyancy tubes; or

2.10.3 the number of persons having an average mass of 75 kilogrammes, all wearing lifejackets, that can be seated inboard of the buoyancy tubes without interfering with the operation of any of the liferaft's equipment.

2.11 No liferaft must be approved with a carrying capacity of less than 4 or greater than 65 persons, calculated or determined in accordance with the requirements of paragraph 2.10.

Fittings

3.1 Lifelines must be securely becketed around the inside and outside of the liferaft.

3.2 The liferaft must be fitted with an efficient painter of a length suitable for automatic inflation on reaching the water. For liferafts accommodating more than 30 persons an additional bowsing-in line is to be fitted.

3.3 The breaking strength of the painter system including its means of attachment to the liferaft except the weak link required by Part 8 must be:

3.3.1 7.5 kilonewtons for liferafts accommodating up to 8 persons;

3.3.2 10.0 kilonewtons for liferafts accommodating 9 to 30 persons; and

3.3.3 15.0 kilonewtons for liferafts accommodating more than 30 persons.

3.4 The liferaft must be fitted with at least the following number of inflated ramps to assist boarding from the sea whichever way up the raft inflates:

3.4.1 one boarding ramp for liferafts accommodating up to 30 persons; or

3.4.2 two boarding ramps for liferafts accommodating more than 30 persons.

3.5 The liferaft must be fitted with water pockets complying with the following requirements:

3.5.1 the cross-sectional area of the pockets must be in the shape of an isosceles triangle with the base of the triangle attached to the buoyancy tubes of the liferaft;

3.5.2 the design must be such that the pockets fill to approximately 60 per cent of capacity within 15 to 25 seconds of deployment;

3.5.3 the pockets must normally have aggregate capacity of between 125 litres and 150 litres for inflatable liferafts up to and including the 10-person size;

3.5.4 the pockets to be fitted to each buoyancy tube and on liferafts certified to carry more than 10 persons must have as far as practicable an aggregate capacity of $(12 \times N)$ litres, where N = number of persons the liferaft is certified to carry;

3.5.5 each pocket on a buoyancy tube should be attached so that when this pocket is in the deployed position it is attached along the full length of its upper edges to, or close to, the lowest point of the lowest buoyancy tube; and

3.5.6 the pockets must be distributed symmetrically round the circumference of the liferaft with sufficient separation between each pocket to enable air to escape readily.



- 3.6 At least one manually controlled lamp complying with the requirements of Part 9 must be fitted on the upper and lower surfaces of the buoyancy tubes.
- 3.7 Suitable automatic drainage arrangements are to be provided on each side of the floor of the liferaft in the following manner:
- 3.7.1 one for liferafts accommodating up to 30 persons; or
- 3.7.2 two for liferafts accommodating more than 30 persons.
- 3.8 The equipment of every liferaft must consist of:
- 3.8.1 one buoyant rescue quoit, attached to not less than 30 metres of buoyant line with a breaking strain of at least 1.0 kiloNewtons;
- 3.8.2 two safety knives of the non-folding type having buoyant handles are to be attached to the liferaft by light lines. They must be stowed in pockets so that, irrespective of the way in which the liferaft inflates, they will be readily available on the top surface or the upper buoyancy tube in a suitable position to enable the painter to be readily cut;
- 3.8.3 one buoyant bailer;
- 3.8.4 two sponges;
- 3.8.5 one sea-anchor permanently attached to the liferaft in such a way as to be readily deployable when the liferaft inflates. The position of the sea anchor should be clearly marked on both buoyancy tubes;
- 3.8.6 two buoyant paddles;
- 3.8.7 one first-aid outfit complying with the requirements of Schedule 13;
- 3.8.8 one whistle or equivalent sound signal;
- 3.8.9 two hand flares;
- 3.8.10 one waterproof electric torch suitable for Morse signalling together with a spare set of batteries and a spare bulb in a waterproof container;
- 3.8.11 one repair outfit for repairing punctures in buoyancy compartments; and
- 3.8.12 one topping-up pump or bellows.
- 3.9 Liferafts equipped in accordance with paragraph 3.8 be marked in block capitals "E PACK".
- 3.10 Where appropriate the equipment must be stowed in a container which, if it is not an integral part of, or permanently attached to the liferaft, must be stowed and secured to the liferaft and be capable of floating in water for at least 30 minutes without damage to its contents. Irrespective of whether the equipment container is an integral part of, or is permanently attached to, this open reversible liferaft, the equipment must be readily accessible irrespective of which way up the open reversible liferaft inflates. The line which secures the equipment container to the liferaft must have a breaking strain of 2 kiloNewtons or a breaking strain of 3:1 based on the mass of the complete equipment pack, whichever is the greater.



Containers for Open Reversible Inflatable Liferafts

- 4.1 The liferaft must be packed in a container that is:
 - 4.1.1 so constructed as to withstand conditions encountered at sea;
 - 4.1.2 of sufficient inherent buoyancy, when packed with the liferaft and its equipment, to pull the painter from within and to operate the inflation mechanism should the ship sink; and
 - 4.1.3 as far as practicable watertight, except for drain holes in the container bottom.
- 4.2 The container must be marked with the:
 - 4.2.1 maker's name or trade mark;
 - 4.2.2 serial number;
 - 4.2.3 number of persons it is permitted to carry;
 - 4.2.4 words "NON-SOLAS REVERSIBLE";
 - 4.2.5 type of emergency pack enclosed;
 - 4.2.6 date when last serviced;
 - 4.2.7 length of painter;
 - 4.2.8 maximum permitted height of stowage above waterline (depending on drop-test height); and
 - 4.2.9 launching instructions.

Markings

- 5.1 The liferaft must be marked with the:
 - 5.1.1 maker's name or trade mark;
 - 5.1.2 serial number;
 - 5.1.3 date of manufacture (month and year);
 - 5.1.4 name and place of service station where it was last serviced; and
 - 5.1.5 number of persons it is permitted to accommodate on the top of each buoyancy tube in characters not less than 100 millimetres in height and of a colour contrasting with that of the tube.

Instructions and Information

- 6.1 Instructions and information must be in a form suitable for the training manual and the instructions for on-board maintenance referred to in Schedule 14. Instructions and information must be in English in a clear and concise form and must include, as appropriate:



- 6.1.1 a general description of the liferaft and its equipment;
- 6.1.2 the installation arrangements;
- 6.1.3 operational instructions including use of associated survival equipment;
- 6.1.4 launching, deployment and boarding instructions; and
- 6.1.5 servicing requirements.

PART 5 – INFLATABLE LIFE RAFTS (NON-SOLAS)

General

- 1.1 Liferafts carried on board ships of Classes IX(A), IX(A)(T) and in ships of Class XII of less than 21.3 metres in length must comply with the requirements of Part 1 and 2 provided that paragraphs 1.2 of Schedule 1, 2.2, 2.5.6, 2.6 and 3.3 of Part 1 and 2.3, 4.1.3.2 and 5.4.4 of Part 2 may be modified as follows:
 - 1.1.1 the drop height of 18 metres referred to in paragraph 2.2 of Part 1 may be 6 metres; if the liferaft is to be stowed at a height of more than 6 metres above the waterline in the lightest seagoing condition, it must be of a type which has been satisfactorily drop-tested from at least that height;
 - 1.1.2 the means for collecting rain referred to in paragraph 2.5.6 of Part 1 need not be provided;
 - 1.1.3 the means for insulating the floor of the liferaft against cold as referred to in paragraph 2.6 of Part 2 need not be provided;
 - 1.1.4 the temperature of -30°C referred to in paragraph 1.2 of Schedule 1, paragraph 2.3 and paragraph 4.1.3.2 of Part 2 may be -18°C ;
 - 1.1.5 the minimum carrying capacity of liferafts required by paragraph 2.6 of Part 1 as 6 persons may be four provided that liferafts which are deemed fit to accommodate less than 6 persons must only be carried on such ships on which the total number of persons on board is less than six;
 - 1.1.6 in determining a minimum length of a painter 10 metres must be substituted for the 15 metres referred to in paragraph 3.3 of Part 1; and
 - 1.1.7 the container must be marked with “DOT(UK) 98” in lieu of the marking required by paragraph 5.4.4 of Part 2.

PART 6 – LIFERAFT EQUIPMENT (SOLAS)

General

- 1.1 Subject to the provisions of paragraph 1.3, 1.5, 1.7 and 1.9 the equipment of every liferaft must consist of:
 - 1.1.1 one buoyant rescue quoit, attached to not less than 30 metres of buoyant line with a breaking strain of at least 1.0 kiloNewton;



- 1.1.2 one safety knife of the non-folding type having a buoyant handle and stowed in a pocket on the upper buoyancy tube near the entrance adjacent to the painter and secured to the liferaft by a light line of sufficient length to enable the painter to be readily cut. In addition, a liferaft which is permitted to accommodate 13 persons or more must be provided with a second safety knife which need not be of the non- folding type. The stowage position of the knives must be highlighted;
- 1.1.3 for a liferaft which is permitted to accommodate not more than 12 persons, one buoyant bailer; for a liferaft which is permitted to accommodate 13 persons or more, two buoyant bailers;
- 1.1.4 two sponges;
- 1.1.5 two sea-anchors, one being spare and the other permanently attached to the liferaft in such a way as to be readily deployable when the liferaft inflates to enable the liferaft to lie oriented to the wind in the most stable manner;
- 1.1.6 two buoyant paddles;
- 1.1.7 three tin openers; and a pair of scissors. Safety knives containing special tin opener blades are satisfactory for this equipment. Scissors must be of the safety type;
- 1.1.8 one first-aid outfit complying with the requirements of Schedule 13;
- 1.1.9 one whistle or equivalent sound signal;
- 1.1.10 four rocket parachute flares;
- 1.1.11 six hand flares;
- 1.1.12 two buoyant smoke signals;
- 1.1.13 one waterproof electric torch suitable for Morse signalling together with a spare set of batteries and a spare bulb in a waterproof container;
- 1.1.14 an efficient radar reflector unless a radar transponder is stowed in the liferaft;
- 1.1.15 one daylight signalling mirror with instructions on its use for signalling to ships and aircraft;
- 1.1.16 one copy of the Department for Transport's Rescue Signal Table published by Her Majesty's Stationery Office;
- 1.1.17 One set of fishing tackle;
- 1.1.18 food ration complying with the requirements of Schedule 13 and totalling not less than 10,000 kilojoules for each person the liferaft is permitted to accommodate; these rations must be stowed in a watertight container;
- 1.1.19 watertight receptacles containing a total of 1.5 litres of fresh water complying with the requirements of Schedule 13 for each person the liferaft is permitted to accommodate, of which 0.5 litres per person may be replaced by a de-salting apparatus capable of producing an equal amount of fresh water in 2 days or 1 litre per person may be replaced by a manually powered reverse osmosis desalinator capable of producing an equal amount of fresh water in 2 days;



- 1.1.20 one rust-proof drinking vessel graduated in millilitres;
- 1.1.21 six doses of anti-seasickness medicine and one seasickness bag for each person the liferaft is permitted to accommodate;
- 1.1.22 instructions printed in English on how to survive;
- 1.1.23 instructions for immediate action; and
- 1.1.24 thermal protective aids sufficient for 10 per cent of the number of persons the liferaft is permitted to accommodate, or two, whichever is the greater.
- 1.2 Liferafts equipped in accordance with paragraph 1.1 must be marked in block capitals "SOLAS A PACK".
- 1.3 Liferafts carried on passenger ships engaged on short international voyages must be provided with the equipment specified in paragraphs 1.1.1 to 1.1.6 inclusive, 1.1.8, 1.1.9, 1.1.13 to 1.1.16 inclusive and 1.1.21 to 1.1.24 inclusive and one half of the equipment specified in paragraphs 1.1.10 to 1.1.12 inclusive.
- 1.4 Liferafts equipped in accordance with paragraph 1.3 must be marked in block capitals "SOLAS B PACK".
- 1.5 Liferafts carried on board ships of Classes IX(A) and IX(A)(T) must be provided with the equipment specified in paragraphs 1.1.1 to 1.1.4 inclusive, 1.1.9, 1.1.13, 1.1.16, 1.1.22 and 1.1.23 and one half of the equipment specified in paragraph 1.1.5.
- 1.6 Liferafts equipped in accordance with paragraph 1.5 must be marked in block capitals "C PACK".
- 1.7 Liferafts carried on board ships of Class XII of less than 21.3 metres in length must be provided with the equipment specified in paragraphs 1.1.1 to 1.1.6 inclusive, 1.1.8, 1.1.9, 1.1.13, 1.1.15, 1.1.16, 1.1.17, 1.1.20 to 1.1.24 inclusive and one half of the equipment specified in paragraphs 1.1.10 to 1.1.12 inclusive together with the following equipment:
 - 1.7.1 one safety tin opener;
 - 1.7.2 one third of the food ration required by paragraph 1.1.18; and
 - 1.7.3 watertight receptacles containing a total of 0.5 litres of fresh water for each person the liferaft is permitted to accommodate.
- 1.8 Liferafts equipped in accordance with paragraph 1.7 must be marked in block capitals "D PACK".
- 1.9 Liferafts carried on board ships of Classes III, IV, V, VI and VI(A) may be provided with equipment specified in paragraphs 1.1.1, 1.1.4, 1.1.6, 1.1.8, 1.1.9 and 1.1.13 and two of the safety knives specified in 1.1.2, two buoyant bailers specified in 1.1.3 one sea anchor specified in 1.1.5 and two hand flares specified in 1.1.11.
- 1.10 Where appropriate the equipment must be stowed in a container which, if it is not an integral part of, or permanently attached to, the liferaft, must be stowed and secured inside the liferaft and be capable of floating in water for at least 30 minutes without damage to its contents. The line which secures the equipment container to the liferaft must have a breaking strain of 2 kiloNewtons or a breaking strain of 3:1 based on the mass of the complete equipment pack, whichever is the greater.



- 1.11 In addition to the above requirements every inflatable liferaft must be provided with –
 - 1.11.1 one repair outfit for repairing punctures in buoyancy compartments; and
 - 1.11.2 one topping-up pump or bellows.

PART 7 – AUTOMATIC RELEASE HOOKS

Definitions

- 1.1 In this Part the following definitions apply:
 - 1.1.1 “actuating force” means the force required to set the actuating mechanism;
 - 1.1.2 “actuating mechanism” means the mechanism which, when operated, allows the liferaft to be released automatically;
 - 1.1.3 “automatic release mechanism” means the mechanism which opens the hook automatically to release the liferaft; and
 - 1.1.4 “hook” means a hook to be used for the launching of liferafts which can be activated to automatically release the liferaft when it is waterborne.

Functional Criteria

- 2.1 The hook must be reliable and easily handled by one person during the preparation embarkation, launching and release of the liferaft.
- 2.2 The hook and its accessories must be made of materials suitable for use in the marine environment.
- 2.3 A minimum factor of safety of 6 based on the ultimate strength of the materials used must be applied to the design of all parts of the hook.
- 2.4 The lever for manual release and the actuating mechanism may be separate.
- 2.5 There must be a clear and durable indicator to show if the actuating mechanism has been operated. The automatic release mechanism must be such that positions between “safe” and “cocked” are not possible.
- 2.6 When the hook is in the automatic release position the liferaft must be released as soon as it is waterborne. The release must be immediate and complete. Means must be provided to ensure that the hook does not open when the liferaft swings, bumps into the ship’s side or is otherwise influenced by the wind during the lowering operation.
- 2.7 The hook must be capable of release manually after launching. The manual release mechanism must be designed having regard to the risk of unintentional release during the preparation, embarkation and lowering of the liferaft.
- 2.8 The release hook must include a capability to release the hook under load. The on-load release control must:
 - 2.8.1 be clearly differentiated from the control which activates the automatic release function;



- 2.8.2 require at least two separate actions to operate;
- 2.8.3 with a load of 150 kilogrammes on the hook, require a force of at least 600 and not more than 700 Newtons to release the load, or provide equivalent adequate protection against inadvertent release of the hook; and
- 2.8.4 be designed such that the crew members on deck can clearly observe when the release mechanism is properly and completely set.

Compatibility

- 3.1 The operation of automatic release hooks must be compatible with the type, size and manufacture of the inflatable liferafts carried, and this must be established by operational tests before a particular combination of release hook and liferaft is acceptable.

Instructions and Information

- 4.1 Instructions and information must be in a form suitable for the training manual and the instructions for on-board maintenance referred to in Schedule 14. Instructions and information must be in English in a clear and concise form and must include a description of the operation and maintenance of the automatic release hook.

PART 8 – FLOAT FREE ARRANGEMENTS

General

- 1.1 Float free arrangements must provide for a liferaft to be released automatically in the event of a ship sinking.

Painter System

- 2.1 The liferaft painter system must provide a connection between the ship and the liferaft and must be so arranged as to ensure that the liferaft when released, and in the case of an inflatable liferaft when inflated, is not dragged under by the sinking ship.

Hydrostatic Release Unit Construction

- 3.1 A hydrostatic release unit used in the float-free arrangements must be so constructed that:
 - 3.1.1 the materials used are compatible and do not cause the unit to malfunction. No part of the release unit must be galvanised or treated by other forms of metallic coating;
 - 3.1.2 there is adequate drainage to prevent the accumulation of water in the hydrostatic chamber when the unit is in its normal position;
 - 3.1.3 each part connected to the painter system has a strength not less than that required by the painter; and
 - 3.1.4 it can readily be removed for replacement or annual servicing.

Materials and Components

- 3.2 Materials and components must be corrosion-resistant and not affected by seawater, oil or detergents.



Performance

- 3.3 A hydrostatic release unit must:
 - 3.3.1 function properly in the air temperature range of -30°C to $+65^{\circ}\text{C}$;
 - 3.3.2 function properly in a seawater temperature range of -1°C to $+30^{\circ}\text{C}$;
 - 3.3.3 automatically release the liferaft at a depth of not more than 4 metres;
 - 3.3.4 not release prematurely when seas wash over the unit; and
 - 3.3.5 be capable of releasing a liferaft when the stowage is:
 - 3.3.5.1 horizontal;
 - 3.3.5.2 tilted 45 degrees and 100 degrees with the hydrostatic release unit at the upper side;
 - 3.3.5.3 tilted 45 degrees and 100 degrees with the hydrostatic release unit at the lower side; or
 - 3.3.5.4 vertical.

Marking

- 3.4 A hydrostatic release unit must be marked permanently on its exterior to identify its type and serial number and depth at which it will release the liferaft. In addition, if it is of a type which:
 - 3.4.1 requires servicing, it must be marked with its date of manufacture and provided with a plate permanently attached to the unit for recording the date of servicing; and
 - 3.4.2 is disposable, with the date at which it must be replaced.

Instructions and Information

- 3.5 Instructions and information must be in a form suitable for the training manual and the instructions for on-board maintenance referred to in Schedule 14. Instructions and information must be in English in a clear and concise form and must include:
 - 3.5.1 a general description of the unit;
 - 3.5.2 installation instructions;
 - 3.5.3 any on-board maintenance requirements; and
 - 3.5.4 servicing requirements.

Weak Link

Construction and Materials

- 4.1 The weak link used in the float-free arrangements must:
 - 4.1.1 be made from material which is corrosion resistant and not affected by seawater, oil or detergent;
 - 4.1.2 when made of cordage, have the ends either whipped or heat treated; and



- 4.1.3 when made from flexible wire, have each end looped around a thimble and secured with a locking ferrule.

Performance

- 4.2 The weak link must be of sufficient strength to:
- 4.2.1 pull the painter out of the liferaft container;
 - 4.2.2 operate the liferaft inflation system; and
 - 4.2.3 break under a tensile force of between 1.8 and 2.6 kiloNewtons.

PART 9 – LIFERAFT LIGHTS

General

- 1.1 The lights must be manually controlled but, in the case of an inflatable liferaft, operate automatically when the liferaft inflates and, in the case of a rigid liferaft, when the canopy is set in place.
- 1.2 Each light must be connected independently to its own power source.
- 1.3 The external light may be of a flashing type.

Construction

- 2.1 The complete light unit must be constructed with proper workmanship and materials.
- 2.2 It must be capable of withstanding the drop-test on a liferaft without damage to the light or the liferaft.
- 2.3 It must be capable of withstanding a drop of 2 metres on to a rigidly mounted steel plate or concrete surface.
- 2.4 It must be rot-proof, corrosion-resistant, and not be unduly affected by seawater, oil or fungal growth.
- 2.5 It must not deteriorate due to damp or humidity when stowed with a liferaft in its container.
- 2.6 The power source must be a sea activated or dry chemical cell battery.
- 2.7 The power source must be proofed against leakage of any chemicals which could damage or cause deterioration of any fabrics used in the construction of the liferaft.
- 2.8 The connection between light and power source must be suitably protected.
- 2.9 The power source, in the inactive condition with the terminals covered, must be capable of being immersed for 30 days in salt water without deterioration or loss of power.
- 2.10 The lamp holder and lens must be so constructed as to prevent the ingress of water.
- 2.11 A flashing light must not be fitted with a lens or curved reflector to concentrate the beam.

Performance



- 3.1 The lights must have an operational endurance of not less than 12 hours.
- 3.2 They must not be damaged in storage and must operate in a satisfactory manner in the air temperature range -30°C to $+65^{\circ}\text{C}$.
- 3.3 They must operate in a satisfactory manner in a seawater temperature range of -1°C to $+30^{\circ}\text{C}$.
- 3.4 They must have a shelf life of not less than 3 years.
- 3.5 Internal lights must be of sufficient luminous intensity to enable survival and equipment instructions to be read.
- 3.6 External lights must be white with a luminous intensity of not less than 4.3 candela in all directions of the upper hemisphere.
- 3.7 It must be visible through 360 degrees in a horizontal direction and, when attached to a liferaft, over as great a segment of the upper hemisphere as is practical.
- 3.8 In the case of a flashing light it must flash at a rate of not less than 50 and not more than 70 flashes per minute for the 12 hour operating period with an equivalent effective luminous intensity required by paragraph 3.6.

Markings

- 4.1 The power source must be marked externally with the:
 - 4.1.1 manufacturer's name or trade mark;
 - 4.1.2 type and batch number; and
 - 4.1.3 date of manufacture and expiry.
- 4.2 If the power source is a chemical pressurised cell it must be clearly marked with a suitable warning notice.



SCHEDULE 5

MARINE ESCAPE SYSTEMS AND MEANS OF RESCUE SYSTEM

PART 1 - MARINE EVACUATION SYSTEM

General

- 1.1 A marine escape system must provide a complete evacuation system for survivors, consisting of an inflatable escape chute, an inflatable floating boarding platform and a specified number of inflatable liferafts.
- 1.1.1 The passage of the marine evacuation system must provide for safe descent of persons of various ages, sizes and physical capabilities wearing approved lifejackets from the embarkation station to the floating platform or survival craft.
- 1.2 The system must comply with the requirements of Schedule 1 wherever applicable.
- 1.3 The system must be:
 - 1.3.1 sited clear of propellers and stabilisers;
 - 1.3.2 capable of removal for annual servicing;
 - 1.3.3 fitted with float free facilities complying with the requirements of Part 8 of Schedule 4 on those parts of the system intended for use as inflatable survival equipment;
 - 1.3.4 rapidly deployed by a single action using a gas inflation arrangement;
 - 1.3.5 provided with at least 50 per cent more gas than that required to inflate the system so that any loss of pressure sustained during a deployment can rapidly be replenished;
 - 1.3.6 provided, if the inflation system includes air aspiration, with the means of protecting the aspirator from damage and the ingress of water;
 - 1.3.7 capable of satisfactory operation in a sea-way; and
 - 1.3.8 capable of deployment by one person.

Construction

- 2.1 The container housing the escape chute and the boarding platform must be:
 - 2.1.1 strong enough to withstand the forces imposed upon it in severe weather conditions when the chute and platform is fully deployed and the maximum agreed number of fully loaded inflatable liferafts are attached to the platform. If the system is deployed using a support boom, then both the boom and the container must be strong enough to safely withstand a load which is twice that imposed by the above conditions, without causing damage or distortion to either the boom or the container;
 - 2.1.2 suitably constructed on the outboard side to resist damage and to prevent ingress of water;
 - 2.1.3 suitably protected on the inboard side to prevent damage or accidental deployment by unauthorised personnel;



- 2.1.4 prominently labelled on the inboard side with clear deployment instructions;
- 2.1.5 large enough to house the gas inflation system;
- 2.1.6 provided with quick release of the outer door by a secure single-action arrangement;
- 2.1.7 designed so that deployment of the system over the side will also activate the inflation arrangements;
- 2.1.8 provided with a safe access to the top of the chute for those evacuating the ship;
- 2.1.9 provided with a secure, manual release arrangement for the chute so that it can be jettisoned for additional buoyant support;
- 2.1.10 fitted on board with portable securing arrangements so that it can be removed for annual servicing; and
- 2.1.11 be provided with adequate drainage arrangements.
- 2.2 The escape chute which is part of the system must:
 - 2.2.1 consist of a single or double track slide with each track of sufficient width to prevent unrestricted evacuation by persons wearing an approved type of lifejacket;
 - 2.2.2 be of sufficient strength in its fully inflated condition to safely support a load of 300 kilogrammes (150 kilogrammes for a single track slide) at mid-length without bending or distorting;
 - 2.2.3 be sub-divided such that the loss of gas in any one compartment will not restrict its operational use as a means of evacuation;
 - 2.2.4 be provided with a slide path which will drain quickly and be safe to operate in wet conditions;
 - 2.2.5 be provided with vertically inflated panels on each side of the slide path of sufficient depth to permit safe evacuation in severe weather conditions; and
 - 2.2.6 be effectively connected to the chute container by arrangements which are capable of withstanding a load which is at least twice the load imposed in the maximum loaded condition.
- 2.3 The boarding platform, if fitted must be:
 - 2.3.1 stable in a seaway and provide a safe working area for those operating the system;
 - 2.3.2 self draining;
 - 2.3.3 sub-divided in such a way that the loss of gas from any one compartment will not restrict its operational use as a means of evacuation;
 - 2.3.4 of sufficient area that will provide for the securing of at least two liferafts for boarding and to accommodate at least the number of persons that at any time are expected to be on the platform. This usable platform area must be at least equal to:

20% of total number of persons that the marine evacuation system is certified for m²

4

or 10 square metres whichever is the greater. Alternative arrangements may be approved



- subject to a demonstration that they comply with all the prescribed performance requirements;
- 2.3.5 such that sufficient buoyancy will be provided for the working load. In the case of an inflatable platform, the main buoyancy chambers, which for this purpose must include any thwarts or floor inflatable structural members are to meet the requirements of Part 2, Schedule 4, based upon the platform capacity except that the capacity must be obtained by dividing by 0.25 the usable area given in paragraph 2.3.4;
- 2.3.6 fitted with stabilising waterpockets designed in accordance with the standards stated in Part 2 of Schedule 4;
- 2.3.7 restrained by a bowsing line which is designed to deploy automatically as the system inflates so as to prevent it drifting to a position where it would be deployed at an angle of more than 45 degrees to the ship's side;
- 2.3.8 provided with mooring and bowsing line patches of sufficient strength to tie off the largest inflatable liferaft associated with the system; and
- 2.3.9 provided with a means of quick release from the chute and, if intended for use as an inflatable liferaft, comply with the appropriate requirements of Part 2 of Schedule 4.

Performance of the System

3. A marine escape system must:
- 3.1 be capable of deployment by one person at the embarkation position;
- 3.2 not interfere with the deployment of any other life-saving equipment fitted in the ship;
- 3.3 be capable of transferring twice the number of persons it is designed to evacuate without significant deterioration of the slide paths;
- 3.4 be capable of satisfactory operation in a sea-way;
- 3.5 in the case of a passenger ship, be capable of transferring from the ship into the inflated liferafts the total number of persons for which the system is designed to evacuate within a period of 30 minutes and in the case of the cargo ship within 10 minutes from the time the abandon ship signal is given;
- 3.6 be capable of deployment from a passenger ship with a trim of up to 10 degrees and a list of up to 20 degrees either way;
- 3.7 In the case of being fitted with an inclined slide, such that the angle of the slide to the horizontal is:
- 3.7.1 within a range of 30 degrees to 35 degrees when the ship is upright and in the lightest sea-going condition; and
- 3.7.2 in the case of a passenger ship, a maximum of 55 degrees in the final stage of flooding set by the requirements in Schedule 3, paragraph 2 of MSN 1698 (M).
- 3.8 evaluated for capacity by means of timed evacuation deployments conducted in harbour;
- 3.9 capable of providing a satisfactory means of evacuation in a sea state associated with a wind of force 6 on the Beaufort scale;



- 3.10 designed to, as far as practicable, remain effective under conditions of icing;
- 3.11 so constructed that only a minimum amount of routine maintenance is necessary. Any part requiring maintenance by the ship's crews must be readily accessible and easily maintained; and
- 3.12 arranged such that liferafts may be securely attached to the platform and released from the platform by a person either in the liferaft or on the platform.

Associated Inflatable Liferafts

- 4. An inflatable liferaft used in conjunction with the marine escape system must:
 - 4.1 conform with the requirements of Part 1 and Part 2 of Schedule 4 where applicable;
 - 4.2 be sited close to the system container but be capable of dropping clear of the deployed chute/slide and boarding platform;
 - 4.3 be capable of release from its stowage rack with arrangements which will enable it to be moored and inflated alongside the boarding platform;
 - 4.4 be capable of release from its stowage rack as an independent item of life-saving equipment;
 - 4.5 be provided with float free arrangements complying with the requirements of Part 8 of Schedule 4; and
 - 4.6 be provided with pre-connected or easily connected retrieving lines to the platform.

Instructions and Information

- 5. Instructions and information must be in a form suitable for the training manual and in the instructions for on-board maintenance referred to in Schedule 14. Instructions and information must be in English in a clear and concise form and must include:
 - 5.1 a general description of the system;
 - 5.2 the installation arrangements;
 - 5.3 the operational instructions for the system, and associated survival craft;
 - 5.4 the on-board maintenance requirements; and
 - 5.5 the servicing requirements.

Containers for Marine Evacuation Systems

- 6.1 The evacuation passage and platform must be packed in a container that is:
 - 6.1.1 so constructed as to withstand hard wear under conditions encountered at sea; and
 - 6.1.2 as far as practicable watertight, except for drain holes in the container bottom.
- 6.2 The container must be marked with:
 - 6.2.1 maker's name or trade mark;
 - 6.2.2 serial number;



- 6.2.3 name of approval authority and the capacity of the system;
- 6.2.4 SOLAS 1998;
- 6.2.5 date of manufacture (month and year);
- 6.2.6 date and place of last service;
- 6.2.7 maximum permitted height of stowage above waterline; and
- 6.2.8 stowage position on board.
- 6.3 Launching and operating instructions must be marked on or in the vicinity of the container.

Marking on Marine Evacuation Systems

- 7.1 The marine evacuation system must be marked with:
 - 7.1.1 maker's name or trade mark;
 - 7.1.2 serial number;
 - 7.1.3 date of manufacture (month and year);
 - 7.1.4 name of approving authority;
 - 7.1.5 name and place of servicing station where it was last serviced, together with the date of servicing; and
 - 7.1.6 the capacity of the system.

PART 2 – TRAINING

General

- 1.1 Facilities for crew training in the use of marine escape systems must include:
 - 1.1.1 the provision on board of an operational manual for the system and its associated inflatable liferafts;
 - 1.1.2 the provision of on-board training aids; and
 - 1.1.3 the provision ashore of a training course including, as far as is possible, practical exercises with full size equipment.

PART 3 – MEANS OF RESCUE SYSTEM

General

- 1.1 The means of rescue system must comply with the applicable requirements of Part 1 and also comply with the following requirements:
 - 1.1.1 the means of rescue must provide for the safe transfer of persons rescued from the sea to the deck of the ship;
 - 1.1.2 the means of rescue must provide an area of at least 9 square metres at water level to



receive rescued persons;

- 1.1.3 the means of rescue must provide for the transfer of helpless persons to the deck of the ship;
- 1.1.4 the rescue area into which the means of rescue is launched must be adequately illuminated from the deck of the ship;
- 1.1.5 the means of rescue must be one of the following:
 - 1.1.5.1 a marine evacuation system complying with the requirements of Part 1, Schedule 5 providing a suitable floating platform, with a ladder or other means to ascend to the deck for able-bodied persons, and a mechanically powered means to safely hoist persons lying down. If a slide of a marine evacuation system is intended to provide the means of transfer from the platform to the deck of the ship for able-bodied persons, the slide must be provided with suitable handholds or portable ladders with steps having an efficient non-slip surface;
 - 1.1.5.2 an appliance complying with the requirements for davit launched liferafts in Schedule 4, Part 1, paragraph 3.1; Part 2, paragraph 4.1.1 and Part 8, paragraph 1.1.1, and in the case of an inflatable appliance Schedule 4, Part 1, paragraphs 4.1 and 4.2; Part 2 paragraphs 2.1, 2.1.1, 2.1.2, 2.3, 2.4, 4.1.3, 4.1.3.1, 4.1.3.2 and 5.1 and Part 8 paragraph 1.12.1 or in the case of a rigid appliance Schedule 4, Part 1, paragraphs 4.1.1, 4.1.2 and 4.1.5 and Part 6, paragraphs 1, 2, 4.1.2, 4.1.6 and 5.1.1, to provide a suitable floating platform. The appliance must be used with a liferaft launching appliance with a powered winch motor capable of raising the loaded appliance from the water to the deck of the ship with the total number of persons for which it is approved as a means of rescue at a rate of not less than 0.3 metres per second;
 - 1.1.5.3 the appliance provided for the launch and recovery of a fast rescue boat may be used as part of a means of rescue system provided it meets and does not conflict with any other relevant requirements.
- 1.1.6 The means of rescue must comply with the following:
 - 1.1.6.1 the appliance must be of a highly visible colour, and must be protected against damage when moving against the ship's side;
 - 1.1.6.2 the occupants must be protected against injury caused by the launching appliance;
 - 1.1.6.3 two boarding ramps complying with Part 2, Schedule 4 paragraph 3.1 or Part 6, paragraph 3.1 must be fitted;
 - 1.1.6.4 the floor must be self-draining;
 - 1.1.6.5 suitable means must be provided for bowing in the platform to the ship's side;
 - 1.1.6.6 one knife of a type described in Part 8, Schedule 4 paragraph 1.1.2 must be stowed in a pocket close to each bowing line attachment patch;
 - 1.1.6.7 a special arrangement must be fitted to close the gap between the loaded platform and the deck when the rescued persons board the ship;
 - 1.1.6.8 the appliance must be conspicuously marked to prevent confusion with liferafts;
 - 1.1.6.9 if inflatable, the inflation system must be quickly initiated by a manual control; and



1.1.6.10 means must be provided for preventing occupants from falling from the platform on impact with the ship's side.



SCHEDULE 6

LAUNCHING APPLIANCES AND EMBARKATION LADDERS

PART 1 – GENERAL

General Requirements

- 1.1 With the exception of the secondary means of launching for free-fall lifeboats, each survival craft and rescue boat launching appliance, together with all its launching and recovery gear, must be so arranged that the fully equipped survival craft or rescue boat it serves can be safely lowered at a list of up to 20 degrees either way and against a trim of up to 10 degrees:
- 1.1.1 after being boarded by its full complement of persons at the stowed position or from an embarkation deck, as appropriate; and
- 1.1.2 without persons in the survival craft or rescue boat.
- 1.2 Notwithstanding the requirements of paragraph 1.1, lifeboat launching appliances for oil tankers, chemical tankers and gas carriers with a final angle of heel greater than 20 degrees calculated, as appropriate, in accordance with:
- 1.2.1 regulation 29(3)(c) of the Merchant Shipping (Prevention of Oil Pollution) Regulations 1996 (S.I 1996/2154);
- 1.2.2 paragraph 2.9.2.2 of the International Code for the Construction and equipment of Ships carrying Dangerous Chemicals in Bulk (IMO Resolution MSC 4(48)); or
- 1.2.3 paragraph 2.9.1.2 of the International Code for the Construction and Equipment of Ships carrying Liquefied Gases in Bulk (IMO Resolution MSC 5(48));
- must be capable of operating at the final angle of heel on the lower side of the ship taking into consideration the final damaged waterline of the ship.
- 1.3 Davits, winches, falls, blocks and all other launching gear must comply with the requirements of Parts 2, 3 or 4.
- 1.4 On ships which regularly trade to Antarctica or North of the Arctic Circle or to sea areas where ice or icing-up conditions can be expected, each launching appliance must, as far as practicable, remain effective under conditions of icing.
- 1.5 Every launching appliance for a lifeboat, rescue boat, liferaft or inflated boat must be so constructed that a minimum amount of routine maintenance is necessary. All parts requiring regular maintenance by the ship's crew must be readily accessible and easily maintained.
- 1.6 A launching appliance must not depend on any means other than gravity or stored mechanical power which is independent of the ship's power supplies to launch the survival appliance or rescue boat it serves in, the fully loaded and equipped condition, and in the light condition. However, if the rescue boat is a dedicated rescue boat the mechanical power need not be independent of the ship's power supplies.



Stresses

- 2.1 Structural members and all blocks, falls, padeyes, links, fastenings and all other fittings used in connection with launching equipment must be designed on the basis of a factor of safety calculated on the maximum working load assigned and the ultimate strength of the material used for construction. A minimum factor of safety of 4.5 must be applied to the structural members of all davits and winches, and to bousing tackle and tricing pendants where they are required; and a minimum factor of safety of 6 must be applied to falls, suspension chains, links and blocks.

Launching Appliances Using Falls and a Winch

- 3.1 Launching appliances using falls and a winch, except for secondary launching appliances for free-fall lifeboats, must also comply with the following:
- 3.2 An efficient hand gear must be provided to recover each survival craft, rescue boat and fast rescue boat.
- 3.3 Where davit arms are recovered by power, safety devices must be fitted which will automatically cut the power off before the arms reach their stops in order to avoid overstressing the falls or davits, unless the motor is designed to prevent such overstressing.
- 3.4 A lifeboat launching appliance must be capable of recovering and stowing the lifeboat with its launching crew.
- 3.5 Every survival craft, rescue boat and fast rescue boat launching appliance must be fitted with brakes, or equivalent devices, capable of stopping the descent of the survival craft or rescue boat and holding it securely when loaded with its full complement of persons and equipment; brake pads must, where necessary, be protected from water and oil.
- 3.6 Manual brakes must be so arranged that the brake is always applied unless the operator, or a mechanism actuated by the operator, holds the brake control in the "OFF" position.
- 3.7 Every rescue and fast rescue boat launching appliance must be fitted with a winch motor of such capacity that the rescue boat, or a lifeboat if it has been accepted as a rescue boat, can be raised from the water with its full rescue boat complement of persons and equipment to a position where the persons can be safely disembarked.
- 3.8 Rescue boat launching and recovery appliances arrangements must:
- 3.8.1 be capable of hoisting the rescue boat, or a lifeboat in rescue boat mode, when loaded with its full rescue boat complement of persons and equipment at a rate of not less than 0.3 metre per second;
- 3.8.2 except in the case where a rescue boat is fitted with a single point suspension, every rescue boat must be provided with the means for facilitating the attachment of the lower fall blocks to the lifting arrangements of the boat when the boat is recovered from the sea in adverse weather conditions. For this purpose a recovery strop of adequate strength and suitable length must be provided for each davit, and one end of the strop must be attached to the lower fall block and the other end to the lifting arrangement on the boat. In addition means must be provided for hanging off the boat after hoisting to enable the lower fall block to be attached directly to the lifting hook.



- 3.9 Fast rescue boat launching and recovery arrangements must comply with the requirements of this Part as applicable and:
- 3.9.1 the launching appliance must be fitted with a device to dampen the forces due to interaction with the waves when the fast rescue boat is launched or recovered. The device must include a flexible element to soften shock forces and a damping element to cancel out oscillations;
 - 3.9.2 the winch must be fitted with an automatic high-speed tensioning device which prevents the wire from going slack in all sea state conditions in which the fast rescue boat is intended to operate;
 - 3.9.3 the winch brake must have a gradual action. When the fast rescue boat is lowered at full speed and the brakes are applied sharply the additional dynamical force induced in the wire due to retardation should not exceed 0.5 times the working load of the launching appliance;
 - 3.9.4 the lowering speed for a fully equipped fast rescue boat with its full complement of persons on board must not exceed 1 metre per second, the hoisting speed when lifting the fully equipped rescue boat loaded with 6 persons must be not less than 0.8 metres per second. The appliance must also be capable of lifting the rescue boat with the maximum number of persons that can be accommodated in the rescue boat as calculated under Part 2, Schedule 2 paragraph 2.3;
 - 3.9.5 at least three turns of wire must remain on the winch after the fast rescue boat is lowered to the sea with the ship at its lightest seagoing condition, a trim of up to 10 degrees and a list of up to 20 degrees, either way;
 - 3.9.6 These arrangements must take into account that the fast rescue boat is intended to be safely launched and retrieved even under severe adverse weather conditions.

Wire Ropes

- 4.1 Falls must be of rotation-resistant and corrosion-resistant steel wire rope.
- 4.2 The breaking tensile load of each wire rope used for lowering lifeboats, rescue boats, fast rescue boats, liferafts or inflated boats must be not less than 6 times the maximum load on the wire rope when lowering, hoisting or stowing.
- 4.3 Wire ropes must be securely attached to the drum of the winch, and the end attachments of the wires and other parts from which the craft is to be suspended must be capable of withstanding a proof load of not less than 2.2 times the load on such attachments and other parts.
- 4.4 Where wire rope splices or ferrule-secured eye terminals are used they must be capable of withstanding a proof test of not less than 2.2 times the load imposed on them in service.
- 4.5 Survival craft attached to davits must have the falls ready for service, and the falls must be at least long enough to reach the water with the ship at her lightest sea-going draught under unfavourable conditions of trim and listed to 20 degrees either way. Disengaging gear complying with the requirements of Part 1 of Schedule 2, must be provided for detaching the lifeboat or rescue boat from the falls.

Winches



- 5.1 In the case of a multiple drum winch, unless an efficient compensatory device is fitted, the falls must be so arranged to wind off the drums at the same rate when lowering, and to wind on the drums evenly at the same angle when hoisting. The lead blocks must be arranged to give a fleet angle or angle of lead of not more than five degrees for grooved drums and three degrees for ungrooved drums. In the case of mechanically controlled single-arm davits, the lead of the wire rope fall must be such that the fall winds evenly on the drum.
- 5.2 Winch brakes must be of robust construction and be capable of controlling and limiting the speed a boat is lowered. The hand brake must be so arranged that it is normally in the "ON" position and returns to the "ON" position when the control handle is not being operated. The mass of the brake lever must be sufficient to operate the brake effectively without additional pressure. The winch brakes must be of sufficient strength to withstand:
- 5.2.1 a static test with a proof load of not less than 1.5 times the maximum working load; and
- 5.2.2 a dynamic test with a proof load of not less than 1.1 times the maximum working load at maximum lowering speed.
- 5.3 The speed at which a fully laden lifeboat, rescue boat, liferaft or inflated boat with its equipment and launching crew is lowered into the water must be not less than that obtained from the formula:
- $$S = 0.4 + (0.02 \times H)$$
- where S = speed of lowering in metres per second, and
- H = height in metres from davit head, at the outboard position, to the waterline at the lightest seagoing condition.
- In the case of a lifeboat, rescue boat or inflated boat where "H" exceeds 30 metres the lowering speed need not exceed 1 metre per second. In the case of a liferaft where "H" exceeds 15 metres the lowering speeds need not exceed 0.7 metres per second.
- 5.4 Notwithstanding the requirements of paragraph 5.3 the speed of lowering a lifeboat, rescue boat or inflated boat must not exceed 1.3 metres per second. The speed of lowering a liferaft must not exceed 1 metre per second.
- 5.5 The speed of lowering survival craft, fully equipped but without persons on board, must be at least 70 per cent of that required by paragraph 5.3.
- 5.6 The brake gear of the winch must include the means for automatically controlling the speed of lowering to within the limits specified in paragraphs 5.3 and 5.4. A ratchet gear must be incorporated in these winches.
- 5.7 Hand gear handles must not be rotated by moving parts of the winch when the lifeboat or rescue boat is being lowered or when it is being hoisted by power. Provision must be made to allow the falls to be manually unwound.
- 5.8 The launching mechanism must be so arranged that it may be actuated by one person from a position on the ship's deck and, except for secondary launching appliances for free-fall lifeboats, from a position within the survival craft or rescue boat. When launched by a person on the deck, the launching and recovery arrangements must be such that the winch operator on the ship's deck is able to observe the craft at all times during launching and recovery.



- 5.9 In this case of a liferaft, if the lowering is actuated from within the raft by means of a control wire paid off from an auxiliary drum on the winch:
- 5.9.1 the mass of the control wire must be sufficient to overcome the friction of the various pulleys on the control wire;
 - 5.9.2 the winch brake must be operable from within the liferaft;
 - 5.9.3 the winch brake must not be affected by the mass of the fully extended control wire nor the wind effects on it; and
 - 5.9.4 there must be sufficient length of control wire available at the craft during all stages of lowering.
- 5.10 When the lowering of the lifeboat or rescue boat is controlled from within the craft by means of a control wire paid off from an auxiliary drum on the winch:
- 5.10.1 the mass of the control wire must be sufficient to overcome the friction of the various pulleys on the control wire, when turning out the lifeboat or rescue boat from the stowed position;
 - 5.10.2 the winch brake must be operable from within the boat;
 - 5.10.3 the winch brake must not be affected by the mass of the fully extended control wire, nor the wind effects on it;
 - 5.10.4 there must be sufficient length of control wire available at the boat during stages of lowering; and
 - 5.10.5 means must be provided to retain the free end of the control wire in the boat until the boat is detached from the falls.

Float-free Launching

- 6.1 Where a survival craft requires a launching appliance and is also designed to float free, the float-free release of the survival craft from its stowed position must be automatic.

Free-fall Launching

- 7.1 Every free-fall launching appliance using an inclined plane must, in addition to complying with the applicable requirements of paragraph 1 also comply with the following requirements:
- 7.1.1 the launching appliance must be so arranged that excessive forces are not experienced by the occupants of the survival craft during launching;
 - 7.1.2 the launching appliance must be a rigid structure with a ramp angle and length sufficient to ensure that the survival craft effectively clears the ship;
 - 7.1.3 the launching appliance must be efficiently protected against corrosion and be so constructed as to prevent incendive friction or impact sparking during the launching of the survival craft;
 - 7.1.4 The launching appliance must be designed and arranged so that in its ready to launch position, the distance from the lowest point on the lifeboat it serves to the water surface with the ship in its lightest seagoing condition does not exceed the lifeboat's free-fall



certification height taking into consideration the requirements of paragraph 3, Part 9, Schedule 2;

- 7.1.5 The launching appliance must be arranged so as to preclude accidental release of the lifeboat in its unattended stowed position. If the means provided to secure the lifeboat cannot be released from inside the lifeboat, it must be so arranged as to preclude boarding the lifeboat without first releasing it;
- 7.1.6 The release mechanism must be arranged so that at least two independent actions from inside the lifeboat are required in order to launch the lifeboat;
- 7.1.7 Each launching appliance must be provided with a secondary means to launch the lifeboat by falls. Such means must comply with the requirements of Section 1 except paragraph 1.6 and Section 3 except paragraph 3.2. It must be capable of launching the lifeboat against unfavourable conditions of trim of up to only 2 degrees and list of up to only 5 degrees either way and it need not comply with the speed requirements of paragraphs 5.3 and 5.4. If the secondary launching appliance is not dependent on gravity, stored mechanical power or other manual means, the launching appliance must be connected both to the ship's main and emergency power supplies; and
- 7.1.8 The secondary means of launching must be equipped with at least a single off-load capability to release the lifeboat.

Evacuation - Passage Launching and Embarkation

- 8.1 Every evacuation-passage launching appliance must, in addition to complying with the applicable requirements of paragraph 1, also comply with the requirements of Schedule 5.

Means of Rescue Launching and Embarkation

- 9.1 Every means of rescue launching and recovery appliance must; in addition to complying with the applicable requirements of Part 1; also comply with the requirements of Part 3, Schedule 5.

Instructions and Information

- 10.1 Instructions and information must be in a form suitable for the training manual and in the instructions for on-board maintenance referred to in Schedule 14. Instructions and information must be in English in a clear and concise form and must include the following:
 - 10.1.1 a description of launching appliance and winch, were provided;
 - 10.1.2 the operation for launching and recovery; and
 - 10.1.3 the maintenance required.

PART 2 – LIFEBOAT AND RESCUE BOAT LAUNCHING APPLIANCES

General

- 1.1 Every lifeboat, rescue boat and fast rescue boat launching appliance must comply with the requirements of Part 1 as is applicable to it and, in addition, must comply with the requirements of this Part.
- 1.2 In this Part the expression “working load” means:
 - 1.2.1 in relation to davits to which paragraphs 2.1 and 2.2 apply, the sum of the weight of the lifeboat and its full equipment, the blocks and falls, and the maximum number of persons



which the lifeboat is deemed fit to carry, the weight of each person being taken to be 75 kilogrammes; and

- 1.2.2 in relation to winches, the maximum pull exerted by the fall or falls at the winch drum during lowering, hoisting or stowing which in any case is to be taken as not less than the working load on the davit or davits divided by the velocity ratio of the lowering tackle.

Construction

- 2.1 The arrangements of the davits must be such as to enable safe boarding of the lifeboat in accordance with the requirements of paragraph 2.4 and 2.5 of Part 2 of Schedule 2.
- 2.2 If partially enclosed lifeboats are carried, a davit span must be provided, fitted with not less than two lifelines of sufficient length to reach the water with the ship in its lightest seagoing condition, under unfavourable conditions of trim and with the ship listed not less than 20 degrees either way.

Strength

- 3.1 Every davit serving a lifeboat which is required to be boarded and launched from the stowed position and put into the water when loaded with its full complement of persons must, together with its winch, falls, blocks and all other associated equipment, be of such strength that the lifeboat with its full equipment can be turned out and then safely lowered into the water from the stowed position with its full complement of persons, when the ship has a list of up to 20 degrees either way and a trim up to 10 degrees or such greater angles as may be required under paragraph 1.2 of Part 1.
- 3.2. Every davit serving a lifeboat which is required to be boarded and launched from an embarkation position and put into the water when loaded with its full complement of persons must, together with its winch, falls, blocks and all other associated lowering gear, be of such strength that the lifeboat with its full equipment and manned by a launching crew of not less than 2 persons can be turned out and then safely lowered into the water from the embarkation position with its full complement of persons, when the ship has a list of up to 20 degrees either way and a trim of up to 10 degrees.
- 3.3 Every set of davits, davit or other means of launching to which a lifeboat is attached, together with its winch and associated gear must be of such strength that the lifeboat can be hoisted with launching crew of at least 3 persons and its full equipment at a rate of not less than 0.05 metre per second when a powered winch is fitted. When an unpowered winch is fitted the hoisting rate must be not less than 0.01 metre per second.
- 3.4 Every set of davits, davit or other means of launching to which a rescue boat is attached must be fitted with a powered winch and must, together with its associated gear, be of such strength that the boat to which it is attached can be hoisted when loaded with its full rescue boat complement of persons and equipment at a rate of not less than 0.3 metre per second. When a lifeboat is designated as a rescue boat, the davits, davit or other means of launching must be capable of hoisting the boat to a disembarkation position at a rate of not less than 0.3 metre per second when loaded with its full rescue boat complement, or 6 persons whichever is the greater, and its full lifeboat equipment.
- 3.5 Every fast rescue boat launching and recovery arrangement must incorporate a powered winch, dampening devices and braking requirements described in Part 1 paragraph 3.9 and be capable of lowering the fully equipped boat with its full complement of persons at a speed not exceeding 1 metre per second and hoisting the fully equipped boat loaded with 6 persons at a speed of at least 0.8 metres per second. The arrangement must also be capable of lifting the rescue boat with the maximum number of persons



accommodated. The complete arrangement must be of adequate strength to withstand the stresses developed in the system carrying out these operations safely under severe adverse weather conditions.

Gravity Davits

- 4.1 All gravity davits must be so designed that there is a positive turning out moment during the whole of the davit travel from the inboard to the outboard position when the vessel is upright and also when the vessel is listed at any angle up to and including 30 degrees either way from upright, or 10 degrees more than the angle required by paragraph 1.2 of Part 1. In the case of gravity type davits comprising arms mounted on rollers which engage with and travel down fixed inclined trackways, the trackways must be inclined at an angle of not less than 35 degrees to the horizontal when the vessel is upright.

Luffing Davits

- 5.1 The operating gear of luffing davits must be of sufficient power to ensure that the lifeboats or rescue boats fully equipped and carrying:
- 5.1.1 the total number of persons they are certified to carry; or
- 5.1.2 a launching crew of not less than 2 persons when boarded from a stowed position or embarkation deck;
- can be turned out against a list of at least 20 degrees.

Static Load Test

- 6.1 Each davit arm and its attachments, except the winch brakes, must be capable of withstanding a static load test when in the outboard position, of at least 2.2 times the maximum load designed to be supported by that arm.

Attachments at the Davit Head

- 7.1 The attachments at the davit head from which the blocks are suspended must be capable of withstanding a proof load test of not less than 2.2 times the maximum load on them.

Blocks

- 8.1 Lower blocks, when fitted, must be non-toppling. In the case of rescue boats provision must be made to prevent the falls from cabling. The size of blocks must be commensurate with the size of the falls.
- 8.2 The blocks must be capable of withstanding a proof load test of not less than 2.2 times the maximum load it is intended to carry in service. The clearance between the sheaves and the cheeks of the blocks in which wire rope is used must be kept to a practical minimum to prevent the rope from overriding the rim of the sheave of any block or load sheave. Component parts of blocks other than their sheaves must be of ductile material.

PART 3 – LIFERAFT LAUNCHING APPLIANCES

General



- 1.1 Every launching appliance must comply with the requirements of Part 1 as is applicable to it and in addition must comply with the requirements of this Part.
- 1.2 In this Part the expression “working load” means the sum of the mass of the liferaft and its equipment, all other associated gear that is supported by the launching appliance during the lowering operation and the maximum number of persons which the liferaft is deemed fit to carry, the mass of each person being taken to be 75 kilogrammes.
- 1.3 The arrangements of the launching appliance must be such as to enable safe boarding of the liferaft in accordance with the requirements of paragraph 4.3 and 4.4 of Part 2 of Schedule 4.

Strength

- 2.1 Every launching appliance serving a liferaft which is required to be put into the water when loaded with its full complement of persons must, together with its winch, falls, blocks and all other associated launching equipment, be of such strength that the liferaft with its full equipment can be safely lowered into the water from the embarkation position with its full complement of persons, when the ship has a list of up to 20 degrees either way and a trim of up to 10 degrees, or such higher angle as may be required by paragraph 1.2 of Part 1.

Static Load Test

- 3.1 Every launching appliance and its attachments, except the winch brakes, must be capable of withstanding a static load test when in the full outboard position, of at least 2.2 times the maximum designed working load.

Release of the Liferaft

- 4.1 The launching appliance must be so arranged as to prevent premature release during the lowering of the liferaft but must be such that on becoming waterborne the raft must be automatically released from the release hook which must comply with requirements of Part 7 of Schedule 4.

PART 4 – INFLATED BOAT LAUNCHING APPLIANCES

General

- 1.1 Every inflated boat launching appliance must comply with the requirements of Part 1 as is applicable to it and in addition with the requirements of this Part.
- 1.2 In this Part the expression “working load” means the weight of:
- 1.2.1 the inflated boat and its full equipment;
 - 1.2.2 the blocks and falls;
 - 1.2.3 a launching crew of 2 persons each of mass 75 kilogrammes; and
 - 1.2.4 a weight of 60 kilogrammes or the engine together with its fuel tank and sufficient fuel for two hours operation, whichever is the greater.
- 1.3 In this Part the expression “inflated boat” means any inflated boat or rigid inflated boat other than a dedicated rescue boat.

Construction



- 2.1 Every inflated boat launching appliance must be so constructed to be:
 - 2.1.1 capable of recovering the inflated boat and bringing it on board the ship;
 - 2.1.2 readily available and not stowed or used for any purpose other than the launching of the inflated boat whilst the ship is at sea; and
 - 2.1.3 provided with a suitable means for manual operation.

Strength

- 3.1 Every launching appliance serving an inflated boat must, together with its winch if fitted, falls, blocks and other associated lowering gear, be of such strength that the inflated boat with its full equipment can be safely lowered into the water from the embarkation position with a complement of 2 persons, when the ship has a list of up to 20 degrees either way and a trim of up to 10 degrees.

Static Load Test

- 4.1 Every launching appliance and its attachments, except the winch brakes, must be capable of withstanding a static load test when in the full outboard position of at least 2.2 times the maximum designed working load.

Winches

- 5.1 Every such launching appliance must be provided with a winch when the inflated boat is situated more than 4.5 metres above the lightest sea going waterline.

Cordage Rope Falls

- 6.1 Cordage rope falls must be of manila or some other suitable material and must be durable, unkinkable, firm laid and pliable. They must be able to pass freely under any conditions through a hole 10 millimetres larger than the nominal diameter of the rope. The breaking load of each rope used for lowering inflated boats must be not less than 6 times the maximum load on the rope when lowering or hoisting. Winding reels or flaking boxes for the manila rope falls must be provided.
- 6.2 Such falls must be at least long enough to reach the water with the ship at her lightest seagoing condition and listed to 20 degrees either way.

Bollards

- 7.1 Suitable bollards or other equally effective appliances for lowering any inflated boat must be provided in all cases where cordage rope falls are used. Such bollards or other appliances must be sited so as to ensure that the inflated boat served by them can be safely lowered, the fairleads or lead sheaves must be fitted so as to ensure that it must not be lifted during the process of turning out or swinging out.

PART 5 – EMBARKATION LADDERS

Construction

- 1.1 The steps of the three-string embarkation ladder applicable for Class III to VI(A) must be:



- 1.1.1 made of hardwood, free from knots or other irregularities, smoothly machined and free from sharp edges and splinters, or of suitable material of equivalent properties;
- 1.1.2 provided with an efficient non-slip surface either by longitudinal grooving or by the application of an approved non-slip coating;
- 1.1.3 not less than 1370 millimetres long, 115 millimetres wide and 25 millimetres in depth, excluding any non-slip surface or coating; and
- 1.1.4 equally spaced not less than 300 millimetres or more than 380 millimetres apart and secured in such a manner that they will remain horizontal.
- 1.2 The side and centre ropes of the three-string embarkation ladder must consist of two parts of uncoiled 20 millimetres diameter good quality manila ropes.
- 1.3 The steps for the two-string embarkation ladder, applicable to Ships Other than Classes III to VI(A) Regulations, must be:
 - 1.3.1 made of hardwood, free from knots or other irregularities, smoothly machined and free from sharp edges and splinters, or of suitable material of equivalent properties;
 - 1.3.2 provided with an efficient non-slip surface either by longitudinal grooving or by the application of an approved non-slip coating;
 - 1.3.3 not less than 480 millimetres long, 115 millimetres wide and 25 millimetres in depth, excluding any non-slip surface or coating; and
 - 1.3.4 equally spaced not less than 300 millimetres or more than 380 millimetres apart and secured in such a manner that they will remain horizontal.
- 1.4 The side and centre ropes of the two-string embarkation ladder must consist of two parts of uncoiled 20 millimetres diameter good quality manila ropes.



SCHEDULE 7

PYROTECHNIC SIGNALS AND LINE-THROWING APPLIANCES

PART 1 – GENERAL

General

- 1.1 A pyrotechnic signal must:
- 1.1.1 be constructed with proper workmanship and materials;
 - 1.1.2 not be damaged in stowage in the air temperature range of -30°C to $+65^{\circ}\text{C}$;
 - 1.1.3 be contained in a water-resistant casing;
 - 1.1.4 have integral means of ignition which can be readily operated with wet, cold or gloved hands in adverse conditions and require the minimum of preparation;
 - 1.1.5 in the case of a rocket parachute flare or a hand flare be so designed that, when used in accordance with the manufacturer's operating instructions, it must not cause discomfort to the person holding the casing or endanger a liferaft by burning or glowing residues;
 - 1.1.6 in the case of a buoyant smoke signal be so designed that it must not ignite explosively when used in accordance with the manufacturer's operating instructions;
 - 1.1.7 be so constructed that any sealing must not depend on adhesive tapes, or plastic envelopes;
 - 1.1.8 be so constructed that the end from which the rocket is ejected can be positively identified by day or night;
 - 1.1.9 be so constructed that all components, compositions and ingredients of the signal and the means of igniting it must be of such character and quality to enable the signal to maintain its serviceability under good average storage conditions in the marine environment for a period of at least 4 years; and
 - 1.1.10 be so constructed that if it is intended to be stowed in a liferaft it can function effectively after being subjected to a drop test appropriate to the height at which the liferaft is to be stowed, when the signal is packed in the equipment container.

Marking

- 2.1 A pyrotechnic signal must have printed on its casing brief instructions or diagrams clearly illustrating how it is to be used.
- 2.2 The date of manufacture and the date of expiry must be marked indelibly on the casing.

PART 2 – ROCKET PARACHUTE FLARES

General

- 1.1 Every rocket parachute flare must comply with the requirements of Part 1 and in addition must comply with the requirements of this Part.



Performance

- 2.1 A rocket must, when fired vertically, reach an altitude of not less than 300 metres. At or near the top of its trajectory, the rocket must eject a parachute flare, which must:
 - 2.1.1 burn with a bright red colour;
 - 2.1.2 burn uniformly with an average luminous intensity of not less than 30,000 candela;
 - 2.1.3 have a burning period not less than 40 seconds;
 - 2.1.4 have a rate of descent of not more than 5 metres/second; and
 - 2.1.5 not damage its parachute or attachments while burning.
- 3.1 The rocket must in addition be capable of functioning when the rocket is fired at an angle of 45 degrees to the horizontal.

PART 3 – HAND FLARES

General

- 1.1 Every flare must comply with the requirements of Part 1 and in addition must comply with the requirements of this Part.

Performance

- 2.1 A hand flare must:
 - 2.1.1 burn with a bright red colour;
 - 2.1.2 burn uniformly with an average luminous intensity of not less than 15,000 candela;
 - 2.1.3 have a burning period of not less than 1 minute; and
 - 2.1.4 after ignition continue to burn after having been immersed for a period of 10 seconds under 100 millimetres of water.

PART 4 – BUOYANT SMOKE SIGNALS

General

- 1.1 Every buoyant smoke signal must comply with the requirements of Part 1 and in addition with the requirements of this Part.

Performance

- 2.1 A buoyant smoke signal must:
 - 2.1.1 emit smoke of a highly visible colour at a uniform rate for a period of not less than 3 minutes when floating in calm water;
 - 2.1.2 not emit any flame during the entire smoke emission time;



- 2.1.3 not be swamped in a sea-way; and
- 2.1.4 continue to emit smoke when submerged in water for a period of 10 seconds under 100 millimetres of water.
- 3.1 It must be safe to operate in water covered by a low flash point liquid.

PART 5 – LINE-THROWING APPLIANCES

Construction

- 1.1 A line-throwing appliance must:
 - 1.1.1 be constructed with proper workmanship and materials;
 - 1.1.2 in the case of an integral rocket and line, be contained in a water-resistant casing; in the case of a pistol fired rocket, the rocket must be contained in a water-resistant casing;
 - 1.1.3 include not less than four projectiles;
 - 1.1.4 include not less than four lines each having a breaking strength of not less than 20 kiloNewtons; and
 - 1.1.5 be so designed that the end from which the rocket is ejected can be positively identified by day or night.
- 2.1 Rockets, cartridges and igniters must be so constructed that all components, compositions and ingredients must be of such character and quality to maintain serviceability under good average storage conditions in the marine environment for a period of at least 4 years.
- 3.1 Rockets, cartridges and igniters must be so constructed that any sealing must not depend on adhesive tapes or plastic envelopes.

Performance

- 4.1 A line-throwing appliance must be capable of throwing a line not less than 4 millimetres in diameter a distance of at least 230 metres in calm weather.
- 4.2 A line-throwing appliance must be capable of throwing a line in such a manner that the lateral deflection on either side of the direction of firing does not exceed 10 per cent of the length of flight of the rocket in calm weather.

Marking

- 5.1 A line-throwing appliance must be marked with brief instructions or diagrams clearly illustrating the use of the appliance.
- 5.2 The date of manufacture and the date of expiry must be marked indelibly on the rockets, cartridges and igniters.

PART 6 – INFORMATION INSTRUCTIONS AND STOWAGE

- 1.1 Instructions and information for pyrotechnic signals must be in a form suitable for the



training manual referred to in Schedule 14. Instructions and information must be in English in a clear and concise form and must include:

- 1.1.1 a description of the item;
- 1.1.2 the method of its use, including any precautions or warnings;
- 1.1.3 its stowage;
- 1.1.4 guidance on when it is to be used; and
- 1.1.5 instructions for replacing rockets, cartridges or strikers (integral line-throwing appliance).



SCHEDULE 8

LIFEBUOYS AND ATTACHMENTS

PART 1 – GENERAL

General

- 1.1 Every lifebuoy and its attachments required by Regulation, must comply with the requirements of Schedule 1 as are applicable to it.

Instructions and information

- 2.1 In the case of lifebuoy self-igniting lights or self-activating smoke signals, instructions and information must be in a form suitable for the training manual and, if appropriate, the instructions for on-board maintenance referred to in Schedule 14. Instructions and information must be in English in a clear and concise form and must include:
- 2.1.1 the stowage and attachments to the lifebuoy;
 - 2.1.2 the type of energy source if provided and, if replaceable, the method and frequency of its replacement;
 - 2.1.3 the type of light source if provided and whether it is replaceable;
 - 2.1.4 any maintenance requirements including the method and frequency of checking the of the energy source if one is provided; and
 - 2.1.5 the operation of the light or signal and its duration.

PART 2 – LIFEBUOYS (SOLAS)

Construction

- 1.1 A lifebuoy must have an outer diameter of not more than 800 millimetres and an inner diameter of not less than 400 millimetres.
- 1.2 A lifebuoy must be constructed of inherently buoyant material. It must not depend for buoyancy upon rushes, cork shavings, granulated cork, any other loose granulated material or an air compartment.
- 1.3 It must have a mass of not less than 2.5 kilogrammes: except that if it is to operate a quick release arrangement for a self-activating smoke signal and self-igniting light it must have a mass sufficient to operate the arrangement or 4 kilogrammes, whichever is the greater.
- 1.4 It must be constructed to withstand a drop into water from the height at which it is stowed above the waterline in the lightest seagoing conditions or 30 metres, whichever is the greater, without impairing either its operating capability or that of its attached components.
- 1.5 It must be fitted with a grabline of not less than 9.5 millimetres in diameter and of length not less than 4 times the outside diameter of the lifebuoy. The grabline must be secured at four equidistant points around the circumference of the lifebuoy to form four equal



loops.

Performance

- 2.1 A lifebuoy must be capable of supporting not less than 14.5 kilogrammes of iron in fresh water for period of 24 hours.
- 2.2 It must not sustain burning or continue melting after being totally enveloped in a fire for a period of 2 seconds.

Marking

- 3.1 A lifebuoy must be marked in block capitals with the name and the port of registry of the ship on which it is carried.
- 3.2 A lifebuoy must be permanently marked with the maximum height above the waterline at which it can be stowed if this exceeds 30 metres.

PART 3 – LIFEBOUYS (610 millimetres)

- 1.1 Every lifebuoy (610 millimetres) must comply with requirements of Part 1 and 2: except that:
 - 1.1.1 it must have outer diameter of not less than 610 millimetres and an inner diameter of not less than 350 millimetres;
 - 1.1.2 it must have a mass of not less than 1.3 kilogrammes;
 - 1.1.3 the lightest seagoing condition should be taken to be 10 metres; and
 - 1.1.4 the grabline should not be less than 6 millimetres in diameter.

PART 4 – LIFEBOUY SELF-IGNITING LIGHTS

Construction

- 1.1 It must be constructed to withstand a drop into the water from the height at which it is stowed above the waterline in the lightest seagoing condition or 30 metres, whichever is the greater, without impairing either its operating capability or that of the lifebuoy to which it is attached.
- 1.2 It must be provided with means for being efficiently attached to a lifebuoy.
- 1.3 A lifebuoy self-igniting light attached to a lifebuoy carried by tanker must be of an electric battery type.
- 1.4 Components of electronic circuits should comply with the quality control requirements of BS 9000 or an equivalent standard. Where components cannot be obtained under one of the above standards these components may be covered by a Certificate of Conformance from the manufacturer of the components.

Performance



- 2.1 A lifebuoy self-igniting light must be such that it cannot be extinguished by water.
- 2.2 It must be capable of either burning continuously with a luminous intensity of not less than 2 candela in all directions of the upper hemisphere or flashing (discharge flashing) at a rate of not less than 50 flashes and not more than 70 flashes per minute with at least the corresponding effective luminous intensity and be provided with a source of energy which will give this performance for a period of at least 2 hours.
- 2.3 It must be capable of withstanding the drop test required by Part 2 paragraph 1.4.

Marking

- 3.1 A lifebuoy self-igniting light must be marked indelibly with:
 - 3.1.1 the manufacturer's name or trade mark;
 - 3.1.2 clear and concise directions for use in English supported where necessary by illustrations;
 - 3.1.3 the type of energy source;
 - 3.1.4 the date of manufacture and expiry in the case of a light with a non-replaceable energy source; and
 - 3.1.5 the maximum height above waterline at which it can be stowed.

PART 5 – LIFEBOUY SELF-ACTIVATING SMOKE SIGNALS

Construction

- 1.1 It must be constructed to withstand a drop into the water from the height at which it is stowed above the waterline in the lightest seagoing condition or 30 metres, whichever is the greater, without impairing either its operating capability or that of the lifebuoy to which it is attached.
- 1.2 It must be provided with means for being efficiently attached to a lifebuoy.
- 1.3 A lifebuoy self-activating smoke signal may also be provided with a self-igniting light which must comply with the requirements of Part 4.

Performance

- 2.1 A lifebuoy self-activating smoke signal must emit smoke of a highly visible colour at a uniform rate for a period of at least 15 minutes when floating in calm water.
- 2.2 It must not ignite explosively or emit any flame during the entire smoke emission time of the signal.
- 2.3 It must not be swamped in a sea-way.
- 2.4 It must continue to emit smoke when fully submerged for a period of at least 10 seconds.
- 2.5 It must be capable of quick release from its stowed position.



- 2.6 It must be safe to operate in waters covered by a low flashpoint liquid.
- 2.7 All components, composition and ingredients of the lifebuoy self-activating smoke signal, and the energy source of the self-igniting light, if provided, must be of such character and quality as to enable them to maintain their serviceability under good average stowage conditions in the marine environment for a period of at least four years unless, in the case of a self-igniting light energy source, it is possible to readily renew the energy source.

Marking

- 3.1 A lifebuoy self-activating smoke signal must be marked indelibly with:
- 3.1.1 the manufacturer's name or trade mark;
 - 3.1.2 the lot number or other means of identifying the signal;
 - 3.1.3 clear and concise directions for use in English supported where necessary by illustrations;
 - 3.1.4 the date of manufacture and date of expiry;
 - 3.1.5 the type of energy source in the case of a signal provided with a self-activating light; and
 - 3.1.6 the maximum height above the waterline at which it can be stowed.

PART 6 – LIFEBOUY BUOYANT LIFELINES

Construction

- 1.1 A lifebuoy buoyant lifeline must be non-kinking.
- 1.2 It must have a diameter of not less than 8 millimetres.
- 1.3 It must have a breaking strength of not less than 5 kiloNewtons.
- 1.4 It must be resistant to deterioration from exposure to sunlight.
- 1.5 It must have a length not less than twice the height at which it is stowed above the waterline in the lightest seagoing condition, or 30 metres, whichever is the greater. On ships of less than 12 metres in length the lifeline must be at least 18 metres in length.



SCHEDULE 9

LIFEJACKETS AND ATTACHMENTS

PART 1 – GENERAL

General

- 1.1 Every lifejacket and its attachment required by Regulations must comply with the requirements of Schedule 1 as is applicable to it.

Construction

- 2.1 A lifejacket must be so constructed that:
- 2.1.1 at least 75 per cent of persons, who are completely unfamiliar with the lifejacket, can correctly don it within a period of one minute without assistance, guidance or prior demonstration;
 - 2.1.2 after a demonstration, all persons can correctly don it within a period of 1 minute without assistance;
 - 2.1.3 it is capable of being worn inside out or, if that is not the case, it is clear that it can be worn only in one way and, as far as is possible, it cannot be donned incorrectly;
 - 2.1.4 it is comfortable to wear; and
 - 2.1.5 it allows the wearer to jump from a height of at least 4.5 metres into the water without injury and without dislodging or damaging the lifejacket.
- 2.2 It must be so constructed that the buoyancy is not reduced by more than 5 per cent after 24 hours submersion in fresh water.
- 2.3 It must be fitted with a whistle firmly secured by a cord of suitable length. The whistle must be non-metallic and not be affected by water or humidity.
- 2.4 It must be fitted with retro-reflective material to assist detection, and the dimensions and location of the material must be such as to meet this objective.
- 2.5 It must be fitted with a ring or loop or similar device of adequate strength to facilitate rescue.
- 2.6 It must be fitted with an approved light if it is intended for a ship which is required to carry lifejackets fitted with lights.

Performance

- 3.1 It must have sufficient buoyancy and stability in calm fresh water to:
- 3.1.1 lift the mouth of an exhausted or unconscious person not less than 120 millimetres clear of the water with the body inclined backwards at an angle of not less than 20 degrees and not more than 50 degrees from the vertical position; and
 - 3.1.2 turn the body of an unconscious person in the water from any position to one where the mouth is clear of the water in not more than 5 seconds.



- 3.2 An inherently buoyant lifejacket must allow the person wearing it to swim a short distance and to board a survival craft.
- 3.3 The buoyancy of the lifejacket must not reduce by more than 5 per cent after 24 hours submersion in fresh water.
- 3.4 It must not sustain burning or continue melting after being totally enveloped in a fire for a period of 2 seconds.

Marking

- 4.1 A lifejacket must be marked indelibly with:
 - 4.1.1 the manufacturer's name or trade mark and the name of the lifejacket, if any;
 - 4.1.2 the words "PERSON OF 32 KG OR MORE" in letters not less than 12 millimetres in size on the front in the case of inflatable lifejackets and on both sides in the case of lifejackets which can be worn inside out. In the case of lifejackets which can only be worn one way the marking must be on the outside of the lifejacket;
 - 4.1.3 the year of manufacture or, in the case of an inflatable lifejacket, the means to identify the date of manufacture;
 - 4.1.4 the word "FRONT" on both sides of the front part of the lifejacket in letters not less than 12 millimetres in size in the case of lifejackets which can be worn inside-out. In the case of lifejackets which can only be worn one way the marking must be on the outside of the front part of the lifejacket.

Lifejacket Lights

Construction

- 5.1.1 The complete light unit must be constructed with proper workmanship and materials. The materials must be compatible with materials used in the construction of a lifejacket and with an immersion suit designed to be worn with a lifejacket.
- 5.1.2 The unit must be rot-proof, corrosion-resistant and not be unduly affected by seawater, oil or fungal attack.
- 5.1.3 The unit must not have any adverse effect on the performance of the lifejacket or immersion suit to which it is attached.
- 5.1.4 Each component of the unit must be designed to remain serviceable for at least as long as the storage life of the power source.
- 5.1.5 The unit must be so designed that it will not leak any substance which would be harmful to the lifejacket, immersion suit or wearer.
- 5.1.6 A flashing light must be provided with a manually operated switch.
- 5.1.7 A flashing light must not be fitted with a lens or curved reflector to concentrate the beam.
- 5.1.8 Components of electric circuits must comply with the quality control requirements of ISO 9000 or an equivalent standard. Where components cannot be obtained under one of the



above standards these components must be covered by a Certificate of Conformance from the manufacturer of the components.

Attachment

- 5.2.1 The method of attachment must not require penetration of a lifejacket's buoyancy material or adversely affect the watertight integrity of an immersion suit.
- 5.2.2 The method of attachment must be such that the light cannot become accidentally detached.
- 5.2.3 The light and power source must be capable of being removed and replaced without causing damage to the lifejacket or immersion suit.

Activation

- 5.3.1 The light must be easy to activate with wet, cold or gloved hands in adverse conditions with the minimum of preparation.

Performance

- 5.4.1 A lifejacket light must not be damaged in stowage in an air temperature range of -30°C to $+65^{\circ}\text{C}$.
- 5.4.2 It must operate as prescribed in paragraphs 5.4.7 and 5.4.8 in a seawater temperature range of -1°C to $+30^{\circ}\text{C}$. It must also be capable of operating in fresh water.
- 5.4.3 It must be capable of operation in a sea-way when attached to a lifejacket or immersion suit.
- 5.4.4 It must be visible over as great a segment of the upper hemisphere as is practicable when attached to a lifejacket or immersion suit.
- 5.4.5 It must be white in colour.
- 5.4.6 A flashing light must flash at a rate of not less than 50 and not more than 70 flashes per minute and must attain this rate within 5 minutes of activation.
- 5.4.7 A water activated light must commence functioning within 2 minutes of immersion and have reached a luminous intensity of 0.75 candela within 5 minutes in salt water at temperatures of -1°C and $+30^{\circ}\text{C}$ and within 10 minutes in fresh water at ambient temperature.
- 5.4.8 A fixed light and a flashing light with a flash duration of not less than 50 flashes and not more than 70 flashes per minute must have a luminous intensity of not less than 0.75 candela in all directions of the upper hemisphere.
- 5.4.9 A light must have a source of energy capable of providing the luminous intensity, or effective luminous intensity, as appropriate, for a period of at least 8 hours.
- 5.4.10 The unit and the lifejacket or immersion suit attachment arrangements must be capable of withstanding a jump into the water from a height of 4.5 metres without the unit being damaged or dislodged or causing injury to the wearer of the lifejacket or immersion suit.
- 5.4.11 The unit must be capable of withstanding a drop of 2 metres onto a rigidly mounted steel plate or concrete surface.



Marking

- 5.5.1 The unit must be indelibly marked with:
 - 5.5.1.1 the manufacturer's name or trade mark;
 - 5.5.1.2 the batch number or other means of identifying the unit; and
 - 5.5.1.3 clear and concise directions in English for activating the light supported by illustrations.
- 5.5.2 The unit or power source as appropriate, must be marked indelibly with the date of manufacture and expiry of the power source.

Instructions and Information

- 5.6.1 Instructions and information must be in a form suitable for the training manual and, if appropriate, in the instructions for on-board maintenance referred to in Schedule 14. Instructions and information must be in English in a clear and concise form and must include:
 - 5.6.1.1 the method or methods of attachment to lifejackets and immersion suits;
 - 5.6.1.2 the type of power source for the particular type of light;
 - 5.6.1.3 if the power source is replaceable, the method of replacement;
 - 5.6.1.4 the type of light source and whether replaceable;
 - 5.6.1.5 any maintenance requirements including the method and recommended frequency of checks of power source; and
 - 5.6.1.6 the operation of the light.

PART 2 – INHERENTLY BUOYANT LIFEJACKETS (For persons weighing 32 kilogrammes or over)

General

- 1.1 Inherently buoyant lifejackets for persons weighing 32 kilogrammes or over must comply with the requirements of Part 1 and the requirements in this Part.

Materials

- 2.1 Buoyancy material must be of good quality synthetic material, or kapok.
- 2.2 Cover material where used must be of:
 - 2.2.1 good quality synthetic material, or pre-shrunk cotton material free of admixture of sizing or other foreign matter; and
 - 2.2.2 a highly visible colour such as traffic yellow (BSEN 381, Ref 368) international orange (BSEN 381, Ref 592) or a colour of equivalent conspicuity.



- 2.3 Where a synthetic cover material is used and the seams are stitched, the thread must be of synthetic material. Where cotton cover material is used the thread must be of natural fibre or a combination of synthetic and natural fibre.
- 2.4 Fastening tapes must not be less than 32 millimetres wide and have a breaking strength of not less than 1.4 kiloNewtons. Tapes of a synthetic material must be capable of providing an equivalent degree of security when tied as that provided by cotton tapes.

Instructions and Information

- 3.1 Instructions and information must be in a form suitable for the training manual referred to in Schedule 14. Instructions and information must be in English in a clear and concise form and must include how the lifejacket is to be donned and secured.

PART 3 – INHERENTLY BUOYANT LIFEJACKETS (For persons weighing less than 32 kilogrammes)

General

- 1.1 Inherently buoyant lifejackets for persons weighing less than 32 kilogrammes must comply with the requirements of Parts 1 and 2, except that:
- 1.1.1 donning assistance is permitted for small children;
- 1.1.2 it must only be required to lift the mouth of an exhausted or unconscious wearer clear of the water a distance appropriate to the size of the intended wearer;
- 1.1.3 assistance may be given to board a survival craft, but wearer mobility must not be significantly reduced; and
- 1.1.4 in addition to the markings required by paragraph 4.2 of Part 1 they must be marked with a “child” symbol as shown in the “childs lifejacket” symbol in Section B of Schedule 16 and the height or weight range for which the lifejacket will meet the approval requirements.

PART 4 – INFLATABLE LIFEJACKETS (for persons weighing 32 kilogrammes or over)

General

- 1.1 Inflatable lifejackets for person weighing 32 kilogrammes or over must comply with the requirements of Part 1 and the requirements in this Part.

Construction

- 2.1 An inflatable lifejacket must be constructed with not less than two separate compartments and it must inflate automatically on immersion. The automatic inflation system must be so designed and protected that the risk of inadvertent inflation is reduced to a minimum. It must be provided with a device to permit inflation by a single manual motion and must be capable of being inflated by mouth.



- 2.2 In the event of loss of buoyancy in any one compartment the lifejacket must be capable of complying with the requirements of paragraphs 2.1, 3.1 and 3.2 of Part 1.
- 2.3 The inflatable compartments must be so located that when inflated they do not channel water into the wearer's face when in a sea-way.
- 2.4 An inflatable lifejacket must comply with the requirements of paragraph 2.2 of Part 1 after inflation by means of the automatic mechanism.

Materials and Components

- 3.1 Materials and components must comply, as applicable, with the requirements of BS EN 394 and 396.
- 3.2 Materials used on the exterior of the buoyancy chambers must be of a highly visible colour such as traffic yellow (BS EN 381, Ref 368), international orange (BS EN 381, Ref 592) or a colour of equivalent conspicuity.

Instructions and Information

- 4.1 Instructions and information must be in a suitable form for the training manual and, if appropriate, the instructions for on-board maintenance referred to in Schedule 14. Instructions and information must be in English in a clear and concise form and must include:
- 4.1.1 a description of lifejacket and attachments;
 - 4.1.2 the method of donning;
 - 4.1.3 the method of operation;
 - 4.1.4 its packaging;
 - 4.1.5 any maintenance requirements;
 - 4.1.6 any servicing requirements;
 - 4.1.7 the type and charged weight of gas bottles; and
 - 4.1.8 the method of replacing gas bottles.

PART 5 – INFLATABLE CIVIL AVIATION AUTHORITY LIFEJACKET

Inflatable lifejackets which are suitable for persons weighing 32 kilogrammes or more, or less than 32 kilogrammes, which have been approved by the United Kingdom Civil Aviation Authority comply with this Schedule if they have been fitted with a ring or loop or similar device, having a minimum breaking strain of 1.8 kiloNewtons to facilitate rescue: provided that an approved light is not required.

PART 6 – BUOYANCY AIDS

Inherent buoyant lifejackets for persons weighing 32 kilogrammes or over, or under 32 kilogrammes must comply with requirements of British Standard CEN 100 Standard and in addition must be fitted



with a ring or loop or similar device, having a minimum breaking strain of at least 1.8 kiloNewton to facilitate rescue.



SCHEDULE 10

REQUIREMENTS FOR IMMERSION SUITS, ANTI-EXPOSURE SUITS AND THERMAL PROTECTIVE AIDS

PART 1 – IMMERSION SUITS

General

- 1.1 Every lifejacket and its attachment required by Regulations must comply with the requirements of Schedule 1 as is applicable to it.

Construction

- 1.1 An immersion suit must be constructed with proper workmanship and waterproof materials.
- 1.2 The materials of the suit must be rot-proof, corrosion resistant and not unduly affected by seawater, oil or fungal attack.
- 1.3 An immersion suit must be of a highly visible colour to assist detection.
- 1.4 It must be fitted with retro-reflective material to assist detection.
- 1.5 It must be constructed to cover the whole body with the exception of the face. Hand covering must be provided as an integral part of the suit or by means of permanently attached gloves.
- 1.6 It must be provided with arrangements to minimise or reduce free air in the legs of the suit.
- 1.7 It must be fitted with a non-metallic whistle not affected by water and humidity and firmly secured by a cord of suitable length, means of attaching a lifejacket light complying with of Part 1 in Schedule 9 and, if the suit has buoyancy and is designed to be worn without a lifejacket, a ring or loop or similar device of adequate strength to facilitate rescue.
- 1.8 An immersion suit which also complies with the requirements of Parts 1 or 2 of Schedule 9 may be classified as a lifejacket.
- 1.9 An immersion suit must be provided with a valise or container for stowage purposes.

Performance

- 2.1 An immersion suit must not be damaged in stowage in the air temperature range of -30°C to $+65^{\circ}\text{C}$.
- 2.2 It must operate in a seawater temperature range of -1°C to $+30^{\circ}\text{C}$.
- 2.3 It must be resistant to deterioration where exposed to sunlight.
- 2.4 An immersion suit must be capable of satisfactory operation in a sea-way.
- 2.5 An immersion suit must permit the person wearing it (and a lifejacket if the immersion suit is to be worn in conjunction with a lifejacket) to:



- 2.5.1 climb up and down a vertical ladder at least 5 metres in length;
- 2.5.2 perform normal duties during abandonment;
- 2.5.3 jump from a height of not less than 4.5 metres into the water without damaging or dislodging the immersion suit, or being injured; and
- 2.5.4 swim a short distance through the water and board a survival craft.
- 2.6 The suit must be capable of being unpacked and donned without assistance within 2 minutes, taking into account any associated clothing and a lifejacket if the immersion suit is to be worn in conjunction with a lifejacket.
- 2.7 It must not sustain burning or continue melting after being totally enveloped in a fire for a period of 2 seconds.
- 2.8 Following a jump from a height of not less than 4.5 metres into water there must be no undue ingress of water into the suit.
- 2.9 When the wearer is exposed to disturbed water conditions for a period of 20 minutes there must be no undue ingress of water into the suit.
- 2.10 The person wearing it must be able to don a lifejacket without assistance if the immersion suit is to be worn with a lifejacket over it.
- 2.11 If the material has no inherent insulation the suit when worn in conjunction with warm clothing (and a lifejacket if the immersion suit is to be worn with a lifejacket) the suit must provide sufficient thermal protection to ensure that the wearer's body core temperature does not fall more than 2°C:
 - 2.11.1 when it is worn for a period of 1 hour in calm circulating water at a temperature of 5°C taking into account any water ingress following a jump into the water from a height of 4.5 metres; and
 - 2.11.2 a 20-minute period in disturbed water conditions.
- 2.12 If the material has inherent insulation either on its own or when worn with a lifejacket (if the immersion suit is to be worn in conjunction with a lifejacket) the suit must provide sufficient thermal insulation to ensure that the wearer's body core temperature does not fall more than 2°C:
 - 2.12.1 after a period of 6 hours immersion in calm circulating water at a temperature of between 0°C and 2°C, taking into account any water ingress following a jump into the water from a height of 4.5 metres; and
 - 2.12.2 a 20-minute period in disturbed water conditions.
- 2.13 After being immersed in water at 5°C for a period of 1 hour the wearer of the immersion suit must be able to pick up a pencil and write with hands covered.
- 2.14 A person in fresh water wearing an immersion suit which complies with the requirements of Parts 1 or 2 of Schedule 9 or an immersion suit with a lifejacket must:
 - 2.14.1 be able to turn from a face-down to a face-up position in not more than 5 seconds;
 - 2.14.2 float in a stable face-up position with the mouth not less than 120 millimetres clear of the water.



Marking

- 3.1 An immersion suit and the valise or container in which it is stowed must be marked indelibly with the:
 - 3.1.1 manufacturer's name or trade mark;
 - 3.1.2 date of manufacture;
 - 3.1.3 size range for which it is designed;
 - 3.1.4 serial number; and
 - 3.1.5 instruction that it must be worn in conjunction with warm clothing if the suit is made of material which has no inherent insulation.

Instructions and Information

- 4.1 Instructions and information must be in a suitable form for the training manual referred to in Part 1 of Schedule 14 and, if appropriate, for on-board maintenance referred to in Part 2 of that Schedule. Instructions and information must be in English in a clear and concise form and must include:
 - 4.1.1 a description of the immersion suit and attachments;
 - 4.1.2 on donning;
 - 4.1.3 on the operation of any auxiliary buoyancy;
 - 4.1.4 on the method of stowage;
 - 4.1.5 on any servicing and maintenance requirements;
 - 4.1.6 on cleaning; and
 - 4.1.7 its use.

PART 2 – ANTI-EXPOSURE SUITS

Construction

- 1.1 The anti-exposure suit must comply with the requirements of Part 1 paragraphs 1, 2, 3 and 4 as applicable and with the requirements of this Part.
- 1.2 The anti-exposure suit must be constructed with waterproof materials such that it:
 - 1.2.1 provides inherent buoyancy of at least 70 Newtons;
 - 1.2.2 is made of material which reduces the risk of heat stress during rescue and evacuation operations;



- 1.2.3 covers the whole body with the exception of the head and hands; gloves and a hood must be provided in such a manner as to remain available for use with the anti- exposure suits;
- 1.2.4 can be unpacked and donned without assistance within 2 minutes;
- 1.2.5 does not sustain burning or continue melting after being totally enveloped in a fire for a period of 2 seconds;
- 1.2.6 is equipped with a pocket for a portable VHF telephone; and
- 1.2.7 has a lateral field of vision of at least 120 degrees.
- 2.1 An anti-exposure suit which also complies with the requirements of Part 1 and 2, Schedule 9 may be classified as a lifejacket.
- 2.2 An anti-exposure suit must permit the person wearing it, to:
 - 2.2.1 climb up and down a vertical ladder of at least 5 metres in length;
 - 2.2.2 jump from a height of not less than 4.5 metres into the water with feet first, without damaging or dislodging the suit, or being injured;
 - 2.2.3 swim through the water at least 25 metres and board a survival craft;
 - 2.2.4 don a lifejacket without assistance; and
 - 2.2.5 perform all duties associated with abandonment, assist others and operate a rescue boat.
- 2.3 An anti-exposure suit must be fitted with a lifejacket light and a whistle.
- 2.4 An anti-exposure suit must:
 - 2.4.1 if made of material which has no inherent insulation, be marked with instructions that it must be worn in conjunction with warm clothing; and
 - 2.4.2 be so constructed, that when worn as marked, the suit continues to provide sufficient thermal protection following one jump into the water which totally submerges the wearer and must ensure that when it is worn in calm circulating water at a temperature of 5 degrees C, the wearer's body core temperature does not fall at a rate of more than 1.5 degrees C per hour, after the first 30 minutes.
- 2.5 A person in fresh water wearing an anti-exposure suit must be able to turn from a face-down to a face-up position in not more than 5 seconds and must be stable face-up. The suit must have no tendency to turn the wearer face-down in moderate sea conditions.

PART 3 – THERMAL PROTECTIVE AIDS

Construction

- 1.1 A thermal protective aid must be constructed with proper workmanship and materials.
- 1.2 The materials of a thermal protective aid must be rot-proof, corrosion resistant, and not unduly affected by seawater, oil or fungal attack.



- 1.3 A thermal protective aid must be made of waterproof material having a thermal conductivity of not more than $7800\text{W}/(\text{m K})$ and must be so constructed that, it will reduce both the convective and evaporative heat loss from the wearer's body.
- 1.4 It must be so constructed as to cover the whole body of a person wearing a lifejacket with the exception of the face. Hands must also be covered unless permanently attached gloves are provided.
- 1.5 It must be of a highly visible colour to assist detection.
- 1.6 It must be protected by waterproof packaging which can be opened with wet or cold hands.

Performance

- 2.1 A thermal protective aid must not be damaged in stowage in the air temperature range -30°C to $+65^{\circ}\text{C}$.
- 2.2 It must function properly in the air temperature range -30°C to $+20^{\circ}\text{C}$
- 2.3 It must function in the seawater temperature range -1°C to $+30^{\circ}\text{C}$ if designed to be worn in a sea-way.
- 2.4 It must be capable of being unpacked and easily donned without assistance in a survival craft or rescue boat.
- 2.5 It must permit the wearer to remove it in the water in not more than 2 minutes, if it impairs ability to swim.

Marking

- 3.1 The thermal protective aid packaging must be marked with:
 - 3.1.1 the manufacturer's name or trade mark; and
 - 3.1.2 instructions for use.

Instructions and Information

- 4.1 Instructions and information must be in a form suitable for the training manual referred to in Part 1 of Schedule 14. Instructions and information must be in English in a clear and concise form and include:
 - 4.1.1 stowage in lifeboats and liferafts;
 - 4.1.2 unpacking;
 - 4.1.3 donning in a survival craft;
 - 4.1.4 its removal from the wearer in the water (if applicable);
 - 4.1.5 its purpose, and when it should be used;
 - 4.1.6 whether or not ability to swim is impaired when wearing the aid; and
 - 4.1.7 on how it is to be checked and inspected.





SCHEDULE 11

GENERAL EMERGENCY ALARM SYSTEMS AND PUBLIC ADDRESS SYSTEMS

PART 1 – GENERAL EMERGENCY ALARM SYSTEMS

- 1.1 The general emergency alarm system must be capable of sounding the general emergency alarm signal consisting of seven or more short blasts followed by one long blast on the ship's whistle or siren and additionally, in the case of ships of Classes I, II and II(A), and of Classes VII, VII(T), VIII, VIII(T) and IX of 45.7 metres in length or above on an electrically operated bell or klaxon or other equivalent warning system. This additional system must be powered from the ship's main supply and from the emergency source of electrical power required by the Merchant Shipping (Passenger Ship Construction) Regulations 1996 or the Merchant Shipping (Cargo Ship Construction) Regulations 1996 as applicable.
- 1.2 The system must be capable of operation from the navigating bridge and, except for the ship's whistle, also from other strategic points. The system must be audible throughout all the accommodation and normal crew working spaces.
- 1.3 The system must also be audible on all open decks and its sound level must comply with paragraphs 5 and 6. The alarm must continue to sound until it is manually turned off or is temporarily interrupted by a message on the public address system.
- 1.4 Entertainment systems must be turned off automatically when the general emergency alarm system is activated.
- 1.5 The minimum sound pressure levels for the emergency alarm tone in interior and exterior spaces must be 80 dB (A) and at least 10 dB (A) above ambient noise levels existing during normal equipment operation with the ship underway in moderate weather. In cabins without a loudspeaker installation, an electronic alarm transducer must be installed, e.g. a buzzer or similar.
- 1.6 The sound pressure levels at the sleeping position in cabins and in cabin bathrooms must be at least 75 dB (A) and at least 10 dB (A) above ambient noise levels.

PART 2 – PUBLIC ADDRESS SYSTEMS

- 2.1 The public address system must be one complete system consisting of a loudspeaker installation which enables simultaneous broadcast of messages from the navigation bridge, and at least one other location on board for use when the navigation bridge has been rendered unavailable due to the emergency, to all spaces where crew members or passengers, or both are normally present and to assembly stations (i.e. muster stations). The controls of the system on the navigation bridge must be capable of interrupting any broadcast on the system from any other location on board. It must not require any action by the addressee. It must also be possible to address crew accommodation and work spaces separately from passenger spaces.
- 2.2 In addition to any function provided for routine use aboard the ship, the system must have an emergency function control at each control station which:
 - 2.2.1 is clearly indicated as the emergency function;
 - 2.2.2 is protected against unauthorized use;



- 2.2.3 automatically overrides any other input system or programme; and
- 2.2.4 automatically overrides all volume controls and on/off controls so that the required volume for the emergency mode is achieved in all spaces.

- 2.3 The system must be installed with regard to acoustically marginal conditions, so that emergency announcements are clearly audible above ambient noise in all spaces. With the ship underway in normal conditions, the minimum sound pressure levels for broadcasting emergency announcements must be:
 - 2.3.1 in interior spaces 75 dB (A) and at least 20 dB(A) above the speech interference level; and
 - 2.3.1 in exterior spaces 80 dB (A) and at least 15 dB (A) above the speech interference level.
- 2.4 The system must be arranged to prevent feedback or other interference.
- 2.5 The system must be arranged to minimize the effect of a single failure, e.g. by the use of multiple amplifiers with segregated cable routes to public rooms, alleyways, stairways, and control stations. The public address systems must have at least two loops of fire resistant cable which must be sufficiently separated throughout their length and have two separate and independent amplifiers.
- 2.6 Each loudspeaker must be individually protected against short circuits.
- 2.7 The public address system must be arranged to operate on both the main source of electrical power and the emergency source of electrical power.



SCHEDULE 12
BUOYANT APPARATUS

General

- 1.1 Buoyant apparatus must:
 - 1.1.1 be constructed with proper workmanship and materials;
 - 1.1.2 retain the shape and properties when exposed to the weather on board ship and when in the water. They must be constructed so as not to require adjustment prior to use; and
 - 1.1.3 be corrosion-resistant and not affected by sea water, oil or oil products.

Construction

- 2.1 Buoyant apparatus must be capable of withstanding a minimum drop into the water from a height of 10 metres. If they are to be stowed in a vessel at a height of more than 10 metres above the waterline in the lightest seagoing condition, they must be of a type which has been satisfactorily drop-tested from at least that height.
- 2.2 Buoyant apparatus must be effective and stable when floating either way up. They must be capable of supporting a weight of iron, suspended in fresh water from the grab lines, of 22.5 kilogrammes per metre of length along any edge (subject to a minimum of 29 kilogrammes), without immersing any part of their upper surfaces.
- 2.3 The air cases or other equivalent provision for buoyancy must be placed as near as possible to the sides of the apparatus. Buoyancy is not to be dependant upon inflation and any material providing buoyancy must not be adversely affected by oil or oil products.
- 2.4 A buoyant apparatus must not exceed 185 kilogrammes in weight unless suitable means are provided to enable it to be launched without lifting by hand. If the weight of the apparatus exceeds 135 kilogrammes suitable handles or rungs are to be fitted for lifting by hand.
- 2.5 The number of persons which a buoyant apparatus must be considered capable of supporting must be equal to the lesser of:
 - 2.5.1 the greatest whole number obtained by dividing by 14.5 the number of kilogrammes of iron which the apparatus is capable of supporting from its grab lines in fresh water; or
 - 2.5.2 the greatest whole number obtained by dividing the perimeter in metres by 0.3.

Fittings

- 3.1 Grab Lines
 - 3.1.1 Buoyant grablines must be securely fitted all around the apparatus so as to provide an equal number of loops, the total number corresponding to the number of persons the apparatus is capable of supporting.
 - 3.1.2 Each loop must have a depth of not less than 150 millimetres and not more than 200 millimetres. On apparatus exceeding 300 millimetres in overall depth two rows of grablines must be fitted, one having its points of attachment below the top of the air cases



and the other above the bottom of the air cases and as close to the sides of the air cases as practical. On apparatus of 300 millimetres or less in overall depth, one row of grab lines is to be attached along the line at mid-depth.

- 3.1.3 Grab lines must be of buoyant rope of not less than 14 millimetres in diameter. The ropes may be passed through holes in the framing, interlaced to prevent movement; or attached by means of wrought iron or steel fastenings. Whichever method is used the attachment is to be of sufficient strength to permit the apparatus to be lifted by the grab lines.
- 3.2 Each buoyant apparatus must be fitted with an efficient painter of length at least equal to the height from its stowed position to the lightest sea going condition plus 5 metres.
- 3.3 Retro-reflective material is to be fitted on all surfaces of the buoyant apparatus.

Marking

- 4.1 Each apparatus must be marked with the:
 - 4.1.1 maker's name or trademark;
 - 4.1.2 serial number; and
 - 4.1.3 maximum permitted height of stowage above waterline.



SCHEDULE 13

SURVIVAL CRAFT EQUIPMENT AND RATIONS

PART 1 – FIRST AID OUTFITS

- 1.1 The first aid outfit provided in every lifeboat, rescue boat, inflated boat or liferaft must comply with the following requirements:
- 1.1.1 it must be packed in a durable, damp-proof and effectively sealed container, capable of being closed tightly after use;
- 1.1.2 the container must be protected; until opened for use, with an outer waterproof seal;
- 1.1.3 the container must bear on its outside an itemised list of its contents, and their date of expiry;
- 1.1.4 it must comply with the implemented UK requirements of Council Directive 92/29/EEC which sets out minimum standards for ships' medical stores by introducing the Merchant Shipping and Fishing Vessel (Medical Stores) Regulations 1995, as amended by the Merchant Shipping and Fishing Vessel (Medical Stores) Amendment Regulations 1996. MSN 1707 (M+F) lists the requirements for Category C vessels which lifeboats and liferafts are required to carry and is shown in Table 1; and
- 1.1.5 drug supplies should be replenished wherever possible at the same strengths as specified in the British Pharmacopoeia. If drugs are obtained elsewhere, e.g in the USA, they may be of different strength, and this must be taken into account when administering them.

TABLE 1

CATEGORY C MEDICAL SUPPLIES

The numbering refers to the number allocated to the medicine or equipment in the Directive

Ref no	Statutory Requirements	Treatment	Recommended Dosage Strength representing best practice	Recommended Quality for 10 workers or for a lifeboat or liferaft
1	Cardio vascular			
(b)	Anti-angina preparations		Glyceryl Trinitrate Spray 400 micrograms/metered dose aerosol or transdermal patches 5mg x 2	1 unit
(d)	Anti-haemorrhagics (including uterotonics if there are women with potential for child		i) Phytomenadione (Vitamin K1) 10mg in 1ml ampoule	1



Ref no	Statutory Requirements	Treatment	Recommended Medicine and Dosage Strength representing best practice	Recommended Quality for 10 workers or for a lifeboat or liferaft
			ii) Ergometrine Maleate 500mg inj. Oxytocin 5 units in 1ml ampoule	1
2	Gastro intestinal system			
(b)	Anti-emetics		Hyoscine hydrobromide 0.3mg tabs.	60
(d)	Anti-diarrhoeals		Codeine Phosphate 30mg tablets	20
3	Analgesics and Anti-spasmodics			
(a)	Analgesics		i) Paracetamol ii) Use 2(d)	50 Use 2(d)
4	Nervous system			
(c)	Seasickness remedies		Use 2(d)	Use 2(d)
9	Medicines for External Use			
(a)	Skin medicine			
	-	Antiseptic solutions	100ml solution or pre-impregnated wipes containing 0.015% w/v chlorhexidine and 0.15% w/v cetrimide	1 bottle or 1 pack wipes
	-	Burn preparations	Cetrimide Cream 50g tube	1

MEDICAL EQUIPMENT

Ref	Statutory Requirements	Treatment	Recommended Specification	Quantity
1	Resuscitation Equipment			
	Mask for mouth to-mouth resuscitation		Laerdal Pocket Mask (or similar)	1
2	Dressing and suturing equipment			
	Adhesive elastic bandage		Adhesive Elastic Bandage 7.5cm x 4m	1
	Disposable polythylene gloves		large size	5prs
	Adhesive dressings		assorted, sterile	20
	Sterile compression bandages		(1) No. 13 Standard dressings (1) No. 14 Standard dressings (1) No. 15 Standard dressings	6 2 2
	Adhesive sutures or zinc oxide bandages		75mm adhesive suture strips	6
	Sterile Gauze Compresses		Packet containing 5 sterile gauze pads size 7.5cms x 7.5cms	1



Ref	Statutory Treatment Requirements	Recommended Specification	Quantity
		Recommended Additional Item	
		Scissors stainless steel/ or sterile disposable size	1 pr
		Calico triangular bandages about 90cm x 127cm	4
		medium safety pins, rustless	6
		sterile paraffin gauze dressings	10
		plastics burn bags	1

PART 2 – FOOD RATIONS

- 2.1 The ration for each one or two persons must be enclosed in substantial packaging of suitable efficiently sealed oxygen impermeable and moisture-proof materials. A ration intended for a lifeboat must additionally be protected by durable water-resistant packaging.
- 2.2 The outer packaging or wrapping must be marked with the manufacturer's name or trade mark, the weight, calorific value and description of the contents and the dates of manufacture and renewal. A description of the contents must be marked on the inner packaging. It must be possible to open the wrapping and packaging with wet or cold hands.
- 2.3 Recommended quantities of ration and fresh water to be consumed daily must be marked in English on the packaging or on a water resistant instruction sheet included in the ration.
- 2.4 The ration for each person must have a calorific value of not less than 10,000 kilojoules.
- 2.5 The composition of the ration:
- 2.5.1 must include at least 300 grammes of carbohydrate in the form of bland barley sugar sweets, glucose tablets or as part of a food tablet. The ration must not include protein at a greater rate than 3 grammes per 10 grammes of carbohydrate or fat at a greater rate than 4 grammes per 10 grammes of carbohydrate; and
- 2.5.2 must have a salt content as low as possible which must not exceed 1 gramme NaCl. If the ration includes an approved anti-oxidant it must be included at the rate of 0.02 per cent by weight of the fat component of the ration.
- 2.6 The moisture content of any barley sugar or food tablets in the ration must not exceed 3 per cent and 7 per cent by weight respectively. The moisture content of a glucose tablet must be as low as possible and compatible with the recommended operational shelf-life.
- 2.7 The ration must be palatable to a survivor limited to a fresh water intake of 0.5 litres per day.
- 2.8 The ration must remain palatable throughout its recommended shelf-life under the climatic conditions normally encountered.
- 2.9 The ration must be readily divisible into at least 3 one-day portions for one person.



PART 3 – FRESH WATER

General

- 1.1 The water must comply with the UK Laboratory of the Government Chemist test requirements or the equivalent standards of another State of the European Union to confirm that the water is microbiologically and chemically suitable for drinking and conforms to World Health Organisation standards.
- 1.2 Processing, packaging and sterilisation arrangements must be carried out under hygienic conditions and quality assurance inspection acceptable to the Maritime and Coastguard Agency or the equivalent authority of another member State of the European Union.
- 1.3 The water must remain palatable in its storage containers in the survival craft in a temperature range of -30°C to $+65^{\circ}\text{C}$.

Water Containers

Sachets

- 2.1.1 The water must be packed in efficiently sealed sachets which are impermeable, moisture proof and have an effective vapour barrier.
- 2.1.2 The sachets must have a cut above the top seal to facilitate easy opening with wet or cold hands.
- 2.1.3 Individual sachets must contain not less than 50 and not more than 150 millilitres of water.
- 2.1.4 Water filled sachets must be capable of withstanding a compressive load test of 5 kiloNewtons without bursting.
- 2.1.5 Except as provided for in paragraph 2.1.6 water sachets packed in a liferaft emergency pack must not be affected by any of the prototype tests carried out on a liferaft.
- 2.1.6 When included in the emergency pack of an operationally packed liferaft no more than 2 per cent of the water sachets must be damaged after the appropriate drop test.
- 2.1.7 The recommended shelf life of the water sachets must be at least 3 years.
- 2.1.8 The outer packaging must be marked with the following information the:
 - 2.1.8.1 manufacturer's name or trade mark;
 - 2.1.8.2 contents capacity;
 - 2.1.8.3 lot number;
 - 2.1.8.4 date of manufacture; and
 - 2.1.8.5 a recommended daily consumption per person.

Cans



- 2.2.1 Cans in which drinking water is supplied must be hermetically sealed with a vacuum of not less than 510 millimetres of mercury.
- 2.2.2 They must be constructed of tinplate with minimum thickness 0.30 millimetres and a tin content conforming to the relevant part of section 10 of British Standard 113.
- 2.2.3 The cans must be constructed with a double seam and properly balanced interlocking hooks. They must be left plain internally but coated externally with a machine applied golden lacquer and then stoved.
- 2.2.4 The capacity of the can must not be greater than 500 millilitres.
- 2.2.5 After filling the seams must be inspected and any exposed areas must be suitably lacquered.
- 2.2.6 A click test to confirm the vacuum must be carried out on each can 7 days after filling.
- 2.2.7 The cans must be free from dents or any signs of corrosion.
- 2.2.8 The cans must not be affected by any of the prototype tests carried out on a liferaft.
- 2.2.9 The cans must be clearly marked on the outside with the:
 - 2.2.9.1 manufacturer's name or trade mark;
 - 2.2.9.2 words "drinking water" and the capacity of the can in millilitres;
 - 2.2.9.3 lot or batch number;
 - 2.2.9.4 date of manufacture; and
 - 2.2.9.5 a recommended daily consumption per person.

Bottles

- 2.3.1 Bottles in which drinking water is supplied must be manufactured from a material which will not contaminate or effect the taste of the water.
- 2.3.2 They must not be affected by any of the prototype tests carried out on a liferaft.
- 2.3.3 The material from which the bottle is made must be opaque.
- 2.3.4 The capacity of the bottle must not be greater than 500 millilitres.
- 2.3.5 The bottle must be capable of being opened by a survivor with cold hands.
- 2.3.6 The minimum recommended shelf life of the water bottle and its contents must be at least 3 years.
- 2.3.7 The bottle filling cap must be fitted with a watertight seal, and have positive locking arrangements which will not be loosened by vibration. After the bottle has been filled and the cap fitted it must be provided with an outer continuous seal which must not be broken until the water is used or has become time expired.
- 2.3.8 The bottle must be marked on the outside with the:
 - 2.3.8.1 manufacturer's name or trade mark;



- 2.3.8.2 date of filling;
- 2.3.8.3 date of expiry;
- 2.3.8.4 words “drinking water” and the capacity of the bottle in millilitres;
- 2.3.8.5 recommended daily consumption per person; and
- 2.3.8.6 lot or batch number.

Water tanks

- 2.4.1 Tanks fitted for fresh water in a survival craft may be of metal or a plastic material acceptable to the Maritime and Coastguard Agency or the equivalent competent authority or of another member State of the European Union.
- 2.4.2 Each tank is to be filled and emptied to ensure cleanliness and to check for watertightness.
- 2.4.3 The tank must be strong enough to withstand a head of water of at least 1.5 metres.
- 2.4.4 Where necessary the inside of the tank must be suitably coated to prevent contamination or unpleasant taste.
- 2.4.5 Tanks which are not portable must be fitted with drain plugs constructed of non-corrosive material.
- 2.4.6 Filling plugs and aperture covers must be of non-ferrous materials, neatly fitted and made properly watertight to prevent the entry of contaminants.
- 2.4.7 Tanks must be sited well clear of any propelling machinery.
- 2.4.8 At least one rustproof dipper with a lanyard must be provided for each tank.
- 2.4.9 The inside of tanks constructed with glass reinforced plastic must be smooth and sealed with a gel coat.
- 2.4.10 Tanks made out of glass reinforced plastic must be opaque.
- 2.4.11 The tank must be clearly marked on the outside with the contents and its capacity in litres.

PART 4 – SEA ANCHORS

1.1 A sea anchor must be conical in shape and have the following dimensions:

CRAFT	SEA ANCHOR		Minimum Sloping Length of Lines (mm)
	Minimum Mouth Diameter (mm)	Minimum Sloping Length (mm)	
Liferafts up to 10 person capacity	400	600	600
Liferafts 11 person capacity up to 25 person capacity and inflated boats	500	670	670
Liferafts over 25 person capacity, lifeboats and rescue boats up to 6 m in length	600	780	780



Lifeboats and rescue boats over 6 m in length and up to 9 m in length	700	920	920
Lifeboats over 9 m in length	800	1050	1050

- 2.1 The sea anchor material must be porous, slightly stiff and must allow a water penetration of between 10 and 12 cubic centimetres per second per square centimetre at a pressure of 550Pa (roughly equivalent to a speed through water of 2 knots).
- 3.1 The painter line used to secure the sea anchor to a liferaft or boat must:
- 3.1.1 be inherently rot proof and of braided construction; and
- 3.1.2 be 30 metres long; not less than 8 mm. in diameter and have a breaking load including attachments and knots of not less than:
- 3.1.2.1 7.5 kN for liferafts up to 10 person capacity;
- 3.1.2.2 10.0 kN for liferafts of 11 person to 25 person capacity; and
- 3.1.3.3 10.0 kN for all other sea anchors or have a factor of safety of 3:1 based on a tow test at 6 knots whichever is the greater.
- 4.1 The shroud lines must be designed to restrict the sea anchor from tumbling through itself.
- 5.1 The sea anchor must be stable when towed through the water at speeds up to 6 knots.
- 6.1 The sea anchor mouth must open immediately on deployment.



SCHEDULE 14

TRAINING MANUALS AND INSTRUCTIONS FOR ON-BOARD MAINTENANCE

PART 1 – TRAINING MANUALS

1. Training manuals must contain instructions and information on the life-saving appliances provided in the ship. It must also contain information on the best methods of survival. The material in the manual must be in easily understood terms and illustrated where appropriate.
2. Training manuals may comprise one or more volumes and information may be provided in the form of audio-visual aids as an alternative to printed material.
3. Depending on the life-saving appliances provided in the ship, the following must be explained in detail:
 - 3.1 donning of lifejackets, immersion suits and anti-exposure suits, as appropriate;
 - 3.2 muster at the assigned stations;
 - 3.3 boarding, launching, and clearing the survival craft, rescue boats, fast rescue boats, free-fall boats and inflated boats;
 - 3.4 method of launching from within the survival craft;
 - 3.5 release from launching appliances;
 - 3.6 methods and use of devices for protection in launching areas;
 - 3.7 illumination in launching areas;
 - 3.8 use of all survival equipment;
 - 3.9 use of all detection equipment;
 - 3.10 with the assistance of illustrations, the use of radio life-saving appliances;
 - 3.11 use of sea anchors;
 - 3.12 use of engine and accessories;
 - 3.13 recovery of the survival craft, rescue boats, fast rescue boats, free-fall boats and inflated boats including stowage and securing;
 - 3.14 hazards of exposure and the need for warm clothing;
 - 3.15 best use of the survival craft facilities in order to survive;
 - 3.16 methods of retrieval, including the use of helicopter rescue gear (slings, baskets, stretchers), breeches-buoy and shore life-saving apparatus and ship's line-throwing apparatus;
 - 3.17 all other functions contained in the muster list and emergency instructions;



- 3.18 instructions for emergency repair of the life-saving appliances;
- 3.19 means of rescue arrangements;
- 3.20 marine evacuation systems; and
- 3.21 helicopter landing and pick-up area operations.

PART 2 – INSTRUCTIONS FOR ON-BOARD MAINTENANCE

1. Instructions for on-board maintenance of life-saving appliances must be in easily understood terms and illustrated wherever possible.
2. The instructions must include, where appropriate, the following for each appliance:
 - 2.1 a checklist for use when carrying out the inspections required by the Regulations;
 - 2.2 maintenance and repair instructions;
 - 2.3 a schedule of periodic maintenance;
 - 2.4 a diagram of lubrication points with the recommended lubricants;
 - 2.5 a list of replaceable parts;
 - 2.6 a list of sources of spare parts; and
 - 2.7 a record of inspection and maintenance.



SCHEDULE 15

CARRIAGE OF TWO-WAY VHF RADIOTELEPHONE SETS – EXEMPTING CONDITIONS

- 1.1 The conditions referred to in regulation 7(5)(b), 8(11)(b), 10(12)(b), 11(5)(b), 20(8)(b), 42(6)(b), 43(8)(b), 44(9)(b), 45(11)(b) and 47(3)(b) of the 2019 Regulations under which ships may be exempted from the carriage of two-way VHF radiotelephone sets complying with performance standards contained in IMO Resolution A762(18) are given below.
- 1.2 In the case of a passenger ship or a cargo ship of 500 tons or over, at least three and in the case of a cargo ship under 500 tons, at least two portable or VHF radiotelephone sets for use in survival craft must be provided.
- 1.3 The radiotelephone sets must:
 - 1.3.1 be waterproofed;
 - 1.3.2 be capable of operating on radio frequency 156.8 MHz (VHF channel 16) and on at least one other channel;
 - 1.3.3 have the selection of 156.8 MHz (VHF Channel 16) correctly and clearly marked on the channel selector switch;
 - 1.3.4 in respect of United Kingdom ships, be of a type approved by the Department of Trade and Industry; or the equivalent competent authority of another member State of the European Union;
 - 1.3.5 have been provided on board ship prior to 1st February 1992; and
 - 1.3.6 if replacement of a radio telephone becomes necessary, be replaced with approved equipment complying with IMO performance standards.
- 1.4 Where secondary batteries are used in the radiotelephone sets, suitable arrangements must be made to ensure the availability of fully charged sets at all times.



SCHEDULE 16

SYMBOLS RELATING TO LIFE-SAVING APPLIANCES AND ARRANGEMENTS

1. The Merchant Shipping (Life-Saving Appliances) Regulations 1999 require ships (other than fishing vessels) carrying survival craft to be provided with posters or signs on or in the vicinity of these craft and their launching controls. The posters and signs are to illustrate the purposes of the controls and the procedures for operating the appliance and to give relevant instructions or warnings. They must be capable of being seen under emergency lighting conditions where that is provided.
2. The symbols have been approved by the Maritime Safety Committee of the International Maritime Organization and the symbols used in the posters and signs referred to in paragraph 1 above must conform to the design and colour (white on a blue background) prescribed in Section A. The size of the symbol must be appropriate to the particular purpose for which it is being used; but where the diameter of the symbol is 60 millimetres or greater, it should be one of the preferred dimensions given in Amendment No. 1 to BS 5378 (a):Part 2: 1980.
3. The symbols are suitable for use on posters and signs at survival craft locations and for display inside survival craft adjacent to the relevant control or function to which they refer. Most of the symbols relate to totally enclosed lifeboats but there are some which can be used for conventional open lifeboats and davit-launched liferafts. In addition, symbols in the appropriate sequence can be displayed at the coxswain's position in a totally enclosed lifeboat as a reminder of the sequence of actions required to launch the lifeboat.
4. An additional set of symbols has also been approved by the Maritime Safety Committee and they appear in Section B. These symbols are intended to indicate the location of emergency equipment, and muster and embarkation stations. These symbols are not called for by the Regulations but many of them can be used with advantage on passenger ships. In particular, the symbol for a muster station (number 21) and the symbol indicating the direction to a muster/assembly station (number 23) could be used on passenger ships where such signs are required and on other passenger ships where the provision of such signs is appropriate.
5. Where symbols are used to indicate direction, or the stowage position of life-saving equipment, it is recommended that they conform in design and colour (white on a green background) with the relevant symbols in Section B and that the size of the signs is one of the preferred sizes in the British Standard referred to in paragraph 2.



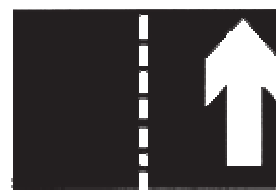
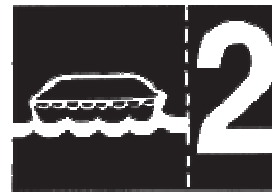
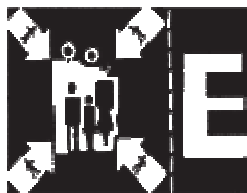
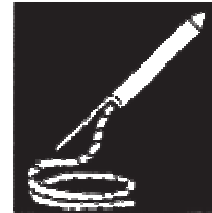
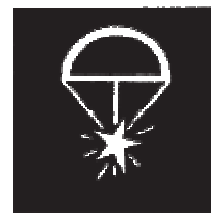
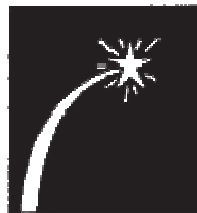
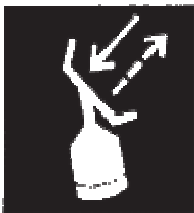
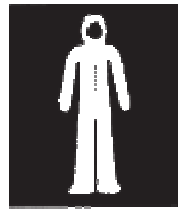
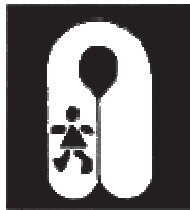
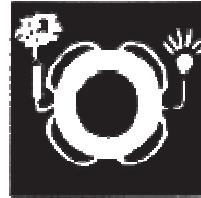

More Information

Ship Standards
Maritime and Coastguard Agency
Bay 2/23
Spring Place
105 Commercial Road
Southampton
SO15 1EG

Tel : +44 (0) 203 8172000
e-mail: marinetechnology@mcga.gov.uk

Website Address: www.gov.uk/government/organisations/maritime-and-coastguard-agency

General Enquiries: infoline@mcga.gov.uk

File Ref: Insert MCA File Reference

Published: Printers to Insert Month Year
Please note that all addresses and
telephone numbers are correct at time of publishing

© Crown Copyright 2020

Safer Lives, Safer Ships, Cleaner Seas



